

VERSION : 49.860MHZ

6XAA BATTERY RECHARGEABLE OR ALKALINE

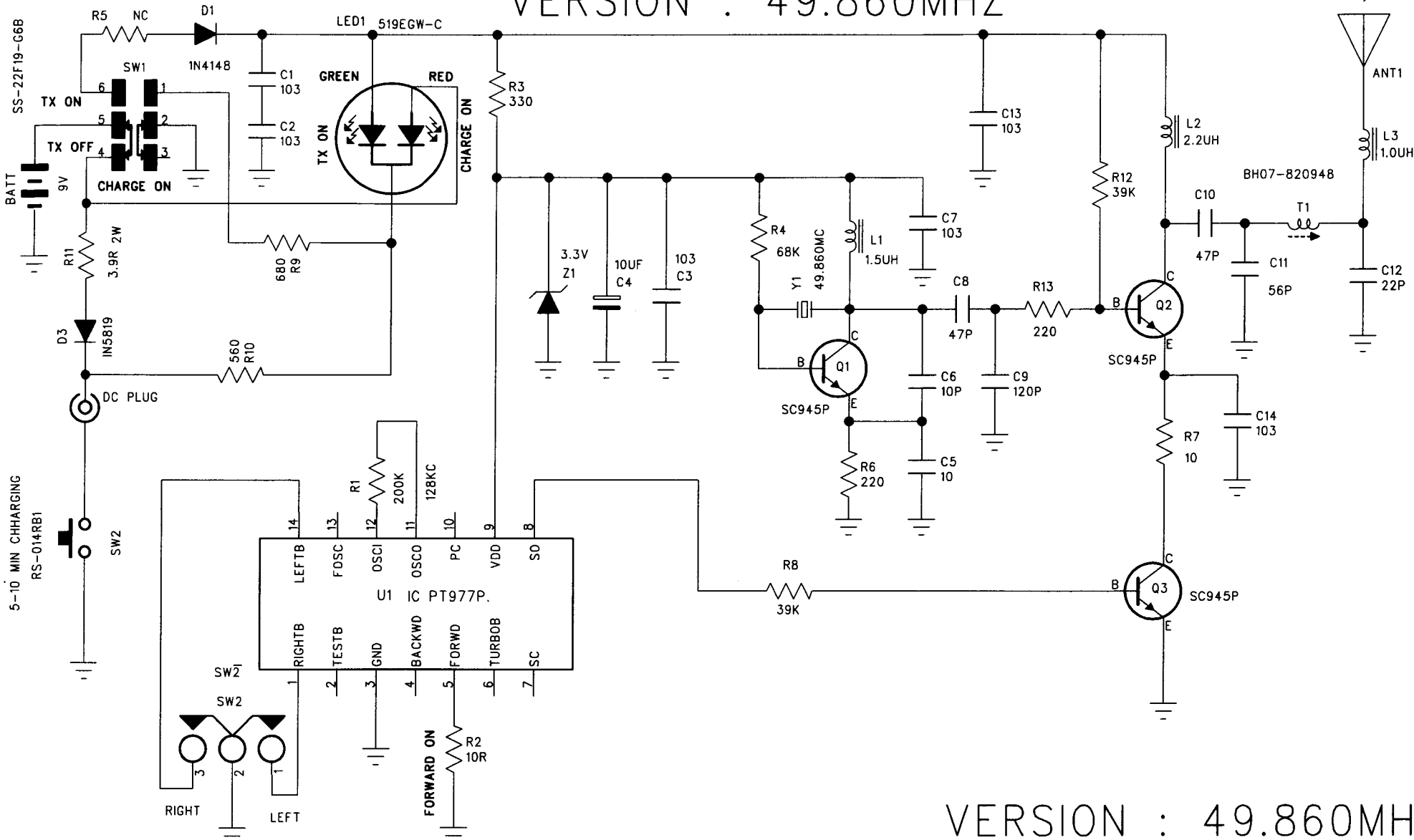

VERSION : 49.860MHZ

DRAWN: H Y S	DATE: 2003.10.02	TITLE: SCHEMATIC DIAGRAM--TX		SIZE: A4
CHECKED: YKY	DATE: 2003.10.02	MATERIAL: 49.860MHZ TX SIDE	VERSION: 1.0	DATE:
APPROVED: B.LEE	DATE: 14/12/2003	MODEL: RCX AIR PLANE	PART NO. 412-372TX01-49860-0	SHEET 1 OF 1

Dynamic industries co. ltd.