

6

5

4

3

2

1

REVISION RECORD			
LTR	ECO NO:	APPROVED:	DATE:

2404-2479MHz

ANT

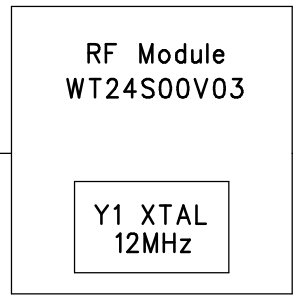

Module 1

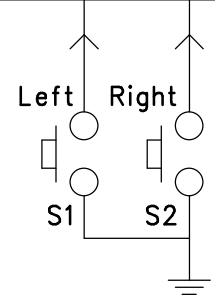
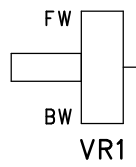
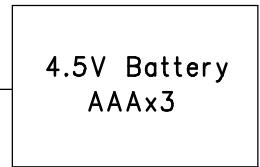
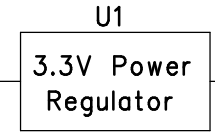
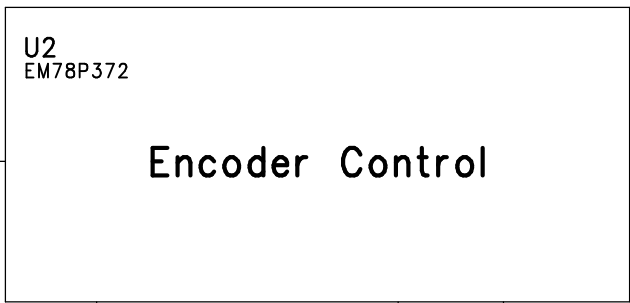

COMPANY:				Pacific Industries Ltd.			
TITLE:				2.4GHz TX Part For 20426 Fast Five			
CHECKED:	DATED:	CODE:	SIZE:	DRAWING NO:		REV:	
		0	F	20426 Fast Five (2.4GHz TX Block).SCH		0	
QUALITY CONTROL:	DATED:	SCALE: 1 : 1		SHEET: 1 OF 1			

DRAWN:	DATED:
So Jin Oung	07-Dec-12
CHECKED:	DATED:
QUALITY CONTROL:	DATED:
RELEASED:	DATED:

D

D

C

C

B

B

A

A

WT24S00V03 Block Diagram

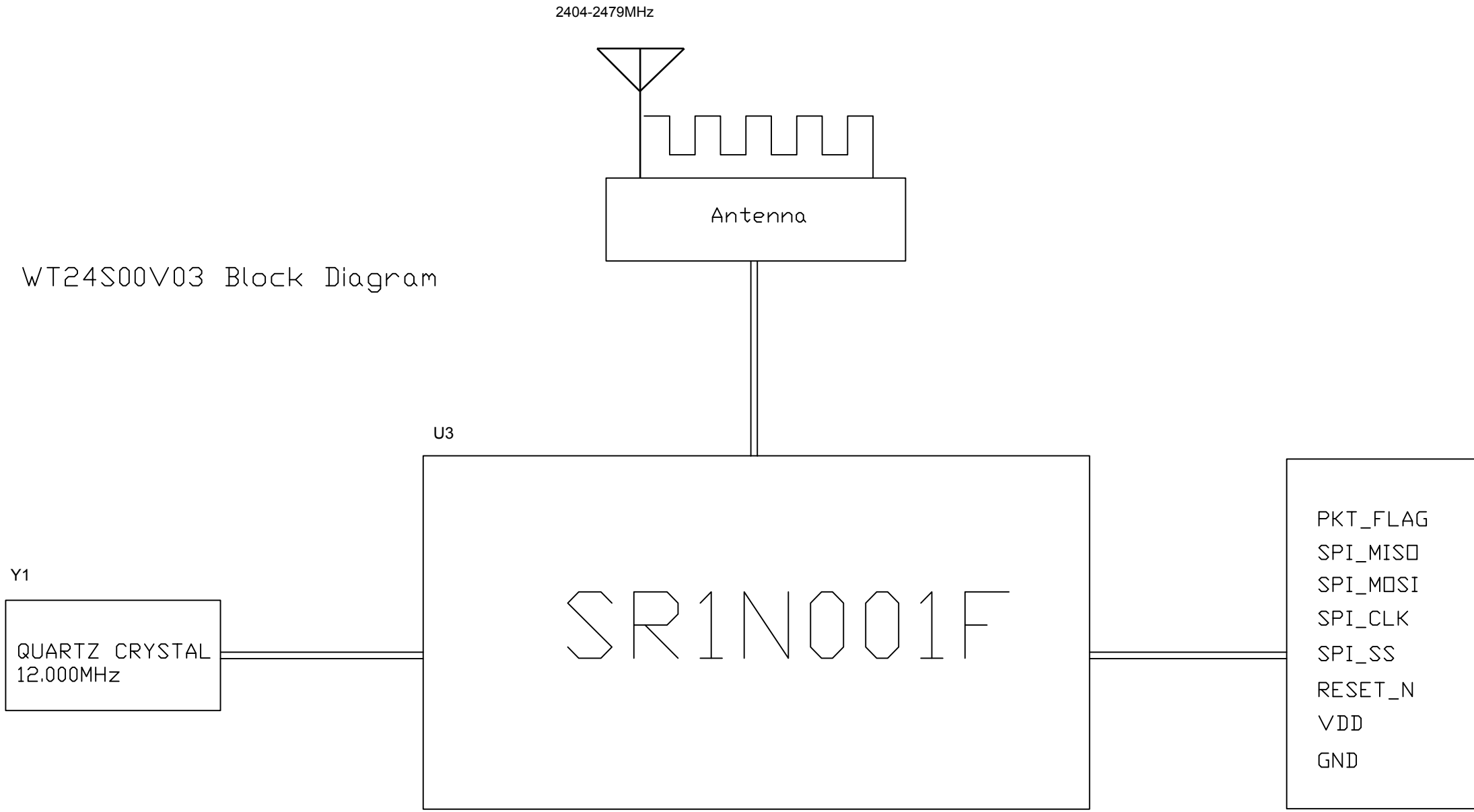

1.3 Bloc Diagram

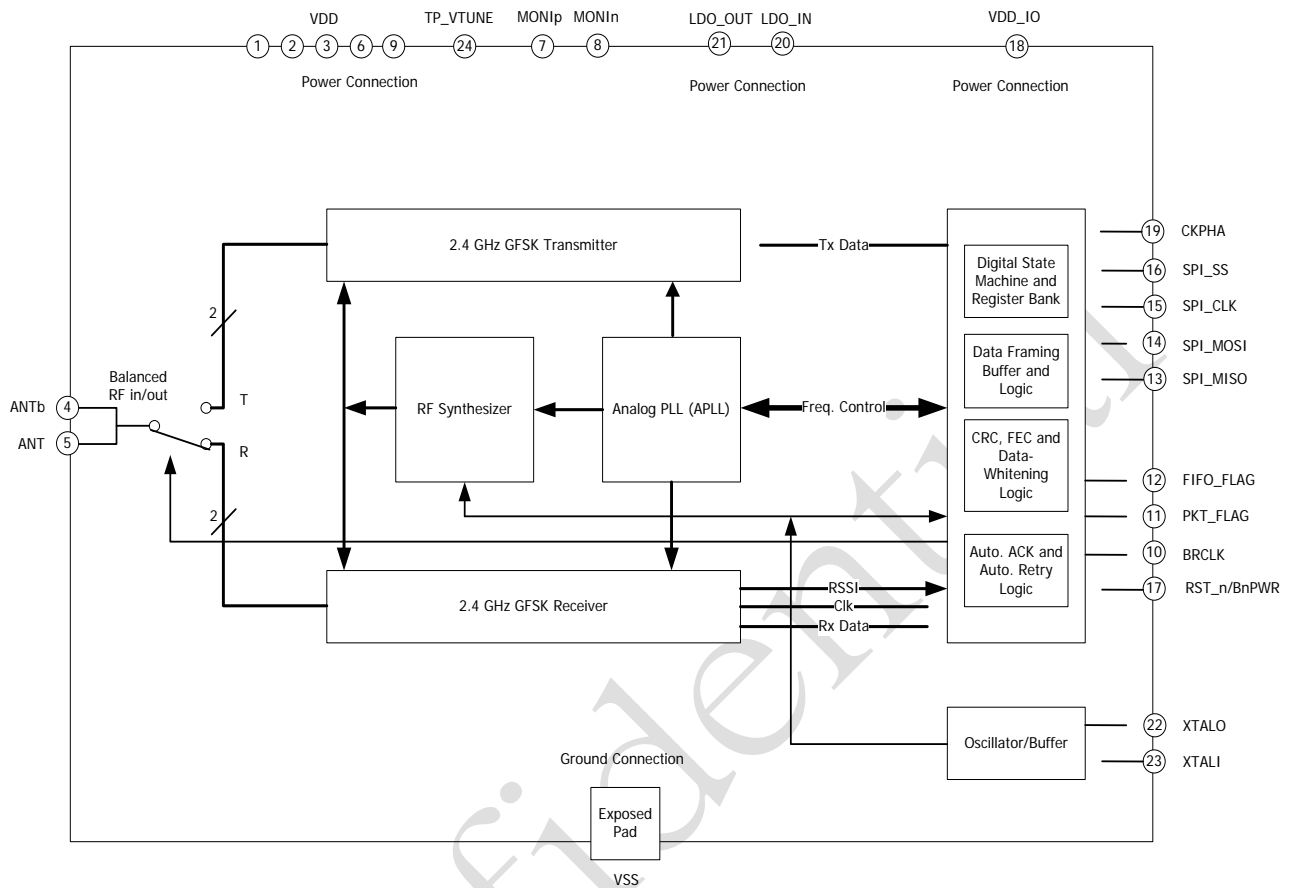

Figure 1-1 SR1N001F Block Diagram (QFN24 Package)