

6

5

4

3

2

1

REVISION RECORD			
LTR	ECO NO:	APPROVED:	DATE:

2404-2479MHz

ANT



4.5V Battery AAx3

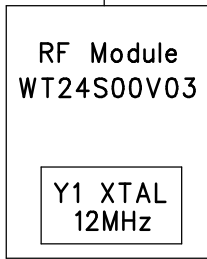
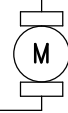
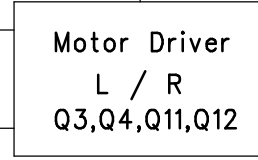
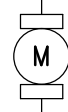
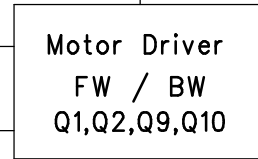
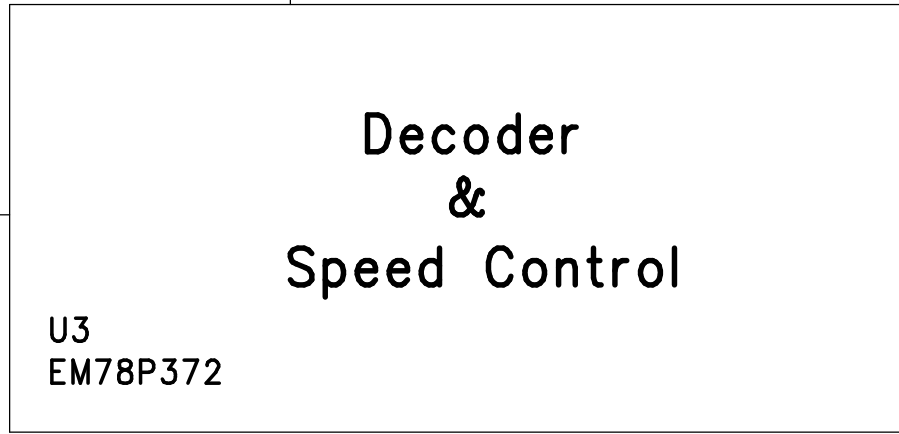
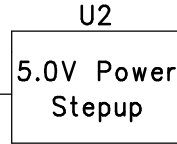
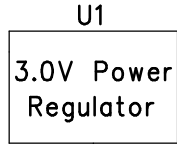

Module 1

COMPANY:				<b>Pacific Industries Ltd.</b>							
TITLE:				2.4GHz RX Part For 20426 Fast Five							
DRAWN:	So Jin Oung	DATED:	07-Dec-12	CODE:	0	SIZE:	F	DRAWING NO:	20426 Fast Five (2.4GHz RX Block).SCH	REV:	0
CHECKED:		DATED:		SCALE: 1 : 1		SHEET: 1 OF 1					
QUALITY CONTROL:		DATED:									
RELEASED:		DATED:									

D

D

C

C

B

B

A

A

WT24S00V03 Block Diagram

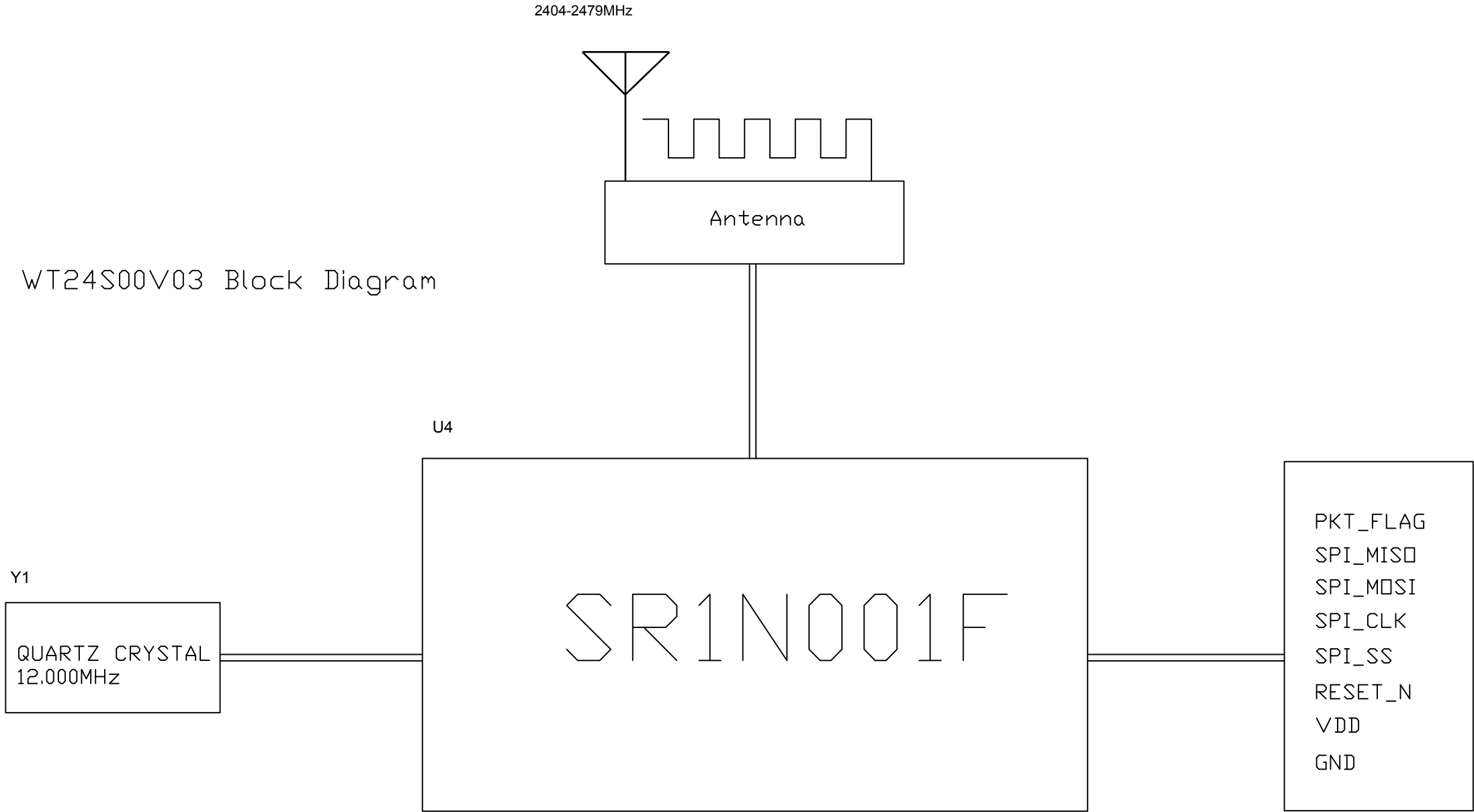

### 1.3 Bloc Diagram

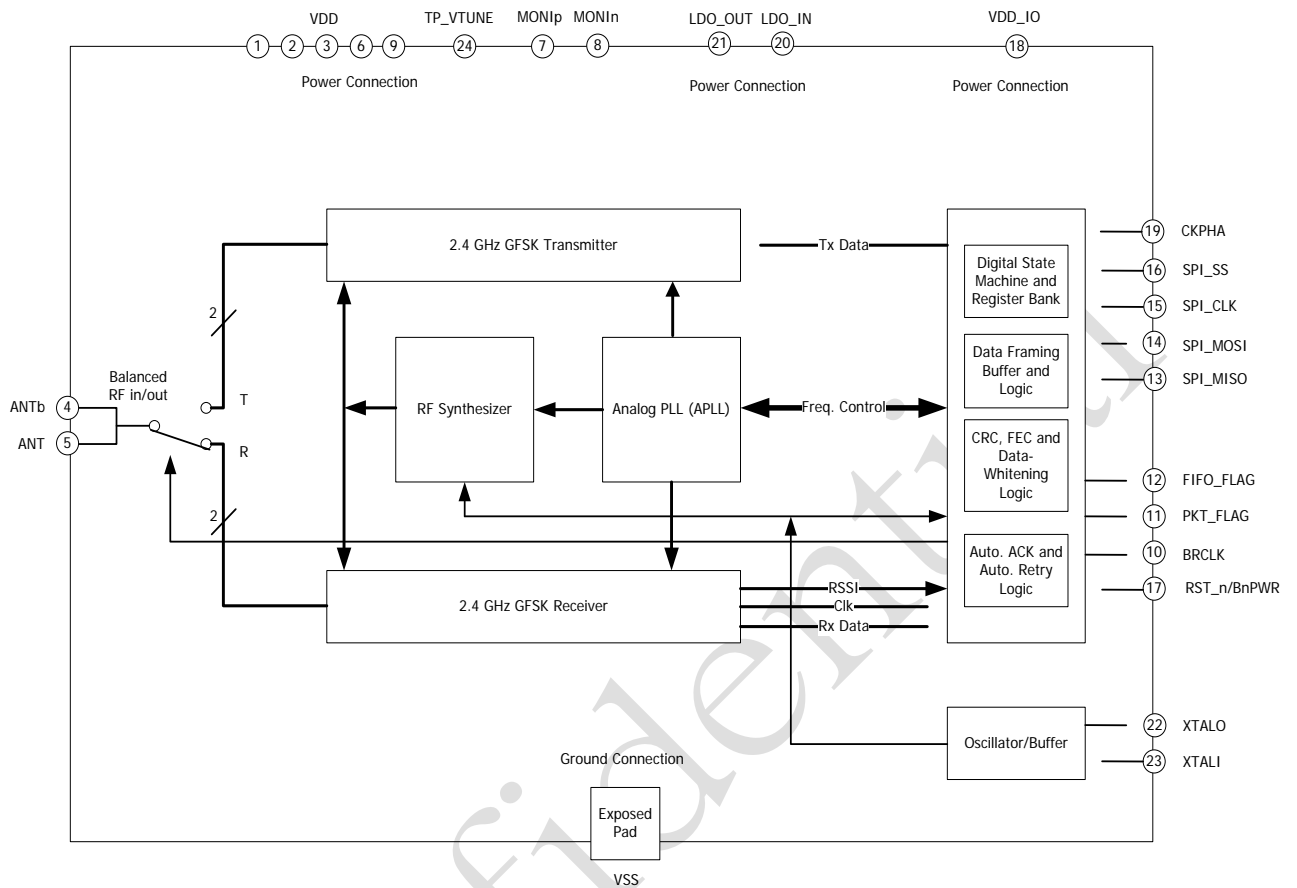

Figure 1-1 SR1N001F Block Diagram (QFN24 Package)