



APPLICATION SPECIFICATION

2.4/5GHZ BALANCE FLEX ANTENNA

1.0 SCOPE

This specification describes the antenna application and surroundings. The information in this document is for reference and benchmark purposes only. The user is responsible for verifying antenna RF performance based on the user's actual implementation.

All measurements are done of the antenna mounted on a PC/ABS material block of 1mm thickness with VNA Agilent 5071C and OTA chamber. All measurements are done with the part no. 1461530100 with a cable length of 100mm.

Antenna illustrations in this document are generic representations. They are not intended to be an image of any antenna listed in the scope.

2.0 PRODUCT DESCRIPTION

A. DEFINITIONS OF TERMS

The overall antenna size is 34.9mm*9mm (Figure 1).

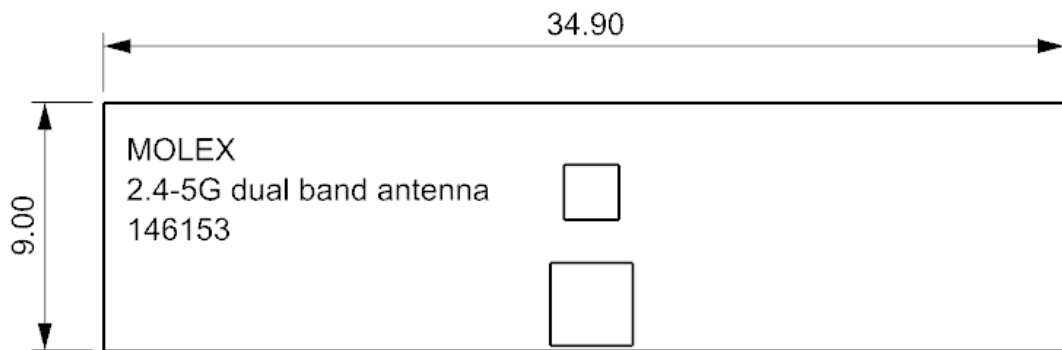

FIGURE 1. DIMENSION OF THE 2.4/5GHZ BALANCE FLEX ANTENNA

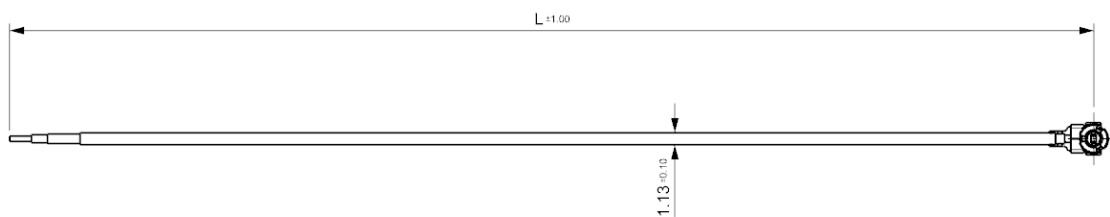

FIGURE 2. CABLE LINE VIEW OF WIFI 2.4/5GHZ BALANCE FLEX ANTENNA

REVISION: D	ECR/ECN INFORMATION: EC No: ABU2016-0043 DATE: 2016/02/03	TITLE: 2.4/5GHz Balance Flex Antenna Application Specification	SHEET No. 1 of 10
DOCUMENT NUMBER: AS-146153-100	CREATED / REVISED BY: Stephen Hu 2016/02/03	CHECKED BY: Ryan Liu 2016/02/03	APPROVED BY: Welson Tan 2016/02/03

B. RF PERFORMANCE OF ANTENNA LOADED WITH PC/ABS MATERIAL BLOCK OF 1MM THICKNESS IN FREE SPACE

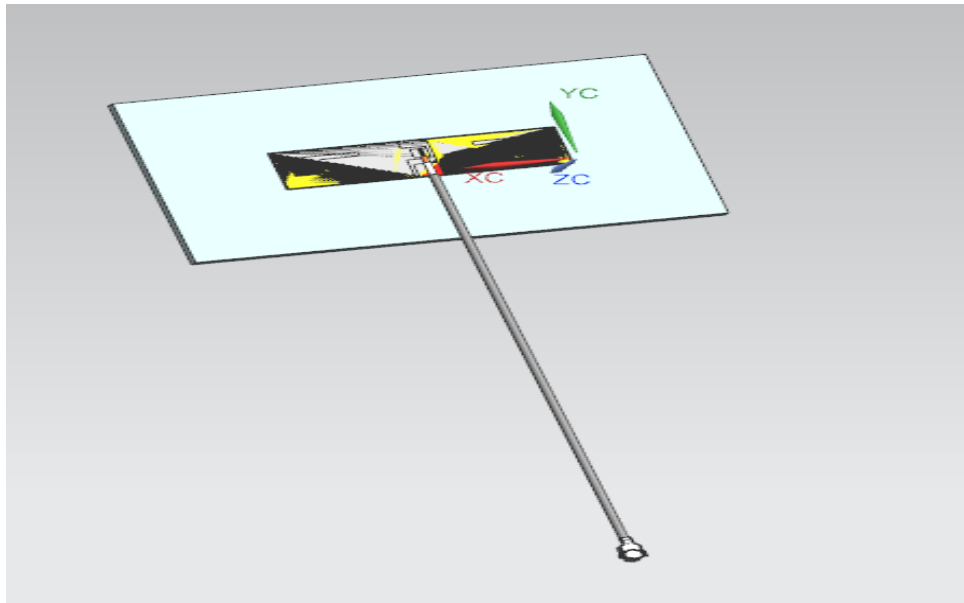

FIGURE 3.1. ANTENNA LOADED WITH PC/ABS BLOCK OF 1MM THICKNESS

DESCRIPTION	TEST CONDITION	REQUIREMENTS	
Frequency Range	2.4GHz~5.85GHz	2.4GHz~2.5GHz	5.15GHz~5.85GHz
Return Loss	Antenna loaded on PC/ABS housing (thickness 1mm) with 100mm 1.13mm diameter micro coaxial cable Measured by VNA5071C	< -10 dB	
Peak Gain	Measure antenna on recommended PC/ABS housing through OTA chamber	3.0 dBi	4.5 dBi
Total Efficiency	Measure antenna on recommended PC/ABS housing through OTA chamber	>75%	>70%
Polarization	Measure antenna on recommended PC/ABS housing through OTA chamber	Linear	
Input Impedance	Measure antenna on recommended PC/ABS housing through VNA E5071C	50 Ohms	

REVISION: D	ECR/ECN INFORMATION: EC No: ABU2016-0043 DATE: 2016/02/03	TITLE: 2.4/5GHz Balance Flex Antenna Application Specification	SHEET No. 2 of 10
DOCUMENT NUMBER: AS-146153-100	CREATED / REVISED BY: Stephen Hu 2016/02/03	CHECKED BY: Ryan Liu 2016/02/03	APPROVED BY: Welson Tan 2016/02/03

3.0 REFERENCE DOCUMENTS

- ENGINEERING DRAWING – E-146153-100
- PRODUCT SPECIFICATION – PS-146153-100
- PACKAGING INFORMATION – REFER TO THE MOLEX RELATED PACKAGING DRAWINGS.

4.0 RF PERFORMANCE AS A FUNCTION OF IMPLEMENTATION

4.1 ANTENNA RF PERFORMANCE AS A FUNCTION OF DIFFERENT LOCATION WITH VERTICAL GROUND

Four ground locations with vertical ground have been evaluated, with different distances from the antenna and these locations are shown in figure 4.1. The PCB size is 90mm*90mm and we move the PCB to four locations for each test. The antennas meet the spec of the return loss and the total efficiency specification at location 4. The minimum ground distance from antenna is recommended to be 20mm to meet the antenna specification.

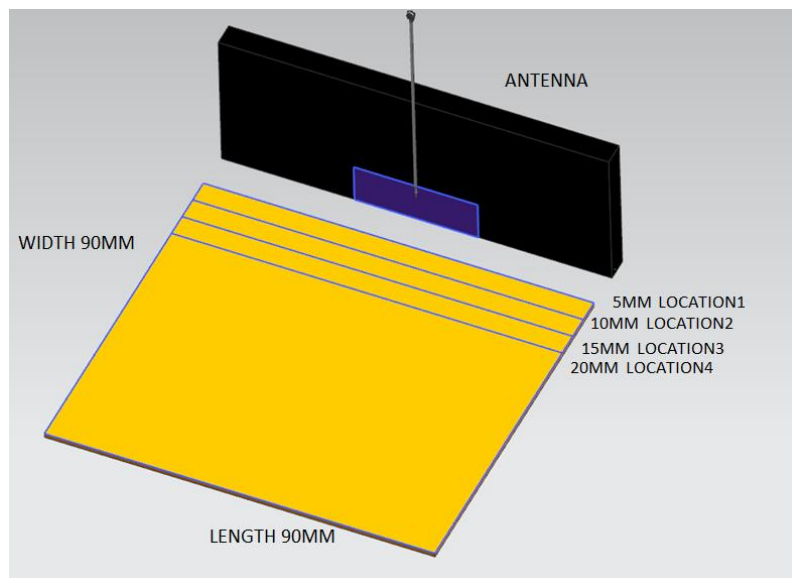

FIGURE 4.1 FOUR LOCATIONS WITH VERTICAL GROUND

Ground Area: 90mm*90mm

- (a) Location 1: Distance between antenna and ground is about 5mm.
- (b) Location 2: Distance between antenna and ground is about 10mm
- (c) Location 3: Distance between antenna and ground is about 15mm.
- (d) Location 4: Distance between antenna and ground is about 20mm.

REVISION: D	ECR/ECN INFORMATION: EC No: ABU2016-0043 DATE: 2016/02/03	TITLE: 2.4/5GHz Balance Flex Antenna Application Specification	SHEET No. 3 of 10
DOCUMENT NUMBER: AS-146153-100	CREATED / REVISED BY: Stephen Hu 2016/02/03	CHECKED BY: Ryan Liu 2016/02/03	APPROVED BY: Welson Tan 2016/02/03



APPLICATION SPECIFICATION

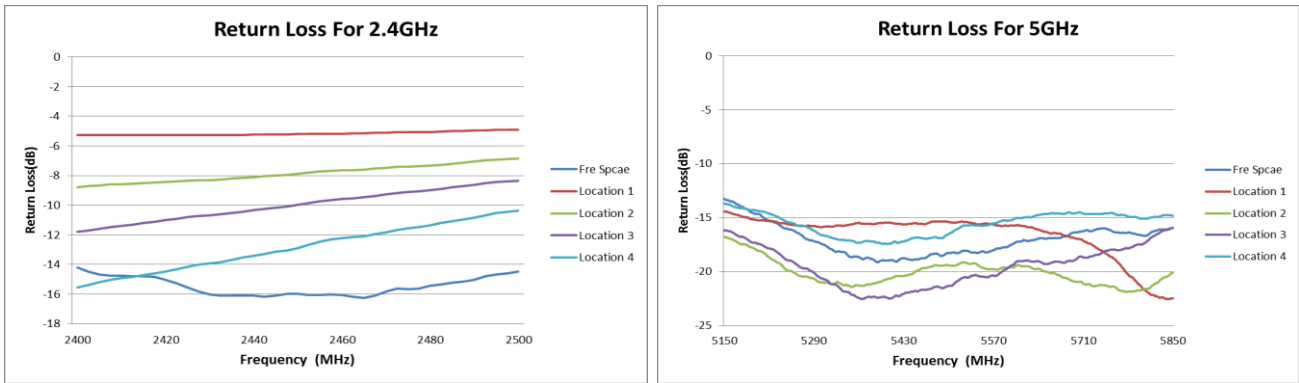

FIGURE 4.1.1 RETURN LOSS OF ANTENNA AT 2.4/5GHZ BAND AT FOUR LOCATIONS WITH VERTICAL GROUND

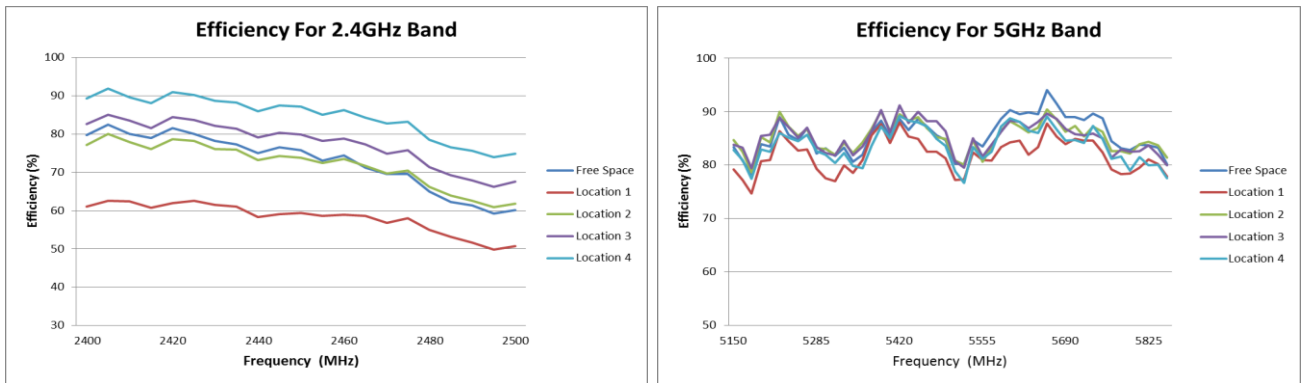

FIGURE 4.1.2 EFFICIENCY OF ANTENNA AT 2.4/5GHZ BAND AT FOUR LOCATIONS WITH VERTICAL GROUND

REVISION: D	ECR/ECN INFORMATION: EC No: ABU2016-0043 DATE: 2016/02/03	TITLE: 2.4/5GHz Balance Flex Antenna Application Specification	SHEET No. 4 of 10
DOCUMENT NUMBER: AS-146153-100	CREATED / REVISED BY: Stephen Hu 2016/02/03	CHECKED BY: Ryan Liu 2016/02/03	APPROVED BY: Welson Tan 2016/02/03

4.2 ANTENNA RF PERFORMANCE AS A FUNCTION OF DIFFERENT LOCATION WITH PARALLEL GROUND

Four ground locations with parallel ground have been evaluated, and these locations are shown in figure 4.2. The PCB size is 90mm*90mm and we move the PCB to four locations for each test. Though the antenna cannot meet the return loss specification at 2.4GHz band at location 4 but it can fulfill the efficiency specification. The minimum ground distance from the ground is recommended to be 20mm from the antenna to meet the total efficiency specification.

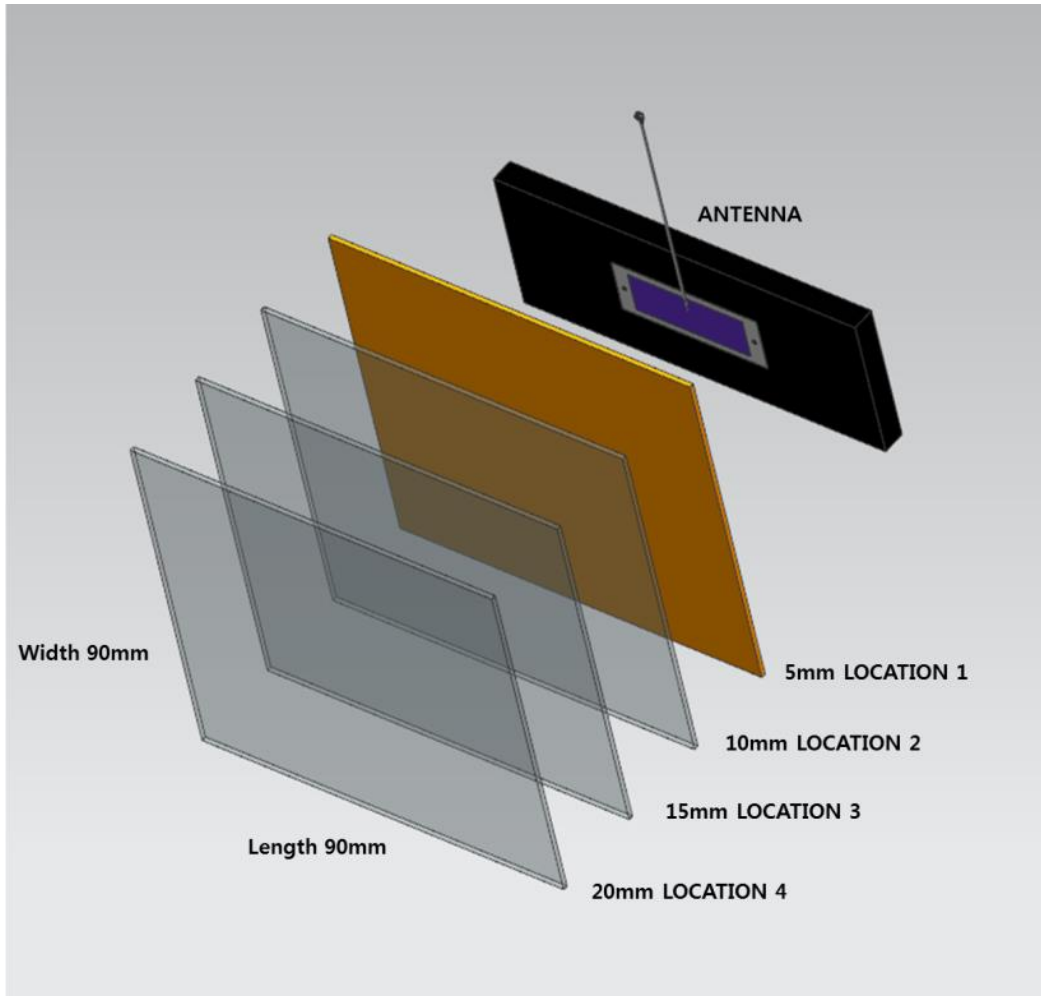

FIGURE 4.2 FOUR LOCATIONS WITH PARALLEL GROUND

Ground Area: 90mm*90mm

- (a)Location 1: Distance between antenna and ground is about 5mm
- (b)Location 2: Distance between antenna and ground is about 10mm.
- (c)Location 3: Distance between antenna and ground is about 15mm.
- (d)Location 4: Distance between antenna and ground is about 20mm.

REVISION: D	ECR/ECN INFORMATION: EC No: ABU2016-0043 DATE: 2016/02/03	TITLE: 2.4/5GHz Balance Flex Antenna Application Specification	SHEET No. 5 of 10
DOCUMENT NUMBER: AS-146153-100	CREATED / REVISED BY: Stephen Hu 2016/02/03	CHECKED BY: Ryan Liu 2016/02/03	APPROVED BY: Welson Tan 2016/02/03



APPLICATION SPECIFICATION

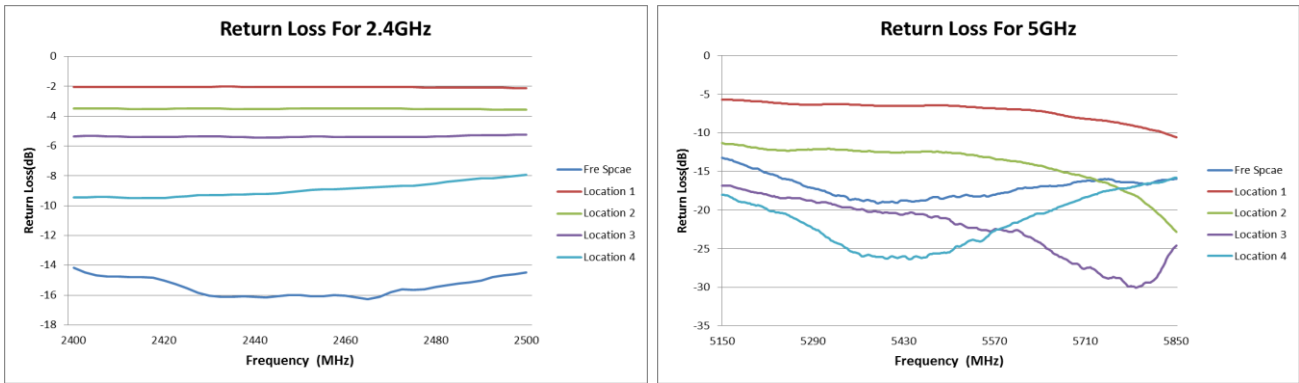

FIGURE 4.2.1 RETURN LOSS OF ANTENNA AT 2.4/5GHZ BAND AT FOUR LOCATIONS WITH PARALLEL GROUND

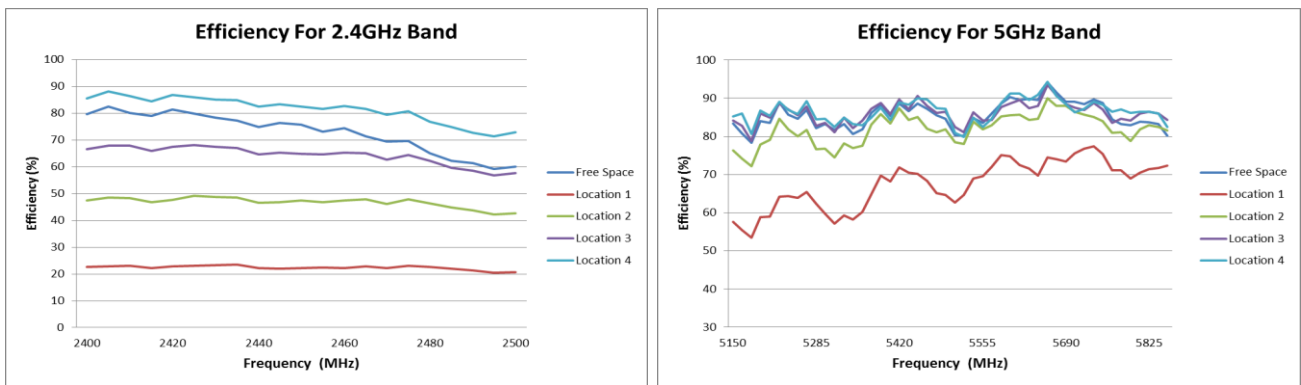
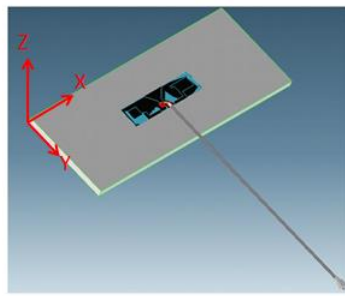

FIGURE 4.2.2 EFFICIENCY OF ANTENNA AT 2.4/5GHZ BAND AT FOUR LOCATIONS WITH PARALLEL GROUND

REVISION: D	ECR/ECN INFORMATION: EC No: ABU2016-0043 DATE: 2016/02/03	TITLE: 2.4/5GHz Balance Flex Antenna Application Specification	SHEET No. 6 of 10
DOCUMENT NUMBER: AS-146153-100	CREATED / REVISED BY: Stephen Hu 2016/02/03	CHECKED BY: Ryan Liu 2016/02/03	APPROVED BY: Welson Tan 2016/02/03

5.0 RADIATION PATTERN



XY-2450MHz

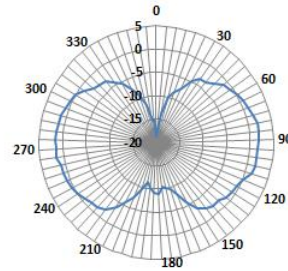

XZ-2450MHz

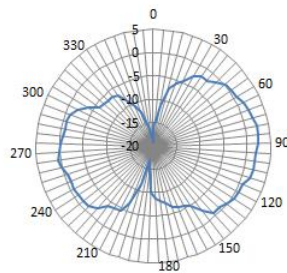

YZ-2450MHz

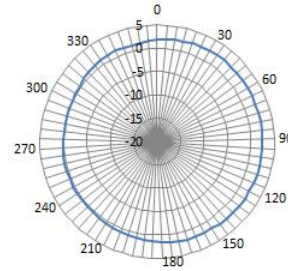
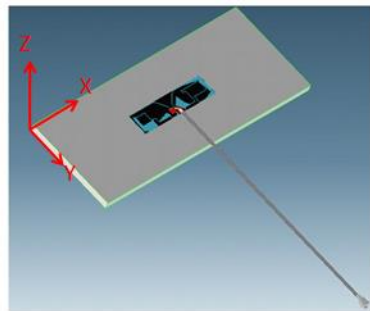
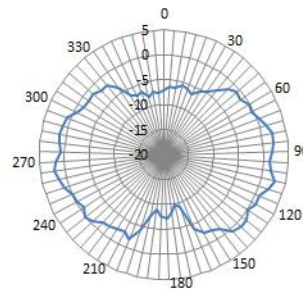

FIGURE 5.1 RADIATION PATTERN OF ANTENNA AT 2.45GHZ IN FREE SPACE



XY-5450MHz



XZ-5450MHz

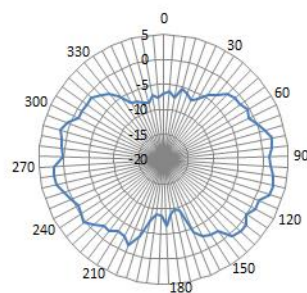

YZ-5450MHz

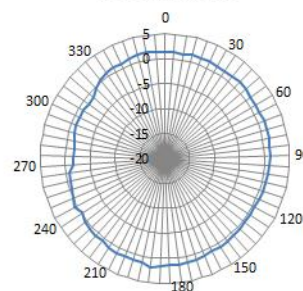

FIGURE 5.2 RADIATION PATTERN OF ANTENNA AT 5.45GHZ IN FREE SPACE

REVISION: D	ECR/ECN INFORMATION: EC No: ABU2016-0043 DATE: 2016/02/03	TITLE: 2.4/5GHz Balance Flex Antenna Application Specification	SHEET No. 7 of 10
DOCUMENT NUMBER: AS-146153-100	CREATED / REVISED BY: Stephen Hu 2016/02/03	CHECKED BY: Ryan Liu 2016/02/03	APPROVED BY: Welson Tan 2016/02/03



APPLICATION SPECIFICATION

6.0 THE ANTENNA PERFORMANCE VARIATION WITH CABLE LENGTH

6.0.1 CABLE LOSS

ITEM	DESCRIPTION	TEST CONDITION	REQUIREMENT	
6.0.1.1	Frequency Range	2 GHz~6GHz	2GHz~3GHz	5GHz~6.0GHz
6.0.1.2	Attenuation	1m cable measured by VNA5071C	≤3.5dB/m	≤5dB/m

6.0.2 CABLE LENGTH AFFECT THE ANTENNA PERFORMANCE

Balance antenna resonance is insensitive by cable length, but the cable loss will affect the total efficiency. Refer to 6.0.1

6.0.3 FOR EXAMPLE

Base on the 100mm cable performance, we can mostly compute the 300mm cable's.

Frequency (MHz)	100mm cable		cable loss	300mm cable	
	Efficiency (dB)	Efficiency (%)		Efficiency (dB)	Efficiency (%)
	X		X-LOSS=Y	Y	
2400	-1.06132	78.3192	0.2m*3.5dB/m	-1.76132	66.66
2410	-1.00181	79.3997		-1.70181	67.58
2420	-1.03427	78.8086		-1.73427	67.08
2430	-0.929705	80.729		-1.629705	68.71
2440	-1.06668	78.2226		-1.76668	66.58
2450	-1.05499	78.4334		-1.75499	66.76
2460	-1.03892	78.7241		-1.73892	67.01
2470	-1.15769	76.6004		-1.85769	65.20
2480	-1.12229	77.2274		-1.82229	65.73
2490	-1.24719	75.0379		-1.94719	63.87
2500	-1.20995	75.6841		-1.90995	64.42

REVISION: D	ECR/ECN INFORMATION: EC No: ABU2016-0043 DATE: 2016/02/03	TITLE: 2.4/5GHz Balance Flex Antenna Application Specification	SHEET No. 8 of 10
DOCUMENT NUMBER: AS-146153-100	CREATED / REVISED BY: Stephen Hu 2016/02/03	CHECKED BY: Ryan Liu 2016/02/03	APPROVED BY: Welson Tan 2016/02/03



APPLICATION SPECIFICATION

Frequency (MHz)	100mm cable		cable loss	300mm cable	
	Efficiency (dB)	Efficiency (%)		Efficiency (dB)	Efficiency (%)
	X		X-LOSS=Y	Y	
5150	-0.770398	83.7453	0.2*5dB/m	-1.770398	66.52
5180	-0.711782	84.8832		-1.711782	67.43
5210	-0.952011	80.3154		-1.952011	63.80
5240	-1.1463	76.8016		-2.1463	61.01
5270	-1.14173	76.8824		-2.14173	61.07
5300	-1.22177	75.4784		-2.22177	59.95
5330	-1.08976	77.8079		-2.08976	61.81
5360	-1.15375	76.67		-2.15375	60.90
5390	-1.23326	75.2791		-2.23326	59.80
5420	-0.984162	79.723		-1.984162	63.33
5450	-0.929805	80.7271		-1.929805	64.12
5480	-0.772094	83.7126		-1.772094	66.50
5510	-0.813659	82.9152		-1.813659	65.86
5540	-0.922461	80.8637		-1.922461	64.23
5570	-0.713125	84.857		-1.713125	67.40
5600	-0.584359	87.4106		-1.584359	69.43
5630	-0.321743	92.8594		-1.321743	73.76
5660	-0.644595	86.2066		-1.644595	68.48
5690	-0.739671	84.3399		-1.739671	66.99
5720	-0.818499	82.8228		-1.818499	65.79
5750	-0.913087	81.0385		-1.913087	64.37
5780	-1.2365	75.2229		-2.2365	59.75
5810	-1.18849	76.059		-2.18849	60.42
5840	-1.24776	75.0281		-2.24776	59.60
5850	-1.13398	77.0197		-2.13398	61.18

- The data is just for your reference, all accurate performance should be according to the test results in the OTA chamber.

REVISION: D	ECR/ECN INFORMATION: EC No: ABU2016-0043 DATE: 2016/02/03	TITLE: 2.4/5GHz Balance Flex Antenna Application Specification	SHEET No. 9 of 10
DOCUMENT NUMBER: AS-146153-100	CREATED / REVISED BY: Stephen Hu 2016/02/03	CHECKED BY: Ryan Liu 2016/02/03	APPROVED BY: Welson Tan 2016/02/03

7.0 ASSEMBLY GUIDELINES

During the assembly of the antenna in a device, the cable needs to be positioned away from the antenna flex. The antenna cable should not be close to the antenna flex. The cable has to be away from the pattern at least 5mm.

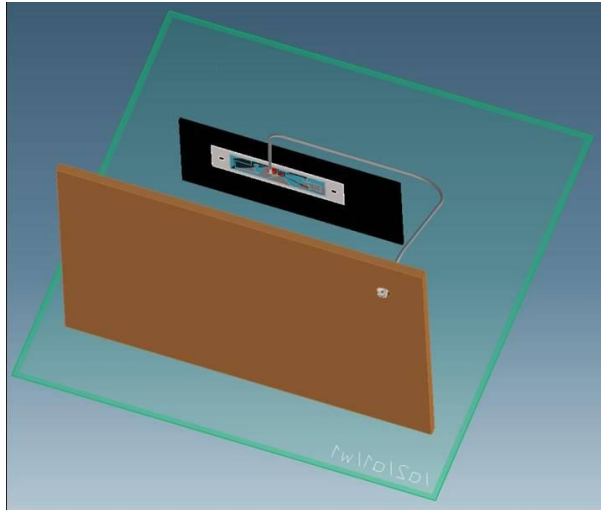

FIGURE 7.1 ASSEMBLY GUIDELINE

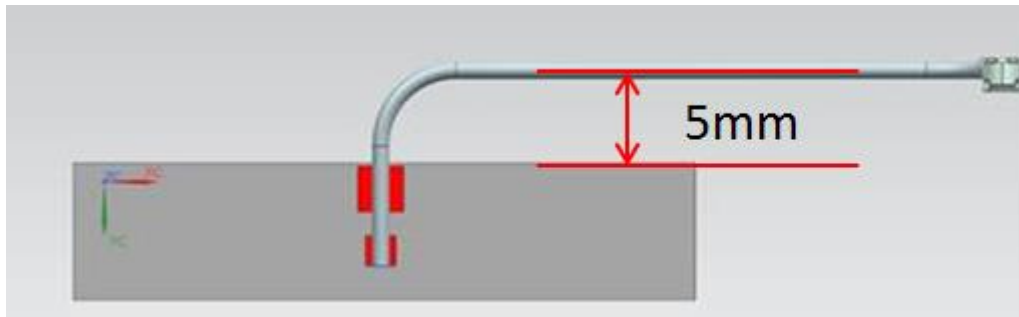

FIGURE 7.2 CABLE BENDING

REVISION: D	ECR/ECN INFORMATION: EC No: ABU2016-0043 DATE: 2016/02/03	TITLE: 2.4/5GHz Balance Flex Antenna Application Specification	SHEET No. 10 of 10
DOCUMENT NUMBER: AS-146153-100	CREATED / REVISED BY: Stephen Hu 2016/02/03	CHECKED BY: Ryan Liu 2016/02/03	APPROVED BY: Welson Tan 2016/02/03