



**MET Laboratories, Inc.** *Safety Certification - EMI - Telecom Environmental Simulation*

914 WEST PATAPSCO AVENUE • BALTIMORE, MARYLAND 21230-3432 • PHONE (410) 354-3300 • FAX (410) 354-3313  
33439 WESTERN AVENUE • UNION CITY, CALIFORNIA 94587 • PHONE (510) 489-6300 • FAX (510) 489-6372  
3162 BELICK STREET • SANTA CLARA, CA 95054 • PHONE (408) 748-3585 • FAX (510) 489-6372  
13501 MCCALLEN PASS • AUSTIN, TEXAS 78753 • PHONE (512) 287-2500 • FAX (512) 287-2513

March 14, 2018

Caterpillar Inc.  
100 NE Adams St.  
Peoria, IL 61629

Dear David Mitchell,

Enclosed is the EMC Wireless test report for compliance testing of the Caterpillar Inc., PL671 as tested to the requirements of Title 47 of the CFR, Ch. 1 (10-1-06 ed.), Part 15 Subpart C for Intentional Radiators.

Thank you for using the services of MET Laboratories, Inc. If you have any questions regarding these results or if MET can be of further service to you, please feel free to contact me.

Sincerely yours,  
MET LABORATORIES, INC.

Joel Huna  
Documentation Department

Reference: (\Caterpillar Inc.\EMCS95659C-FCC247 BLE Rev. 1)

Certificates and reports shall not be reproduced except in full, without the written permission of MET Laboratories, Inc. While use of the A2LA logo in this report reflects MET accreditation under these programs, the report must not be used by the client to claim product certification, approval, or endorsement by A2LA or any agency of the Federal Government. This letter of transmittal is not a part of the attached report.



*The Nation's First Licensed Nationally Recognized Testing Laboratory*

## **Electromagnetic Compatibility Criteria Test Report**

for the

**Caterpillar Inc.  
PL671**

**Tested under**  
the FCC Certification Rules  
contained in  
15.247 Subpart C for Intentional Radiators

**MET Report: EMCS95659C-FCC247 BLE Rev. 1**

March 14, 2018

**Prepared For:**

**Caterpillar Inc.  
100 NE Adams St.  
Peoria, IL 61629**

**Prepared By:**  
**MET Laboratories, Inc.**  
914 West Patapsco Avenue, Baltimore, MD 21230

**Electromagnetic Compatibility Criteria  
Test Report**

for the

**Caterpillar Inc.  
PL671**

**Tested under**  
the FCC Certification Rules  
contained in  
15.247 Subpart C for Intentional Radiators



James Borrott, Project Engineer  
Electromagnetic Compatibility Lab



Joel Huna  
Documentation Department

**Engineering Statement:** The measurements shown in this report were made in accordance with the procedures indicated, and the emissions from this equipment were found to be within the limits applicable. I assume full responsibility for the accuracy and completeness of these measurements, and for the qualifications of all persons taking them. It is further stated that upon the basis of the measurements made, the equipment tested is capable of operation in accordance with the requirements of the FCC Rules Part 15.247 under normal use and maintenance.



John Mason,  
Director, Electromagnetic Compatibility Lab

## Report Status Sheet

Revision	Report Date	Reason for Revision
∅	March 7, 2018	Initial Issue.
1	March 14, 2018	TCB Corrections and Customer Name Change.

## Table of Contents

<b>I.</b>	<b>Executive Summary .....</b>	<b>1</b>
	A. Purpose of Test .....	2
	B. Executive Summary .....	2
<b>II.</b>	<b>Equipment Configuration .....</b>	<b>3</b>
	A. Overview .....	4
	B. References.....	5
	C. Test Site .....	5
	D. Measurement Uncertainty .....	5
	E. Description of Test Sample.....	6
	F. Equipment Configuration.....	7
	G. Support Equipment .....	7
	H. Ports and Cabling Information.....	7
	I. Mode of Operation.....	7
	J. Method of Monitoring EUT Operation .....	8
	K. Modifications .....	8
	a) Modifications to EUT.....	8
	b) Modifications to Test Standard.....	8
	L. Disposition of EUT.....	8
<b>III.</b>	<b>Electromagnetic Compatibility Criteria for Intentional Radiators.....</b>	<b>9</b>
	§ 15.203 Antenna Requirement.....	10
	§ 15.207(a) Conducted Emissions Limits.....	11
	§ 15.247(a)(a) 6 dB and 99% Bandwidth .....	12
	§ 15.247(b) Peak Power Output .....	15
	§ 15.247(d) Radiated Spurious Emissions Requirements and Band Edge .....	18
	§ 15.247(d) RF Conducted Spurious Emissions Requirements and Band Edge.....	25
	§ 15.247(e) Peak Power Spectral Density .....	28
	§ 15.247(i) Maximum Permissible Exposure .....	31
<b>IV.</b>	<b>Test Equipment .....</b>	<b>32</b>
<b>V.</b>	<b>Certification &amp; User’s Manual Information.....</b>	<b>34</b>
	A. Certification Information .....	35
	B. Label and User’s Manual Information .....	39

## List of Tables

Table 1. Executive Summary of EMC Part 15.247 Compliance Testing .....	2
Table 2. EUT Summary Table.....	4
Table 3. References .....	5
Table 4. Measurement Uncertainty .....	5
Table 5. Equipment Configuration .....	7
Table 6. Support Equipment.....	7
Table 7. Ports and Cabling Information .....	7
Table 8. Antenna List .....	10
Table 9. Conducted Limits for Intentional Radiators from FCC Part 15 § 15.207(a) .....	11
Table 10. 6 dB Occupied Bandwidth, Test Results .....	13
Table 11. Output Power Requirements from §15.247(b) .....	15
Table 12. Peak Power Output, Test Results .....	16
Table 13. Restricted Bands of Operation.....	18
Table 14. Radiated Emissions Limits Calculated from FCC Part 15, § 15.209 (a) .....	19
Table 15. Peak Power Spectral Density, Test Results .....	29
Table 16. Test Equipment List .....	33

## List of Plots

Plot 1. 6 dB Occupied Bandwidth, 2402 MHz .....	14
Plot 2. 6 dB Occupied Bandwidth, 2440 MHz .....	14
Plot 3. 6 dB Occupied Bandwidth, 2479 MHz .....	14
Plot 4. Peak Power Output, 2402 MHz .....	17
Plot 5. Peak Power Output, 2440 MHz .....	17
Plot 6. Peak Power Output, 2479 MHz .....	17
Plot 7. Radiated Spurious Emissions, 2402 MHz, 15.209 Average .....	20
Plot 8. Radiated Spurious Emissions, 2402 MHz, 15.209 Peak .....	20
Plot 9. Radiated Spurious Emissions, 2440 MHz, 15.209 Average .....	20
Plot 10. Radiated Spurious Emissions, 2440 MHz, 15.209 Peak .....	21
Plot 11. Radiated Spurious Emissions, 2479 MHz, 15.209 Average .....	21
Plot 12. Radiated Spurious Emissions, 2479 MHz, 15.209 Peak .....	21
Plot 13. Radiated Restricted Band Edge, 2479 MHz, Average .....	22
Plot 14. Radiated Restricted Band Edge, 2479 MHz, Peak .....	22
Plot 15. Radiated Restricted Band Edge, 2402 MHz, Average .....	23
Plot 16. Radiated Restricted Band Edge, 2402 MHz, Peak .....	23
Plot 17. Conducted Spurious Emissions, 2402 MHz, 30 MHz – 26 GHz .....	26
Plot 18. Conducted Spurious Emissions, 2440 MHz, 30 MHz – 26 GHz .....	26
Plot 19. Conducted Spurious Emissions, 2479 MHz, 30 MHz – 26 GHz .....	26
Plot 20. Conducted Band Edge, 2402 MHz.....	27
Plot 21. Conducted Band Edge, 2479 MHz.....	27
Plot 22. Peak Power Spectral Density, 2402 MHz .....	30
Plot 23. Peak Power Spectral Density, 2440 MHz .....	30
Plot 24. Peak Power Spectral Density, 2479 MHz .....	30

## List of Figures

Figure 1. Block Diagram of Test Configuration.....	6
Figure 2. Block Diagram, Occupied Bandwidth Test Setup.....	12
Figure 3. Peak Power Output Test Setup.....	15

Figure 4. Block Diagram, Conducted Spurious Emissions Test Setup..... 25  
Figure 5. Block Diagram, Peak Power Spectral Density Test Setup ..... 28

## List of Photographs

Photograph 1. Radiated Spurious Emissions, 30 MHz – 1 GHz, Test Setup..... 24  
Photograph 2. Radiated Spurious Emissions, 1 – 18 GHz, Test Setup..... 24

## List of Terms and Abbreviations

<b>AC</b>	<b>A</b> lternating <b>C</b> urrent
<b>ACF</b>	<b>A</b> ntenna <b>C</b> orrection <b>F</b> actor
<b>Cal</b>	<b>C</b> alibration
<i>d</i>	<b>M</b> easurement <b>D</b> istance
<b>dB</b>	<b>D</b> ecibels
<b>dB<math>\mu</math>A</b>	<b>D</b> ecibels above one <b>m</b> icroamp
<b>dB<math>\mu</math>V</b>	<b>D</b> ecibels above one <b>m</b> icrovolt
<b>dB<math>\mu</math>A/m</b>	<b>D</b> ecibels above one <b>m</b> icroamp <b>p</b> er meter
<b>dB<math>\mu</math>V/m</b>	<b>D</b> ecibels above one <b>m</b> icrovolt <b>p</b> er meter
<b>DC</b>	<b>D</b> irect <b>C</b> urrent
<b>E</b>	<b>E</b> lectric <b>F</b> ield
<b>DSL</b>	<b>D</b> igital <b>S</b> ubscriber <b>L</b> ine
<b>ESD</b>	<b>E</b> lectrostatic <b>D</b> ischarge
<b>EUT</b>	<b>E</b> quipment <b>U</b> nder <b>T</b> est
<i>f</i>	<b>F</b> requency
<b>FCC</b>	<b>F</b> ederal <b>C</b> ommunications <b>C</b> ommission
<b>GRP</b>	<b>G</b> round <b>R</b> eference <b>P</b> lane
<b>H</b>	<b>M</b> agnetic <b>F</b> ield
<b>HCP</b>	<b>H</b> orizontal <b>C</b> oupling <b>P</b> lane
<b>Hz</b>	<b>H</b> ertz
<b>IEC</b>	<b>I</b> nternational <b>E</b> lectrotechnical <b>C</b> ommission
<b>kHz</b>	<b>k</b> ilohertz
<b>kPa</b>	<b>k</b> ilopascal
<b>kV</b>	<b>k</b> ilovolt
<b>LISN</b>	<b>L</b> ine <b>I</b> mpedance <b>S</b> tabilization <b>N</b> etwork
<b>MHz</b>	<b>M</b> egahertz
<b><math>\mu</math>H</b>	<b>m</b> icrohenry
<b><math>\mu</math></b>	<b>m</b> icrofarad
<b><math>\mu</math>s</b>	<b>m</b> icroseconds
<b>NEBS</b>	<b>N</b> etwork <b>E</b> quipment- <b>B</b> uilding <b>S</b> ystem
<b>PRF</b>	<b>P</b> ulse <b>R</b> epetition <b>F</b> requency
<b>RF</b>	<b>R</b> adio <b>F</b> requency
<b>RMS</b>	<b>R</b> oot- <b>M</b> ean- <b>S</b> quare
<b>TWT</b>	<b>T</b> raveling <b>W</b> ave <b>T</b> ube
<b>V/m</b>	<b>V</b> olts <b>p</b> er meter
<b>VCP</b>	<b>V</b> ertical <b>C</b> oupling <b>P</b> lane



# I. Executive Summary

**A. Purpose of Test**

An EMC evaluation was performed to determine compliance of the Caterpillar Inc. PL671, with the requirements of Part 15, §15.247. All references are to the most current version of Title 47 of the Code of Federal Regulations in effect. In accordance with §2.1033, the following data is presented in support of the Certification of the PL671. Caterpillar Inc. should retain a copy of this document which should be kept on file for at least two years after the manufacturing of the PL671, has been **permanently** discontinued.

**B. Executive Summary**

The following tests were conducted on a sample of the equipment for the purpose of demonstrating compliance with Part 15, §15.247, in accordance with Caterpillar Inc., purchase order number PO9516. All tests were conducted using measurement procedure ANSI C63.4-2014.

<b>FCC Reference 47 CFR Part 15.247:2005</b>	<b>Description</b>	<b>Compliance</b>
Title 47 of the CFR, Part 15 §15.203	Antenna Requirement	Compliant
Title 47 of the CFR, Part 15 §15.207(a)	Conducted Emission Limits	Not Applicable
Title 47 of the CFR, Part 15 §15.247(a)(2)	6dB Occupied Bandwidth	Compliant
Title 47 of the CFR, Part 15 §15.247(b)	Peak Power Output	Compliant
Title 47 of the CFR, Part 15 §15.247(d); §15.209; §15.205	Radiated Spurious Emissions Requirements	Compliant
Title 47 of the CFR, Part 15 §15.247(d)	RF Conducted Spurious Emissions Requirements	Compliant
Title 47 of the CFR, Part 15 §15.247(d)	RF Conducted Band Edge	Compliant
Title 47 of the CFR, Part 15; §15.247(e)	Peak Power Spectral Density	Compliant
Title 47 of the CFR, Part 15 §15.247(i)	Maximum Permissible Exposure (MPE)	Compliant

**Table 1. Executive Summary of EMC Part 15.247 Compliance Testing**

## II. Equipment Configuration

## A. Overview

MET Laboratories, Inc. was contracted by Caterpillar Inc. to perform testing on the PL671, under Caterpillar Inc.'s purchase order number PO9516.

This document describes the test setups, test methods, required test equipment, and the test limit criteria used to perform compliance testing of the Caterpillar Inc., PL671.

The results obtained relate only to the item(s) tested.

<b>Model(s) Tested:</b>	PL671	
<b>Model(s) Covered:</b>	PL671	
<b>EUT Specifications:</b>	Primary Power: 9 – 32 VDC	
	FCC ID: PQMPL671	
	Type of Modulations:	$\pi/4$ DQPSK, 8DPSK
	Equipment Code:	DTS
	Peak RF Output Power:	-0.823 dBm
	EUT Frequency Ranges:	2400 to 2480 MHz
<b>Analysis:</b>	The results obtained relate only to the item(s) tested.	
<b>Environmental Test Conditions:</b>	Temperature: 15-35° C	
	Relative Humidity: 30-60%	
	Barometric Pressure: 860-1060 mbar	
<b>Evaluated by:</b>	James Borrott	
<b>Report Date(s):</b>	March 14, 2018	

**Table 2. EUT Summary Table**

## B. References

<b>CFR 47, Part 15, Subpart C</b>	Federal Communication Commission, Code of Federal Regulations, Title 47, Part 15: General Rules and Regulations, Allocation, Assignment, and Use of Radio Frequencies
<b>ANSI C63.4:2014</b>	Methods and Measurements of Radio-Noise Emissions from Low-Voltage Electrical And Electronic Equipment in the Range of 9 kHz to 40 GHz
<b>ISO/IEC 17025:2005</b>	General Requirements for the Competence of Testing and Calibration Laboratories
<b>ANSI C63.10-2013</b>	American National Standard for Testing Unlicensed Wireless Devices

**Table 3. References**

## C. Test Site

All testing was performed at MET Laboratories, Inc., 3162 Belick St., Santa Clara, CA 95054. All equipment used in making physical determinations is accurate and bears recent traceability to the National Institute of Standards and Technology.

Radiated Emissions measurements were performed in a 3 meter semi-anechoic chamber (equivalent to an Open Area Test Site). In accordance with §2.948(a)(3), a complete site description is contained at MET Laboratories.

## D. Measurement Uncertainty

Test Method	Typical Expanded Uncertainty	K	Confidence Level
<b>RF Frequencies</b>	±4.52 Hz	2	95%
<b>RF Power Conducted Emissions</b>	±2.32 dB	2	95%
<b>RF Power Conducted Spurious Emissions</b>	±2.25 dB	2	95%
<b>RF Power Radiated Emissions</b>	±3.01 dB	2	95%

**Table 4. Measurement Uncertainty**

## E. Description of Test Sample

The Caterpillar Inc. PL671, Equipment Under Test (EUT), is a dedicated short range communication (DSRC) device. Units are mounted on heavy machinery on both sides of the vehicle to minimize blind spots. It is intended to provide proximity information vehicle to vehicle. A dedicated radio module in the EUT is used to do provide this link. EUT can also communicate to a stationary device or device on a smaller vehicle by Wi-Fi or BT. A GNSS module inside the EUT provides positioning information to the EUT. The two EUTs communicate with each other and the vehicle using Ethernet. An audio module in the EUT can send audible warnings in case of collision possibilities.

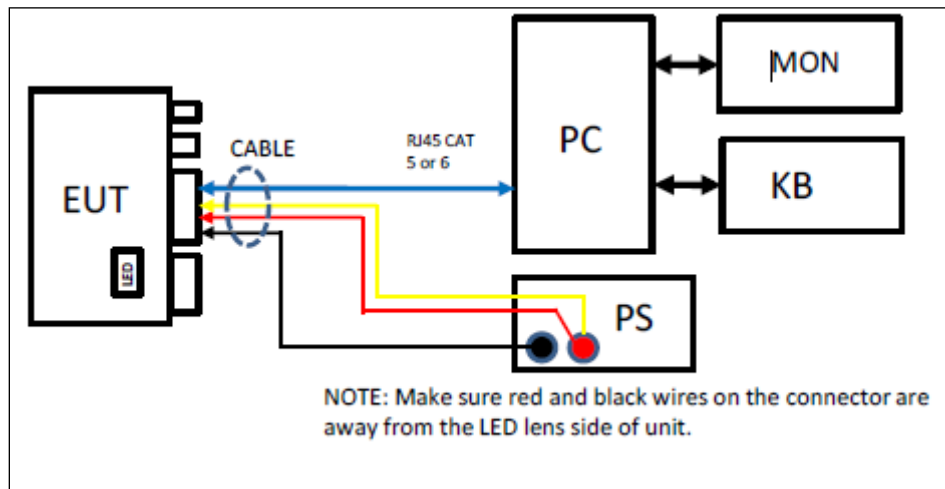

**Figure 1. Block Diagram of Test Configuration**

Note: EUT modified with antenna terminal only for test purposes. Otherwise, EUT will have permanent antenna.

## F. Equipment Configuration

The EUT was set up as outlined in Figure 1, Block Diagram of Test Setup. All cards, racks, etc., incorporated as part of the EUT is included in the following list.

Ref. ID	Slot #	Name / Description	Model Number	Part Number	Serial Number	Revision
EUT	N/A	DSRC Radio	PL671			A

Table 5. Equipment Configuration

## G. Support Equipment

Support equipment necessary for the operation and testing of the EUT is included in the following list.

Ref. ID	Name / Description	Manufacturer	Model Number	* Customer Supplied Calibration Data
PS	Power Supply	MASTECH	HY1803D	N/A
PC	Computer	Dell	VOSTRO or Equiv.	N/A

The 'Customer Supplied Calibration Data' column will be marked as either not applicable, not available, or will contain the calibration date supplied by the customer.

Table 6. Support Equipment

## H. Ports and Cabling Information

Ref. ID	Port Name on EUT	Cable Description	Qty.	Length (m)	Max Length	Shielded (Y/N)	Termination Point
1	Data Cable	RJ45 CAT 5 or 6 on Quake Cable	2	TBD		No	12 PIN Conn.
2	Power Supply Leads	On Quake Conn. Red, Black, and Yellow		TBD		No	9-32V

Table 7. Ports and Cabling Information

## I. Mode of Operation

Mode 1: The DSRC module in the EUT is put in a continuous transmit mode using the test script. It will broadcast at full power till turned off.

Mode 2: The Wi-Fi module in the EUT is put into continuous transmit mode using the test script. It will broadcast at full power till turned off.

Mode 3: The GNSS module in the EUT is activated using the test script and sends out NMEA data to the CPU. It will receive and send data till turned off. The EUT must be connected to an active antenna and have a clear sky view

Mode 4: The Ethernet is used to set up the test modes. The Ethernet is set to full duplex and set to communicate with the computer in a continuous mode.

## **J. Method of Monitoring EUT Operation**

Mode 1: The DSRC is activated for the test menu using “d”. It will download firmware to the DSRC module. A secondary menu will appear. Select “b” (TX with no GPS). Current will increase and a rolling script will appear in the terminal window continuously. Please refer to Quake document 1153-3011 for instructions.

Mode 2: The Wi-Fi is activated by opening another terminal. Use the test script to select “w”. Select TX mode. A continuous script will scroll in the terminal as the module transmits.

Mode 3: Open another terminal and select “g” to activate the GNSS module. The NMEA data stream from the module will scroll continuously.

Mode 4: Open another terminal and set up a ping on the ENET. Continuous acknowledgement will be sent.

## **K. Modifications**

### **a) Modifications to EUT**

No modifications were made to the EUT.

### **b) Modifications to Test Standard**

No modifications were made to the test standard.

## **L. Disposition of EUT**

The test sample including all support equipment submitted to the Electro-Magnetic Compatibility Lab for testing was returned to Caterpillar Inc. upon completion of testing.



### **III. Electromagnetic Compatibility Criteria for Intentional Radiators**

## Electromagnetic Compatibility Criteria for Intentional Radiators

### § 15.203 Antenna Requirement

**Test Requirement:** § 15.203: An intentional radiator shall be designed to ensure that no antenna other than that furnished by the responsible party shall be used with the device. The use of a permanently attached antenna or of an antenna that uses a unique coupling to the intentional radiator shall be considered sufficient to comply with the provisions of this section. The manufacturer may design the unit so that a broken antenna can be replaced by the user, but the use of a standard antenna jack or electrical connector is prohibited.

The structure and application of the EUT were analyzed to determine compliance with Section 15.203 of the Rules. Section 15.203 states that the subject device must meet at least one of the following criteria:

- a.) Antenna must be permanently attached to the unit.
- b.) Antenna must use a unique type of connector to attach to the EUT.
- c.) Unit must be professionally installed. Installer shall be responsible for verifying that the correct antenna is employed with the unit.

**Results:** The EUT as tested is compliant the criteria of §15.203. Antenna is permanently attached.

**Test Engineer(s):** James Borrott

**Test Date(s):** December 4, 2018

Gain	Type	Model	Manufacturer
Peak 3.0 dBi 2.4 GHz	Balanced Flex	146153-0100	Molex

**Table 8. Antenna List**

## Electromagnetic Compatibility Criteria for Intentional Radiators

### § 15.207(a) Conducted Emissions Limits

**Test Requirement(s):** § 15.207 (a): For an intentional radiator that is designed to be connected to the public utility (AC) power line, the radio frequency voltage that is conducted back onto the AC power line on any frequency or frequencies, within the band 150 kHz to 30MHz, shall not exceed the limits in the following table, as measured using a 50  $\mu$ H/50  $\Sigma$  line impedance stabilization network (LISN). Compliance with the provisions of this paragraph shall be based on the measurement of the radio frequency voltage between each power line and ground at the power terminal. The lower limit applies at the boundary between the frequency ranges.

Frequency range (MHz)	§ 15.207(a), Conducted Limit (dB $\mu$ V)	
	Quasi-Peak	Average
* 0.15- 0.45	66 - 56	56 - 46
0.45 - 0.5	56	46
0.5 - 30	60	50

**Table 9. Conducted Limits for Intentional Radiators from FCC Part 15 § 15.207(a)**

**Test Procedure:** The EUT was placed on a 0.8 m-high wooden table inside a screen room. The EUT was situated such that the back of the EUT was 0.4 m from one wall of the vertical ground plane, and the remaining sides of the EUT were no closer than 0.8 m from any other conductive surface. The EUT was powered from a 50  $\Omega$ /50  $\mu$ H Line Impedance Stabilization Network (LISN). The EMC receiver scanned the frequency range from 150 kHz to 30 MHz. Conducted Emissions measurements were made in accordance with *ANSI C63.4-2014 "Methods and Measurements of Radio-Noise Emissions from Low-Voltage Electrical and Electronic Equipment in the Range of 9kHz to 40 GHz"*. The measurements were performed over the frequency range of 0.15 MHz to 30 MHz using a 50  $\Omega$ /50  $\mu$ H LISN as the input transducer to an EMC/field intensity meter. For the purpose of this testing, the transmitter was turned on. Scans were performed with the transmitter on.

**Test Results:** The EUT was not applicable with this requirement. Device is DC powered. Not applicable under FCC 15.207(c).

## Electromagnetic Compatibility Criteria for Intentional Radiators

### § 15.247(a)(2) 6 dB Bandwidth

**Test Requirements:** § 15.247(a)(2): Operation under the provisions of this section is limited to frequency hopping and digitally modulated intentional radiators that comply with the following provisions:

For systems using digital modulation techniques, the EUT may operate in the 902-928 MHz, 2400-2483.5 MHz and 5725-5850 MHz bands. The minimum 6dB bandwidth shall be at least 500 kHz.

**Test Procedure:** The transmitter was on and transmitting at the highest output power. The bandwidth of the fundamental frequency was measured with the spectrum analyzer using a RBW approximately 1% of the total emission bandwidth, VBW > RBW. The 6 dB Bandwidth was measured and recorded. The measurements were performed on the low, mid and high channels.

**Test Results** The EUT was compliant with § 15.247 (a)(2). No anomalies detected.

The 6 dB Bandwidth was determined from the plots on the following pages.

**Test Engineer(s):** James Borrott

**Test Date(s):** November 30, 2017

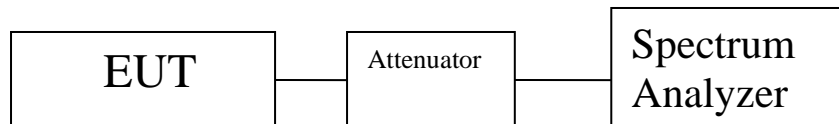

**Figure 2. Block Diagram, Occupied Bandwidth Test Setup**

## Occupied Bandwidth Test Results

Occupied Bandwidth		
Carrier Channel	Frequency (MHz)	Measured 6 dB Bandwidth (MHz)
Low	2402	.747467
Mid	2440	.739832
High	2479	.747633

**Table 10. 6 dB Occupied Bandwidth, Test Results**

## 6 dB Occupied Bandwidth Test Results

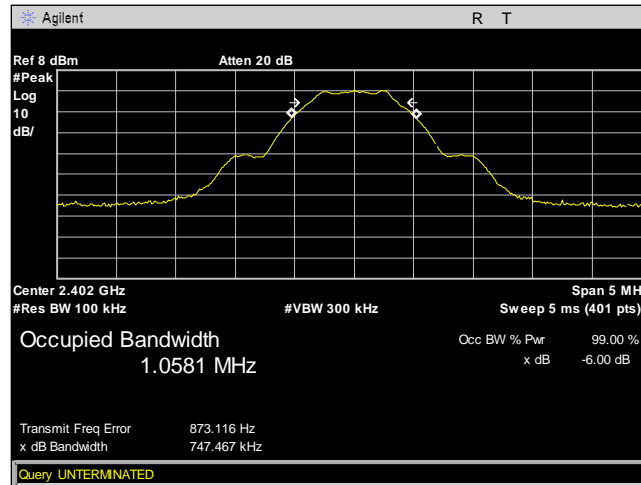

**Plot 1. 6 dB Occupied Bandwidth, 2402 MHz**

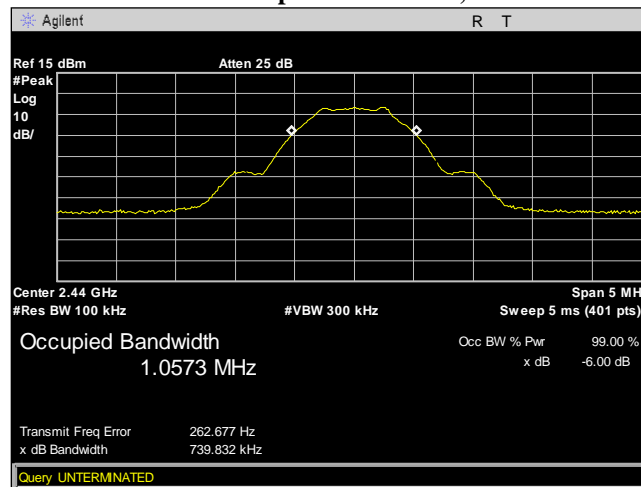

**Plot 2. 6 dB Occupied Bandwidth, 2440 MHz**

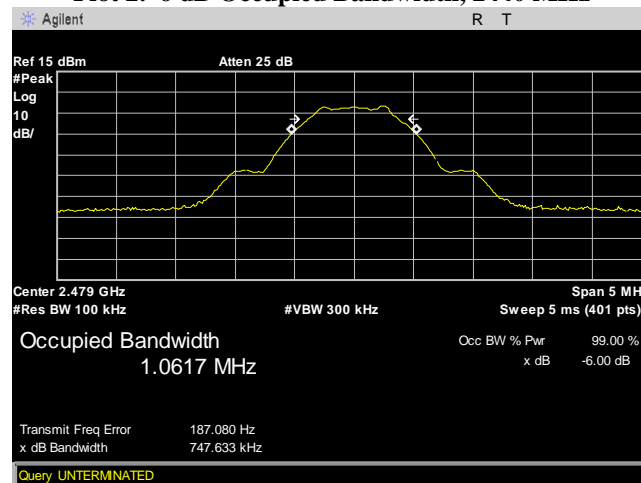

**Plot 3. 6 dB Occupied Bandwidth, 2479 MHz**

## Electromagnetic Compatibility Criteria for Intentional Radiators

### § 15.247(b) Peak Power Output

**Test Requirements:** §15.247(b): The maximum peak output power of the intentional radiator shall not exceed the following:

Digital Transmission Systems (MHz)	Output Limit (Watts)
902-928	1.000
2400-2483.5	1.000
5725- 5850	1.000

**Table 11. Output Power Requirements from §15.247(b)**

§15.247(c): if transmitting antennas of directional gain greater than 6 dBi are used the peak output power from the intentional radiator shall be reduced below the stated values in the Table 11, as appropriate, by the amount in dB that the directional gain of the antenna exceeds 6 dBi.

Systems operating in the 2400 – 2483.5 MHz band and using a point to point application may employ transmitting antennas with directional gain greater than 6 dBi provided the maximum peak output power of the intentional radiator is reduced by 1 dB for every 3 dB that the directional gain of the antenna exceeds 6 dBi.

Systems operating in the 5725 – 5850 MHz band that are used exclusively for fixed, point-to-point operations may employ transmitting antennas with directional gain greater than 6 dBi without any corresponding reduction in transmitter peak output power.

Fixed, point-to-point operation excludes the use of point-to-multipoint systems, Omni-directional applications, and multiple co-located intentional radiators transmitting the same information. The operator of the spread spectrum intentional radiator or, if the equipment is professionally installed, the installer is responsible for ensuring that the system is used exclusively for fixed, point-to-point operations. The instruction manual furnished with the intentional radiator shall contain language in the installation instructions informing the operator and the installer of this responsibility.

**Test Procedure:** The transmitter was connected to a calibrated spectrum analyzer. The EUT was measured at the low, mid and high channels of each band at the maximum power level.

**Test Results:** The EUT was compliant with the Peak Power Output limits of §15.247(b). No anomalies detected.

**Test Engineer(s):** James Borrott

**Test Date(s):** November 30, 2017

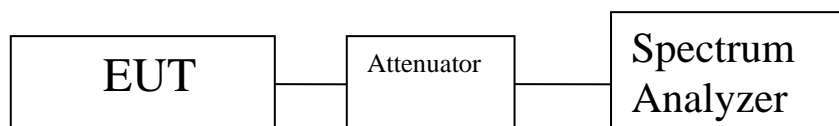

**Figure 3. Peak Power Output Test Setup**

## Peak Power Output Test Results

Peak Conducted Output Power		
Carrier Channel	Frequency (MHz)	Measured Peak Output Power dBm
Low	2402	-1.201
Mid	2440	-0.979
High	2479	-0.823

**Table 12. Peak Power Output, Test Results**



## Peak Power Output Test Results

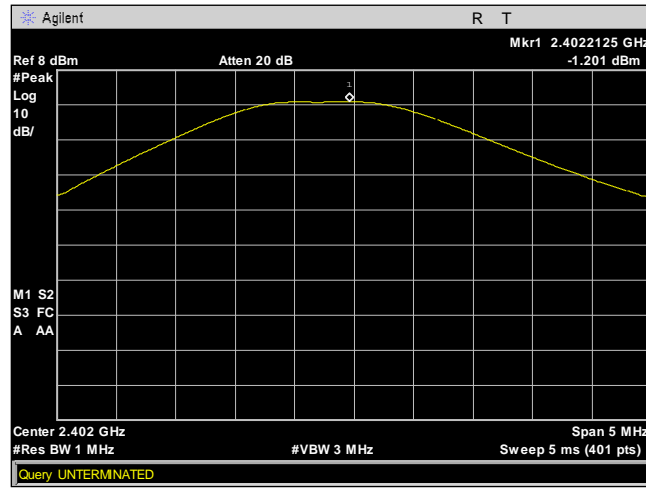

Plot 4. Peak Power Output, 2402 MHz

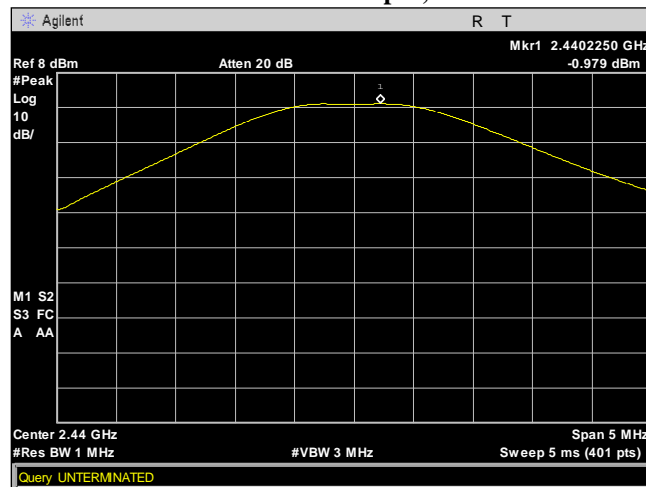

Plot 5. Peak Power Output, 2440 MHz

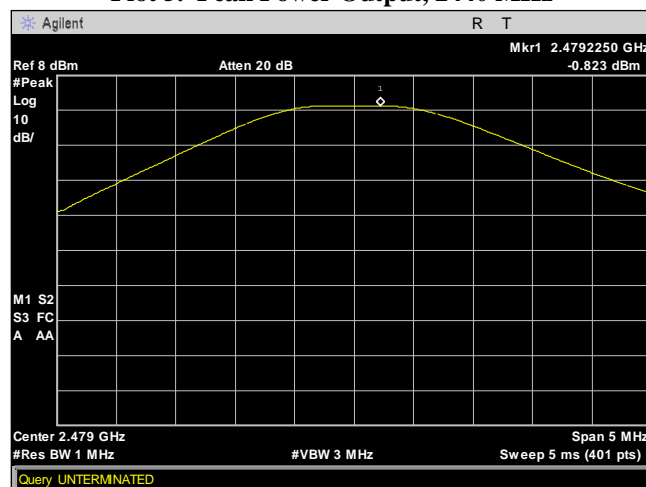

Plot 6. Peak Power Output, 2479 MHz

## Electromagnetic Compatibility Criteria for Intentional Radiators

### § 15.247(d) Radiated Spurious Emissions Requirements and Band Edge

**Test Requirements:** §15.247(d); §15.205: Emissions outside the frequency band.

**§15.247(d):** In any 100 kHz bandwidth outside the frequency band in which the spread spectrum or digitally modulated intentional radiator is operating, the radio frequency power that is produced by the intentional radiator shall be at least 20 dB below that in the 100 kHz bandwidth within the band that contains the highest level of the desired power, based on either an RF conducted or a radiated measurement. Attenuation below the general limits specified in § 15.209(a) is not required. In addition, radiated emissions which fall in the restricted bands, as defined in § 15.205(a), must also comply with the radiated emission limits specified in § 15.209(a).

**§15.205(a):** Except as shown in paragraph (d) of this section, only spurious emissions are permitted in any of the frequency bands listed below:

MHz	MHz	MHz	GHz
0.090–0.110-----	16.42–16.423	399.9–410	4.5–5.15
<sup>1</sup> 0.495–0.505-----	16.69475–16.69525	608–614	5.35–5.46
2.1735–2.1905-----	16.80425–16.80475	960–1240	7.25–7.75
4.125–4.128-----	25.5–25.67	1300–1427	8.025–8.5
4.17725–4.17775-----	37.5–38.25	1435–1626.5	9.0–9.2
4.20725–4.20775-----	73–74.6	1645.5–1646.5	9.3–9.5
6.215–6.218-----	74.8–75.2	1660–1710	10.6–12.7
6.26775–6.26825-----	108–121.94	1718.8–1722.2	13.25–13.4
6.31175–6.31225-----	123–138	2200–2300	14.47–14.5
8.291–8.294-----	149.9–150.05	2310–2390	15.35–16.2
8.362–8.366-----	156.52475–156.52525	2483.5–2500	17.7–21.4
8.37625–8.38675-----	156.7–156.9	2655–2900	22.01–23.12
8.41425–8.41475-----	162.0125–167.17	3260–3267	23.6–24.0
12.29–12.293-----	167.72–173.2	3332–3339	31.2–31.8
12.51975–12.52025-----	240–285	3345.8–3358.36	43–36.5
12.57675–12.57725-----	322–335.4	3600–4400	( <sup>2</sup> )

**Table 13. Restricted Bands of Operation**

<sup>1</sup> Until February 1, 1999, this restricted band shall be 0.490 – 0.510 MHz.

<sup>2</sup> Above 38.6

**Test Requirement(s):** § 15.209 (a): Except as provided elsewhere in this subpart, the emissions from an intentional radiator shall not exceed the field strength levels specified in Table 14.

Frequency (MHz)	§ 15.209(a), Radiated Emission Limits (dBµV) @ 3m
30 - 88	40.00
88 - 216	43.50
216 - 960	46.00
Above 960	54.00

**Table 14. Radiated Emissions Limits Calculated from FCC Part 15, § 15.209 (a)**

**Test Procedures:** The transmitter was turned on. Measurements were performed of the low, mid and high Channels. The EUT was rotated orthogonally through all three axes. Plots shown are corrected for both antenna correction factor and distance and compared to a 3 m limit line. Only noise floor was measured above 18 GHz.

**Test Results:** The EUT was compliant with the Radiated Spurious Emission limits of § 15.247(d). Measured emissions were within applicable limits. Testing DUT on power level 5 (of 7).

**Test Engineer(s):** James Borrott

**Test Date(s):** November 30, 2017

## Radiated Spurious Emissions Test Results

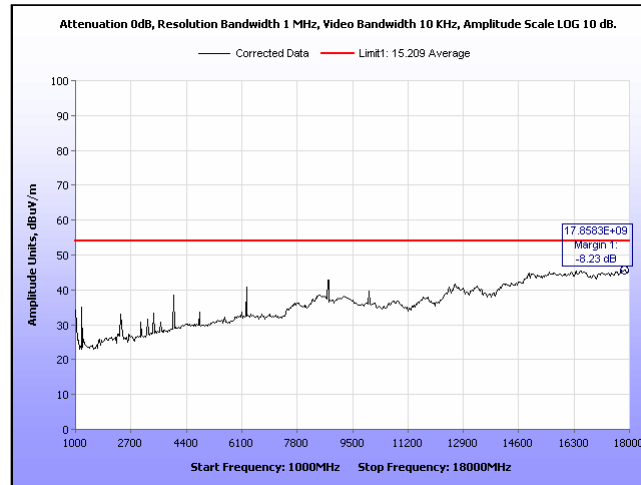

**Plot 7. Radiated Spurious Emissions, 2402 MHz, 15.209 Average**

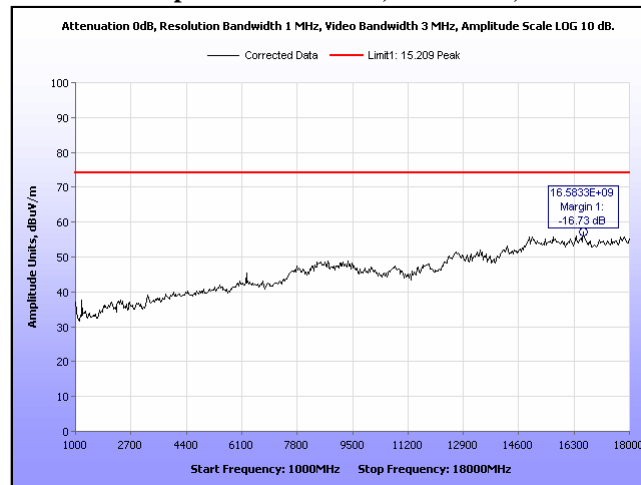

**Plot 8. Radiated Spurious Emissions, 2402 MHz, 15.209 Peak**

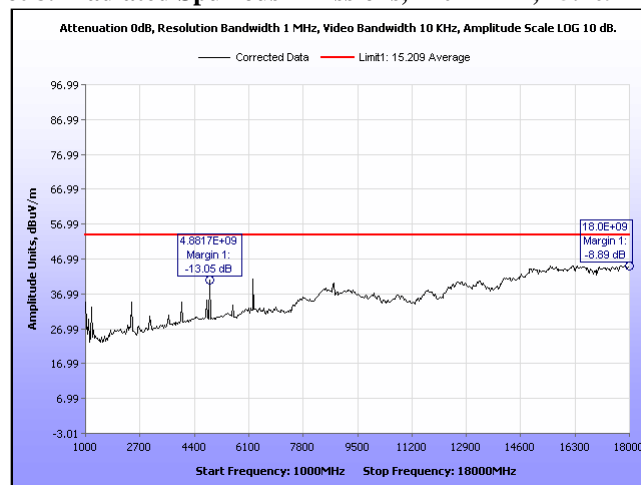

**Plot 9. Radiated Spurious Emissions, 2440 MHz, 15.209 Average**

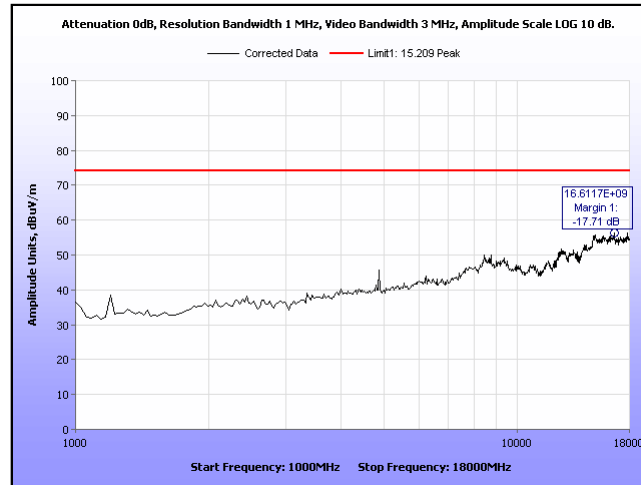

**Plot 10. Radiated Spurious Emissions, 2440 MHz, 15.209 Peak**

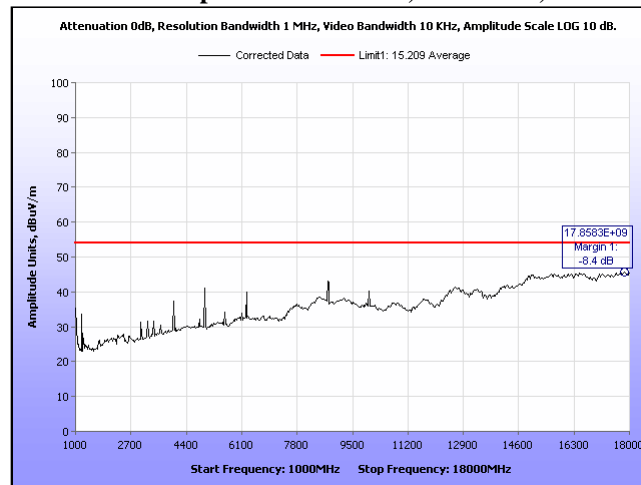

**Plot 11. Radiated Spurious Emissions, 2479 MHz, 15.209 Average**

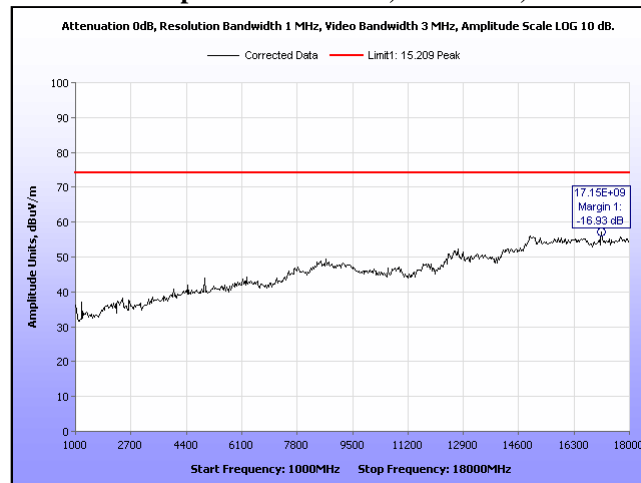

**Plot 12. Radiated Spurious Emissions, 2479 MHz, 15.209 Peak**

## Radiated Band Edge Measurements

**Test Procedures:** The transmitter was turned on. Measurements were performed of the low, mid and high Channels. The EUT was rotated orthogonally through all three axes. Plots shown are corrected for both antenna correction factor and distance and compared to a 3 m limit line.

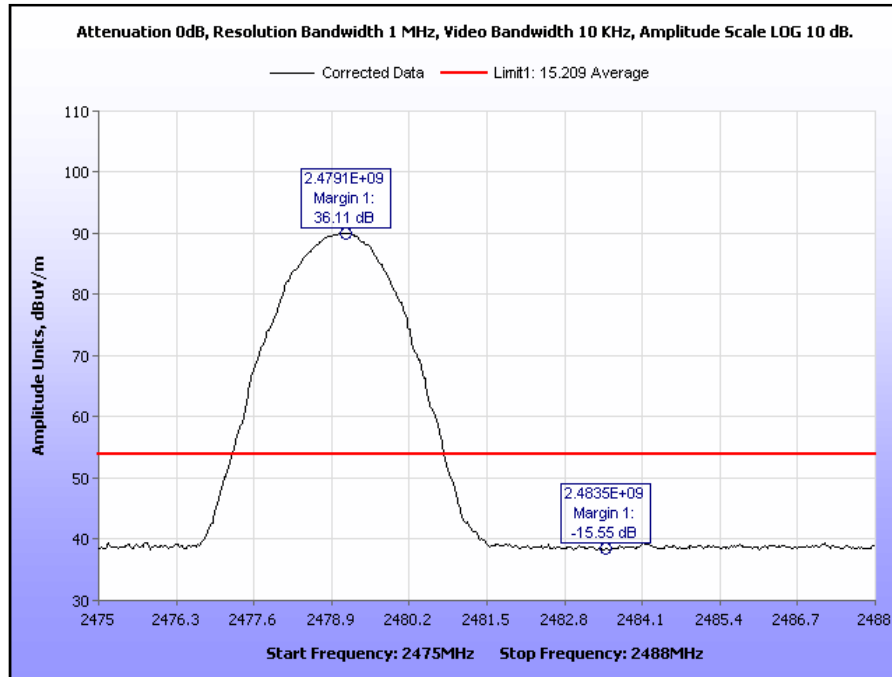

**Plot 13. Radiated Restricted Band Edge, 2479 MHz, Average**

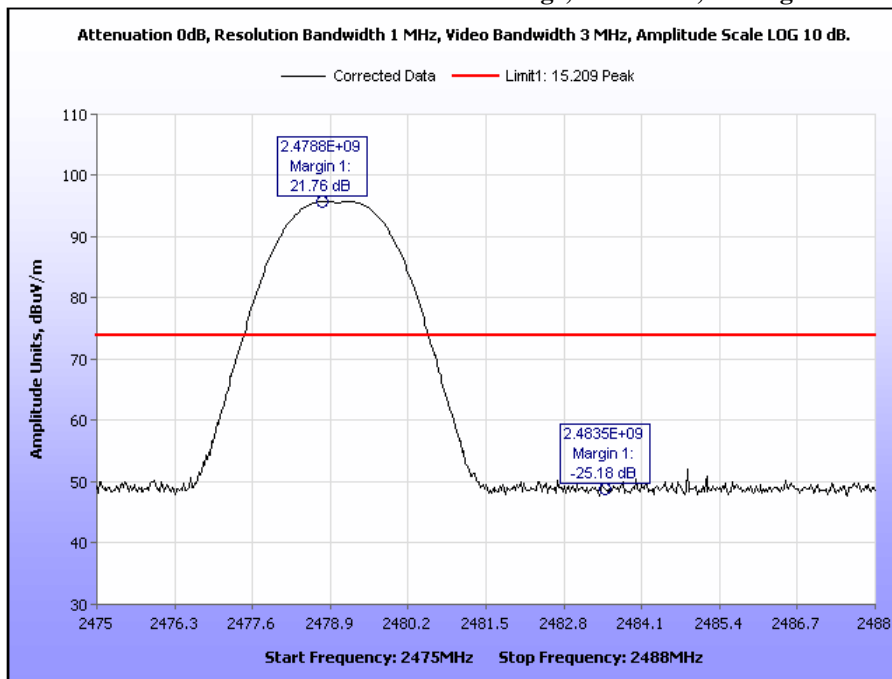

**Plot 14. Radiated Restricted Band Edge, 2479 MHz, Peak**

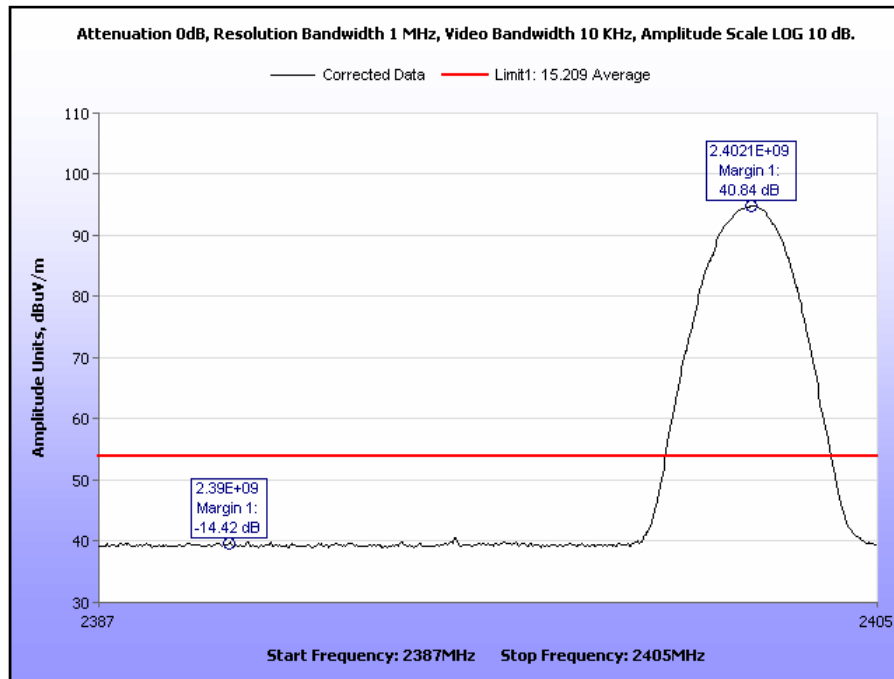

**Plot 15. Radiated Restricted Band Edge, 2402 MHz, Average**

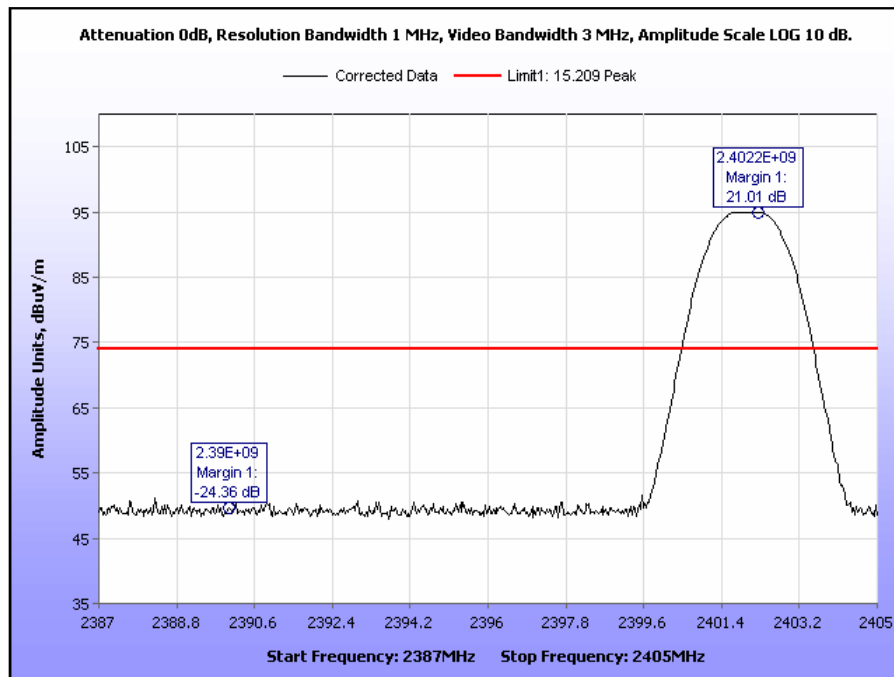

**Plot 16. Radiated Restricted Band Edge, 2402 MHz, Peak**



### Radiated Spurious Emissions Test Setup

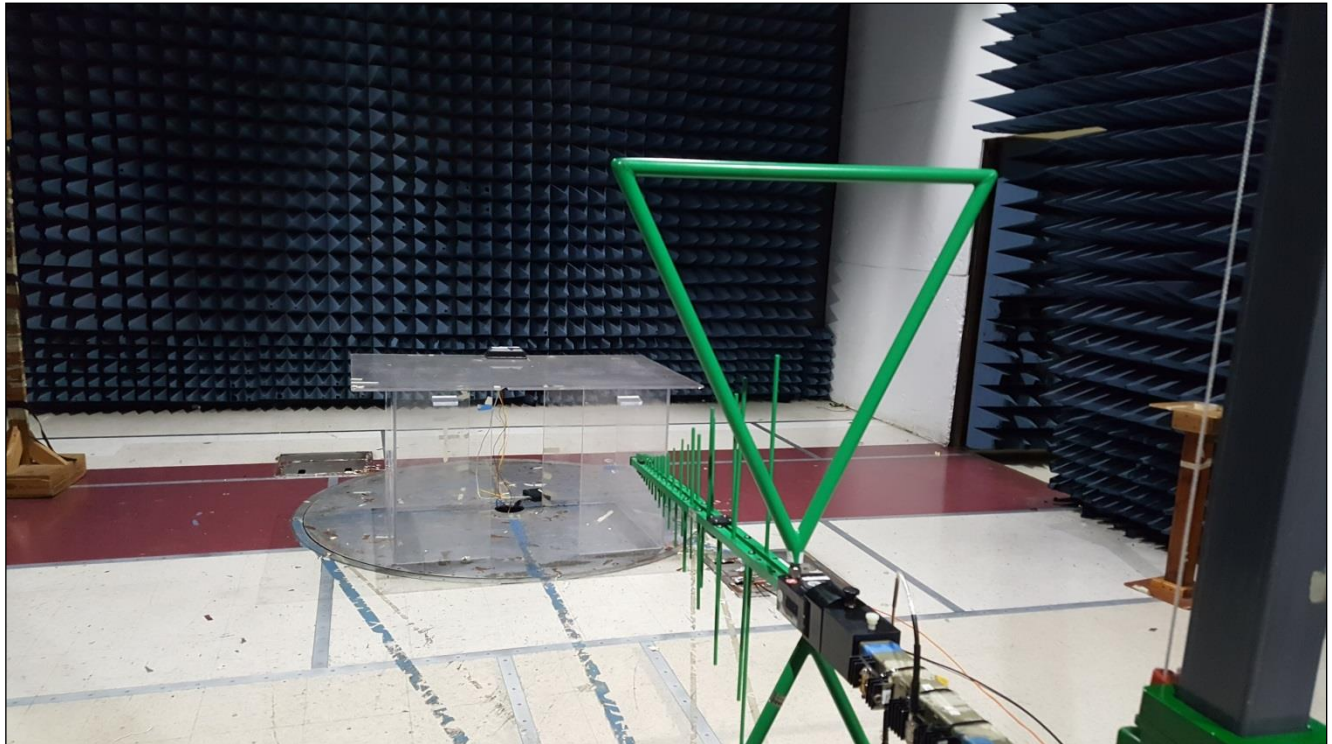

**Photograph 1. Radiated Spurious Emissions, 30 MHz – 1 GHz, Test Setup**

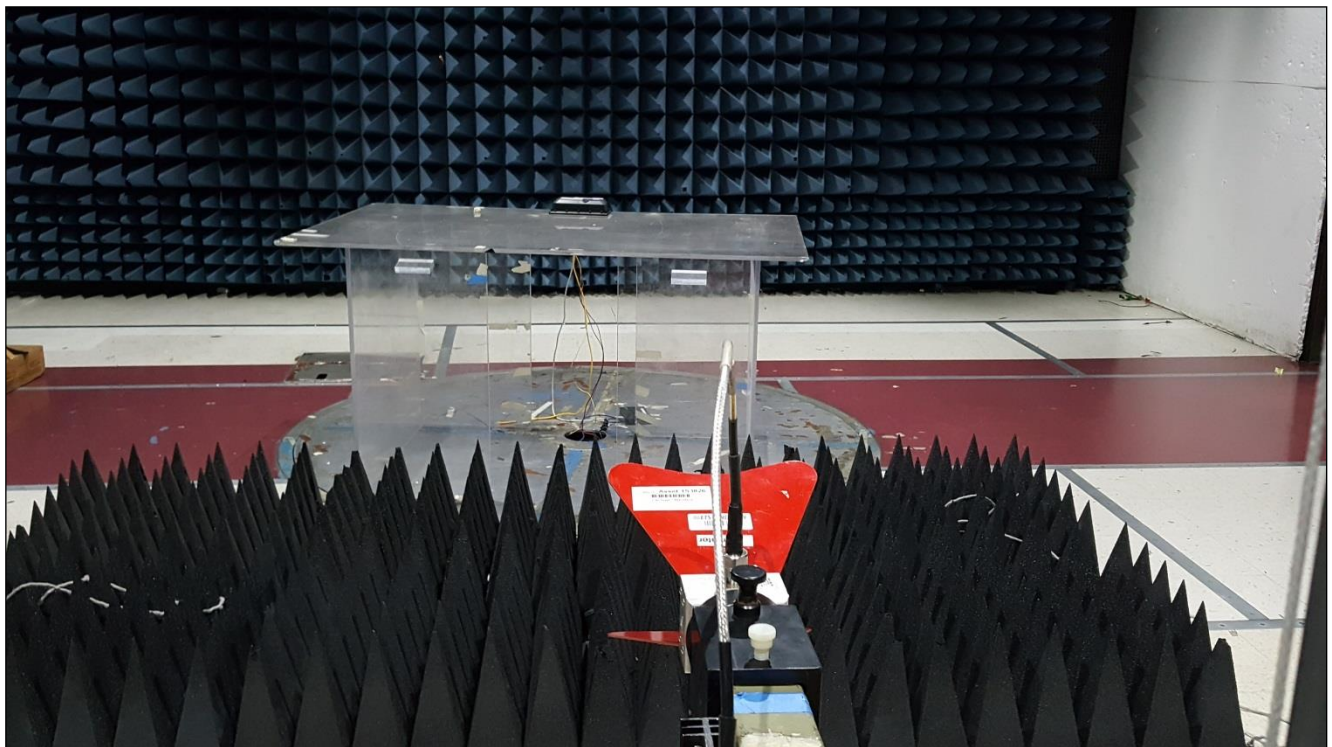

**Photograph 2. Radiated Spurious Emissions, 1 – 18 GHz, Test Setup**



## Electromagnetic Compatibility Criteria for Intentional Radiators

### § 15.247(d) RF Conducted Spurious Emissions Requirements and Band Edge

**Test Requirement:** **15.247(d)** In any 100 kHz bandwidth outside the frequency band in which the spread spectrum or digitally modulated intentional radiator is operating, the radio frequency power that is produced by the intentional radiator shall be at least 20 dB below that in the 100 kHz bandwidth within the band that contains the highest level of the desired power, based on either an RF conducted or a radiated measurement, provided the transmitter demonstrates compliance with the peak conducted power limits. If the transmitter complies with the conducted power limits based on the use of RMS averaging over a time interval, as permitted under paragraph (b)(3) of this section, the attenuation required under this paragraph shall be 30 dB instead of 20 dB.

**Test Procedure:** For intentional radiators with a digital device portion which operates below 10 GHz, the spectrum was investigated as per §15.33(a)(1) and §15.33(a)(4); i.e., the lowest RF signal generated or used in the device up to the 10<sup>th</sup> harmonic of the highest fundamental frequency or to 40 GHz, whichever is lower.

Since the EUT had an integral antenna, conducted measurements could not be performed. Measurements needed to be taken radiated. An antenna was located 3 m away from the EUT and plots were taken. The EUT was rotated through all three orthogonal axes. The plots were corrected for both antenna correction factor and cable loss.

See following pages for detailed test results with RF Conducted Spurious Emissions.

**Test Results:** The EUT was compliant with the Conducted Spurious Emission limits of §15.247(d). Measured emissions were within applicable limits.

**Test Engineer(s):** James Borrott

**Test Date(s):** November 30, 2017

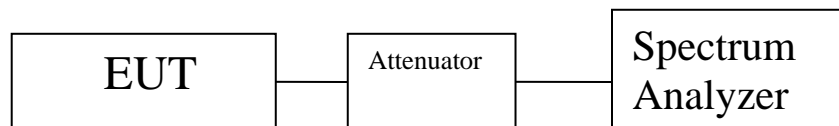
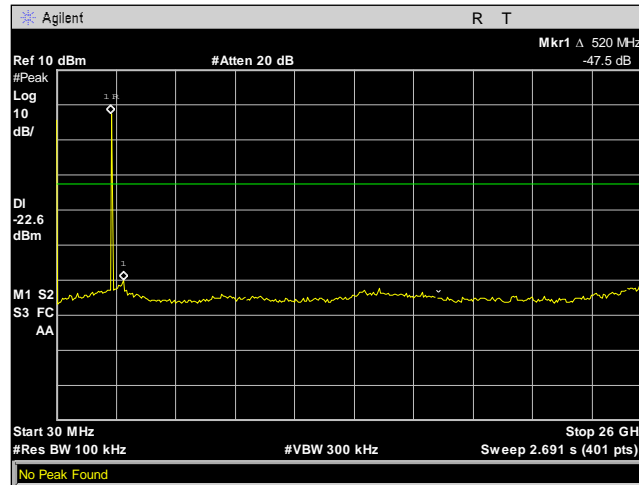
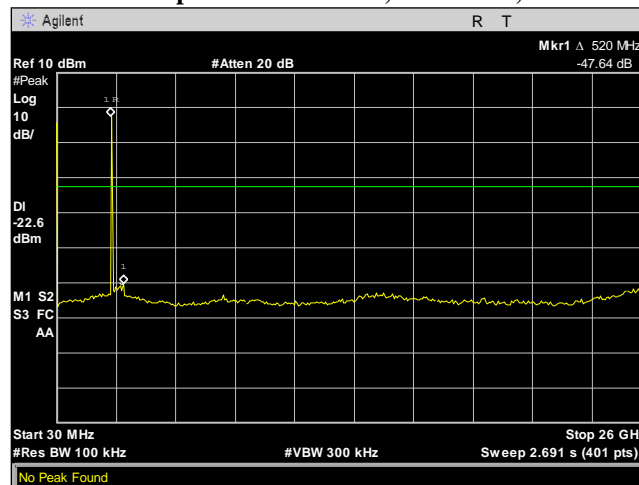

Figure 4. Block Diagram, Conducted Spurious Emissions Test Setup

## Conducted Spurious Emissions Test Results



Plot 17. Conducted Spurious Emissions, 2402 MHz, 30 MHz – 26 GHz



Plot 18. Conducted Spurious Emissions, 2440 MHz, 30 MHz – 26 GHz

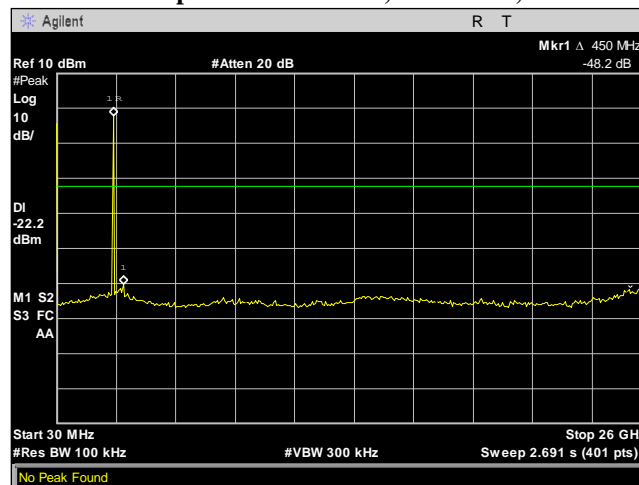

Plot 19. Conducted Spurious Emissions, 2479 MHz, 30 MHz – 26 GHz

## Conducted Band Edge Test Results

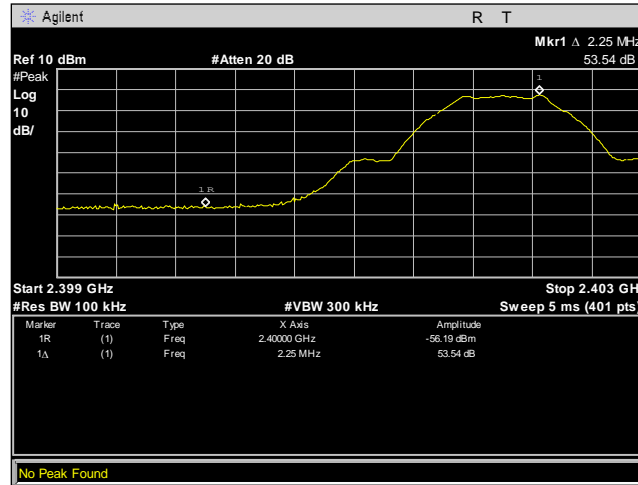

Plot 20. Conducted Band Edge, 2402 MHz

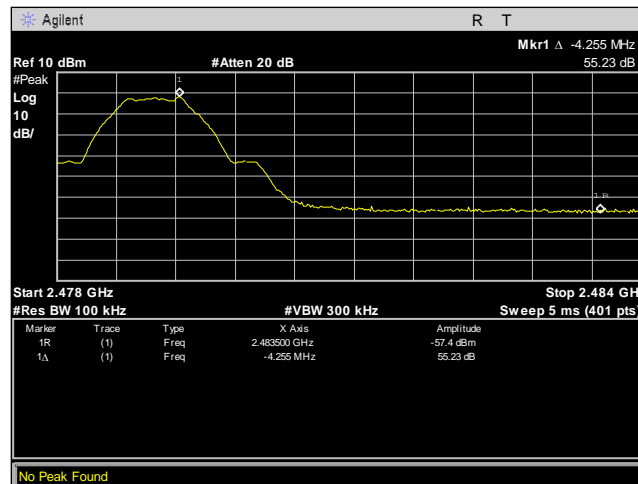

Plot 21. Conducted Band Edge, 2479 MHz

## Electromagnetic Compatibility Criteria for Intentional Radiators

### § 15.247(e) Peak Power Spectral Density

**Test Requirements:** §15.247(e): For digitally modulated systems, the peak power spectral density conducted from the intentional radiator to the antenna shall not be greater than 8dBm in any 3 kHz band during any time interval of continuous transmission.

**Test Procedure:** The transmitter was connected directly to a Spectrum Analyzer through an attenuator. The power level was set to the maximum level throughout each of the 100 sweeps of power averaging. The RBW was set to 3 kHz and a VBW set to 9 kHz or greater. The spectrum analyzer was set to an auto sweep time and a peak detector was used. Measurements were carried out at the low, mid and high channels.

**Test Results:** The EUT was compliant with the peak power spectral density limits of § 15.247 (e). No anomalies detected.

The peak power spectral density was determined from plots on the following page(s).

**Test Engineer:** James Borrott

**Test Date:** November 30, 2017

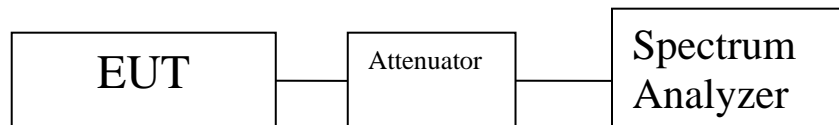

**Figure 5. Block Diagram, Peak Power Spectral Density Test Setup**

## Peak Power Spectral Density Test Results

Peak Power Spectral Density				
Carrier Channel	Frequency (MHz)	Measured PPSD (dBm)	Limit (dBm)	Margin (dB)
Low	2402	-1.853	8	9.853
Mid	2440	-1.606	8	9.606
High	2479	-1.43	8	9.43

**Table 15. Peak Power Spectral Density, Test Results**

## Peak Power Spectral Density

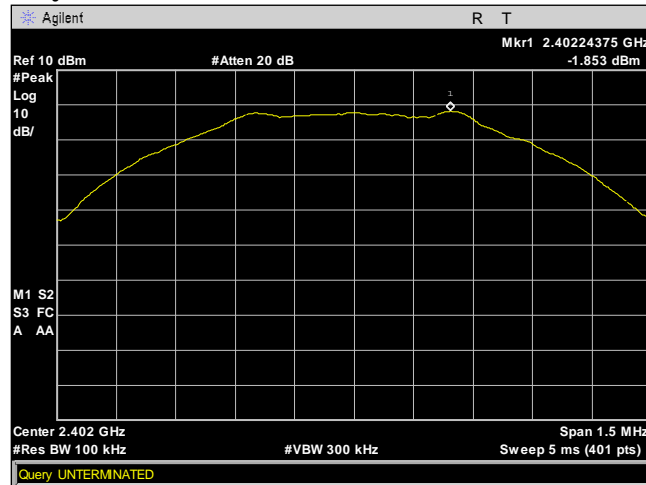

Plot 22. Peak Power Spectral Density, 2402 MHz

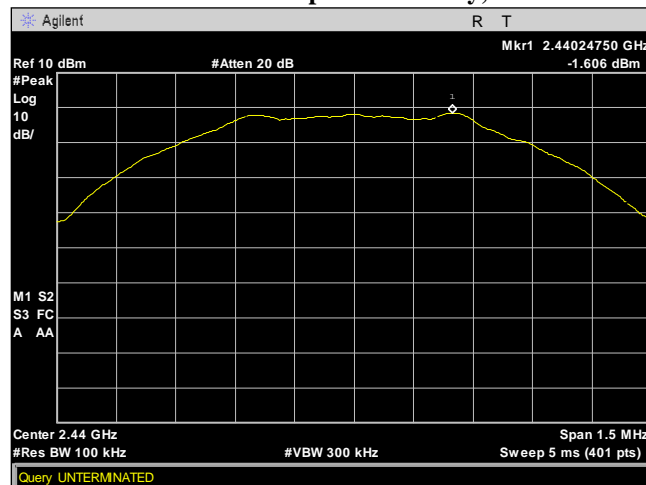

Plot 23. Peak Power Spectral Density, 2440 MHz

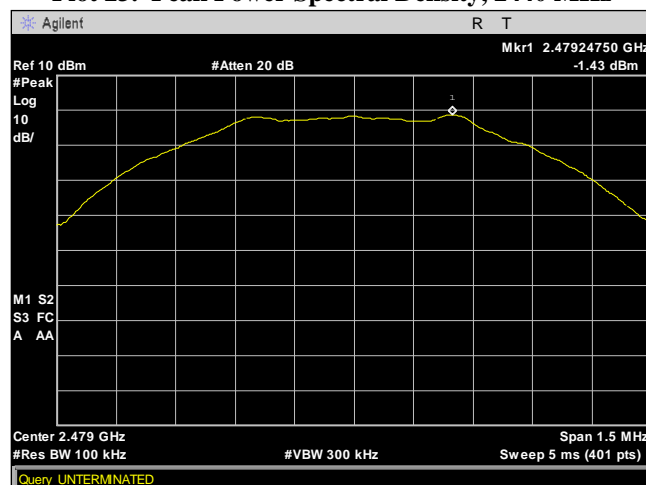

Plot 24. Peak Power Spectral Density, 2479 MHz

## Electromagnetic Compatibility Criteria for Intentional Radiators

### § 15.247(i) Maximum Permissible Exposure

**RF Exposure Requirements:** §1.1307(b)(1) and §1.1307(b)(2): Systems operating under the provisions of this section shall be operated in a manner that ensures that the public is not exposed to radio frequency energy levels in excess of the Commission’s guidelines.

**RF Radiation Exposure Limit:** §1.1310: As specified in this section, the Maximum Permissible Exposure (MPE) Limit shall be used to evaluate the environmental impact of human exposure to radiofrequency (RF) radiation as specified in Sec. 1.1307(b), except in the case of portable devices which shall be evaluated according to the provisions of Sec. 2.1093 of this chapter.

MPE Limit: EUT’s operating frequencies @ 2400-2483.5 MHz; **Limit for Uncontrolled exposure: 1 mW/cm<sup>2</sup> or 10 W/m<sup>2</sup>**

Equation from page 18 of OET 65, Edition 97-01

$$S = PG / 4\pi R^2 \quad \text{or} \quad R = \sqrt{PG / 4\pi S}$$

where, S = Power Density (mW/cm<sup>2</sup>)  
P = Power Input to antenna (mW)  
G = Antenna Gain (numeric value)  
R = Distance (cm)

#### Test Results:

FCC									
Frequency (MHz)	Con. Pwr. (dBm)	Con. Pwr. (mW)	Ant. Gain (dBi)	Ant. Gain numeric	Pwr. Density (mW/cm <sup>2</sup> )	Limit (mW/cm <sup>2</sup> )	Margin	Distance (cm)	Result
2479	-0.823	0.827	3	1.995	0.00033	1	0.99967	20	Pass

The safe distance where Power Density is less than the MPE Limit listed above was found to be 20 cm.

## **IV. Test Equipment**



## Test Equipment

Calibrated test equipment utilized during testing was maintained in a current state of calibration per the requirements of ISO/IEC 17025:2005.

MET Asset #	Equipment	Manufacturer	Model	Last Cal Date	Cal Due Date
1S2399	Turntable Controller	SUNOL SCIENCE	SC99V	See Note	
1S2600	Bilog Antenna	Teseq	CBL6112D	11/28/2016	11/28/2018
1S3835	PSA Spectrum Analyzer	Agilent Technologies	E4448A	04/19/2017	04/19/2018
1S2482A	5 Meter Chamber (FCC)	Panashield	5 Meter Semi-Anechoic Chamber	See Note	
1S2603	Double Ridged Waveguide Horn	ETS-Lindgren	3117	08/09/2016	08/09/2018
1U0258	Spectrum Analyzer	Agilent Technologies	E4407B	02/03/2017	02/03/2018
1S2121	Pre-Amplifier	Hewlett Packard	8449B	See Note	

**Table 16. Test Equipment List**

Note: Functionally tested equipment is verified using calibrated instrumentation at the time of testing.

## **V. Certification & User's Manual Information**

## Certification & User's Manual Information

### A. Certification Information

The following is extracted from Title 47 of the Code of Federal Regulations, Part 2, Subpart I — Marketing of Radio frequency devices:

#### § 2.801 Radio-frequency device defined.

As used in this part, a radio-frequency device is any device which in its operation is capable of Emitting radio-frequency energy by radiation, conduction, or other means. Radio- frequency devices include, but are not limited to:

- (a) The various types of radio communication transmitting devices described throughout this chapter.
- (b) *The incidental, unintentional and intentional radiators defined in Part 15 of this chapter.*
- (c) The industrial, scientific, and medical equipment described in Part 18 of this chapter.
- (d) Any part or component thereof which in use emits radio-frequency energy by radiation, conduction, or other means.

#### § 2.803 Marketing of radio frequency devices prior to equipment authorization.

- (a) Except as provided elsewhere in this chapter, no person shall sell or lease, or offer for sale or lease (including advertising for sale or lease), or import, ship or distribute for the purpose of selling or leasing or offering for sale or lease, any radio frequency device unless:
  - (1) In the case of a device subject to certification, such device has been authorized by the Commission in accordance with the rules in this chapter and is properly identified and labeled as required by §2.925 and other relevant sections in this chapter; or
  - (2) In the case of a device that is not required to have a grant of equipment authorization issued by the Commission, but which must comply with the specified technical standards prior to use, such device also complies with all applicable administrative (including verification of the equipment or authorization under a Declaration of Conformity, where required), technical, labeling and identification requirements specified in this chapter.
- (d) Notwithstanding the provisions of paragraph (a) of this section, the offer for sale solely to business, commercial, industrial, scientific or medical users (but not an offer for sale to other parties or to end users located in a residential environment) of a radio frequency device that is in the conceptual, developmental, design or pre-production stage is permitted prior to equipment authorization or, for devices not subject to the equipment authorization requirements, prior to a determination of compliance with the applicable technical requirements *provided* that the prospective buyer is advised in writing at the time of the offer for sale that the equipment is subject to the FCC rules and that the equipment will comply with the appropriate rules before delivery to the buyer or to centers of distribution.

- (e)(1) Notwithstanding the provisions of paragraph (a) of this section, prior to equipment authorization or determination of compliance with the applicable technical requirements any radio frequency device may be operated, but not marketed, for the following purposes and under the following conditions:
- (i) *Compliance testing*;
  - (ii) Demonstrations at a trade show provided the notice contained in paragraph (c) of this section is displayed in a conspicuous location on, or immediately adjacent to, the device;
  - (iii) Demonstrations at an exhibition conducted at a business, commercial, industrial, scientific or medical location, but excluding locations in a residential environment, provided the notice contained in paragraphs (c) or (d) of this section, as appropriate, is displayed in a conspicuous location on, or immediately adjacent to, the device;
  - (iv) Evaluation of product performance and determination of customer acceptability, provided such operation takes place at the manufacturer's facilities during developmental, design or pre-production states; or
  - (v) Evaluation of product performance and determination of customer acceptability where customer acceptability of a radio frequency device cannot be determined at the manufacturer's facilities because of size or unique capability of the device, provided the device is operated at a business, commercial, industrial, scientific or medical user's site, but not at a residential site, during the development, design or pre-production stages.
- (e)(2) For the purpose of paragraphs (e)(1)(iv) and (e)(1)(v) of this section, the term *manufacturer's facilities* includes the facilities of the party responsible for compliance with the regulations and the manufacturer's premises, as well as the facilities of other entities working under the authorization of the responsible party in connection with the development and manufacture, but not the marketing, of the equipment.
- (f) For radio frequency devices subject to verification and sold solely to business, commercial, industrial, scientific and medical users (excluding products sold to other parties or for operation in a residential environment), parties responsible for verification of the devices shall have the option of ensuring compliance with the applicable technical specifications of this chapter at each end user's location after installation, provided that the purchase or lease agreement includes a proviso that such a determination of compliance be made and is the responsibility of the party responsible for verification of the equipment.

## Certification & User's Manual Information

The following is extracted from Title 47 of the Code of Federal Regulations, Part 2, Subpart J — Equipment Authorization Procedures:

### § 2.901 Basis and Purpose

- (a) In order to carry out its responsibilities under the Communications Act and the various treaties and international regulations, and in order to promote efficient use of the radio spectrum, the Commission has developed technical standards for radio frequency equipment and parts or components thereof. The technical standards applicable to individual types of equipment are found in that part of the rules governing the service wherein the equipment is to be operated.<sup>1</sup> *In addition to the technical standards provided, the rules governing the service may require that such equipment be verified by the manufacturer or importer, be authorized under a Declaration of Conformity, or receive an equipment authorization from the Commission by one of the following procedures: certification or registration.*
- (b) The following sections describe the verification procedure, the procedure for a Declaration of Conformity, and the procedures to be followed in obtaining certification from the Commission and the conditions attendant to such a grant.

### § 2.907 Certification.

- (a) Certification is an equipment authorization issued by the Commission, based on representation and test data submitted by the applicant.
- (b) Certification attaches to all units subsequently marketed by the grantee which are identical (see Section 2.908) to the sample tested except for permissive changes or other variations authorized by the Commission pursuant to Section 2.1043.

---

<sup>1</sup> In this case, the equipment is subject to the rules of Part 15. More specifically, the equipment falls under Subpart B (of Part 15), which deals with unintentional radiators.

## Certification & User's Manual Information

### § 2.948 Description of measurement facilities.

- (a) Each party making measurements of equipment that is subject to an equipment authorization under Part 15 or Part 18 of this chapter, regardless of whether the measurements are filed with the Commission or kept on file by the party responsible for compliance of equipment marketed within the U.S. or its possessions, shall compile a description of the measurement facilities employed.
- (1) If the measured equipment is subject to the verification procedure, the description of the measurement facilities shall be retained by the party responsible for verification of the equipment.
- (i) *If the equipment is verified through measurements performed by an independent laboratory, it is acceptable for the party responsible for verification of the equipment to rely upon the description of the measurement facilities retained by or placed on file with the Commission by that laboratory. In this situation, the party responsible for the verification of the equipment is not required to retain a duplicate copy of the description of the measurement facilities.*
- (ii) If the equipment is verified based on measurements performed at the installation site of the equipment, no specific site calibration data is required. It is acceptable to retain the description of the measurement facilities at the site at which the measurements were performed.
- (2) If the equipment is to be authorized by the Commission under the certification procedure, the description of the measurement facilities shall be filed with the Commission's Laboratory in Columbia, Maryland. The data describing the measurement facilities need only be filed once but must be updated as changes are made to the measurement facilities or as otherwise described in this section. At least every three years, the organization responsible for filing the data with the Commission shall certify that the data on file is current.

## Certification & User's Manual Information

### 1. Label and User's Manual Information

The following is extracted from Title 47 of the Code of Federal Regulations, Part 15, Subpart A — General:

#### § 15.19 Labeling requirements.

(a) *In addition to the requirements in Part 2 of this chapter, a device subject to certification or verification shall be labeled as follows:*

- (1) Receivers associated with the operation of a licensed radio service, e.g., FM broadcast under Part 73 of this chapter, land mobile operation under Part 90, etc., shall bear the following statement in a conspicuous location on the device:

This device complies with Part 15 of the FCC Rules. Operation is subject to the condition that this device does not cause harmful interference.

- (2) A stand-alone cable input selector switch, shall bear the following statement in a conspicuous location on the device:

This device is verified to comply with Part 15 of the FCC Rules for use with cable television service.

- (3) All other devices shall bear the following statement in a conspicuous location on the device:

*This device complies with Part 15 of the FCC Rules. Operation is subject to the following two conditions: (1) This device may not cause harmful interference, and (2) this device must accept any interference received, including interference that may cause undesired operation.*

- (4) Where a device is constructed in two or more sections connected by wires and marketed together, the statement specified under paragraph (a) of this section is required to be affixed only to the main control unit.

- (5) When the device is so small or for such use that it is not practicable to place the statement specified under paragraph (a) of this section on it, the information required by this paragraph shall be placed in a prominent location in the instruction manual or pamphlet supplied to the user or, alternatively, shall be placed on the container in which the device is marketed. However, the FCC identifier or the unique identifier, as appropriate, must be displayed on the device.

#### § 15.21 Information to user.

The user's manual or instruction manual for an intentional or unintentional radiator shall caution the user that changes or modifications not expressly approved by the party responsible for compliance could void the user's authority to operate the equipment.

## Verification & User's Manual Information

The following is extracted from Title 47 of the Code of Federal Regulations, Part 15, Subpart B — Unintentional Radiators:

### § 15.105 Information to the user.

- (a) For a Class A digital device or peripheral, the instructions furnished the user shall include the following or similar statement, placed in a prominent location in the text of the manual:

Note: This equipment has been tested and found to comply with the limits for a Class A digital device, pursuant to Part 15 of the FCC Rules. These limits are designed to provide reasonable protection against harmful interference when the equipment is operated in a commercial environment. This equipment generates, uses, and can radiate radio frequency energy and, if not installed and used in accordance with the instruction manual, may cause harmful interference to radio communications. Operation of this equipment in a residential area is likely to cause harmful interference in which case the user will be required to correct the interference at own expense.

- (b) For a Class B digital device or peripheral, the instructions furnished the user shall include the following or similar statement, placed in a prominent location in the text of the manual:

Note: This equipment has been tested and found to comply with the limits for a Class B digital device, pursuant to Part 15 of the FCC Rules. These limits are designed to provide reasonable protection against harmful interference when the equipment is operated in a residential environment. This equipment generates, uses, and can radiate radio frequency energy and, if not installed and used in accordance with the instruction manual, may cause harmful interference to radio communications. However, there is no guarantee that interference will not occur in a particular installation. If this equipment does cause harmful interference to radio or television reception, which can be determined by turning the equipment off and on, the user is encouraged to try to correct the interference by one or more of the following measures:

- Reorient or relocate the receiving antenna.
- Increase the separation between the equipment and receiver.
- Connect the equipment into an outlet on a circuit different from that to which the receiver is connected.
- Consult the dealer or an experienced radio/TV technician for help.



# End of Report