



Accredited testing-laboratory

DAR registration number: DAT-P-176/94-D1

**Federal Motor Transport Authority (KBA)
DAR registration number: KBA-P 00070-97**

Recognized by the Federal Communications Commission

Anechoic chamber registration no.: 90462 (FCC)

Anechoic chamber registration no.: 3462C-1 (IC)

Certification ID: DE 0001

Accreditation ID: DE 0002

Accredited Bluetooth® Test Facility (BQTF)

The Bluetooth word mark and logos are owned by the Bluetooth SIG, Inc. and any use of such marks by Cetecom ICT is under license

Test report no. : 1-0685-01-15/08-B
**Type identification : MMS+WLAN a/b/g Modul für Monitore
M8100-66490 antenna**
Applicant : Philips Medizin Systeme Böblingen GmbH
FCC ID : PQC-WLANBV1
IC Certification No : 3549C-WLANBV1
**Test standards : 47 CFR Part 15
RSS - 210 Issue 7**

Table of contents

1	General information	3
1.1	Notes	3
1.2	Testing laboratory	4
1.3	Details of applicant	4
1.4	Application details	4
2	Test standard/s:	5
3	Technical tests	6
3.1	Details of manufacturer	6
3.1.1	Test item	6
3.1.2	Additional EUT information For IC Canada (appendix 2)	7
3.1.3	RF Technical Brief Cover Sheet acc. To RSS-102	8
3.1.4	EUT operating modes	9
3.1.5	Extreme conditions testing values	9
4	Summary of Measurement Results and list of all performed test cases	10
5	RF measurement testing	11
5.1	Description of test set-up	11
5.1.1	Radiated measurements	11
5.1.2	Conducted measurements	12
5.2	Referenced Documents	13
5.3	Additional comments	13
5.4	Manufacturer's declaration	16
5.5	Antenna gain	16
5.6	Peak Power Spectral density (digitally modulated systems) §15.247(e)	17
5.7	Spectrum Bandwidth of a DSSS System / 6 dB Bandwidth §15.247(a)(2)	18
5.8	Spectrum Bandwidth of a DSSS System / 20 dB Bandwidth	19
5.9	Maximum output power (conducted) §15.247 (b)(3)	20
5.10	Max. peak output power (radiated) §15.247 (b)(3)	23
5.11	Band-edge compliance of conducted emissions §15.247 (d)	24
5.12	Band-edge compliance of radiated emissions §15.205	25
5.13	Spurious Emissions - conducted (Transmitter) §15.247 (c)	30
5.14	Spurious Emissions - radiated (Transmitter) §15.209	32
5.15	Spurious Emissions - radiated (Receiver) §15.109 / 209	50
5.16	Spurious Emissions - radiated <30 MHz §15.209	54
5.17	Conducted Emissions <30 MHz §15.107/207	56
6	Test equipment and ancillaries used for tests	57
7	Photographs of the Test Set-up	60
8	Photographs of the EUT	61

1 General information

1.1 Notes

The test results of this test report relate exclusively to the test item specified in 3.1.1. The CETECOM ICT Services GmbH does not assume responsibility for any conclusions and generalisations drawn from the test results with regard to other specimens or samples of the type of the equipment represented by the test item. The test report may only be reproduced or published in full. Reproduction or publication of extracts from the report requires the prior written approval of the CETECOM ICT Services GmbH.

Test laboratory manager:

2009-02-18

Stefan Bös

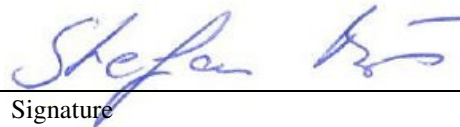

Date

Name

Signature

2009-02-18

Marco Bertolino



Date

Name

Signature

Technical responsibility for area of testing:

2009-02-18

Michael Berg

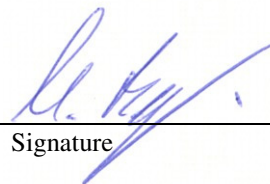

Date

Name

Signature

1.2 Testing laboratory

CETECOM ICT Services GmbH

Untertürkheimer Straße 6 - 10

66117 Saarbrücken

Germany

Phone: + 49 681 5 98 - 0

Fax: + 49 681 5 98 - 9075

e-mail: info@ICT.cetecom.de

Internet: <http://www.cetecom-ict.de>

State of accreditation: The test laboratory (area of testing) is accredited according to
DIN EN ISO/IEC 17025
DAR registration number: DAT-P-176/94-D1

Accredited by: Federal Motor Transport Authority (KBA)
DAR registration number: KBA-P 00070-97

Testing location, if different from CETECOM ICT Services GmbH:

Name :
Street :
Town :
Country :
Phone :
Fax :

1.3 Details of applicant

Name:	Philips Medizin Systeme Böblingen GmbH
Street:	Hewlett-Packard-Strasse 2
Town:	71034 Böblingen
Country:	Germany
Telephone:	
Fax:	+49-7031-463 2944
Contact:	Herrn Stefan Breuer
E-mail:	stefan.breuer@philips.com
Telephone:	+49-7031-463 2321

1.4 Application details

Date of receipt of order:	2008-10-25
Date of receipt of test item:	2008-10-01
Date of start test:	2008-10-01
Date of end test:	2008-11-03
Persons(s) who have been present during the test:	-/-

2 Test standard/s:

47 CFR Part 15	2007-09	Title 47 of the Code of Federal Regulations; Chapter I- Federal Communications Commission subchapter A - general, Part 15-Radio frequency devices
RSS - 210 Issue 7	2007-06	Spectrum Management and Telecommunications - Radio Standards Specification Low-power Licence-exempt Radiocommunication Devices (All Frequency Bands): Category I Equipment

3 Technical tests

3.1 Details of manufacturer

Name:	Philips Medizin Systeme Böblingen GmbH
Street:	Hewlett-Packard-Strasse 2
Town:	71034 Böblingen
Country:	Germany

3.1.1 Test item

Kind of test item	:	Module for healthcare monitoring systems
Type identification	:	MMS+WLAN a/b/g Modul für Monitore M8100-66490 antenna
S/N serial number	:	FH 830 000187
HW hardware status	:	0839
SW software status	:	-/-
Frequency Band [MHz]	:	ISM 2.400 - 2.483,5 MHz
Type of Modulation	:	DSSS & OFDM
Number of channels	:	11
Antenna	:	PCB antenna 1 M8100-66490
Power Supply	:	5 V / 500 mA DC by power supply
Temperature Range	:	-20 C° - +55 C°

DSSS mode: Max. power radiated: 19.92 dBm

OFDM mode: Max. power radiated: 23.92 dBm

Max. power conducted: 19.28 dBm DSSS / WLAN b mode

Max. power conducted: 22.75 dBm OFDM / WLAN g mode

FCC ID: PQC-WLANBV1

IC: 3549C-WLANBV1

3.1.2 Additional EUT information For IC Canada (appendix 2)

IC Registration Number:	3549C-WLANBV1
Model Name:	MMS+WLAN a/b/g Modul für Monitore
Manufacturer (complete Address):	Philips Medizin Systeme Böblingen GmbH Hewlett-Packard-Strasse 2 71034 Böblingen Germany
Tested to Radio Standards Specification (RSS) No.:	RSS-210 Issue 7
Open Area Test Site Industry Canada Number:	IC 3462C-1
Frequency Range (or fixed frequency) [MHz]:	ISM Band 2400 – 2483.5 MHz
RF: Power [W] (max):	DSSS: Rad. EIRP: 98.17 mW Conducted : 84.72 mW OFDM: Rad. EIRP: 213.3 mW Conducted : 188.36 mW
Antenna Type:	PCP antenna 1 M8100-66490
Occupied Bandwidth (99% BW) [kHz]:	DSSS: Not performed! OFDM: Not performed!
Type of Modulation:	DSSS & OFDM
Emission Designator (TRC-43):	DSSS: Not performed! OFDM: Not performed!
Transmitter Spurious (worst case) [dBµV/m in 3m]:	35.05
Receiver Spurious (worst case) [dBµV/m in 3m]:	34.47

ATTESTATION:

I attest that the testing was performed or supervised by me; that the test measurements were made in accordance with the above-mentioned departmental standard(s), and that the radio equipment identified in this application has been subject to all applicable test conditions specified in the departmental standards and all of the requirements of the standards have been met.

Signature:



Test engineer: Stefan Bös

Date: 2009-02-18

Signature:



Test engineer: Marco Bertolino

Date: 2009-02-18

3.1.3 RF Technical Brief Cover Sheet acc. To RSS-102

All Fields must be completed with the requested information or the following codes: N/A for Not Applicable, N/P for Not Performed or N/V for Not Available. Where applicable, check appropriate box.

1. COMPANY NUMBER: **3549C**
2. MODEL NUMBER: **MMS+WLAN a/b/g Modul für Monitore**
3. MANUFACTURER: **Philips Medizin Systeme Böblingen GmbH**
4. TYPE OF EVALUATION: **(c) RF Evaluation**

(c) RF Evaluation

- Evaluated against exposure limits: General Public Use Controlled Use
- Duty cycle used in evaluation: 99 %
- Standard used for evaluation: RSS-102 Issue 2 (2005-11)
- Measurement distance: 0.20 m
- RF value: 0.425 V/m A/m W/m²

Measured Computed Calculated

Declaration of RF Exposure Compliance

ATTESTATION:

I attest that the information provided in this test report is correct; that a Technical Brief was prepared and the information it contains is correct; that the device evaluation was performed or supervised by me; that applicable measurement methods and evaluation methodologies have been followed and that the device meets the SAR and/or RF exposure limits of RSS-102.

Name: Dipl.-Ing. (FH) Stefan Bös
Title: Project engineer
Company: Cetecom ICT Services GmbH

Name: Dipl.-Ing. (FH) Marco Bertolino
Title: Engineer
Company: Cetecom ICT Services GmbH

3.1.4 EUT operating modes

EUT operating mode no. *)	Description of operating modes	Additional information
Op. 0	normal mode	normal temperature and power source conditions
Op. 1		low temperature, low power source conditions
Op. 2		low temperature, high power source conditions
Op. 3		high temperature, low power source conditions
Op. 4		high temperature, high power source conditions

*) EUT operating mode no. is used to simplify the test plan

3.1.5 Extreme conditions testing values

Description	Shortcut	Unit	Value
Nominal Temperature	T _{nom}	°C	20
Nominal Humidity	H _{nom}	%	52
Nominal Power Source	V _{nom}	V	5 V / 500mA

Type of power source: 5 V / 500 mA DC by power supply

Deviations from these values are reported in chapter 2

4 Summary of Measurement Results and list of all performed test cases

- No deviations from the technical specifications were ascertained
- There were deviations from the technical specifications ascertained

TC identifier	Description	verdict	date	Remark
RF-Testing	FCC Part 15 §15.247 - CANADA RSS-210	passed	2009-02-18	-/-

Test Specification Clause	Test Case	Pass	Fail	Not applicable	Not performed
None	Antenna Gain				Yes
§15.247 (e)	Peak power spectral density				Yes
§15.247(a)(2)	Spectrum Bandwidth of a DSSS System / 6dB BW				Yes
§15.247(a)(2)	Spectrum Bandwidth of a DSSS System / 20dB BW				Yes
§ 15.247 (b)(3)	Maximum output power (conducted)				Yes
§ 15.247 (b)(3)	Max. peak output power (radiated)	Yes			
§15.247 (d)	Band-edge compliance of conducted emissions				Yes
§15.205	Band-edge compliance of radiated emissions	Yes			
§15.247 (d)	Spurious Emission - conducted (Transmitter)				Yes
§ 15.209	Spurious Emission -radiated (Transmitter)	Yes			
§ 15.109	Spurious Emissions-radiated (Receiver)	Yes			
§ 15.209	Spurious Emissions-radiated <30 MHz	Yes			
§ 15.107/207	Conducted Emissions <30 MHz				Yes

For the PCP antenna 1 are only delta measurements performed.

5 RF measurement testing

5.1 Description of test set-up

5.1.1 Radiated measurements

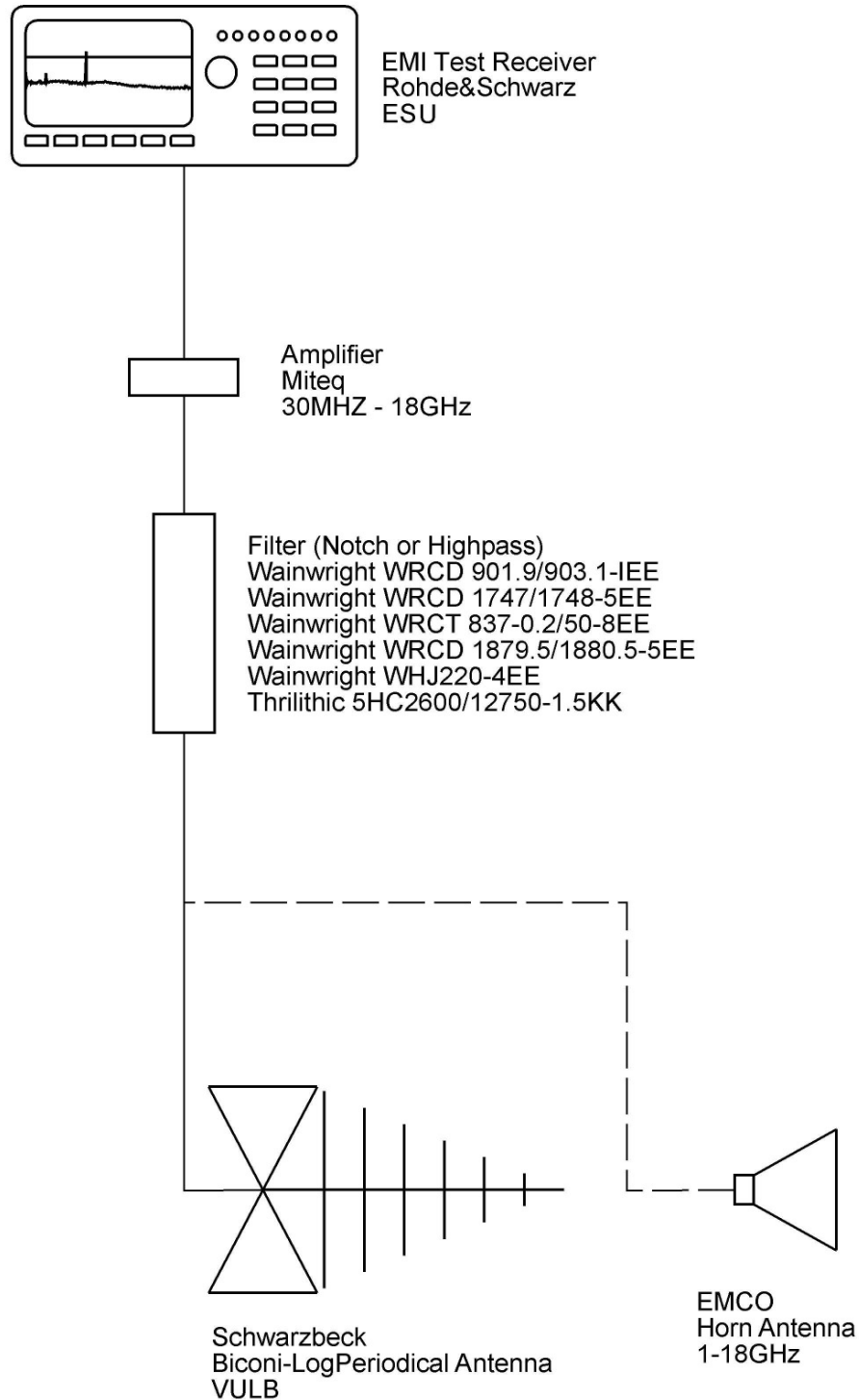

5.1.2 Conducted measurements

The EUT's RF signal is coupled out by the antenna connector which is supplied by the manufacturer. The signal is connected to the spectrum analyzer. The specific losses for signal path are first checked within a calibration. The measurement readings on the spectrum analyzer are corrected by the specific test set-up loss. The attenuator, power divider, signalling unit and the spectrum analyzer are impedance matched on 50 Ohm.

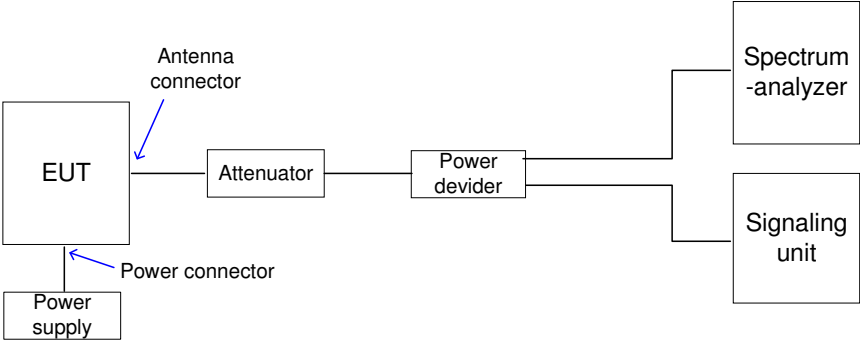

5.2 Referenced Documents

None

5.3 Additional comments

For the PCP antenna 1 are only delta measurements performed.

The followings power settings are declared by the manufacture. All measurements are performed with the specified settings.

target power file for AR6000 802.11a/b/g with super a/g TB111 Reference Design card

11a Target Power table:

Rules:

- # 1. up to a maximum of 8 test frequencies
- # 2. test frequencies DO NOT need to cover the entire range of 5180-5850. It is allowed to provide data for a smaller range. for all channels outside of test frequencies range, target power will be assumed 0dB.
- # 3. specify mask/PER limited target power for various rates

#BEGIN_11a_TARGET_POWER_TABLE

# test_frequencies	6-24_target	36_target	48_target	54_target
5180	15	15	15	15
5240	15	15	15	15
5320	15	15	15	15
5440	15	15	15	15
5460	15	15	15	15
5500	15	15	15	15
5700	15	15	15	15
5745	15	15	15	15

#END_11a_TARGET_POWER_TABLE

11b Target Power table:

Rules:

- # 1. Need to define exactly 2 test frequencies in 2.412 - 2.484 G range.
- # 2. test frequencies DO NOT need to cover the entire range of 2412-2484. It is allowed to provide data for a smaller range. for all channels outside of test frequencies range, target power will be assumed 0dB.
- # 3. specify mask/PER limited target power for various rates

#BEGIN_11b_TARGET_POWER_TABLE

# test_frequencies	1_target	2_target	5.5_target	11_target
2412	15	15	15	15
2484	15	15	15	15

#END_11b_TARGET_POWER_TABLE

ofdm@2p4 Target Power table:

```
# Rules:
# 1. up to a maximum of 3 test frequencies in 2.412 - 2.484 G range
# 2. test frequencies DO NOT need to cover the entire range of 2412-2484. It
# is allowed to provide data for a smaller range. for all channels
# outside of test frequencies range, target power will be assumed 0dB.
# 3. specify mask/PER limited target power for various rates
#
#BEGIN_11g_TARGET_POWER_TABLE
```

```
# test_frequencies 6-24_target 36_target 48_target 54_target
2412          15    15    15    15
2437          15    15    15    15
2472          15    15    15    15
#END_11g_TARGET_POWER_TABLE
```

Test Groups:

```
# Rules:
# 1. Specify up to 8 band edges for each test group.
# 2. If no backoff desired at a band edge, give a large number (e.g, 30) so
# that the driver determined limit becomes the target power.
#
```

#BEGIN_TEST_GROUPS

Test Group 1: US and CANADA (FCC)

```
# test_group_code BE1 BE2 BE3 BE4 BE5 BE6 BE7 BE8
0x10             5180 5200 5260 5320 5500 5520 5700 5745
                11  11  15  15  17  17  17  17 # Band Edge Max Power
                0  1  1  0  0  1  0  1 # in-band flag
```

Test Group 3: US and CANADA (FCC) 802.11b mode CTL

```
# test_group_code BE1 BE2 BE3
0x11             2412 2437 2442
                17  18  17 # Band Edge Max Power
                1  0  1 # in-band flag
```

Test Group 4: US and CANADA (FCC) 802.11g mode CTL

```
# test_group_code BE1 BE2 BE3 BE4
0x12             2412 2417 2457 2462
                16  18  18  17 # Band Edge Max Power
                0  1  0  0 # in-band flag
```

Test Group 6: JAPAN (MKG)

```
# test_group_code BE1 BE2
0x40             5170 5230
                17  17 # Band Edge Max Power
                0  0 # in-band flag
```

Test Group 7: EUROPE (ETSI)

# test_group_code	BE1	BE2	BE3	BE4	BE5	BE6	BE7	
0x30	5180	5320	5500	5700	5745	5765	5825	
	17	17	17	17	17	17	17	# Band Edge Max Power
	0	0	0	0	0	1	0	# in-band flag

Test Group 8: EUROPE (ETSI) 802.11b mode CTL

# test_group_code	BE1	BE2	BE3	
0x31	2412	2417	2472	
	16	16	16	# Band Edge Max Power
	0	1	0	# in-band flag

#END_TEST_GROUPS

5.4 Manufacturer's declaration

The manufacturer attests that the power settings used for testing are part of the firmware and cannot be changed by the user or host. These settings are specific for different countries and are related to the local requirements. The following measurements were performed with the specific power settings fulfilling the requirements of the FCC- and IC- rules.

5.5 Antenna gain

The antenna gain of the complete system is calculated by the difference of radiated power in EIRP and the conducted power of the module.

	low channel	mid channel	high channel
Conducted power [dBm] <i>(measured)</i>	18.08	19.28	17.61
Radiated power [dBm] <i>(measured)</i>	19.49	19.92	19.27
Gain [dBi] <i>(calculated)</i>	1.41	0.64	1.66

5.6 Peak Power Spectral density (digitally modulated systems) §15.247(e)

Not performed!

DSSS

Plot 1: (result calculated by the Signal analyzer FSIQ 26 from Rohde & Schwarz)

Plot 2: (result calculated by the Signal analyzer FSIQ 26 from Rohde & Schwarz)

Plot 3: (result calculated by the Signal analyzer FSIQ 26 from Rohde & Schwarz)

Results: Plot 1: Power density: - dBm/Hz = - dBm / 3 kHz
 Plot 2: Power density: - dBm/Hz = - dBm / 3 kHz
 Plot 3: Power density: - dBm/Hz = - dBm / 3 kHz

Correction factor from dBm/Hz to dBm/3 kHz is +34,8 dB

OFDM

Plot 1: (result calculated by the Signal analyzer FSIQ 26 from Rohde & Schwarz)

Plot 2: (result calculated by the Signal analyzer FSIQ 26 from Rohde & Schwarz)

Plot 3: (result calculated by the Signal analyzer FSIQ 26 from Rohde & Schwarz)

Results: Plot 1: Power density: - dBm/Hz = - dBm / 3 kHz
 Plot 2: Power density: - dBm/Hz = - dBm / 3 kHz
 Plot 3: Power density: - dBm/Hz = - dBm / 3 kHz

Correction factor from dBm/Hz to dBm/3 kHz is +34,8 dB

Limits:

Under normal test conditions only	For digitally modulated systems, the peak power spectral density conducted from the intentional radiator to the antenna shall not be greater than 8 dBm in any 3 kHz band during any time interval of continuous transmission
-----------------------------------	---

5.7 Spectrum Bandwidth of a DSSS System / 6 dB Bandwidth §15.247(a)(2)

Not performed!

DSSS

Plot 1:

Plot 2:

Plot 3:

Results:

Test conditions		6 dB BANDWIDTH [MHz]		
		2412	2437	2462
Frequency [MHz]				
T _{nom}	V _{nom}	--	--	--
Measurement uncertainty		±1kHz		

RBW: 100 kHz / VBW 100 kHz

OFDM

Plot 1:

Plot 2:

Plot 3:

Results:

Test conditions		6 dB BANDWIDTH [MHz]		
		2412	2437	2462
Frequency [MHz]				
T _{nom}	V _{nom}	--	--	--
Measurement uncertainty		±1kHz		

RBW: 100 kHz / VBW 100 kHz

Limits:

Under normal test conditions only	> 500 kHz
-----------------------------------	-----------

5.8 Spectrum Bandwidth of a DSSS System / 20 dB Bandwidth

Not performed!

DSSS

Plot 1:

Plot 2:

Plot 3:

Results:

Test conditions		20 dB BANDWIDTH [MHz]		
Frequency [MHz]		2412	2437	2462
T _{nom}	V _{nom}	--	--	--
Measurement uncertainty		±1kHz		

RBW: 100 kHz / VBW 100 kHz

OFDM

Plot 1:

Plot 2:

Plot 3:

Results:

Test conditions		20 dB BANDWIDTH [MHz]		
Frequency [MHz]		2412	2437	2462
T _{nom}	V _{nom}	--	--	--
Measurement uncertainty		±1kHz		

RBW: 100 kHz / VBW 100 kHz

5.9 Maximum output power (conducted) §15.247 (b)(3)

Not performed!

DSSS

Plot 1:

Plot 2:

Plot 3:

Results:

Test conditions		Max. peak output power [dBm]		
Frequency [MHz]		2412	2437	2462
T _{nom}	V _{nom}	PK		
		PK corrected	--	--
De facto EIRP (Peak) [dBm]				
Antenna gain: [dBi]		--	--	--
Measurement uncertainty		±3dB		

RBW / VBW: 10 MHz

OFDM

Plot 1:

Plot 2:

Plot 3:

Results:

Test conditions		Max. peak output power [dBm]		
		2412	2437	2462
Frequency [MHz]				
T _{nom}	V _{nom}	PK PK corrected	--	--
De facto EIRP (Peak) [dBm]			--	--
Antenna gain: [dBi]			--	--
Measurement uncertainty		±3dB		

RBW / VBW: 10 MHz

Remark:

The correction factor is calculated by $10 \times \log(\text{measured BW} / \text{used BW})$ [dB]

Limits:

Under normal test conditions only, for frequency range 2400-2483.5 MHz	Max. 1.0 Watt / 30 dBm
--	------------------------

MPE calculation

These equations are generally accurate in the far field of an antenna but will over predict power density in the near field, where they could be used for making a “worst case” prediction.

$$S = PG/4\pi R^2$$

where S = power density (in appropriate units, e.g. mW/cm²)
P = power input to the antenna (in appropriate units e.g. mW)
G = power gain of the antenna in the direction of interest relative to the isotropic radiator
R = distance to the centre of radiation of the antenna (appropriate units e.g. cm)

Or

$$S = EIRP/4\pi R^2$$

where EIRP = equivalent isotropically radiated power

Calculation:

(Calculated for max. EIRP)

EIRP: 23.92 dBm (213.3 mW)

calculated at distance of 20 cm:

$$\text{power density} = 213.3/4\pi 20^2 = 0.0424 \text{ mW/ cm}^2$$

Limit:

1mW/ cm² is the reference level for general public exposure according to the OET Bulletin 65,
Edition 97-01 Table 1.

5.10 Max. peak output power (radiated) §15.247 (b)(3)

DSSS

Results:

Test conditions		Max. peak output power EIRP [dBm]		
Frequency [MHz]		2412	2437	2462
T _{nom}	V _{nom}	19.49	19.92	19.27
Measurement uncertainty		±3dB		

RBW / VBW: 10 MHz

Measured at a distance of 3m

OFDM

Results:

Test conditions		Max. peak output power EIRP [dBm]		
Frequency [MHz]		2412	2437	2462
T _{nom}	V _{nom}	23.10	23.27	23.92
Measurement uncertainty		±3dB		

RBW / VBW: 10 MHz

Measured at a distance of 3m

Limits:

Under normal test conditions only, for frequency range 2400-2483.5 MHz	Max. 1.0 Watt
--	---------------

5.11 Band-edge compliance of conducted emissions §15.247 (d)

Not performed!

Plot 1: lowest channel

Plot 2: highest channel

Limits:

Under normal test conditions only	In any 100 kHz bandwidth outside the frequency band in which the spread spectrum or digitally modulated intentional radiator is operating, the radio frequency power that is produced by the intentional radiator shall be at least 20 dB below that in the 100 kHz bandwidth within the band that contains the highest level of the desired power, based on either an RF conducted or a radiated measurement. Attenuation below the general limits specified in Section 15.209(a) is not required. In addition, radiated emissions which fall in the restricted bands, as defined in Section 15.205(a), must also comply with the radiated emission limits specified in Section 15.209(a) (see Section 5.205(c)).
-----------------------------------	--

5.12 Band-edge compliance of radiated emissions §15.205

DSSS low channel

Plot 1: Max field strength in 3m distance (single frequency) peak

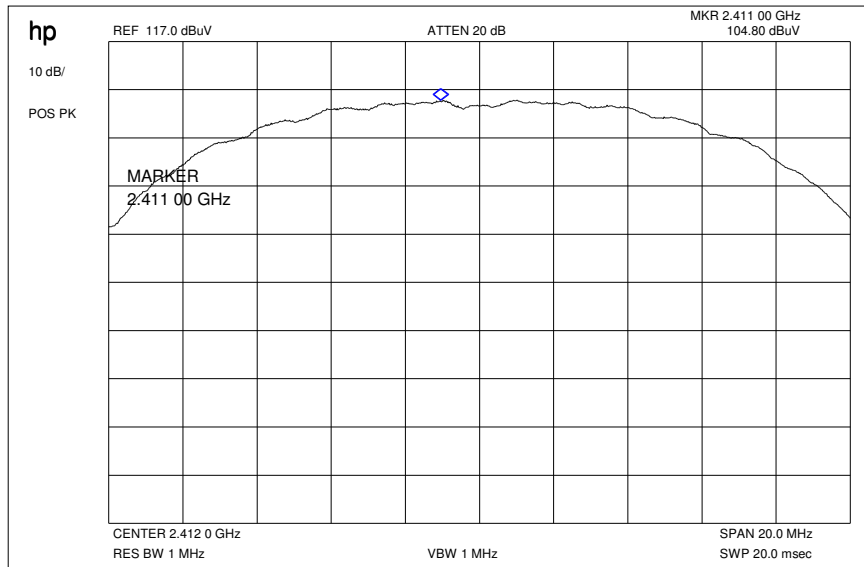

Result:

Frequency	Meter reading	Correction factor	Results
2462 MHz	104.80 dB μ V/m	-6.4 dB	98.4 dB μ V/m

Plot 2: Max field strength in 3m distance (single frequency) average

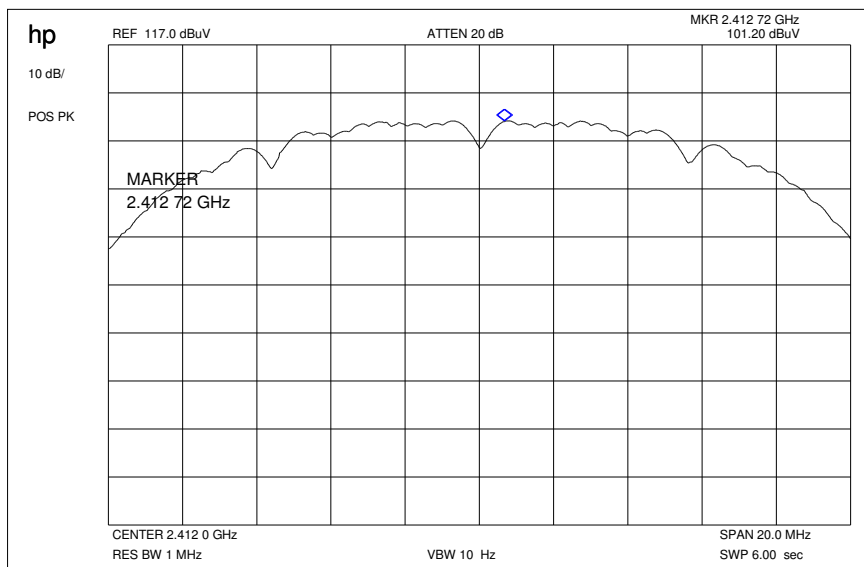

Result:

Frequency	Meter reading	Correction factor	Results
2462 MHz	101.20 dB μ V/m	-6.4 dB	94.8 dB μ V/m

Plot 3: Marker-Delta Method RBW/VBW = 1% of span

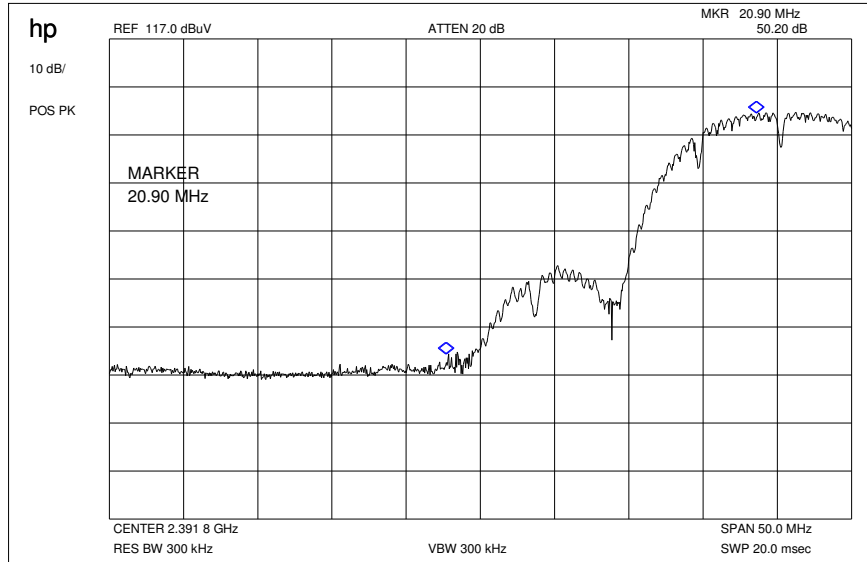

Result:

Marker-Delta-Value: 50.20 dB

This measurement was made to show that the behaviour of the system is conform to FCC 15.205 (restricted bands)

Results & Limits:

Radiated field strength

The field strength was measured with an EMI measuring receiver and 1 MHz RBW / VBW for peak and with 1MHz RBW / 10Hz VBW for average at a distance of 3m.

high channel	setup	measured value (3m)	correction factor (3m)	calculated value (3m)
Max. peak value	1 MHz RBW 1 MHz VBW	104.80 dBµV/m	-6.4 dB	98.40 dBµV/m
Max. average value	1 MHz RBW 10 Hz VBW	101.20 dBµV/m	-6.4 dB	94.80 dBµV/m
Delta value	Peak 300 kHz RBW/VBW	50.20 dB		
Value at band edge	limit 54 dBµV/m			44.60 dBµV/m
Statement:				Complies

DSSS high channel

Plot 1: Max field strength in 3m distance (single frequency) peak

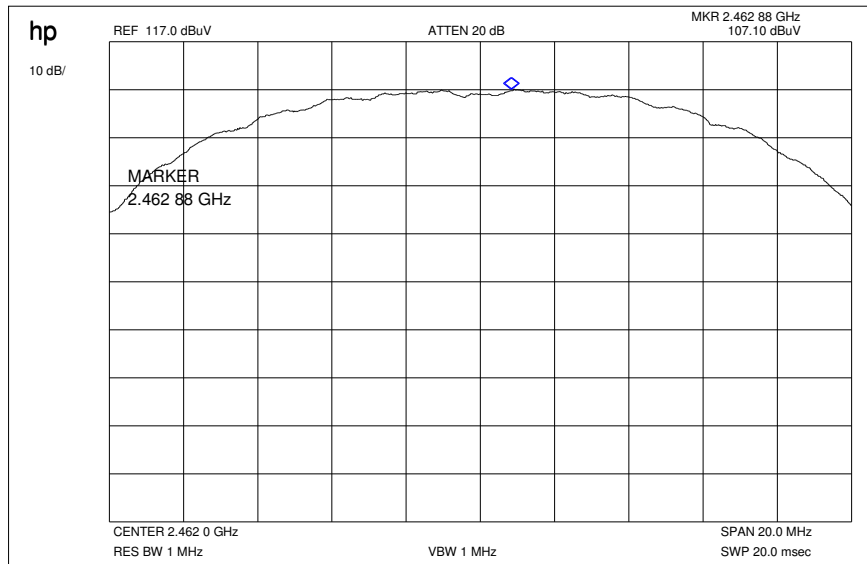

Result:

Frequency	Meter reading	Correction factor	Results
2462 MHz	107.10 dB μ V/m	-6.4 dB	100.7 dB μ V/m

Plot 2: Max field strength in 3m distance (single frequency) average

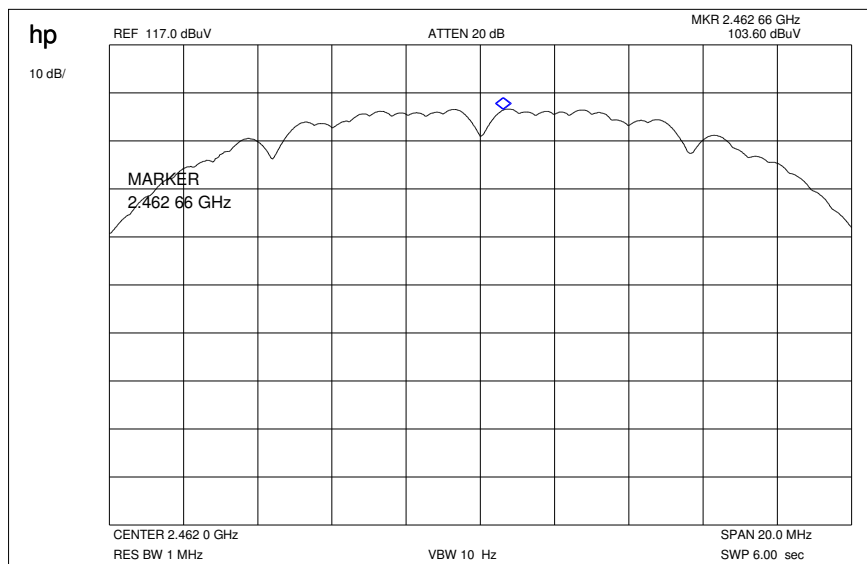

Result:

Frequency	Meter reading	Correction factor	Results
2462 MHz	103.60 dB μ V/m	-6.4 dB	97.20 dB μ V/m

Plot 3: Marker-Delta Method RBW/VBW = 1% of span

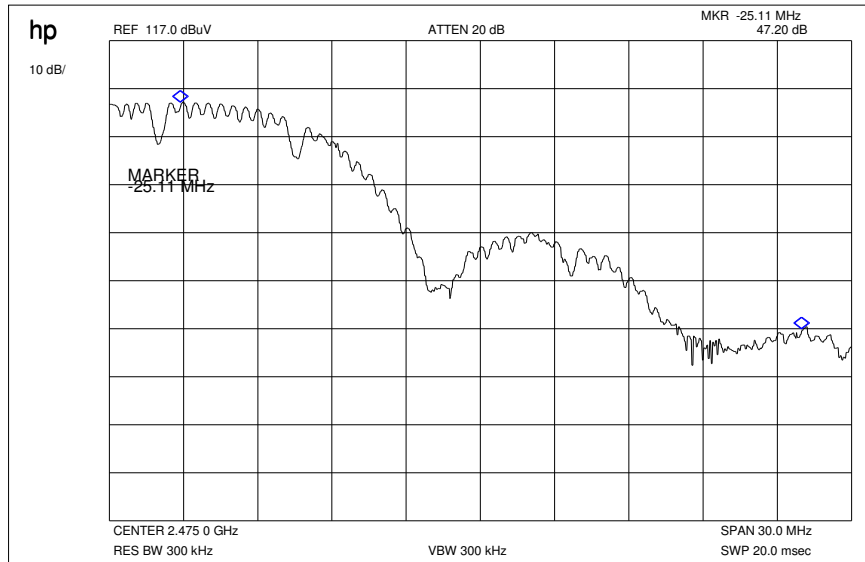

Result:

Marker-Delta-Value: 47.20 dB

This measurement was made to show that the behaviour of the system is conform to FCC 15.205 (restricted bands)

Results & Limits:

Radiated field strength

The field strength was measured with an EMI measuring receiver and 1 MHz RBW / VBW for peak and with 1MHz RBW / 10Hz VBW for average at a distance of 3m.

high channel	setup	measured value (3m)	correction factor (3m)	calculated value (3m)
Max. peak value	1 MHz RBW 1 MHz VBW	107.10 dBµV/m	-6.4 dB	100.70 dBµV/m
Max. average value	1 MHz RBW 10 Hz VBW	103.60 dBµV/m	-6.4 dB	97.20 dBµV/m
Delta value	Peak 300 kHz RBW/VBW	47.20 dB		
Value at band edge	limit 54 dBµV/m			50.00 dBµV/m
Statement:				Complies

OFDM low channel

Plot 1:

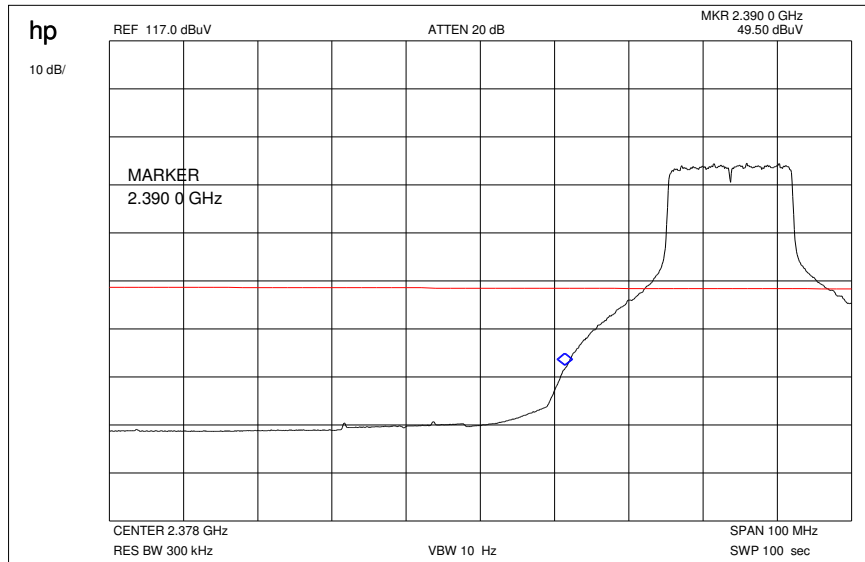

The result of the measurement is passed.

OFDM high channel

Plot 1:

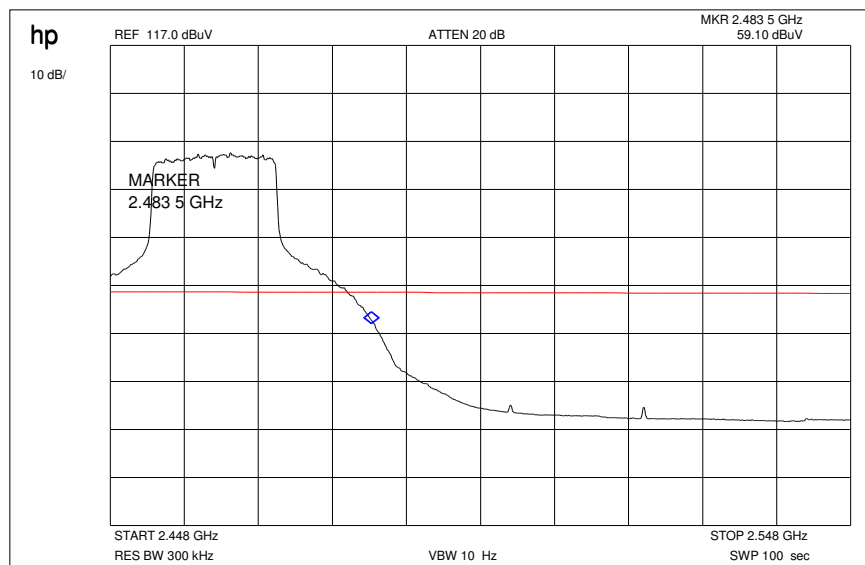

The result of the measurement is passed.

5.13 Spurious Emissions - conducted (Transmitter) §15.247 (c)

Not performed!

DSSS

Plot 1: Lowest Channel

Plot 2: Middle Channel

Plot 3: Highest Channel

Result & Limits:

Emission Limitations					
f [MHz]		amplitude of emission [dBm]	limit max. allowed emission power	actual attenuation below frequency of operation [dB]	results
2412	--	--	30 dBm	--	Operating frequency
			-20 dBc		
2437	--	--	30 dBm	--	Operating frequency
			-20 dBc		
2462	--	--	30 dBm	--	Operating frequency
			-20 dBc		
Measurement uncertainty			± 3dB		

F < 1 GHz: RBW: 100 kHz VBW: 100 kHz
 F > 1 GHz: RBW: 1 MHz VBW: 1 MHz

Under normal test conditions only	In any 100 kHz bandwidth outside the frequency band at least 20dB below the highest level of the desired power. In addition, radiated emissions which fall in the restricted bands, as defined in §15.205(a), must also comply with the radiated emission limits specified in §15.209(a) (see §15.205(c)).
-----------------------------------	--

Note: For emissions that fall into restricted bands you find the radiated emissions later in the report.

Not performed!

OFDM

Plot 1: Lowest Channel

Plot 2: Middle Channel

Plot 3: Highest Channel

Result & Limits:

Emission Limitations					
f [MHz]		amplitude of emission [dBm]	limit max. allowed emission power	actual attenuation below frequency of operation [dB]	results
2412	--	--	30 dBm	--	Operating frequency
			-20 dBc		
2437	--	--	30 dBm	--	Operating frequency
			-20 dBc		
2462	--	--	30 dBm	--	Operating frequency
			-20 dBc		
Measurement uncertainty			± 3dB		

F < 1 GHz: RBW: 100 kHz VBW: 100 kHz
 F > 1 GHz: RBW: 1 MHz VBW: 1 MHz

Under normal test conditions only	In any 100 kHz bandwidth outside the frequency band at least 20dB below the highest level of the desired power. In addition, radiated emissions which fall in the restricted bands, as defined in §15.205(a), must also comply with the radiated emission limits specified in §15.209(a) (see §15.205(c)).
-----------------------------------	--

Note: For emissions that fall into restricted bands you find the radiated emissions later in the report.

5.14 Spurious Emissions - radiated (Transmitter) §15.209

DSSS

Plot 1: 0.03 - 1 GHz (lowest channel)

Common Information

EUT: Philips Medizin MMS + WLAN a/b/g/ Modul
 Serial Number: Antenna M8100-66490
 Test Description: FCC part 15.247
 Operating Conditions: Wlan Mode b; 1 Mb/s; Ch 2.412 GHz; Output Power = 17.0
 Operator Name: ZAK
 Comment: Powered with DC 5 V

Scan Setup: FCC_Fin [EMI radiated]

Hardware Setup: Electric Field (NOS)
 Level Unit: dBµV/m

Subrange **Detectors** **IF Bandwidth** **Meas. Time** **Receiver**
 30 MHz - 1 GHz QuasiPeak 120 kHz 15 s Receiver

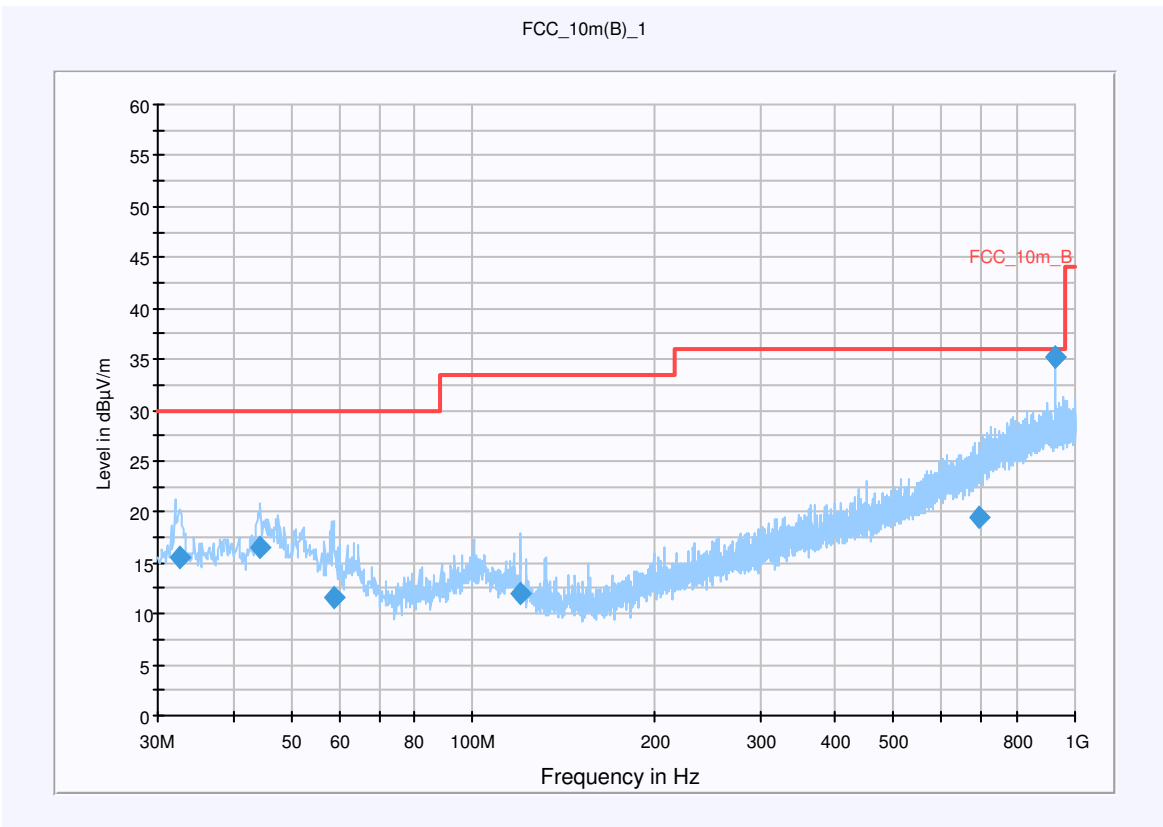

Final Result 1

Frequency (MHz)	QuasiPeak (dBµV/m)	Meas. Time (ms)	Bandwidth (kHz)	Antenna height (cm)	Polarity	Turntable position (deg)	Corr. (dB)	Margin (dB)	Limit (dBµV/m)	Comment
32.514100	15.5	15000.000	120.000	150.0	V	70.0	12.9	14.5	30.0	
44.364100	16.5	15000.000	120.000	138.0	V	323.0	13.4	13.5	30.0	
58.850350	11.6	15000.000	120.000	235.0	V	231.0	12.1	18.4	30.0	
120.028200	12.0	15000.000	120.000	235.0	V	0.0	10.5	21.5	33.5	
694.249300	19.6	15000.000	120.000	200.0	H	23.0	22.4	16.4	36.0	
928.665700	35.1	15000.000	120.000	288.0	H	141.0	25.9	0.9	36.0	

Hardware Setup: EMI radiated\Electric Field (NOS) - [EMI radiated]

Subrange 1	
Frequency Range:	30 MHz - 2 GHz
Receiver:	Receiver [ESCI 3] @ GPIB0 (ADR 20), SN 100083/003, FW 3.32, CAL 07.01.2009
Signal Path:	without Notch FW 1.0
Antenna:	VULB 9163 SN 9163-295, FW ---, CAL 08.04.2010 Correction Table (vertical): VULP6113 Correction Table (horizontal): VULP6113 Correction Table: Cabel with switch (0908)
Antenna Tower:	Tower [EMCO 2090 Antenna Tower] @ GPIB0 (ADR 8), FW REV 3.12
Turntable:	Turntable [EMCO Turntable] @ GPIB0 (ADR 9), FW REV 3.12

Plot 2: 1 - 4 GHz (lowest channel)

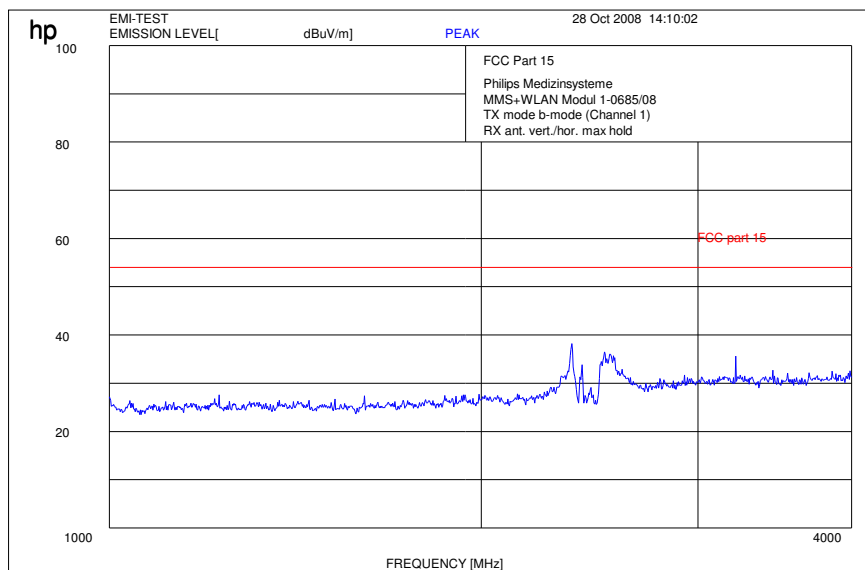

The carrier signal is notched with a 2.4 GHz band rejection filter.

Plot 3: 4 - 12 GHz (lowest channel)

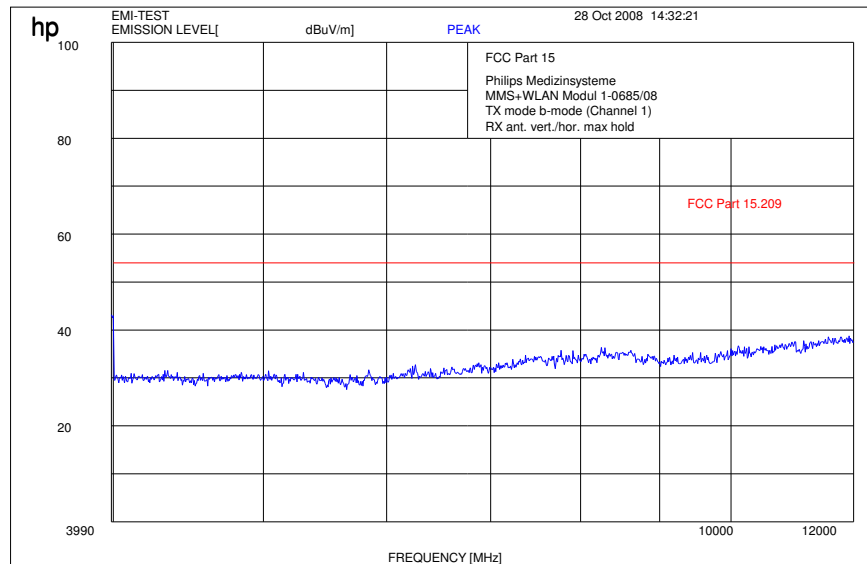

Plot 4: 12 - 25 GHz (valid for all channels)

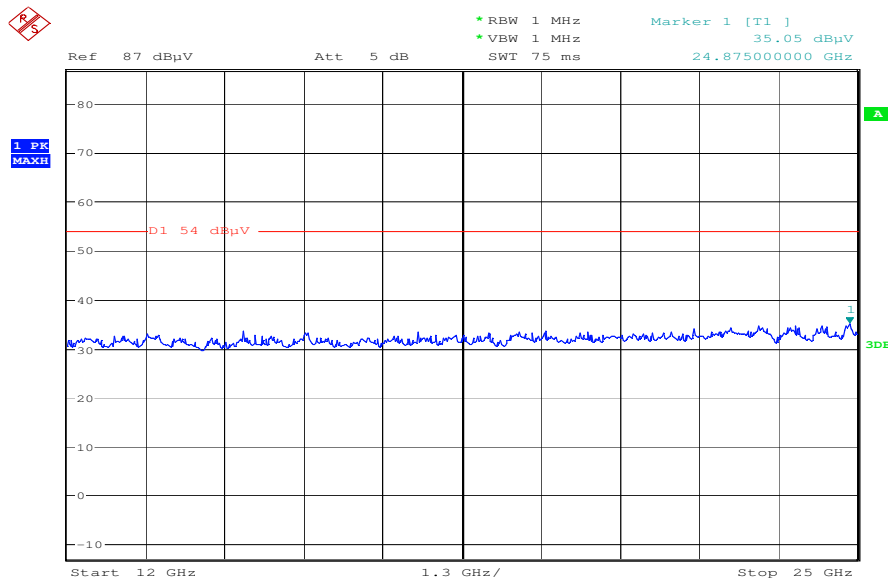

Date: 30.OCT.2008 14:25:00

Plot 5: 0.03 - 1 GHz (middle channel)

Common Information

EUT: Philips Medizin MMS + WLAN a/b/g/ Modul
 Serial Number: Antenna M8100-66490
 Test Description: FCC part 15.247
 Operating Conditions: Wlan Mode b; 1 Mb/s; Ch 2.437 GHz; Output Power = 18.0
 Operator Name: ZAK
 Comment: Powered with DC 5 V

Scan Setup: FCC_Fin [EMI radiated]

Hardware Setup: Electric Field (NOS)
 Level Unit: dBµV/m

Subrange **Detectors** **IF Bandwidth** **Meas. Time** **Receiver**
 30 MHz - 1 GHz QuasiPeak 120 kHz 15 s Receiver

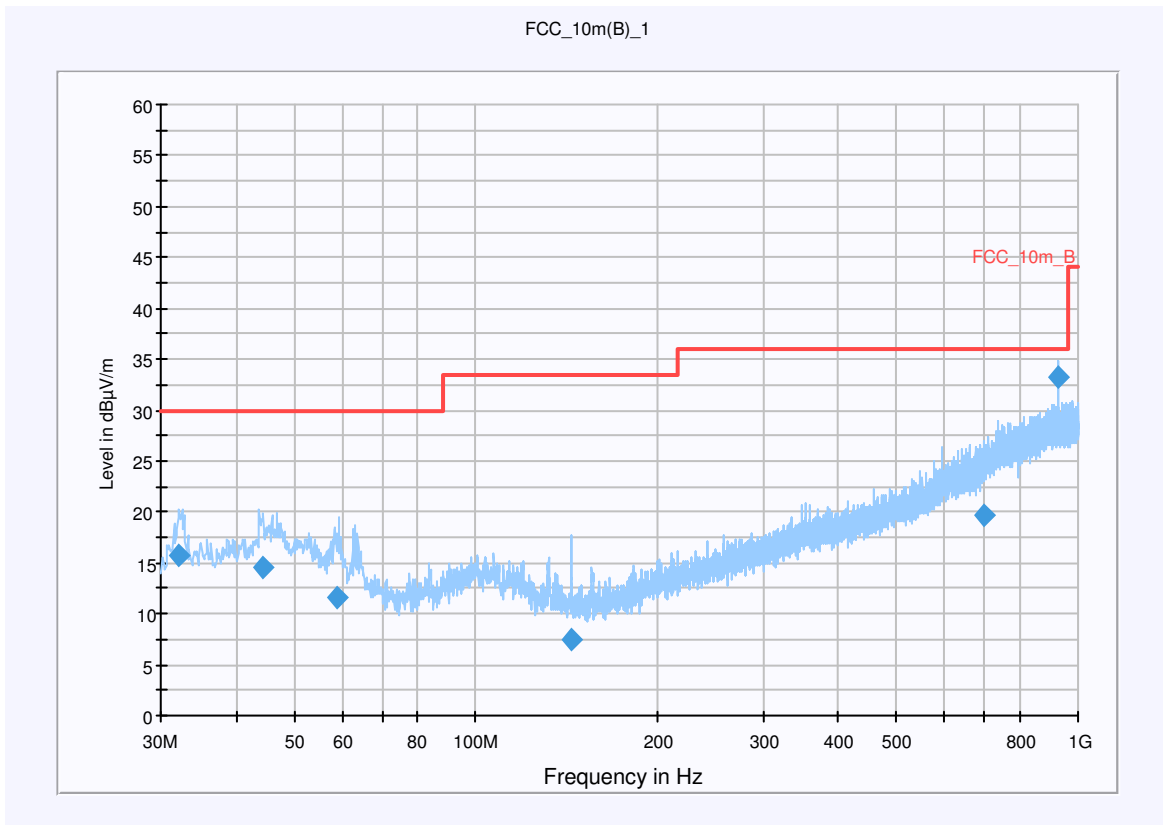

Final Result 1

Frequency (MHz)	QuasiPeak (dBµV/m)	Meas. Time (ms)	Bandwidth (kHz)	Antenna height (cm)	Polarity	Turntable position (deg)	Corr. (dB)	Margin (dB)	Limit (dBµV/m)	Comment
32.117850	15.7	15000.000	120.000	100.0	V	50.0	12.8	14.3	30.0	
44.317950	14.5	15000.000	120.000	100.0	V	125.0	13.4	15.5	30.0	
58.632650	11.7	15000.000	120.000	390.0	V	147.0	12.2	18.4	30.0	
144.341300	7.5	15000.000	120.000	100.0	V	219.0	9.0	26.0	33.5	
700.068100	19.7	15000.000	120.000	359.0	H	231.0	22.6	16.3	36.0	
928.615900	33.3	15000.000	120.000	400.0	H	4.0	25.9	2.7	36.0	

Hardware Setup: EMI radiated\Electric Field (NOS) - [EMI radiated]

Subrange 1	
Frequency Range:	30 MHz - 2 GHz
Receiver:	Receiver [ESCI 3] @ GPIB0 (ADR 20), SN 100083/003, FW 3.32, CAL 07.01.2009
Signal Path:	without Notch FW 1.0
Antenna:	VULB 9163 SN 9163-295, FW ---, CAL 08.04.2010 Correction Table (vertical): VULP6113 Correction Table (horizontal): VULP6113 Correction Table: Cabel with switch (0908)
Antenna Tower:	Tower [EMCO 2090 Antenna Tower] @ GPIB0 (ADR 8), FW REV 3.12
Turntable:	Turntable [EMCO Turntable] @ GPIB0 (ADR 9), FW REV 3.12

Plot 6: 1 - 4 GHz (middle channel)

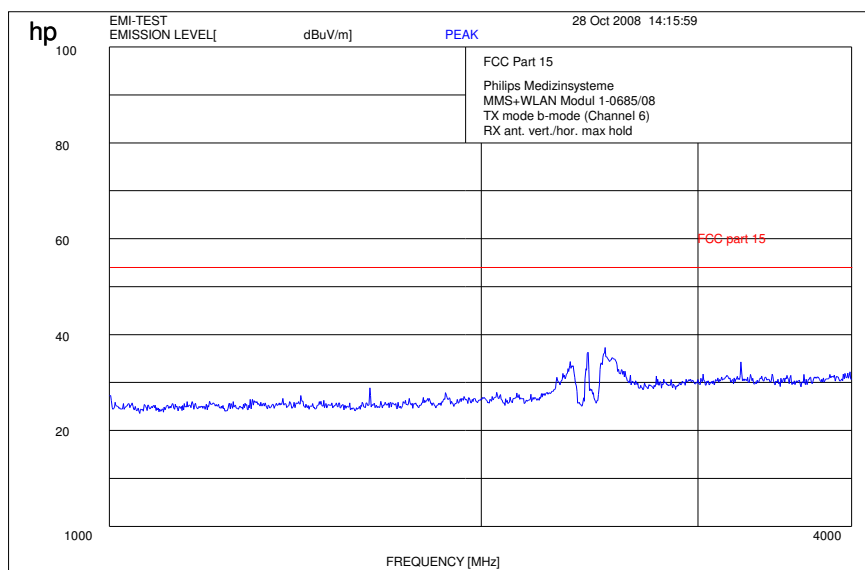

The carrier signal is notched with a 2.4 GHz band rejection filter.

Plot 7: 4 - 12 GHz (middle channel)

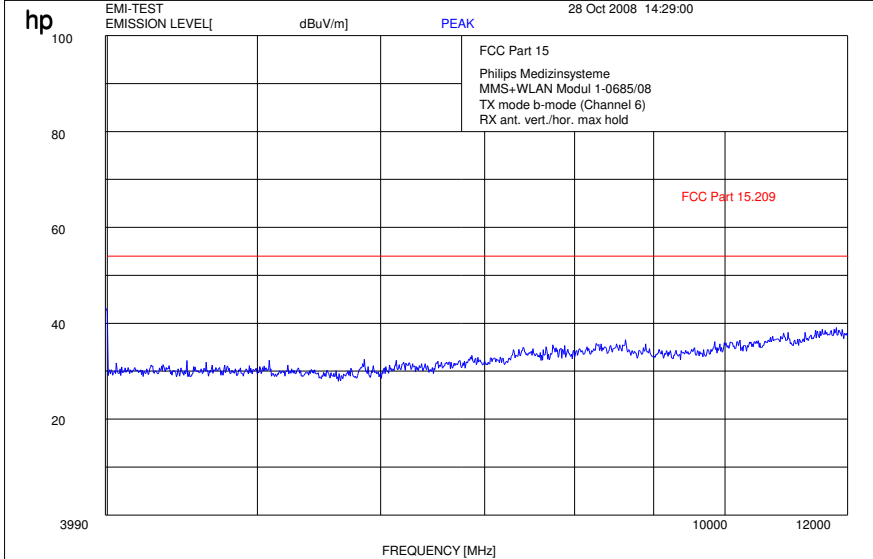

Plot 8: 0.03 - 1 GHz (highest channel)

Common Information

EUT: Philips Medizin MMS + WLAN a/b/g/ Modul
 Serial Number: Antenna M8100-66490
 Test Description: FCC part 15.247
 Operating Conditions: Wlan Mode b; 1 Mbits; Ch 2.462 Ghz; Output Power = 17.0
 Operator Name: ZAK
 Comment: Powered with DC 5 V

Scan Setup: FCC_Fin [EMI radiated]

Hardware Setup: Electric Field (NOS)
 Level Unit: dBµV/m

Subrange **Detectors** **IF Bandwidth** **Meas. Time** **Receiver**
 30 MHz - 1 GHz QuasiPeak 120 kHz 15 s Receiver

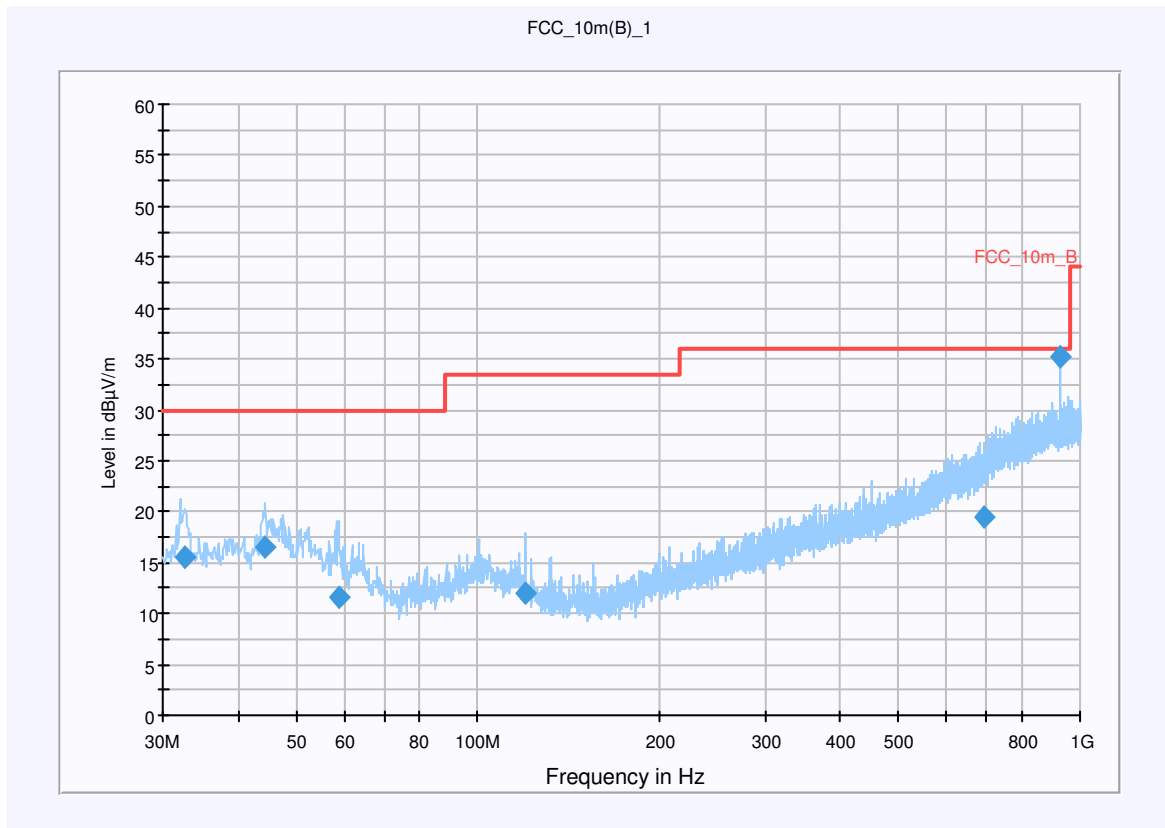

Final Result 1

Frequency (MHz)	QuasiPeak (dBµV/m)	Meas. Time (ms)	Bandwidth (kHz)	Antenna height (cm)	Polarity	Turntable position (deg)	Corr. (dB)	Margin (dB)	Limit (dBµV/m)	Comment
32.514100	15.5	15000.000	120.000	150.0	V	70.0	12.9	14.5	30.0	
44.364100	16.5	15000.000	120.000	138.0	V	323.0	13.4	13.5	30.0	
58.850350	11.6	15000.000	120.000	235.0	V	231.0	12.1	18.4	30.0	
120.028200	12.0	15000.000	120.000	235.0	V	0.0	10.5	21.5	33.5	
694.249300	19.6	15000.000	120.000	200.0	H		23.0	16.4	36.0	
928.665700	35.1	15000.000	120.000	288.0	H	141.0	25.9	0.9	36.0	

Hardware Setup: EMI radiated\Electric Field (NOS) - [EMI radiated]

Subrange 1	
Frequency Range:	30 MHz - 2 GHz
Receiver:	Receiver [ESCI 3] @ GPIB0 (ADR 20), SN 100083/003, FW 3.32, CAL 07.01.2009
Signal Path:	without Notch FW 1.0
Antenna:	VULB 9163 SN 9163-295, FW ---, CAL 08.04.2010 Correction Table (vertical): VULP6113 Correction Table (horizontal): VULP6113 Correction Table: Cabel with switch (0908)
Antenna Tower:	Tower [EMCO 2090 Antenna Tower] @ GPIB0 (ADR 8), FW REV 3.12
Turntable:	Turntable [EMCO Turntable] @ GPIB0 (ADR 9), FW REV 3.12

Plot 9: 1 - 4 GHz (highest channel)

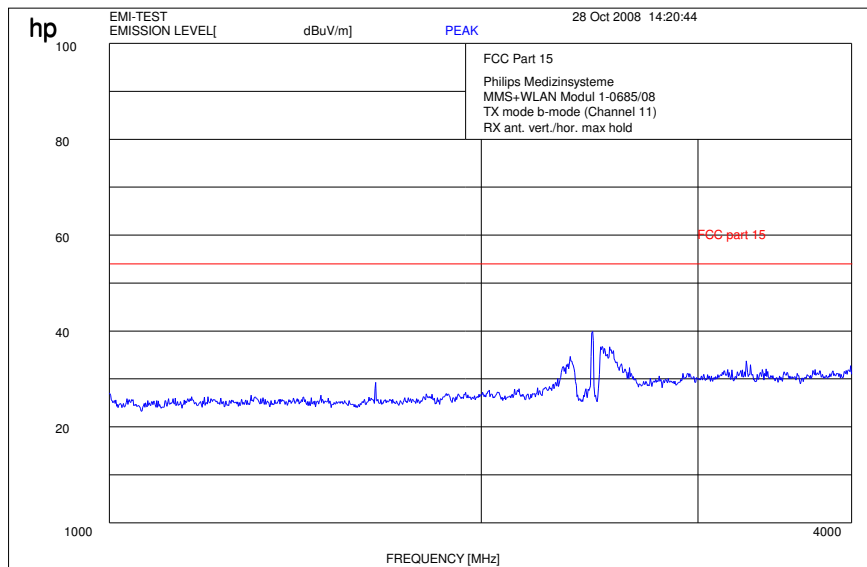

The carrier signal is notched with a 2.4 GHz band rejection filter.

Plot 10: 4 - 12 GHz (highest channel)

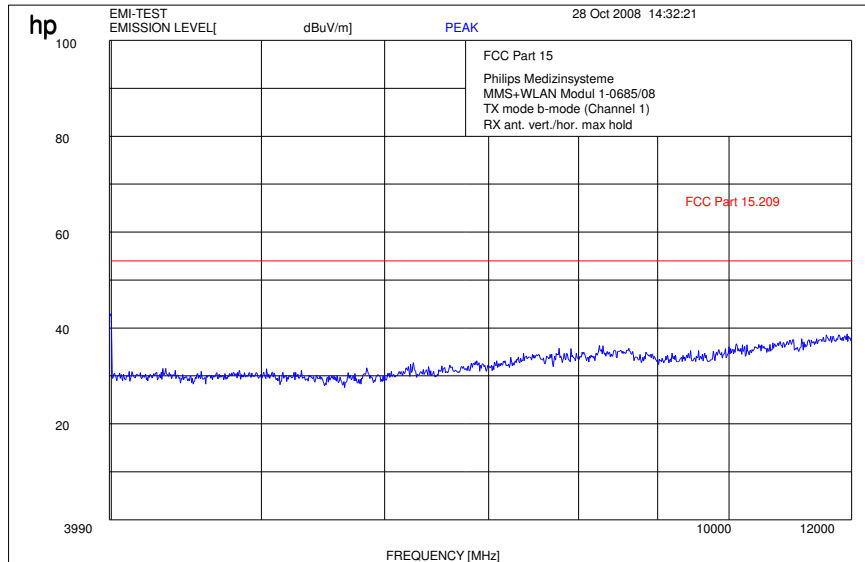

Results:

Spurious Emissions level [dBμV/m]								
2412 MHz			2437 MHz			2462 MHz		
F [MHz]	Detector	Level [dBμV/m]	F [MHz]	Detector	Level [dBμV/m]	F [MHz]	Detector	Level [dBμV/m]
928.67	QP	35.1	928.61	QP	33.3	928.67	QP	35.1
Measurement uncertainty			±3 dB					

f < 1 GHz : RBW/VBW: 100 kHz

f ≥ 1GHz : RBW/VBW: 1 MHz

Limits: § 15.247 (c)

In any 100 kHz bandwidth outside the frequency band at least 20dB below the highest level of the desired power. In addition, radiated emissions which fall in the restricted bands, as defined in §15.205(a), must also comply with the radiated emission limits specified in §15.209(a) (see §15.205(c)).

Limits: § 15.109

Frequency (MHz)	Field strength (dBμV/m)	Measurement distance (m)
30 - 88	30.0	10
88 - 216	33.5	10
216 - 960	36.0	10
above 960	54.0	3

OFDM:

Plot 1: 0.03 - 1 GHz (lowest channel)

Common Information

EUT: Philips Medizin MMS + WLAN a/b/g/ Modul
 Serial Number: Antenna M8100-66490
 Test Description: FCC part 15.247
 Operating Conditions: Wlan Mode G 54Mbps; Ch 2.412 Ghz; Output Power = 16.0
 Operator Name: ZAK
 Comment: Powered with DC 5 V

Scan Setup: FCC_Fin [EMI radiated]

Hardware Setup: Electric Field (NOS)
 Level Unit: dBµV/m

Subrange **Detectors** **IF Bandwidth** **Meas. Time** **Receiver**
 30 MHz - 1 GHz QuasiPeak 120 kHz 15 s Receiver

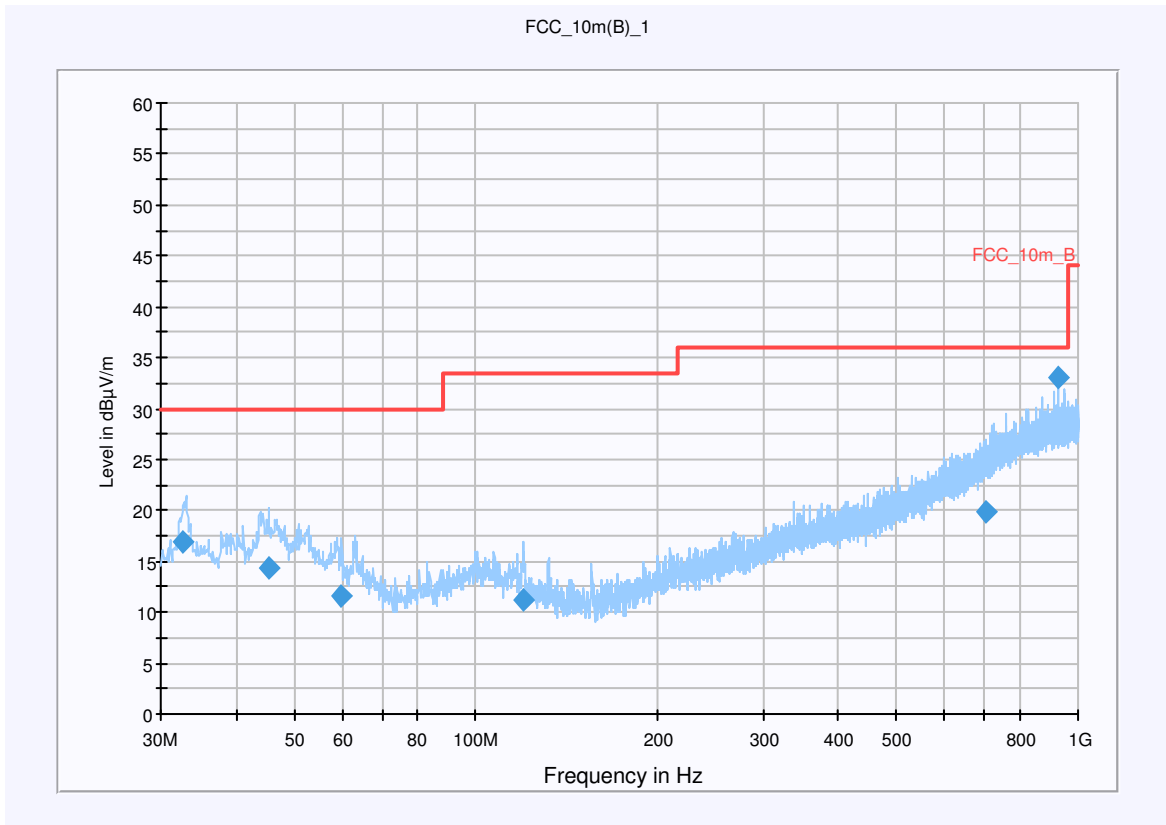

Final Result 1

Frequency (MHz)	QuasiPeak (dBµV/m)	Meas. Time (ms)	Bandwidth (kHz)	Antenna height (cm)	Polarity	Turntable position (deg)	Corr. (dB)	Margin (dB)	Limit (dBµV/m)	Comment
32.553800	16.9	15000.000	120.000	101.0	V	233.0	12.9	13.1	30.0	
45.522500	14.3	15000.000	120.000	123.0	V	36.0	13.4	15.7	30.0	
59.834900	11.5	15000.000	120.000	392.0	V	43.0	11.9	18.5	30.0	
120.096450	11.2	15000.000	120.000	201.0	V	143.0	10.5	22.3	33.5	
704.085550	19.9	15000.000	120.000	386.0	V	40.0	22.7	16.1	36.0	
928.660300	33.0	15000.000	120.000	174.0	H	50.0	25.9	3.0	36.0	

Hardware Setup: EMI radiated\Electric Field (NOS) - [EMI radiated]

Subrange 1	
Frequency Range:	30 MHz - 2 GHz
Receiver:	Receiver [ESCI 3] @ GPIB0 (ADR 20), SN 100083/003, FW 3.32, CAL 07.01.2009
Signal Path:	without Notch FW 1.0
Antenna:	VULB 9163 SN 9163-295, FW ---, CAL 08.04.2010 Correction Table (vertical): VULP6113 Correction Table (horizontal): VULP6113 Correction Table: Cabel with switch (0908)
Antenna Tower:	Tower [EMCO 2090 Antenna Tower] @ GPIB0 (ADR 8), FW REV 3.12
Turntable:	Turntable [EMCO Turntable] @ GPIB0 (ADR 9), FW REV 3.12

Plot 2: 1 - 4 GHz (lowest channel)

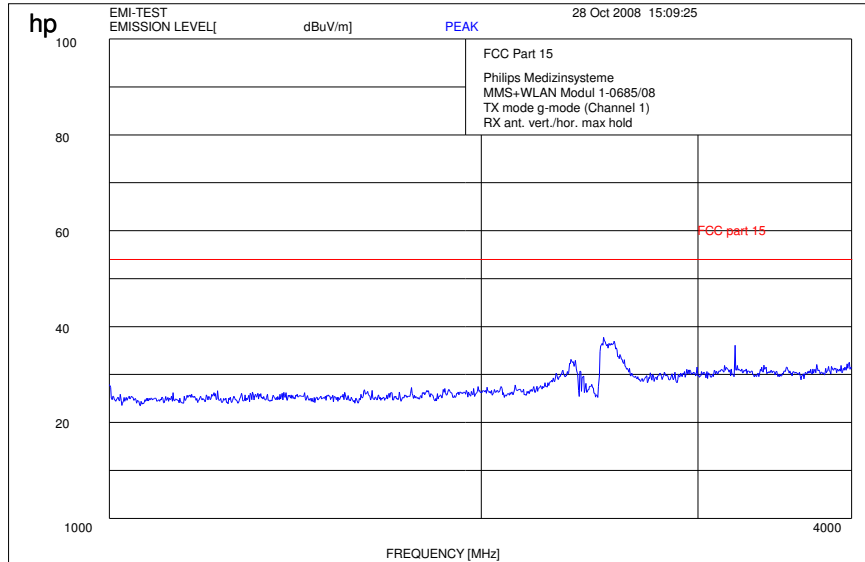

The carrier signal is notched with a 2.4 GHz band rejection filter.

Plot 3: 4 - 12 GHz (lowest channel)

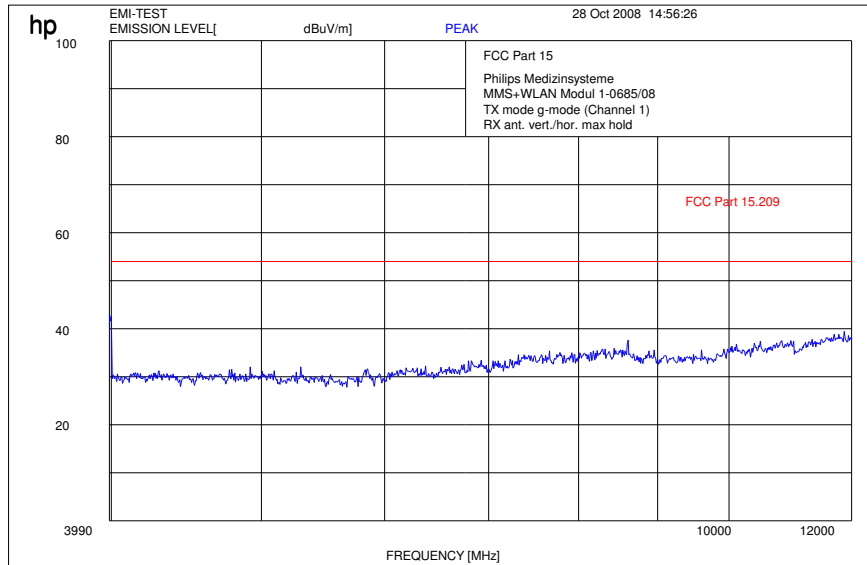

Plot 4: 12 - 25 GHz (valid for all channels)

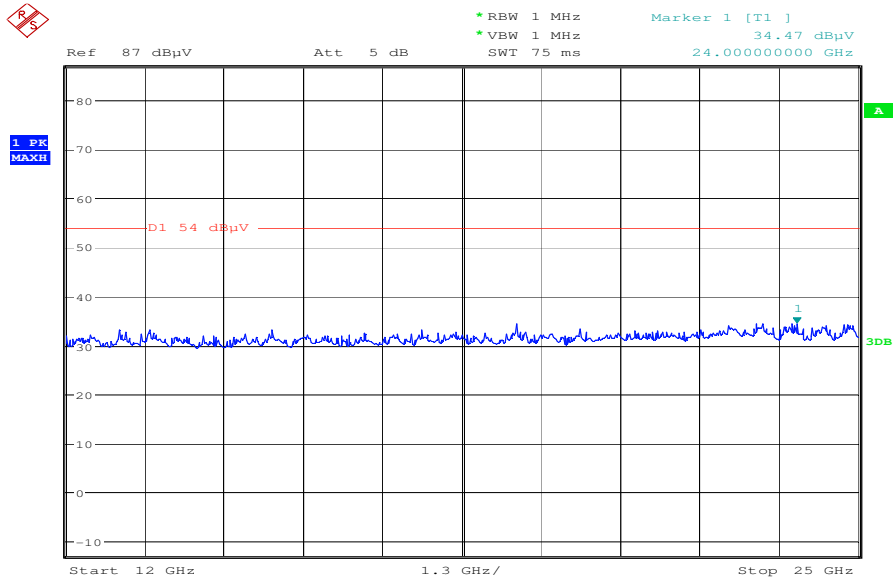

Date: 30.OCT.2008 14:25:19

Plot 5: 0.03 - 1 GHz (middle channel)

Common Information

EUT: Philips Medizin MMS + WLAN a/b/g/ Modul
 Serial Number: Antenna M8100-66490
 Test Description: FCC part 15.247
 Operating Conditions: Wlan Mode G 54Mbits; Ch 2.437 Ghz; Output Power = 18.0
 Operator Name: ZAK
 Comment: Powered with DC 5 V

Scan Setup: FCC_Fin [EMI radiated]

Hardware Setup: Electric Field (NOS)
 Level Unit: dBµV/m

Subrange **Detectors** **IF Bandwidth** **Meas. Time** **Receiver**
 30 MHz - 1 GHz QuasiPeak 120 kHz 15 s Receiver

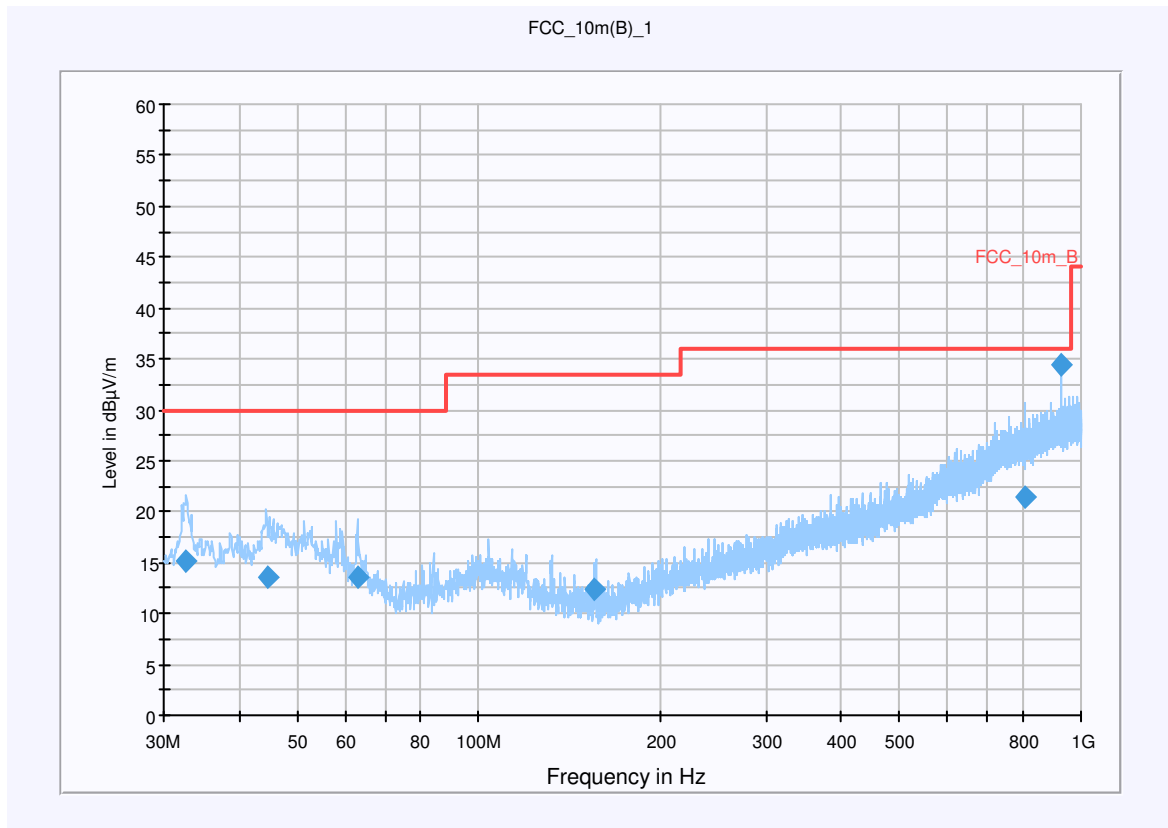

Final Result 1

Frequency (MHz)	QuasiPeak (dBµV/m)	Meas. Time (ms)	Bandwidth (kHz)	Antenna height (cm)	Polarity	Turntable position (deg)	Corr. (dB)	Margin (dB)	Limit (dBµV/m)	Comment
32.581250	15.2	15000.000	120.000	194.0	V	323.0	12.9	14.8	30.0	
44.829400	13.6	15000.000	120.000	173.0	V	323.0	13.4	16.4	30.0	
63.058550	13.6	15000.000	120.000	190.0	H	143.0	11.1	16.4	30.0	
156.095400	12.5	15000.000	120.000	123.0	V	286.0	9.3	21.0	33.5	
808.184700	21.5	15000.000	120.000	400.0	V	222.0	24.4	14.5	36.0	
928.640800	34.5	15000.000	120.000	294.0	H	139.0	25.9	1.5	36.0	

Hardware Setup: EMI radiated\Electric Field (NOS) - [EMI radiated]

Subrange 1	
Frequency Range:	30 MHz - 2 GHz
Receiver:	Receiver [ESCI 3] @ GPIB0 (ADR 20), SN 100083/003, FW 3.32, CAL 07.01.2009
Signal Path:	without Notch FW 1.0
Antenna:	VULB 9163 SN 9163-295, FW ---, CAL 08.04.2010 Correction Table (vertical): VULP6113 Correction Table (horizontal): VULP6113 Correction Table: Cabel with switch (0908)
Antenna Tower:	Tower [EMCO 2090 Antenna Tower] @ GPIB0 (ADR 8), FW REV 3.12
Turntable:	Turntable [EMCO Turntable] @ GPIB0 (ADR 9), FW REV 3.12

Plot 6: 1 - 4 GHz (middle channel)

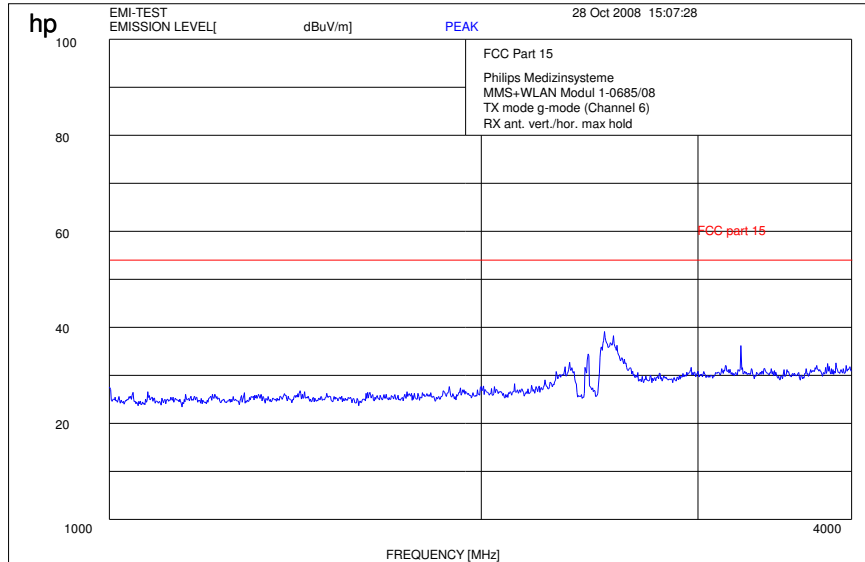

The carrier signal is notched with a 2.4 GHz band rejection filter.

Plot 7: 4 - 12 GHz (middle channel)

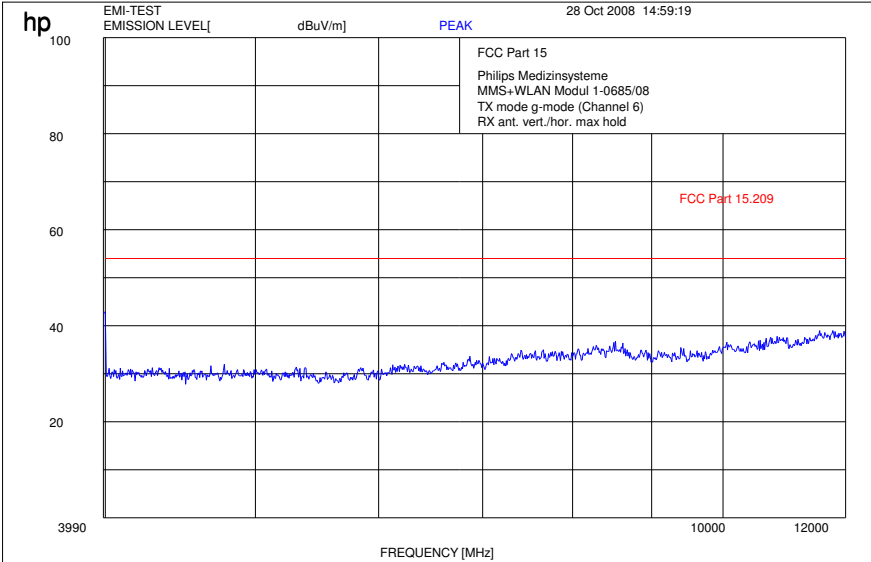

Plot 8: 0.03 - 1 GHz (highest channel)

Common Information

EUT: Philips Medizin MMS + WLAN a/b/g/ Modul
 Serial Number: Antenna M8100-66490
 Test Description: FCC part 15.247
 Operating Conditions: Wlan Mode G 54Mbits; Ch 2.462 Ghz; Output Power = 17.0
 Operator Name: ZAK
 Comment: Powered with DC 5 V

Scan Setup: FCC_Fin [EMI radiated]

Hardware Setup: Electric Field (NOS)
 Level Unit: dBµV/m

Subrange **Detectors** **IF Bandwidth** **Meas. Time** **Receiver**
 30 MHz - 1 GHz QuasiPeak 120 kHz 15 s Receiver

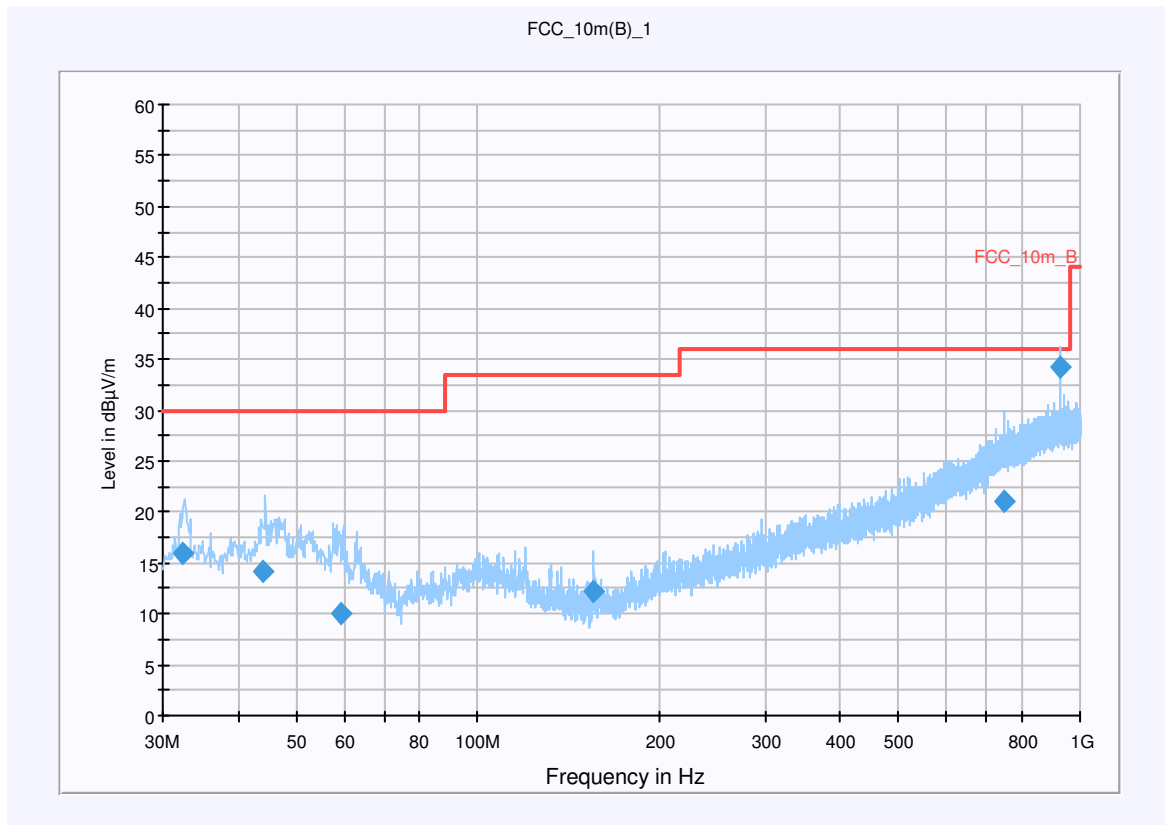

Final Result 1

Frequency (MHz)	QuasiPeak (dBµV/m)	Meas. Time (ms)	Bandwidth (kHz)	Antenna height (cm)	Polarity	Turntable position (deg)	Corr. (dB)	Margin (dB)	Limit (dBµV/m)	Comment
32.489250	16.0	15000.000	120.000	100.0	V	323.0	12.9	14.0	30.0	
44.122000	14.2	15000.000	120.000	126.0	V	17.0	13.4	15.8	30.0	
59.492050	10.0	15000.000	120.000	200.0	V	44.0	11.9	20.0	30.0	
156.002150	12.3	15000.000	120.000	100.0	V	256.0	9.3	21.2	33.5	
747.112150	21.0	15000.000	120.000	346.0	V	323.0	23.9	15.0	36.0	
928.644100	34.2	15000.000	120.000	200.0	H	315.0	25.9	1.8	36.0	

Hardware Setup: EMI radiated\Electric Field (NOS) - [EMI radiated]

Subrange 1	
Frequency Range:	30 MHz - 2 GHz
Receiver:	Receiver [ESCI 3] @ GPIB0 (ADR 20), SN 100083/003, FW 3.32, CAL 07.01.2009
Signal Path:	without Notch FW 1.0
Antenna:	VULB 9163 SN 9163-295, FW ---, CAL 08.04.2010 Correction Table (vertical): VULP6113 Correction Table (horizontal): VULP6113 Correction Table: Cabel with switch (0908)
Antenna Tower:	Tower [EMCO 2090 Antenna Tower] @ GPIB0 (ADR 8), FW REV 3.12
Turntable:	Turntable [EMCO Turntable] @ GPIB0 (ADR 9), FW REV 3.12

Plot 9: 1 - 4 GHz (highest channel)

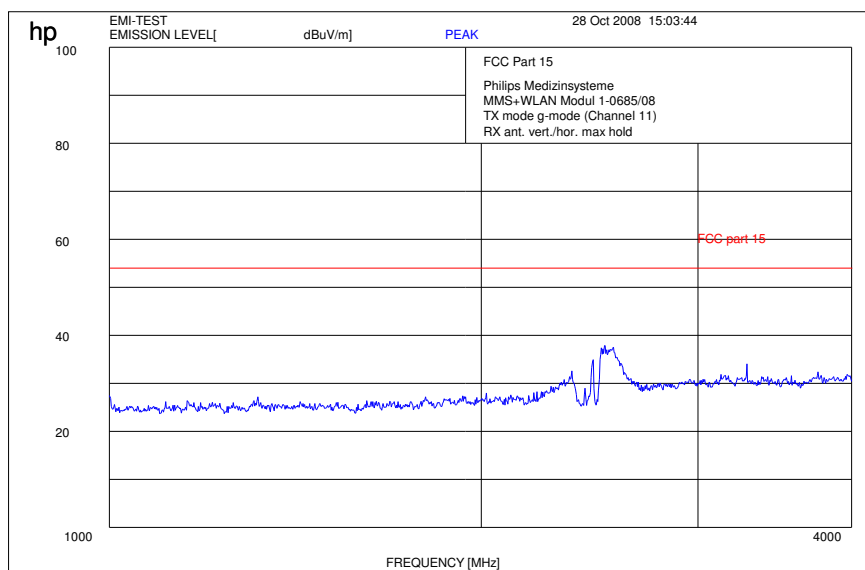

The carrier signal is notched with a 2.4 GHz band rejection filter.

Plot 10: 4 - 12 GHz (highest channel)

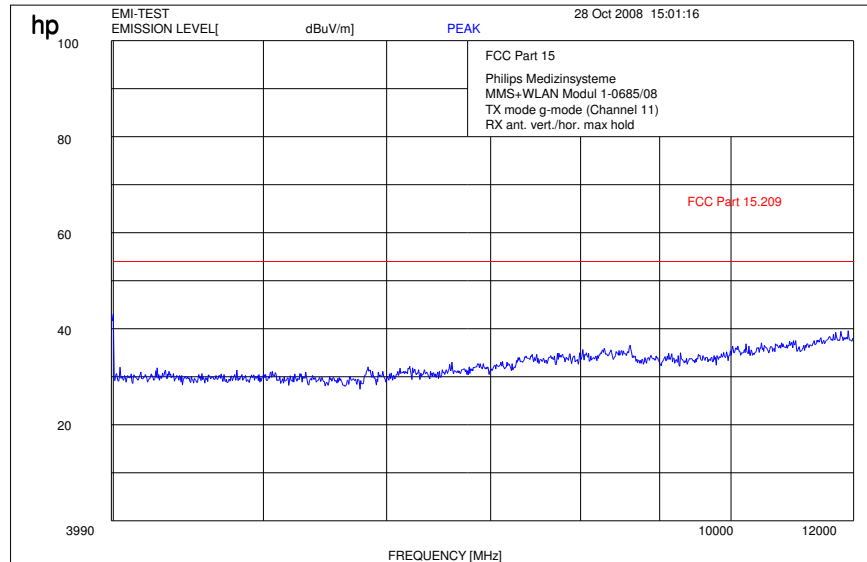

Results:

Spurious Emissions level [dBµV/m]								
2412 MHz			2437 MHz			2462 MHz		
F [MHz]	Detector	Level [dBµV/m]	F [MHz]	Detector	Level [dBµV/m]	F [MHz]	Detector	Level [dBµV/m]
928.66	OP	33.0	928.64	QP	34.5	928.64	QP	34.2
Measurement uncertainty			±3 dB					

f < 1 GHz : RBW/VBW: 100 kHz f ≥ 1GHz : RBW/VBW: 1 MHz

Limits: § 15.247 (c)

In any 100 kHz bandwidth outside the frequency band at least 20dB below the highest level of the desired power. In addition, radiated emissions which fall in the restricted bands, as defined in §15.205(a), must also comply with the radiated emission limits specified in §15.209(a) (see §15.205(c)).

Limits: § 15.109

Frequency (MHz)	Field strength (dBµV/m)	Measurement distance (m)
30 - 88	30.0	10
88 - 216	33.5	10
216 - 960	36.0	10
above 960	54.0	3

5.15 Spurious Emissions - radiated (Receiver) §15.109 / 209

Plot 1: 0.03 - 1 GHz vertical / horizontal (receiver)

Common Information

EUT: Philips Medizin MMS + WLAN a/b/g/ Modul
 Serial Number: Antenna M8100-66490
 Test Description: FCC part 15.247
 Operating Conditions: Wlan Rx Mode
 Operator Name: ZAK
 Comment: Powered with DC 5 V

Scan Setup: FCC_Fin [EMI radiated]

Hardware Setup: Electric Field (NOS)
 Level Unit: dBµV/m

Subrange **Detectors** **IF Bandwidth** **Meas. Time** **Receiver**
 30 MHz - 1 GHz QuasiPeak 120 kHz 15 s Receiver

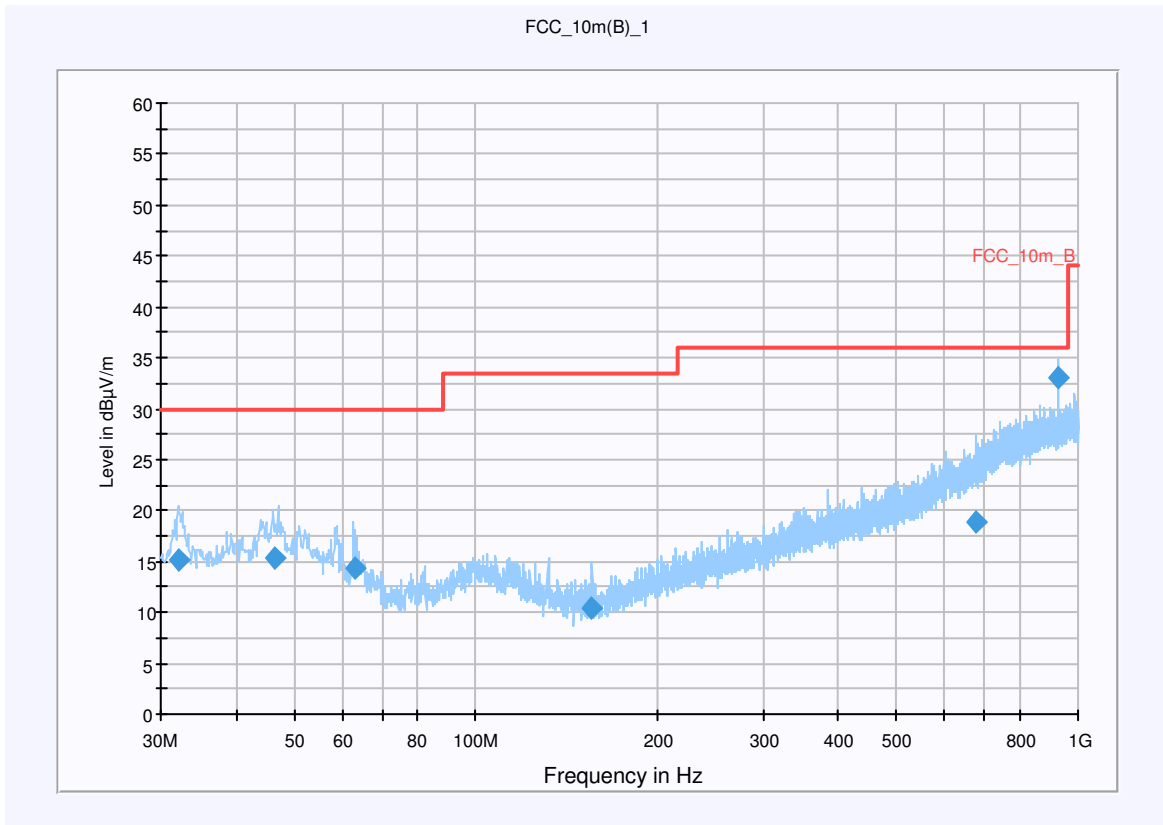

Final Result 1

Frequency (MHz)	QuasiPeak (dBµV/m)	Meas. Time (ms)	Bandwidth (kHz)	Antenna height (cm)	Polarity	Turntable position (deg)	Corr. (dB)	Margin (dB)	Limit (dBµV/m)	Comment
32.087650	15.1	15000.000	120.000	175.0	V	143.0	12.8	14.9	30.0	
46.554550	15.4	15000.000	120.000	183.0	V	220.0	13.5	14.6	30.0	
63.092000	14.3	15000.000	120.000	159.0	V	182.0	11.1	15.7	30.0	
155.920300	10.5	15000.000	120.000	135.0	V	269.0	9.3	23.0	33.5	
675.292250	19.0	15000.000	120.000	400.0	H	168.0	21.9	17.0	36.0	
928.629550	33.0	15000.000	120.000	200.0	V	236.0	25.9	3.0	36.0	

Hardware Setup: EMI radiated\Electric Field (NOS) - [EMI radiated]

Subrange 1	
Frequency Range:	30 MHz - 2 GHz
Receiver:	Receiver [ESCI 3] @ GPIB0 (ADR 20), SN 100083/003, FW 3.32, CAL 07.01.2009
Signal Path:	without Notch FW 1.0
Antenna:	VULB 9163 SN 9163-295, FW ---, CAL 08.04.2010 Correction Table (vertical): VULP6113 Correction Table (horizontal): VULP6113 Correction Table: Cabel with switch (0908)
Antenna Tower:	Tower [EMCO 2090 Antenna Tower] @ GPIB0 (ADR 8), FW REV 3.12
Turntable:	Turntable [EMCO Turntable] @ GPIB0 (ADR 9), FW REV 3.12

Plot 2: 1 - 4 GHz vertical / horizontal (receiver)

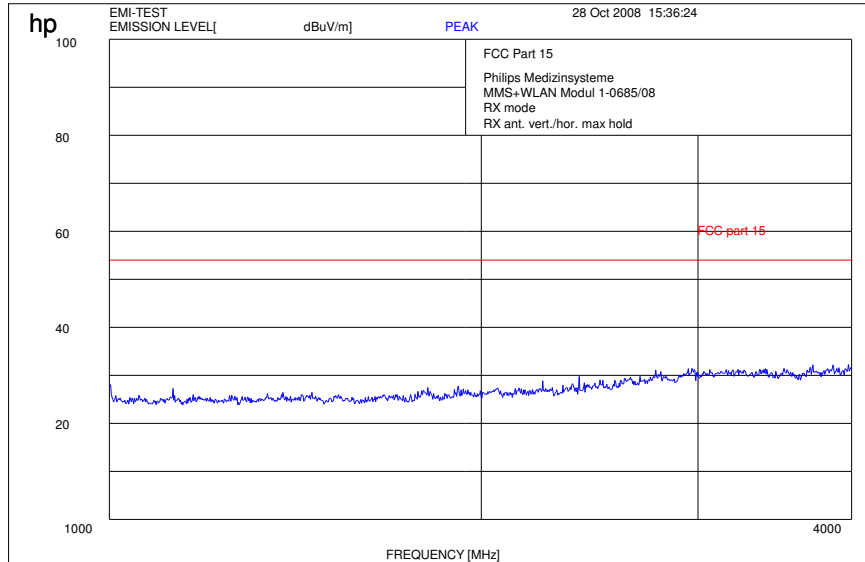

Plot 3: 4 - 12 GHz (receiver)

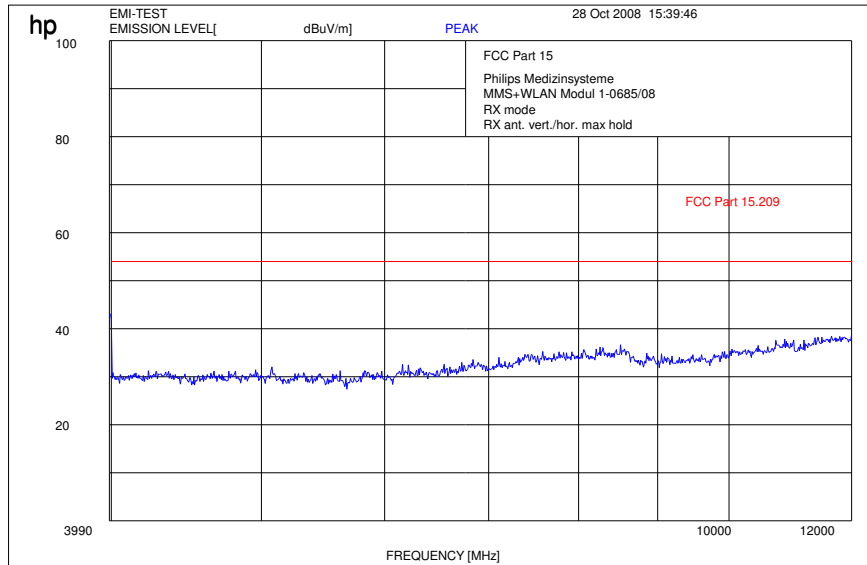

Plot 4: 12 - 25 GHz (receiver)

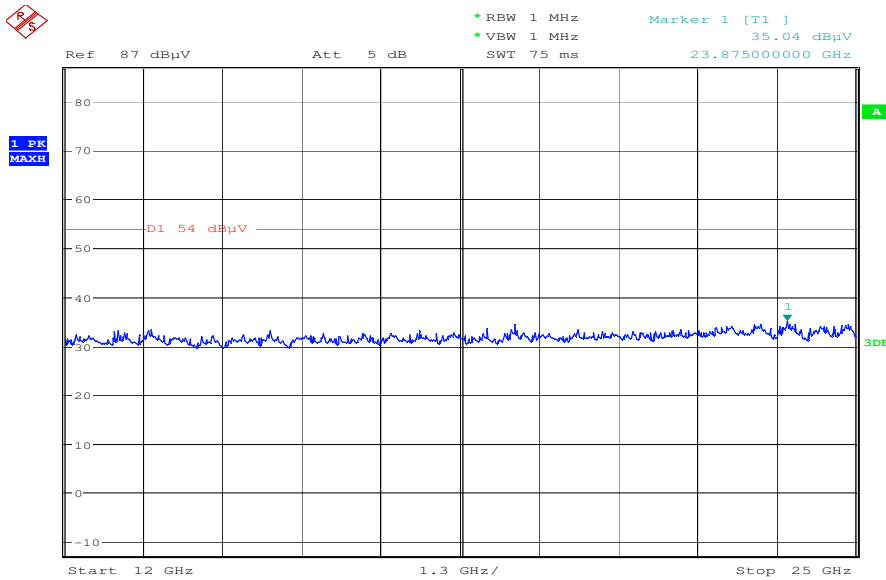

Date: 30.OCT.2008 14:25:33

Results:

Spurious Emissions level [dB μ V/m]		
f[MHz]	Detector	Level [dB μ V/m]
928.63	QP	33.0
Measurement uncertainty		± 3 dB

f < 1 GHz : RBW/VBW: 100 kHz f \geq 1GHz : RBW/VBW: 1 MHz

See above plots

Measurement distance see table

Limits: § 15.109

Frequency (MHz)	Field strength (dB μ V/m)	Measurement distance (m)
30 - 88	30.0	10
88 - 216	33.5	10
216 - 960	36.0	10
above 960	54.0	3

5.16 Spurious Emissions - radiated <30 MHz §15.209

Measured at 3 m distance.

Values recalculated with 40 dB/decade according to FCC rules.

Plot 1: DSSS TX mode

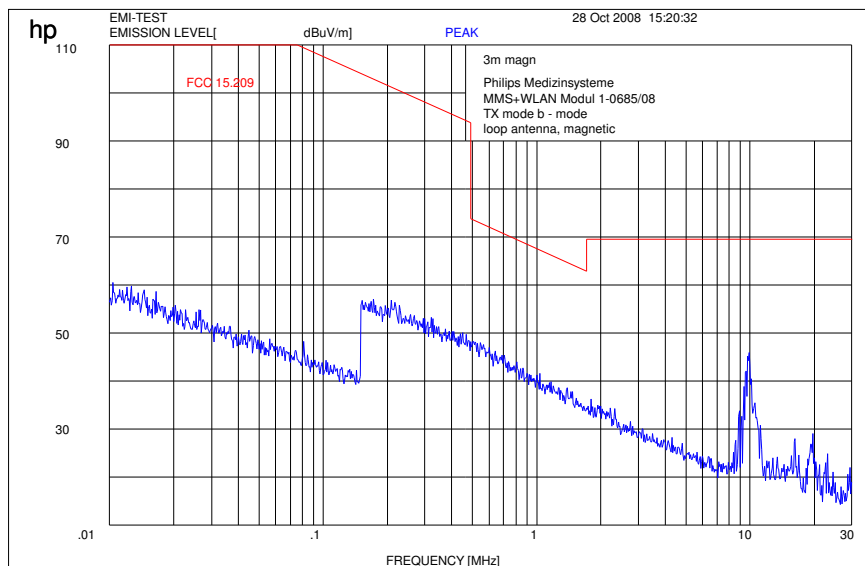

Plot 2: OFDM TX mode

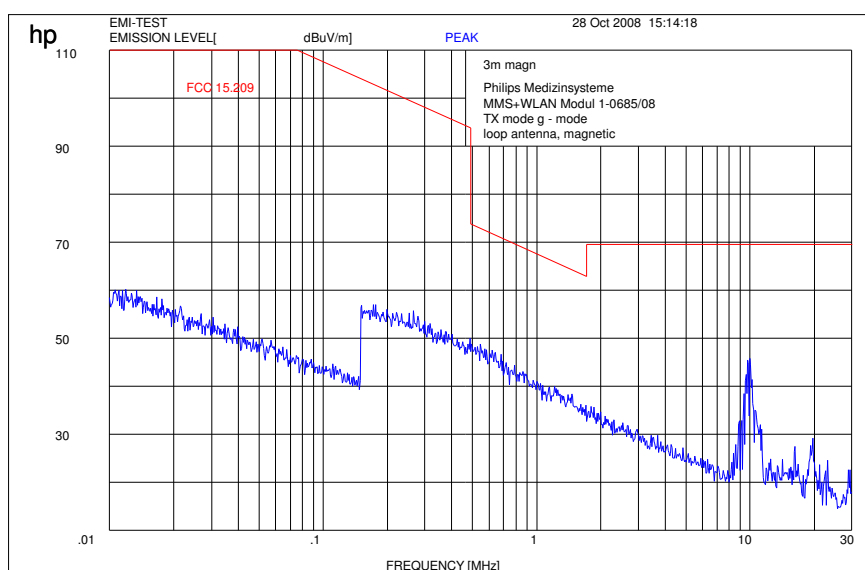

Plot 3: RX mode

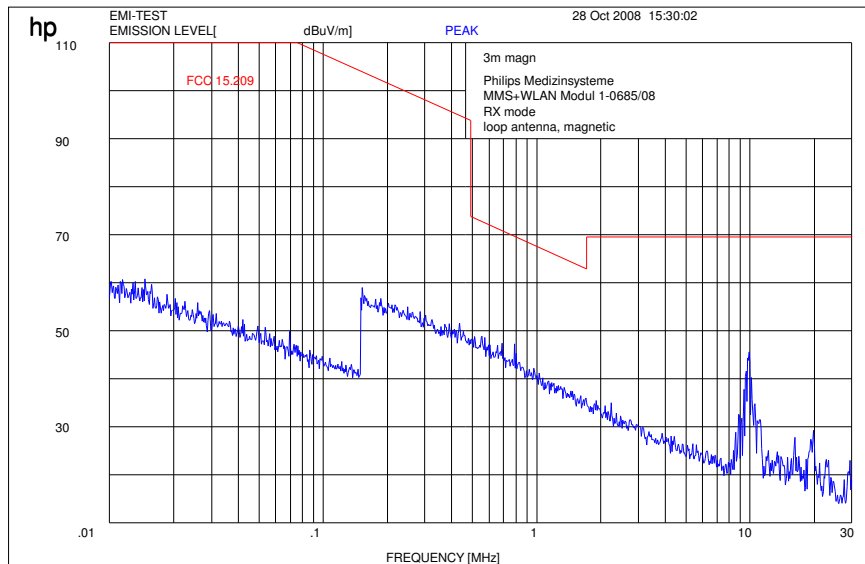

Limits:

Frequency (MHz)	Field strength ($\mu\text{V/m}$)	Measurement distance (m)
0.009 – 0.490	2400/F(kHz)	300
0.490 – 1.705	24000/F(kHz)	30
1.705 – 30.0	30 / 29.5 dB $\mu\text{V/m}$	30
30 - 88	100 / 40 dB $\mu\text{V/m}$	3
88 - 216	150 / 43.5 dB $\mu\text{V/m}$	3
216 - 960	200 / 46 dB $\mu\text{V/m}$	3
above 960	54 dB $\mu\text{V/m}$	3

5.17 Conducted Emissions <30 MHz §15.107/207

Not performed!

Plot 1: Phase line
Plot 2: Neutral line

We measured in TX and RX mode, L1 and N floating and grounded, max value was hold.

Limits:

Under normal test conditions only	See plots
-----------------------------------	-----------

6 Test equipment and ancillaries used for tests

To simplify the identification on each page of the test equipment used, on each page of the test report, each item of test equipment and ancillaries such as cables are identified (numbered) by the Test Laboratory, below.

All reported calibration intervals are calibrations according to the EN/ISO/IEC 17025 standard. These calibrations were performed from an accredited external calibration laboratory.

Additional to these calibrations the laboratory performed comparison measurements with other calibrated systems and performed a weekly chamber inspection.

All used devices are connected with a 10 MHz external reference.

According to the manufacturers' instruction is it possible to establish a calibration interval for the FSP unit of 24 month, if the device has an external 10 MHz reference.

Anechoic chamber C:

No	Equipment/Type	Manuf.	Serial Nr.	Inv. No. Cetecom	Last Calibration	Frequency (months)	Next Calibration
1	Anechoic chamber	MWB	87400/02	300000996	Monthly verification		
2	System-Rack 85900	HP I.V.	*	300000222	n.a.		
3	Measurement System 1						
4	Spektrum Analyzer 8566B	HP	3138A07614	300001207	13.12.2007	24	13.12.2009
5	Spektrum Analyzer Display 85662A	HP	3144A28627	300001208	13.12.2007	24	13.12.2009
6	Quasi-Peak-Adapter 85650A	HP	2811A01204	300002308	13.12.2007	24	13.12.2009
7	RF-Preselector 85685A	HP	2837A00778	300002448	13.12.2007	24	13.12.2009
8	PC Vectra VL	HP		300001688	n.a.		
9	Software EMI	HP		300000983	n.a.		
10	Measurement System 2						
11	FSP 30	R&S	100886	300003575	25.08.2008	24	25.08.2010
12	PC	F+W			n.a.		
13	TILE	TILE			n.a.		
14	Biconical antenna	EMCO	S/N: 860 942/003		Monthly verification (System cal.)		
15	Log. Period. Antenna 3146	EMCO	2130	300001603	Monthly verification (System cal.)		
16	Double Ridged Antenna HP 3115P	EMCO	3088	300001032	Monthly verification (System cal.)		
17	Active Loop Antenna 6502	EMCO	2210	300001015	Monthly verification (System cal.)		
18	Power Supply 6032A	HP	2818A03450	300001040	12.05.2007	36	12.05.2010
19	Busisolator	Kontron		300001056	n.a.		
20	Leitungsteiler 11850C	HP		300000997	Monthly verification (System cal.)		
21	Power attenuator 8325	Byrd	1530	300001595	Monthly verification (System cal.)		
22	Band reject filter WRCG1855/1910	Wainwright	7	300003350	Monthly verification (System cal.)		
23	Band reject filter WRCG2400/2483	Wainwright	11	300003351	Monthly verification (System cal.)		

System Rack Room 005 :

No	Equipment/Type	Manuf.	Serial Nr.	Inv. No. Cetecom	Last Calibration	Frequency (months)	Next Calibration
1	FSP 30	R&S	100886	300003575	25.08.2008	24	25.08.2010
2	CBT	R&S	100313	300003516	03.09.2008	24	03.09.2010
3	Switch Matrix	HP		300000929	n.a.		
4	Power Supply	HP	3041A00544	300002270	13.05.2007	36	13.05.2010
5	Signal Generator	R&S	836206/0092	300002680	30.05.2007	36	30.05.2010

Signalling Units:

No	Equipment/Type	Manuf.	Serial Nr.	Inv. No. Cetecom	Last Calibration	Frequency (months)	Next Calibration
1	CBT	R&S	100313	300003516	03.09.2008	24	03.09.2010
2	CBT	R&S	100185	300003416	27.08.2008	24	27.08.2010
3	CMU-200	R&S	103992	300003231	04.06.2008	12	04.06.2009
4	CMU-200	R&S	106240	300003321	27.08.2008	24	27.08.2010
5	CMU-200	R&S	832221/0055	300002862	20.03.2008	24	20.03.2010

Climatic Box:

No	Equipment/Type	Manuf.	Serial Nr.	Inv. No. Cetecom	Last Calibration	Frequency (months)	Next Calibration
1	Climatic box VT 4002	Heraeus Vötsch	58566046820010	300003019	11.05.2007	24	11.05.2009
2	Climatic box CTS T-40/50	CTS	064023	300003540	03.01.2007	24	03.01.2009

SRD Laboratory Room 002:

No	Equipment/Type	Manuf.	Serial Nr.	Inv. No. Cetecom	Last Calibration	Frequency (months)	Next Calibration
1	System Controller PSM 12	R&S	835259/007	3000002681-00xx	n.a.		
2	Memory Extension PSM-K10	R&S	To 1	3000002681	n.a.		
3	Operating Software PSM-B2	R&S	To 1	3000002681	n.a.		
4	19" Monitor		22759020-ED	3000002681	n.a.		
5	Mouse		LZE 0095/6639	3000002681	n.a.		
6	Keyboard		G00013834L461	3000002681	n.a.		
7	Spectrum Analyser FSIQ 26	R&S	835540/018	3000002681-0005	10.01.2008	24	10.01.2010
8	Tracking Generator FSIQ-B10	R&S	835107/015	3000002681	s.No.7		
10	RF-Generator SMIQ03 (B1 Signal)	R&S	835541/056	3000002681-0002	26.08.2008	36	26.08.2011
11	Modulation Coder SMIQ-B20	R&S	To 10	3000002681	s.No.10		
12	Data Generator SMIQ-B11	R&S	To 10	3000002681	s.No.10		
13	RF Rear Connection SMIQ-B19	R&S	To 10	3000002681	s.No.10		
14	Fast CPU SM-B50	R&S	To 10	3000002681	s.No.10		
15	FM Modulator SM-B5	R&S	835676/033	3000002681	s.No.10		
16	RF-Generator SMIQ03 (B2 Signal)	R&S	835541/055	3000002681-0001	25.08.2008	36	25.08.2011
17	Modulation Coder SMIQ-B20	R&S	To 16	3000002681	s.No.16		
18	Data Generator SMIQ-B11	R&S	To 16	3000002681	s.No.16		
19	RF Rear Connection SMIQ-B19	R&S	To 16	3000002681	s.No.16		
20	Fast CPU SM-B50	R&S	To 16	3000002681	s.No.16		
21	FM Modulator SM-B5	R&S	836061/022	3000002681	s.No.16		
22	RF-Generator SMP03 (B3 Signal)	R&S	835133/011	3000002681-0003	26.08.2008	36	26.08.2011
23	Attenuator SMP-B15	R&S	835136/014	3000002681	S.No.22		
24	RF Rear Connection SMP-B19	R&S	834745/007	3000002681	S.No.22		
25	Power Meter NRVD	R&S	835430/044	3000002681-0004	26.08.2008	24	26.08.2010
26	Power Sensor NRVD-Z1	R&S	833894/012	3000002681-0013	26.08.2008	24	26.08.2010
27	Power Sensor NRVD-Z1	R&S	833894/011	3000002681-0010	26.08.2008	24	26.08.2010
28	Rubidium Standard RUB	R&S		3000002681-0009	27.08.2008	24	27.08.2010
29	Switching and Signal Conditioning Unit SSCU	R&S	338864/003	3000002681-0006	01.08.2006	24	01.08.2008

30	Laser Printer HP Deskjet 2100	HP	N/A	3000002681-0011	n.a.		
31	19" Rack	R&S	11138363000004	3000002681	n.a.		
32	RF-cable set	R&S	N/A	3000002681	n.a.		
33	IEEE-cables	R&S	N/A	3000002681	n.a.		
34	Sampling System FSIQ-B70	R&S	835355/009	3000002681	s.No.7		
35	RSP programmable attenuator	R&S	834500/010	3000002681-0007	26.08.2008	24	26.08.2010
36	Signalling Unit	R&S	838312/011	3000002681	n.a.		
37	NGPE programmable Power Supply for EUT	R&S	192.033.41	3000002681			
39	Power Splitter 6005-3	Inmet Corp.	none	300002841	23.12.2006	24	23.12.2008
40	SMA Cables SPS-1151-985-SPS	Insulated Wire	different	different	n.a.		
41	CBT32 with EDR Signalling Unit	R&S					
42	Coupling unit	Narda	N/A	--	n.a.		
43	2xSwitch Matrix PSU	R&S	872584/021	300001329	n.a.		
44	RF-cable set	R&S	N/A	different	n.a.		
45	IEEE-cables	R&S	N/A	--	n.a.		

Note: 3000002681-00xx inventoried as a system

SRD Laboratory Room 005:

No	Equipment/Type	Manuf.	Serial Nr.	Inv. No. Cetecom	Last Calibration	Frequency (months)	Next Calibration
1	Spektrum Analyzer 8566B	HP	2747A05275	300000219	18.01.2008	24	18.01.2010
2	Spektrum Analyzer Display 85662A	HP	2816A16497	300001690	23.01.2008	24	23.01.2010
3	Quasi-Peak-Adapter 85650A	HP	2811A01135	300000216	23.01.2008	24	23.01.2010
4	Power Supply	Heiden	003202	300001187	12.05.2007	36	12.05.2010
5	Power Supply	Heiden	1701	300001392	12.05.2007	36	12.05.2010

SRD Laboratory Room 011:

No	Equipment/Type	Manuf.	Serial Nr.	Inv. No. Cetecom	Last Calibration	Frequency (months)	Next Calibration
1	NRP Power Meter	R&S	100212	300003780	27.02.2008	24	27.02.2010

Anechoic chamber F:

No	Equipment/Type	Manuf.	Serial Nr.	Inv. No. Cetecom	Last Calibration	Frequency (months)	Next Calibration
1	Control Computer	F+W	FW0502032	300003303	-/-	-/-	-/-
2	Trilog Antenna	9163-295	-/-	-/-	30.04.2008	24	30.04.2010
3	Amplifier - 0518C-138	Veritech Micro-wave Inc.	-/-	-/-	-/-	-/-	-/-
4	Switch - 3488A	HP		300000368	-/-	-/-	-/-
5	EMI Test receiver - ESCI	R&S	100083	300003312	31.01.2007	24	31.01.2009
6	Turntable Controller - 1061 3M	EMCO	1218	300000661	-/-	-/-	-/-
7	Tower Controller 1051 Controller	EMCO	1262	300000625	-/-	-/-	-/-
8	Tower - 1051	EMCO	1262	300000625	-/-	-/-	-/-
10	Ultra Notch-Filter Rejected band Ch. 62	WRCD	9	-/-	-/-	-/-	-/-