

TEST REPORT

Test report no.: 1-2856/16-01-09-B

BNetzA-CAB-02/21-102

Testing laboratory

CTC advanced GmbH

Untertuerkheimer Strasse 6 – 10
66117 Saarbruecken / Germany

Phone: + 49 681 5 98 - 0

Fax: + 49 681 5 98 - 9075

Internet: <http://www.ctcadvanced.com>

e-mail: mail@ctcadvanced.com

Accredited Testing Laboratory:

The testing laboratory (area of testing) is accredited according to DIN EN ISO/IEC 17025 (2005) by the Deutsche Akkreditierungsstelle GmbH (DAkkS)

The accreditation is valid for the scope of testing procedures as stated in the accreditation certificate with the registration number: D-PL-12076-01-03

Applicant

Philips Medizin Systeme Böblingen GmbH

Hewlett-Packard-Strasse 2
71034 Böblingen / GERMANY

Phone: -/-

Fax: +49 7031 463-2944

Contact: Hansjörg Geywitz

e-mail: hansjoerg.geywitz@philips.com

Phone: +49 7031 463-1879

Manufacturer

Philips Medizin Systeme Böblingen GmbH

Hewlett-Packard-Strasse 2
71034 Böblingen / GERMANY

Test standard/s

47 CFR Part 95 Personal radio services – medical device Radiocommunication service (MedRadio)

For further applied test standards please refer to section 3 of this test report.

Test Item

Kind of test item: **Range Extender for SRR measurements via WLAN**

Model name: **IntelliVue CL Transmitter 865221**

FCC ID: **PQC-TRNSBV1**

Frequency: MBAN bands:
2360 MHz to 2390 MHz & 2390 MHz to 2400 MHz

Technology tested: MBAN

Antenna: Integrated chip antenna

Power supply: 3.7 V DC by Li - Ion battery

Temperature range: -20°C to +55°C



This test report is electronically signed and valid without handwriting signature. For verification of the electronic signatures, the public keys can be requested at the testing laboratory.

Test report authorized:

p.o.
Marco Bertolino
Lab Manager
Radio Communications & EMC

Test performed:

Mihail Dorongovskij
Lab Manager
Radio Communications & EMC

1 Table of contents

1	Table of contents.....	2
2	General information	3
2.1	Notes and disclaimer	3
2.2	Application details	3
3	Test standard/s and references.....	3
4	Test environment	4
5	Test item	4
5.1	General description.....	4
5.2	Additional information	4
6	Test laboratories sub-contracted	4
7	Description of the test setup	5
7.1	Shielded semi anechoic chamber	6
7.2	Shielded fully anechoic chamber	7
7.3	Radiated measurements > 18 GHz	8
7.4	Conducted measurements C.BER system	9
7.5	Test setup for the timing behavior	10
7.6	Shielded fully anechoic chamber	11
8	Sequence of testing	12
8.1	Sequence of testing radiated spurious 9 kHz to 30 MHz	12
8.2	Sequence of testing radiated spurious 30 MHz to 1 GHz	13
8.3	Sequence of testing radiated spurious 1 GHz to 18 GHz	14
8.4	Sequence of testing radiated spurious above 18 GHz	15
9	Measurement uncertainty.....	16
10	Summary of measurement results.....	17
11	Additional comments.....	18
12	Measurement results	23
12.1	Frequency stability	23
12.2	Emission bandwidth	29
12.3	Maximum transmit power	37
12.4	Band edge measurement.....	50
12.5	Transmitter unwanted radiation (radiated).....	54
12.6	Receiver unwanted radiation (radiated).....	90
12.7	Connection interrupt test (body-worn sensor).....	96
13	Observations	101
Annex A	Glossary	102
Annex B	Document history	103
Annex C	Accreditation Certificate	103

2 General information

2.1 Notes and disclaimer

The test results of this test report relate exclusively to the test item specified in this test report. CTC advanced GmbH does not assume responsibility for any conclusions and generalizations drawn from the test results with regard to other specimens or samples of the type of the equipment represented by the test item.

The test report may only be reproduced or published in full. Reproduction or publication of extracts from the report requires the prior written approval of CTC advanced GmbH.

The testing service provided by CTC advanced GmbH has been rendered under the current "General Terms and Conditions for CTC advanced GmbH".

CTC advanced GmbH will not be liable for any loss or damage resulting from false, inaccurate, inappropriate or incomplete product information provided by the customer.

Under no circumstances does the CTC advanced GmbH test report include any endorsement or warranty regarding the functionality, quality or performance of any other product or service provided.

Under no circumstances does the CTC advanced GmbH test report include or imply any product or service warranties from CTC advanced GmbH, including, without limitation, any implied warranties of merchantability, fitness for purpose, or non-infringement, all of which are expressly disclaimed by CTC advanced GmbH.

All rights and remedies regarding vendor's products and services for which CTC advanced GmbH has prepared this test report shall be provided by the party offering such products or services and not by CTC advanced GmbH. In no case this test report can be considered as a Letter of Approval.

This test report is electronically signed and valid without handwritten signature. For verification of the electronic signatures, the public keys can be requested at the testing laboratory.

This test report replaces the test report with the number 1-2856/16-01-09-A and dated 2017-11-27.

2.2 Application details

Date of receipt of order:	2016-11-14
Date of receipt of test item:	2017-06-19
Start of test:	2017-06-21
End of test:	2017-11-15
Person(s) present during the test:	-/-

3 Test standard/s and references

Test standard	Date	Description
47 CFR Part 95	May-14-2009	Personal radio services – medical device Radiocommunication service (MedRadio)

Guidance	Version	Description
ANSI C63.4-2014	-/-	American national standard for methods of measurement of radio-noise emissions from low-voltage electrical and electronic equipment in the range of 9 kHz to 40 GHz
KDB 550599 D01 v01r01	December-08-2017	Medical body area network (MBAN) measurement procedures

4 Test environment

Temperature	:	T _{nom} T _{max} T _{min}	+22 °C during room temperature tests +55 °C during high temperature tests 0 °C during low temperature tests
Relative humidity content	:		55 %
Barometric pressure	:		not relevant for this kind of testing
Power supply	:	V _{nom} V _{max} V _{min}	3.7 V DC by Li - Ion battery No tests under extreme voltage conditions required. No tests under extreme voltage conditions required.

5 Test item

5.1 General description

Kind of test item	:	Range Extender for SRR measurements via WLAN
Type identification	:	IntelliVue CL Transmitter 865221
S/N serial number	:	Radiated unit: DE024V0710
HW hardware status	:	1642
SW software status	:	D.00.42
Frequency band	:	MBAN bands: 2360 MHz to 2390 MHz & 2390 MHz to 2400 MHz (lowest channel 2363 MHz, highest channel 2397 MHz)
Type of radio transmission	:	modulated carrier, DSSS
Use of frequency spectrum	:	
Type of modulation	:	OQPSK
Number of channels	:	15
Antenna	:	Integrated chip antenna
Power supply	:	3.7 V DC by Li - Ion battery
Temperature range	:	-20°C to +55°C

5.2 Additional information

The content of the following annexes is defined in the QA. It may be that not all of the listed annexes are necessary for this report, thus some values in between may be missing.

Test setup- and EUT-photos are included in test report:

- 1-2856/16-01-01_AnnexA
- 1-2856/16-01-01_AnnexB
- 1-2856/16-01-01_AnnexD

6 Test laboratories sub-contracted

None

7 Description of the test setup

Typically, the calibrations of the test apparatus are commissioned to and performed by an accredited calibration laboratory. The calibration intervals are determined in accordance with the DIN EN ISO/IEC 17025. In addition to the external calibrations, the laboratory executes comparison measurements with other calibrated test systems or effective verifications. Weekly chamber inspections and range calibrations are performed. Where possible, RF generating and signaling equipment as well as measuring receivers and analyzers are connected to an external high-precision 10 MHz reference (GPS-based or rubidium frequency standard).

In order to simplify the identification of the equipment used at some special tests, some items of test equipment and ancillaries can be provided with an identifier or number in the equipment list below (Lab/Item).

Agenda: Kind of Calibration

k	calibration / calibrated	EK	limited calibration
ne	not required (k, ev, izw, zw not required)	zw	cyclical maintenance (external cyclical maintenance)
ev	periodic self verification	izw	internal cyclical maintenance
Ve	long-term stability recognized	g	blocked for accredited testing
vkl!	Attention: extended calibration interval		
NK!	Attention: not calibrated	*)	next calibration ordered / currently in progress

7.1 Shielded semi anechoic chamber

The radiated measurements are performed in vertical and horizontal plane in the frequency range from 9 kHz to 1 GHz in semi-anechoic chambers. The EUT is positioned on a non-conductive support with a height of 0.80 m above a conductive ground plane that covers the whole chamber. The receiving antennas are confirmed with specifications ANSI C63. These antennas can be moved over the height range between 1.0 m and 4.0 m in order to search for maximum field strength emitted from EUT. The measurement distances between EUT and receiving antennas are indicated in the test setups for the various frequency ranges. For each measurement, the EUT is rotated in all three axes until the maximum field strength is received. The wanted and unwanted emissions are received by spectrum analyzers where the detector modes and resolution bandwidths over various frequency ranges are set according to requirement ANSI C63.

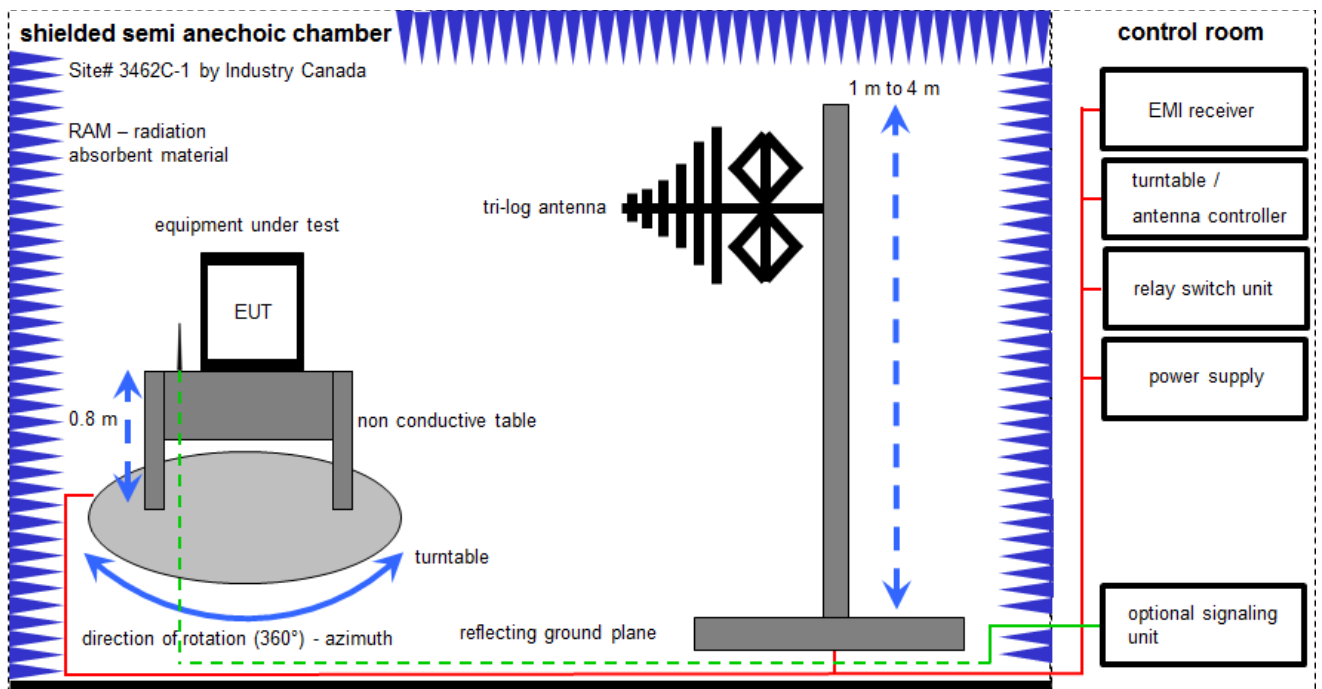

Measurement distance: tri-log antenna 10 meter

$$FS = UR + CL + AF$$

(FS-field strength; UR-voltage at the receiver; CL-loss of the cable; AF-antenna factor)

Example calculation:

$$FS [dB\mu V/m] = 12.35 [dB\mu V/m] + 1.90 [dB] + 16.80 [dB/m] = 31.05 [dB\mu V/m] (35.69 \mu V/m)$$

Equipment table:

No.	Lab / Item	Equipment	Type	Manufacturer	Serial No.	INV. No.	Kind of Calibration	Last Calibration	Next Calibration
1	A	Switch-Unit	3488A	HP	2719A14505	300000368	ev	-/-	-/-
2	A	EMI Test Receiver	ESCI 3	R&S	100083	300003312	k	08.03.2016 01.02.2017	08.03.2017 31.01.2018
3	A	Antenna Tower	Model 2175	ETS-Lindgren	64762	300003745	izw	-/-	-/-
4	A	Positioning Controller	Model 2090	ETS-Lindgren	64672	300003746	izw	-/-	-/-
5	A	Turntable Interface-Box	Model 105637	ETS-Lindgren	44583	300003747	izw	-/-	-/-
6	A	TRILOG Broadband Test-Antenna 30 MHz - 3 GHz	VULB9163	Schwarzbeck	295	300003787	k	25.04.2016	25.04.2018

7.2 Shielded fully anechoic chamber

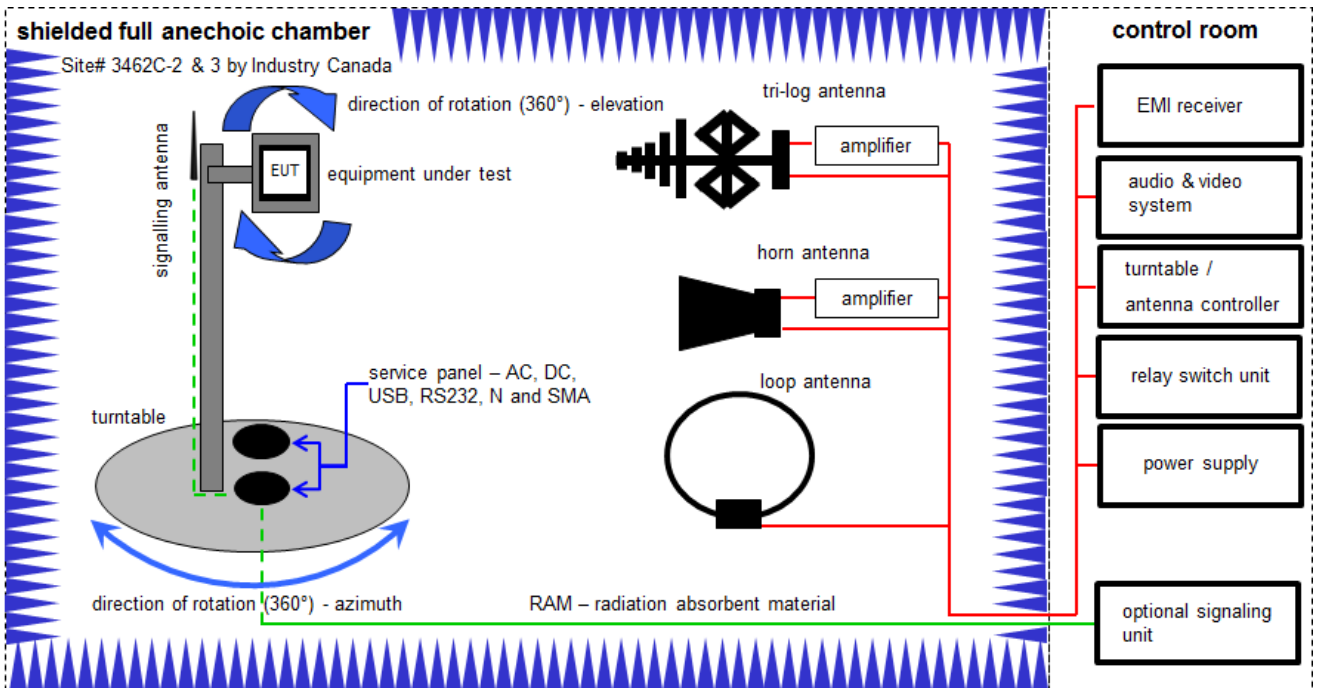

Measurement distance: tri-log antenna and horn antenna 3 meter; loop antenna 3 meter

$$FS = UR + CA + AF$$

(FS-field strength; UR-voltage at the receiver; CA-loss of the signal path; AF-antenna factor)

Example calculation:

$$FS [dB\mu V/m] = 40.0 [dB\mu V/m] + (-35.8) [dB] + 32.9 [dB/m] = 37.1 [dB\mu V/m] (71.61 \mu V/m)$$

Equipment table:

No.	Lab / Item	Equipment	Type	Manufacturer	Serial No.	INV. No.	Kind of Calibration	Last Calibration	Next Calibration
1	A	Double-Ridged Wav eguide Horn Antenna 1-18.0GHz	3115	EMCO	8812-3088	300001032	v IKI!	20.05.2015	20.05.2017
								14.02.2017	13.02.2019
2	A, B	Anechoic chamber	FAC 3/5m	MWB / TDK	87400/02	300000996	ev	-/-	-/-
3	A, B	Switch / Control Unit	3488A	HP		300000199	ne	-/-	-/-
4	B	Active Loop Antenna 10 kHz to 30 MHz	6502	EMCO/2	8905-2342	300000256	k	24.06.2015	24.06.2017
5	B	Active Loop Antenna 9 kHz to 30 MHz	6502	EMCO	2210	300001015	k	07.07.2017	06.07.2019
6	A	Amplifier	js42-00502650-28-5a	Parzich GMBH	928979	300003143	ne	-/-	-/-
7	A	Band Reject filter	WRCG2400/2483-2375/2505-50/10SS	Wainwright	11	300003351	ev	-/-	-/-
8	A	Highpass Filter	WHKX7.0/18G-8SS	Wainwright	18	300003789	ne	-/-	-/-
9	A	TRIALOG Broadband Test-Antenna 30 MHz - 3 GHz	VULB9163	Schwarzbeck	371	300003854	v IKI!	29.10.2014	29.10.2017
10	A, B	4U RF Switch Platform	L4491A	Agilent Technologies	MY50000037	300004509	ne	-/-	-/-
11	A, B	EMI Test Receiver 9kHz-26,5GHz	ESR26	R&S	101376	300005063	v IKI!	13.09.2016	13.03.2018

7.3 Radiated measurements > 18 GHz

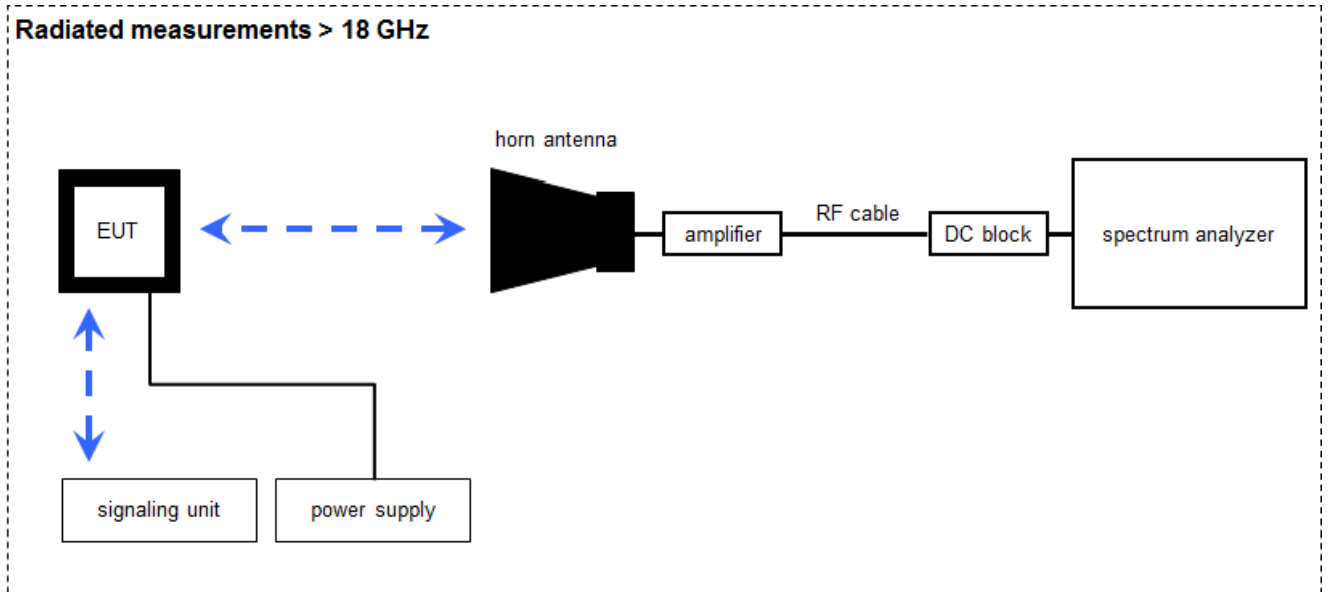

Measurement distance: horn antenna 50 cm

$$FS = UR + CA + AF$$

(FS-field strength; UR-voltage at the receiver; CA-loss signal path & distance correction; AF-antenna factor)

Example calculation:

$$FS [dB\mu V/m] = 40.0 [dB\mu V/m] + (-60.1) [dB] + 36.74 [dB/m] = 16.64 [dB\mu V/m] (6.79 \mu V/m)$$

Equipment table:

No.	Lab / Item	Equipment	Type	Manufacturer	Serial No.	INV. No.	Kind of Calibration	Last Calibration	Next Calibration
1	A	Amplifier 2-40 GHz	JS32-02004000-57-5P	MITEQ	1777200	300004541	ev	-/-	-/-
2	A	RF-Cable	ST18/SMAm/SMAm/48	Huber & Suhner	Batch no. 600918	400001182	ev	-/-	-/-
3	A	RF-Cable	ST18/SMAm/SMm/48	Huber & Suhner	Batch no. 127377	400001183	ev	-/-	-/-
4	A	DC-Blocker 0.1-40 GHz	8141A	Inmet	Batch no. 127377	400001185	ev	-/-	-/-
5	A	Std. Gain Horn Antenna 18.0 to 26.5 GHz	638	Narda	-/-	300000486	k	10.09.2015	10.09.2017
6	A	Signal Analyzer 40 GHz	FSV40	R&S	101042	300004517	k	21.01.2016 25.01.2017	21.01.2017 24.01.2018

7.4 Conducted measurements C.BER system

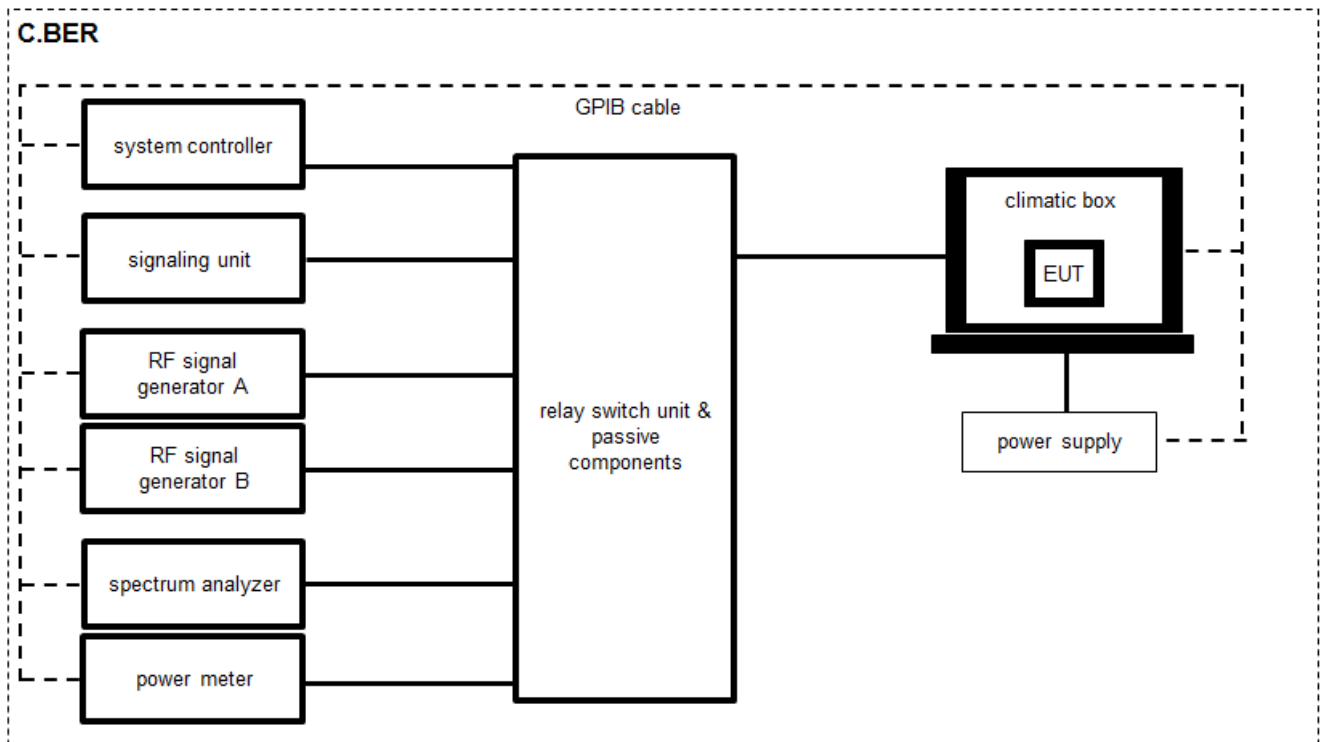

OP = AV + CA
(OP-output power; AV-analyzer value; CA-loss signal path)

Example calculation:

OP [dBm] = 6.0 [dBm] + 11.7 [dB] = 17.7 [dBm] (58.88 mW)

Equipment table:

No.	Lab / Item	Equipment	Type	Manufacturer	Serial No.	INV. No.	Kind of Calibration	Last Calibration	Next Calibration
1	A, B	Switch / Control Unit	3488A	HP	-/-	300001691	ne	-/-	-/-
2	A, B	Power Supply DC	NGPE 40/40	R&S	388	400000078	v IKI!	22.01.2015 31.01.2017	22.01.2017 30.01.2020
3	A, B	Signal Analyzer 20Hz-26,5GHz-150 to + 30 DBM	FSIQ26	R&S	835540/018	300002681	k	28.01.2016	28.01.2018
4	A, B	Frequency Standard (Rubidium Frequency Standard)	MFS (Rubidium)	R&S (Datum)	002	300002681	Ve	29.01.2015 27.01.2017	29.01.2017 26.01.2019
5	A,	Directional Coupler	101020010	Krytar	70215	300002840	ev	-/-	-/-
6	A, B	DC-Blocker	8143	Inmet Corp.	none	300002842	ne	-/-	-/-
7	A, B	Powersplitter	6005-3	Inmet Corp.	none	300002841	ev	-/-	-/-
8	A, B	USB/GPIB interface	82357B	Agilent Technologies	MY 52103346	300004390	ne	-/-	-/-
9	A, B	Messplatzrechner	Tecline	F+W	102585	300003580	ne	-/-	-/-
10	A, B	RF-Cable	ST18/SMAm/SMAm/72	Huber & Suhner	Batch no. 605505	400001187	ev	-/-	-/-
11	A, B	RF-Cable	Sucoflex 104	Huber & Suhner	147636/4	400001188	ev	-/-	-/-
12	A, B	RF-Cable	ST18/SMAm/SMAm/48	Huber & Suhner	Batch no. 699866	400001189	ev	-/-	-/-
13	A, B	RF-Cable	ST18/SMAm/SMAm/48	Huber & Suhner	Batch no. 14844	400001190	ev	-/-	-/-
14	B	Temperature Test Chamber	VT 4002	Heraeus Voetsch	58566046820010	300003019	ev	03.09.2015	03.09.2017
15	A	Signal Analyzer 30GHz	FSV30	R&S	103170	300004855	k	30.01.2017	29.01.2019

7.5 Test setup for the timing behavior

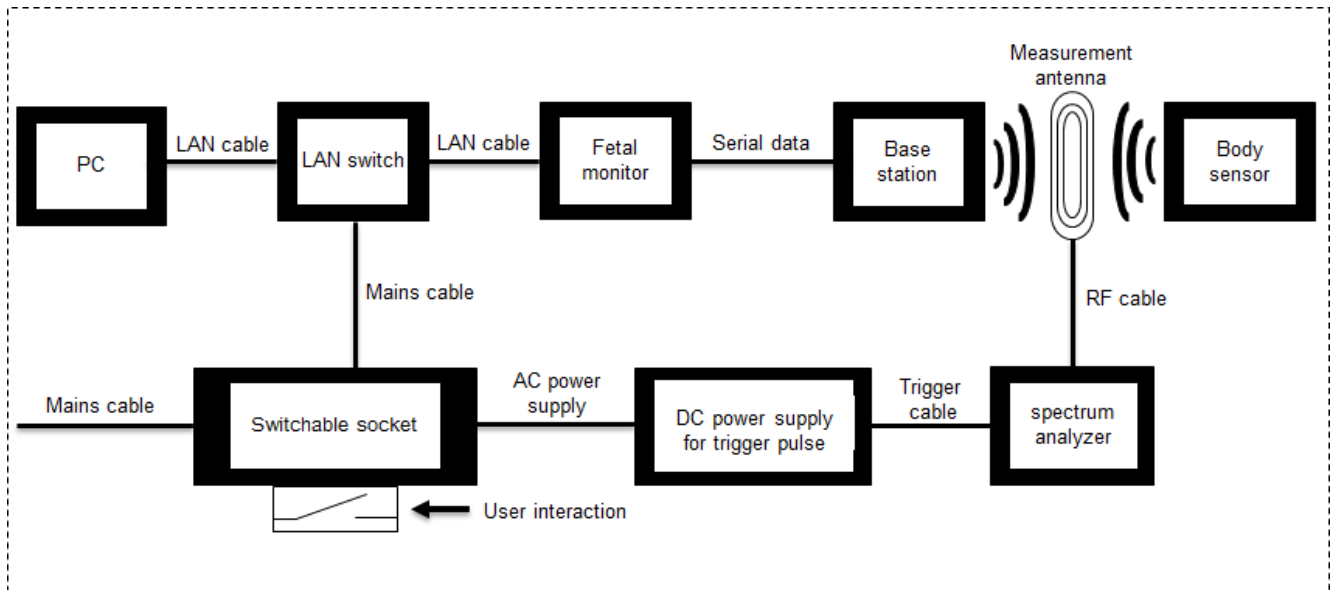

Equipment table:

No.	Lab / Item	Equipment	Type	Manufacturer	Serial No.	INV. No.	Kind of Calibration	Last Calibration	Next Calibration
1	A	Antenna	-/-	-/-	-/-	-/-	ne	-/-	-/-
2	A	Switchable socket	-/-	-/-	-/-	-/-	ne	-/-	-/-
3	A	Switch	-/-	-/-	-/-	-/-	ne	-/-	-/-
4	A	PC	Elitebock 480	hp	CNU416B860	Customer provided	ne	-/-	-/-
5	A	Power supply	EA-PS 3032-65	Elektro Automatik	-/-	300002318	ne	-/-	-/-
6	A	Spectrum analyser	FSV30	R&S	100763	300003950	k	31.01.2017	30.01.2018

7.6 Shielded fully anechoic chamber

OTA – over the air performance

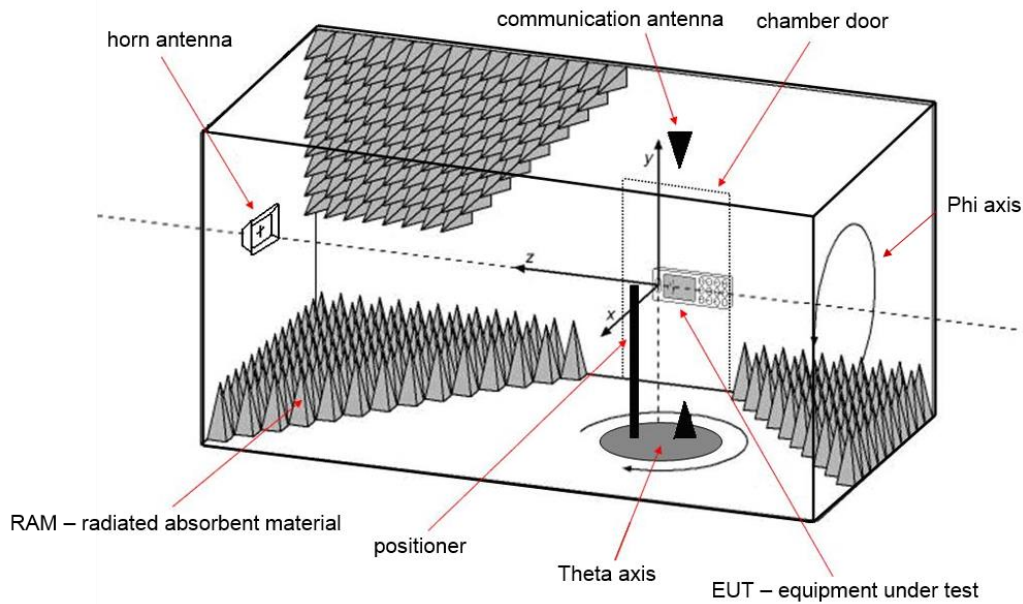

Equipment table:

No.	Lab / Item	Equipment	Type	Manufacturer	Serial No.	INV. No.	Kind of Calibration	Last Calibration	Next Calibration
1	A	Splitter	15542	Mini Circuits	15542	400000086	ev	-/-	-/-
2	A	Splitter	42000	Anaren	4730	400000085	ev	-/-	-/-
3	A	Switch Unit	TS-RSP	R&S	100155	300003281	ev	-/-	-/-
4	A	CTIA-Chamber	CTIA-Chamber AMS 8500	ETS-Lindgren Finland	-/-	300003327	ne	-/-	-/-
5	A	CTIA-Chamber - Positioning Equipment	CTIA-Chamber - Positioning Equipment	EMCO/2	-/-	300003328	ne	-/-	-/-
6	A	CTIA-Chamber - Software	CTIA-Chamber - Software	EMCO/2	-/-	300003328	ne	-/-	-/-
7	A	CTIA-Chamber - Antenna	3164-04	EMCO/2	00041915	300003328	ne	-/-	-/-
8	A	Spectrum Analy zer 9kHz - 30 GHz	FSP30	R&S	100623	300003464	v IKI!	01.02.2017	31.01.2019
9	A	Hygro-Thermometer	5-45 C, 20-100 rF	Thies Clima	-/-	400000089	ev	-/-	-/-

8 Sequence of testing

8.1 Sequence of testing radiated spurious 9 kHz to 30 MHz

Setup

- The equipment is set up to simulate normal operation mode as described in the user manual or defined by the manufacturer.
- If the EUT is a tabletop system, it is placed on a table with 0.8 m height.
- If the EUT is a floor standing device, it is placed directly on the turn table.
- Auxiliary equipment and cables are positioned to simulate normal operation conditions as described in ANSI C 63.4.
- The AC power port of the EUT (if available) is connected to a power outlet below the turntable.
- Measurement distance is 3 m (see ANSI C 63.4) – see test details.
- EUT is set into operation.

Premeasurement*

- The turntable rotates from 0° to 315° using 45° steps.
- The antenna height is 1 m.
- At each turntable position the analyzer sweeps with positive-peak detector to find the maximum of all emissions.

Final measurement

- Identified emissions during the pre-measurement are maximized by the software by rotating the turntable from 0° to 360°.
- Loop antenna is rotated about its vertical axis for maximum response at each azimuth about the EUT. (For certain applications, the loop antenna plane may also need to be positioned horizontally at the specified distance from the EUT)
- The final measurement is done in the position (turntable and elevation) causing the highest emissions with quasi-peak (as described in ANSI C 63.4).
- Final levels, frequency, measuring time, bandwidth, turntable position, correction factor, margin to the limit and limit will be recorded. A plot with the graph of the premeasurement and the limit is stored.

*)Note: The sequence will be repeated three times with different EUT orientations.

8.2 Sequence of testing radiated spurious 30 MHz to 1 GHz

Setup

- The equipment is set up to simulate normal operation mode as described in the user manual or defined by the manufacturer.
- If the EUT is a tabletop system, a table with 0.8 m height is used, which is placed on the ground plane.
- If the EUT is a floor standing device, it is placed on the ground plane with insulation between both.
- Auxiliary equipment and cables are positioned to simulate normal operation conditions as described in ANSI C 63.4.
- The AC power port of the EUT (if available) is connected to a power outlet below the turntable.
- Measurement distance is 10 m or 3 m (see ANSI C 63.4) – see test details.
- EUT is set into operation.

Premeasurement

- The turntable rotates from 0° to 315° using 45° steps.
- The antenna is polarized vertical and horizontal.
- The antenna height changes from 1 m to 3 m.
- At each turntable position, antenna polarization and height the analyzer sweeps three times in peak to find the maximum of all emissions.

Final measurement

- The final measurement is performed for at least six highest peaks according to the requirements of the ANSI C63.4.
- Based on antenna and turntable positions at which the peak values are measured the software maximize the peaks by changing turntable position $\pm 45^\circ$ and antenna height between 1 and 4 m.
- The final measurement is done with quasi-peak detector (as described in ANSI C 63.4).
- Final levels, frequency, measuring time, bandwidth, antenna height, antenna polarization, turntable angle, correction factor, margin to the limit and limit are recorded. A plot with the graph of the premeasurement with marked maximum final results and the limit is stored.

8.3 Sequence of testing radiated spurious 1 GHz to 18 GHz

Setup

- The equipment is set up to simulate normal operation mode as described in the user manual or defined by the manufacturer.
- If the EUT is a tabletop system, a 2-axis positioner with 1.5 m height is used.
- If the EUT is a floor standing device, it is placed directly on the turn table.
- Auxiliary equipment and cables are positioned to simulate normal operation conditions as described in ANSI C 63.4.
- The AC power port of the EUT (if available) is connected to a power outlet below the turntable.
- Measurement distance is 3 m (see ANSI C 63.4) – see test details.
- EUT is set into operation.

Premeasurement

- The turntable rotates from 0° to 315° using 45° steps.
- The antenna is polarized vertical and horizontal.
- The antenna height is 1.5 m.
- At each turntable position and antenna polarization the analyzer sweeps with positive peak detector to find the maximum of all emissions.

Final measurement

- The final measurement is performed for at least six highest peaks according to the requirements of the ANSI C63.4.
- Based on antenna and turntable positions at which the peak values are measured the software maximizes the peaks by rotating the turntable from 0° to 360°. This measurement is repeated for different EUT-table positions (0° to 150° in 30°-steps) and for both antenna polarizations.
- The final measurement is done in the position (turntable, EUT-table and antenna polarization) causing the highest emissions with Peak and RMS detector (as described in ANSI C 63.4).
- Final levels, frequency, measuring time, bandwidth, turntable position, EUT-table position, antenna polarization, correction factor, margin to the limit and limit are recorded. A plot with the graph of the premeasurement with marked maximum final results and the limit is stored.

8.4 Sequence of testing radiated spurious above 18 GHz

Setup

- The equipment is set up to simulate normal operation mode as described in the user manual or defined by the manufacturer.
- Auxiliary equipment and cables are positioned to simulate normal operation conditions as described in ANSI C 63.4.
- The AC power port of the EUT (if available) is connected to a power outlet.
- The measurement distance is as appropriate (e.g. 0.5 m).
- The EUT is set into operation.

Premeasurement

- The test antenna is handheld and moved carefully over the EUT to cover the EUT's whole sphere and different polarizations of the antenna.

Final measurement

- The final measurement is performed at the position and antenna orientation causing the highest emissions with Peak and RMS detector (as described in ANSI C 63.4).
- Final levels, frequency, measuring time, bandwidth, correction factor, margin to the limit and limit are recorded. A plot with the graph of the premeasurement and the limit is stored.

9 Measurement uncertainty

Measurement uncertainty	
Test case	Uncertainty
Frequency stability	± 100 Hz
Emission bandwidth	± 21.5 kHz absolute; ± 15.0 kHz relative
Maximum output power	± 1 dB
Band edge	± 3 dB
Spurious emissions radiated 30 MHz to 1 GHz	± 3 dB
Spurious emissions radiated 1 GHz to 12.75 GHz	± 3.7 dB
Spurious emissions radiated above 12.75 GHz	± 4.5 dB
Spurious emissions conducted below 30 MHz (AC conducted)	± 2.6 dB

10 Summary of measurement results

<input checked="" type="checkbox"/>	No deviations from the technical specifications were ascertained
<input type="checkbox"/>	There were deviations from the technical specifications ascertained
<input type="checkbox"/>	This test report is only a partial test report. The content and verdict of the performed test cases are listed below.

TC Identifier	Description	Verdict	Date	Remark
RF-Testing	47 CFR Part 2 47 CFR Part 95 H	See table	2018-02-28	-/-

Test Specification Clause	Test Case	Temperature Conditions	Power Source Voltages	C	NC	NA	NP	Remark
FCC 47 CFR § 95.2565(b)	Frequency stability	Nominal and extreme	Nominal	<input checked="" type="checkbox"/>	<input type="checkbox"/>	<input type="checkbox"/>	<input type="checkbox"/>	Added from report 1-2773/16-01-02
FCC 47 CFR § 95.2573(e)	Emission bandwidth	Nominal	Nominal	<input checked="" type="checkbox"/>	<input type="checkbox"/>	<input type="checkbox"/>	<input type="checkbox"/>	-/-
FCC 47 CFR § 95.2567(e) and (f)	Maximum transmit power	Nominal	Nominal	<input checked="" type="checkbox"/>	<input type="checkbox"/>	<input type="checkbox"/>	<input type="checkbox"/>	-/-
FCC 47 CFR § 95.2579(a)(5) and (f)	Band edge measurements	Nominal	Nominal	<input checked="" type="checkbox"/>	<input type="checkbox"/>	<input type="checkbox"/>	<input type="checkbox"/>	-/-
FCC 47 CFR § 95.2579(a)(5) and (f)	Transmitter unwanted radiation	Nominal	Nominal	<input checked="" type="checkbox"/>	<input type="checkbox"/>	<input type="checkbox"/>	<input type="checkbox"/>	-/-
FCC 47 CFR § 95.2579(a)(5) and (f)	Receiver spurious emissions (radiated)	Nominal	Nominal	<input checked="" type="checkbox"/>	<input type="checkbox"/>	<input type="checkbox"/>	<input type="checkbox"/>	-/-
FCC 47 CFR § 15.107(a) § 15.207	Conducted emissions below 30 MHz (AC conducted)	Nominal	Nominal	<input type="checkbox"/>	<input type="checkbox"/>	<input checked="" type="checkbox"/>	<input type="checkbox"/>	Battery operated
550599 D01 Medical Body Area Network v01 § 95.2559 (f)	Connection interrupt test	Nominal	Nominal	<input checked="" type="checkbox"/>	<input type="checkbox"/>	<input type="checkbox"/>	<input type="checkbox"/>	Added from report 1-9941/15-01-06-C

Notes:

C	Compliant	NC	Not compliant	NA	Not applicable	NP	Not performed
----------	-----------	-----------	---------------	-----------	----------------	-----------	---------------

11 Additional comments

Reference documents: Customer_Questionnaire_1-3558_17-01_CL_Wide_Range_Pod.docx

Connection interrupt test: **1-9941/15-01-06-C**
(Avalon CL fetal & maternal pod 866488)

Frequency stability: **1-2773/16-01-02**

Project Note - SRR Applicability of conducted measurements

Project Note

Subject: Applicability of conducted measurements

Referenced Product:

Single SRR: FCC ID PQC-SRRBV6

Affected Products:

Dual SRR: FCC IDs: PQC-TRNSBV1 and PQC-OBTRNSBV1
Single SRR: FCC IDs: PQC-SRRBV5 and PQC-CLNBPBV2

The aforementioned "Affected Products" are identical in the design of the RF part except the antenna and its matching. Therefore, the conducted measurement results of the "Referenced Product" do also apply for the "Affected Products".

.....
Winfried Kaiser
Program Manager Measurements

20 Nov 2017
.....
Date

Note: Filed in DHF P35410, Saturn, Binder "Post Release Docs 1" in BBN R&D Vault DE-B300-006 chapter „Project Notes“.

Special test descriptions:

The EUT contains two radio modules (ID 248 and ID 251). The tests were performed on both modules.

Used power settings for module ID 248:

Lower band: -5 dBm for all channels / Upper band: 0 dBm for all channels

Used power settings for module ID 251:

Lower band: -1 dBm for all channels / Upper band: 0 dBm for all channels

Configuration descriptions: None

Test mode: Special software is used.
EUT is transmitting pseudo random data by itself

Antennas and transmit operating modes:

 Operating mode 1 (single antenna)

- *Equipment with 1 antenna,*
- *Equipment with 2 diversity antennas operating in switched diversity mode by which at any moment in time only 1 antenna is used,*
- *Smart antenna system with 2 or more transmit/receive chains, but operating in a mode where only 1 transmit/receive chain is used)*

 Operating mode 2 (multiple antennas, no beamforming)

- *Equipment operating in this mode contains a smart antenna system using two or more transmit/receive chains simultaneously but without beamforming.*

 Operating mode 3 (multiple antennas, with beamforming)

- *Equipment operating in this mode contains a smart antenna system using two or more transmit/receive chains simultaneously with beamforming.
In addition to the antenna assembly gain (G), the beamforming gain (Y) may have to be taken into account when performing the measurements.*

Expected results for systems test:

The timing specification of the MBAN System is as follows:

- MBAN P/C ceases any transmissions in the 2360 – 2390 MHz band < 60 seconds after communication with the MBAN Control Point is lost
- Body-Worn Sensor ceases any transmissions in the 2360 – 2390 MHz band < 6 seconds after the communication to the MBAN P/C is lost

Expected Results for Connection interrupt test (body-worn sensor) in 12.7 according to MBAN System Description (declared from manufacturer) (see Project Note)

Timeout for MBAN P/C connection interrupt:	60 seconds
Timeout for Body-Worn Sensor connection interrupt:	66 seconds

System description (declared from manufacturer):

Project Note

Subject: MBAN System Description for FCC Approval

Affected Products:

- Single SRR (FCC ID: PQC- SRRFMPBV1) in
- Avalon CL Fetal & Maternal Pod (866488)

This Project Note is made in order to describe the behavior of an MBAN System with an MBAN Control Point, MBAN P/Cs and Body-Worn Sensors.

An MBAN System (1) consists of:

- an MBAN Control Point which coordinates the usage of the restricted 2360 – 2390 MHz band
- MBAN P/Cs holding connections to Body-Worn Sensors
- Body-Worn Sensors sending data to their MBAN P/C

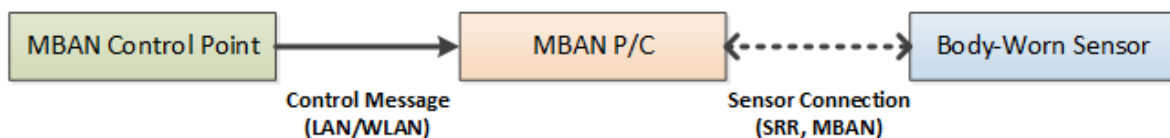

1 - MBAN System

The MBAN Control Point periodically sends a control message to the MBAN P/Cs which includes the following information:

- Channel Mask: An IEEE 802.15.4 channel mask listing the permitted frequencies in the 2360 – 2390 MHz band.
- Reception Period: The period in which the MBAN P/C has to receive at least one control message or has to cease any transmissions in the 2360 – 2390 MHz band.

In the default configuration, the control message is sent at an interval of 20 seconds and the reception period is 60 seconds (three times of the interval).

When a MBAN P/C receives a control message from the MBAN Control Point it automatically selects a channel according to the received Channel Mask. This channel is used for connections between the MBAN P/C and Body-Worn Sensors.

Also, the MBAN P/C distributes the received Channel Mask in the unrestricted 2390 – 2400 MHz band to the Body-Worn Sensors.

The Body-Worn Sensor monitors its connection to the MBAN P/C with a maximum timeout of 6 seconds. If there is no communication within this period the connection is dropped and the Body-Worn Sensor will cease any transmissions in the 2360 – 2390 MHz band.

The message flow of the MBAN System is shown in the message sequence diagram.

The timing specification of the MBAN System is as follows:

- MBAN P/C ceases any transmissions in the 2360 – 2390 MHz band **< 60 seconds** after communication with the MBAN Control Point is lost
- Body-Worn Sensor ceases any transmissions in the 2360 – 2390 MHz band **< 6 seconds** after the communication to the MBAN P/C is lost

Message sequence diagram:

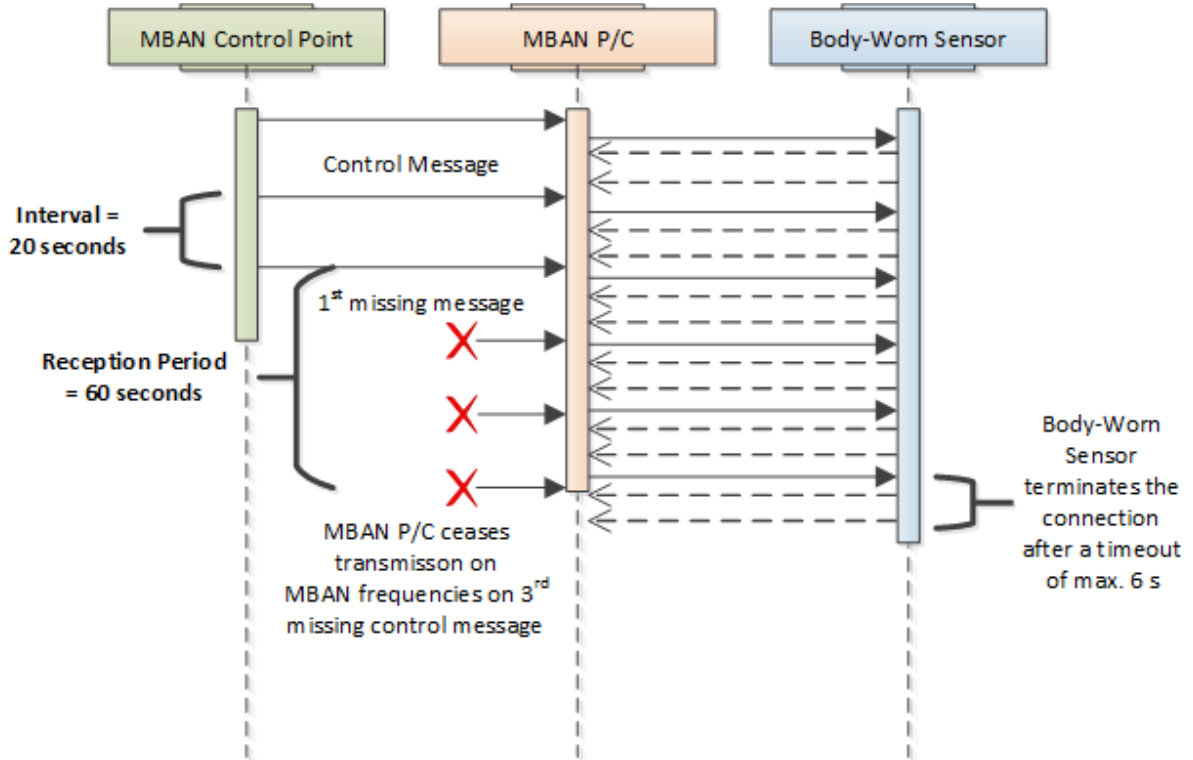

12 Measurement results

12.1 Frequency stability

Measurement:

Measurements in accordance with the procedure detailed in KDB 550599 D01 v01r01 (V) (A).

Measurement parameter	
Detector:	Peak
Sweep time:	Auto
Resolution bandwidth:	10 kHz
Video bandwidth:	30 kHz
Span:	5 MHz
Trace mode:	Max. hold
Test setup:	See sub clause 7.4 – B
Measurement uncertainty:	See sub clause 9

Limits:

FCC	IC
CFR § 95.2565 (b)	-/-
Frequency stability	
All MBAN devices must maintain a frequency stability of ± 100 ppm over a temperature range of 0°C to + 55°C.	

Note: Added from test report: 1-2773/16-01-02

Results: Channel low (2363 MHz), lower band

Temp [°C]	Time	Measured Frequency [MHz]	Deviation [ppm]	Verdict
0	Startup	2363.004	1.7	Compliant
	After 2 minutes	2363.004	1.7	Compliant
	After 5 minutes	2363.004	1.7	Compliant
	After 10 minutes	2363.004	1.7	Compliant
10	Startup	2363.004	1.7	Compliant
	After 2 minutes	2363.004	1.7	Compliant
	After 5 minutes	2363.004	1.7	Compliant
	After 10 minutes	2363.004	1.7	Compliant
20	Startup	2363.004	1.7	Compliant
	After 2 minutes	2363.004	1.7	Compliant
	After 5 minutes	2363.004	1.7	Compliant
	After 10 minutes	2363.004	1.7	Compliant
30	Startup	2362.995	-2.1	Compliant
	After 2 minutes	2362.995	-2.1	Compliant
	After 5 minutes	2362.995	-2.1	Compliant
	After 10 minutes	2362.995	-2.1	Compliant
40	Startup	2362.991	-3.8	Compliant
	After 2 minutes	2362.991	-3.8	Compliant
	After 5 minutes	2362.991	-3.8	Compliant
	After 10 minutes	2362.991	-3.8	Compliant
50	Startup	2362.987	-5.5	Compliant
	After 2 minutes	2362.987	-5.5	Compliant
	After 5 minutes	2362.987	-5.5	Compliant
	After 10 minutes	2362.987	-5.5	Compliant
55	Startup	2362.987	-5.5	Compliant
	After 2 minutes	2362.987	-5.5	Compliant
	After 5 minutes	2362.987	-5.5	Compliant
	After 10 minutes	2362.987	-5.5	Compliant

Results: Channel mid (2382 MHz), lower band

Temp [°C]	Time	Measured Frequency [MHz]	Deviation [ppm]	Verdict
0	Startup	2382.004	1.7	Compliant
	After 2 minutes	2382.004	1.7	Compliant
	After 5 minutes	2382.004	1.7	Compliant
	After 10 minutes	2382.004	1.7	Compliant
10	Startup	2382.004	1.7	Compliant
	After 2 minutes	2382.004	1.7	Compliant
	After 5 minutes	2382.004	1.7	Compliant
	After 10 minutes	2382.004	1.7	Compliant
20	Startup	2382.004	1.7	Compliant
	After 2 minutes	2382.004	1.7	Compliant
	After 5 minutes	2382.004	1.7	Compliant
	After 10 minutes	2382.004	1.7	Compliant
30	Startup	2381.995	-2.1	Compliant
	After 2 minutes	2381.995	-2.1	Compliant
	After 5 minutes	2381.995	-2.1	Compliant
	After 10 minutes	2381.995	-2.1	Compliant
40	Startup	2386.991	-3.8	Compliant
	After 2 minutes	2386.991	-3.8	Compliant
	After 5 minutes	2386.991	-3.8	Compliant
	After 10 minutes	2386.991	-3.8	Compliant
50	Startup	2387.987	-5.5	Compliant
	After 2 minutes	2387.987	-5.5	Compliant
	After 5 minutes	2387.987	-5.5	Compliant
	After 10 minutes	2387.987	-5.5	Compliant
55	Startup	2387.987	-5.5	Compliant
	After 2 minutes	2387.987	-5.5	Compliant
	After 5 minutes	2387.987	-5.5	Compliant
	After 10 minutes	2387.987	-5.5	Compliant

Results: Channel high (2387 MHz), lower band

Temp [°C]	Time	Measured Frequency [MHz]	Deviation [ppm]	Verdict
0	Startup	2387.004	1.7	Compliant
	After 2 minutes	2387.004	1.7	Compliant
	After 5 minutes	2387.004	1.7	Compliant
	After 10 minutes	2387.004	1.7	Compliant
10	Startup	2387.004	1.7	Compliant
	After 2 minutes	2387.004	1.7	Compliant
	After 5 minutes	2387.004	1.7	Compliant
	After 10 minutes	2387.004	1.7	Compliant
20	Startup	2387.004	1.7	Compliant
	After 2 minutes	2387.004	1.7	Compliant
	After 5 minutes	2387.004	1.7	Compliant
	After 10 minutes	2387.004	1.7	Compliant
30	Startup	2386.995	-2.1	Compliant
	After 2 minutes	2386.995	-2.1	Compliant
	After 5 minutes	2386.995	-2.1	Compliant
	After 10 minutes	2386.995	-2.1	Compliant
40	Startup	2386.997	-3.8	Compliant
	After 2 minutes	2386.997	-3.8	Compliant
	After 5 minutes	2386.997	-3.8	Compliant
	After 10 minutes	2386.997	-3.8	Compliant
50	Startup	2386.987	-5.5	Compliant
	After 2 minutes	2386.987	-5.5	Compliant
	After 5 minutes	2386.987	-5.5	Compliant
	After 10 minutes	2386.987	-5.5	Compliant
55	Startup	2386.987	-5.5	Compliant
	After 2 minutes	2386.987	-5.5	Compliant
	After 5 minutes	2386.987	-5.5	Compliant
	After 10 minutes	2386.987	-5.5	Compliant

Results: Channel low (2392 MHz), upper band

Temp [°C]	Time	Measured Frequency [MHz]	Deviation [ppm]	Verdict
0	Startup	2392.004	1.7	Compliant
	After 2 minutes	2392.004	1.7	Compliant
	After 5 minutes	2392.004	1.7	Compliant
	After 10 minutes	2392.004	1.7	Compliant
10	Startup	2392.004	1.7	Compliant
	After 2 minutes	2392.004	1.7	Compliant
	After 5 minutes	2392.004	1.7	Compliant
	After 10 minutes	2392.004	1.7	Compliant
20	Startup	2392.004	1.7	Compliant
	After 2 minutes	2392.004	1.7	Compliant
	After 5 minutes	2392.004	1.7	Compliant
	After 10 minutes	2392.004	1.7	Compliant
30	Startup	2391.995	-2.1	Compliant
	After 2 minutes	2391.995	-2.1	Compliant
	After 5 minutes	2391.995	-2.1	Compliant
	After 10 minutes	2391.995	-2.1	Compliant
40	Startup	2391.991	-3.8	Compliant
	After 2 minutes	2391.991	-3.8	Compliant
	After 5 minutes	2391.991	-3.8	Compliant
	After 10 minutes	2391.991	-3.8	Compliant
50	Startup	2391.987	-5.4	Compliant
	After 2 minutes	2391.987	-5.4	Compliant
	After 5 minutes	2391.987	-5.4	Compliant
	After 10 minutes	2391.987	-5.4	Compliant
55	Startup	2391.987	-5.4	Compliant
	After 2 minutes	2391.987	-5.4	Compliant
	After 5 minutes	2391.987	-5.4	Compliant
	After 10 minutes	2391.987	-5.4	Compliant

Results: Channel high (2397 MHz), upper band

Temp [°C]	Time	Measured Frequency [MHz]	Deviation [ppm]	Verdict
0	Startup	2397.004	1.7	Compliant
	After 2 minutes	2397.004	1.7	Compliant
	After 5 minutes	2397.004	1.7	Compliant
	After 10 minutes	2397.004	1.7	Compliant
10	Startup	2397.004	1.7	Compliant
	After 2 minutes	2397.004	1.7	Compliant
	After 5 minutes	2397.004	1.7	Compliant
	After 10 minutes	2397.004	1.7	Compliant
20	Startup	2397.004	1.7	Compliant
	After 2 minutes	2397.004	1.7	Compliant
	After 5 minutes	2397.004	1.7	Compliant
	After 10 minutes	2397.004	1.7	Compliant
30	Startup	2396.995	-2.1	Compliant
	After 2 minutes	2396.995	-2.1	Compliant
	After 5 minutes	2396.995	-2.1	Compliant
	After 10 minutes	2396.995	-2.1	Compliant
40	Startup	2396.991	-3.8	Compliant
	After 2 minutes	2396.991	-3.8	Compliant
	After 5 minutes	2396.991	-3.8	Compliant
	After 10 minutes	2396.991	-3.8	Compliant
50	Startup	2396.987	-5.4	Compliant
	After 2 minutes	2396.987	-5.4	Compliant
	After 5 minutes	2396.987	-5.4	Compliant
	After 10 minutes	2396.987	-5.4	Compliant
55	Startup	2396.987	-5.4	Compliant
	After 2 minutes	2396.987	-5.4	Compliant
	After 5 minutes	2396.987	-5.4	Compliant
	After 10 minutes	2396.987	-5.4	Compliant

12.2 Emission bandwidth

Measurement:

Measurements were made in accordance with ANSI C63.26-2015 (5.4.3).

Measurement parameter	
Detector:	Peak
Sweep time:	Auto
Resolution bandwidth:	30 kHz
Video bandwidth:	100 kHz
Span:	5 MHz
Trace mode:	Max. hold
Test setup:	See sub clause 7.4 – A
Measurement uncertainty:	See sub clause 9

Limits:

FCC	IC
CFR § 95.2573 (e)	-/-
<p>Emission bandwidth will be determined by measuring the width of the signal between points, one below the carrier center frequency and one above the carrier center frequency, that are 20 dB down relative to the maximum level of the modulated carrier. Compliance with the emission bandwidth limit is based on the use of measurement instrumentation employing a peak detector function with an instrument resolution bandwidth approximately equal to 1.0 percent of the emission bandwidth of the device under measurement.</p> <p>For stations operating in 2360-2400 MHz, the maximum authorized emission bandwidth is 5 megahertz.</p>	

Results: Module ID 248

Channel	Frequency [MHz]	Emission bandwidth [kHz]
Low (lower band)	2363	2580
Mid (lower band)	2382	2600
High (lower band)	2387	2600
Low (upper band)	2392	2610
High (upper band)	2397	2610

Results: Module ID 251

Channel	Frequency [MHz]	Emission bandwidth [kHz]
Low (lower band)	2363	2640
Mid (lower band)	2382	2600
High (lower band)	2387	2600
Low (upper band)	2392	2610
High (upper band)	2397	2610

Plots: Module ID 248

Plot 1: lowest channel, lower band

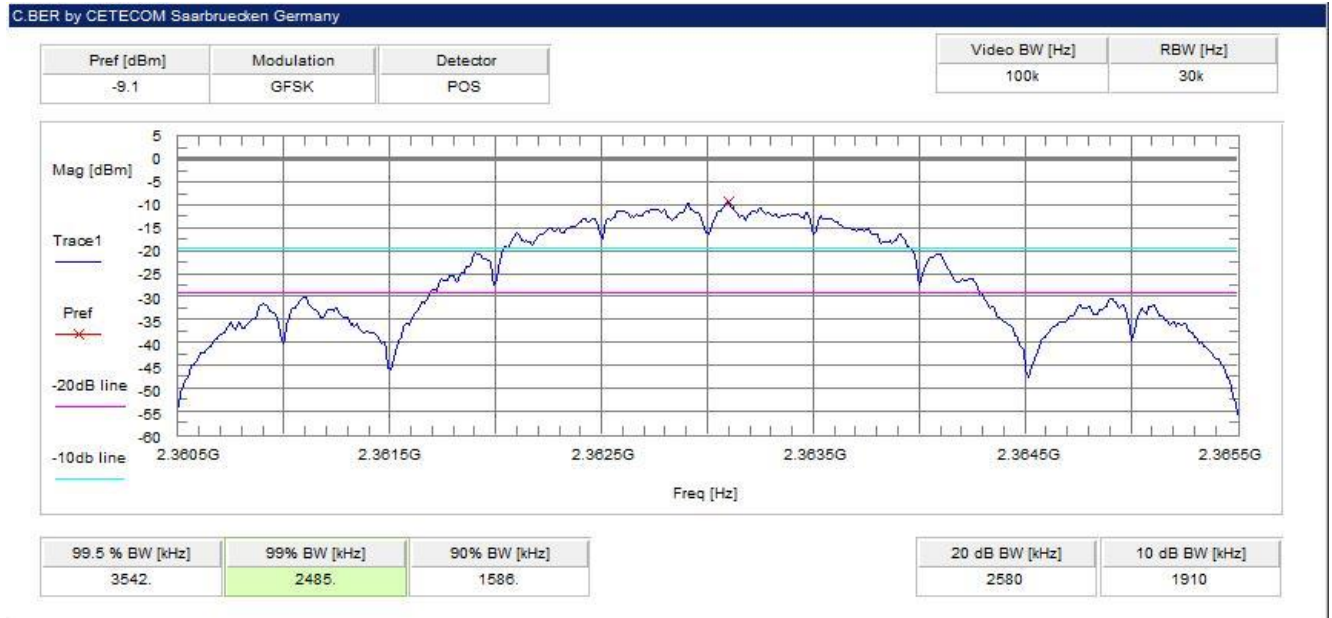

Plot 2: mid channel, lower band



Plot 3: highest channel, lower band

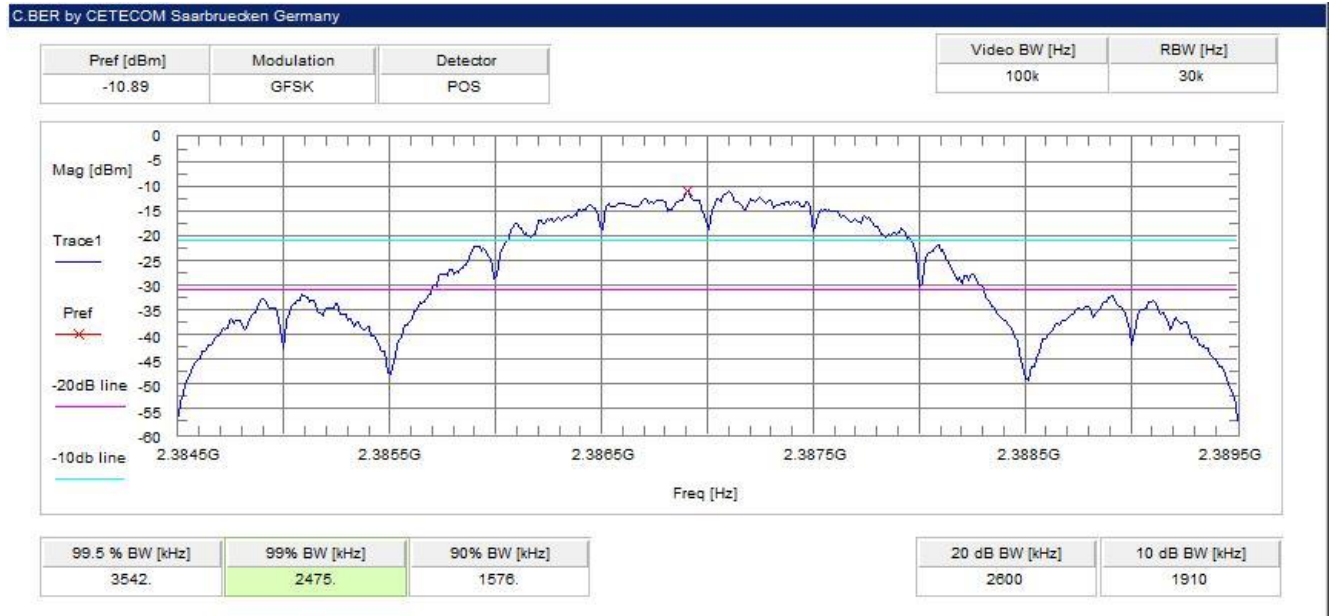

Plot 4: lowest channel, upper band



Plot 5: highest channel, upper band

C.BER by CETECOM Saarbruecken Germany

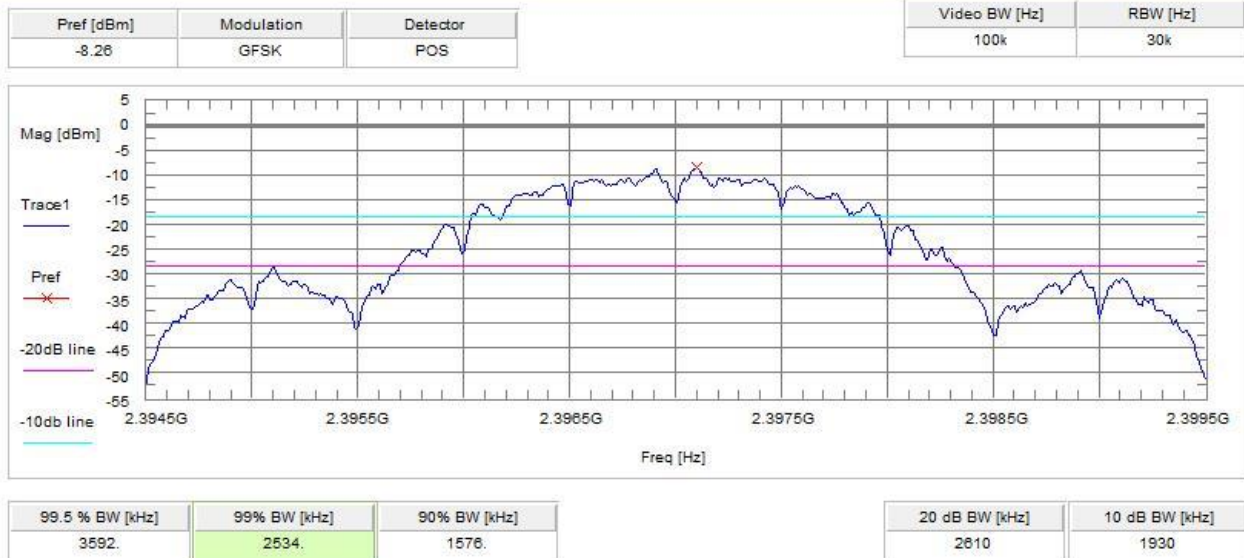

Plots: Module ID 251

Plot 1: lowest channel, lower band

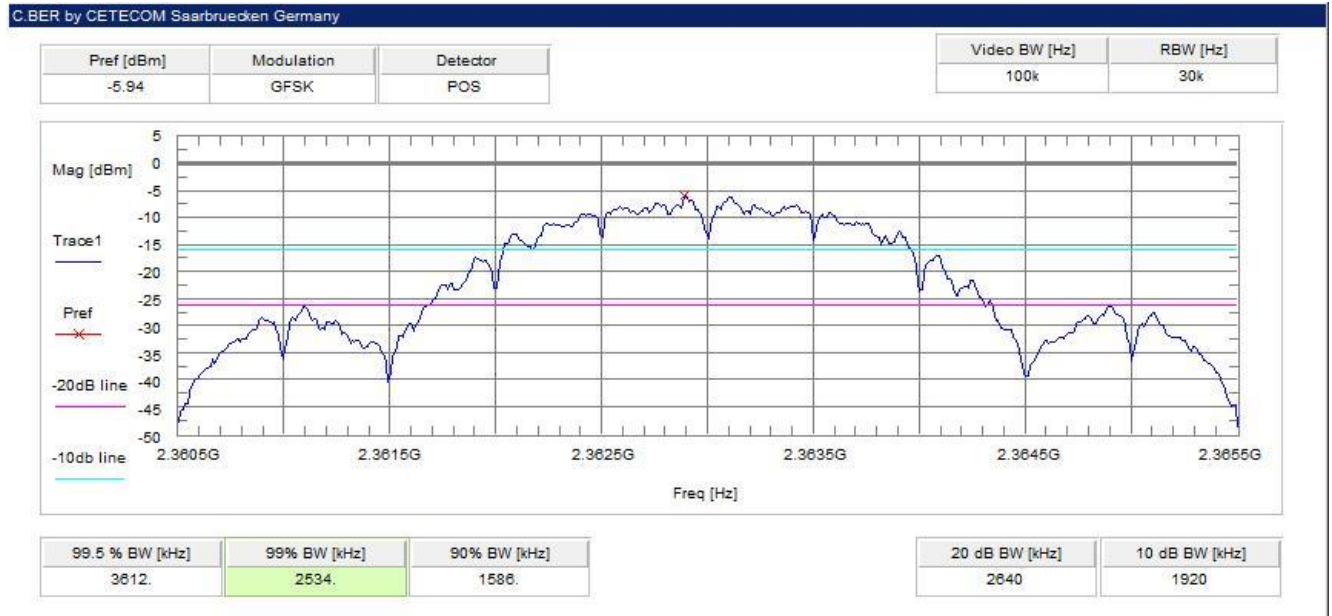

Plot 2: mid channel, lower band



Plot 3: highest channel, lower band



Plot 4: lowest channel, upper band



Plot 5: highest channel, upper band

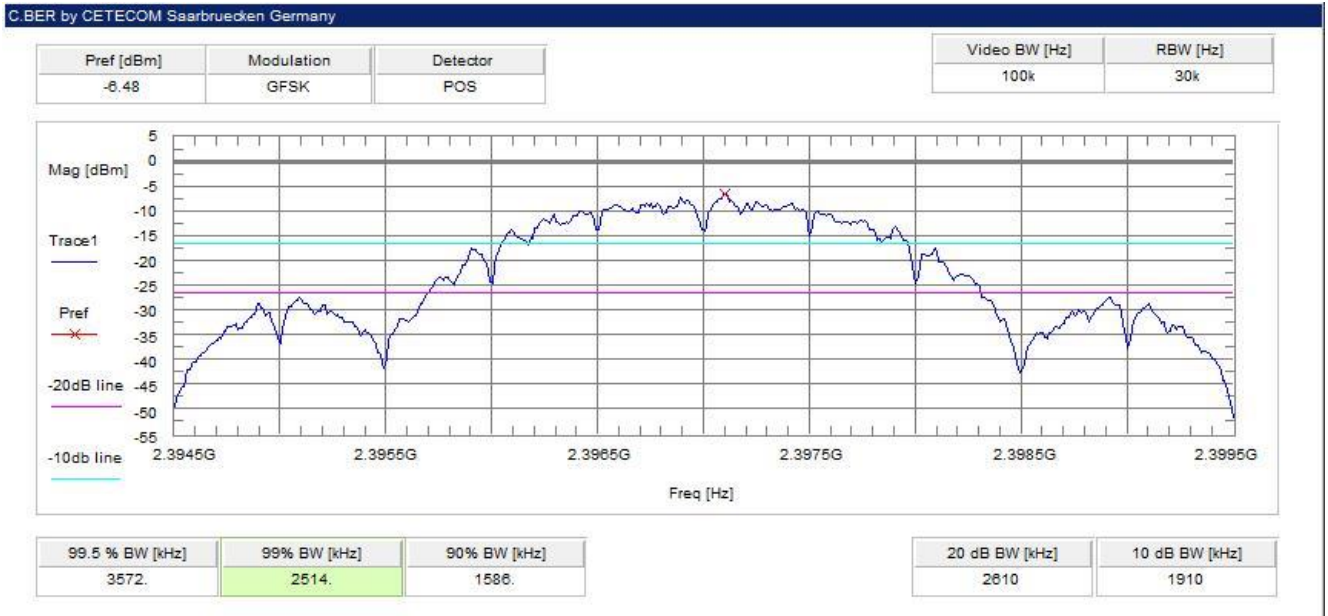

12.3 Maximum transmit power

Measurement:

Measurements were made in accordance with the procedures detailed in FCC 95.2567 (e) and (f), 5.2.5.5 of ANSI C63.26- 2015 and FCC OET 971168 – Measurement Guidance for Certification of Licensed Digital Transmitters, Section 5.1.

Measurement parameter	
Detector:	Peak
Sweep time:	Auto
Resolution bandwidth:	3 MHz
Video bandwidth:	10 MHz
Span:	10 MHz
Trace mode:	Max. hold
Test setup:	See sub clause 7.6 – A
Measurement uncertainty:	See sub clause 9

Limits:

FCC	IC
47 CFR § 95.2567 (e) and (f)	-/-
<p>95.2567(e): For MedRadio transmitters operating in the 2360-2390 MHz band, the M-EIRP over the bands of operation must not exceed the lesser of zero dBm (1 mW) or $10 \log(B)$ dBm, where B is the MedRadio 20 dB emission bandwidth in megahertz.</p> <p>95.2567(f): For MedRadio transmitters operating in the 2390-2400 MHz band, the M-EIRP over the bands of operation must not exceed the lesser of 13 dBm (20 mW) or $16 + 10 \log(B)$ dBm, where B is the MedRadio 20 dB emission bandwidth in megahertz.</p>	

Result: Module ID 248

Frequency [MHz]	EIRP measured [dBm]	Limit [dBm]
2363	-1.6	0.0
2382	-0.4	0.0
2387	0.0	0.0
2392	5.0	13.0
2397	5.1	13.0

Result: Module ID 251

Frequency [MHz]	EIRP measured [dBm]	Limit [dBm]
2363	0.0	0.0
2382	-0.1	0.0
2387	0.0	0.0
2392	2.5	13.0
2397	3.5	13.0

According to the FCC requirement:

Photo: test setup OTA (over the air performance)

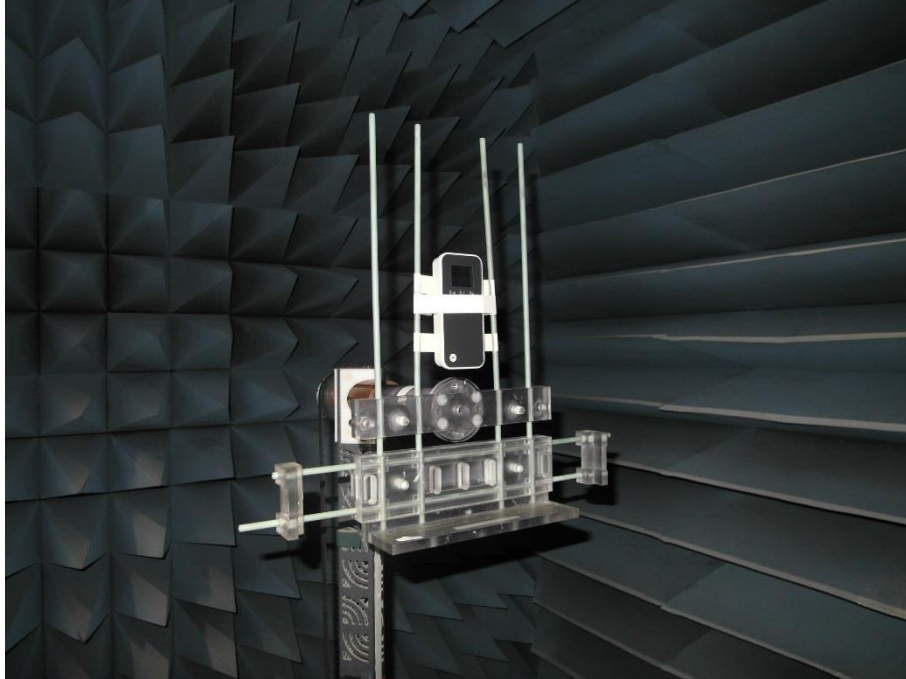

No human body phantom or an equivalent testing setup was used for the test setup.

Plots: radiated; module ID 248

Plot 1: lowest channel, lower band, antenna diagram with maximum EIRP

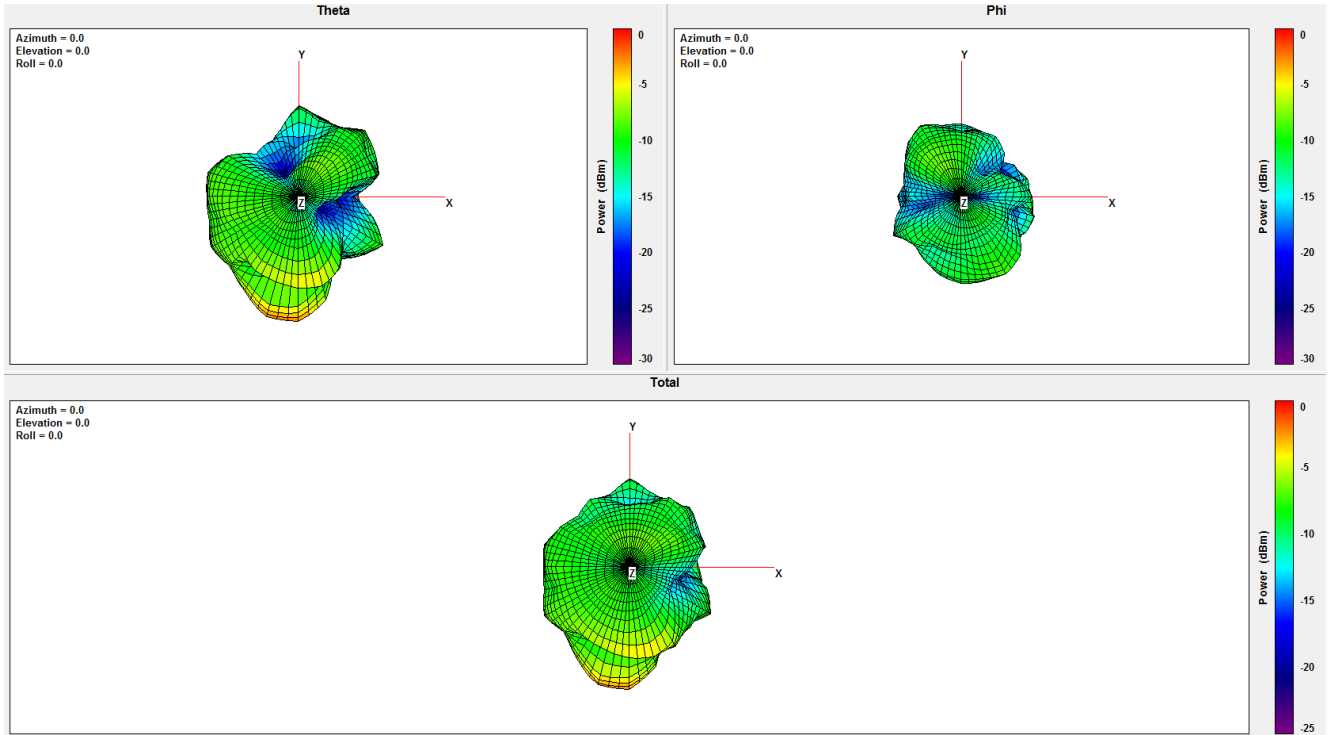

Total	Point Values	
	Ant. Port Input Pwr. (dBm)	0
	Tot. Rad. Pwr. (dBm)	-7,65018
	Peak EIRP (dBm)	-1,61659

Plot 2: mid channel, lower band, antenna diagram with maximum EIRP

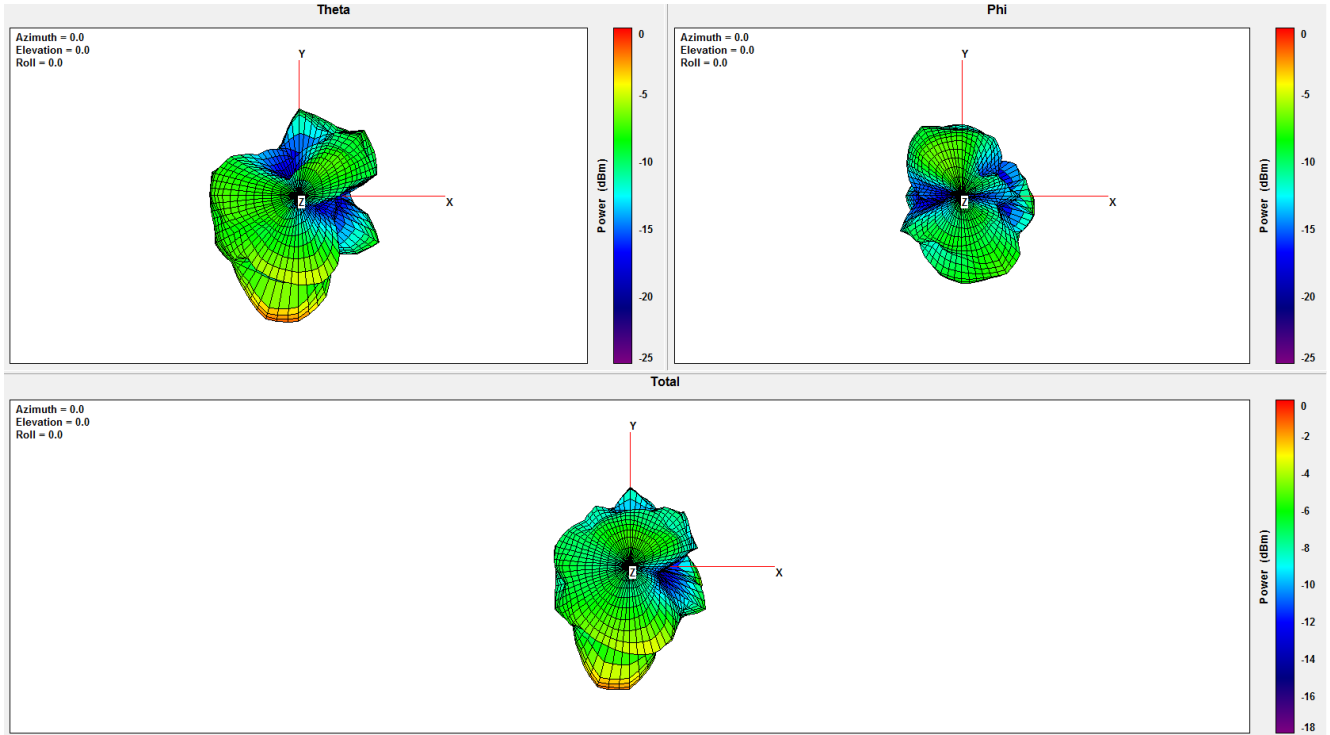

Total	Point Values	
	Ant. Port Input Pwr. (dBm)	0
	Tot. Rad. Pwr. (dBm)	-6,70359
	Peak EIRP (dBm)	-0,358667

Plot 3: highest channel, lower band, antenna diagram with maximum EIRP

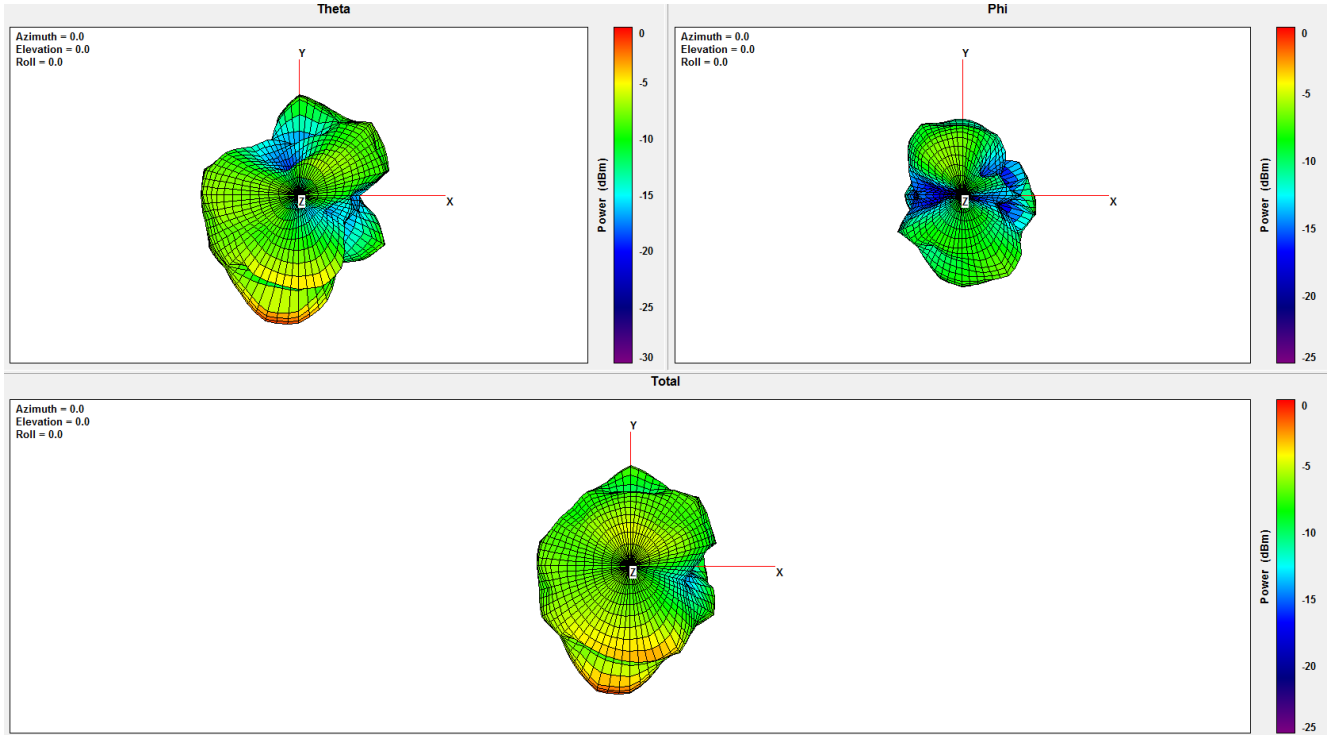

Total	Point Values
	Ant. Port Input Pwr. (dBm) 0
	Tot. Rad. Pwr. (dBm) -6,3264
	Peak EIRP (dBm) -0,0055952
	2

Plot 4: low channel, upper band, antenna diagram with maximum EIRP

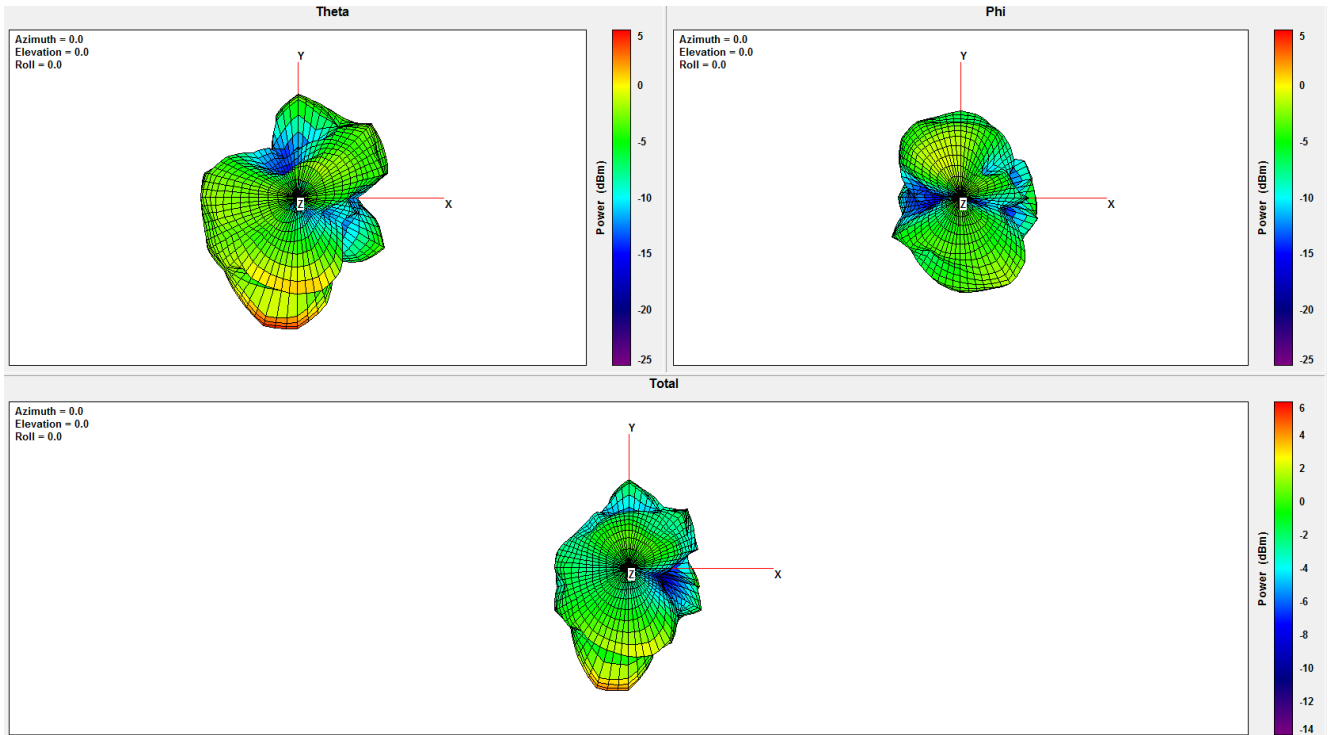

Total	Point Values
	Ant. Port Input Pwr. (dBm) 0
	Tot. Rad. Pwr. (dBm) -1,38725
	Peak EIRP (dBm) 5,00763

Plot 5: highest channel, upper band, antenna diagram with maximum EIRP

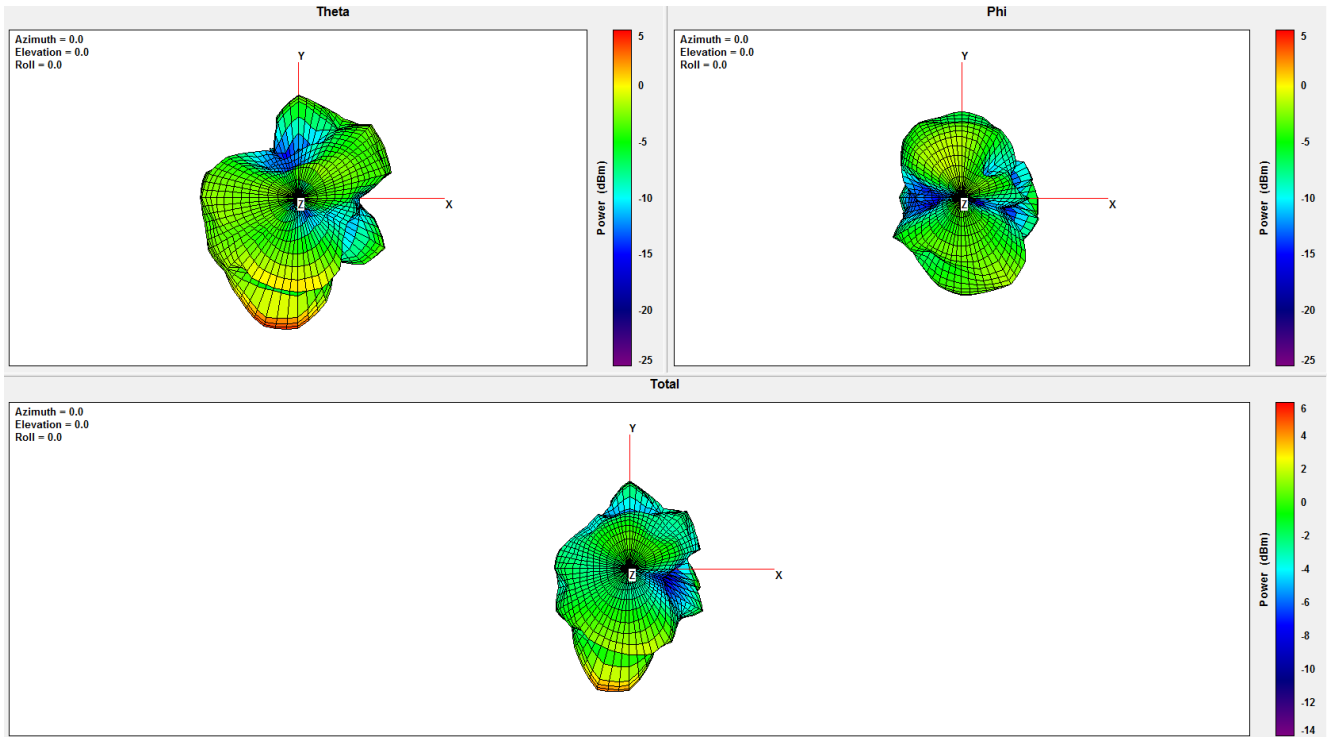

Total	Point Values	
	Ant. Port Input Pwr. (dBm)	0
	Tot. Rad. Pwr. (dBm)	-1,42265
	Peak EIRP (dBm)	5,10867

Plots: radiated; module ID 251

Plot 1: lowest channel, lower band, antenna diagram with maximum EIRP

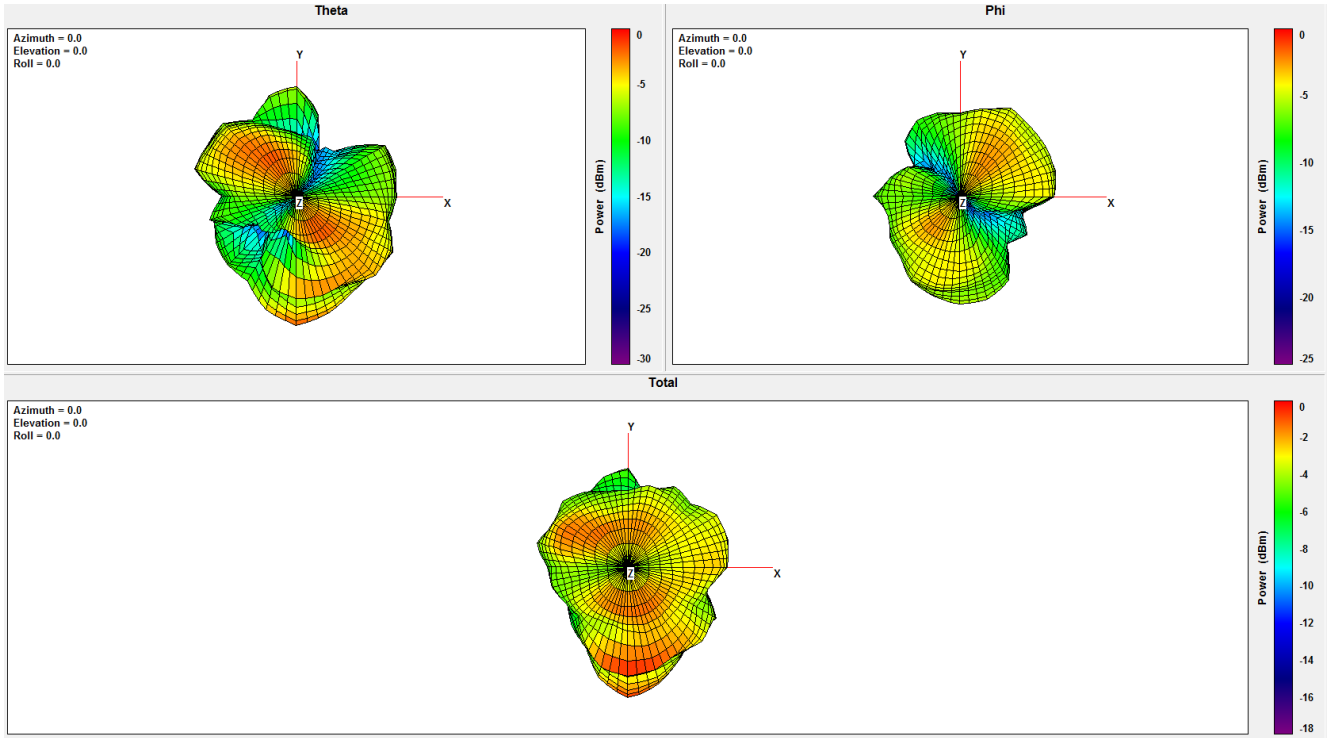

Total	Point Values	
	Ant. Port Input Pwr. (dBm)	0
	Tot. Rad. Pwr. (dBm)	-5,43188
	Peak EIRP (dBm)	-0,0125985

Plot 2: mid channel, lower band, antenna diagram with maximum EIRP

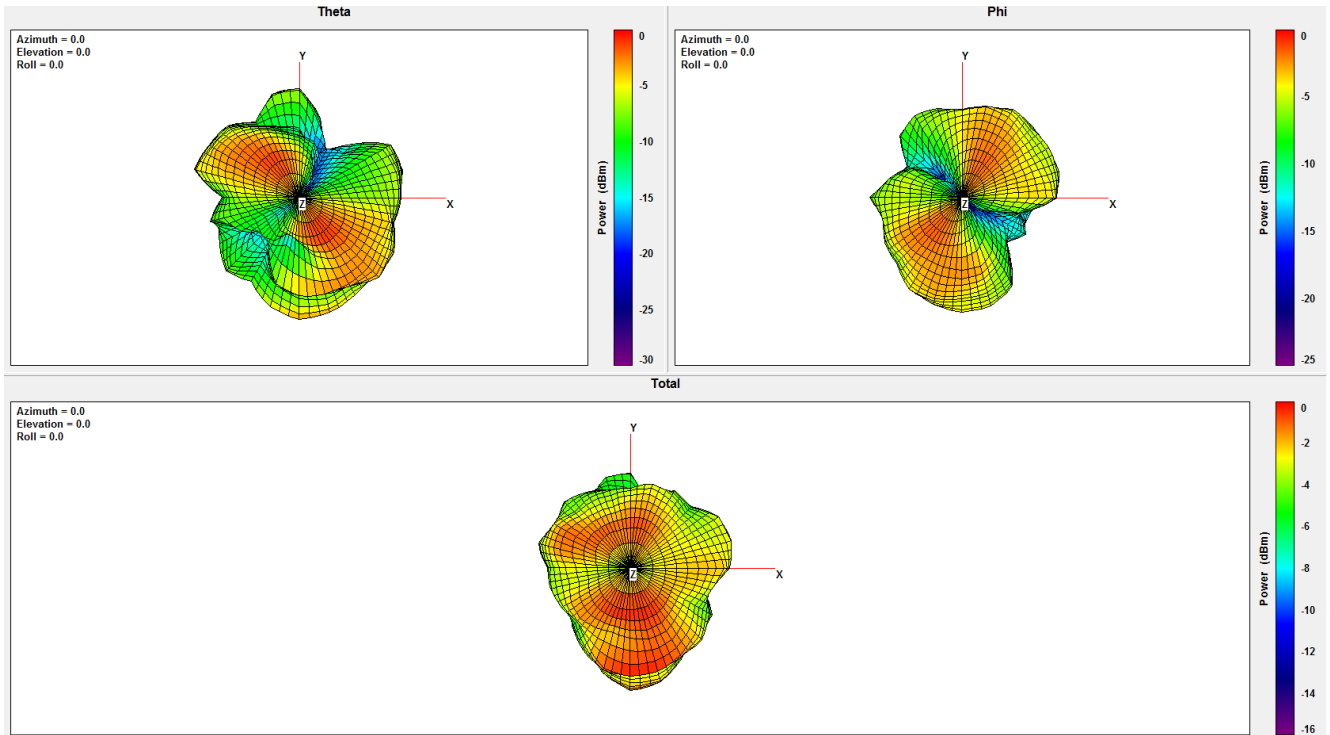

Total	Point Values	
	Ant. Port Input Pwr. (dBm)	0
	Tot. Rad. Pwr. (dBm)	-5,05584
	Peak EIRP (dBm)	-0,0751521

Plot 3: highest channel, lower band, antenna diagram with maximum EIRP

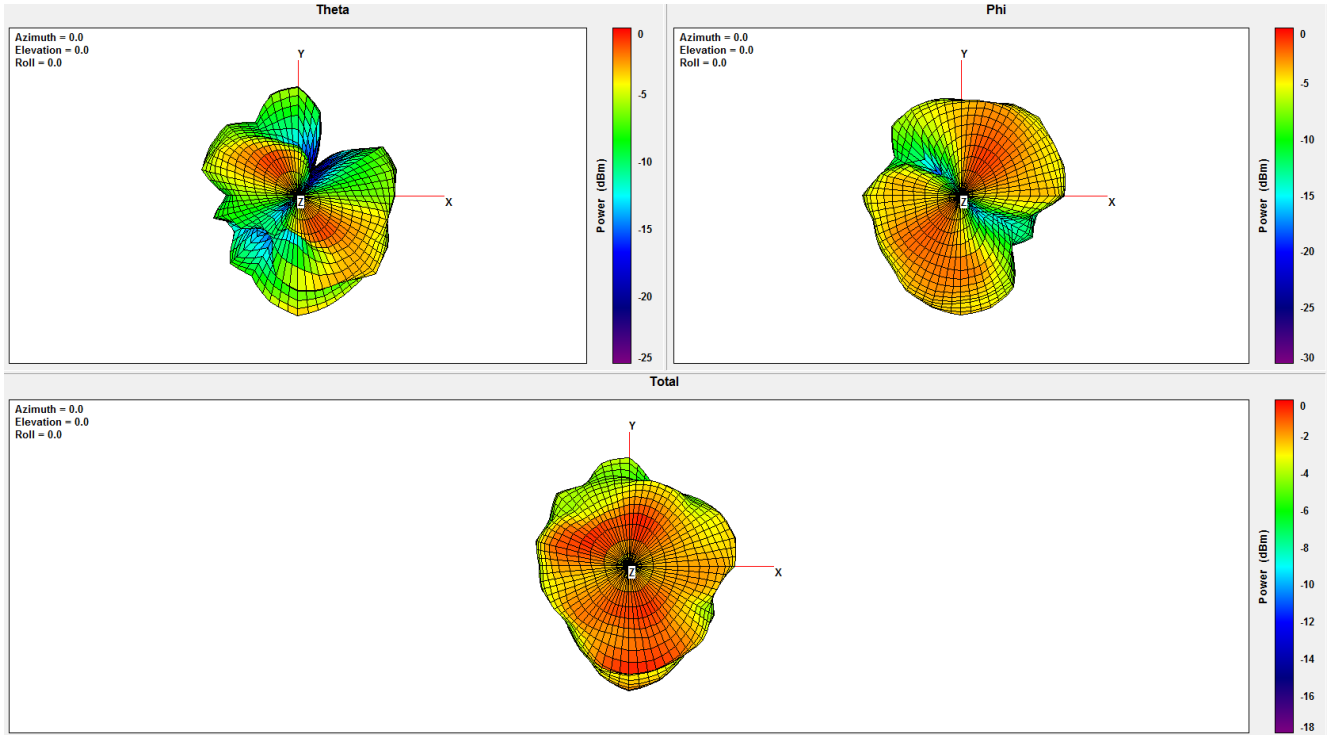

Total	Point Values	
	Ant. Port Input Pwr. (dBm)	0
	Tot. Rad. Pwr. (dBm)	-4,8917
	Peak EIRP (dBm)	-0,043203

Plot 4: low channel, upper band, antenna diagram with maximum EIRP

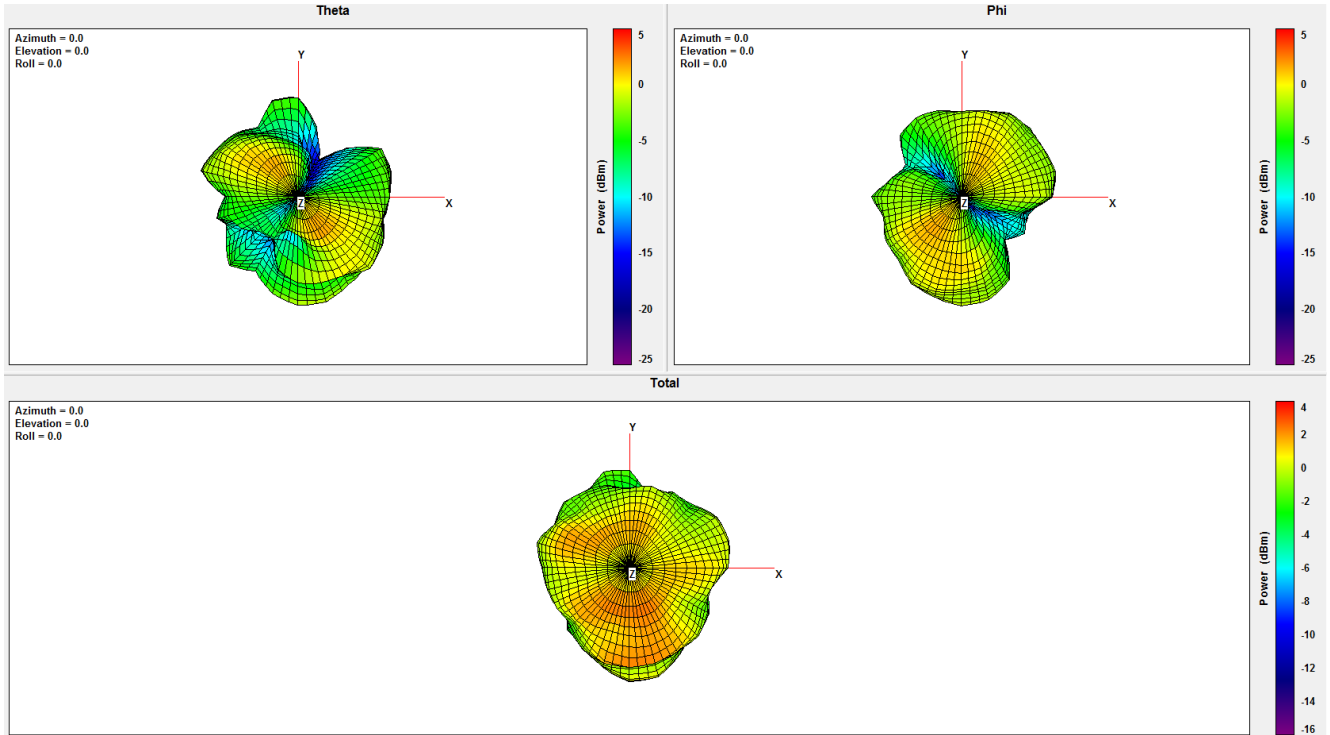

Total	Point Values	
	Ant. Port Input Pwr. (dBm)	0
	Tot. Rad. Pwr. (dBm)	-2,24844
	Peak EIRP (dBm)	2,54254

Plot 5: highest channel, upper band, antenna diagram with maximum EIRP

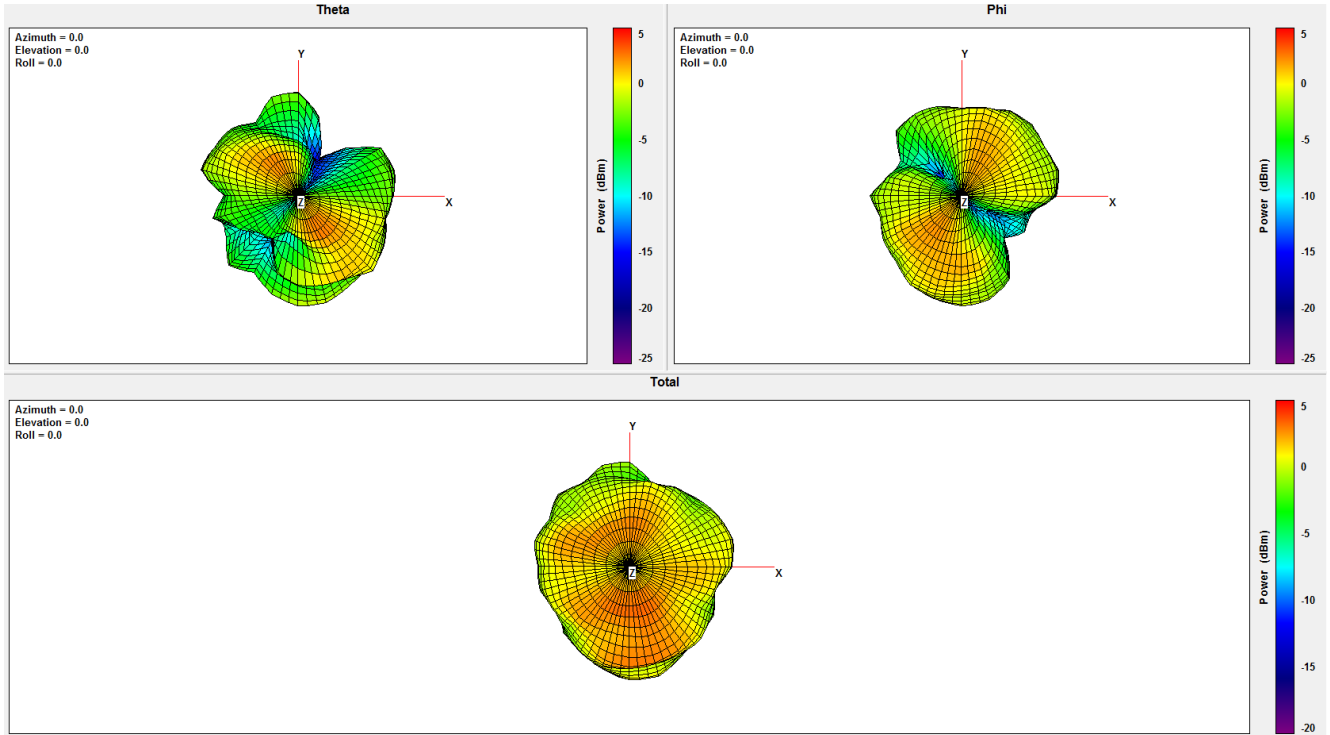

Total	Point Values	
	Ant. Port Input Pwr. (dBm)	0
	Tot. Rad. Pwr. (dBm)	-1,69628
	Peak EIRP (dBm)	3,45382

12.4 Band edge measurement

Measurement:

Measurements were made in accordance with 5.7 of ANSI C63.26-2015.

Measurement parameter	
Detector:	Peak
Sweep time:	Auto
Resolution bandwidth:	1 MHz
Video bandwidth:	3 MHz
Span:	2357.5 MHz – 2392.5 MHz
Trace mode:	Max. hold
Test setup:	See sub clause 7.4 – A
Measurement uncertainty:	See sub clause 9

Limits:

FCC	IC
47 CFR § 95.2579 (f)	-/-
In the first 2.5 MHz beyond any of the frequency bands authorized for MBAN operation, the EIRP level associated with any unwanted emissions must be attenuated within a 1 MHz bandwidth by at least 20 dB relative to the maximum EIRP level within any 1 MHz of the fundamental emission (i.e., 20 dBc).	

Results: Module ID 248

Channel	Band edge frequency range [MHz]	Frequency [MHz]	Effective attenuation [dBc]	Required attenuation [dBc]
Low	2357.5 – 2360	2363	-25.1	≥ 20
Low	2400 – 2402.5	2363	-34.6	≥ 20
High	2357.5 – 2360	2397	-37.4	≥ 20
High	2400 – 2402.5	2397	-24.8	≥ 20

Results: Module ID 251

Channel	Band edge frequency range [MHz]	Frequency [MHz]	Effective attenuation [dBc]	Required attenuation [dBc]
Low	2357.5 – 2360	2363	-25.2	≥ 20
Low	2400 – 2402.5	2363	-33.9	≥ 20
High	2357.5 – 2360	2397	-38.8	≥ 20
High	2400 – 2402.5	2397	-25.6	≥ 20

Plots: Module ID 248

Plot 1: lowest channel, lower band edge

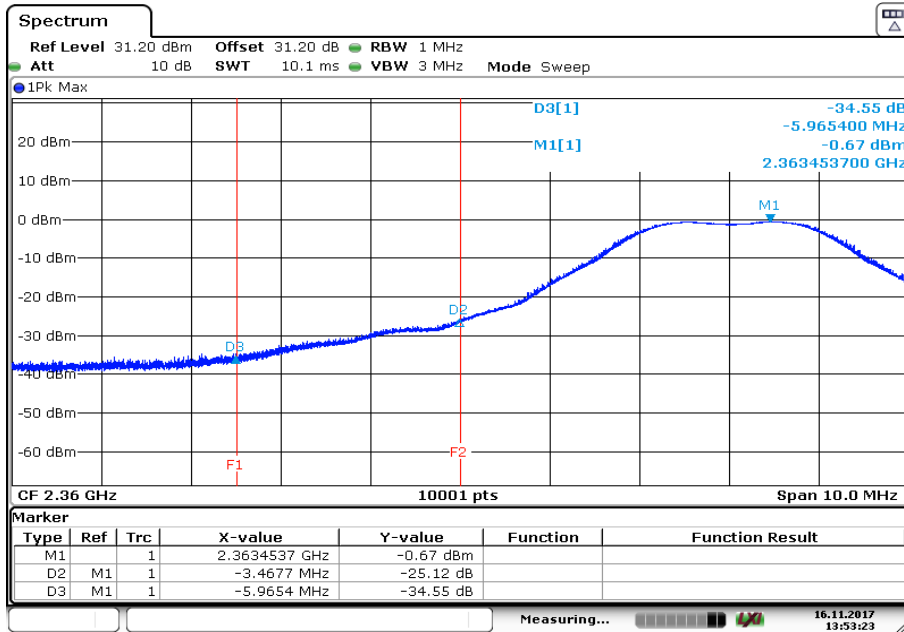

Date: 16.NOV.2017 13:53:23

Plot 2: highest channel, upper band edge

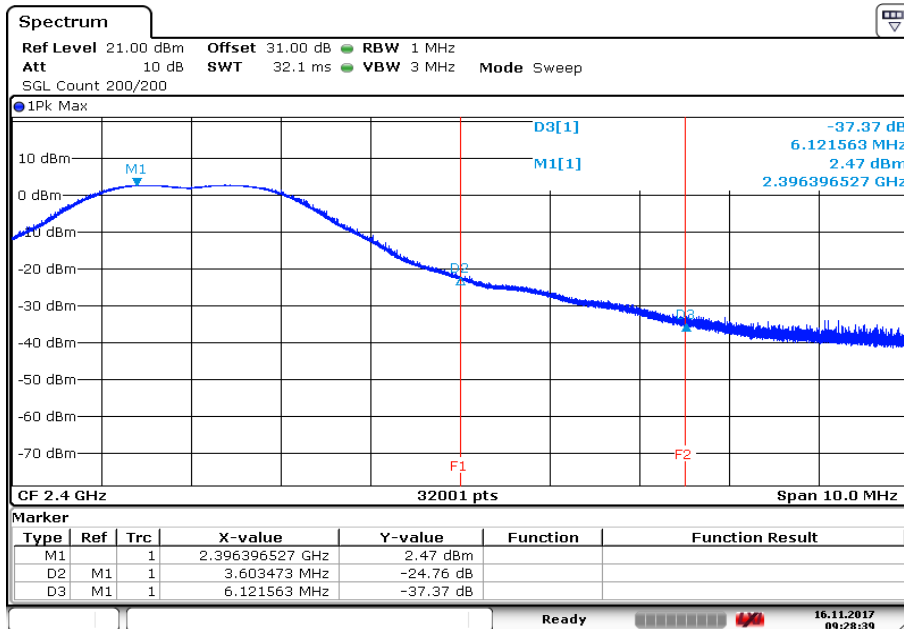

Date: 16 NOV. 2017 09:28:39

Plots: Module ID 251

Plot 1: lowest channel, lower band edge

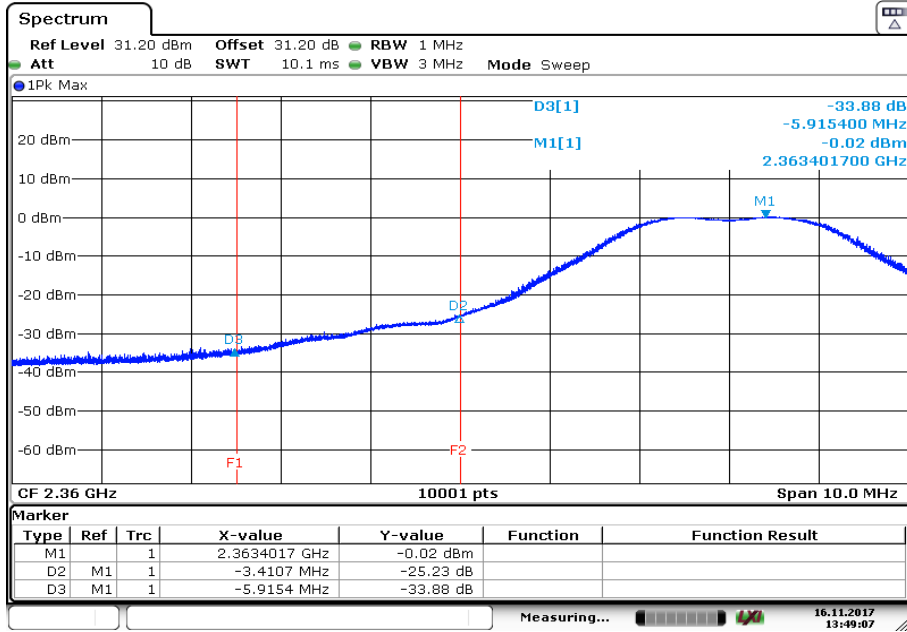

Date: 16.NOV.2017 13:49:07

Plot 2: highest channel, upper band edge

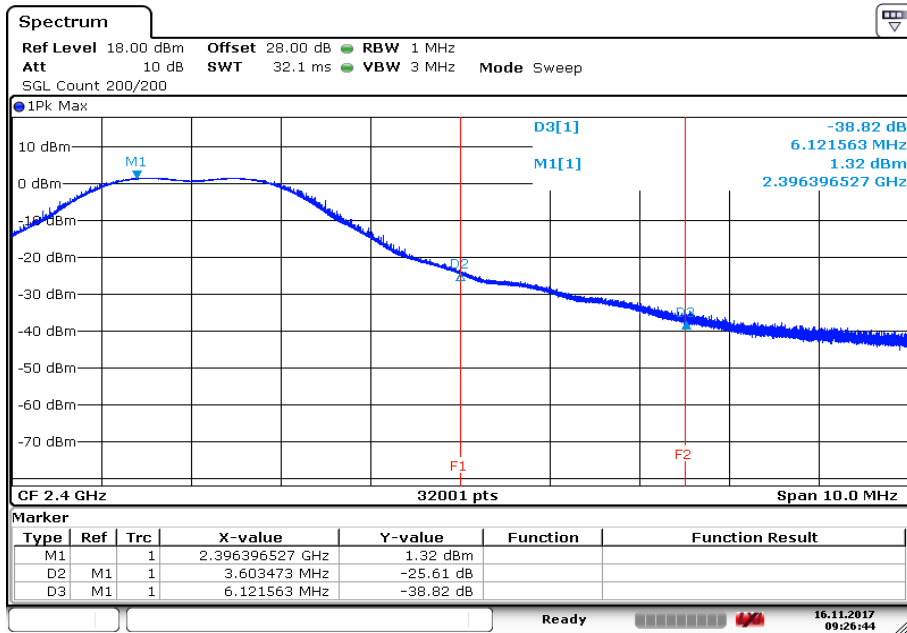

Date: 16 NOV. 2017 09:26:45

12.5 Transmitter unwanted radiation (radiated)

Measurement:

Measurement parameter	
Detector:	Prescan: Peak Final: QPK below 960 MHz RMS above 960 MHz
Video bandwidth:	9 kHz – 150 kHz: 1 kHz 150 kHz – 30 MHz: 30 kHz 30 MHz – 1 GHz: 300 kHz 1 GHz – 26 GHz: 3 MHz
Resolution bandwidth:	9 kHz – 150 kHz: 200 Hz 150 kHz – 30 MHz: 9 kHz 30 MHz – 1 GHz: 100 kHz 1 GHz – 26 GHz: 1 MHz
Span:	See plots
Trace mode:	Max Hold
Test setup:	See sub clause 7.1 – A & 7.2 – A&B & 7.3 – A
Measurement uncertainty:	See sub clause 9

Limits:

FCC	IC	
47 CFR § 15.109 47 CFR §95.2579 (a)(5)	-/-	
Transmitter unwanted radiation (radiated)		
Frequency (MHz)	Field strength (µV/m) ¹	Measurement distance (m)
0.009 – 0.490	2400/F(kHz)	300
0.490 – 1.705	24000/F(kHz)	30
1.705 – 30.0	30	30
30 - 88	100 (40 dBµV/m)	3
30 - 88	31.6 (30 dBµV/m)	10
88 - 216	150 (43.5 dBµV/m)	3
88 - 216	47.3 (33.5 dBµV/m)	10
216 - 960	200 (46 dBµV/m)	3
216 - 960	63.1 (36 dBµV/m)	10
above 960	500 (54 dBµV/m)	3

¹ Measurements in the 9 to 90 kHz, 110 to 490 kHz and above 1000 MHz ranges employ an average detector. Otherwise a quasi-peak detector is used.

According to the FCC requirement:

The radiated measurements were performed without a human body phantom or an equivalent testing setup (photo documentation – see external annex D).

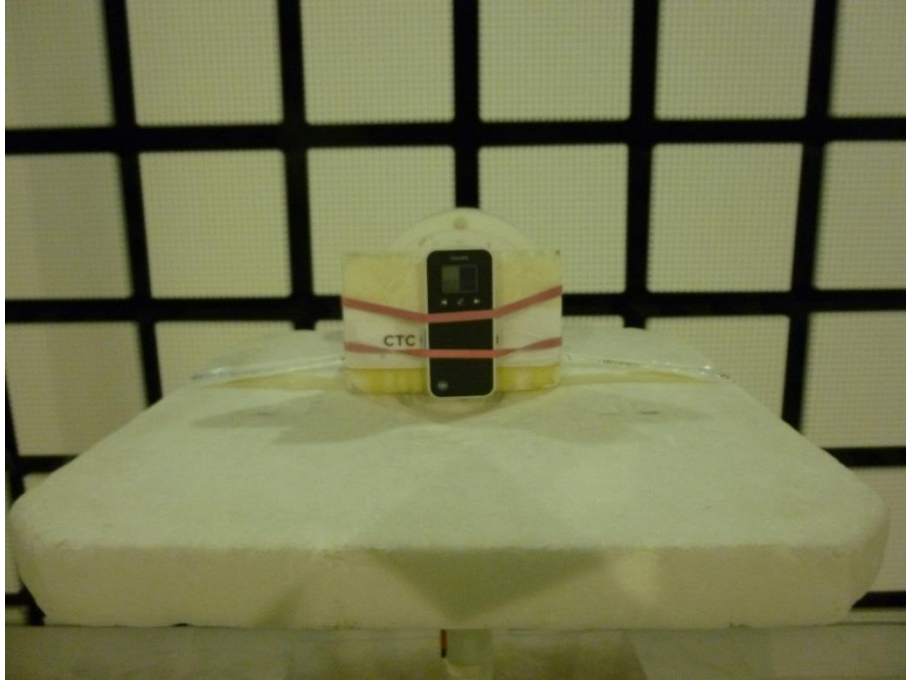

Results: Transmitter mode, Module ID 248

Transmitter unwanted radiation [dBµV/m]								
2363 MHz			2382 MHz			2387 MHz		
F [MHz]	Detector	Level [dBµV/m]	F [MHz]	Detector	Level [dBµV/m]	F [MHz]	Detector	Level [dBµV/m]
For emissions below 1 GHz, please look at the table below the 1 GHz plot.								
1023	Peak	24.8	1023	Peak	24.8	1023	Peak	24.8
	QPK	-/-		QPK	-/-		QPK	-/-
1238	Peak	25.2	1238	Peak	25.2	1238	Peak	25.2
	QPK	-/-		QPK	-/-		QPK	-/-
1370	Peak	27.1	1484	Peak	26.5	1484	Peak	26.5
	QPK	-/-		QPK	-/-		QPK	-/-
1643	Peak	27.0	1643	Peak	27.0	1643	Peak	27.0
	RMS	-/-		RMS	-/-		RMS	-/-
2120	Peak	29.3	2120	Peak	29.3	2120	Peak	29.3
	RMS	-/-		RMS	-/-		RMS	-/-
2337	Peak	31.0	2337	Peak	31.0	2337	Peak	31.0
	RMS	-/-		RMS	-/-		RMS	-/-
2507	Peak	33.8	3090	Peak	35.4	3090	Peak	35.4
	RMS	-/-		RMS	-/-		RMS	-/-
4371	Peak	38.0	3736	Peak	36.7	3736	Peak	36.7
	RMS	-/-		RMS	-/-		RMS	-/-
4726	Peak	53.4	4764	Peak	52.4	4774	Peak	53.1
	RMS	45.2		RMS	44.0		RMS	44.0
6980	Peak	41.1	6980	Peak	41.1	6980	Peak	41.1
	RMS	-/-		RMS	-/-		RMS	-/-
14238	Peak	40.1	14238	Peak	40.1	14238	Peak	40.1
	RMS	-/-		RMS	-/-		RMS	-/-
17958	Peak	43.8	17958	Peak	43.8	17958	Peak	43.8
	RMS	-/-		RMS	-/-		RMS	-/-
-/-	Peak	-/-	-/-	Peak	-/-	-/-	Peak	-/-
	RMS	-/-		RMS	-/-		RMS	-/-
For emissions above 18 GHz, please look at the plots.								

Results: Transmitter mode, Module ID 248

Transmitter unwanted radiation [dBµV/m]								
2392 MHz			-/-			2397 MHz		
F [MHz]	Detector	Level [dBµV/m]	F [MHz]	Detector	Level [dBµV/m]	F [MHz]	Detector	Level [dBµV/m]
For emissions below 1 GHz, please look at the table below the 1 GHz plot.								
1023	Peak	24.8	-/-	Peak	-/-	1023	Peak	24.8
	QPK	-/-		QPK	-/-		QPK	-/-
1238	Peak	25.2	-/-	Peak	-/-	1238	Peak	25.2
	QPK	-/-		QPK	-/-		QPK	-/-
1370	Peak	27.1	-/-	Peak	-/-	1370	Peak	27.1
	QPK	-/-		AVG	-/-		QPK	-/-
1643	Peak	27.0	-/-	Peak	-/-	1643	Peak	27.0
	RMS	-/-		RMS	-/-		RMS	-/-
2120	Peak	29.3	-/-	Peak	-/-	2120	Peak	29.3
	RMS	-/-		RMS	-/-		RMS	-/-
2337	Peak	31.0	-/-	Peak	-/-	2337	Peak	31.0
	RMS	-/-		RMS	-/-		RMS	-/-
2507	Peak	33.8	-/-	Peak	-/-	2507	Peak	33.8
	RMS	-/-		RMS	-/-		RMS	-/-
3736	Peak	36.7	-/-	Peak	-/-	4795	Peak	57.7
	RMS	-/-		RMS	-/-		RMS	50.5
4785	Peak	57.3	-/-	Peak	-/-	7191	Peak	40.1
	RMS	50.5		RMS	-/-		RMS	-/-
7177	Peak	38.9	-/-	Peak	-/-	9189	Peak	38.5
	RMS	-/-		RMS	-/-		RMS	-/-
9570	Peak	38.8	-/-	Peak	-/-	11878	Peak	38.6
	RMS	-/-		RMS	-/-		RMS	-/-
17958	Peak	43.8	-/-	Peak	-/-	17958	Peak	43.8
	RMS	-/-		RMS	-/-		RMS	-/-
-/-	Peak	-/-	-/-	Peak	-/-	-/-	Peak	-/-
	RMS	-/-		RMS	-/-		RMS	-/-
For emissions above 18 GHz, please look at the plots.								

Results: Transmitter mode, Module ID 251

Transmitter unwanted radiation [dBµV/m]								
2363 MHz			2382 MHz			2387 MHz		
F [MHz]	Detector	Level [dBµV/m]	F [MHz]	Detector	Level [dBµV/m]	F [MHz]	Detector	Level [dBµV/m]
For emissions below 1 GHz, please look at the table below the 1 GHz plot.								
1023	Peak	24.8	1023	Peak	24.8	1023	Peak	24.8
	QPK	-/-		QPK	-/-		QPK	-/-
1238	Peak	25.2	1238	Peak	25.2	1238	Peak	25.2
	QPK	-/-		QPK	-/-		QPK	-/-
1370	Peak	27.1	1484	Peak	26.5	1484	Peak	26.5
	QPK	-/-		QPK	-/-		QPK	-/-
1643	Peak	27.0	1643	Peak	27.0	1643	Peak	27.0
	RMS	-/-		RMS	-/-		RMS	-/-
2120	Peak	29.3	2120	Peak	29.3	2120	Peak	29.3
	RMS	-/-		RMS	-/-		RMS	-/-
2337	Peak	31.0	2337	Peak	31.0	2337	Peak	31.0
	RMS	-/-		RMS	-/-		RMS	-/-
2507	Peak	33.8	3090	Peak	35.4	3090	Peak	35.4
	RMS	-/-		RMS	-/-		RMS	-/-
4371	Peak	38.0	3736	Peak	36.7	3736	Peak	36.7
	RMS	-/-		RMS	-/-		RMS	-/-
4726	Peak	52.7	4764	Peak	48.9	4774	Peak	49.1
	RMS	44.0		RMS	41.0		RMS	42.3
6980	Peak	41.1	7144	Peak	39.6	6980	Peak	41.1
	RMS	-/-		RMS	-/-		RMS	-/-
14238	Peak	40.1	9526	Peak	38.5	14256	Peak	39.9
	RMS	-/-		RMS	-/-		RMS	-/-
17958	Peak	43.8	17958	Peak	43.8	17958	Peak	43.8
	RMS	-/-		RMS	-/-		RMS	-/-
-/-	Peak	-/-	-/-	Peak	-/-	-/-	Peak	-/-
	RMS	-/-		RMS	-/-		RMS	-/-
For emissions above 18 GHz, please look at the plots.								

Results: Transmitter mode, Module ID 251

Transmitter unwanted radiation [dBµV/m]								
2392 MHz			-/-			2397 MHz		
F [MHz]	Detector	Level [dBµV/m]	F [MHz]	Detector	Level [dBµV/m]	F [MHz]	Detector	Level [dBµV/m]
For emissions below 1 GHz, please look at the table below the 1 GHz plot.								
1023	Peak	24.8	-/-	Peak	-/-	1023	Peak	24.8
	QPK	-/-		QPK	-/-		QPK	-/-
1238	Peak	25.2	-/-	Peak	-/-	1238	Peak	25.2
	QPK	-/-		QPK	-/-		QPK	-/-
1370	Peak	27.1	-/-	Peak	-/-	1370	Peak	27.1
	QPK	-/-		AVG	-/-		QPK	-/-
1643	Peak	27.0	-/-	Peak	-/-	1643	Peak	27.0
	RMS	-/-		RMS	-/-		RMS	-/-
2120	Peak	29.3	-/-	Peak	-/-	2120	Peak	29.3
	RMS	-/-		RMS	-/-		RMS	-/-
2310	Peak	29.2	-/-	Peak	-/-	2337	Peak	31.0
	RMS	-/-		RMS	-/-		RMS	-/-
2507	Peak	30.2	-/-	Peak	-/-	2507	Peak	29.5
	RMS	-/-		RMS	-/-		RMS	-/-
3729	Peak	36.0	-/-	Peak	-/-	4795	Peak	52.8
	RMS	-/-		RMS	-/-		RMS	43.9
4785	Peak	52.4	-/-	Peak	-/-	7191	Peak	42.1
	RMS	42.0		RMS	-/-		RMS	-/-
7177	Peak	41.3	-/-	Peak	-/-	9589	Peak	41.7
	RMS	-/-		RMS	-/-		RMS	-/-
9570	Peak	41.0	-/-	Peak	-/-	14590	Peak	40.2
	RMS	-/-		RMS	-/-		RMS	-/-
17958	Peak	43.8	-/-	Peak	-/-	17958	Peak	43.8
	RMS	-/-		RMS	-/-		RMS	-/-
-/-	Peak	-/-	-/-	Peak	-/-	-/-	Peak	-/-
	RMS	-/-		RMS	-/-		RMS	-/-
For emissions above 18 GHz, please look at the plots.								

Plots: Module ID 248

Plot 1: 9 kHz – 30 MHz, channel low, lower band

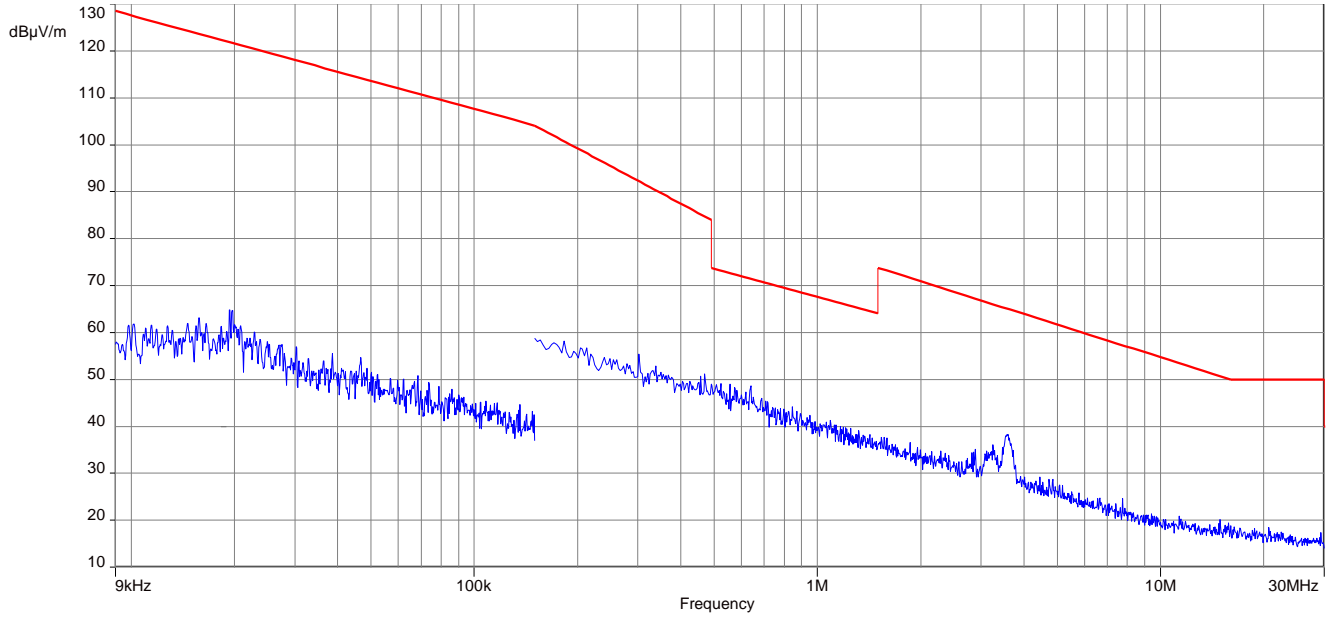

Plot 2: 30 MHz – 1 GHz, channel low, lower band

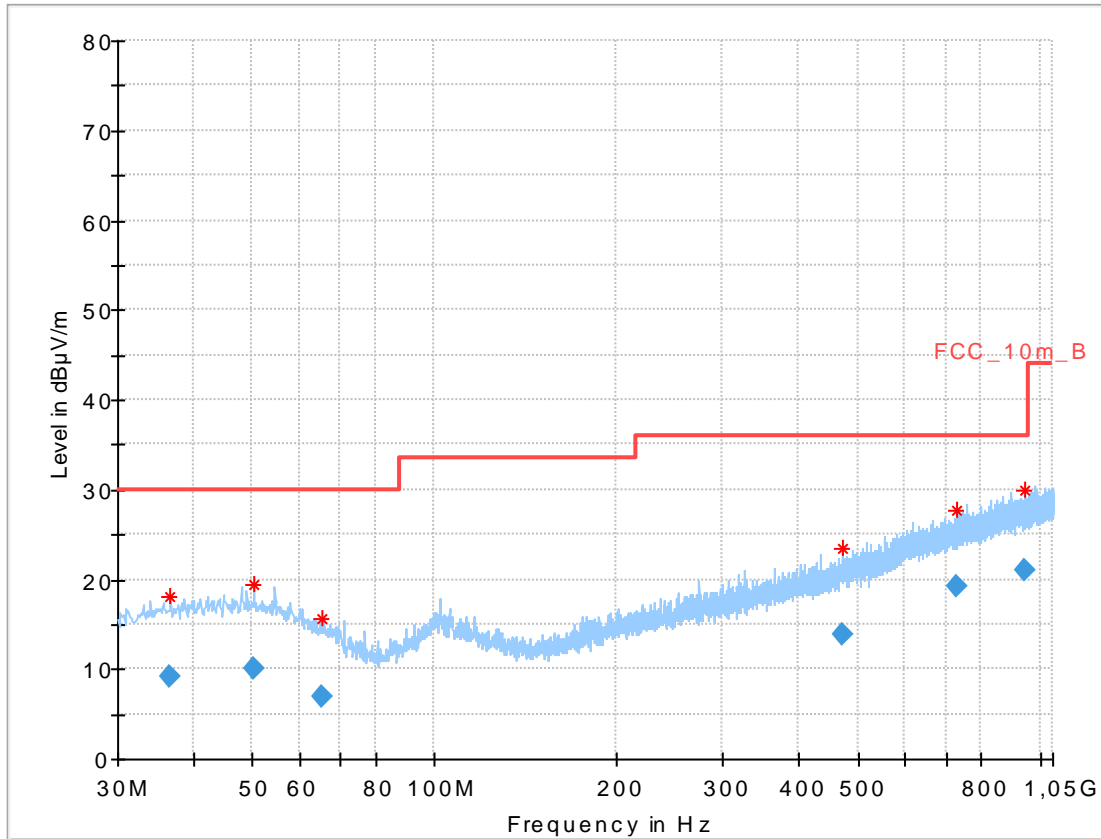

Final results:

Frequency (MHz)	QuasiPeak (dBµV/m)	Limit (dBµV/m)	Margin (dB)	Meas. Time (ms)	Bandwidth (kHz)	Height (cm)	Pol	Azimuth (deg)	Corr. (dB)
36.503400	9.20	30.00	20.80	1000.0	120.000	101.0	V	189.0	12.8
50.408400	10.01	30.00	19.99	1000.0	120.000	101.0	V	331.0	13.7
65.074500	6.98	30.00	23.02	1000.0	120.000	100.0	V	237.0	10.7
473.409900	13.94	36.00	22.06	1000.0	120.000	98.0	V	123.0	18.2
731.308350	19.18	36.00	16.82	1000.0	120.000	98.0	H	331.0	22.3
940.799700	21.03	36.00	14.97	1000.0	120.000	101.0	V	33.0	24.3

Plot 3: 1 GHz – 18 GHz, antenna horizontal/vertical, channel low, lower band

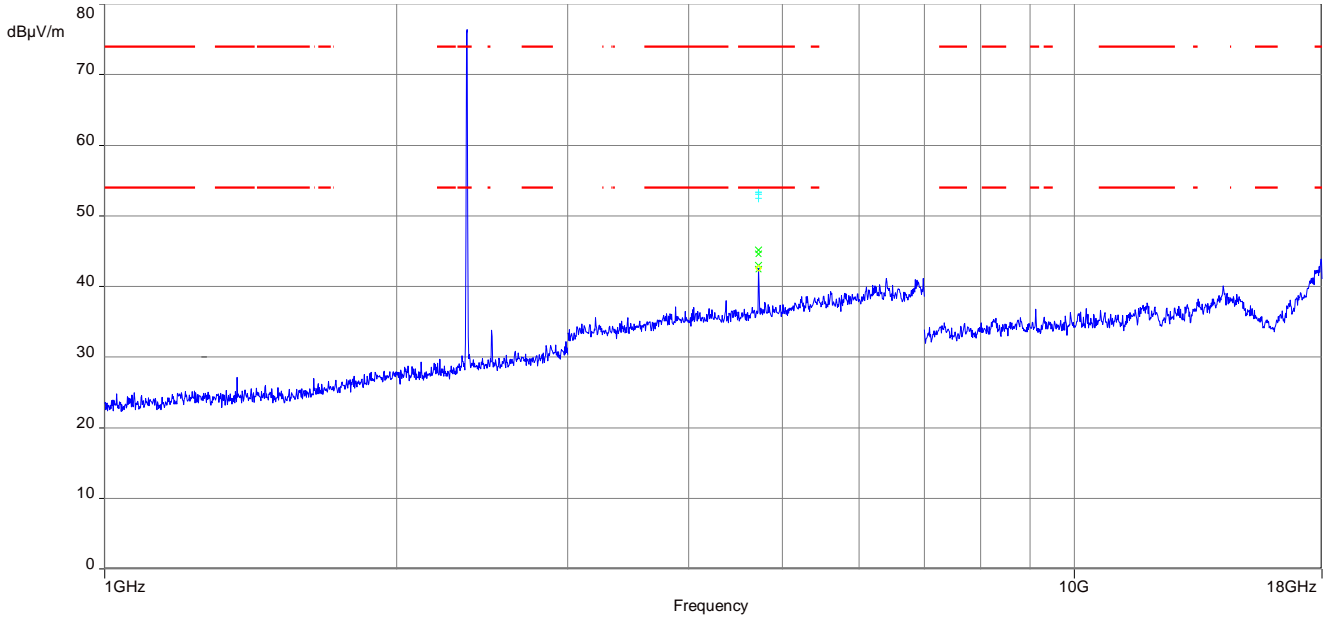

Plot 4: 18 GHz – 26 GHz, antenna horizontal/vertical, channel low, lower band

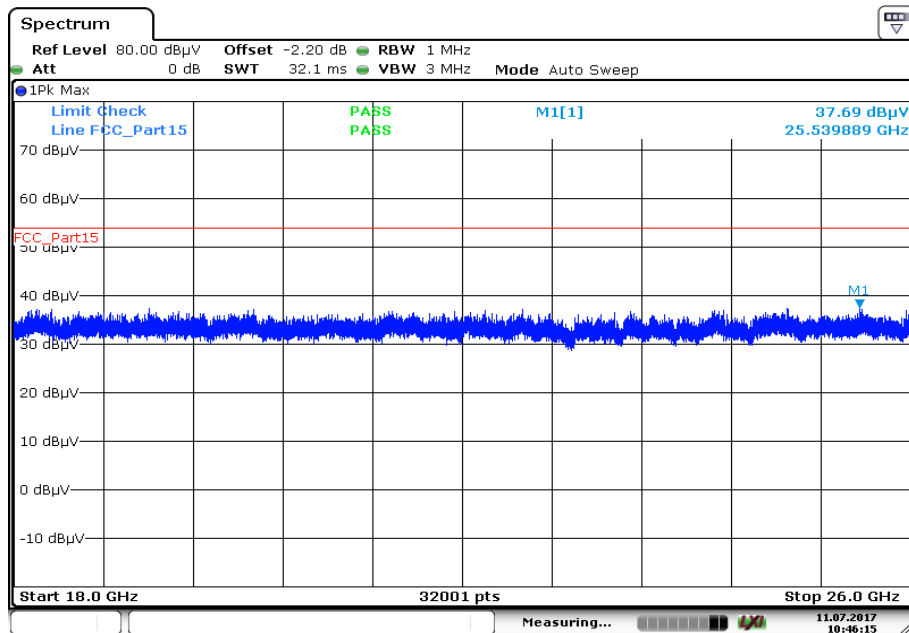

Date: 11.JUL.2017 10:46:15

Plot 5: 9 kHz – 30 MHz, channel mid, lower band

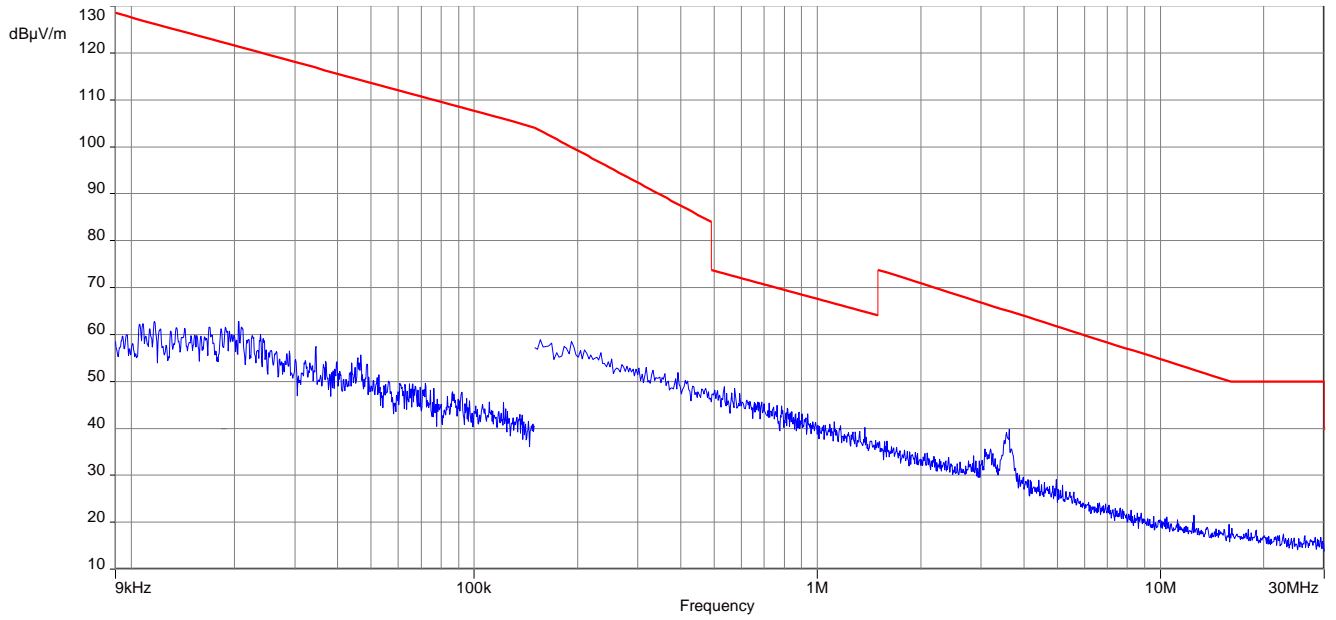

Plot 6: 30 MHz – 1 GHz, channel mid, lower band

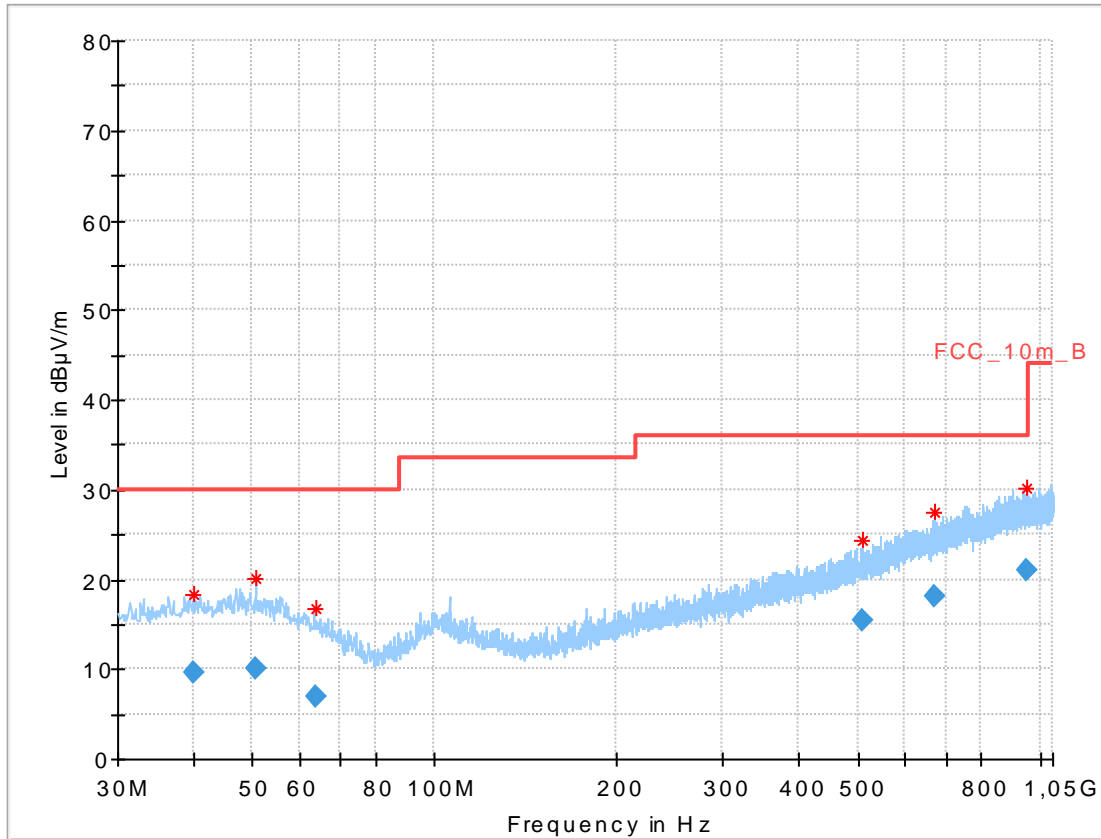

Final results:

Frequency (MHz)	QuasiPeak (dBµV/m)	Limit (dBµV/m)	Margin (dB)	Meas. Time (ms)	Bandwidth (kHz)	Height (cm)	Pol	Azimuth (deg)	Corr. (dB)
40.213650	9.67	30.00	20.33	1000.0	120.000	101.0	H	347.0	13.2
50.568750	9.98	30.00	20.02	1000.0	120.000	98.0	H	84.0	13.7
63.569250	7.01	30.00	22.99	1000.0	120.000	98.0	V	249.0	11.1
511.086000	15.46	36.00	20.54	1000.0	120.000	101.0	V	338.0	18.9
672.253200	18.20	36.00	17.80	1000.0	120.000	98.0	H	0.0	21.3
948.358350	21.11	36.00	14.89	1000.0	120.000	101.0	H	171.0	24.3

Plot 7: 1 GHz – 18 GHz, antenna horizontal/vertical, channel mid, lower band

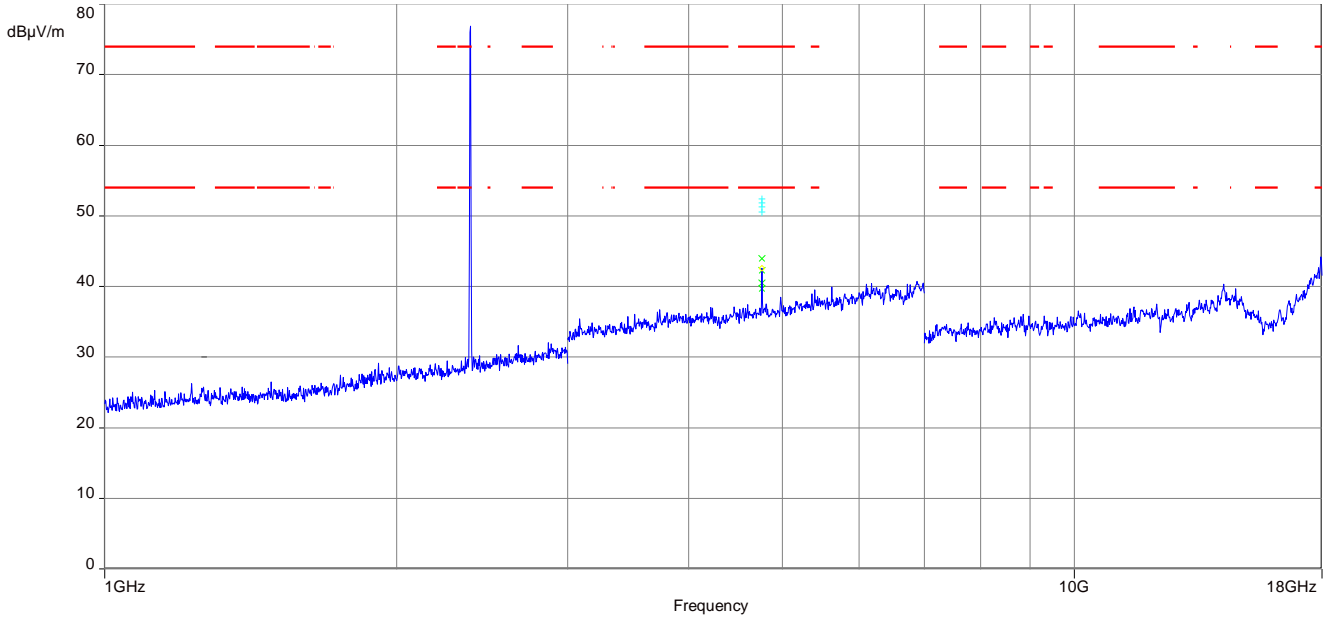

Plot 8: 18 GHz – 26 GHz, antenna horizontal/vertical, channel mid, lower band

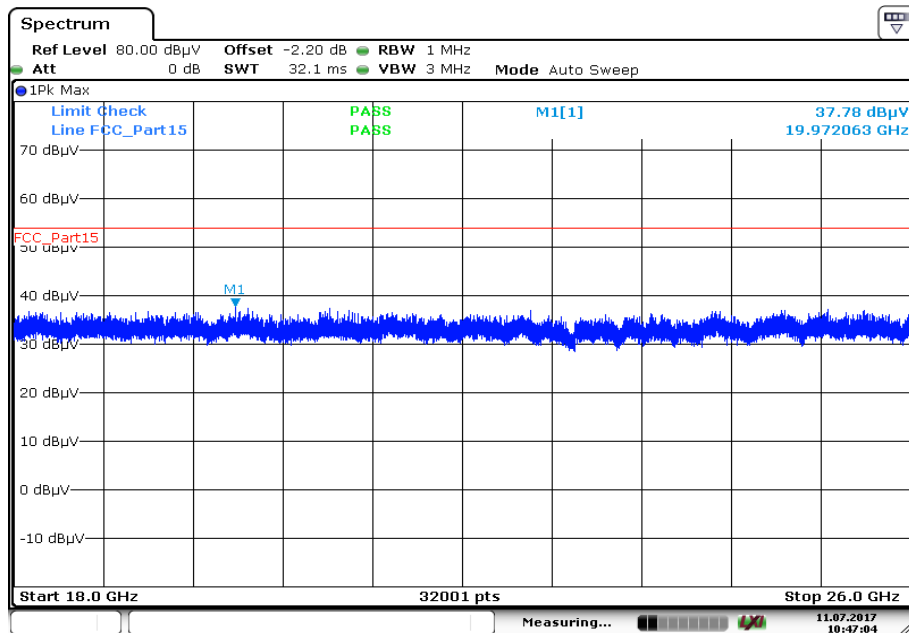

Date: 11.JUL.2017 10:47:04

Plot 9: 9 kHz – 30 MHz, channel high, lower band

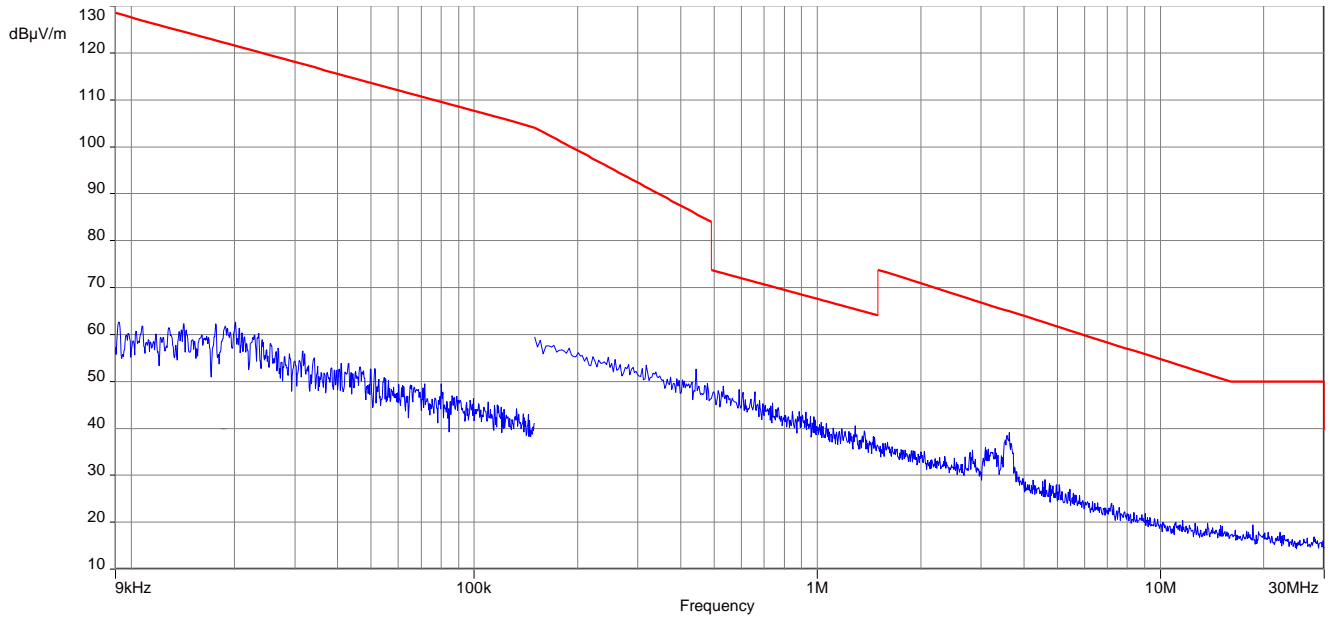

Plot 10: 30 MHz – 1 GHz, channel high, lower band

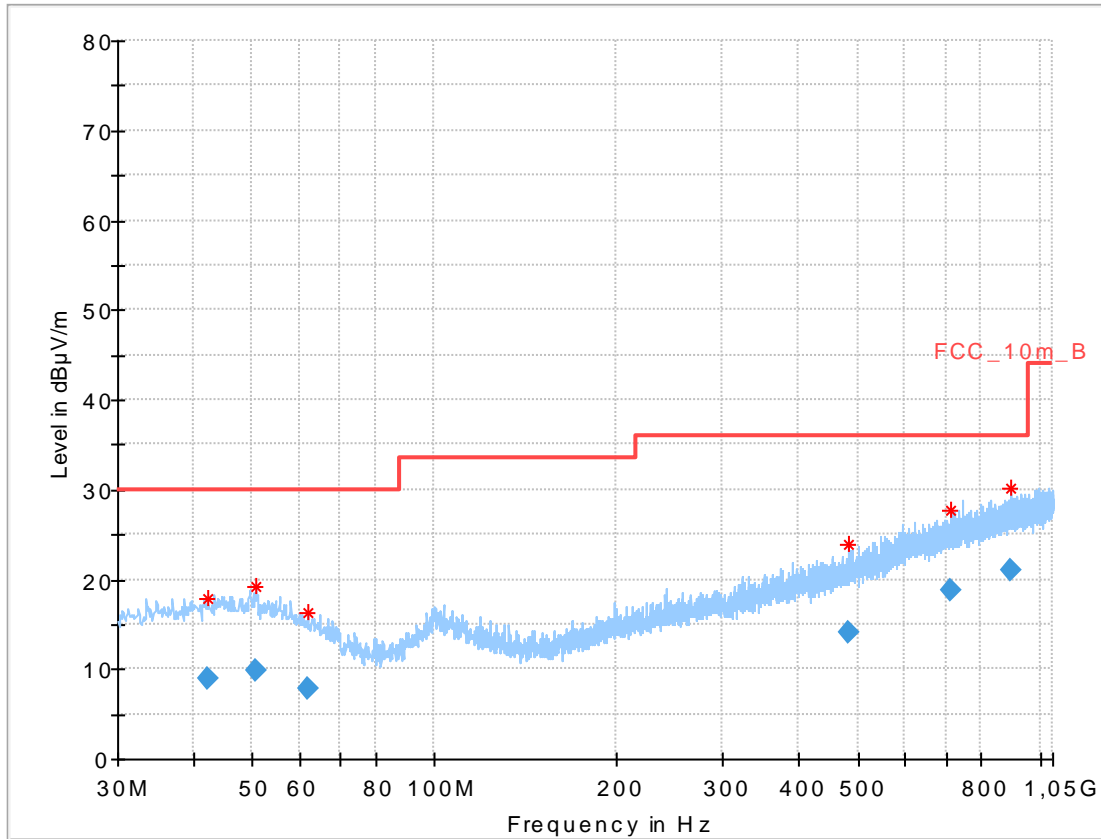

Final results:

Frequency (MHz)	QuasiPeak (dBµV/m)	Limit (dBµV/m)	Margin (dB)	Meas. Time (ms)	Bandwidth (kHz)	Height (cm)	Pol	Azimuth (deg)	Corr. (dB)
42.326550	8.84	30.00	21.16	1000.0	120.000	101.0	H	198.0	13.4
50.699250	9.89	30.00	20.11	1000.0	120.000	98.0	H	273.0	13.6
61.861800	7.80	30.00	22.20	1000.0	120.000	98.0	V	322.0	11.4
483.283800	14.02	36.00	21.98	1000.0	120.000	98.0	V	353.0	18.4
711.316200	18.72	36.00	17.28	1000.0	120.000	98.0	H	76.0	21.8
897.600900	21.00	36.00	15.00	1000.0	120.000	98.0	H	168.0	24.2

Plot 11: 1 GHz – 18 GHz, antenna horizontal/vertical, channel high, lower band

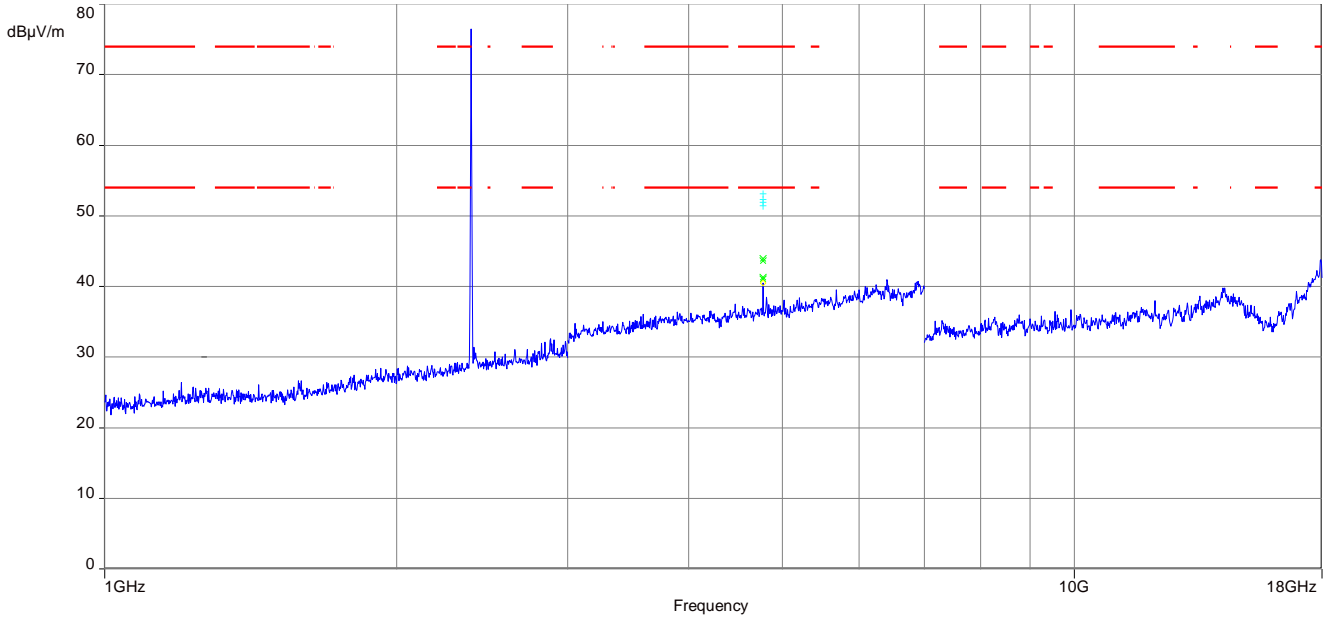

Plot 12: 18 GHz – 26 GHz, antenna horizontal/vertical, channel high, lower band

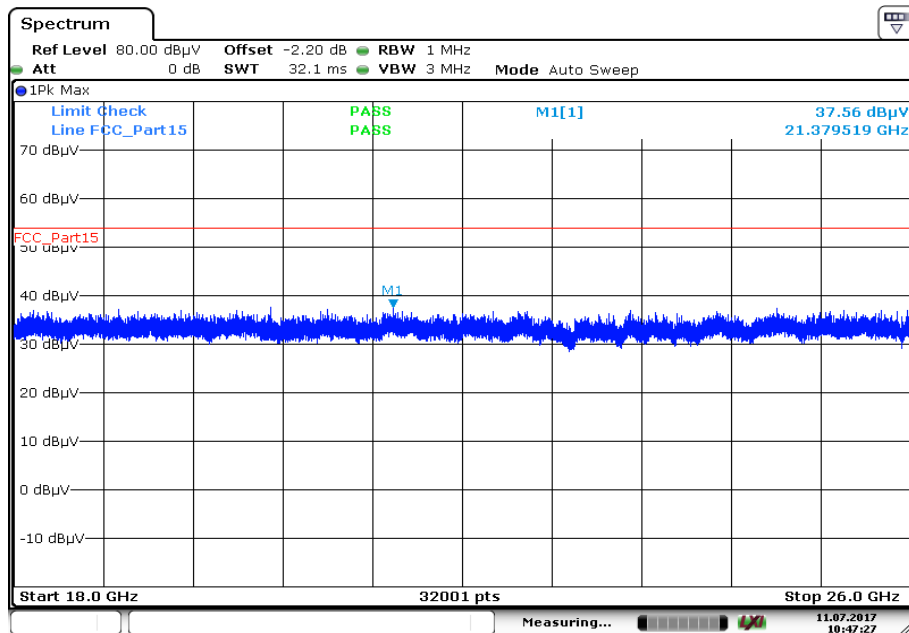

Date: 11.JUL.2017 10:47:27

Plot 13: 9 kHz – 30 MHz, channel low, upper band

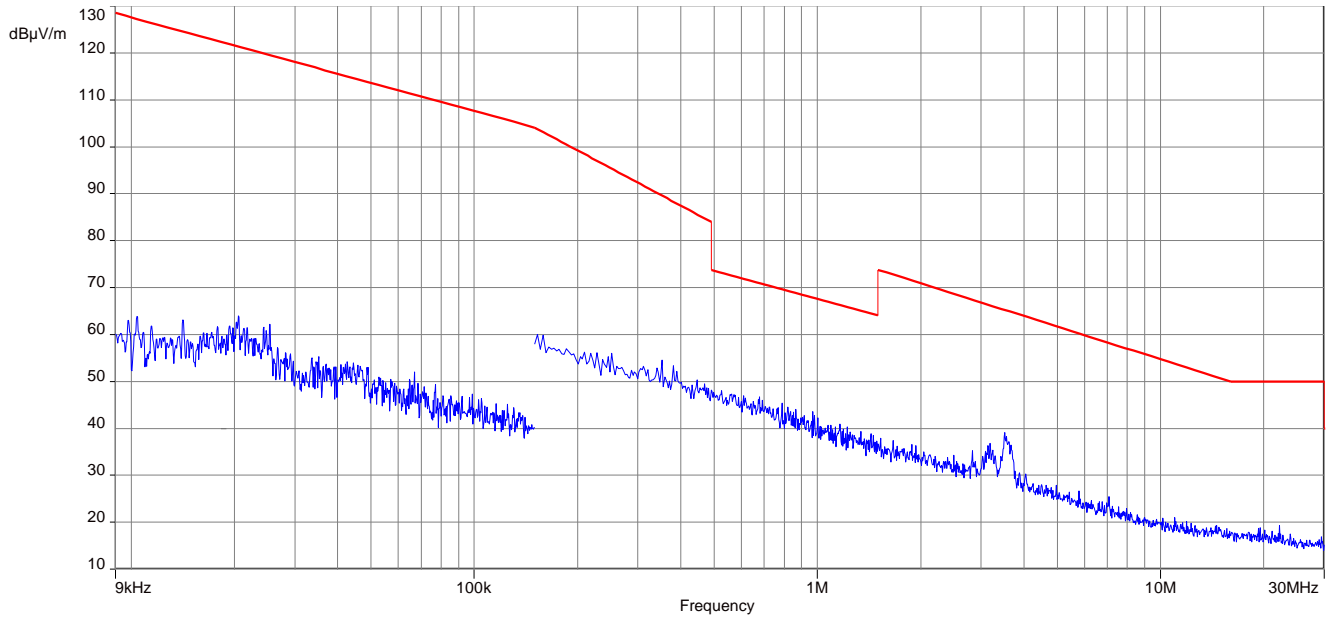

Plot 14: 30 MHz – 1 GHz, channel low, upper band

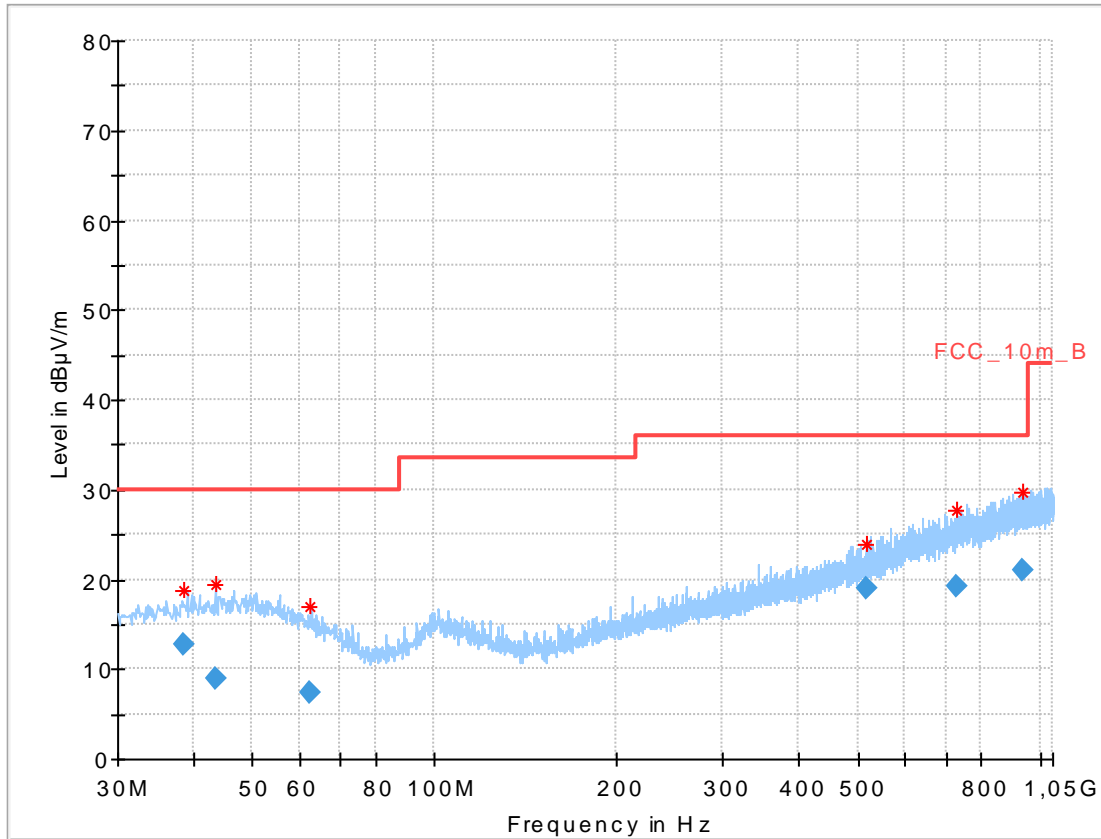

Final results:

Frequency (MHz)	QuasiPeak (dBµV/m)	Limit (dBµV/m)	Margin (dB)	Meas. Time (ms)	Bandwidth (kHz)	Height (cm)	Pol	Azimuth (deg)	Corr. (dB)
38.701050	12.79	30.00	17.21	1000.0	120.000	101.0	V	123.0	13.1
43.572450	8.92	30.00	21.08	1000.0	120.000	101.0	H	94.0	13.5
62.365050	7.48	30.00	22.52	1000.0	120.000	101.0	H	36.0	11.3
515.414100	19.07	36.00	16.93	1000.0	120.000	101.0	V	308.0	18.9
729.113700	19.13	36.00	16.87	1000.0	120.000	98.0	V	70.0	22.2
935.726550	20.96	36.00	15.04	1000.0	120.000	100.0	V	135.0	24.3

Plot 15: 1 GHz – 18 GHz, antenna horizontal/vertical, channel low, upper band

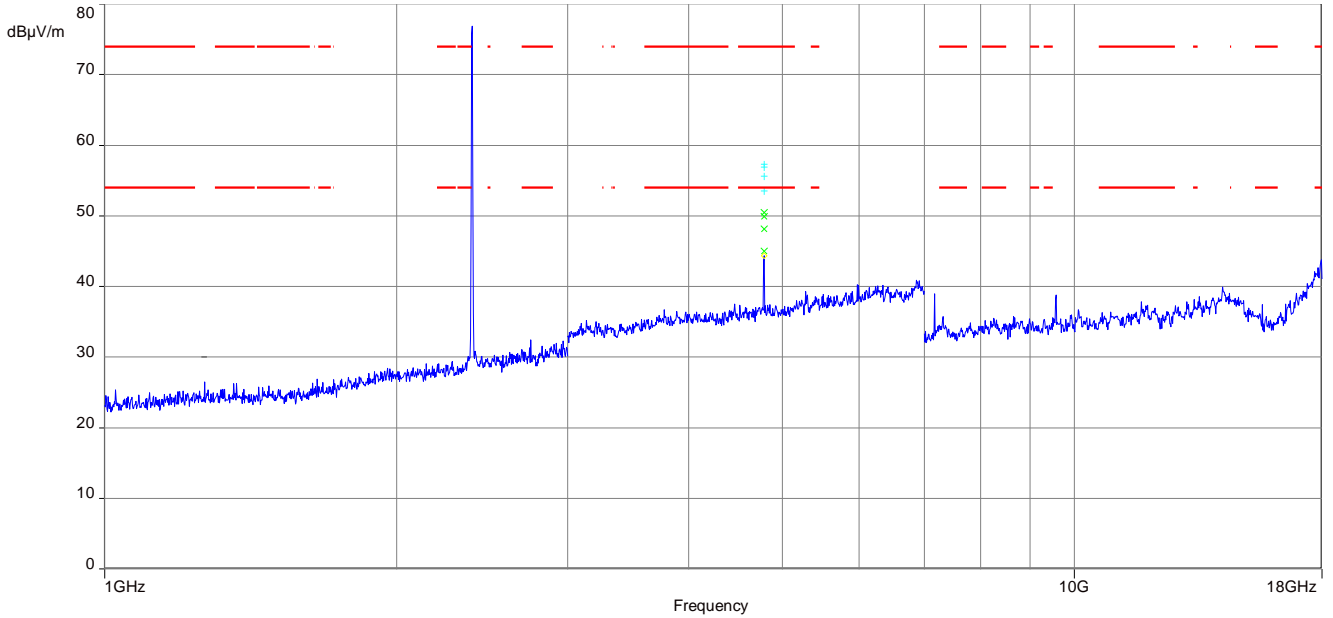

Plot 16: 18 GHz – 26 GHz, antenna horizontal/vertical, channel low, upper band

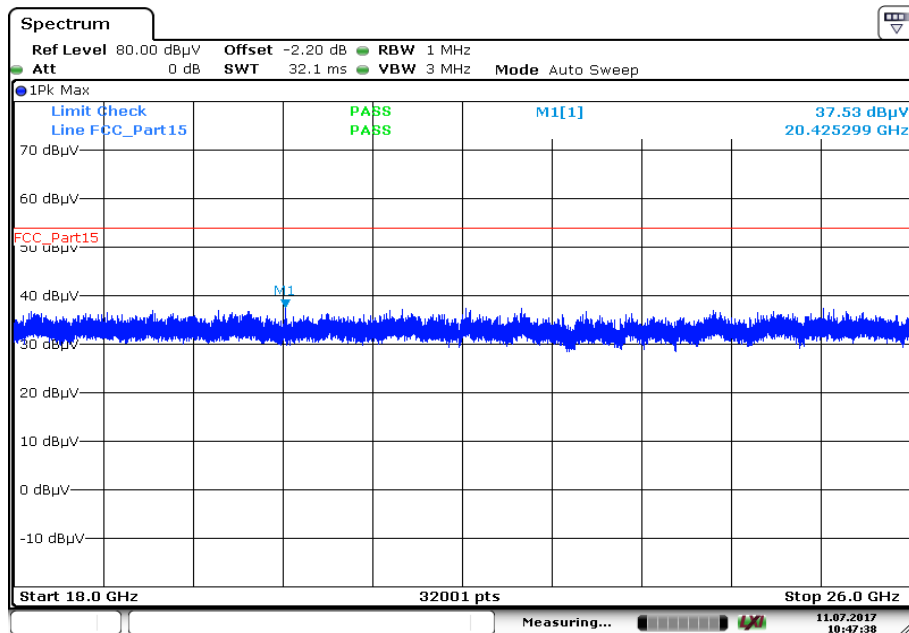

Date: 11.JUL.2017 10:47:38

Plot 17: 9 kHz – 30 MHz, channel high, upper band

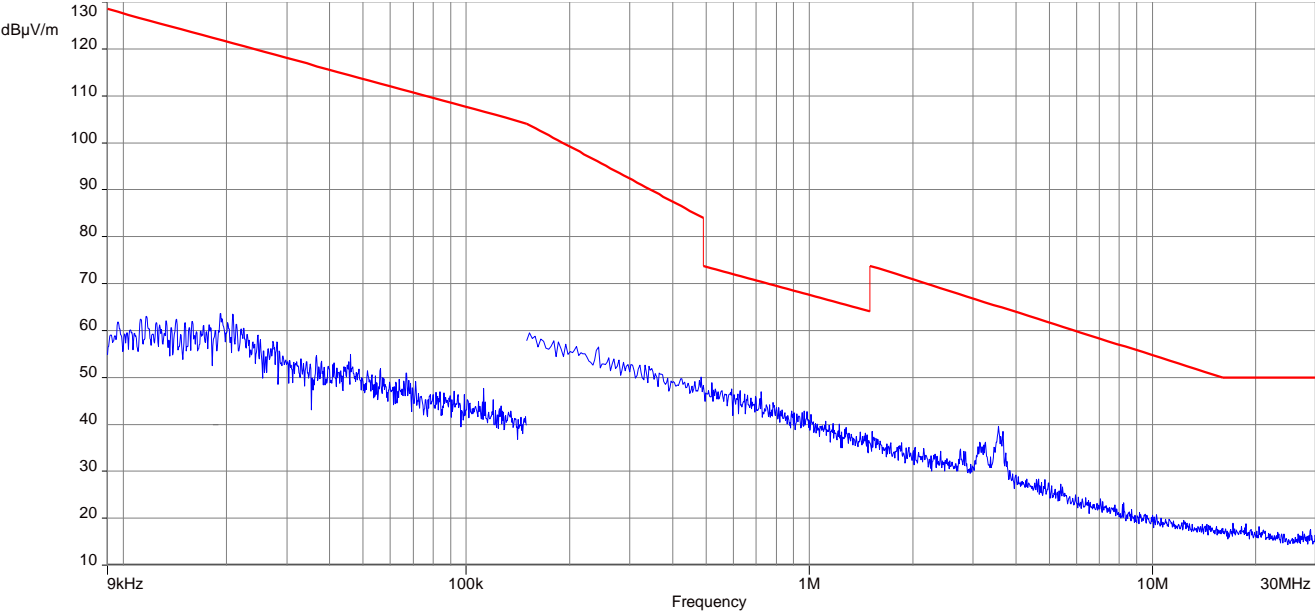

Plot 18: 30 MHz – 1 GHz, channel high, upper band

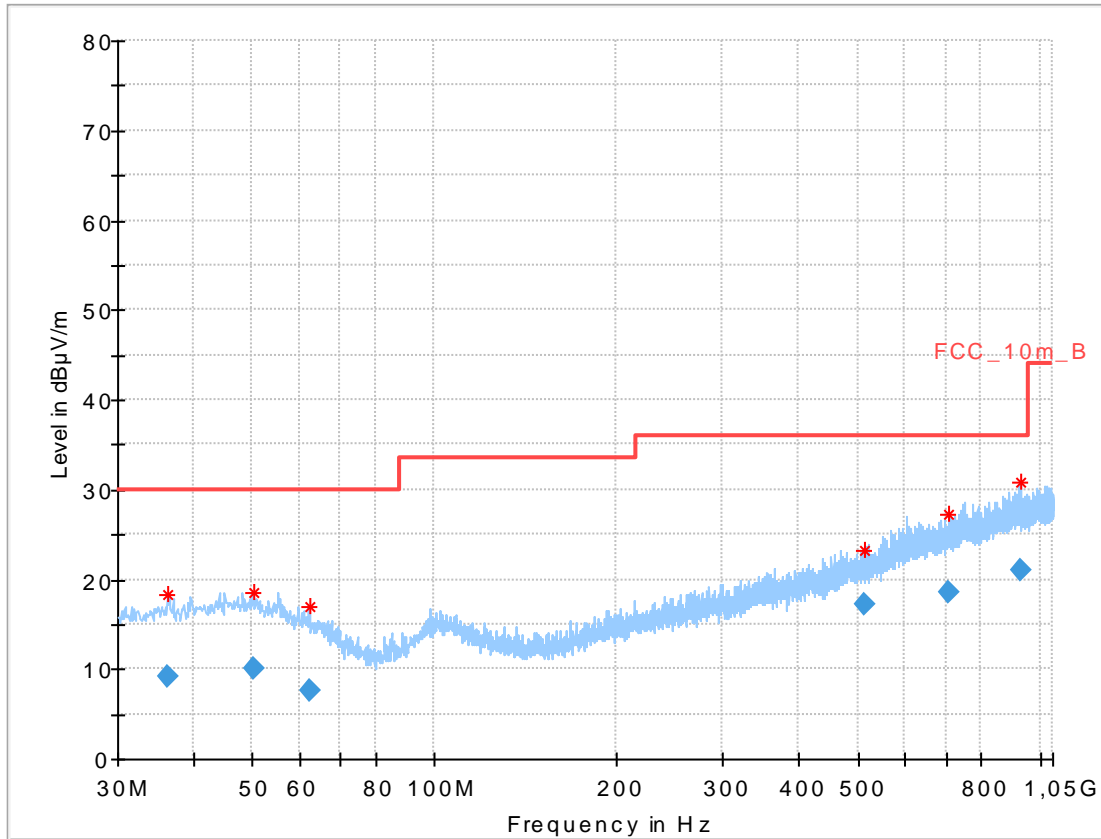

Final results:

Frequency (MHz)	QuasiPeak (dBµV/m)	Limit (dBµV/m)	Margin (dB)	Meas. Time (ms)	Bandwidth (kHz)	Height (cm)	Pol	Azimuth (deg)	Corr. (dB)
36.251250	9.13	30.00	20.87	1000.0	120.000	101.0	H	33.0	12.8
50.341050	9.98	30.00	20.02	1000.0	120.000	98.0	V	126.0	13.7
62.172300	7.56	30.00	22.44	1000.0	120.000	98.0	H	82.0	11.4
511.975950	17.20	36.00	18.80	1000.0	120.000	98.0	V	137.0	18.9
704.130600	18.54	36.00	17.46	1000.0	120.000	101.0	V	216.0	21.6
927.082950	20.99	36.00	15.01	1000.0	120.000	98.0	V	180.0	24.3

Plot 19: 1 GHz – 18 GHz, antenna horizontal/vertical, channel high, upper band

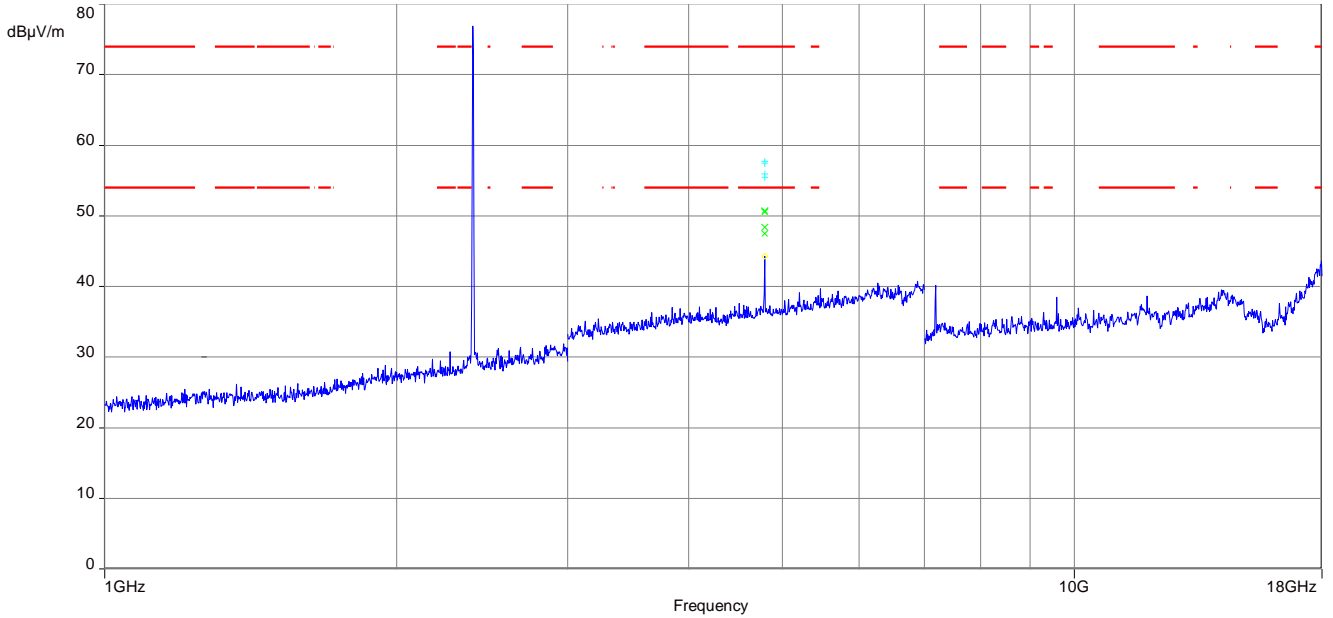

Plot 20: 18 GHz – 26 GHz, antenna horizontal/vertical, channel high, upper band

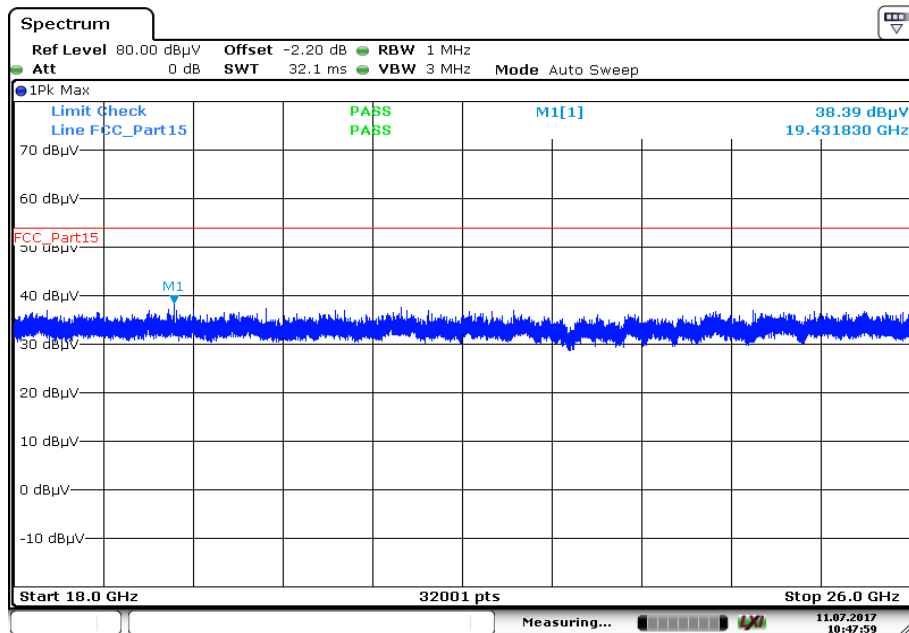

Date: 11.JUL.2017 10:47:59

Plots: Module ID 251

Plot 1: 9 kHz – 30 MHz, channel low, lower band

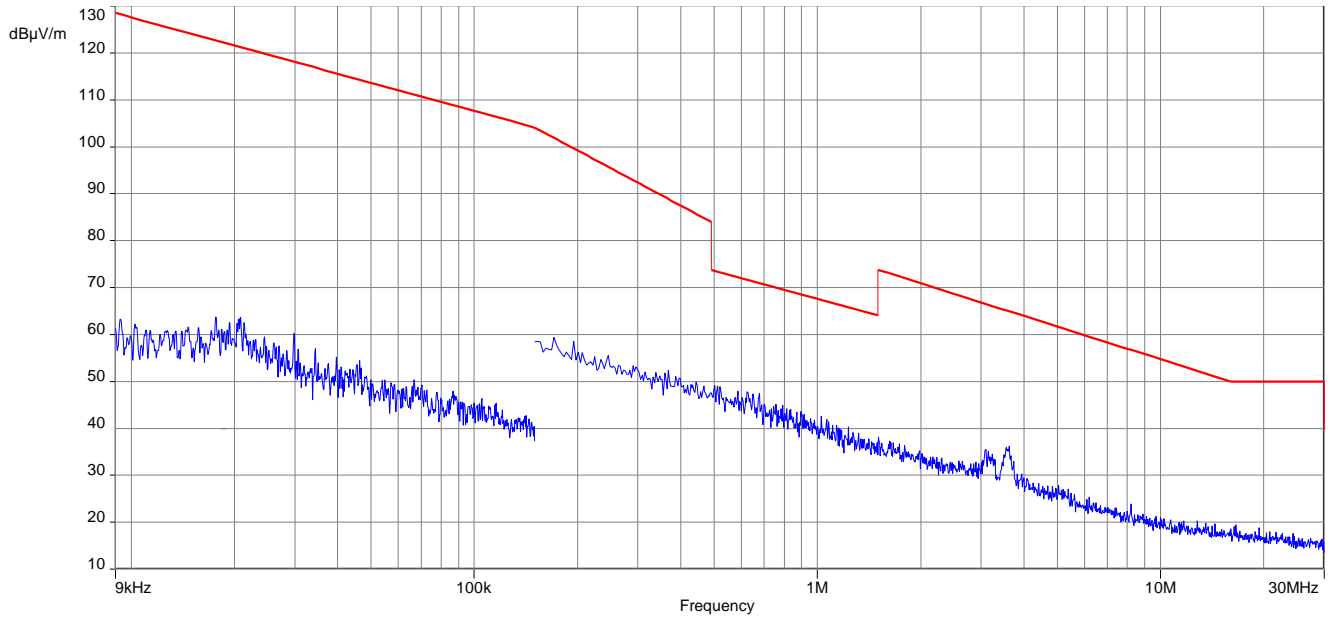

Plot 2: 30 MHz – 1 GHz, channel low, lower band

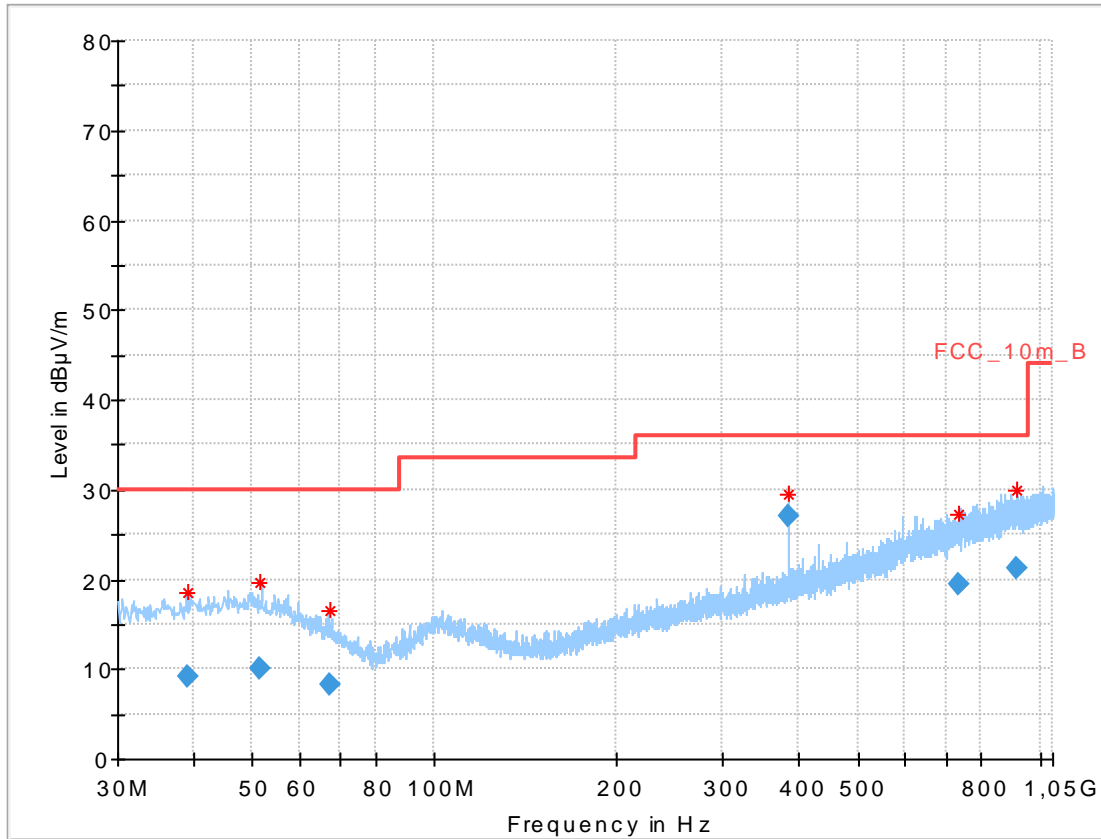

Final results:

Frequency (MHz)	QuasiPeak (dBµV/m)	Limit (dBµV/m)	Margin (dB)	Meas. Time (ms)	Bandwidth (kHz)	Height (cm)	Pol	Azimuth (deg)	Corr. (dB)
39.146550	9.16	30.00	20.84	1000.0	120.000	101.0	H	236.0	13.1
51.407400	10.00	30.00	20.00	1000.0	120.000	98.0	V	17.0	13.5
67.059450	8.18	30.00	21.82	1000.0	120.000	101.0	H	322.0	10.3
383.982000	27.10	36.00	8.90	1000.0	120.000	98.0	V	355.0	16.6
733.580250	19.39	36.00	16.61	1000.0	120.000	178.0	V	291.0	22.3
914.460600	21.19	36.00	14.81	1000.0	120.000	98.0	V	130.0	24.2

Plot 3: 1 GHz – 18 GHz, antenna horizontal/vertical, channel low, lower band

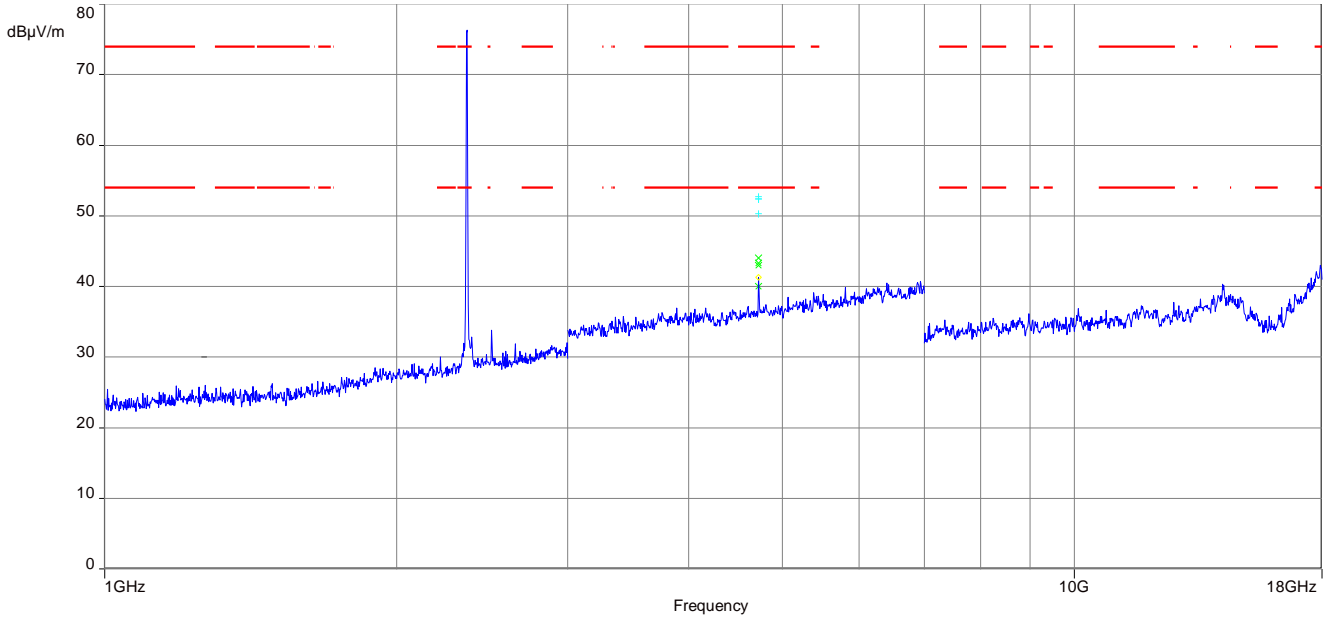

Plot 4: 18 GHz – 26 GHz, antenna horizontal/vertical, channel low, lower band

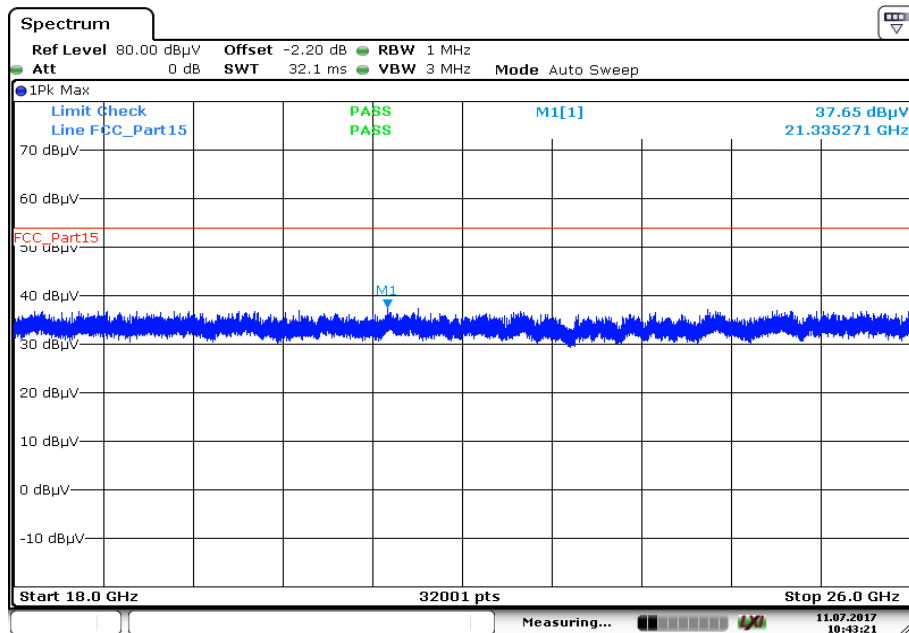

Date: 11.JUL.2017 10:43:22

Plot 5: 9 kHz – 30 MHz, channel mid, lower band

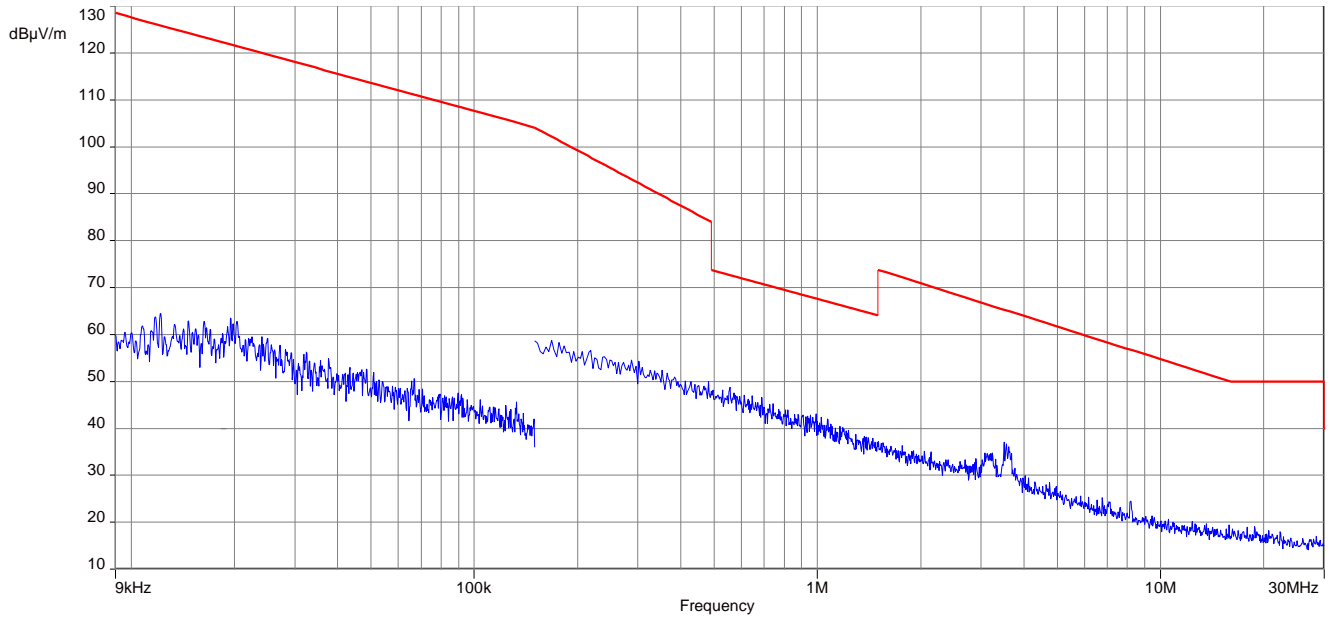

Plot 6: 30 MHz – 1 GHz, channel mid, lower band

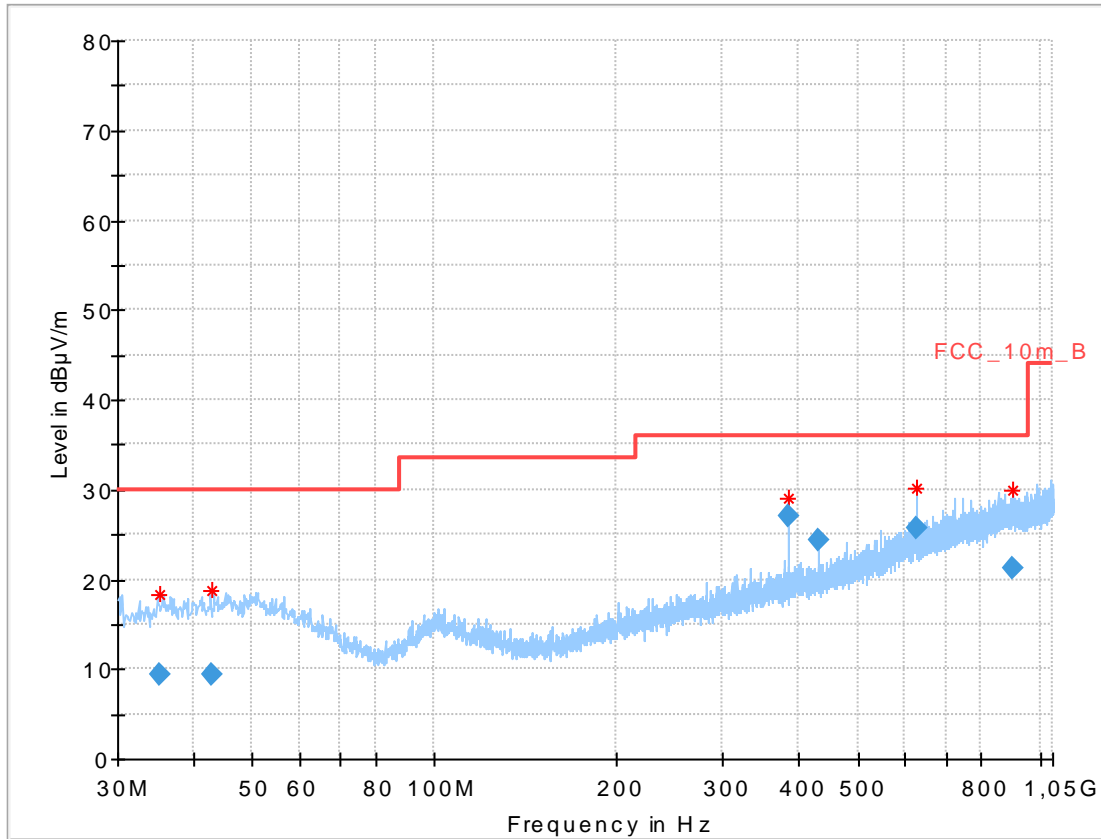

Final results:

Frequency (MHz)	QuasiPeak (dBµV/m)	Limit (dBµV/m)	Margin (dB)	Meas. Time (ms)	Bandwidth (kHz)	Height (cm)	PoI	Azimuth (deg)	Corr. (dB)
35.322750	9.37	30.00	20.63	1000.0	120.000	101.0	V	20.0	12.7
42.967950	9.32	30.00	20.68	1000.0	120.000	101.0	V	295.0	13.5
383.980050	27.10	36.00	8.90	1000.0	120.000	98.0	V	20.0	16.6
432.010500	24.29	36.00	11.71	1000.0	120.000	98.0	V	0.0	17.4
623.980650	25.79	36.00	10.21	1000.0	120.000	101.0	H	107.0	20.9
901.903200	21.12	36.00	14.88	1000.0	120.000	101.0	H	285.0	24.2

Plot 7: 1 GHz – 18 GHz, antenna horizontal/vertical, channel mid, lower band

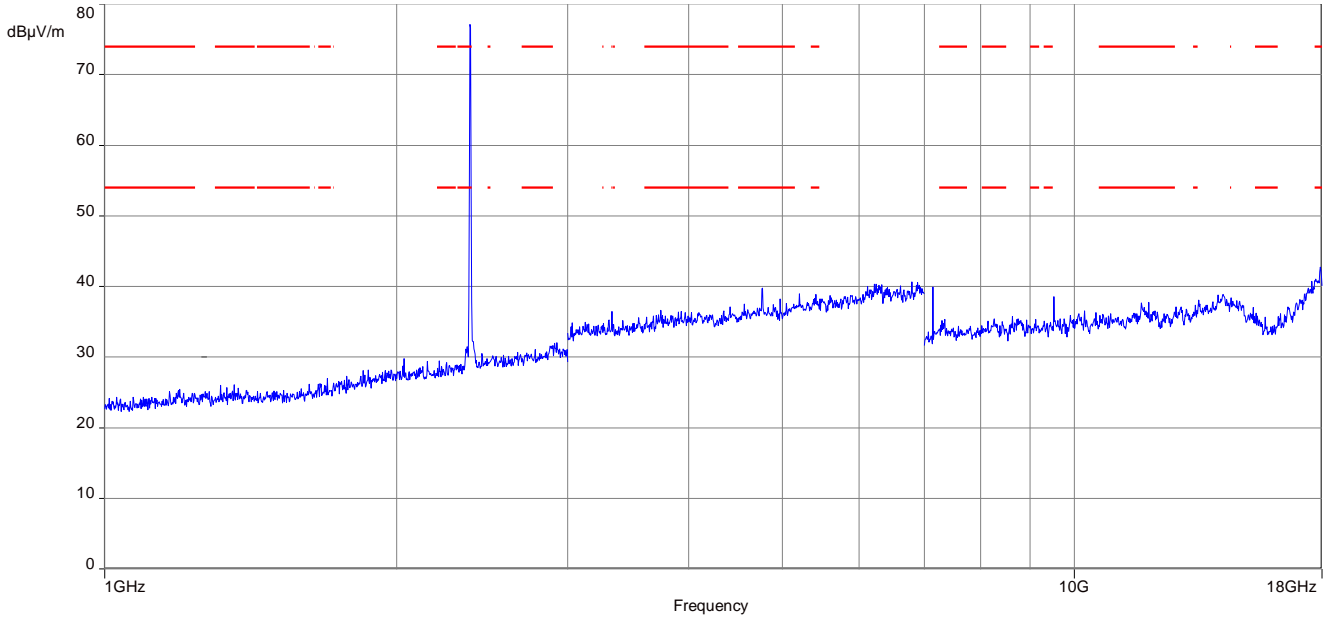

Plot 8: 18 GHz – 26 GHz, antenna horizontal/vertical, channel mid, lower band

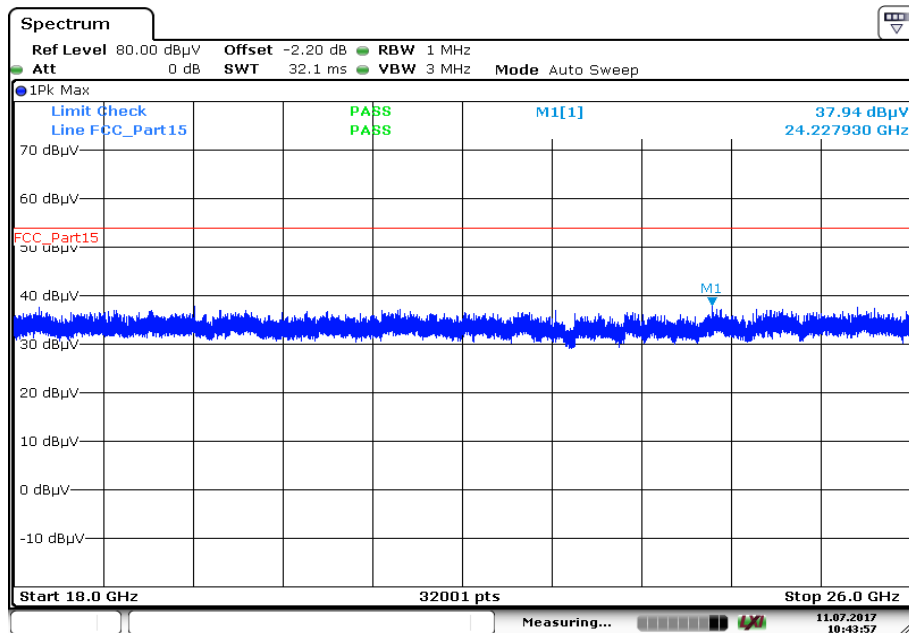

Plot 9: 9 kHz – 30 MHz, channel high, lower band

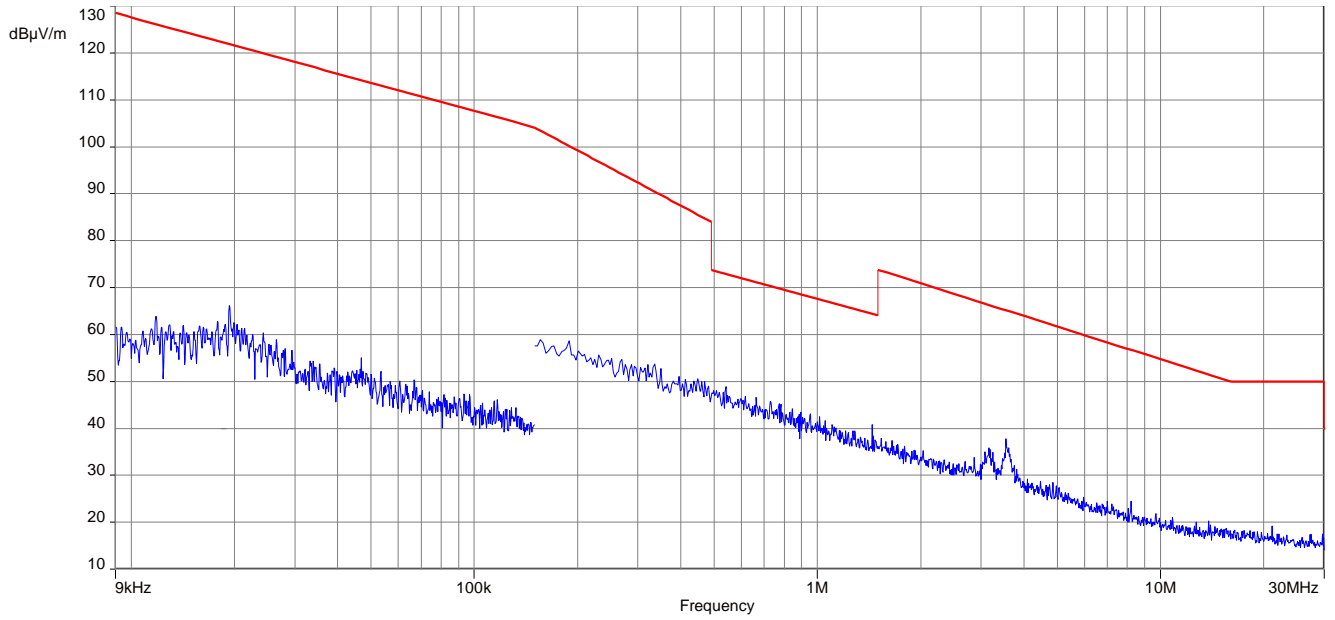

Plot 10: 30 MHz – 1 GHz, channel high, lower band

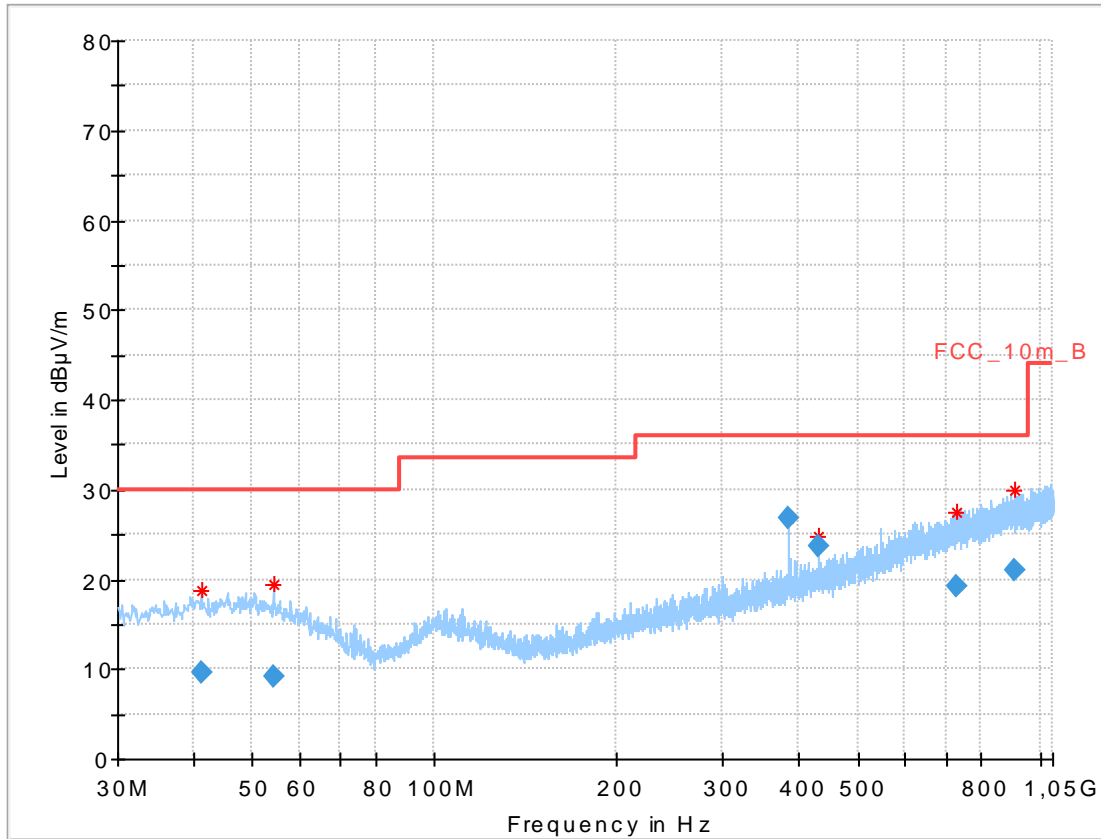

Final results:

Frequency (MHz)	QuasiPeak (dBµV/m)	Limit (dBµV/m)	Margin (dB)	Meas. Time (ms)	Bandwidth (kHz)	Height (cm)	Pol	Azimuth (deg)	Corr. (dB)
41.291400	9.58	30.00	20.42	1000.0	120.000	101.0	H	31.0	13.3
54.399300	9.22	30.00	20.78	1000.0	120.000	185.0	H	146.0	13.2
383.985150	26.85	36.00	9.15	1000.0	120.000	98.0	V	355.0	16.6
432.013800	23.74	36.00	12.26	1000.0	120.000	98.0	V	146.0	17.4
728.268300	19.21	36.00	16.79	1000.0	120.000	181.0	H	0.0	22.2
905.225700	21.04	36.00	14.96	1000.0	120.000	101.0	V	200.0	24.2

Plot 11: 1 GHz – 18 GHz, antenna horizontal/vertical, channel high, lower band

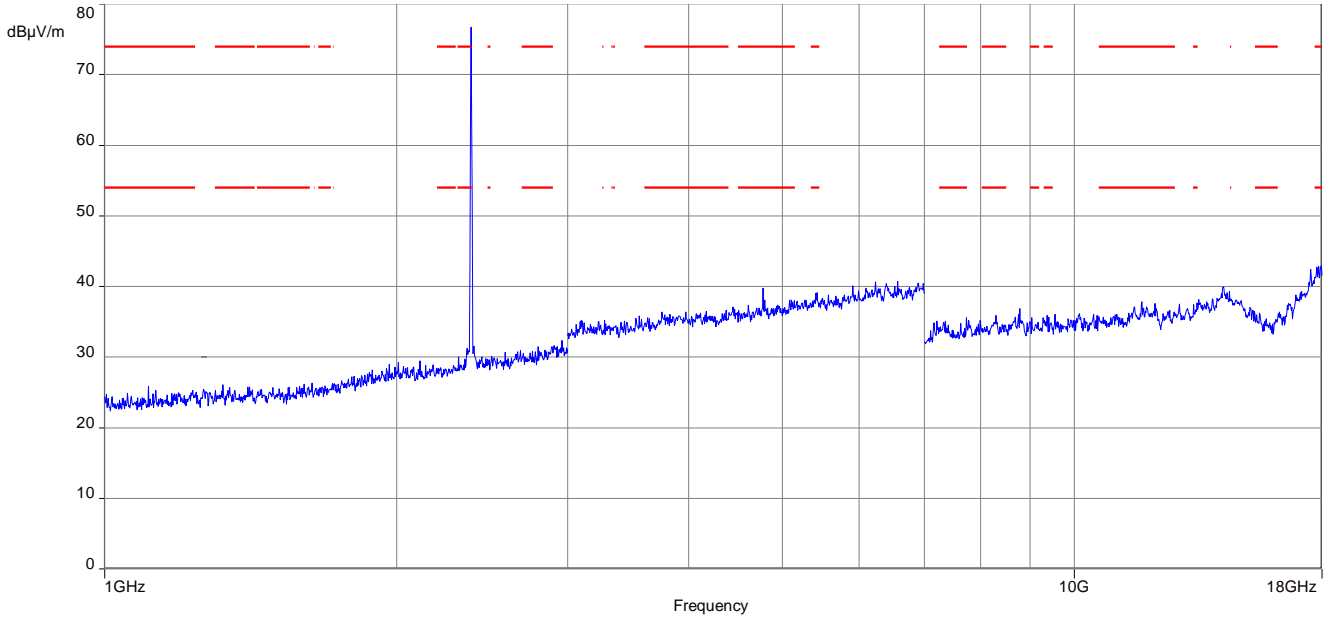

Plot 12: 18 GHz – 26 GHz, antenna horizontal/vertical, channel high, lower band

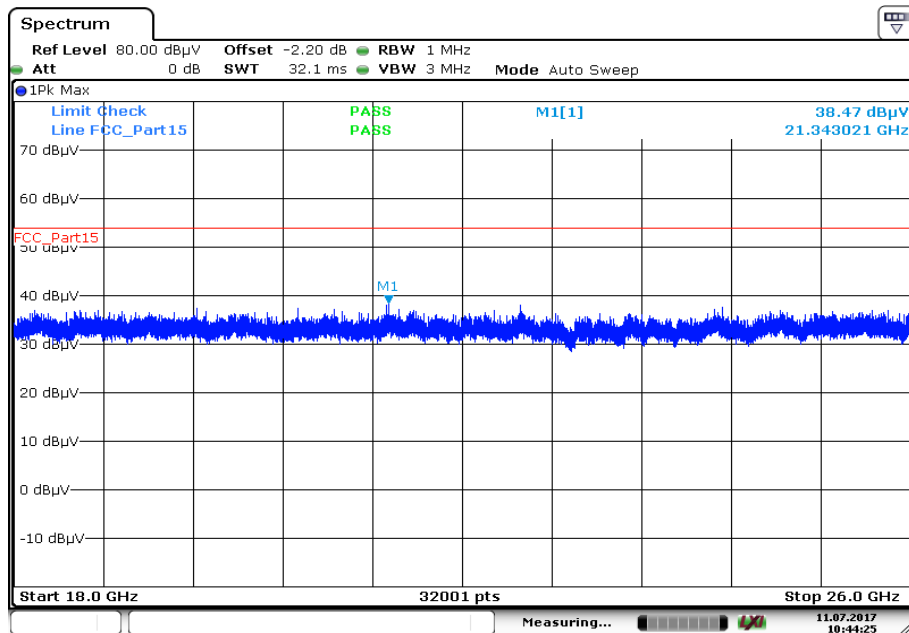

Date: 11.JUL.2017 10:44:25

Plot 13: 9 kHz – 30 MHz, channel low, upper band

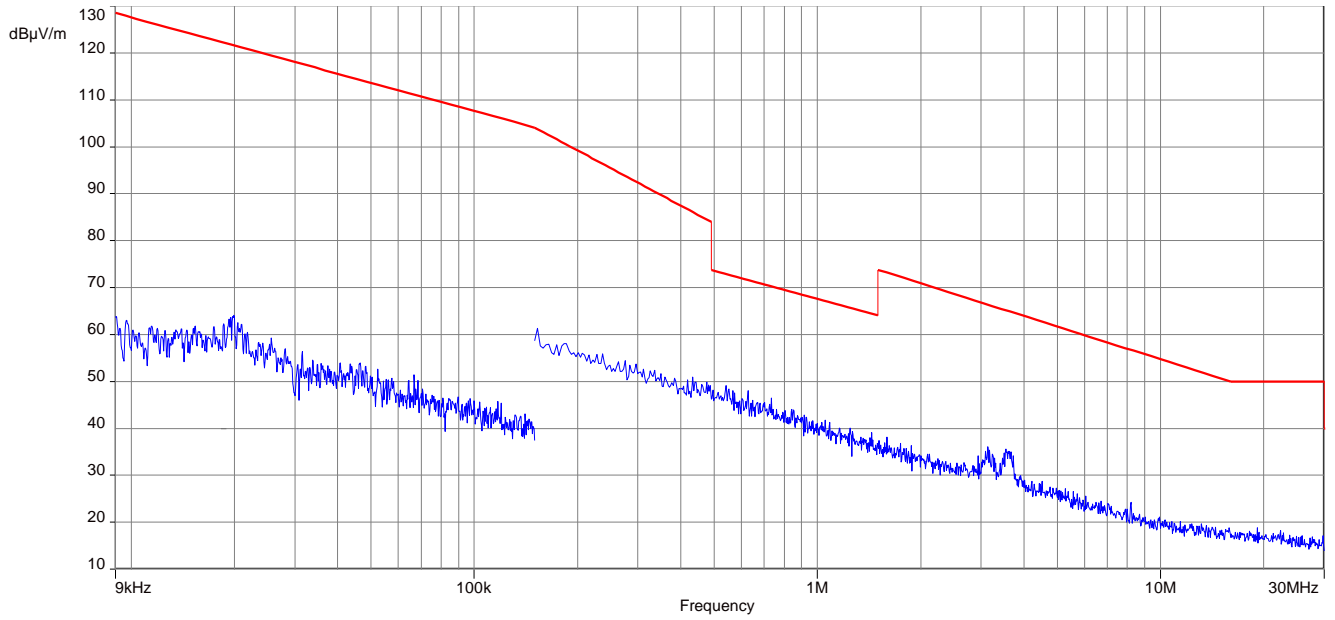

Plot 14: 30 MHz – 1 GHz, channel low, upper band

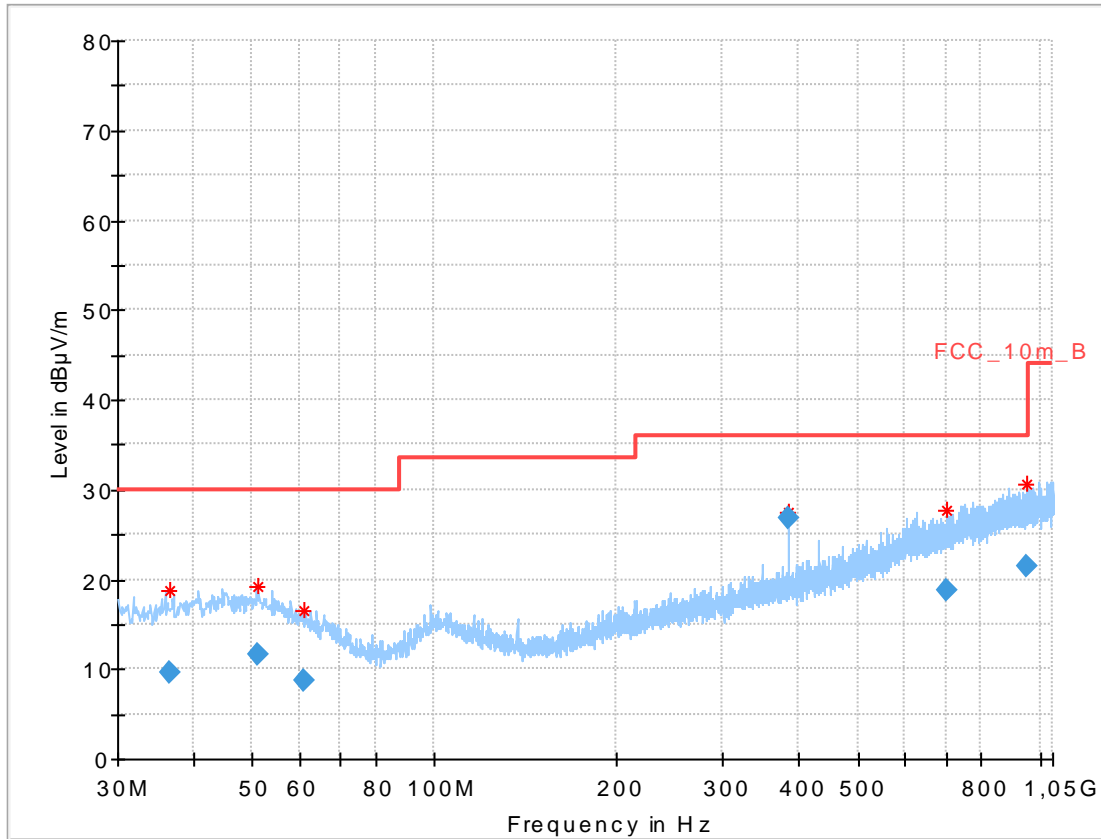

Final results:

Frequency (MHz)	QuasiPeak (dBµV/m)	Limit (dBµV/m)	Margin (dB)	Meas. Time (ms)	Bandwidth (kHz)	Height (cm)	Pol	Azimuth (deg)	Corr. (dB)
36.592350	9.54	30.00	20.46	1000.0	120.000	101.0	V	133.0	12.8
50.980800	11.66	30.00	18.34	1000.0	120.000	101.0	V	86.0	13.6
60.790950	8.69	30.00	21.31	1000.0	120.000	101.0	V	133.0	11.7
383.997750	26.77	36.00	9.23	1000.0	120.000	98.0	V	205.0	16.6
702.513300	18.87	36.00	17.13	1000.0	120.000	185.0	V	169.0	21.6
950.445000	21.46	36.00	14.54	1000.0	120.000	185.0	V	126.0	24.3

Plot 15: 1 GHz – 18 GHz, antenna horizontal/vertical, channel low, upper band

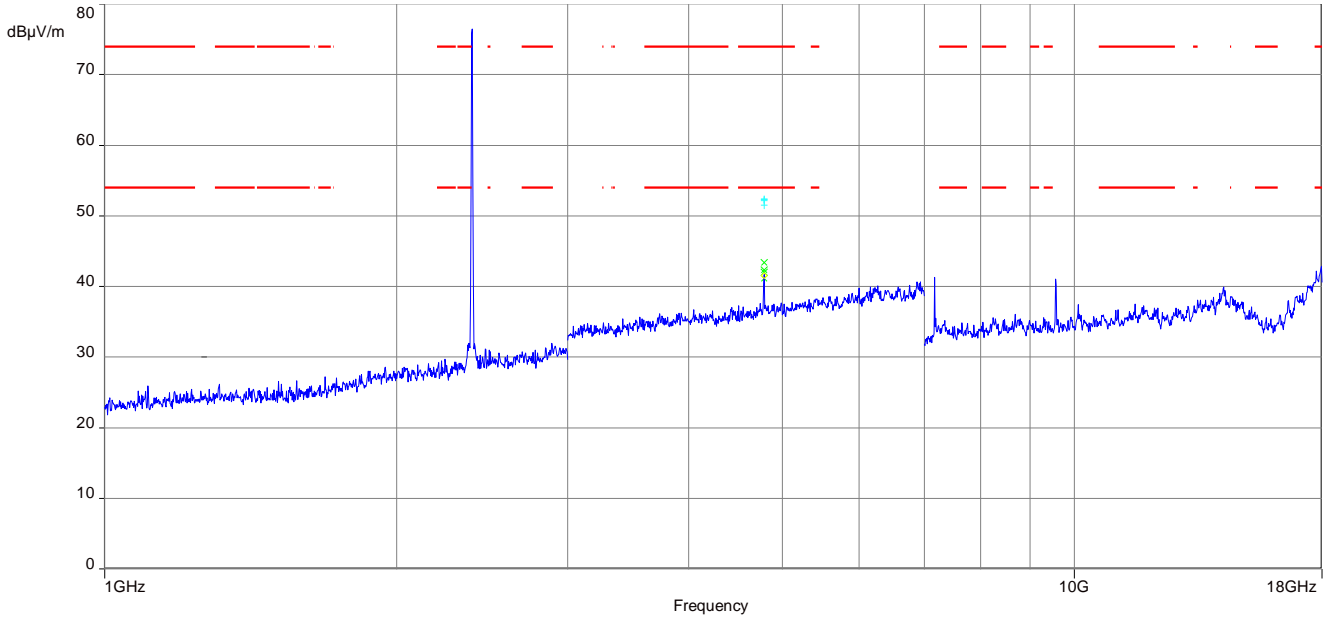

Plot 16: 18 GHz – 26 GHz, antenna horizontal/vertical, channel low, upper band

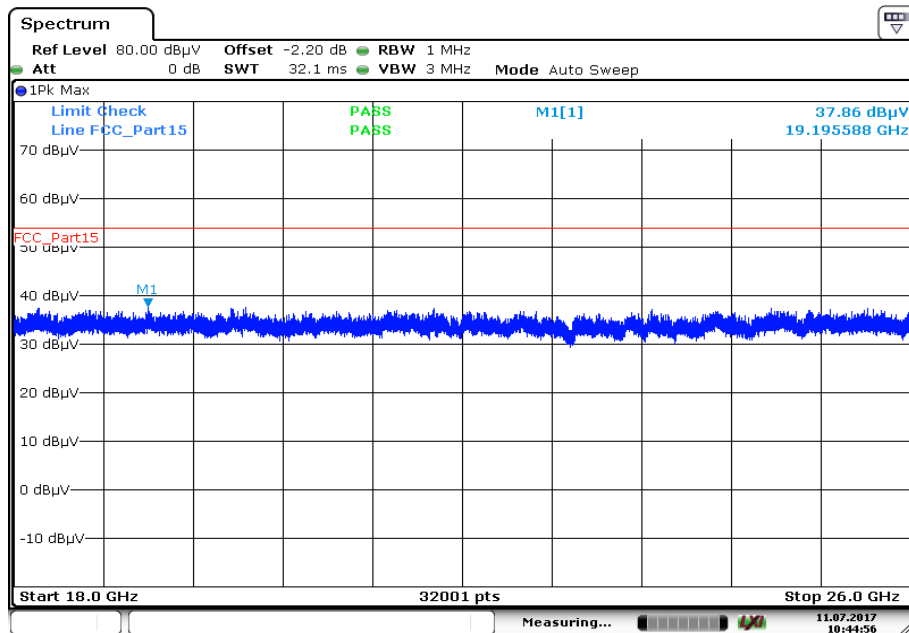

Date: 11.JUL.2017 10:44:57

Plot 17: 9 kHz – 30 MHz, channel high, upper band

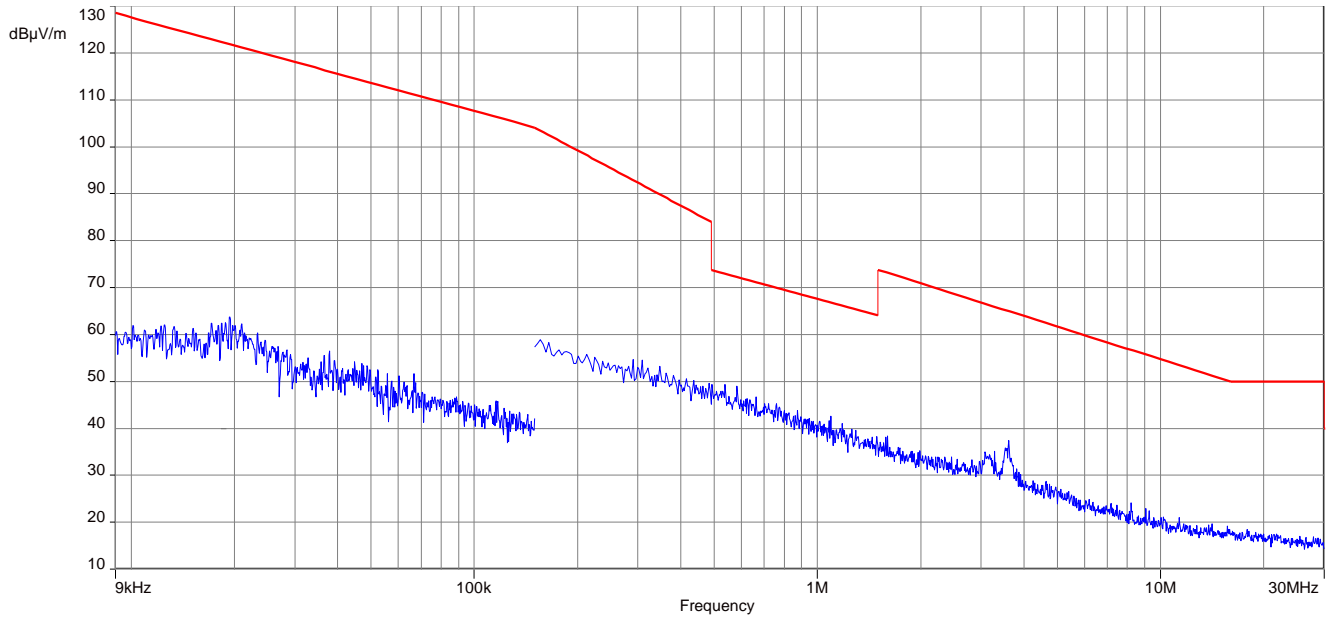

Plot 18: 30 MHz – 1 GHz, channel high, upper band

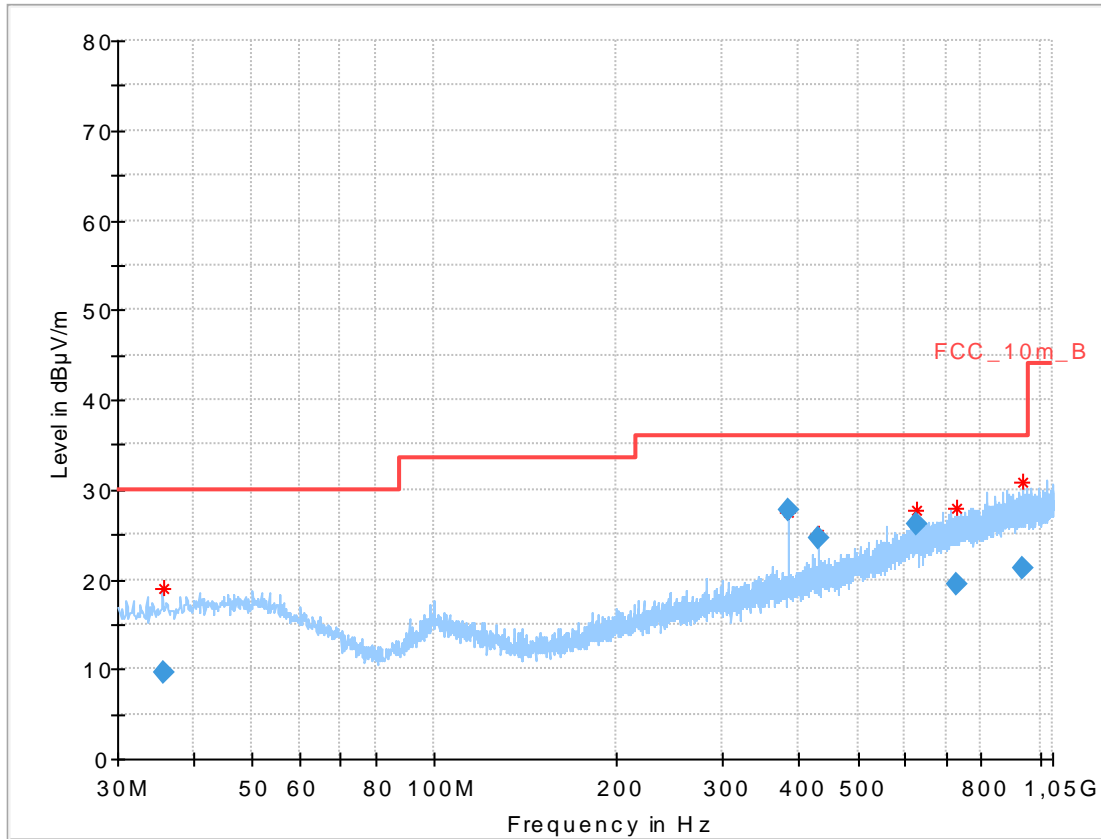

Final results:

Frequency (MHz)	QuasiPeak (dBµV/m)	Limit (dBµV/m)	Margin (dB)	Meas. Time (ms)	Bandwidth (kHz)	Height (cm)	Pol	Azimuth (deg)	Corr. (dB)
35.751900	9.62	30.00	20.38	1000.0	120.000	98.0	V	127.0	12.7
383.998500	27.67	36.00	8.33	1000.0	120.000	98.0	V	51.0	16.6
432.002550	24.57	36.00	11.43	1000.0	120.000	98.0	V	31.0	17.4
624.006600	26.05	36.00	9.95	1000.0	120.000	101.0	H	83.0	20.9
728.529000	19.43	36.00	16.57	1000.0	120.000	178.0	V	265.0	22.2
934.204050	21.24	36.00	14.76	1000.0	120.000	185.0	V	187.0	24.3

Plot 19: 1 GHz – 18 GHz, antenna horizontal/vertical, channel high, upper band

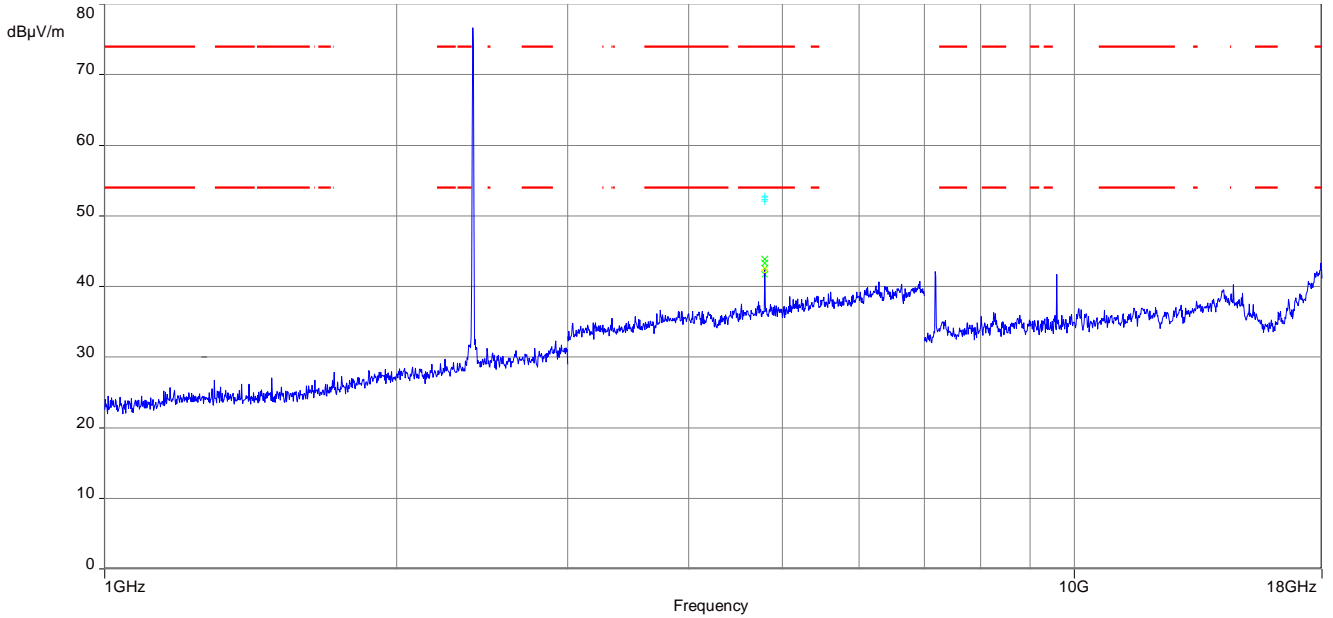

Plot 20: 18 GHz – 26 GHz, antenna horizontal/vertical, channel high, upper band

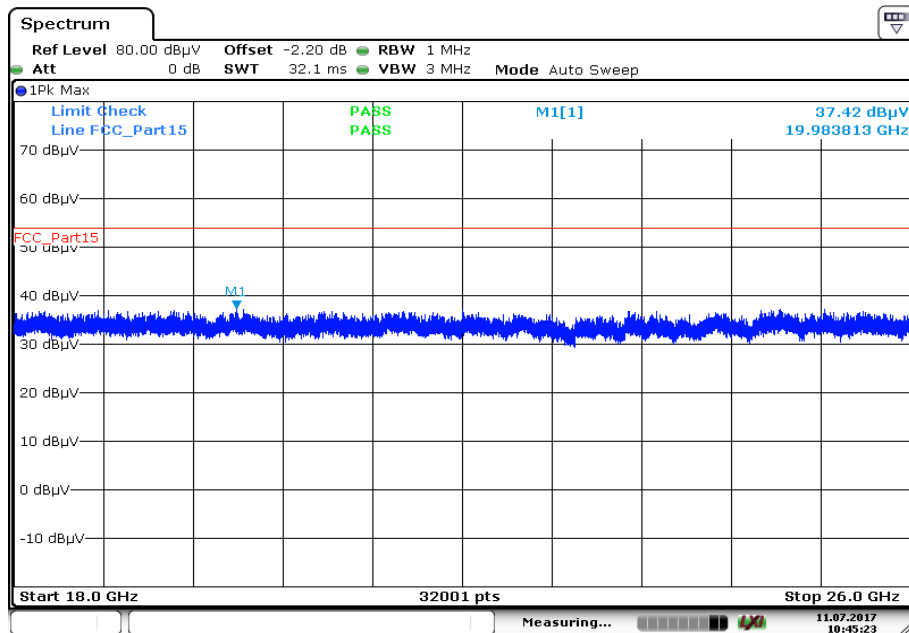

Date: 11.JUL.2017 10:45:23

12.6 Receiver unwanted radiation (radiated)

Measurement:

Measurement parameter		
Detector:	Prescan: Final:	Peak QPK below 960 MHz RMS above 960 MHz
Video bandwidth:	9 kHz – 150 kHz: 150 kHz – 30 MHz: 30 MHz – 1 GHz: 1 GHz – 26 GHz:	1 kHz 30 kHz 300 kHz 3 MHz
Resolution bandwidth:	9 kHz – 150 kHz: 150 kHz – 30 MHz: 30 MHz – 1 GHz: 1 GHz – 26 GHz:	200 Hz 9 kHz 100 kHz 1 MHz
Span:	See plots	
Trace mode:	Max Hold	
Test setup:	See sub clause 7.1 – A & 7.2 – A & 7.3 – A	
Measurement uncertainty:	See sub clause 9	

Limits:

FCC		IC
47 CFR § 15.109		-/-
Receiver unwanted radiation (radiated)		
Frequency (MHz)	Field strength ($\mu\text{V}/\text{m}$) ¹	Measurement distance (m)
30 - 88	100 (40 dB $\mu\text{V}/\text{m}$)	3
30 - 88	31.6 (30 dB $\mu\text{V}/\text{m}$)	10
88 - 216	150 (43.5 dB $\mu\text{V}/\text{m}$)	3
88 - 216	47.3 (33.5 dB $\mu\text{V}/\text{m}$)	10
216 - 960	200 (46 dB $\mu\text{V}/\text{m}$)	3
216 - 960	63.1 (36 dB $\mu\text{V}/\text{m}$)	10
above 960	500 (54 dB $\mu\text{V}/\text{m}$)	3

¹ Measurements in the 9 to 90 kHz, 110 to 490 kHz and above 1000 MHz ranges employ an average detector. Otherwise a quasi-peak detector is used.

According to the FCC requirement:

The radiated measurements were performed without a human body phantom or an equivalent testing setup (photo documentation – see external annex D).

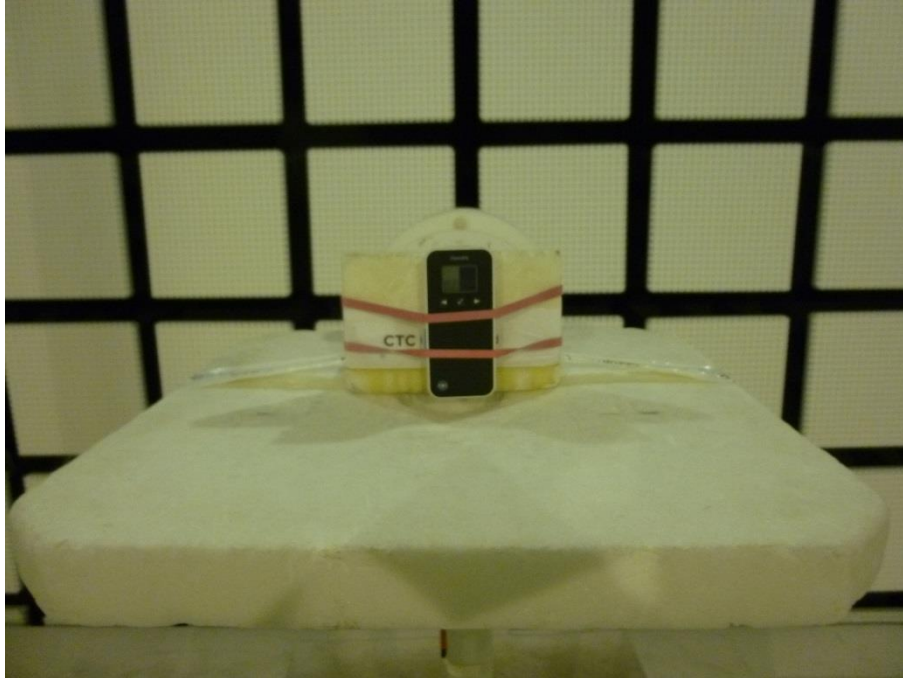

Results: Receiver mode, module ID 248

Receiver unwanted radiation [dBµV/m]		
F [MHz]	Detector	Level [dBµV/m]
See plots!		
4956	Peak	49.5
	RMS	41.9

Results: Receiver mode, module ID 251

Receiver unwanted radiation [dBµV/m]		
F [MHz]	Detector	Level [dBµV/m]
See plots!		
4956	Peak	49.1
	RMS	40.5

Plots: Module ID 248

Plot 1: 30 MHz – 1 GHz

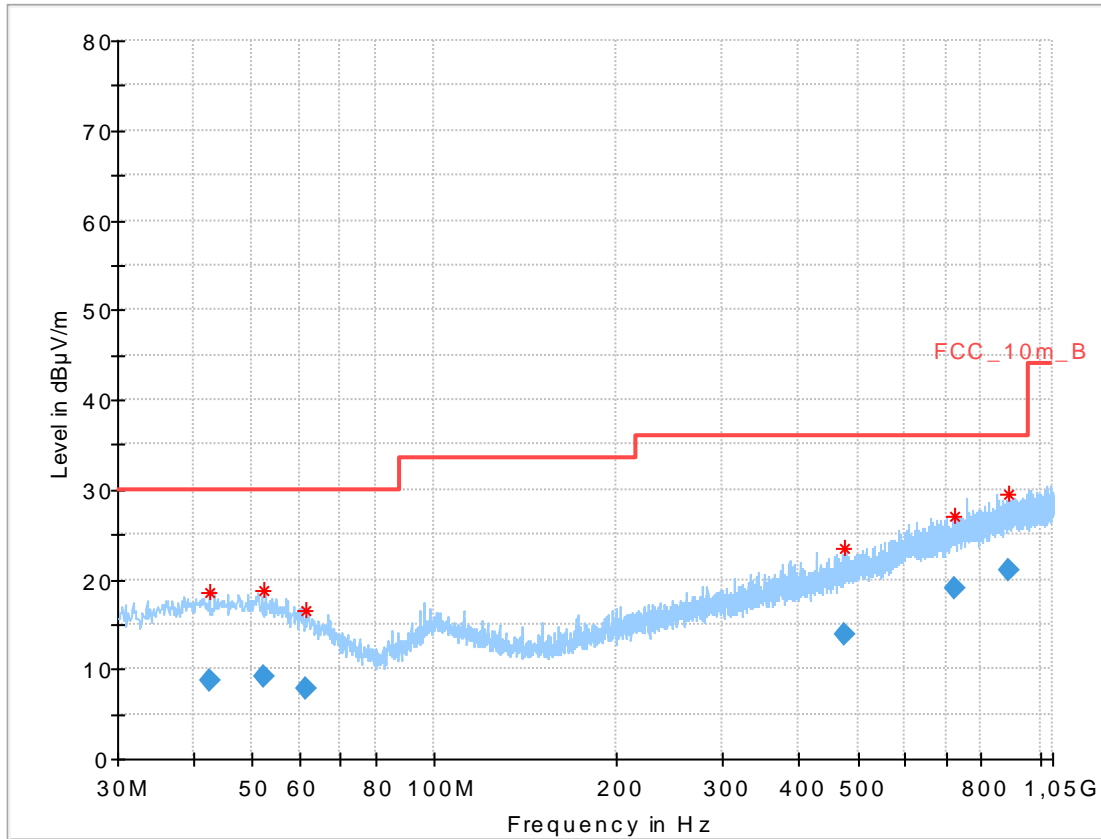

Final results:

Frequency (MHz)	QuasiPeak (dBµV/m)	Limit (dBµV/m)	Margin (dB)	Meas. Time (ms)	Bandwidth (kHz)	Height (cm)	Pol	Azimuth (deg)	Corr. (dB)
42.617100	8.79	30.00	21.21	1000.0	120.000	98.0	V	92.0	13.4
52.232100	9.23	30.00	20.77	1000.0	120.000	101.0	V	352.0	13.4
61.410450	7.89	30.00	22.11	1000.0	120.000	101.0	H	304.0	11.5
475.712550	13.88	36.00	22.12	1000.0	120.000	101.0	H	279.0	18.2
721.380450	18.91	36.00	17.09	1000.0	120.000	98.0	H	136.0	22.1
886.743300	20.91	36.00	15.09	1000.0	120.000	101.0	V	345.0	24.0

Plot 2: 1 GHz – 18 GHz, antenna horizontal/vertical

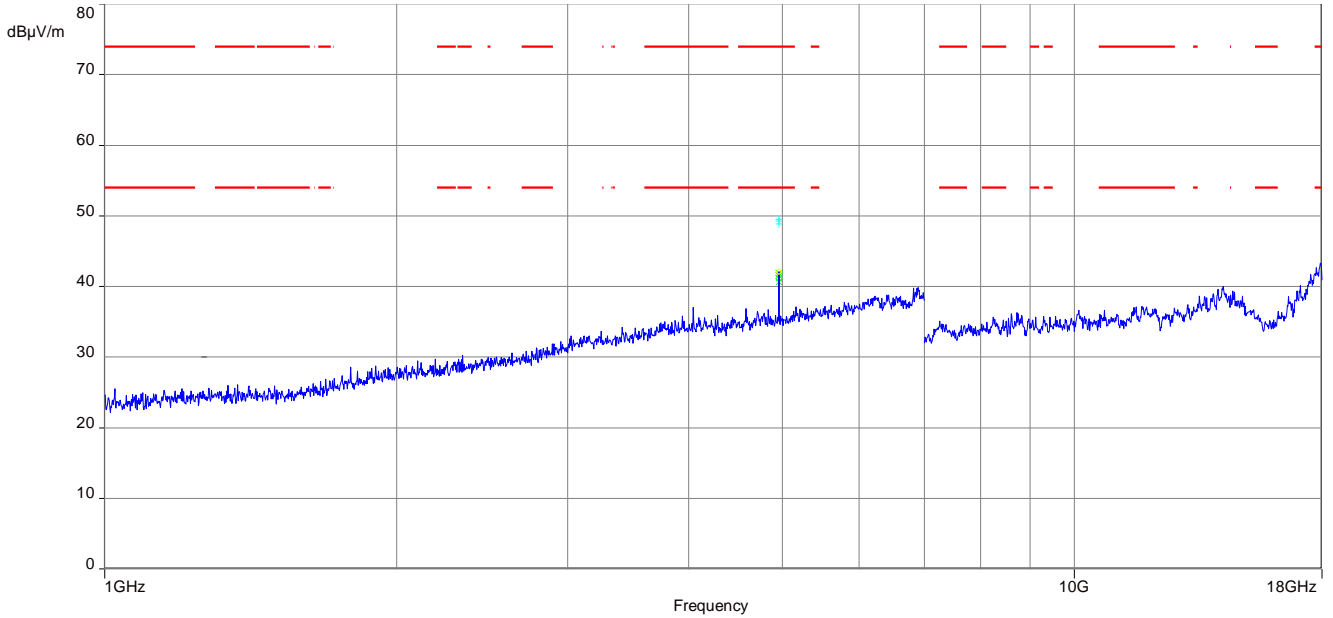

Plot 3: 18 GHz – 26 GHz, antenna horizontal/vertical

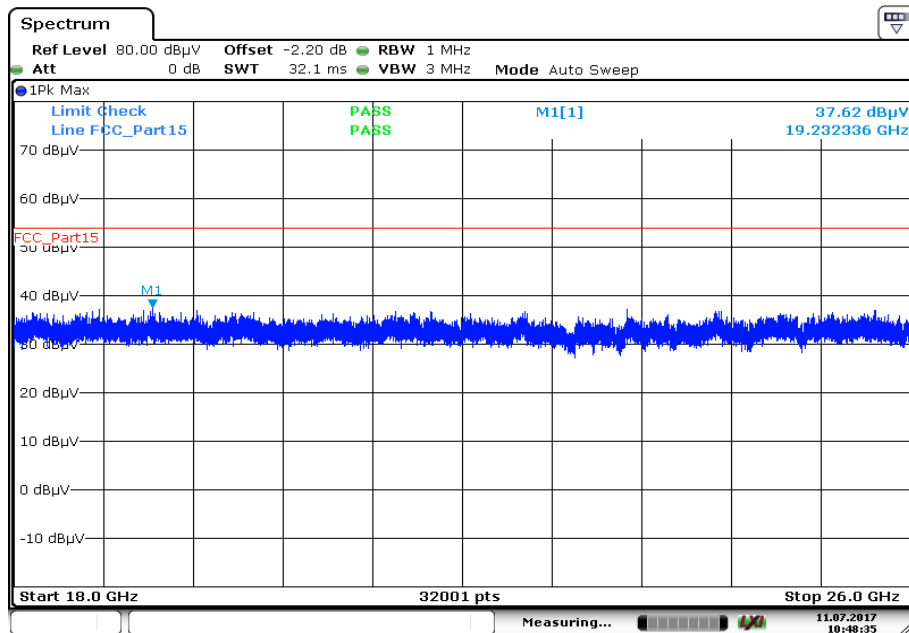

Date: 11.JUL.2017 10:48:35

Plots: Module ID 251

Plot 1: 30 MHz – 1 GHz

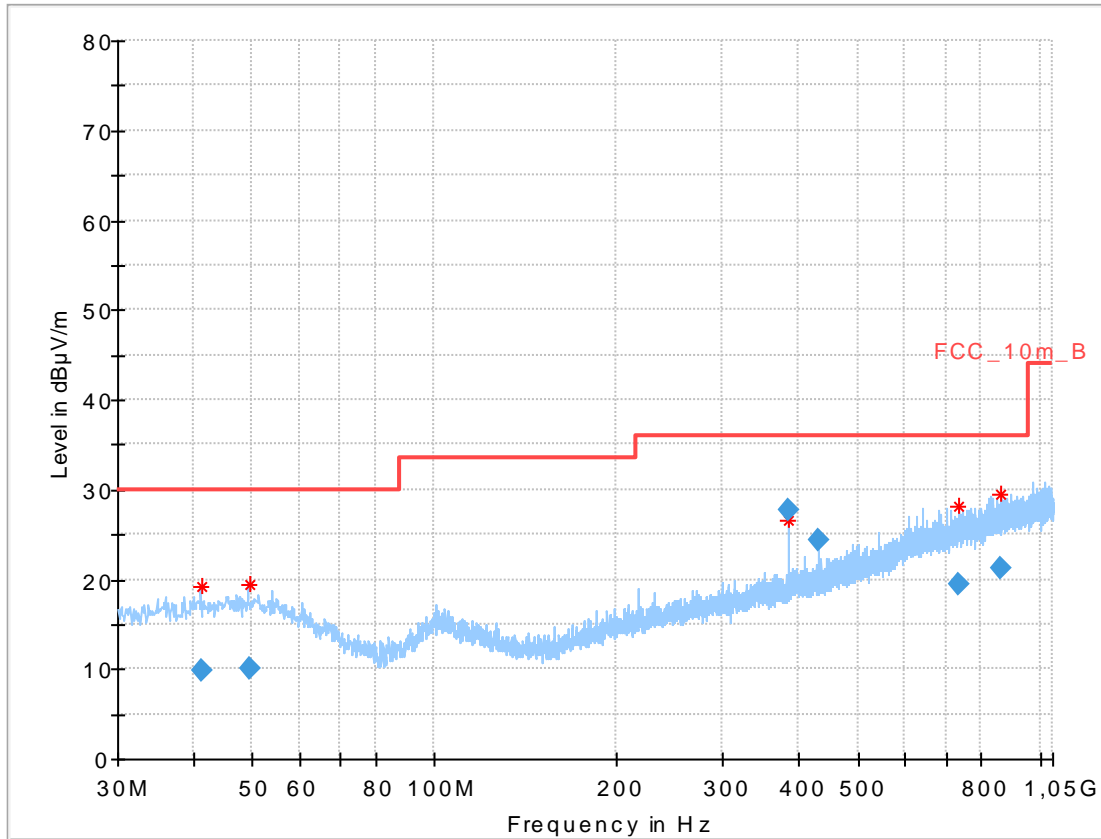

Final results:

Frequency (MHz)	QuasiPeak (dBµV/m)	Limit (dBµV/m)	Margin (dB)	Meas. Time (ms)	Bandwidth (kHz)	Height (cm)	Pol	Azimuth (deg)	Corr. (dB)
41.155200	9.74	30.00	20.26	1000.0	120.000	101.0	H	237.0	13.3
49.645950	10.01	30.00	19.99	1000.0	120.000	101.0	V	41.0	13.7
383.987850	27.67	36.00	8.33	1000.0	120.000	98.0	V	16.0	16.6
432.005250	24.44	36.00	11.56	1000.0	120.000	98.0	V	292.0	17.4
731.418450	19.45	36.00	16.55	1000.0	120.000	178.0	H	341.0	22.3
863.644050	21.24	36.00	14.76	1000.0	120.000	179.0	V	64.0	23.7

Plot 2: 1 GHz – 18 GHz, antenna horizontal/vertical

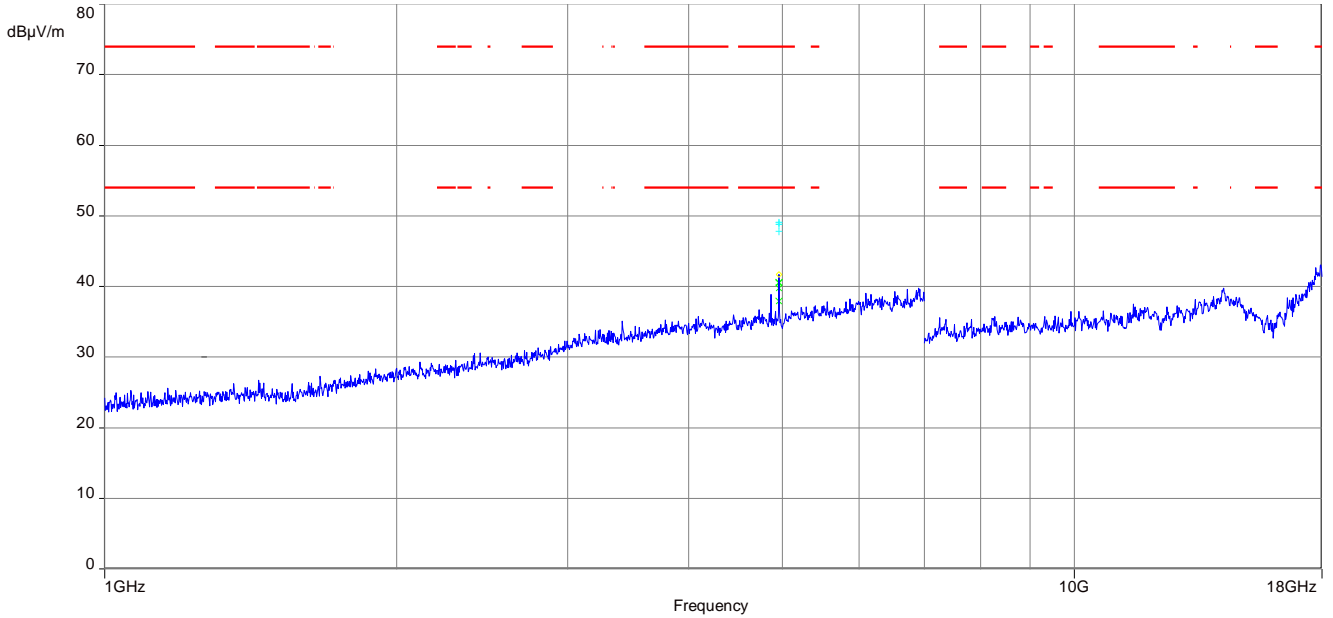

Plot 3: 18 GHz – 26 GHz, antenna horizontal/vertical

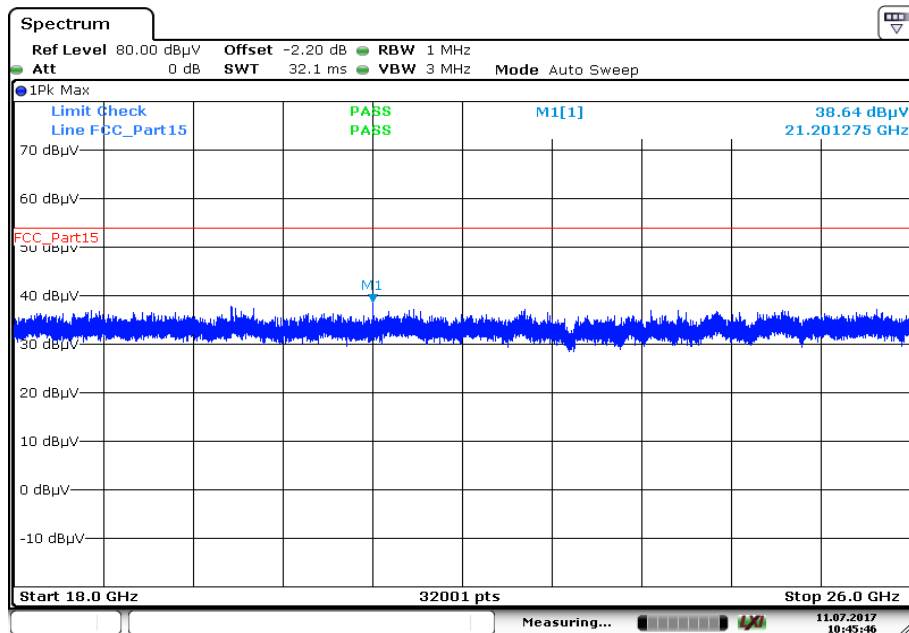

Date: 11.JUL.2017 10:45:46

12.7 Connection interrupt test (body-worn sensor)

Measurement:

- (a) Establish a LAN connection between the MBAN P/C device and the simulated control point.
- (b) Establish connection between the MBAN P/C and the body-worn sensor device under test (DUT).
- (c) Configure the control message to enable operation in the 2360–2390 MHz band.
- (d) Verify that transmissions between DUT and its associated MBAN P/C are consistent with the control message configuration.
- (e) Interrupt the RF and verify that the DUT ceases transmission in the 2360–2390 MHz band with a latency period not exceeding the maximum control message periodicity as specified in the operational description of the device. Additionally, if the DUT operating frequency is now moved to 2390–2400 MHz band verify the channel transition time (latency) is less than the maximum control message periodicity as specified in the operational description of the device.

Measurement parameter	
Detector:	Peak
Resolution bandwidth:	1 MHz
Video bandwidth:	3 MHz
Span:	See plots (both MBAN bands)
Trace mode:	Max Hold
Test setup:	See sub clause 7.5 – A

Note: Added from test report:

1-9941/15-01-06-C (Avalon CL fetal and maternal pod 866488) – see customer declaration.

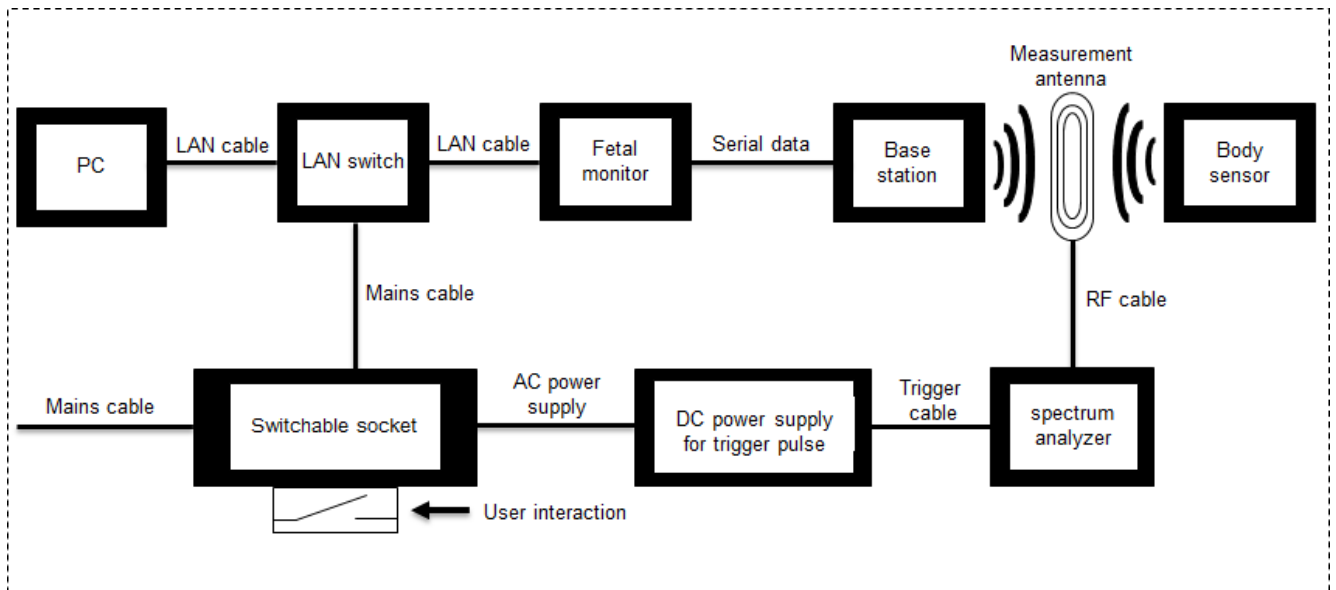
Test setup:**Test description (KDB 550599 D01 v01r01):**

1. Switchable socket with manual interaction to switch off the DC power supply and the LAN switch
2. DC power supply for a low ramp trigger pulse to trigger the spectrum analyzer
3. LAN switch to release the connection between PC (Server) and monitor (Main station)
4. Monitor, base station and body sensor – complete test setup in normal use constellation
5. Measurement antenna and spectrum analyzer to perform the test

Test execution:

1. Establishing a normal system connection
2. Manual interaction to switch off the DC power supply and the LAN switch
3. Spectrum analyzer – start of the measurement and connection lost between PC and monitor
4. Monitor deactivate the base station RF connection
5. Base station deactivate the body sensor
6. End of test

Step 1 (KDB 550599 D01 v01r01):

- (a) Establish a LAN connection between the MBAN P/C device and the simulated control point.
- (b) Establish connection between the MBAN P/C and the body-worn sensor device under test (DUT).

Plot 1:

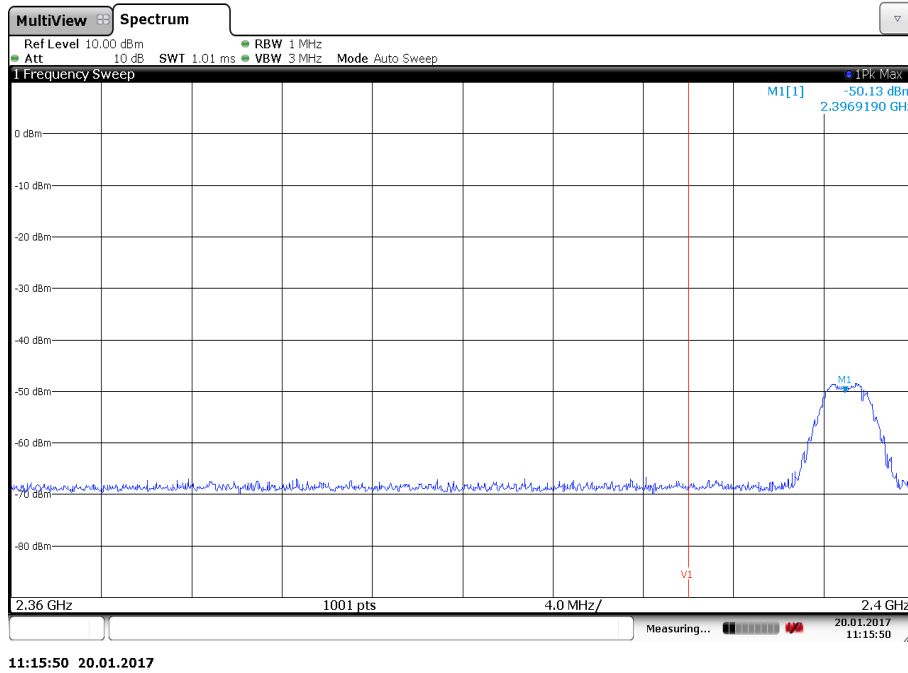

The plot shows the communication of the control message between the MBAN P/C and the body-worn sensor in the 2390-2400 MHz band (Marker 1 @ 2397 MHz). The V1 frequency line marks the end of lower and the start of the upper MBAN band.

Step 2 (KDB 550599 D01 v01r01):

- (c) Configure the control message to enable operation in the 2360–2390 MHz band.
- (d) Verify that transmissions between DUT and its associated MBAN P/C are consistent with the control message configuration.

Plot 2:

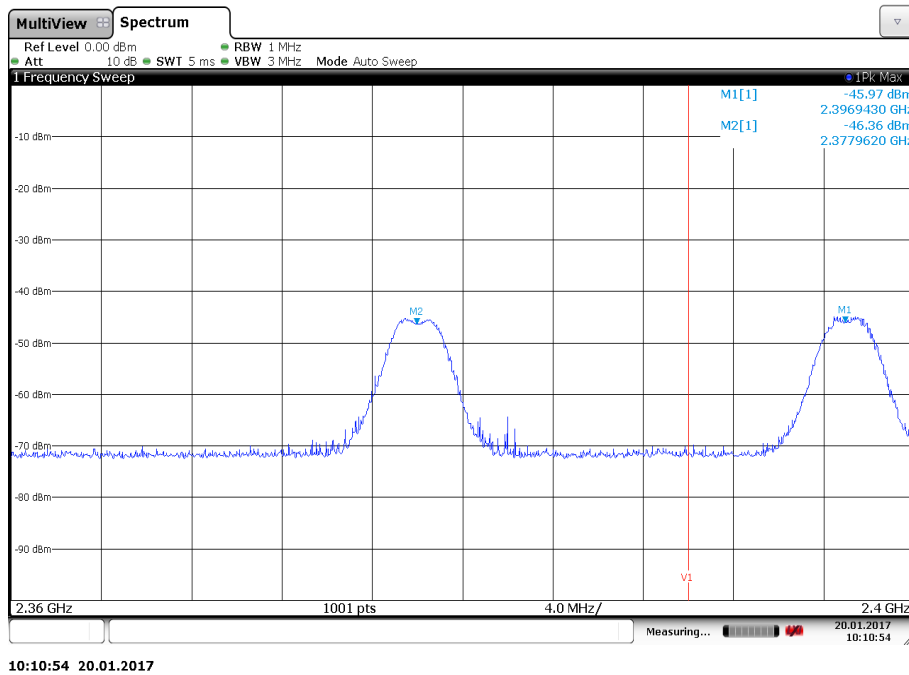

The 2360-2390 MHz band (Marker 2 @ 2378 MHz) was enabled for the body-worn sensor communication and the sensor transmits on the channel defined by the MBAN P/C. The control message of the MBAN P/C is transmitted in the 2390-2400 MHz band (Marker 1 @ 2397 MHz). The V1 frequency line marks the end of lower and the start of the upper MBAN band.

Step 3 (KDB 550599 D01 v01r01):

(e) Interrupt the RF and verify that the DUT ceases transmission in the 2360–2390 MHz band with a latency period not exceeding the maximum control message periodicity as specified in the operational description of the device. Additionally, if the DUT operating frequency is now moved to 2390–2400 MHz band verify the channel transition time (latency) is less than the maximum control message periodicity as specified in the operational description of the device.

Plot 3:

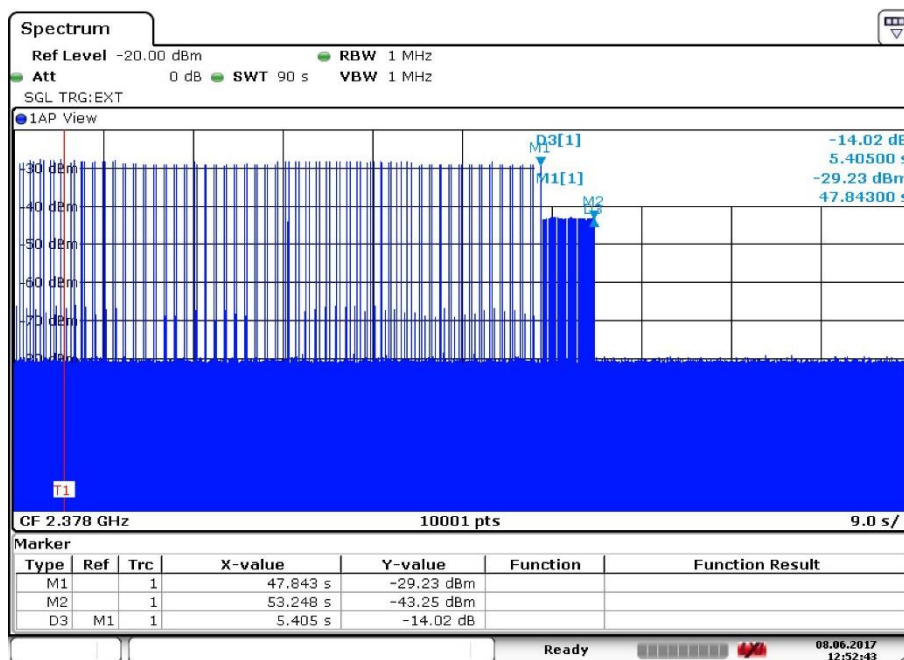

The communication between the MBAN P/C and the simulated control point was interrupted via LAN disconnection. MBAN P/C and body-worn sensor stop the communication within the MBAN frequency bands.

The plot shows the communication between the MBAN P/C and the body-worn sensor in the 2360-2390 MHz band. The red trigger line (T1) indicates the interrupt between the MBAN P/C and the simulated control point within the communication timeline. The base station stops communication within 47.8 seconds (Marker 1) and the body-worn sensor runs another 5.4 seconds and finished the communication within 53.2 seconds. (Marker 2 and delta marker 3).

Plot 4: Spectrum after marker 2 plot 3

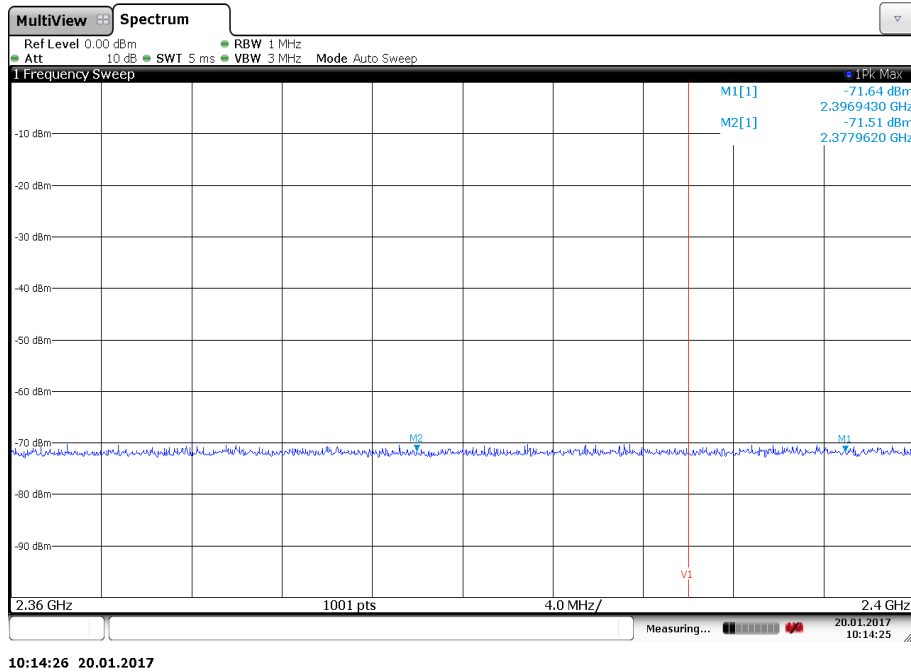

MBAN P/C and body-worn sensor stop the communication within the MBAN frequency bands. The V1 frequency line marks the end of lower and the start of the upper MBAN band.

13 Observations

No observations except those reported with the single test cases have been made.

Annex A Glossary

EUT	Equipment under test
DUT	Device under test
UUT	Unit under test
GUE	GNSS User Equipment
ETSI	European Telecommunications Standards Institute
EN	European Standard
FCC	Federal Communications Commission
FCC ID	Company Identifier at FCC
IC	Industry Canada
PMN	Product marketing name
HMN	Host marketing name
HVIN	Hardware version identification number
FVIN	Firmware version identification number
EMC	Electromagnetic Compatibility
HW	Hardware
SW	Software
Inv. No.	Inventory number
S/N or SN	Serial number
C	Compliant
NC	Not compliant
NA	Not applicable
NP	Not performed
PP	Positive peak
QP	Quasi peak
AVG	Average
OC	Operating channel
OCW	Operating channel bandwidth
OBW	Occupied bandwidth
OOB	Out of band
DFS	Dynamic frequency selection
CAC	Channel availability check
OP	Occupancy period
NOP	Non occupancy period
DC	Duty cycle
PER	Packet error rate
CW	Clean wave
MC	Modulated carrier
WLAN	Wireless local area network
RLAN	Radio local area network
DSSS	Dynamic sequence spread spectrum
OFDM	Orthogonal frequency division multiplexing
FHSS	Frequency hopping spread spectrum
GNSS	Global Navigation Satellite System
C/N₀	Carrier to noise-density ratio, expressed in dB-Hz

Annex B Document history

Version	Applied changes	Date of release
-/-	Initial release	2017-11-23
A	Editorial changes	2017-11-27
B	Editorial changes	2018-02-28

Annex C Accreditation Certificate

first page	last page
 <p>Deutsche Akkreditierungsstelle GmbH</p> <p>Entrusted according to Section 8 subsection 1 AkkStelleG in connection with Section 1 subsection 1 AkkStelleGBV Signatory to the Multilateral Agreements of EA, ILAC and IAF for Mutual Recognition</p> <p>Accreditation </p> <p>The Deutsche Akkreditierungsstelle GmbH attests that the testing laboratory CTC advanced GmbH Untertürkheimer Straße 6-10, 66117 Saarbrücken</p> <p>is competent under the terms of DIN EN ISO/IEC 17025:2005 to carry out tests in the following fields: Telecommunication</p> <p>The accreditation certificate shall only apply in connection with the notice of accreditation of 02.06.2017 with the accreditation number D-PL-12076-01 and is valid until 21.04.2021. It comprises the cover sheet, the reverse side of the cover sheet and the following annex with a total of 43 pages.</p> <p>Registration number of the certificate: D-PL-12076-01-03</p> <p>Frankfurt, 02.06.2017  Dipl.-Ing. (FH) Ralf Brier Heads of Division</p> <p><small>See notes enclosed.</small></p>	<p>Deutsche Akkreditierungsstelle GmbH</p> <p>Office Berlin Spittelmarkt 10 10117 Berlin</p> <p>Office Frankfurt am Main Europa-Allee 52 60327 Frankfurt am Main</p> <p>Office Braunschweig Bundesallee 100 38116 Braunschweig</p> <p>The publication of extracts of the accreditation certificate is subject to the prior written approval by Deutsche Akkreditierungsstelle GmbH (DAkkS). Exempted is the unchanged form of separate disseminations of the cover sheet by the conformity assessment body mentioned overleaf.</p> <p>No impression shall be made that the accreditation also extends to fields beyond the scope of accreditation attested by DAkkS.</p> <p>The accreditation was granted pursuant to the Act on the Accreditation Body (AkkStelleG) of 31 July 2009 (Federal Law Gazette I p. 2625) and the Regulation (EC) No 765/2008 of the European Parliament and of the Council of 9 July 2008 setting out the requirements for accreditation and market surveillance relating to the marketing of products (Official Journal of the European Union L 218 of 9 July 2008, p. 30). DAkkS is a signatory to the Multilateral Agreements for Mutual Recognition of the European co-operation for Accreditation (EA), International Accreditation Forum (IAF) and International Laboratory Accreditation Cooperation (ILAC). The signatories to these agreements recognise each other's accreditations.</p> <p>The up-to-date state of membership can be retrieved from the following websites: EA: www.european-accreditation.org ILAC: www.ilac.org IAF: www.iaf.nu</p>

Note: The current certificate annex is published on the website (link see below) of the Accreditation Body DAkkS or may be received by CTC advanced GmbH on request

<http://www.dakks.de/as/ast/d/D-PL-12076-01-03.pdf>