

TEST REPORT

Test report no.: 1-9941/15-01-06-C



Deutsche
Akkreditierungsstelle
D-PL-12076-01-01

Testing laboratory

CTC advanced GmbH

Untertuerkheimer Strasse 6 – 10
66117 Saarbruecken / Germany

Phone: + 49 681 5 98 - 0

Fax: + 49 681 5 98 - 9075

Internet: <http://www.ctcadvanced.com>

e-mail: mail@ctcadvanced.com

Accredited Testing Laboratory:

The testing laboratory (area of testing) is accredited according to DIN EN ISO/IEC 17025 (2005) by the Deutsche Akkreditierungsstelle GmbH (DAkkS)

The accreditation is valid for the scope of testing procedures as stated in the accreditation certificate with the registration number: D-PL-12076-01-01

Applicant

Philips Medizin Systeme Böblingen GmbH

Hewlett-Packard-Strasse 2
71034 Böblingen / GERMANY

Phone: -/-

Fax: +49 7031 463-2944

Contact: Hansjörg Geywitz

e-mail: hansjoerg.geywitz@philips.com

Phone: +49 7031 463-1879

Manufacturer

Philips Medizin Systeme Böblingen GmbH

Hewlett-Packard-Strasse 2
71034 Böblingen / GERMANY

Test standard/s

47 CFR Part 95 Personal radio services – medical device Radiocommunication service (MedRadio)

For further applied test standards please refer to section 3 of this test report.

Test Item

Kind of test item: **Device for measuring fetal and maternal heartrate and uterine activity**

Model name: **Avalon CL fetal and maternal pod 866488**

FCC ID: **PQC-SRRFMPBV1**

Frequency: MBAN bands:
2360 MHz to 2390 MHz & 2390 MHz to 2400 MHz

Technology tested: MBAN

Antenna: Integrated PCB antenna

Power supply: 3.7 V DC by Li - Ion battery

Temperature range: -20°C to +55°C



This test report is electronically signed and valid without handwriting signature. For verification of the electronic signatures, the public keys can be requested at the testing laboratory.

Test report authorized:

p.o.

Stefan Bös
Lab Manager
Radio Communications & EMC

Test performed:

Mihail Dorongovskij
Lab Manager
Radio Communications & EMC

1 Table of contents

1	Table of contents.....	2
2	General information	3
2.1	Notes and disclaimer	3
2.2	Application details	3
3	Test standard/s and references.....	3
4	Test environment	4
5	Test item	4
5.1	General description.....	4
5.2	Additional information	4
6	Test laboratories sub-contracted	4
7	Description of the test setup	5
7.1	Shielded semi anechoic chamber	6
7.2	Shielded fully anechoic chamber	7
7.3	Radiated measurements > 18 GHz	8
7.4	Conducted measurements C.BER system	9
7.5	Test setup for the timing behavior	10
7.6	Shielded fully anechoic chamber	11
8	Sequence of testing	12
8.1	Sequence of testing radiated spurious 9 kHz to 30 MHz	12
8.2	Sequence of testing radiated spurious 30 MHz to 1 GHz	13
8.3	Sequence of testing radiated spurious 1 GHz to 18 GHz	14
8.4	Sequence of testing radiated spurious above 18 GHz	15
9	Measurement uncertainty.....	16
10	Summary of measurement results.....	17
11	Additional comments.....	18
	Project Note	19
	Subject: MBAN System Description for FCC Approval	19
	Affected Products:	19
12	Measurement results	21
12.1	Frequency stability	21
12.2	Emission bandwidth	27
12.3	Maximum transmit power	31
12.4	Band edge measurement.....	41
12.5	Transmitter unwanted radiation (radiated).....	43
12.6	Receiver unwanted radiation (radiated).....	67
12.7	Connection interrupt test (body-worn sensor).....	72
13	Observations	77
Annex A	Glossary	78
Annex B	Document history	79
Annex C	Accreditation Certificate	79

2 General information

2.1 Notes and disclaimer

The test results of this test report relate exclusively to the test item specified in this test report. CTC advanced GmbH does not assume responsibility for any conclusions and generalizations drawn from the test results with regard to other specimens or samples of the type of the equipment represented by the test item.

The test report may only be reproduced or published in full. Reproduction or publication of extracts from the report requires the prior written approval of CTC advanced GmbH.

The testing service provided by CTC advanced GmbH has been rendered under the current "General Terms and Conditions for CTC advanced GmbH".

CTC advanced GmbH will not be liable for any loss or damage resulting from false, inaccurate, inappropriate or incomplete product information provided by the customer.

Under no circumstances does the CTC advanced GmbH test report include any endorsement or warranty regarding the functionality, quality or performance of any other product or service provided.

Under no circumstances does the CTC advanced GmbH test report include or imply any product or service warranties from CTC advanced GmbH, including, without limitation, any implied warranties of merchantability, fitness for purpose, or non-infringement, all of which are expressly disclaimed by CTC advanced GmbH.

All rights and remedies regarding vendor's products and services for which CTC advanced GmbH has prepared this test report shall be provided by the party offering such products or services and not by CTC advanced GmbH. In no case this test report can be considered as a Letter of Approval.

This test report is electronically signed and valid without handwritten signature. For verification of the electronic signatures, the public keys can be requested at the testing laboratory.

This test report replaces the test report with the number 1-9941/15-01-06-B and dated 2017-09-05

2.2 Application details

Date of receipt of order:	2016-08-26
Date of receipt of test item:	2016-08-29
Start of test:	2016-08-29
End of test:	2017-06-08
Person(s) present during the test:	-/-

3 Test standard/s and references

Test standard	Date	Description
47 CFR Part 95	May-14-2009	Personal radio services – medical device Radiocommunication service (MedRadio)

Guidance	Version	Description
ANSI C63.4-2014	-/-	American national standard for methods of measurement of radio-noise emissions from low-voltage electrical and electronic equipment in the range of 9 kHz to 40 GHz
KDB 550599 D01 v01	June-17-2016	Medical body area network (MBAN) measurement procedures

4 Test environment

Temperature	:	T _{nom} T _{max} T _{min}	+22 °C during room temperature tests +55 °C during high temperature tests 0 °C during low temperature tests
Relative humidity content	:		55 %
Barometric pressure	:		not relevant for this kind of testing
Power supply	:	V _{nom} V _{max} V _{min}	3.7 V DC by Li - Ion battery 4.1 V 2.8 V

5 Test item

5.1 General description

Kind of test item	:	Device for measuring fetal and maternal heartrate and uterine activity	
Type identification	:	Avalon CL fetal and maternal pod 866488	
S/N serial number	:	Radiated unit:	XW62500238
		Conducted unit:	XW62500203
HW hardware status	:	1	
SW software status	:	D.00.58	
Frequency band	:	MBAN bands: 2360 MHz to 2390 MHz & 2390 MHz to 2400 MHz (lowest channel 2363 MHz, highest channel 2397 MHz)	
Type of radio transmission	:	modulated carrier, DSSS	
Use of frequency spectrum	:		
Type of modulation	:	OQPSK	
Number of channels	:	15	
Antenna	:	Integrated PCB antenna	
Power supply	:	3.7 V DC by Li - Ion battery	
Temperature range	:	-20°C to +55°C	

5.2 Additional information

The content of the following annexes is defined in the QA. It may be that not all of the listed annexes are necessary for this report, thus some values in between may be missing.

Test setup- and EUT-photos are included in test report:

1-9941/15-01-01_AnnexA

1-9941/15-01-01_AnnexB (Photos provided by customer)

1-9941/15-01-01_AnnexD

6 Test laboratories sub-contracted

None

7 Description of the test setup

Typically, the calibrations of the test apparatus are commissioned to and performed by an accredited calibration laboratory. The calibration intervals are determined in accordance with the DIN EN ISO/IEC 17025. In addition to the external calibrations, the laboratory executes comparison measurements with other calibrated test systems or effective verifications. Weekly chamber inspections and range calibrations are performed. Where possible, RF generating and signaling equipment as well as measuring receivers and analyzers are connected to an external high-precision 10 MHz reference (GPS-based or rubidium frequency standard).

In order to simplify the identification of the equipment used at some special tests, some items of test equipment and ancillaries can be provided with an identifier or number in the equipment list below (Lab/Item).

Agenda: Kind of Calibration

k	calibration / calibrated	EK	limited calibration
ne	not required (k, ev, izw, zw not required)	zw	cyclical maintenance (external cyclical maintenance)
ev	periodic self verification	izw	internal cyclical maintenance
Ve	long-term stability recognized	g	blocked for accredited testing
vkl!	Attention: extended calibration interval		
NK!	Attention: not calibrated	*)	next calibration ordered / currently in progress

7.1 Shielded semi anechoic chamber

The radiated measurements are performed in vertical and horizontal plane in the frequency range from 9 kHz to 1 GHz in semi-anechoic chambers. The EUT is positioned on a non-conductive support with a height of 0.80 m above a conductive ground plane that covers the whole chamber. The receiving antennas are confirmed with specifications ANSI C63. These antennas can be moved over the height range between 1.0 m and 4.0 m in order to search for maximum field strength emitted from EUT. The measurement distances between EUT and receiving antennas are indicated in the test setups for the various frequency ranges. For each measurement, the EUT is rotated in all three axes until the maximum field strength is received. The wanted and unwanted emissions are received by spectrum analyzers where the detector modes and resolution bandwidths over various frequency ranges are set according to requirement ANSI C63.

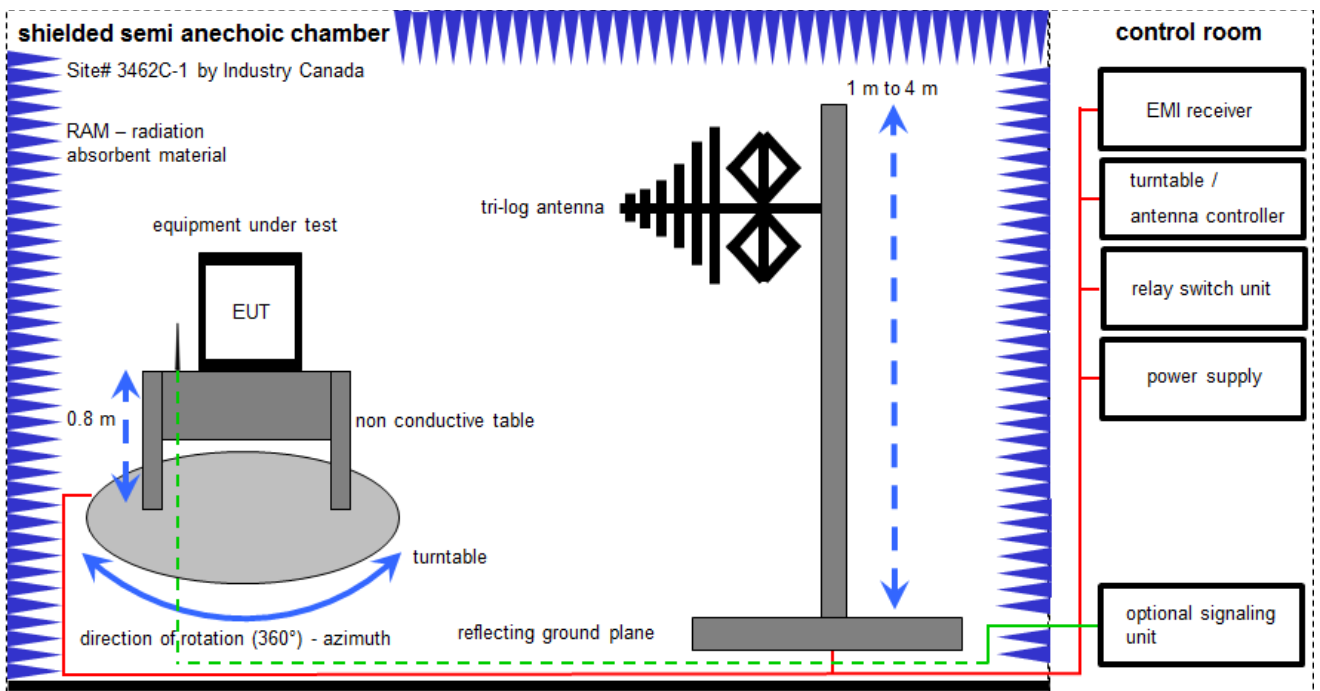

Measurement distance: tri-log antenna 10 meter

$$FS = UR + CL + AF$$

(FS-field strength; UR-voltage at the receiver; CL-loss of the cable; AF-antenna factor)

Example calculation:

$$FS [dB\mu V/m] = 12.35 [dB\mu V/m] + 1.90 [dB] + 16.80 [dB/m] = 31.05 [dB\mu V/m] (35.69 \mu V/m)$$

Equipment table:

No.	Lab / Item	Equipment	Type	Manufacturer	Serial No.	INV. No.	Kind of Calibration	Last Calibration	Next Calibration
1	A	Switch-Unit	3488A	HP	2719A14505	300000368	ev	-/-	-/-
2	A	EMI Test Receiver	ESCI 3	R&S	100083	300003312	k	08.03.2016 01.02.2017	08.03.2017 31.01.2018
3	A	Antenna Tower	Model 2175	ETS-Lindgren	64762	300003745	izw	-/-	-/-
4	A	Positioning Controller	Model 2090	ETS-Lindgren	64672	300003746	izw	-/-	-/-
5	A	Turntable Interface-Box	Model 105637	ETS-Lindgren	44583	300003747	izw	-/-	-/-
6	A	TRILOG Broadband Test-Antenna 30 MHz - 3 GHz	VULB9163	Schwarzbeck	295	300003787	k	25.04.2016	25.04.2018

7.2 Shielded fully anechoic chamber

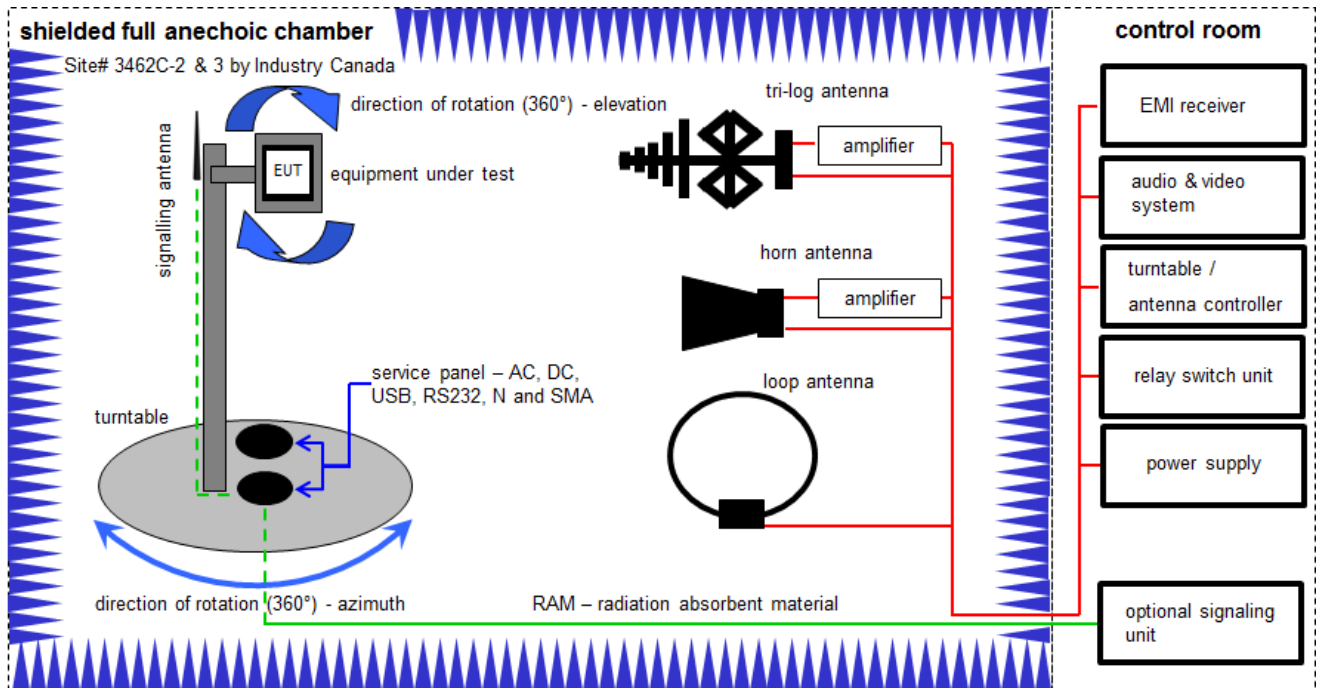

Measurement distance: tri-log antenna and horn antenna 3 meter; loop antenna 3 meter

$$FS = UR + CA + AF$$

(FS-field strength; UR-voltage at the receiver; CA-loss of the signal path; AF-antenna factor)

Example calculation:

$$FS \text{ [dB}\mu\text{V/m]} = 40.0 \text{ [dB}\mu\text{V/m]} + (-35.8) \text{ [dB]} + 32.9 \text{ [dB/m]} = 37.1 \text{ [dB}\mu\text{V/m]} \text{ (} 71.61 \text{ }\mu\text{V/m)}$$

Equipment table:

No.	Lab / Item	Equipment	Type	Manufacturer	Serial No.	INV. No.	Kind of Calibration	Last Calibration	Next Calibration
1	A, B	Double-Ridged Wav eguide Horn Antenna 1-18.0GHz	3115	EMCO	8812-3088	300001032	v IKI!	20.05.2015 14.02.2017	20.05.2017 13.02.2019
2	A, B	Anechoic chamber	FAC 3/5m	MWB / TDK	87400/02	300000996	ev	-/-	-/-
3	A, B	Switch / Control Unit	3488A	HP	*	300000199	ne	-/-	-/-
4	A	Active Loop Antenna 10 kHz to 30 MHz	6502	EMCO/2	8905-2342	300000256	k	24.06.2015	24.06.2017
5	A	Amplifier	js42-00502650-28-5a	Parzich GMBH	928979	300003143	ne	-/-	-/-
6	A	Band Reject filter	WRCG2400/2483-2375/2505-50/10SS	Wainwright	11	300003351	ev	-/-	-/-
7	A	Highpass Filter	WHKX7.0/18G-8SS	Wainwright	18	300003789	ne	-/-	-/-
8	B	TRILOG Broadband Test-Antenna 30 MHz - 3 GHz	VULB9163	Schwarzbeck	371	300003854	v IKI!	29.10.2014	29.10.2017
9	A, B	4U RF Switch Platform	L4491A	Agilent Technologies	MY50000037	300004509	ne	-/-	-/-
10	A, B	EMI Test Receiver 9kHz-26,5GHz	ESR26	R&S	101376	300005063	k	04.09.2015	04.09.2016

7.3 Radiated measurements > 18 GHz

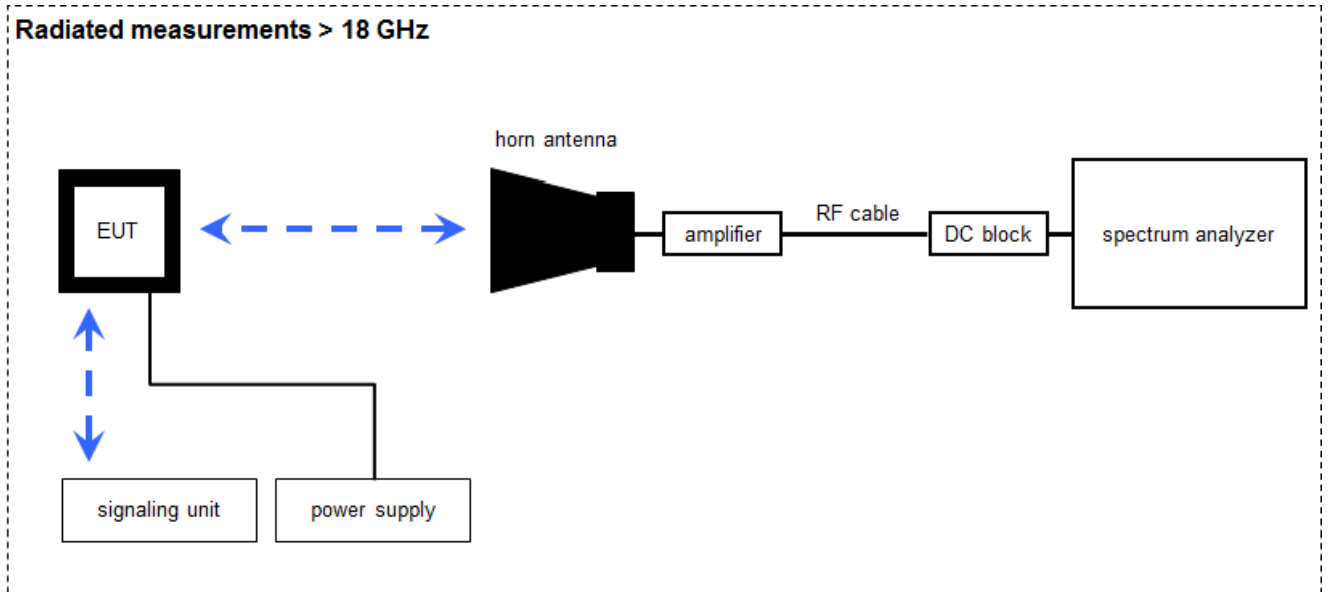

Measurement distance: horn antenna 50 cm

$$FS = U_R + CA + AF$$

(FS-field strength; U_R -voltage at the receiver; CA-loss signal path & distance correction; AF-antenna factor)

Example calculation:

$$FS \text{ [dB}\mu\text{V/m]} = 40.0 \text{ [dB}\mu\text{V/m]} + (-60.1) \text{ [dB]} + 36.74 \text{ [dB/m]} = 16.64 \text{ [dB}\mu\text{V/m]} \text{ (} 6.79 \text{ }\mu\text{V/m)}$$

Equipment table:

No.	Lab / Item	Equipment	Type	Manufacturer	Serial No.	INV. No.	Kind of Calibration	Last Calibration	Next Calibration
1	A	Amplifier 2-40 GHz	JS32-02004000-57-5P	MITEQ	1777200	300004541	ev	-/-	-/-
2	A	RF-Cable	ST18/SMAm/SMAm/48	Huber & Suhner	Batch no. 600918	400001182	ev	-/-	-/-
3	A	RF-Cable	ST18/SMAm/SMm/48	Huber & Suhner	Batch no. 127377	400001183	ev	-/-	-/-
4	A	DC-Blocker 0.1-40 GHz	8141A	Inmet	Batch no. 127377	400001185	ev	-/-	-/-
5	A	Std. Gain Horn Antenna 18.0 to 26.5 GHz	638	Narda	-/-	300000486	k	10.09.2015	10.09.2017
6	A	Signal Analyzer 40 GHz	FSV40	R&S	101042	300004517	k	21.01.2016 25.01.2017	21.01.2017 24.01.2018

7.4 Conducted measurements C.BER system

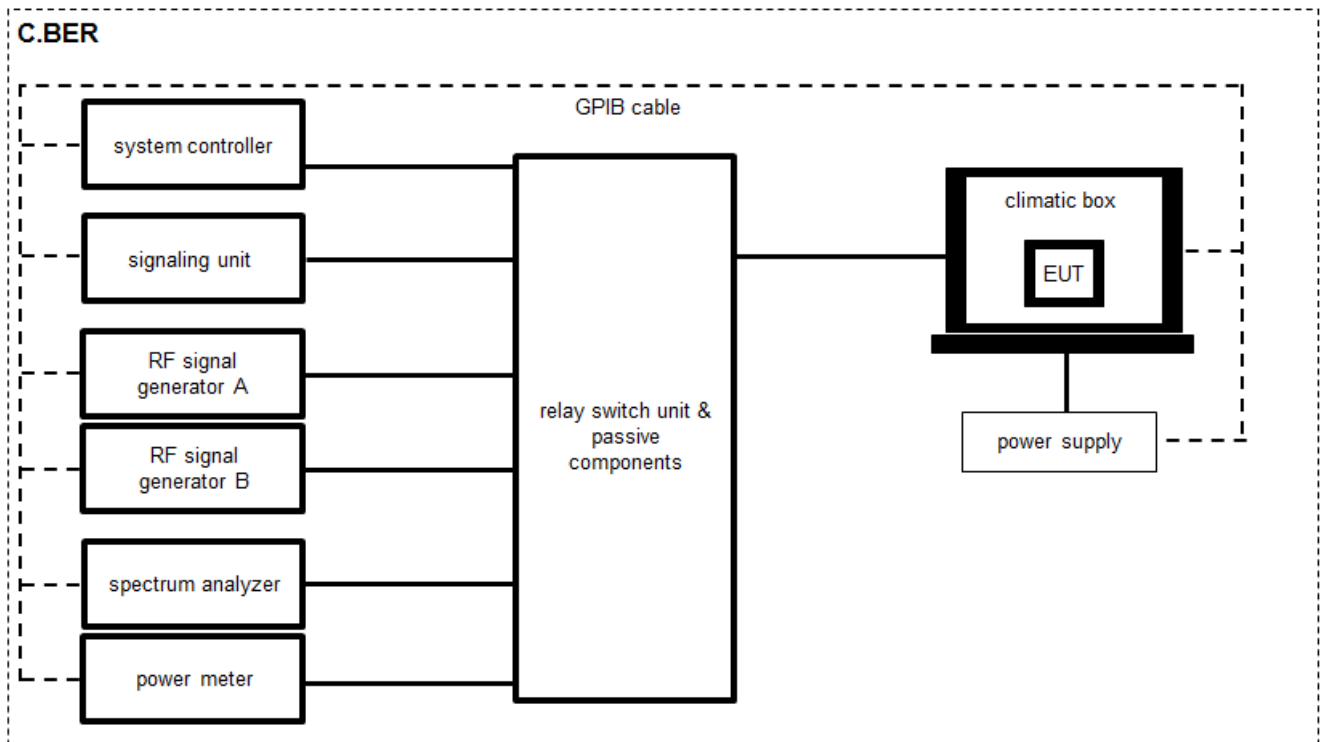

OP = AV + CA
(OP-output power; AV-analyzer value; CA-loss signal path)

Example calculation:

OP [dBm] = 6.0 [dBm] + 11.7 [dB] = 17.7 [dBm] (58.88 mW)

Equipment table:

No.	Lab / Item	Equipment	Type	Manufacturer	Serial No.	INV. No.	Kind of Calibration	Last Calibration	Next Calibration
1	A, B	Switch / Control Unit	3488A	HP	-/-	300001691	ne	-/-	-/-
2	A, B	Power Supply DC	NGPE 40/40	R&S	388	400000078	v IKI!	22.01.2015 31.01.2017	22.01.2017 30.01.2020
3	A, B	Signal Analyzer 20Hz-26,5GHz-150 to + 30 DBM	FSIQ26	R&S	835540/018	300002681	k	28.01.2016	28.01.2018
4	A, B	Frequency Standard (Rubidium Frequency Standard)	MFS (Rubidium)	R&S (Datum)	002	300002681	Ve	29.01.2015 27.01.2017	29.01.2017 26.01.2019
5	A,	Directional Coupler	101020010	Krytar	70215	300002840	ev	-/-	-/-
6	A, B	DC-Blocker	8143	Inmet Corp.	none	300002842	ne	-/-	-/-
7	A, B	Powersplitter	6005-3	Inmet Corp.	none	300002841	ev	-/-	-/-
8	A, B	USB/GPIB interface	82357B	Agilent Technologies	MY 52103346	300004390	ne	-/-	-/-
9	A, B	Messplatzrechner	Tecline	F+W	102585	300003580	ne	-/-	-/-
10	A, B	RF-Cable	ST18/SMAm/SMAm/72	Huber & Suhner	Batch no. 605505	400001187	ev	-/-	-/-
11	A, B	RF-Cable	Sucoflex 104	Huber & Suhner	147636/4	400001188	ev	-/-	-/-
12	A, B	RF-Cable	ST18/SMAm/SMAm/48	Huber & Suhner	Batch no. 699866	400001189	ev	-/-	-/-
13	A, B	RF-Cable	ST18/SMAm/SMAm/48	Huber & Suhner	Batch no. 14844	400001190	ev	-/-	-/-
14	B	Temperature Test Chamber	VT 4002	Heraeus Voetsch	58566046820010	300003019	ev	03.09.2015	03.09.2017

7.5 Test setup for the timing behavior

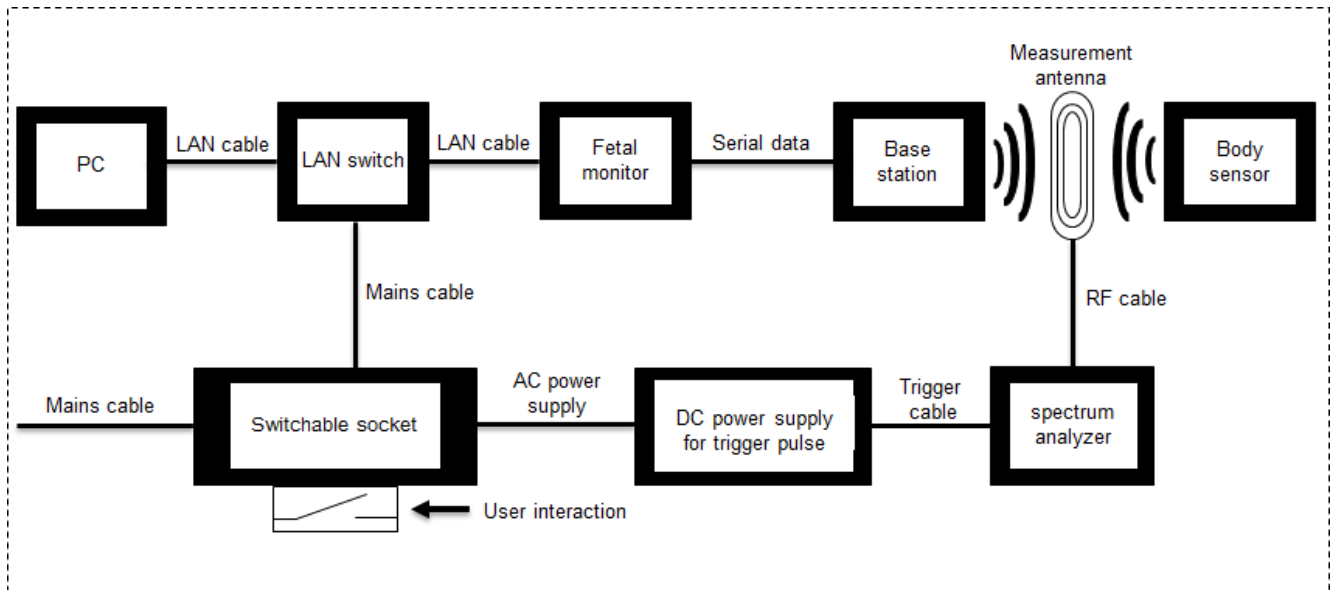

Equipment table:

No.	Lab / Item	Equipment	Type	Manufacturer	Serial No.	INV. No.	Kind of Calibration	Last Calibration	Next Calibration
1	A	Antenna	-/-	-/-	-/-	-/-	ne	-/-	-/-
2	A	Switchable socket	-/-	-/-	-/-	-/-	ne	-/-	-/-
3	A	Switch	-/-	-/-	-/-	-/-	ne	-/-	-/-
4	A	PC	Elitebock 480	hp	CNU416B860	Customer provided	ne	-/-	-/-
5	A	Power supply	EA-PS 3032-65	Elektro Automatik	-/-	300002318	ne	-/-	-/-
6	A	Spectrum analyser	FSV30	R&S	100763	300003950	k	31.01.2017	30.01.2018

7.6 Shielded fully anechoic chamber

OTA – over the air performance

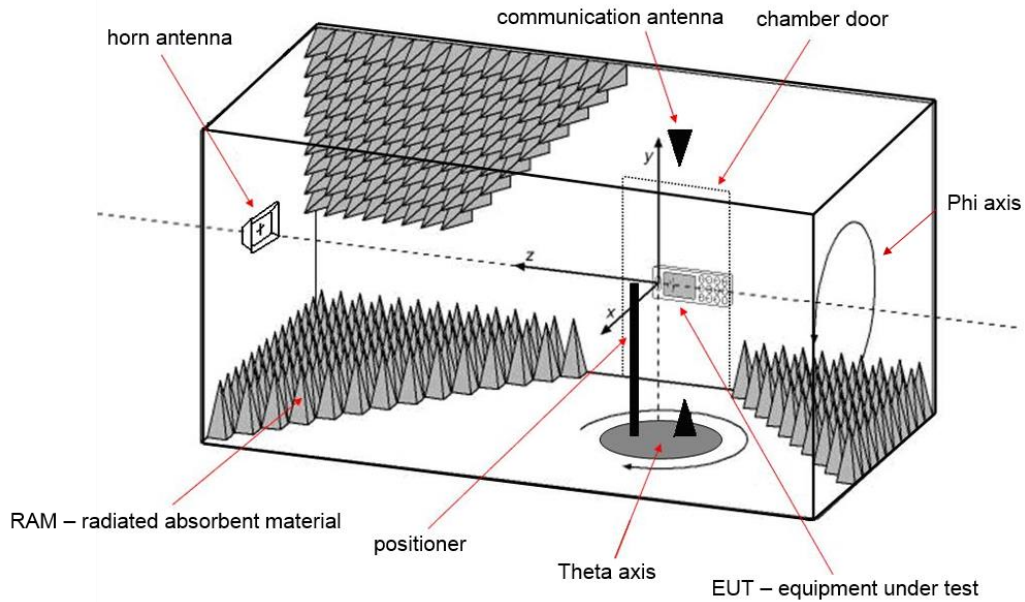

Equipment table:

No.	Lab / Item	Equipment	Type	Manufacturer	Serial No.	INV. No.	Kind of Calibration	Last Calibration	Next Calibration
1	A	Splitter	15542	Mini Circuits	15542	400000086	ev	-/-	-/-
2	A	Splitter	42000	Anaren	4730	400000085	ev	-/-	-/-
3	A	Switch Unit	TS-RSP	R&S	100155	300003281	ev	-/-	-/-
4	A	CTIA-Chamber	CTIA-Chamber AMS 8500	ETS-Lindgren Finland	-/-	300003327	ne	-/-	-/-
5	A	CTIA-Chamber - Positioning Equipment	CTIA-Chamber - Positioning Equipment	EMCO/2	-/-	300003328	ne	-/-	-/-
6	A	CTIA-Chamber - Software	CTIA-Chamber - Software	EMCO/2	-/-	300003328	ne	-/-	-/-
7	A	CTIA-Chamber - Antenna	3164-04	EMCO/2	00041915	300003328	ne	-/-	-/-
8	A	Spectrum Analy zer 9kHz - 30 GHz	FSP30	R&S	100623	300003464	v IKI!	01.02.2017	31.01.2019
9	A	Hygro-Thermometer	5-45 C, 20-100 rF	Thies Clima	-/-	400000089	ev	07.09.2015	07.09.2017

8 Sequence of testing

8.1 Sequence of testing radiated spurious 9 kHz to 30 MHz

Setup

- The equipment is set up to simulate normal operation mode as described in the user manual or defined by the manufacturer.
- If the EUT is a tabletop system, a 2-axis positioner with 1.5 m height is used.
- If the EUT is a floor standing device, it is placed directly on the turn table.
- Auxiliary equipment and cables are positioned to simulate normal operation conditions as described in ANSI C 63.4.
- The AC power port of the EUT (if available) is connected to a power outlet below the turntable.
- Measurement distance is 3 m (see ANSI C 63.4) – see test details.
- EUT is set into operation.

Premeasurement

- The turntable rotates from 0° to 315° using 45° steps.
- The antenna height is 1.5 m.
- At each turntable position the analyzer sweeps with positive-peak detector to find the maximum of all emissions.

Final measurement

- Identified emissions during the premeasurement are maximized by the software by rotating the turntable from 0° to 360°. In case of the 2-axis positioner is used the elevation axis is also rotated from 0° to 360°.
- The final measurement is done in the position (turntable and elevation) causing the highest emissions with quasi-peak (as described in ANSI C 63.4).
- Final levels, frequency, measuring time, bandwidth, turntable position, correction factor, margin to the limit and limit will be recorded. A plot with the graph of the premeasurement and the limit is stored.

8.2 Sequence of testing radiated spurious 30 MHz to 1 GHz

Setup

- The equipment is set up to simulate normal operation mode as described in the user manual or defined by the manufacturer.
- If the EUT is a tabletop system, a table with 0.8 m height is used, which is placed on the ground plane.
- If the EUT is a floor standing device, it is placed on the ground plane with insulation between both.
- Auxiliary equipment and cables are positioned to simulate normal operation conditions as described in ANSI C 63.4.
- The AC power port of the EUT (if available) is connected to a power outlet below the turntable.
- Measurement distance is 10 m or 3 m (see ANSI C 63.4) – see test details.
- EUT is set into operation.

Premeasurement

- The turntable rotates from 0° to 315° using 45° steps.
- The antenna is polarized vertical and horizontal.
- The antenna height changes from 1 m to 3 m.
- At each turntable position, antenna polarization and height the analyzer sweeps three times in peak to find the maximum of all emissions.

Final measurement

- The final measurement is performed for at least six highest peaks according to the requirements of the ANSI C63.4.
- Based on antenna and turntable positions at which the peak values are measured the software maximize the peaks by changing turntable position $\pm 45^\circ$ and antenna height between 1 and 4 m.
- The final measurement is done with quasi-peak detector (as described in ANSI C 63.4).
- Final levels, frequency, measuring time, bandwidth, antenna height, antenna polarization, turntable angle, correction factor, margin to the limit and limit are recorded. A plot with the graph of the premeasurement with marked maximum final results and the limit is stored.

8.3 Sequence of testing radiated spurious 1 GHz to 18 GHz

Setup

- The equipment is set up to simulate normal operation mode as described in the user manual or defined by the manufacturer.
- If the EUT is a tabletop system, a 2-axis positioner with 1.5 m height is used.
- If the EUT is a floor standing device, it is placed directly on the turn table.
- Auxiliary equipment and cables are positioned to simulate normal operation conditions as described in ANSI C 63.4.
- The AC power port of the EUT (if available) is connected to a power outlet below the turntable.
- Measurement distance is 3 m (see ANSI C 63.4) – see test details.
- EUT is set into operation.

Premeasurement

- The turntable rotates from 0° to 315° using 45° steps.
- The antenna is polarized vertical and horizontal.
- The antenna height is 1.5 m.
- At each turntable position and antenna polarization the analyzer sweeps with positive peak detector to find the maximum of all emissions.

Final measurement

- The final measurement is performed for at least six highest peaks according to the requirements of the ANSI C63.4.
- Based on antenna and turntable positions at which the peak values are measured the software maximizes the peaks by rotating the turntable from 0° to 360°. This measurement is repeated for different EUT-table positions (0° to 150° in 30°-steps) and for both antenna polarizations.
- The final measurement is done in the position (turntable, EUT-table and antenna polarization) causing the highest emissions with Peak and RMS detector (as described in ANSI C 63.4).
- Final levels, frequency, measuring time, bandwidth, turntable position, EUT-table position, antenna polarization, correction factor, margin to the limit and limit are recorded. A plot with the graph of the premeasurement with marked maximum final results and the limit is stored.

8.4 Sequence of testing radiated spurious above 18 GHz

Setup

- The equipment is set up to simulate normal operation mode as described in the user manual or defined by the manufacturer.
- Auxiliary equipment and cables are positioned to simulate normal operation conditions as described in ANSI C 63.4.
- The AC power port of the EUT (if available) is connected to a power outlet.
- The measurement distance is as appropriate (e.g. 0.5 m).
- The EUT is set into operation.

Premeasurement

- The test antenna is handheld and moved carefully over the EUT to cover the EUT's whole sphere and different polarizations of the antenna.

Final measurement

- The final measurement is performed at the position and antenna orientation causing the highest emissions with Peak and RMS detector (as described in ANSI C 63.4).
- Final levels, frequency, measuring time, bandwidth, correction factor, margin to the limit and limit are recorded. A plot with the graph of the premeasurement and the limit is stored.

9 Measurement uncertainty

Measurement uncertainty	
Test case	Uncertainty
Frequency stability	± 100 Hz
Emission bandwidth	± 21.5 kHz absolute; ± 15.0 kHz relative
Maximum output power	± 1 dB
Band edge	± 3 dB
Spurious emissions radiated 30 MHz to 1 GHz	± 3 dB
Spurious emissions radiated 1 GHz to 12.75 GHz	± 3.7 dB
Spurious emissions radiated above 12.75 GHz	± 4.5 dB
Spurious emissions conducted below 30 MHz (AC conducted)	± 2.6 dB

10 Summary of measurement results

<input checked="" type="checkbox"/>	No deviations from the technical specifications were ascertained
<input type="checkbox"/>	There were deviations from the technical specifications ascertained
<input type="checkbox"/>	This test report is only a partial test report. The content and verdict of the performed test cases are listed below.

TC Identifier	Description	Verdict	Date	Remark
RF-Testing	47 CFR Part 2 47 CFR Part 95 H	See table	2017-09-20	-/-

Test Specification Clause	Test Case	Temperature Conditions	Power Source Voltages	C	NC	NA	NP	Remark
FCC 47 CFR § 95.628(f)(2)	Frequency stability	Nominal and extreme	Nominal	<input checked="" type="checkbox"/>	<input type="checkbox"/>	<input type="checkbox"/>	<input type="checkbox"/>	-/-
FCC 47 CFR § 95.633(e)	Emission bandwidth	Nominal	Nominal	<input checked="" type="checkbox"/>	<input type="checkbox"/>	<input type="checkbox"/>	<input type="checkbox"/>	-/-
FCC 47 CFR § 95.639(f)	Maximum transmit power	Nominal	Nominal	<input checked="" type="checkbox"/>	<input type="checkbox"/>	<input type="checkbox"/>	<input type="checkbox"/>	-/-
FCC 47 CFR § 95.635(d)(7)	Band edge measurements	Nominal	Nominal	<input checked="" type="checkbox"/>	<input type="checkbox"/>	<input type="checkbox"/>	<input type="checkbox"/>	-/-
FCC 47 CFR § 95.635(d)(1)(v) § 95.635(d)(3)	Transmitter unwanted radiation	Nominal	Nominal	<input checked="" type="checkbox"/>	<input type="checkbox"/>	<input type="checkbox"/>	<input type="checkbox"/>	-/-
FCC 47 CFR § 95.635(d)(1)(v) § 95.635(d)(3)	Receiver spurious emissions (radiated)	Nominal	Nominal	<input checked="" type="checkbox"/>	<input type="checkbox"/>	<input type="checkbox"/>	<input type="checkbox"/>	-/-
FCC 47 CFR § 15.107(a) § 15.207	Conducted emissions below 30 MHz (AC conducted)	Nominal	Nominal	<input type="checkbox"/>	<input type="checkbox"/>	<input checked="" type="checkbox"/>	<input type="checkbox"/>	Battery operated only
550599 D01 Medical Body Area Network v01 § 95.628 (c)	Connection interrupt test	Nominal	Nominal	<input checked="" type="checkbox"/>	<input type="checkbox"/>	<input type="checkbox"/>	<input type="checkbox"/>	-/-

Note: C = Compliant; NC = Not compliant; NA = Not Applicable; NP = Not Performed

11 Additional comments

Reference documents: Customer questionnaire

Special test descriptions: Channel 0 (2363 MHz) uses the power setting 2. All channels within the band 2364 MHz to 2390 MHz use power setting 1 and all channels within the band 2390 MHz to 2400 MHz use power setting 5.

Configuration descriptions: None

Test mode: Special software is used.
EUT is transmitting pseudo random data by itself

Antennas and transmit operating modes:

Operating mode 1 (single antenna)

- *Equipment with 1 antenna,*
- *Equipment with 2 diversity antennas operating in switched diversity mode by which at any moment in time only 1 antenna is used,*
- *Smart antenna system with 2 or more transmit/receive chains, but operating in a mode where only 1 transmit/receive chain is used)*

Operating mode 2 (multiple antennas, no beamforming)

- *Equipment operating in this mode contains a smart antenna system using two or more transmit/receive chains simultaneously but without beamforming.*

Operating mode 3 (multiple antennas, with beamforming)

- *Equipment operating in this mode contains a smart antenna system using two or more transmit/receive chains simultaneously with beamforming. In addition to the antenna assembly gain (G), the beamforming gain (Y) may have to be taken into account when performing the measurements.*

Expected results for systems test:

The timing specification of the MBAN System is as follows:

- MBAN P/C ceases any transmissions in the 2360 – 2390 MHz band < 60 seconds after communication with the MBAN Control Point is lost
- Body-Worn Sensor ceases any transmissions in the 2360 – 2390 MHz band < 6 seconds after the communication to the MBAN P/C is lost

Expected Results for Connection interrupt test (body-worn sensor) in 12.7 according to MBAN System Description (declared from manufacturer) (see Project Note)

Timeout for MBAN P/C connection interrupt: 60 seconds
Timeout for Body-Worn Sensor connection interrupt: 66 seconds

System description (declared from manufacturer):

Project Note

Subject: MBAN System Description for FCC Approval

Affected Products:

Single SRR (FCC ID: PQC- SRRFMPBV1) in

- Avalon CL Fetal & Maternal Pod (866488)

This Project Note is made in order to describe the behavior of an MBAN System with an MBAN Control Point, MBAN P/Cs and Body-Worn Sensors.

An MBAN System (1) consists of:

- an MBAN Control Point which coordinates the usage of the restricted 2360 – 2390 MHz band
- MBAN P/Cs holding connections to Body-Worn Sensors
- Body-Worn Sensors sending data to their MBAN P/C

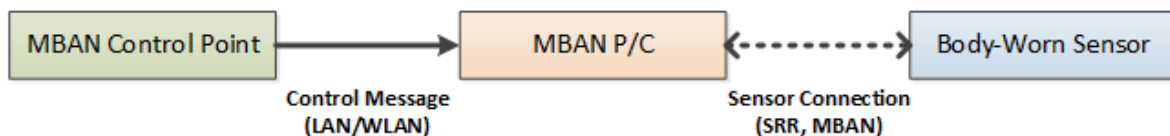

1 - MBAN System

The MBAN Control Point periodically sends a control message to the MBAN P/Cs which includes the following information:

- Channel Mask: An IEEE 802.15.4 channel mask listing the permitted frequencies in the 2360 – 2390 MHz band.
- Reception Period: The period in which the MBAN P/C has to receive at least one control message or has to cease any transmissions in the 2360 – 2390 MHz band.

In the default configuration, the control message is sent at an interval of 20 seconds and the reception period is 60 seconds (three times of the interval).

When a MBAN P/C receives a control message from the MBAN Control Point it automatically selects a channel according to the received Channel Mask. This channel is used for connections between the MBAN P/C and Body-Worn Sensors.

Also, the MBAN P/C distributes the received Channel Mask in the unrestricted 2390 – 2400 MHz band to the Body-Worn Sensors.

The Body-Worn Sensor monitors its connection to the MBAN P/C with a maximum timeout of 6 seconds. If there is no communication within this period the connection is dropped and the Body-Worn Sensor will cease any transmissions in the 2360 – 2390 MHz band.

The message flow of the MBAN System is shown in the message sequence diagram.

The timing specification of the MBAN System is as follows:

- MBAN P/C ceases any transmissions in the 2360 – 2390 MHz band < **60 seconds** after communication with the MBAN Control Point is lost
- Body-Worn Sensor ceases any transmissions in the 2360 – 2390 MHz band < **6 seconds** after the communication to the MBAN P/C is lost

Message sequence diagram:

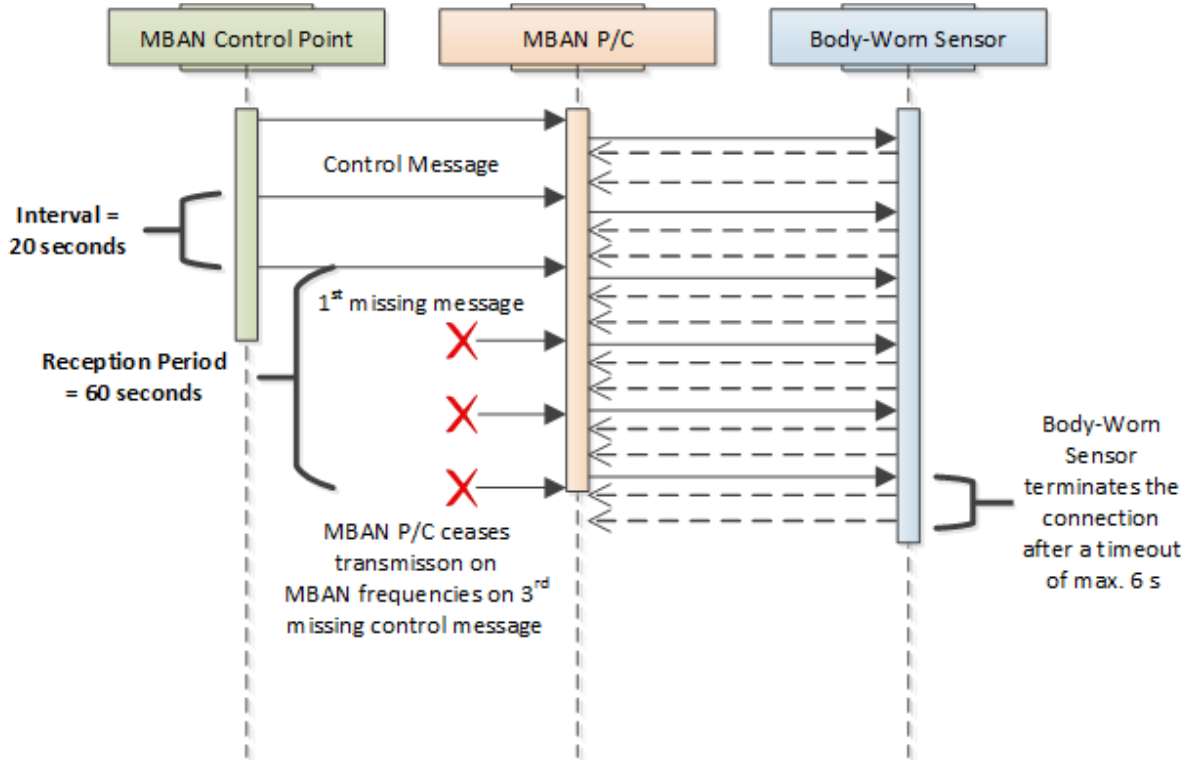

12 Measurement results

12.1 Frequency stability

Measurement:

Measurements in accordance to KDB 550599 chapter V; section A - frequency stability measurement.

Measurement parameter	
Detector:	Peak
Sweep time:	Auto
Resolution bandwidth:	10 kHz
Video bandwidth:	30 kHz
Span:	5 MHz
Trace mode:	Max. hold
Test setup:	See sub clause 7.4 – B
Measurement uncertainty:	See sub clause 9

Limits:

FCC	IC
CFR § 95.628 (f)	-/-
Frequency stability	
All MBAN devices must maintain a frequency stability of ± 100 ppm over a temperature range of 0°C to +55°C.	

Results: Channel low (2363 MHz), lower band

Temp [°C]	Time	Measured Frequency [MHz]	Deviation [kHz]	Deviation [ppm]	Verdict
0	Startup	2362.9635	-36.5	-15	Compliant
	After 2 minutes	2362.9275	-72.5	-31	Compliant
	After 5 minutes	2362.9635	-36.5	-15	Compliant
	After 10 minutes	2362.9635	-36.5	-15	Compliant
10	Startup	2362.9395	-60.5	-26	Compliant
	After 2 minutes	2362.9515	-48.5	-21	Compliant
	After 5 minutes	2362.9515	-48.5	-21	Compliant
	After 10 minutes	2362.9515	-48.5	-21	Compliant
20	Startup	2362.9515	-48.5	-21	Compliant
	After 2 minutes	2362.9635	-36.5	-15	Compliant
	After 5 minutes	2362.9395	-60.5	-26	Compliant
	After 10 minutes	2362.9755	-24.5	-10	Compliant
30	Startup	2362.9515	-48.5	-21	Compliant
	After 2 minutes	2362.9395	-60.5	-26	Compliant
	After 5 minutes	2362.9515	-48.5	-21	Compliant
	After 10 minutes	2362.9275	-72.5	-31	Compliant
40	Startup	2362.9515	-48.5	-21	Compliant
	After 2 minutes	2362.9275	-72.5	-31	Compliant
	After 5 minutes	2362.9275	-72.5	-31	Compliant
	After 10 minutes	2362.9395	-60.5	-26	Compliant
50	Startup	2362.9635	-36.5	-15	Compliant
	After 2 minutes	2362.9395	-60.5	-26	Compliant
	After 5 minutes	2362.9515	-48.5	-21	Compliant
	After 10 minutes	2362.9395	-60.5	-26	Compliant
55	Startup	2362.9275	-72.5	-31	Compliant
	After 2 minutes	2362.9275	-72.5	-31	Compliant
	After 5 minutes	2362.9275	-72.5	-31	Compliant
	After 10 minutes	2362.9395	-60.5	-26	Compliant

Results: Channel mid (2382 MHz), lower band

Temp [°C]	Time	Measured Frequency [MHz]	Deviation [kHz]	Deviation [ppm]	Verdict
0	Startup	2381.9515	-48.5	-20	Compliant
	After 2 minutes	2381.9755	-24.5	-10	Compliant
	After 5 minutes	2381.9515	-48.5	-20	Compliant
	After 10 minutes	2381.9395	-60.5	-25	Compliant
10	Startup	2381.9635	-36.5	-15	Compliant
	After 2 minutes	2381.9275	-72.5	-30	Compliant
	After 5 minutes	2381.9395	-60.5	-25	Compliant
	After 10 minutes	2381.9635	-36.5	-15	Compliant
20	Startup	2381.9755	-24.5	-10	Compliant
	After 2 minutes	2381.9395	-60.5	-25	Compliant
	After 5 minutes	2381.9515	-48.5	-20	Compliant
	After 10 minutes	2381.9515	-48.5	-20	Compliant
30	Startup	2381.9275	-72.5	-30	Compliant
	After 2 minutes	2381.9515	-48.5	-20	Compliant
	After 5 minutes	2381.9515	-48.5	-20	Compliant
	After 10 minutes	2381.9635	-36.5	-15	Compliant
40	Startup	2381.9515	-48.5	-20	Compliant
	After 2 minutes	2381.9515	-48.5	-20	Compliant
	After 5 minutes	2381.9275	-72.5	-30	Compliant
	After 10 minutes	2381.9395	-60.5	-25	Compliant
50	Startup	2381.9635	-36.5	-15	Compliant
	After 2 minutes	2381.9515	-48.5	-20	Compliant
	After 5 minutes	2381.9395	-60.5	-25	Compliant
	After 10 minutes	2381.9275	-72.5	-30	Compliant
55	Startup	2381.9275	-72.5	-30	Compliant
	After 2 minutes	2381.9635	-36.5	-15	Compliant
	After 5 minutes	2381.9275	-72.5	-30	Compliant
	After 10 minutes	2381.9395	-60.5	-25	Compliant

Results: Channel high (2387 MHz), lower band

Temp [°C]	Time	Measured Frequency [MHz]	Deviation [kHz]	Deviation [ppm]	Verdict
0	Startup	2386.9515	-48.5	-20	Compliant
	After 2 minutes	2386.9755	-24.5	-10	Compliant
	After 5 minutes	2386.9635	-36.5	-15	Compliant
	After 10 minutes	2386.9515	-48.5	-20	Compliant
10	Startup	2386.9515	-48.5	-20	Compliant
	After 2 minutes	2386.9755	-24.5	-10	Compliant
	After 5 minutes	2386.9635	-36.5	-15	Compliant
	After 10 minutes	2386.9515	-48.5	-20	Compliant
20	Startup	2386.9515	-48.5	-20	Compliant
	After 2 minutes	2386.9395	-60.5	-25	Compliant
	After 5 minutes	2386.9395	-60.5	-25	Compliant
	After 10 minutes	2386.9395	-60.5	-25	Compliant
30	Startup	2386.9515	-48.5	-20	Compliant
	After 2 minutes	2386.9395	-60.5	-25	Compliant
	After 5 minutes	2386.9395	-60.5	-25	Compliant
	After 10 minutes	2386.9395	-60.5	-25	Compliant
40	Startup	2386.9515	-48.5	-20	Compliant
	After 2 minutes	2386.9395	-60.5	-25	Compliant
	After 5 minutes	2386.9395	-60.5	-25	Compliant
	After 10 minutes	2386.9395	-60.5	-25	Compliant
50	Startup	2386.9395	-60.5	-25	Compliant
	After 2 minutes	2386.9515	-48.5	-20	Compliant
	After 5 minutes	2386.9395	-60.5	-25	Compliant
	After 10 minutes	2386.9155	-84.5	-35	Compliant
55	Startup	2386.9395	-60.5	-25	Compliant
	After 2 minutes	2386.9515	-48.5	-20	Compliant
	After 5 minutes	2386.9395	-60.5	-25	Compliant
	After 10 minutes	2386.9155	-84.5	-35	Compliant

Results: Channel low (2392 MHz), upper band

Temp [°C]	Time	Measured Frequency [MHz]	Deviation [kHz]	Deviation [ppm]	Verdict
0	Startup	2391.9395	-60.5	-25	Compliant
	After 2 minutes	2391.9395	-60.5	-25	Compliant
	After 5 minutes	2391.9755	-24.5	-10	Compliant
	After 10 minutes	2391.9275	-72.5	-30	Compliant
10	Startup	2391.9515	-48.5	-20	Compliant
	After 2 minutes	2391.9395	-60.5	-25	Compliant
	After 5 minutes	2391.9515	-48.5	-20	Compliant
	After 10 minutes	2391.9515	-48.5	-20	Compliant
20	Startup	2391.9515	-48.5	-20	Compliant
	After 2 minutes	2391.9395	-60.5	-25	Compliant
	After 5 minutes	2391.9515	-48.5	-20	Compliant
	After 10 minutes	2391.9515	-48.5	-20	Compliant
30	Startup	2391.9395	-60.5	-25	Compliant
	After 2 minutes	2391.9395	-60.5	-25	Compliant
	After 5 minutes	2391.9755	-24.5	-10	Compliant
	After 10 minutes	2391.9275	-72.5	-30	Compliant
40	Startup	2391.9395	-60.5	-25	Compliant
	After 2 minutes	2391.9395	-60.5	-25	Compliant
	After 5 minutes	2391.9755	-24.5	-10	Compliant
	After 10 minutes	2391.9275	-72.5	-30	Compliant
50	Startup	2391.9155	-84.5	-35	Compliant
	After 2 minutes	2391.9635	-36.5	-15	Compliant
	After 5 minutes	2391.9395	-60.5	-25	Compliant
	After 10 minutes	2391.9275	-72.5	-30	Compliant
55	Startup	2391.9155	-84.5	-35	Compliant
	After 2 minutes	2391.9635	-36.5	-15	Compliant
	After 5 minutes	2391.9395	-60.5	-25	Compliant
	After 10 minutes	2391.9275	-72.5	-30	Compliant

Results: Channel high (2397 MHz), upper band

Temp [°C]	Time	Measured Frequency [MHz]	Deviation [kHz]	Deviation [ppm]	Verdict
0	Startup	2396.9275	-72.5	-30	Compliant
	After 2 minutes	2396.9395	-60.5	-25	Compliant
	After 5 minutes	2396.9395	-60.5	-25	Compliant
	After 10 minutes	2396.9635	-36.5	-15	Compliant
10	Startup	2396.9395	-60.5	-25	Compliant
	After 2 minutes	2396.9875	-12.5	-5	Compliant
	After 5 minutes	2396.9875	-12.5	-5	Compliant
	After 10 minutes	2396.9275	-72.5	-30	Compliant
20	Startup	2396.9635	-36.5	-15	Compliant
	After 2 minutes	2396.9755	-24.5	-10	Compliant
	After 5 minutes	2396.9515	-48.5	-20	Compliant
	After 10 minutes	2396.9275	-72.5	-30	Compliant
30	Startup	2396.9755	-24.5	-10	Compliant
	After 2 minutes	2396.9635	-36.5	-15	Compliant
	After 5 minutes	2396.9515	-48.5	-20	Compliant
	After 10 minutes	2396.9395	-60.5	-25	Compliant
40	Startup	2396.9275	-72.5	-30	Compliant
	After 2 minutes	2396.9275	-72.5	-30	Compliant
	After 5 minutes	2396.9275	-72.5	-30	Compliant
	After 10 minutes	2396.9395	-60.5	-25	Compliant
50	Startup	2396.9275	-72.5	-30	Compliant
	After 2 minutes	2396.9755	-24.5	-10	Compliant
	After 5 minutes	2396.9515	-48.5	-20	Compliant
	After 10 minutes	2396.9395	-60.5	-25	Compliant
55	Startup	2396.9515	-48.5	-20	Compliant
	After 2 minutes	2396.9515	-48.5	-20	Compliant
	After 5 minutes	2396.9395	-60.5	-25	Compliant
	After 10 minutes	2396.9515	-48.5	-20	Compliant

12.2 Emission bandwidth

Measurement:

Measurements were made in accordance with the requirements detailed in FCC Part 95, Section 95.633(e)(3) - emission bandwidth with reference to KDB 558074 DTS 2.0.

Measurement parameter	
Detector:	Peak
Sweep time:	Auto
Resolution bandwidth:	30 kHz
Video bandwidth:	100 kHz
Span:	5 MHz
Trace mode:	Max. hold
Test setup:	See sub clause 7.4 – A
Measurement uncertainty:	See sub clause 9

Limits:

FCC	IC
CFR § 95.633 (e)(1)(3)	-/-
<p>Emission bandwidth will be determined by measuring the width of the signal between points, one below the carrier center frequency and one above the carrier center frequency, that are 20 dB down relative to the maximum level of the modulated carrier. Compliance with the emission bandwidth limit is based on the use of measurement instrumentation employing a peak detector function with an instrument resolution bandwidth approximately equal to 1.0 percent of the emission bandwidth of the device under measurement.</p> <p>For stations operating in 2360-2400 MHz, the maximum authorized emission bandwidth is 5 megahertz.</p>	

Results:

Channel	Frequency [MHz]	Emission bandwidth [kHz]
Low (lower band)	2363	2715
Mid (lower band)	2382	2715
High (lower band)	2387	2695
Low (upper band)	2392	2756
High (upper band)	2397	2625

Plots:

Plot 1: lowest channel, lower band

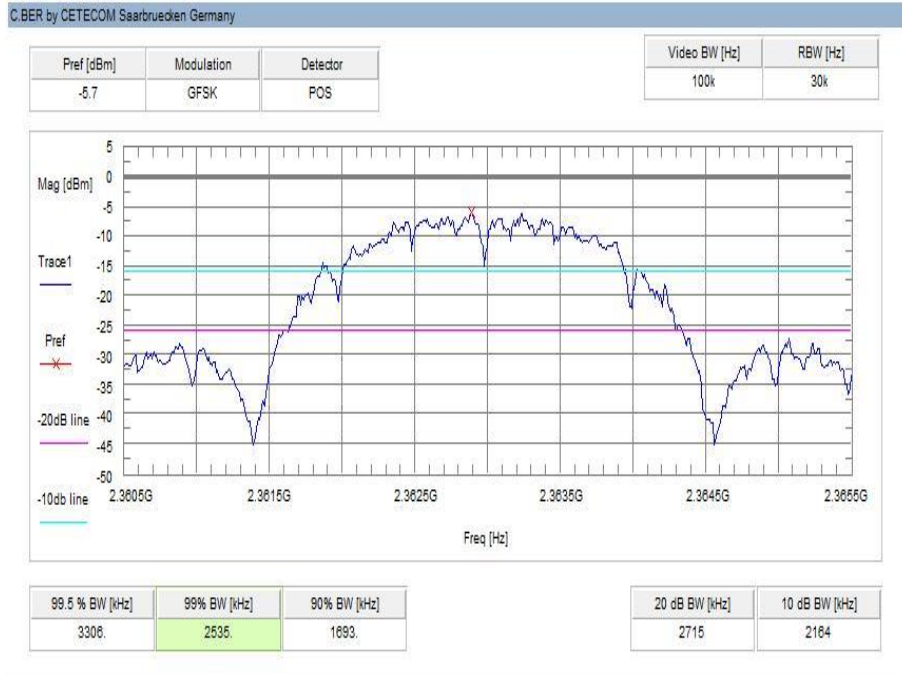

Plot 2: mid channel, lower band



Plot 3: highest channel, lower band

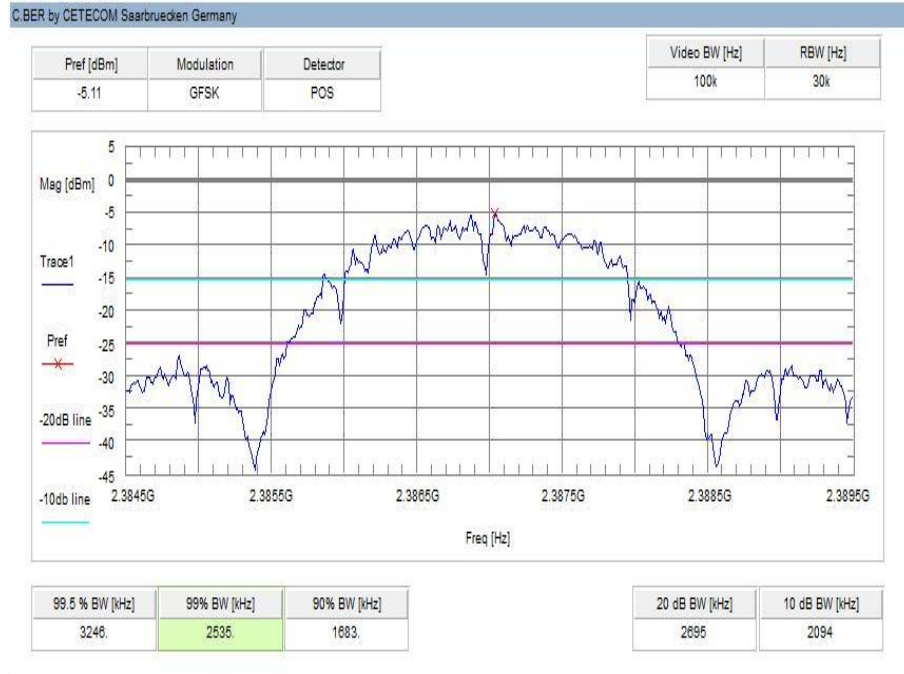

Plot 4: lowest channel, upper band

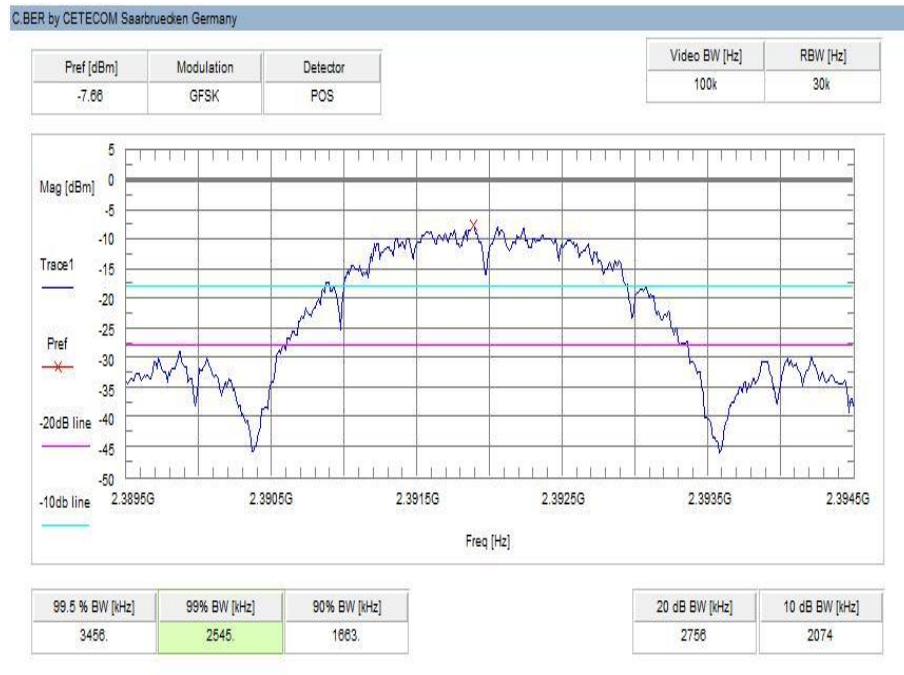

Plot 5: highest channel, upper band

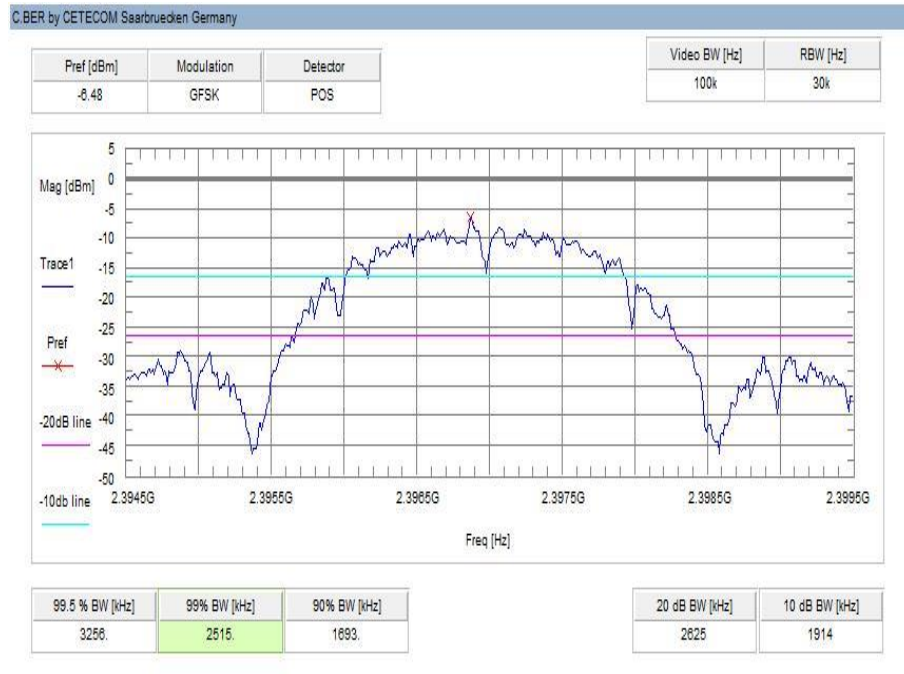

12.3 Maximum transmit power

Measurement:

Measurements were made in accordance with the procedures detailed in FCC 95.628 (f)(3) and KDB 558074 chapter 9.0 section 9.1.1.

Measurement parameter	
Detector:	Peak
Sweep time:	Auto
Resolution bandwidth:	3 MHz
Video bandwidth:	10 MHz
Span:	10 MHz
Trace mode:	Max. hold
Test setup:	See sub clause 7.2 – B; 7.4 – A & 7.6 – A
Measurement uncertainty:	See sub clause 9

Limits:

FCC	IC
47 CFR § 95.639 (f)(3)(4)(5)	-/-
<p>95.639(f)(3): The antenna associated with any MedRadio transmitter must be supplied with the transmitter and shall be considered part of the transmitter subject to equipment authorization.</p> <p>95.639(f)(4): MBAN transmissions in the 2390 – 2400 MHz frequency band are limited to a maximum equivalent isotropic radiated power (EIRP) that shall not exceed the lesser of 20 mW (13 dBm) or 16 + 10log (EBW) dBm, where EBW is expressed in MHz.</p> <p>95.639(f)(5): MBAN transmissions in the 2360 – 2390 MHz frequency band are limited to a maximum equivalent isotropic radiated power (EIRP) that shall not exceed the lesser of 1 mW (0 dBm) or 10log (EBW) dBm, where EBW is expressed in MHz.</p>	

Result:

Frequency [MHz]	Output power conducted measured [dBm]	Gain calculated [dBi]	EIRP measured [dBm]	Limit [dBm]
2363	2.1	-2.2	-0.1	0.0
2382	1.1	-1.6	-0.6	0.0
2387	0.9	-1.3	-0.4	0.0
2392	4.6	-1.8	2.8	13.0
2397	4.5	-2.3	2.2	13.0

According to the FCC requirement:

The maximum EIRP levels were calculated with the conducted output power (see plots) and the antenna gain stated in the table. The values do not include any influence from a human body phantom or an equivalent testing setup.

In addition to the results, 3D antenna diagrams were performed for the lowest and the highest provided channel. The maximum output power determined shows the same power level as the calculated values.

Photo: test setup OTA (over the air performance)

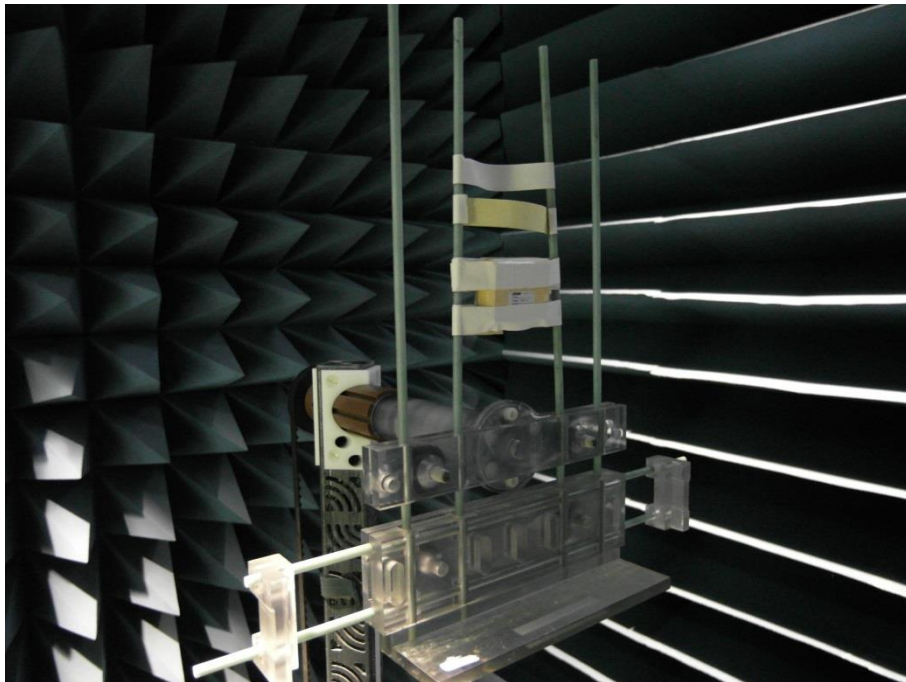

No human body phantom or an equivalent testing setup was used for the test setup.

Plots: conducted

Plot 1: lowest channel, lower band

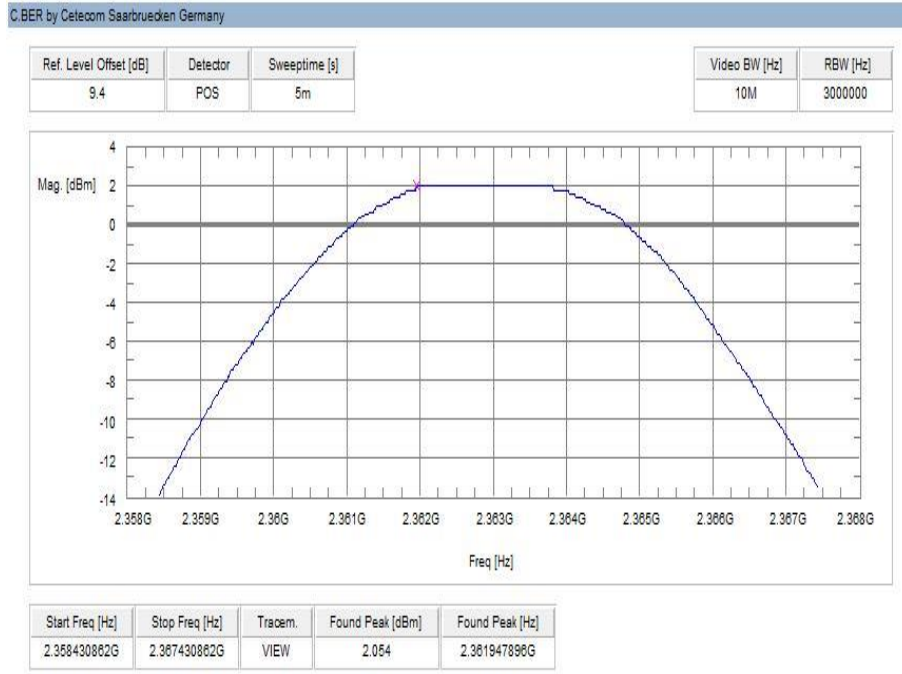

Plot 2: mid channel, lower band



Plot 3: highest channel, lower band

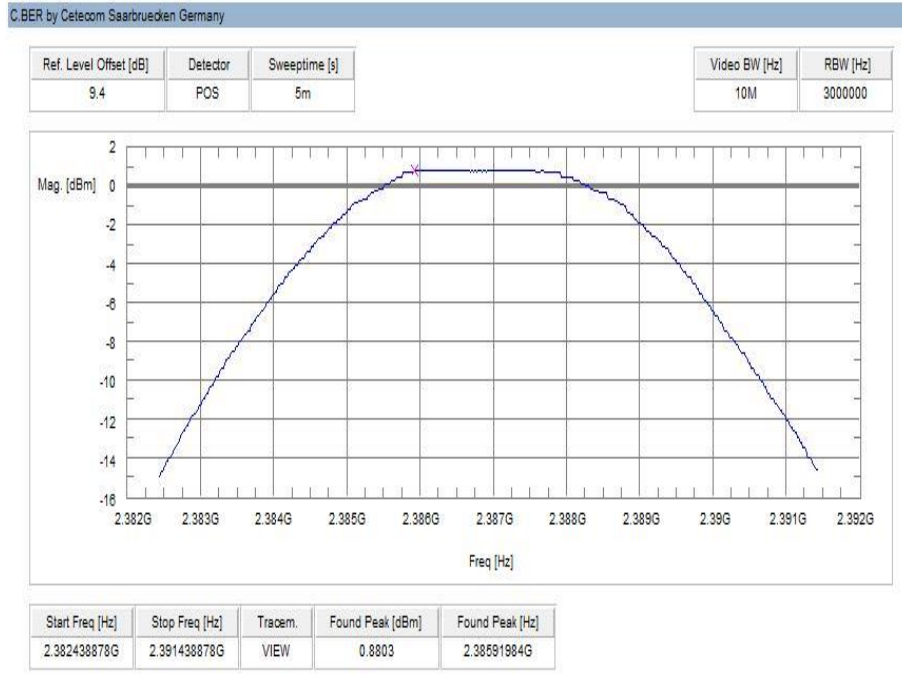

Plot 4: lower channel, upper band



Plot 5: highest channel, upper band

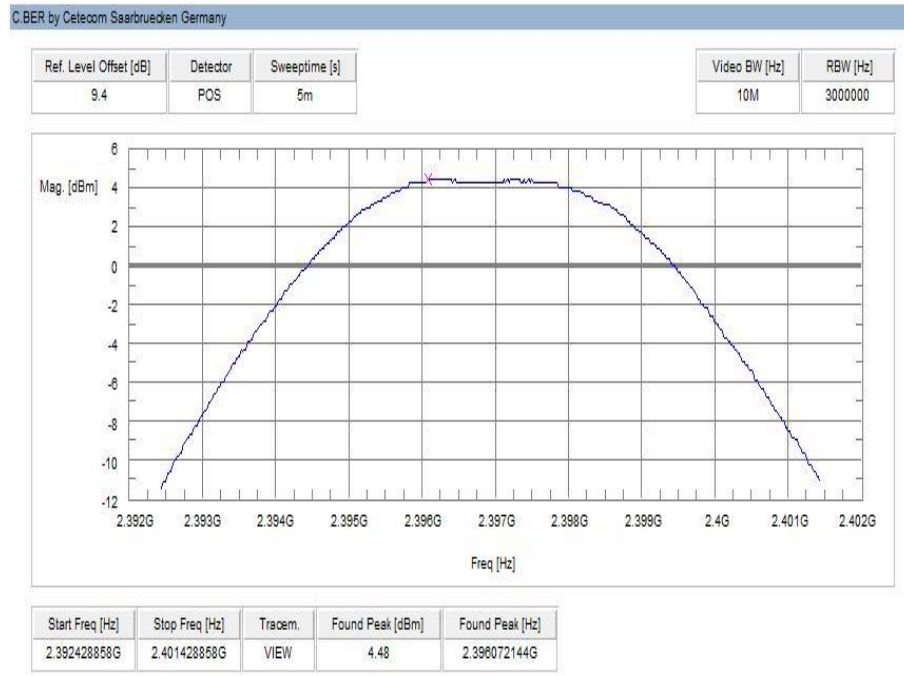

Plots: radiated

Plot 1: lowest channel, lower band, antenna diagram with maximum EIRP

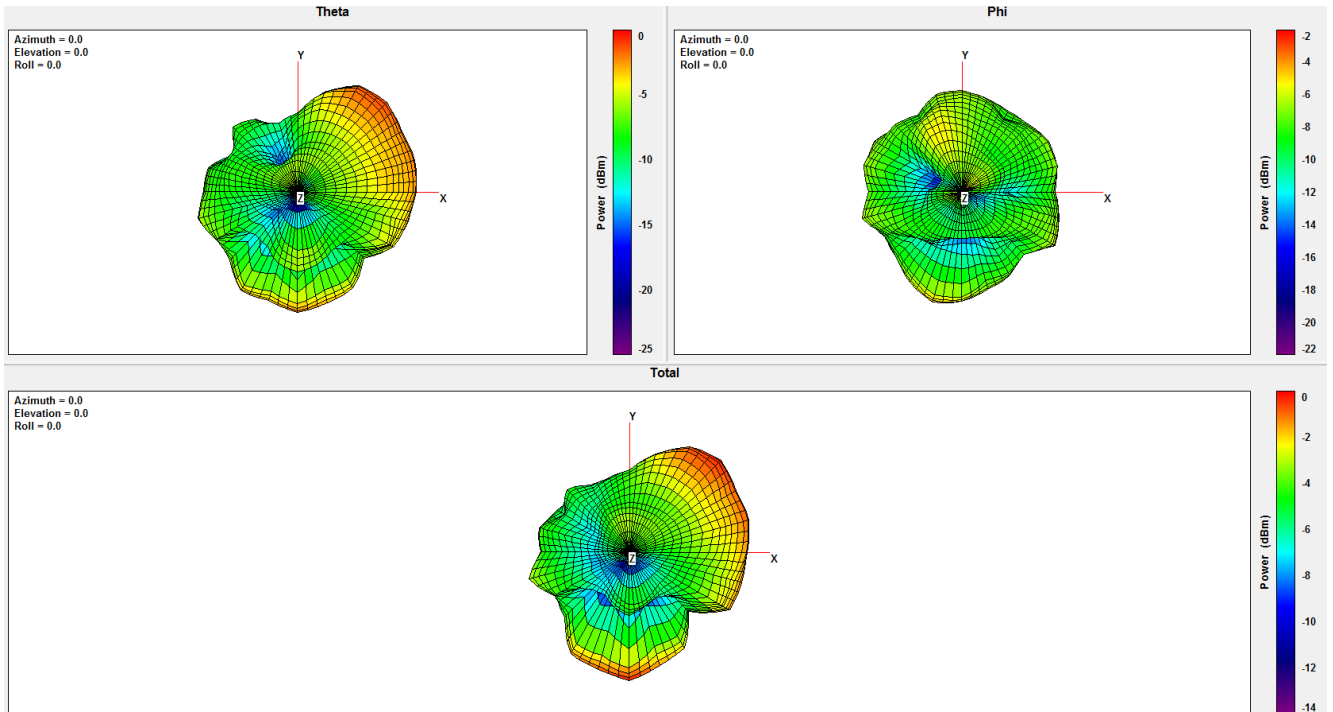

Total	Point Values	
	Ant. Port Input Pwr. (dBm)	0
	Tot. Rad. Pwr. (dBm)	-3,8587
	Peak EIRP (dBm)	-0,0506262

Plot 2: mid channel, lower band, antenna diagram with maximum EIRP

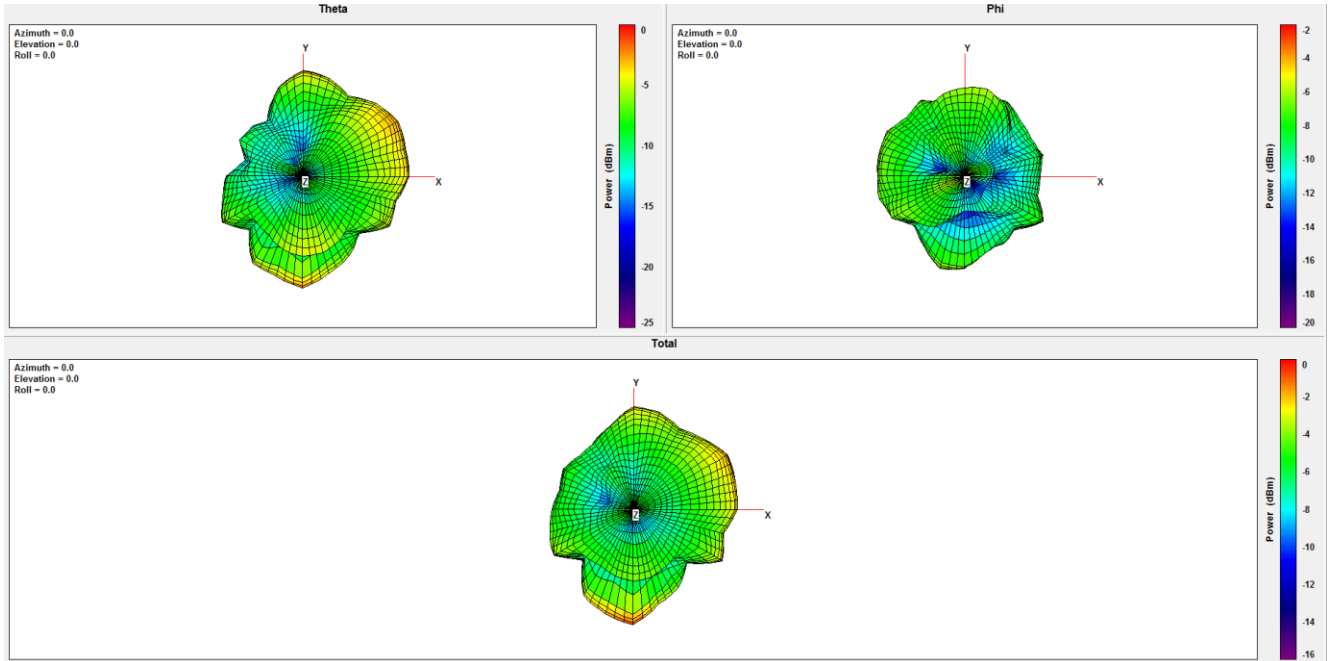

Total	Point Values	
	Ant. Port Input Pwr. (dBm)	0
	Tot. Rad. Pwr. (dBm)	-4,87983
	Peak EIRP (dBm)	-0,571097

Plot 3: highest channel, lower band, antenna diagram with maximum EIRP

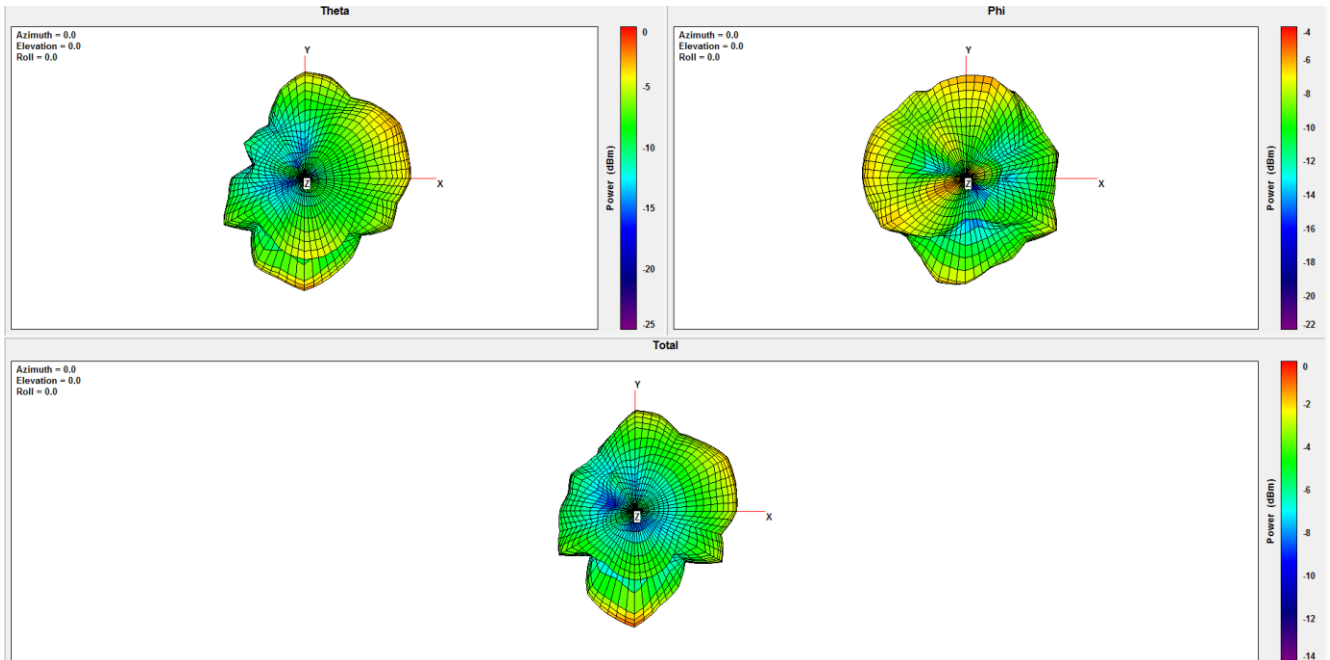

Total	Point Values	
	Ant. Port Input Pwr. (dBm)	0
	Tot. Rad. Pwr. (dBm)	-4,81288
	Peak EIRP (dBm)	-0,429346

Plot 4: low channel, upper band, antenna diagram with maximum EIRP

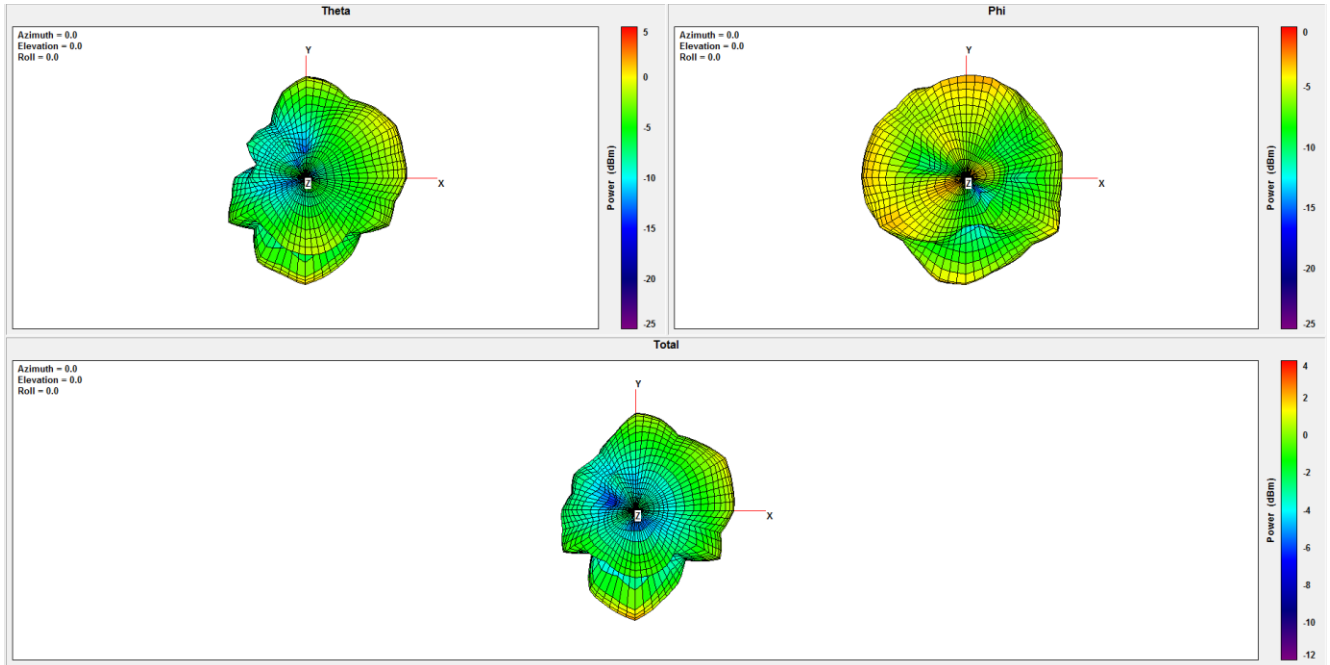

Total	Point Values	
	Ant. Port Input Pwr. (dBm)	0
	Tot. Rad. Pwr. (dBm)	-1,7348
	Peak EIRP (dBm)	2,75943

Plot 5: highest channel, upper band, antenna diagram with maximum EIRP

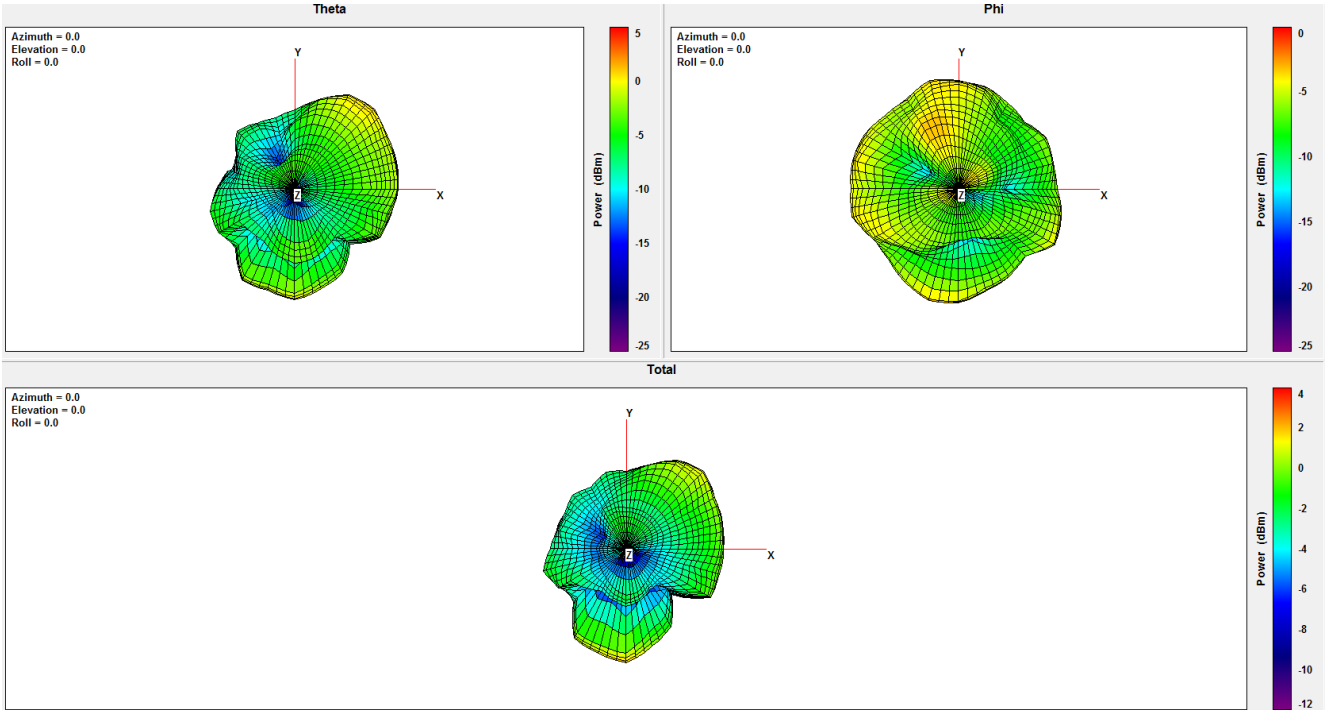

Total	Point Values	
	Ant. Port Input Pwr. (dBm)	0
	Tot. Rad. Pwr. (dBm)	-2,15597
	Peak EIRP (dBm)	2,21645

12.4 Band edge measurement

Measurement:

Measurements were made in accordance with the procedure detailed in KDB 550599 section D1 (ANSI C63.26 5.7.2).

Measurement parameter	
Detector:	Peak
Sweep time:	Auto
Resolution bandwidth:	1 MHz
Video bandwidth:	3 MHz
Span:	2357.5 MHz – 2392.5 MHz
Trace mode:	Max. hold
Test setup:	See sub clause 7.4 – A
Measurement uncertainty:	See sub clause 9

Limits:

FCC	IC
47 CFR § 95.635(d)(7)	-/-
In the first 2.5 MHz beyond any of the frequency bands authorized for MBAN operation, the EIRP level associated with any unwanted emissions must be attenuated within a 1 MHz bandwidth by at least 20 dB relative to the maximum EIRP level within any 1 MHz of the fundamental emission (i.e., 20 dBc).	

Results:

Channel	Band edge frequency range [MHz]	Frequency [MHz]	Effective attenuation [dBc]	Required attenuation [dBc]
Low	2357.5 – 2360	2363	-25.6	≥ 20
Low	2400 – 2402.5	2363	-39.5	≥ 20
High	2357.5 – 2360	2397	-39.1	≥ 20
High	2400 – 2402.5	2397	-26.9	≥ 20

Plots:

Plot 1: lowest channel, lower band edge

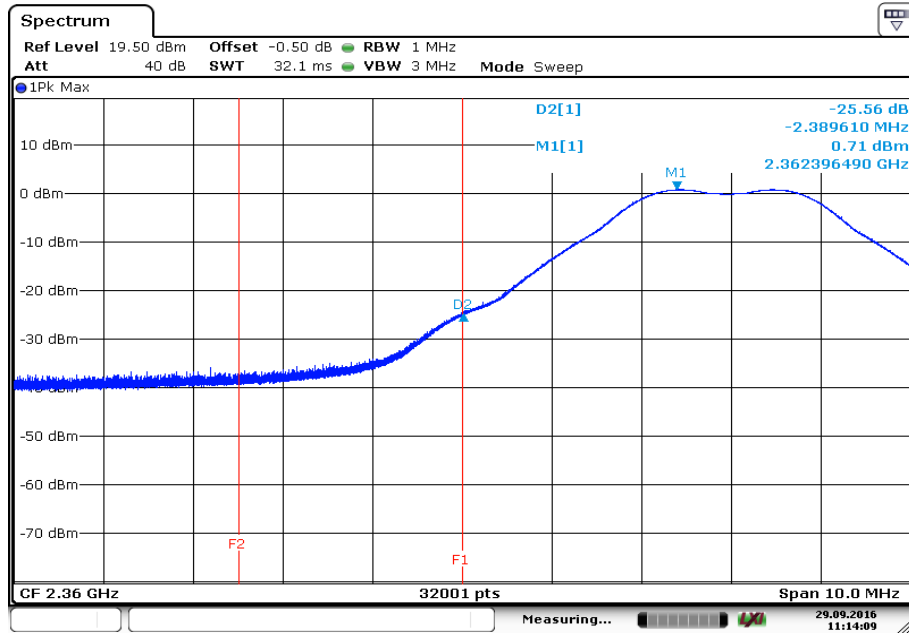

Date: 29.SEP.2016 11:14:10

Plot 2: highest channel, upper band edge

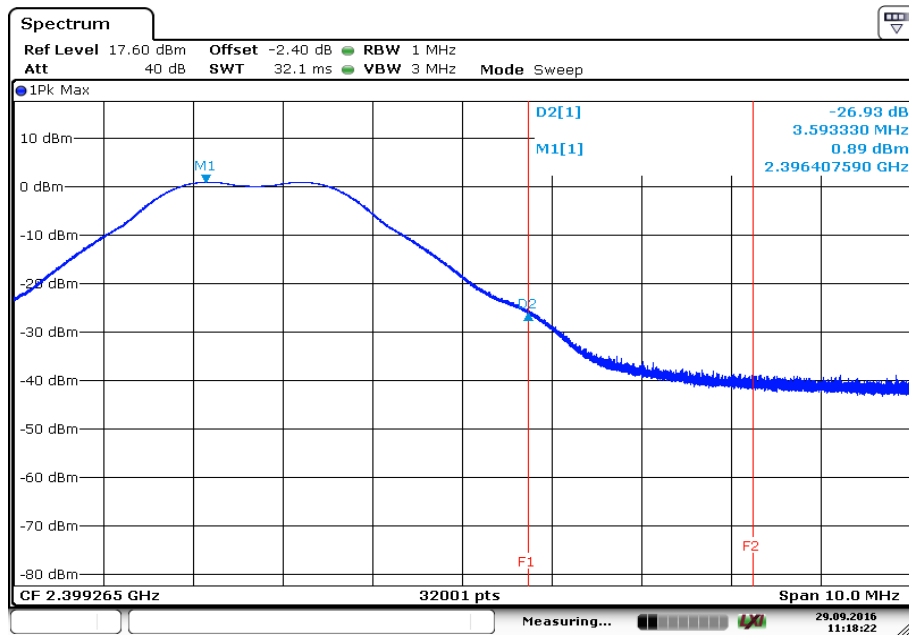

Date: 29.SEP.2016 11:18:22

12.5 Transmitter unwanted radiation (radiated)

Measurement:

Measurements were made in accordance with the procedure detailed in KDB 550599 section D2.

Measurement parameter	
Detector:	Prescan: Peak Final: QPK below 960 MHz RMS above 960 MHz
Video bandwidth:	9 kHz – 150 kHz: 1 kHz 150 kHz – 30 MHz: 30 kHz 30 MHz – 1 GHz: 300 kHz 1 GHz – 26 GHz: 3 MHz
Resolution bandwidth:	9 kHz – 150 kHz: 200 Hz 150 kHz – 30 MHz: 9 kHz 30 MHz – 1 GHz: 100 kHz 1 GHz – 26 GHz: 1 MHz
Span:	See plots
Trace mode:	Max Hold
Test setup:	See sub clause 7.1 – A & 7.2 – A & 7.3 – A
Measurement uncertainty:	See sub clause 9

Limits:

FCC		IC
47 CFR § 15.109 47 CFR § 95.635(d)(1)(v), 95.635(d)(3)		-/-
Transmitter unwanted radiation (radiated)		
Frequency (MHz)	Field strength ($\mu\text{V}/\text{m}$) ¹	Measurement distance (m)
0.009 – 0.490	2400/F(kHz)	300
0.490 – 1.705	24000/F(kHz)	30
1.705 – 30.0	30	30
30 - 88	100 (40 dB $\mu\text{V}/\text{m}$)	3
30 - 88	31.6 (30 dB $\mu\text{V}/\text{m}$)	10
88 - 216	150 (43.5 dB $\mu\text{V}/\text{m}$)	3
88 - 216	47.3 (33.5 dB $\mu\text{V}/\text{m}$)	10
216 - 960	200 (46 dB $\mu\text{V}/\text{m}$)	3
216 - 960	63.1 (36 dB $\mu\text{V}/\text{m}$)	10
above 960	500 (54 dB $\mu\text{V}/\text{m}$)	3

¹ Measurements in the 9 to 90 kHz, 110 to 490 kHz and above 1000 MHz ranges employ an average detector. Otherwise a quasi-peak detector is used.

According to the FCC requirement:

The radiated measurements were performed without a human body phantom or an equivalent testing setup (photo documentation – see external annex D).

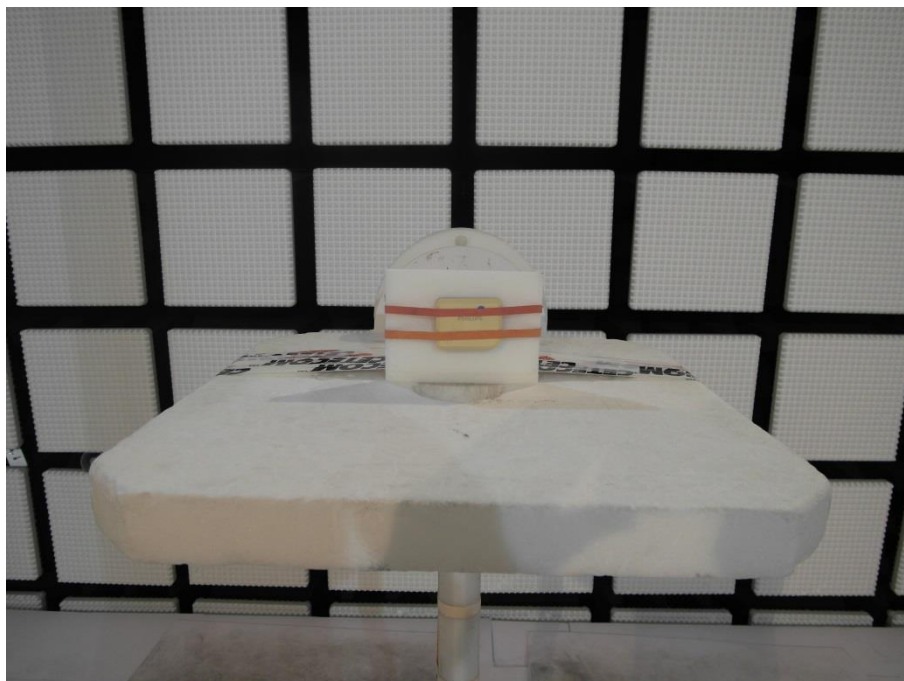

Results: Transmitter mode

Transmitter unwanted radiation [dBµV/m]								
2363 MHz			2382 MHz			2387 MHz		
F [MHz]	Detector	Level [dBµV/m]	F [MHz]	Detector	Level [dBµV/m]	F [MHz]	Detector	Level [dBµV/m]
For emissions below 1 GHz, please look at the table below the 1 GHz plot.								
4727	Peak	56.7	4763	Peak	55.7	4773	Peak	54.2
	QPK	52.5		QPK	51.3		QPK	49.2
7088 No RB	Peak	56.9	7147 No RB	Peak	58.5	7159 No RB	Peak	59.1
	QPK	51.7		QPK	53.4		QPK	54.0
Additional peaks according to KDB 550599.								
1842	Peak	30.2	1842	Peak	30.5	1552	Peak	28.5
	AVG	-/-		AVG	-/-		AVG	-/-
2134	Peak	30.3	2069	Peak	30.2	1842	Peak	30.8
	AVG	-/-		AVG	-/-		AVG	-/-
2472	Peak	31.5	2774	Peak	32.9	2596	Peak	33.3
	AVG	-/-		AVG	-/-		AVG	-/-
2932	Peak	33.5	3219	Peak	35.2	2695	Peak	33.4
	AVG	-/-		AVG	-/-		AVG	-/-
3405	Peak	36.0	3311	Peak	35.5	3166	Peak	35.2
	AVG	-/-		AVG	-/-		AVG	-/-
4532	Peak	30.5	8588	Peak	38.0	8852	Peak	38.9
	AVG	-/-		AVG	-/-		AVG	-/-
9916	Peak	40.2	11519	Peak	43.1	11526	Peak	43.2
	AVG	-/-		AVG	-/-		AVG	-/-
11165	Peak	42.6	14409	Peak	43.7	14337	Peak	44.9
	AVG	-/-		AVG	-/-		AVG	-/-
For emissions above 18 GHz, please look at the plots.								
-/-	Peak	-/-	-/-	Peak	-/-	-/-	Peak	-/-
	AVG	-/-		AVG	-/-		AVG	-/-
-/-	Peak	-/-	-/-	Peak	-/-	-/-	Peak	-/-
	AVG	-/-		AVG	-/-		AVG	-/-
-/-	Peak	-/-	-/-	Peak	-/-	-/-	Peak	-/-
	AVG	-/-		AVG	-/-		AVG	-/-

Results: Transmitter mode

Transmitter unwanted radiation [dBµV/m]								
2392 MHz			-/-			2397 MHz		
F [MHz]	Detector	Level [dBµV/m]	F [MHz]	Detector	Level [dBµV/m]	F [MHz]	Detector	Level [dBµV/m]
For emissions below 1 GHz, please look at the table below the 1 GHz plot.								
4785	Peak	50.7	-/-	Peak	-/-	4795	Peak	52.7
	QPK	45.0		QPK	-/-		QPK	47.8
7174	Peak	52.4	-/-	Peak	-/-	7192 No RB	Peak	59.6
	QPK	45.7		QPK	-/-		QPK	54.8
Additional peaks according to KDB 550599.								
1842	Peak	30.9	-/-	Peak	-/-	1842	Peak	31.1
	AVG	-/-		AVG	-/-		AVG	-/-
2233	Peak	31.3	-/-	Peak	-/-	2091	Peak	30.1
	AVG	-/-		AVG	-/-		AVG	-/-
2557	Peak	32.1	-/-	Peak	-/-	2571	Peak	33.2
	AVG	-/-		AVG	-/-		AVG	-/-
3068	Peak	35.3	-/-	Peak	-/-	3107	Peak	34.3
	AVG	-/-		AVG	-/-		AVG	-/-
3199	Peak	35.8	-/-	Peak	-/-	3374	Peak	35.1
	AVG	-/-		AVG	-/-		AVG	-/-
8746	Peak	38.4	-/-	Peak	-/-	9849	Peak	39.6
	AVG	-/-		AVG	-/-		AVG	-/-
11526	Peak	43.4	-/-	Peak	-/-	11528	Peak	43.2
	AVG	-/-		AVG	-/-		AVG	-/-
14310	Peak	44.4	-/-	Peak	-/-	14215	Peak	43.6
	AVG	-/-		AVG	-/-		AVG	-/-
For emissions above 18 GHz, please look at the plots.								
-/-	Peak	-/-	-/-	Peak	-/-	-/-	Peak	-/-
	AVG	-/-		AVG	-/-		AVG	-/-
-/-	Peak	-/-	-/-	Peak	-/-	-/-	Peak	-/-
	AVG	-/-		AVG	-/-		AVG	-/-
-/-	Peak	-/-	-/-	Peak	-/-	-/-	Peak	-/-
	AVG	-/-		AVG	-/-		AVG	-/-

Plots:

Plot 1: 9 kHz – 30 MHz, channel low, lower band

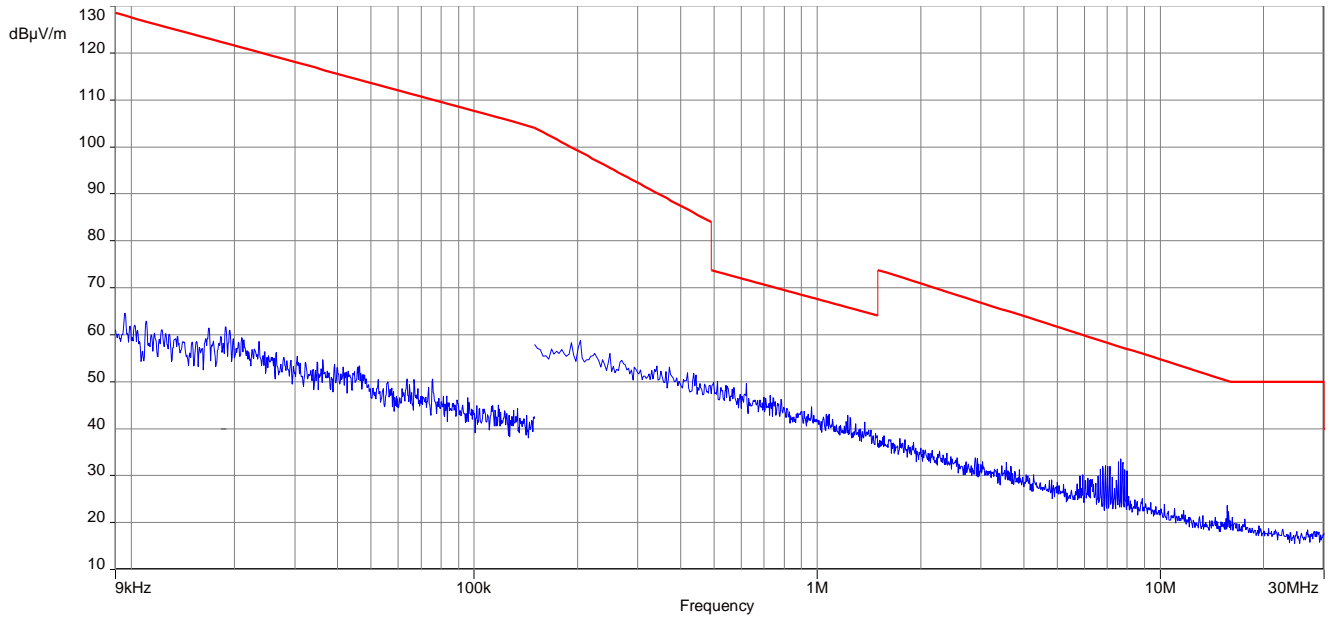

Plot 2: 30 MHz – 1 GHz, channel low, lower band

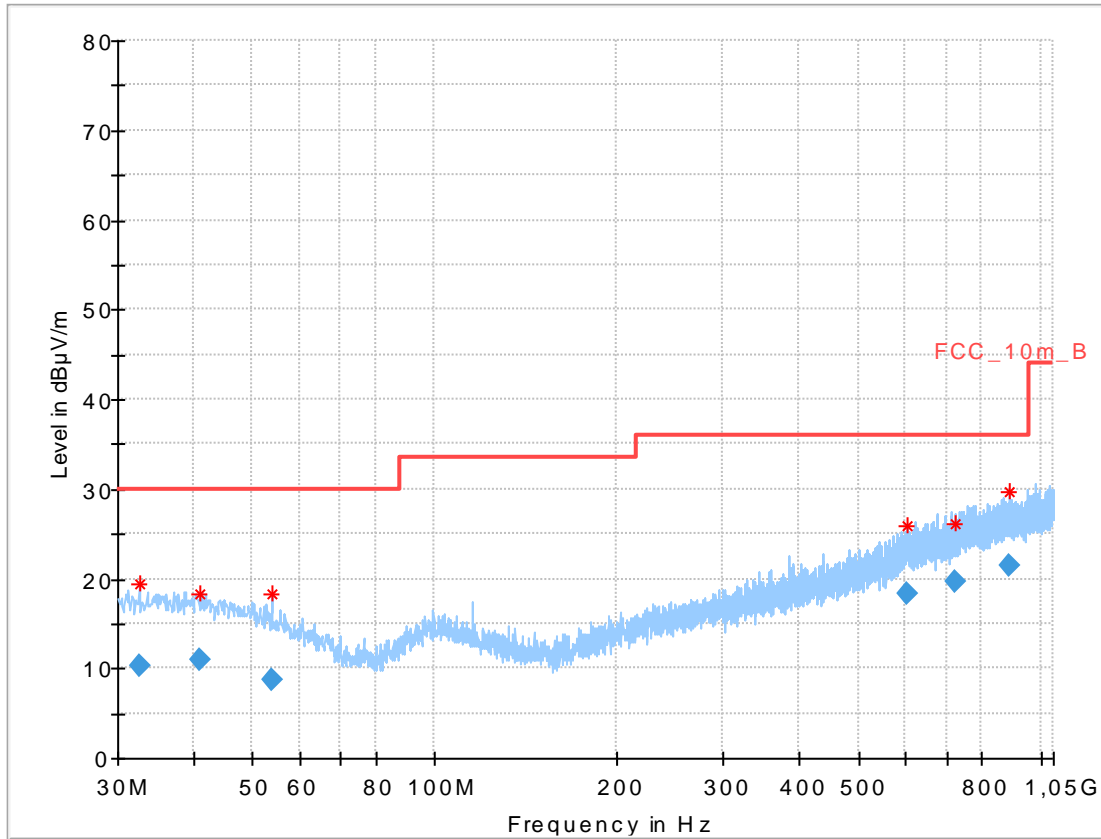

Final_Result:

Frequency (MHz)	QuasiPeak (dBµV/m)	Limit (dBµV/m)	Margin (dB)	Meas. Time (ms)	Bandwidth (kHz)	Height (cm)	Pol	Azimuth (deg)	Corr. (dB)
32.726550	10.29	30.00	19.71	1000.0	120.000	101.0	H	80.0	13.6
41.020350	10.89	30.00	19.11	1000.0	120.000	101.0	H	280.0	14.0
53.943450	8.65	30.00	21.35	1000.0	120.000	101.0	V	100.0	12.0
602.377800	18.37	36.00	17.63	1000.0	120.000	98.0	H	-9.0	20.7
721.645050	19.58	36.00	16.42	1000.0	120.000	170.0	H	190.0	22.0
889.832550	21.52	36.00	14.48	1000.0	120.000	170.0	H	190.0	24.0

Plot 3: 1 GHz – 3.5 GHz, antenna horizontal/vertical, channel low, lower band

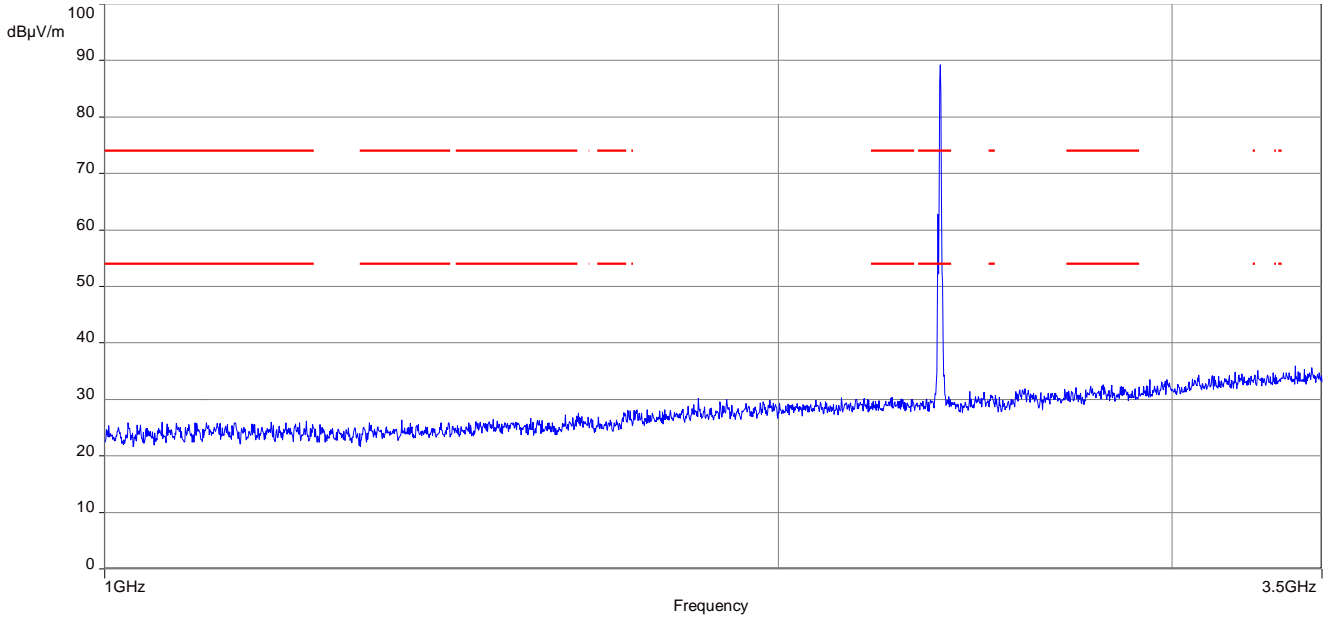

Plot 4: 2392.5 GHz – 18 GHz, antenna horizontal/vertical, channel low, lower band

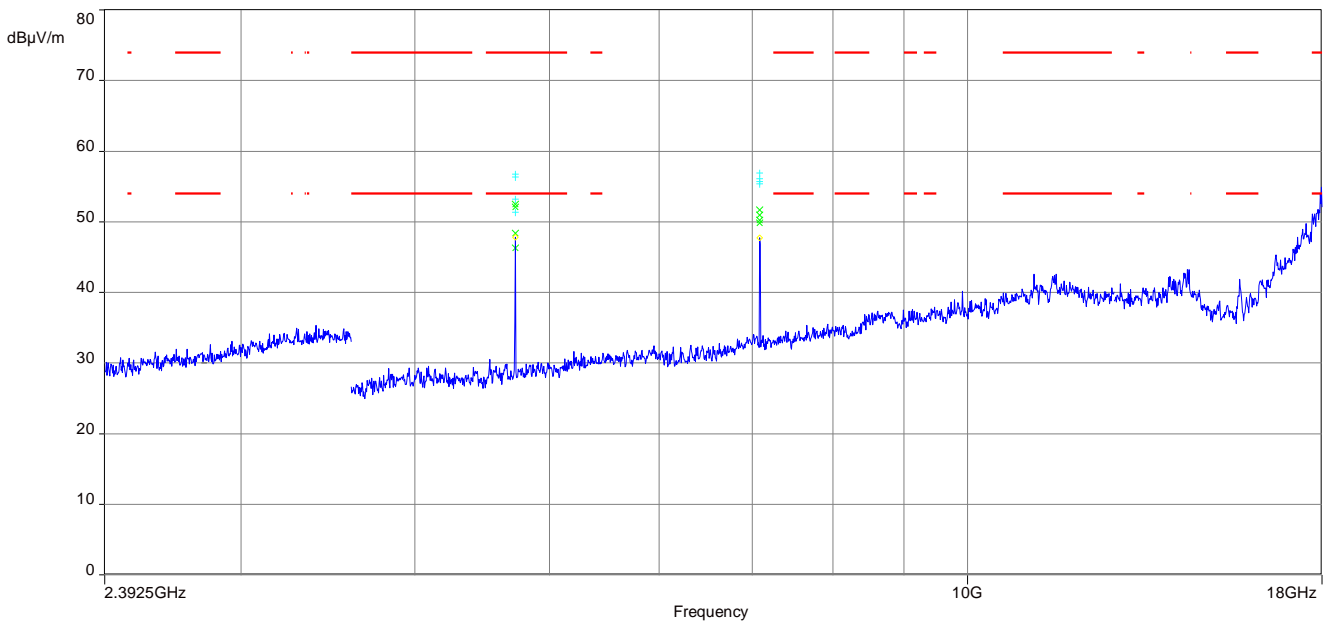

Plot 5: 17.7 GHz – 18 GHz, antenna horizontal/vertical, channel low, lower band

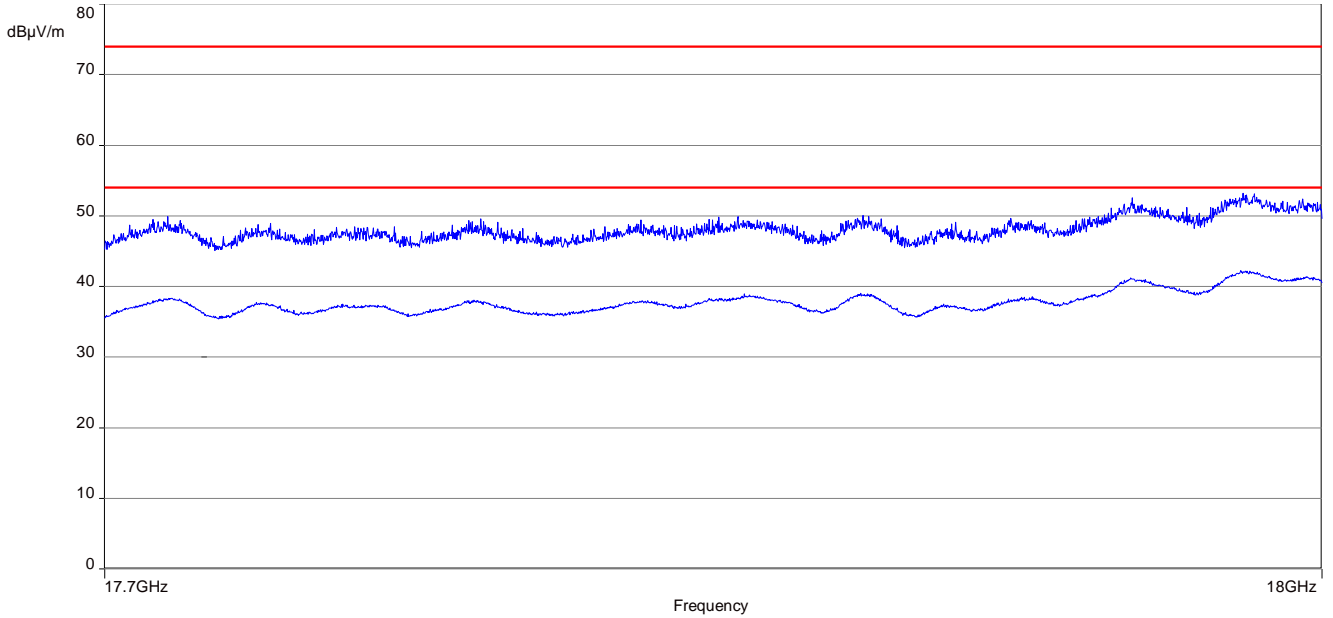

Plot 6: 18 GHz – 26 GHz, antenna horizontal/vertical, channel low, lower band

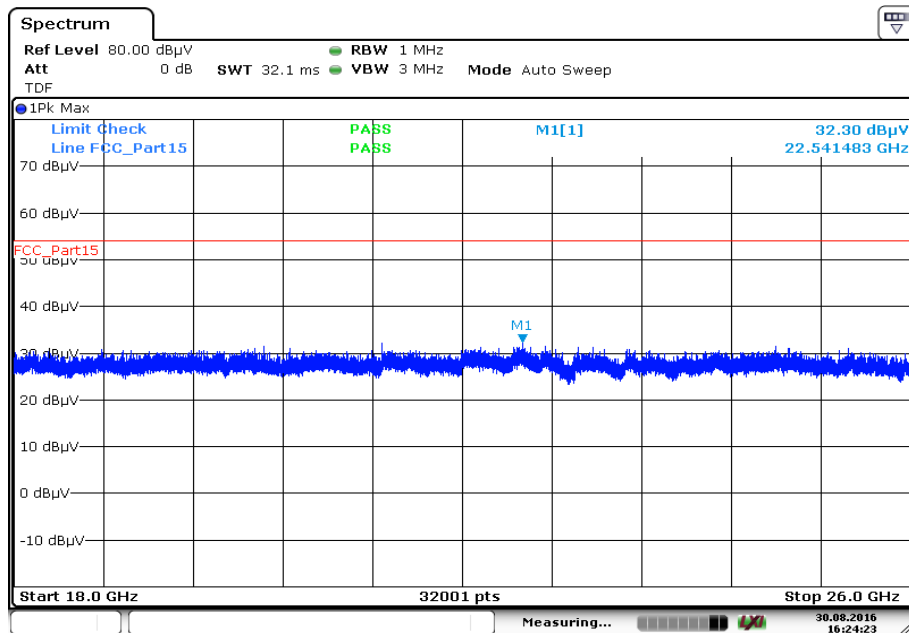

Plot 7: 9 kHz – 30 MHz, channel mid, lower band

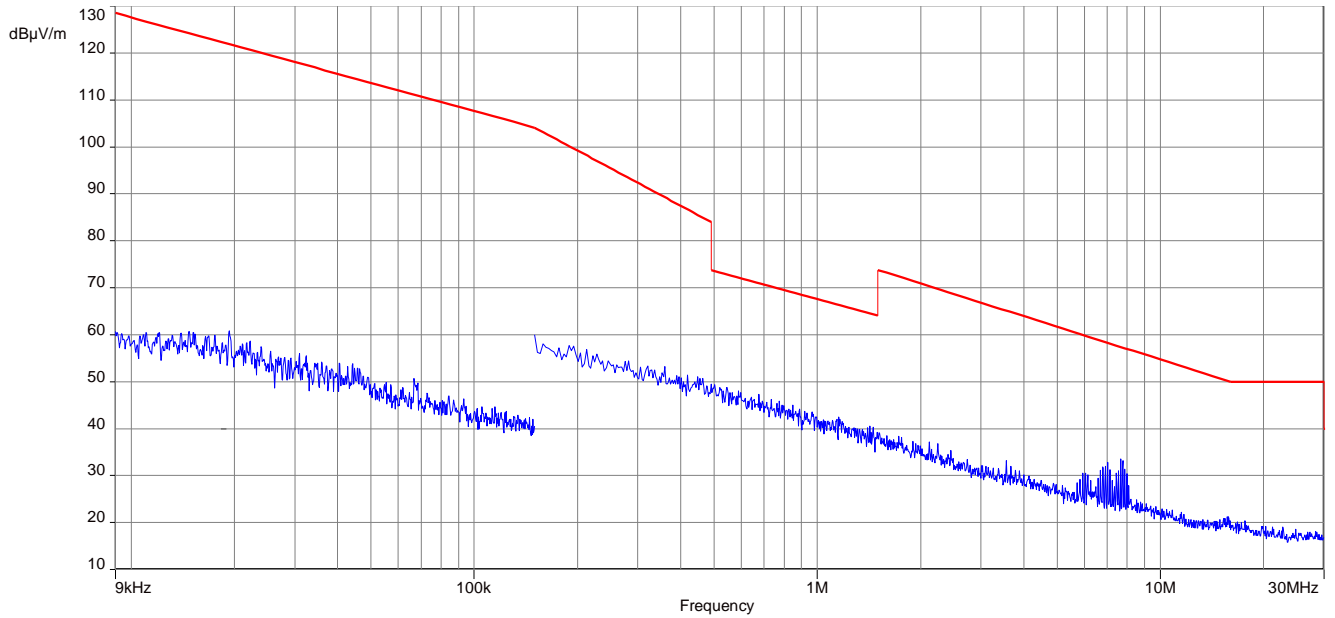

Plot 8: 30 MHz – 1 GHz, channel mid, lower band

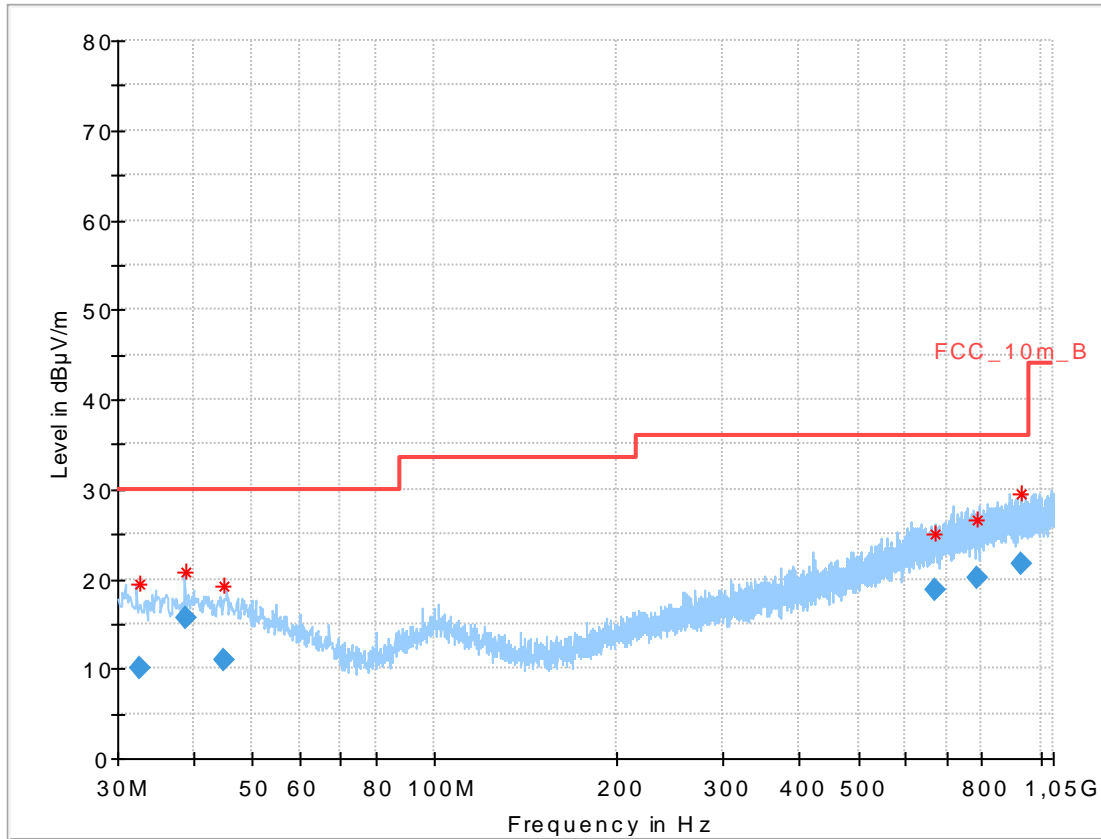

Final_Result:

Frequency (MHz)	QuasiPeak (dBµV/m)	Limit (dBµV/m)	Margin (dB)	Meas. Time (ms)	Bandwidth (kHz)	Height (cm)	Pol	Azimuth (deg)	Corr. (dB)
32.734800	10.14	30.00	19.86	1000.0	120.000	101.0	H	171.0	13.6
38.720700	15.54	30.00	14.46	1000.0	120.000	101.0	V	190.0	14.0
44.976900	10.90	30.00	19.10	1000.0	120.000	101.0	V	261.0	13.9
668.011350	18.70	36.00	17.30	1000.0	120.000	170.0	V	80.0	21.3
785.701500	20.09	36.00	15.91	1000.0	120.000	170.0	V	80.0	22.7
930.739500	21.58	36.00	14.42	1000.0	120.000	170.0	V	-9.0	24.2

Plot 9: 1 GHz – 3.5 GHz, antenna horizontal/vertical, channel mid, lower band

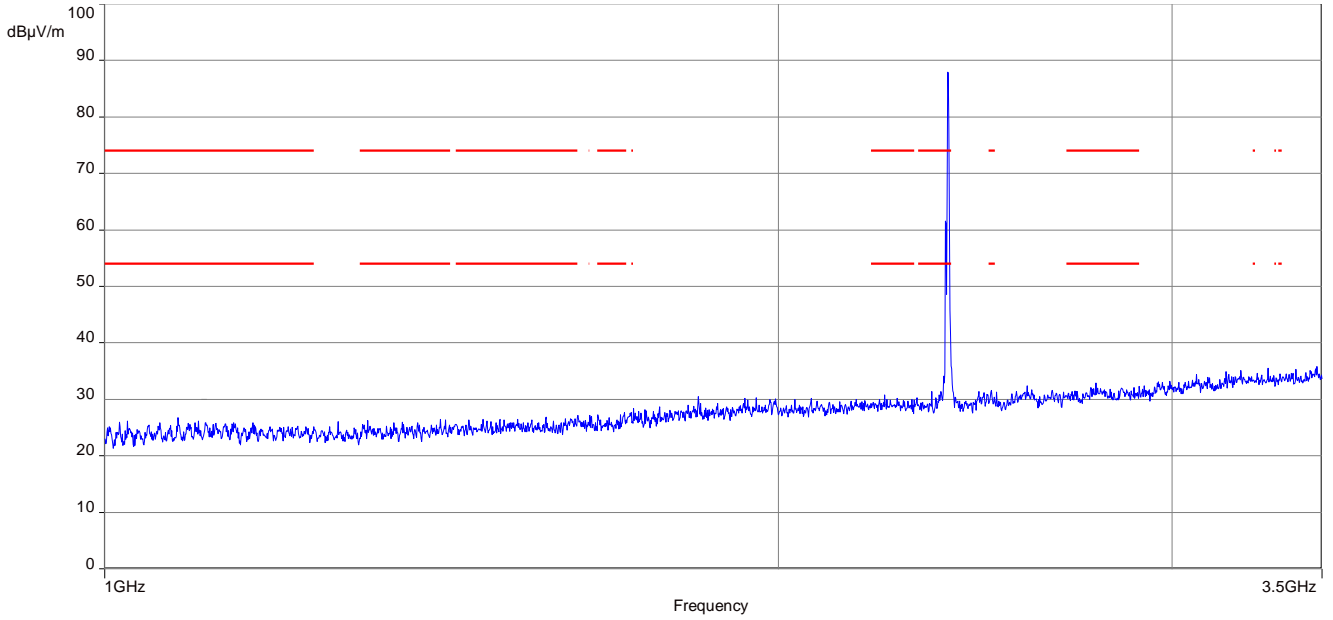

Plot 10: 2392.5 GHz – 18 GHz, antenna horizontal/vertical, channel mid, lower band

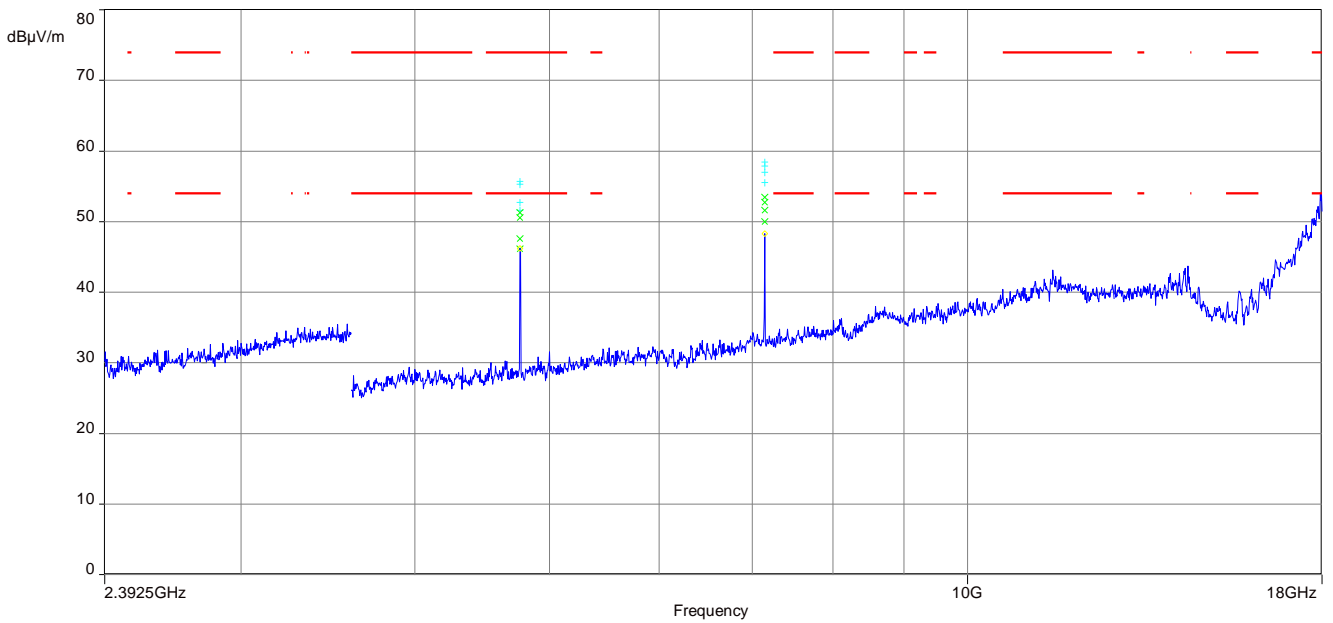

Plot 11: 17.7 GHz – 18 GHz, antenna horizontal/vertical, channel mid, lower band

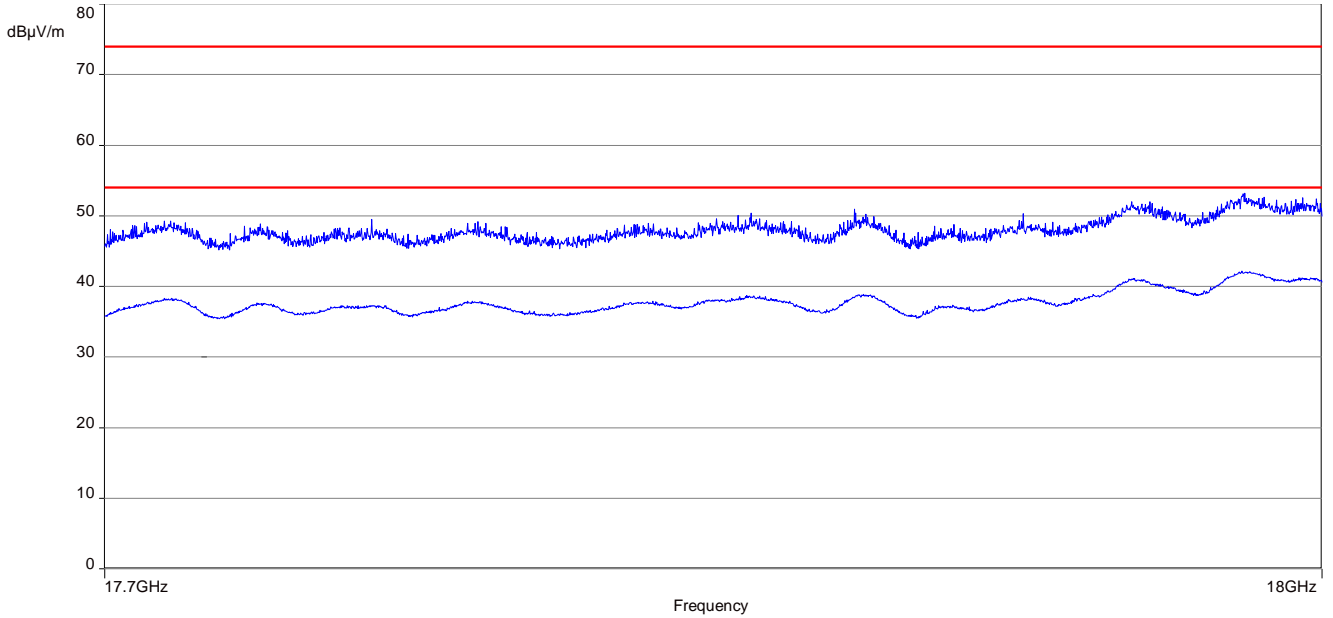

Plot 12: 18 GHz – 26 GHz, antenna horizontal/vertical, channel mid, lower band

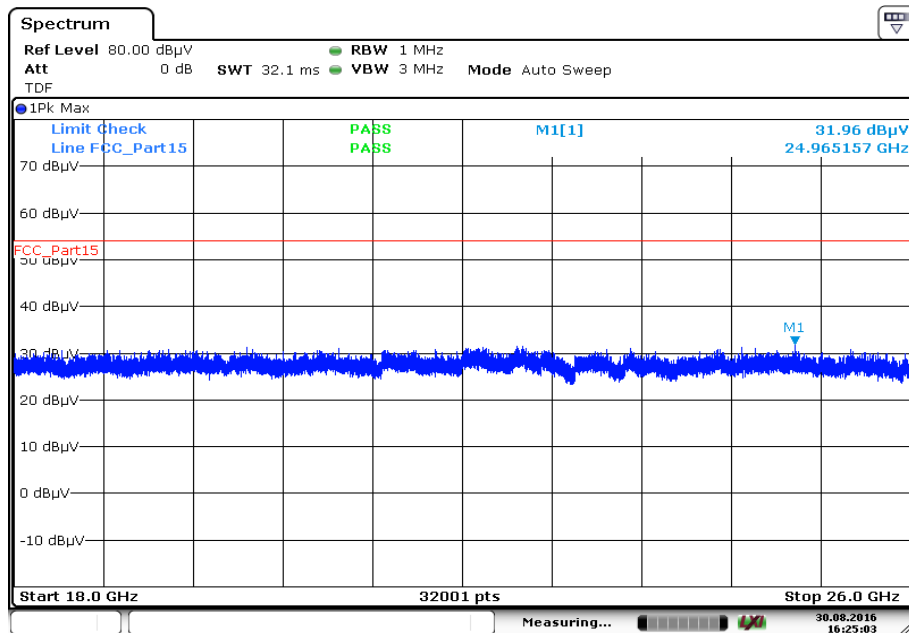

Plot 13: 9 kHz – 30 MHz, channel high, lower band

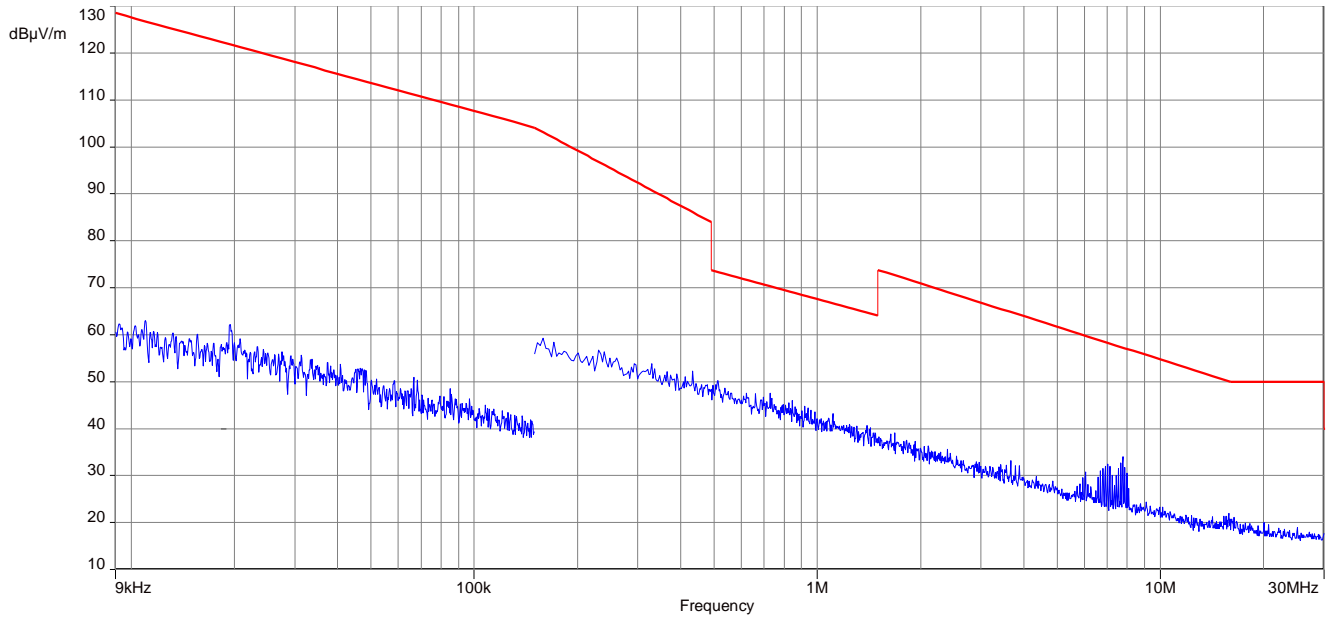

Plot 14: 30 MHz – 1 GHz, channel high, lower band

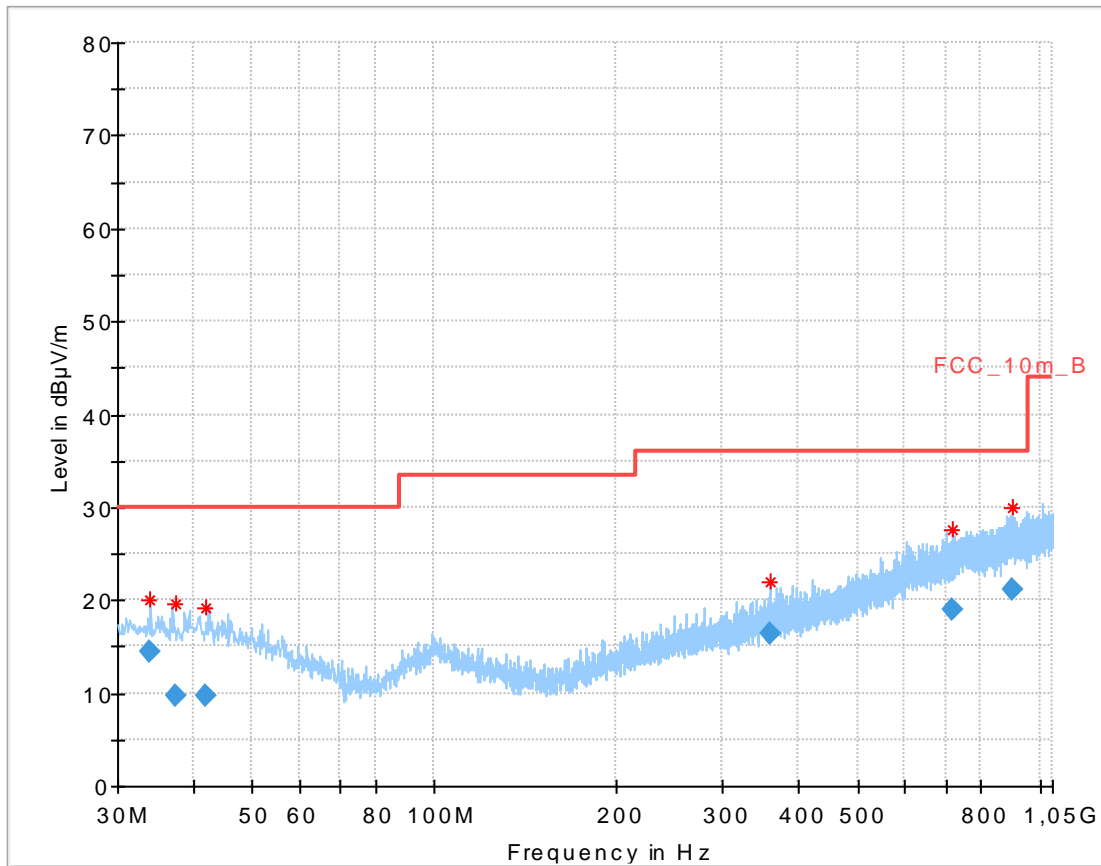

Final_Result:

Frequency (MHz)	QuasiPeak (dBµV/m)	Limit (dBµV/m)	Margin (dB)	Meas. Time (ms)	Bandwidth (kHz)	Height (cm)	PoI	Azimuth (deg)	Corr. (dB)
34.008450	14.39	30.00	15.61	1000.0	120.000	170.0	V	280.0	13.7
37.282350	9.61	30.00	20.39	1000.0	120.000	170.0	H	-10.0	13.9
41.917500	9.77	30.00	20.23	1000.0	120.000	170.0	H	100.0	14.0
359.461500	16.34	36.00	19.66	1000.0	120.000	98.0	V	280.0	16.2
716.883300	18.95	36.00	17.05	1000.0	120.000	100.0	V	171.0	21.9
903.408900	21.03	36.00	14.97	1000.0	120.000	170.0	H	190.0	24.1

Plot 15: 1 GHz – 3.5 GHz, antenna horizontal/vertical, channel high, lower band

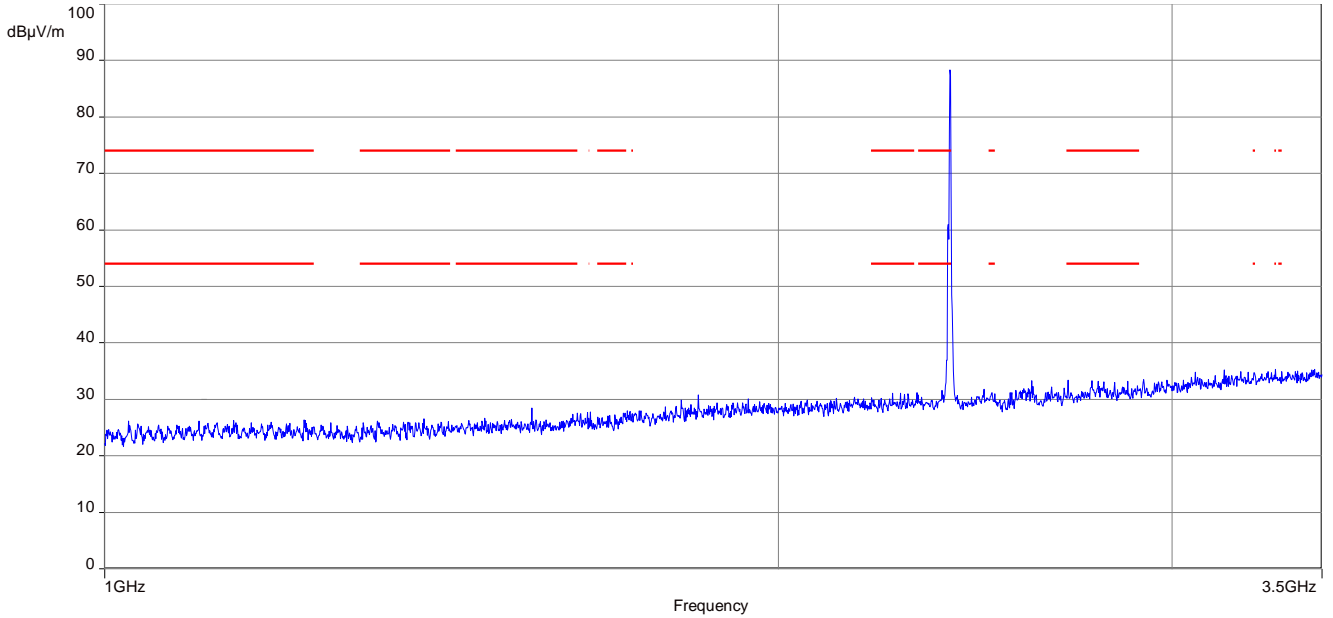

Plot 16: 2392.5 GHz – 18 GHz, antenna horizontal/vertical, channel high, lower band

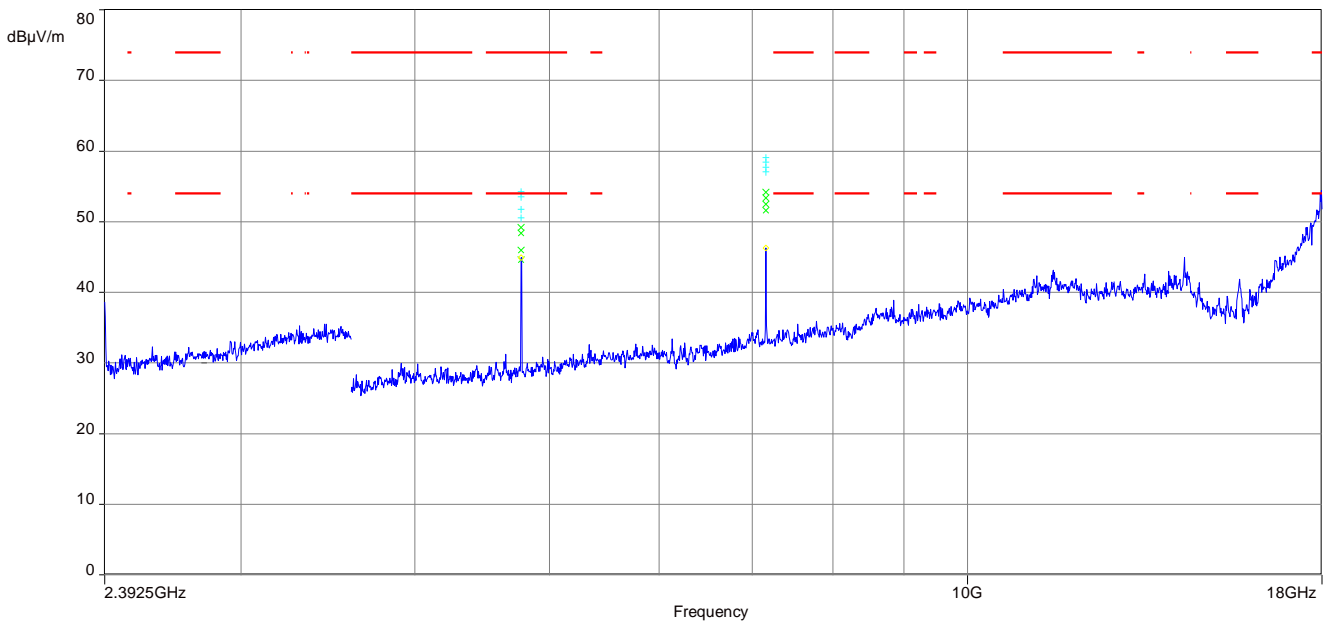

Plot 17: 17.7 GHz – 18 GHz, antenna horizontal/vertical, channel high, lower band

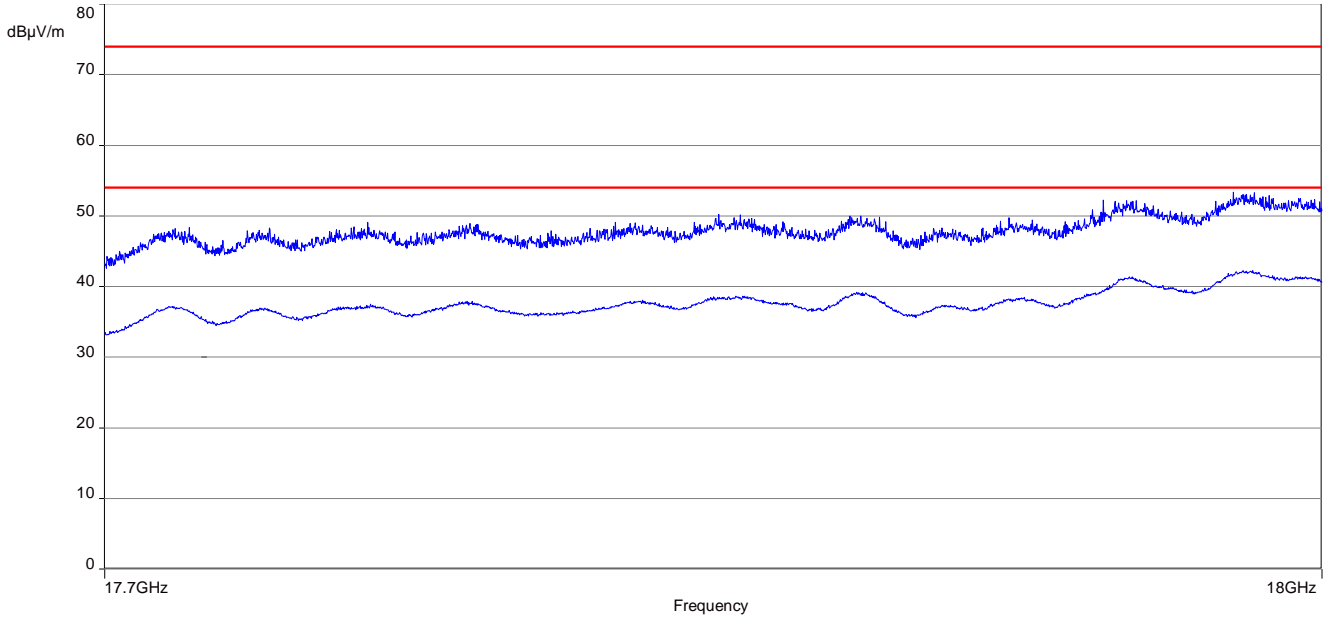

Plot 18: 18 GHz – 26 GHz, antenna horizontal/vertical, channel high, lower band

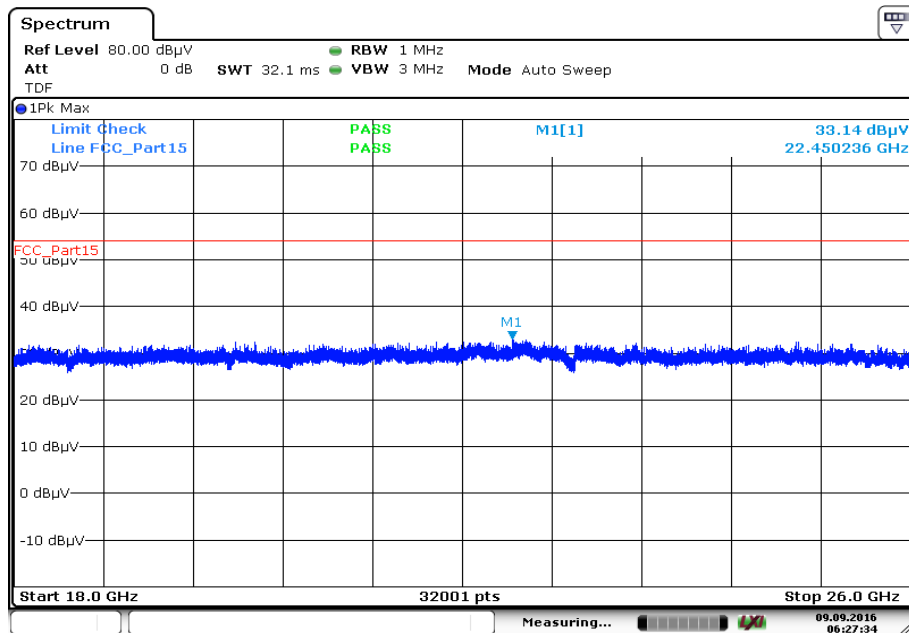

Date: 9. SEP. 2016 06:27:34

Plot 19: 9 kHz – 30 MHz, channel low, upper band

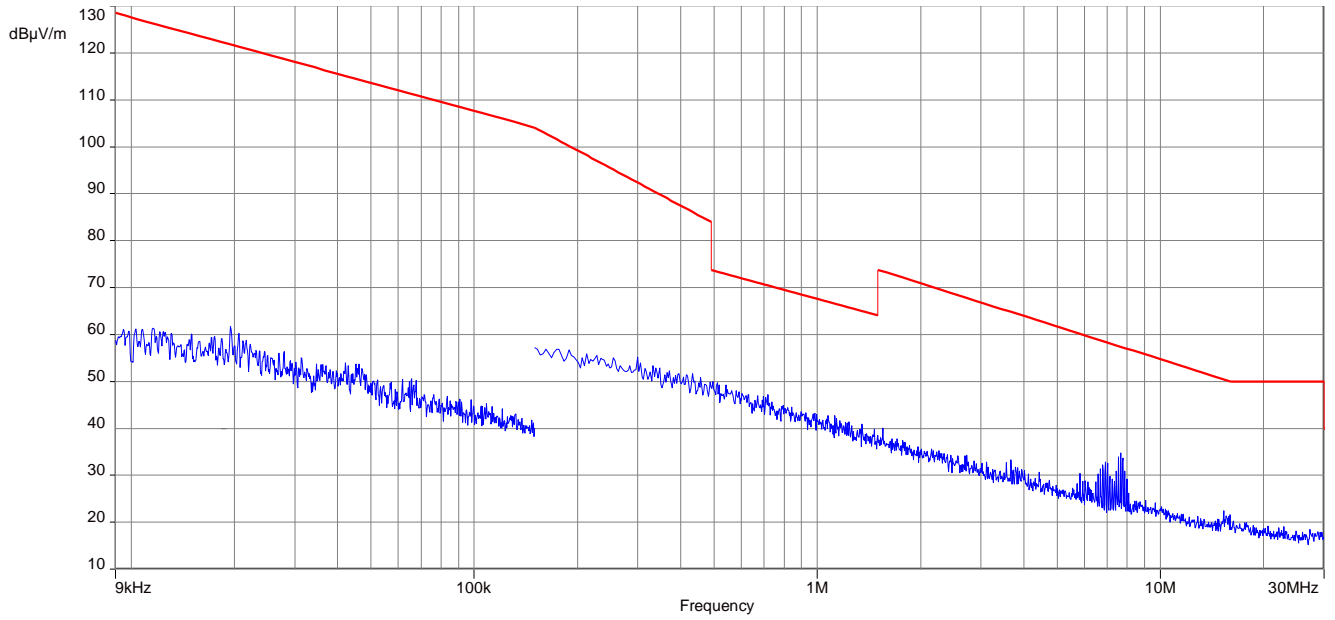

Plot 20: 30 MHz – 1 GHz, channel low, upper band

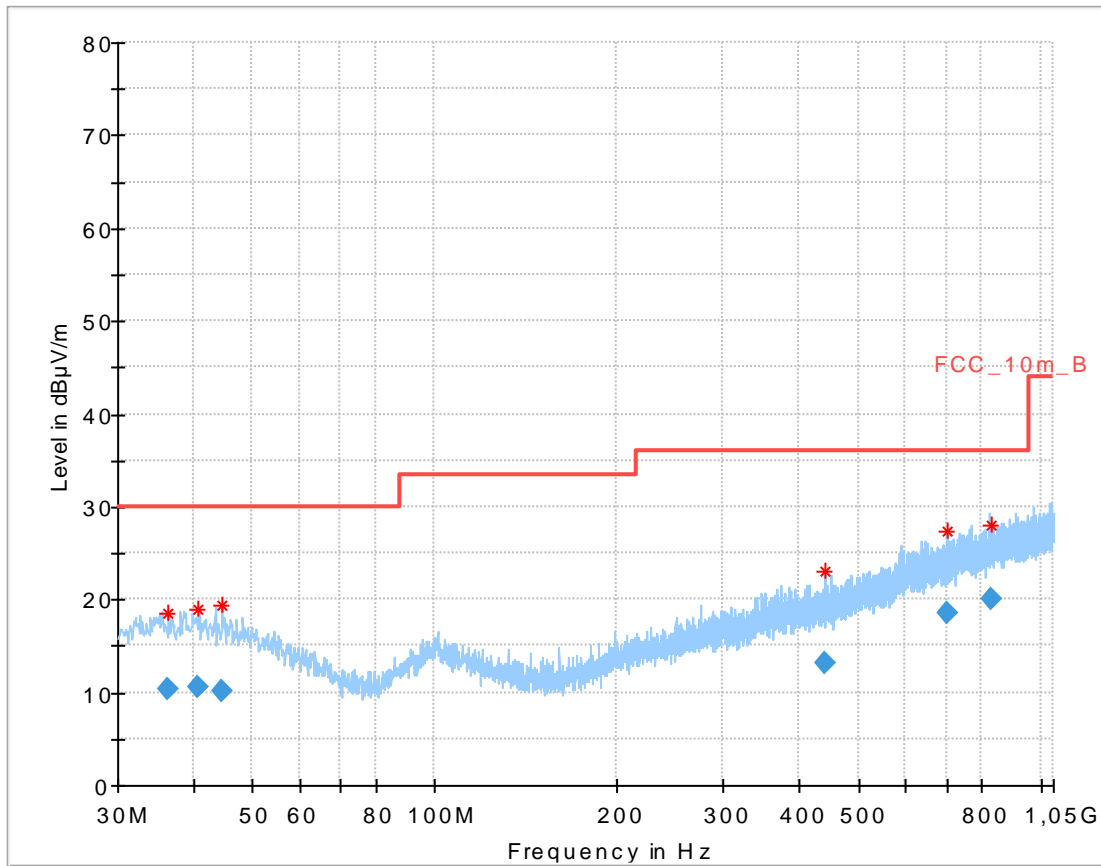

Final_Result:

Frequency (MHz)	QuasiPeak (dBµV/m)	Limit (dBµV/m)	Margin (dB)	Meas. Time (ms)	Bandwidth (kHz)	Height (cm)	Pol	Azimuth (deg)	Corr. (dB)
36.248550	10.43	30.00	19.57	1000.0	120.000	101.0	V	190.0	13.9
40.675950	10.58	30.00	19.42	1000.0	120.000	170.0	V	280.0	14.0
44.460000	10.03	30.00	19.97	1000.0	120.000	170.0	V	-9.0	13.9
439.654950	13.14	36.00	22.86	1000.0	120.000	101.0	V	190.0	17.5
702.212250	18.63	36.00	17.37	1000.0	120.000	170.0	H	260.0	21.6
829.345050	20.12	36.00	15.88	1000.0	120.000	98.0	H	80.0	23.2

Plot 21: 1 GHz – 3.5 GHz, antenna horizontal/vertical, channel low, upper band

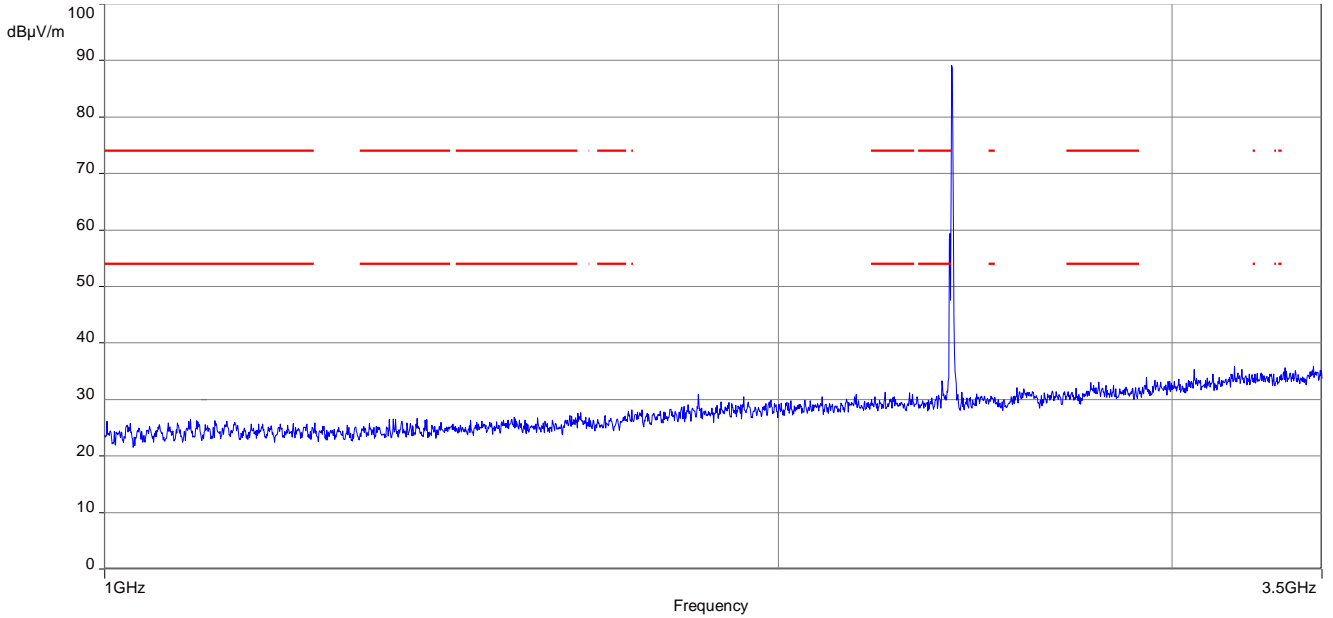

Plot 22: 2392.5 GHz – 18 GHz, antenna horizontal/vertical, channel low, upper band

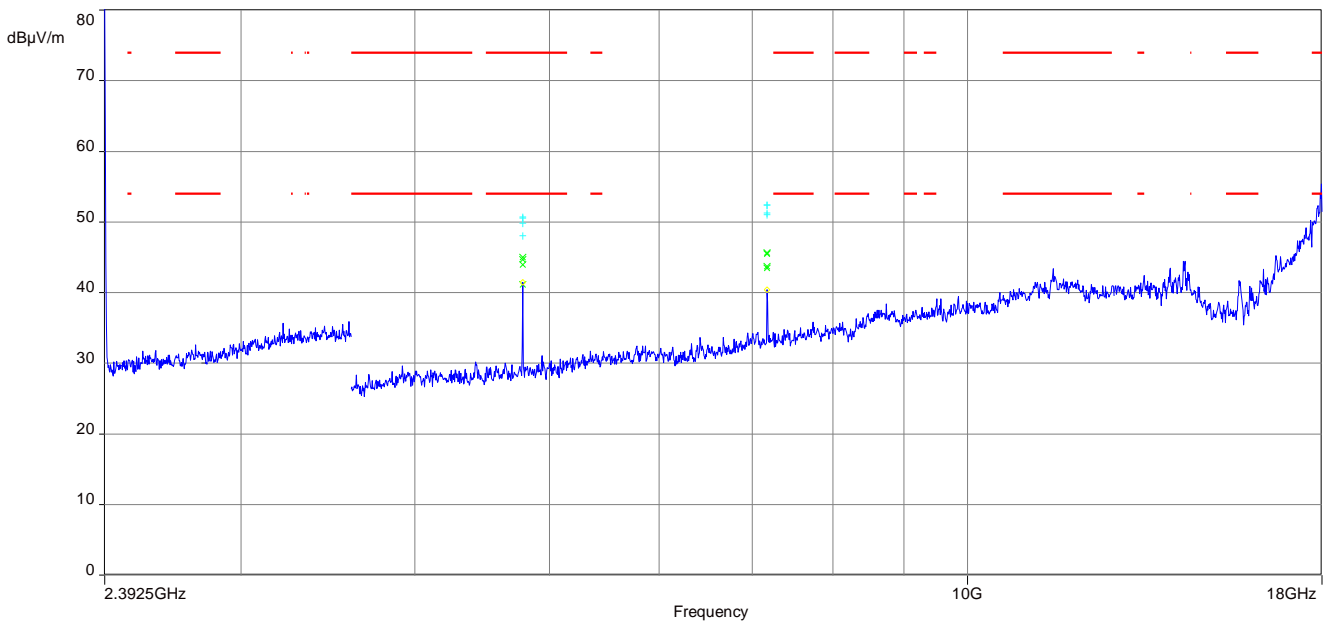

Plot 23: 17.7 GHz – 18 GHz, antenna horizontal/vertical, channel low, upper band

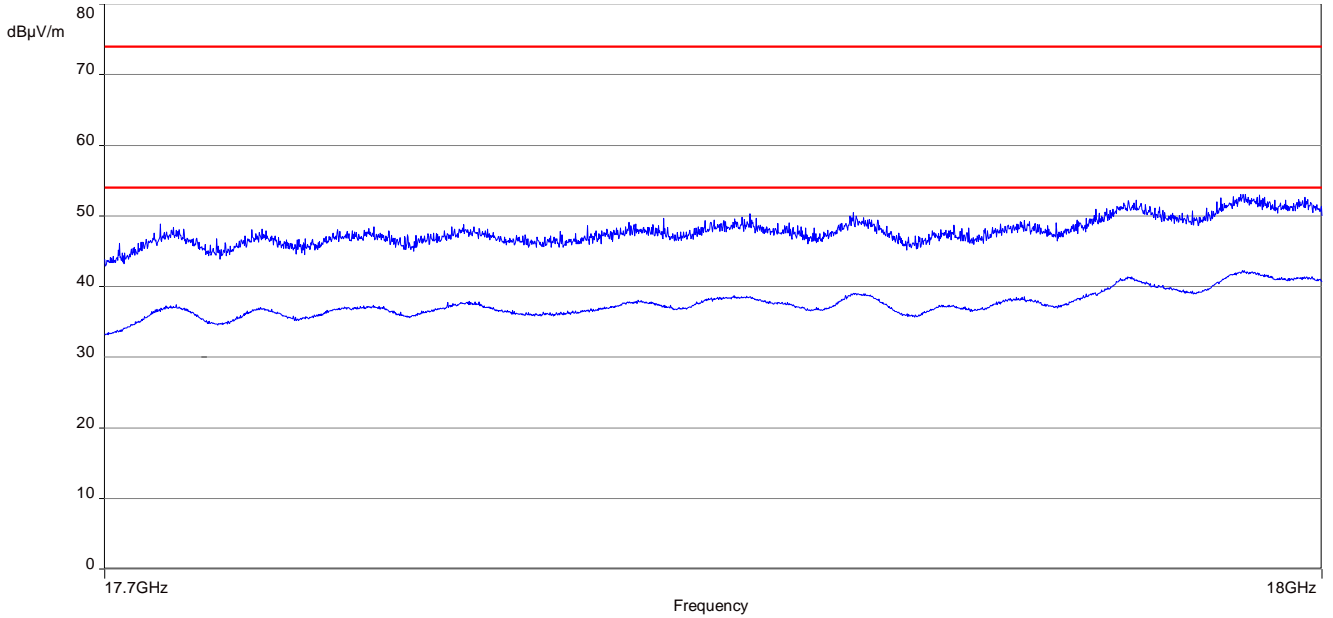

Plot 24: 18 GHz – 26 GHz, antenna horizontal/vertical, channel low, upper band

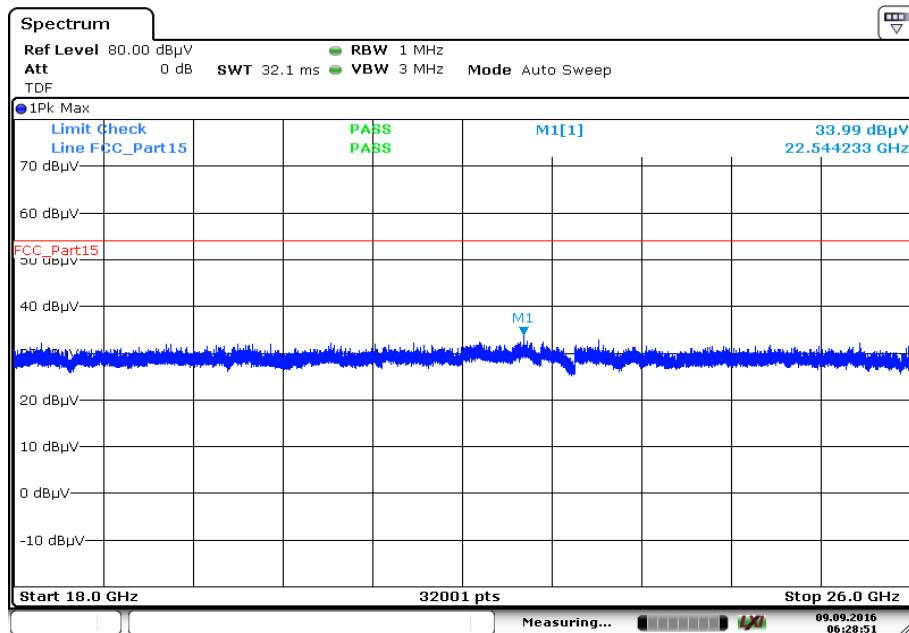

Date: 9.SEP.2016 06:28:51

Plot 25: 9 kHz – 30 MHz, channel high, upper band

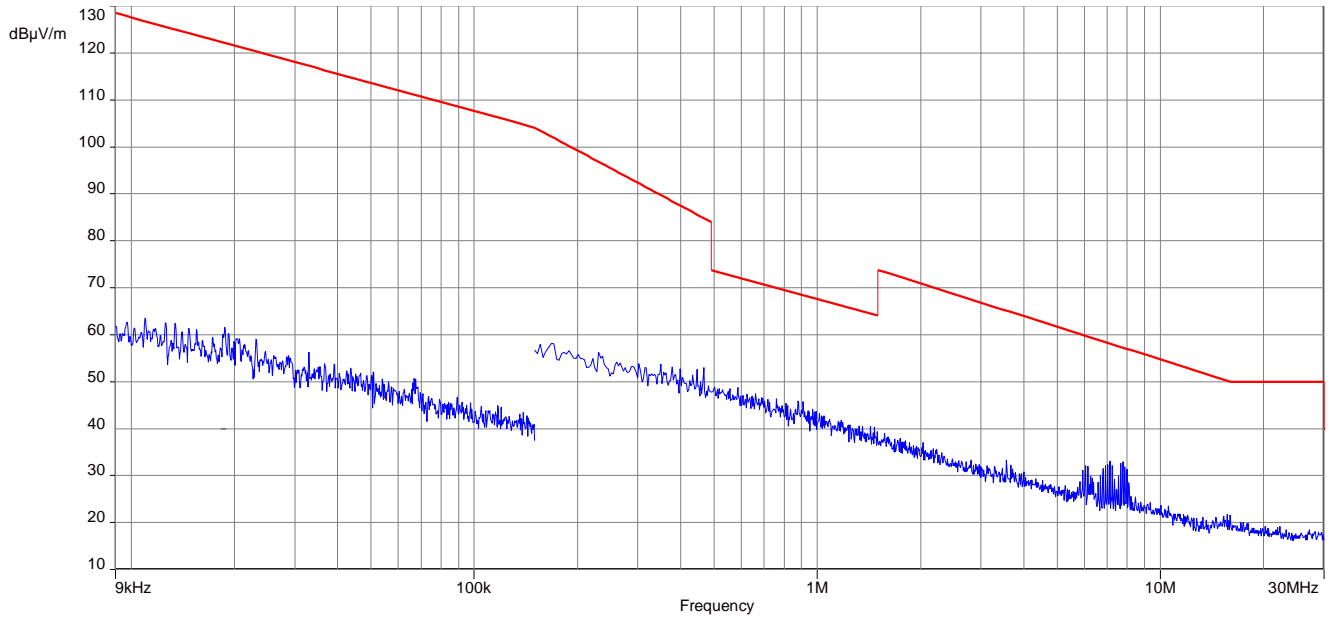

Plot 26: 30 MHz – 1 GHz, channel high, upper band

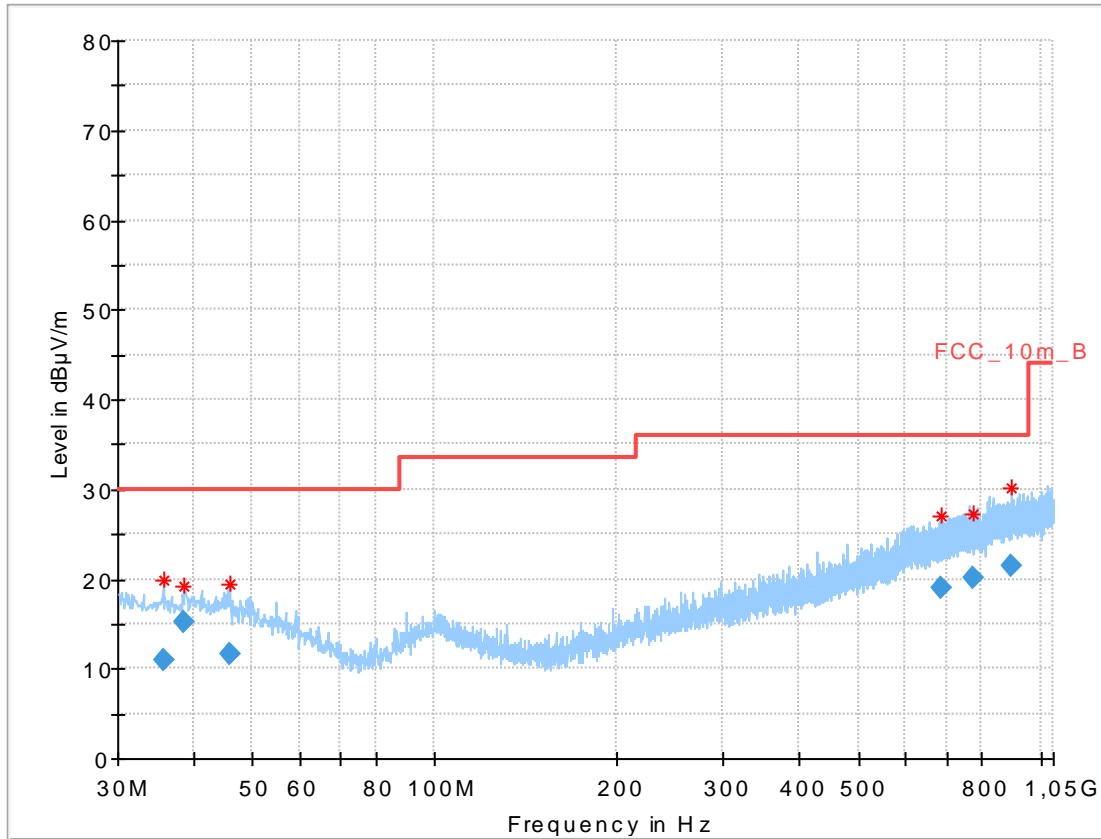

Final_Result:

Frequency (MHz)	QuasiPeak (dBµV/m)	Limit (dBµV/m)	Margin (dB)	Meas. Time (ms)	Bandwidth (kHz)	Height (cm)	Pol	Azimuth (deg)	Corr. (dB)
35.701950	11.03	30.00	18.97	1000.0	120.000	101.0	H	261.0	13.8
38.707800	15.14	30.00	14.86	1000.0	120.000	101.0	V	280.0	14.0
46.078200	11.63	30.00	18.37	1000.0	120.000	100.0	V	280.0	13.6
685.283100	18.96	36.00	17.04	1000.0	120.000	170.0	H	170.0	21.4
772.858350	20.05	36.00	15.95	1000.0	120.000	170.0	V	81.0	22.7
891.731850	21.48	36.00	14.52	1000.0	120.000	101.0	V	81.0	24.0

Plot 27: 1 GHz – 3.5 GHz, antenna horizontal/vertical, channel high, upper band

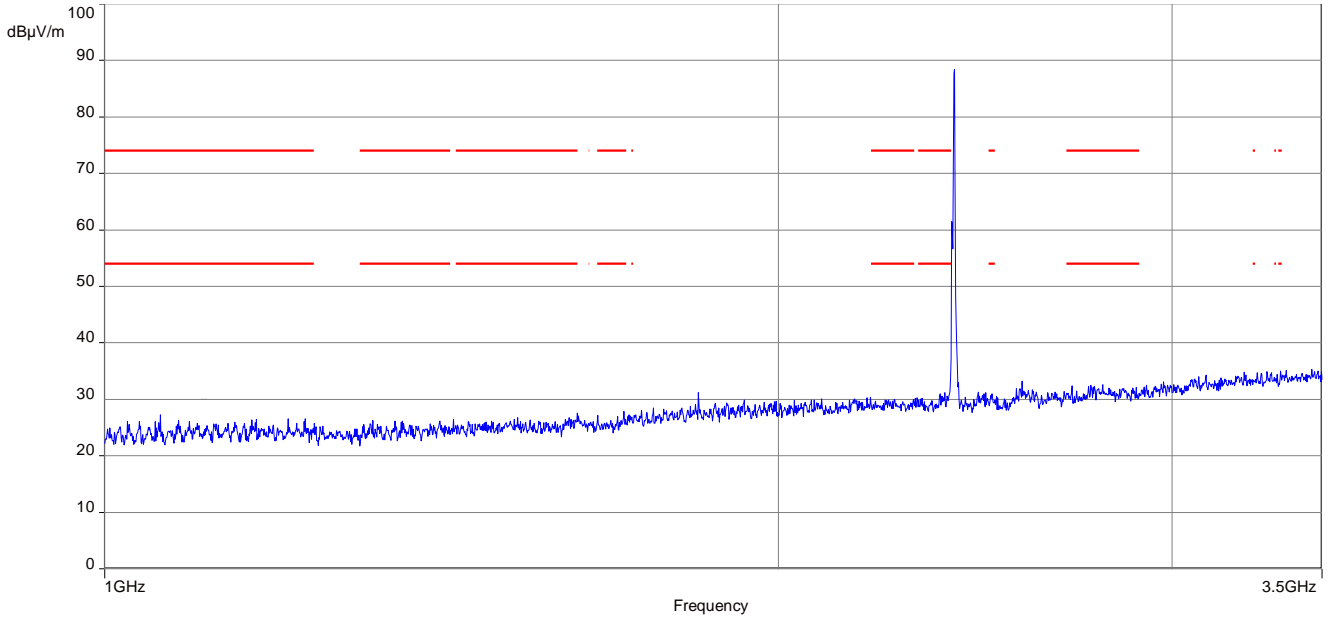

Plot 28: 2392.5 GHz – 18 GHz, antenna horizontal/vertical, channel high, upper band

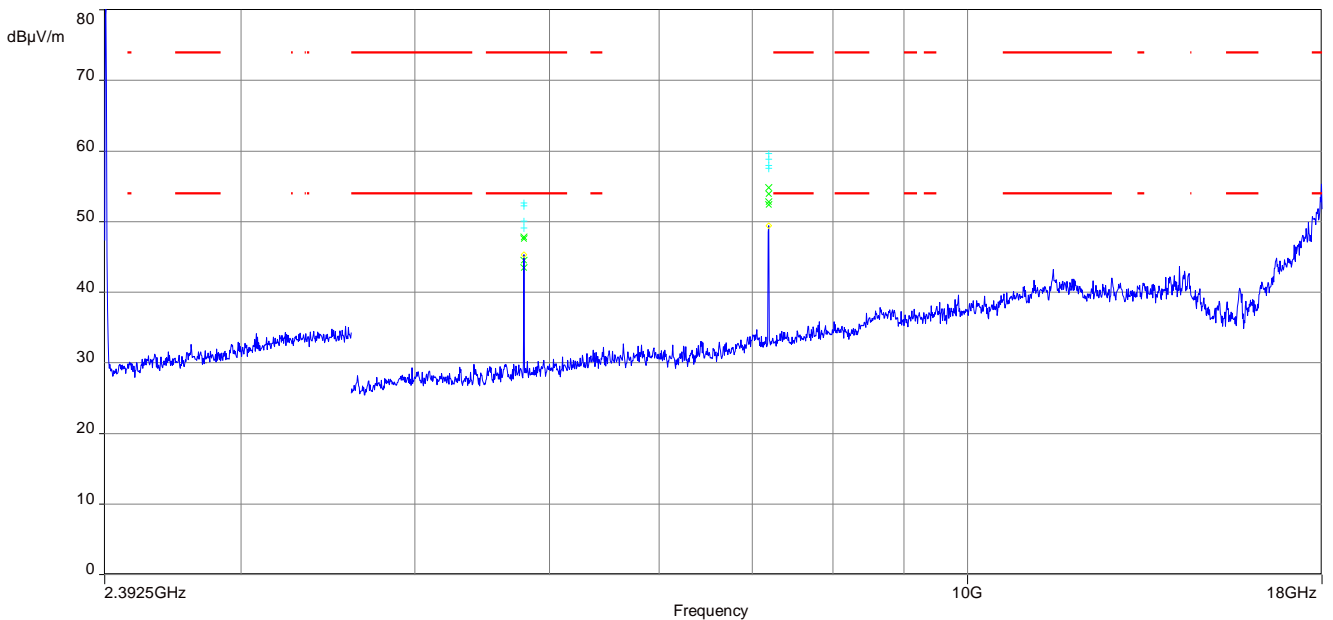

Plot 29: 17.7 GHz – 18 GHz, antenna horizontal/vertical, channel high, upper band

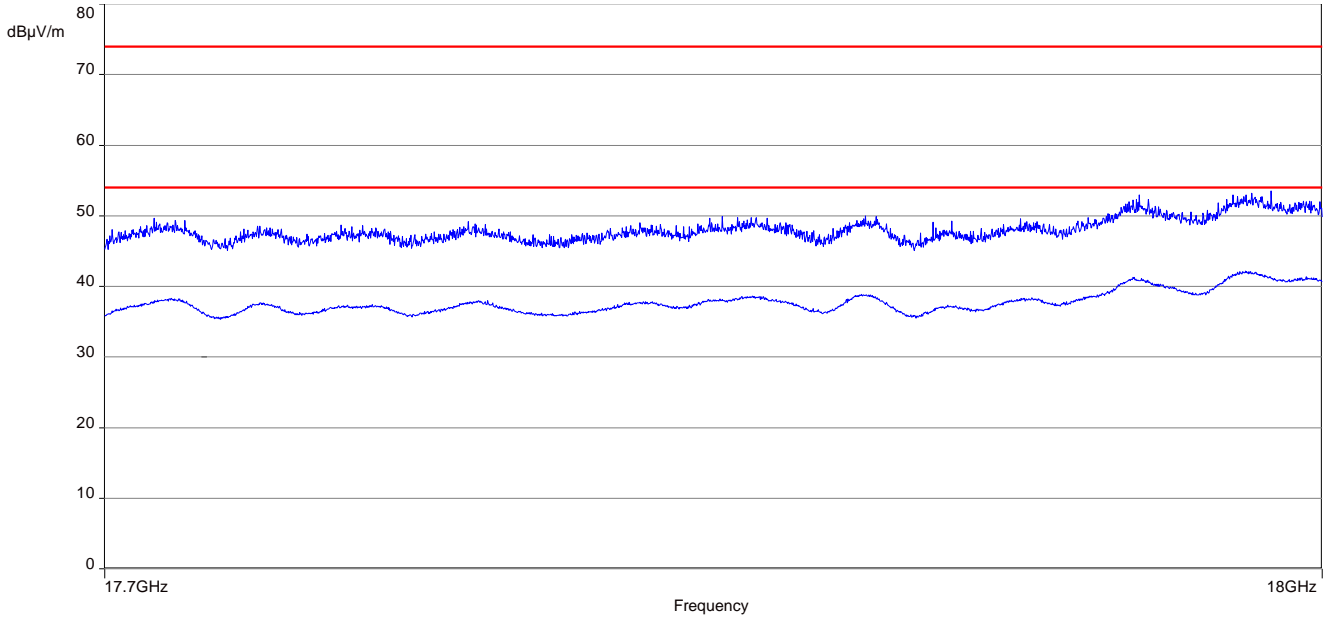

Plot 30: 18 GHz – 26 GHz, antenna horizontal/vertical, channel high, upper band

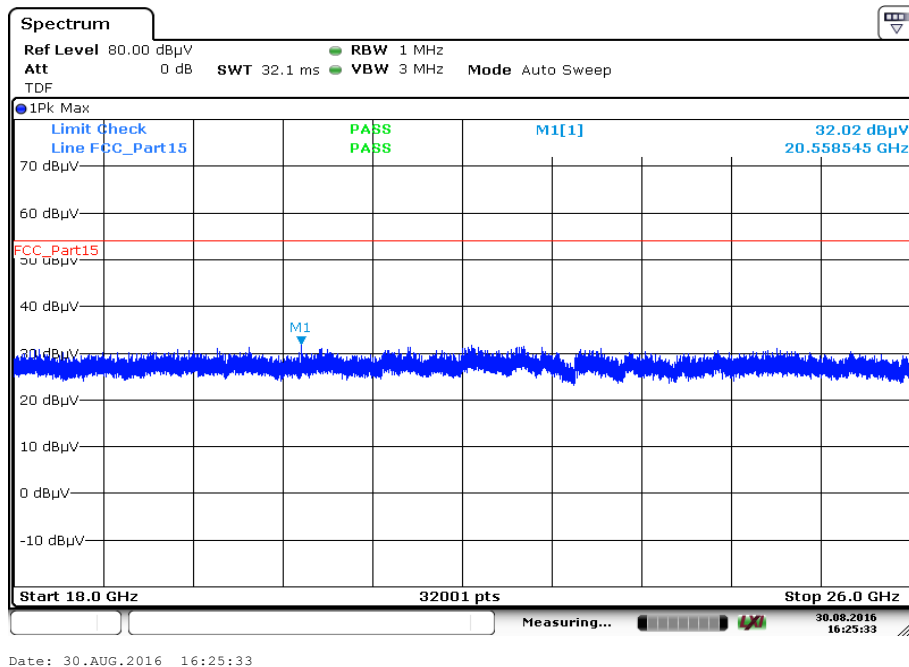

12.6 Receiver unwanted radiation (radiated)

Measurement:

Measurements were made in accordance with the procedure detailed in KDB 550499 section D2.

Measurement parameter		
Detector:	Prescan: Final:	Peak QPK below 960 MHz RMS above 960 MHz
Video bandwidth:	9 kHz – 150 kHz: 150 kHz – 30 MHz: 30 MHz – 1 GHz: 1 GHz – 26 GHz:	1 kHz 30 kHz 300 kHz 3 MHz
Resolution bandwidth:	9 kHz – 150 kHz: 150 kHz – 30 MHz: 30 MHz – 1 GHz: 1 GHz – 26 GHz:	200 Hz 9 kHz 100 kHz 1 MHz
Span:	See plots	
Trace mode:	Max Hold	
Test setup:	See sub clause 7.1 – A & 7.2 – A & 7.3 – A	
Measurement uncertainty:	See sub clause 9	

Limits:

FCC		IC
47 CFR § 15.109		-/-
Receiver unwanted radiation (radiated)		
Frequency (MHz)	Field strength ($\mu\text{V}/\text{m}$) ¹	Measurement distance (m)
30 - 88	100 (40 dB $\mu\text{V}/\text{m}$)	3
30 - 88	31.6 (30 dB $\mu\text{V}/\text{m}$)	10
88 - 216	150 (43.5 dB $\mu\text{V}/\text{m}$)	3
88 - 216	47.3 (33.5 dB $\mu\text{V}/\text{m}$)	10
216 - 960	200 (46 dB $\mu\text{V}/\text{m}$)	3
216 - 960	63.1 (36 dB $\mu\text{V}/\text{m}$)	10
above 960	500 (54 dB $\mu\text{V}/\text{m}$)	3

¹ Measurements in the 9 to 90 kHz, 110 to 490 kHz and above 1000 MHz ranges employ an average detector. Otherwise a quasi-peak detector is used.

According to the FCC requirement:

The radiated measurements were performed without a human body phantom or an equivalent testing setup (photo documentation – see external annex D).



Results: Receiver mode

Receiver unwanted radiation [dB μ V/m]		
F [MHz]	Detector	Level [dB μ V/m]
For emissions below 1 GHz, please look at the table below the 1 GHz plot.		
1447	Peak	17.8
	QPK	-/-
4960	Peak	40.4
	QPK	-/-
6608	Peak	32.5
	QPK	-/-
11160	Peak	39.7
	AVG	-/-
11571	Peak	40.9
	AVG	-/-
13960	Peak	41.8
	AVG	-/-
For emissions above 1 GHz, please look at the plots.		

Plot:

Plot 1: 30 MHz – 1 GHz

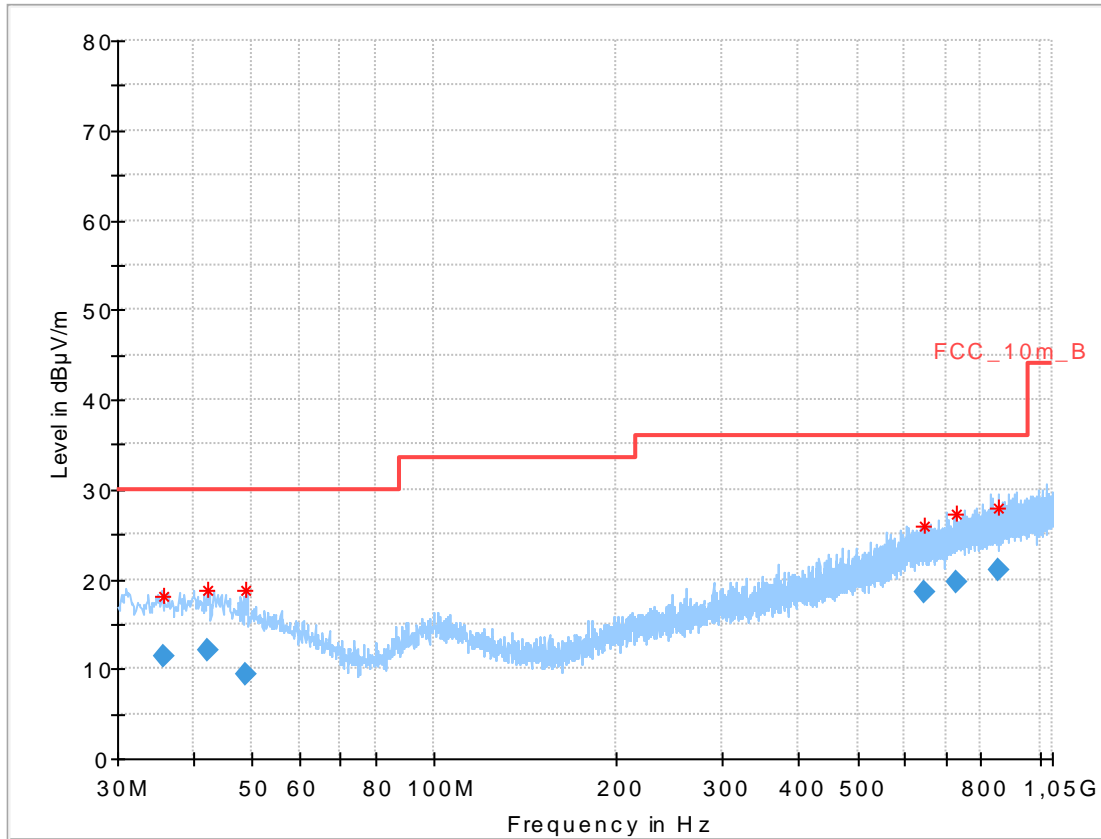

Final_Result:

Frequency (MHz)	QuasiPeak (dBµV/m)	Limit (dBµV/m)	Margin (dB)	Meas. Time (ms)	Bandwidth (kHz)	Height (cm)	Pol	Azimuth (deg)	Corr. (dB)
35.809500	11.43	30.00	18.57	1000.0	120.000	98.0	V	260.0	13.8
42.381450	12.10	30.00	17.90	1000.0	120.000	101.0	V	170.0	14.0
48.894000	9.35	30.00	20.65	1000.0	120.000	101.0	V	-9.0	12.9
644.932050	18.51	36.00	17.49	1000.0	120.000	101.0	H	280.0	21.1
729.390900	19.77	36.00	16.23	1000.0	120.000	98.0	H	280.0	22.2
853.422900	21.01	36.00	14.99	1000.0	120.000	101.0	H	261.0	23.5

Plot 2: 1 GHz – 18 GHz, antenna horizontal/vertical

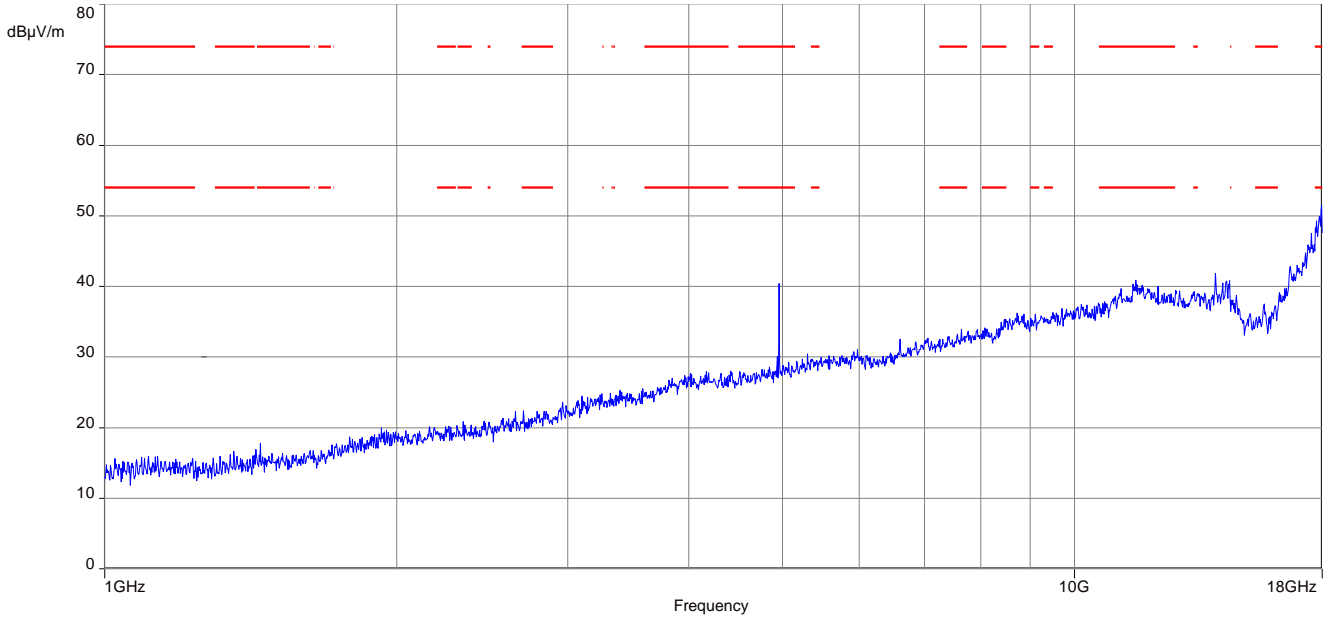

Plot 3: 17.7 GHz – 18 GHz, antenna horizontal/vertical

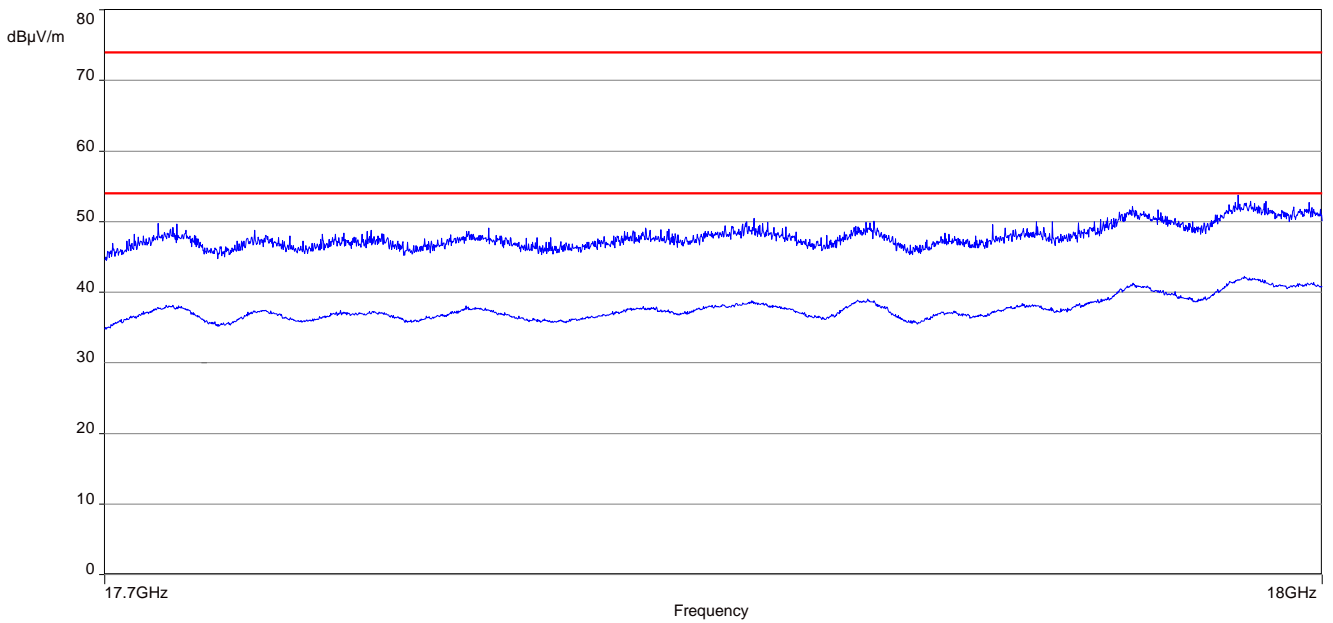

Plot 4: 18 GHz – 26 GHz, antenna horizontal/vertical

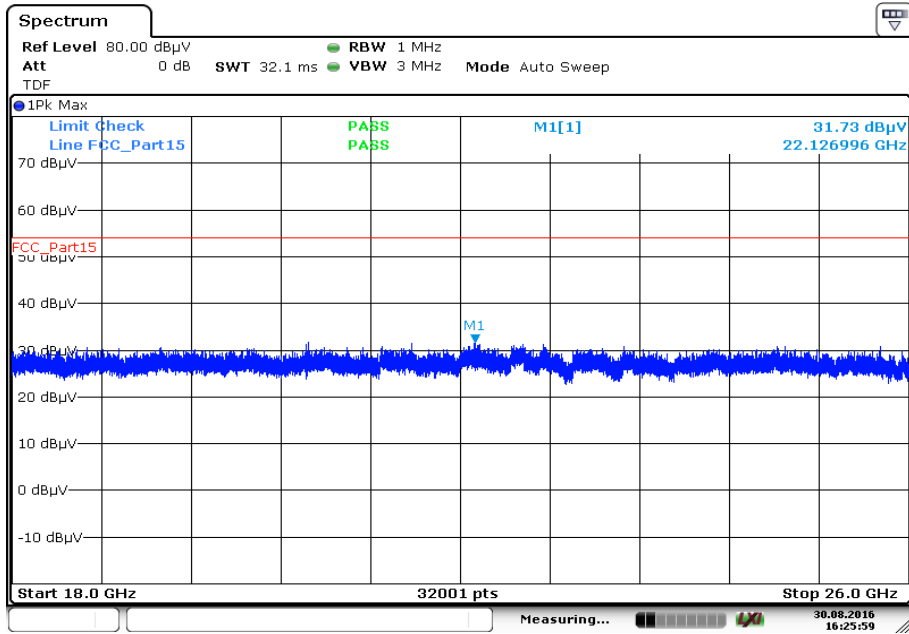

Date: 30.AUG.2016 16:25:58

12.7 Connection interrupt test (body-worn sensor)

Measurement:

- (a) Establish a LAN connection between the MBAN P/C device and the simulated control point.
- (b) Establish connection between the MBAN P/C and the body-worn sensor device under test (DUT).
- (c) Configure the control message to enable operation in the 2360–2390 MHz band.
- (d) Verify that transmissions between DUT and its associated MBAN P/C are consistent with the control message configuration.
- (e) Interrupt the RF and verify that the DUT ceases transmission in the 2360–2390 MHz band with a latency period not exceeding the maximum control message periodicity as specified in the operational description of the device. Additionally, if the DUT operating frequency is now moved to 2390–2400 MHz band verify the channel transition time (latency) is less than the maximum control message periodicity as specified in the operational description of the device.

Measurement parameter	
Detector:	Peak
Resolution bandwidth:	1 MHz
Video bandwidth:	3 MHz
Span:	See plots (both MBAN bands)
Trace mode:	Max Hold
Test setup:	See sub clause 7.5 – A

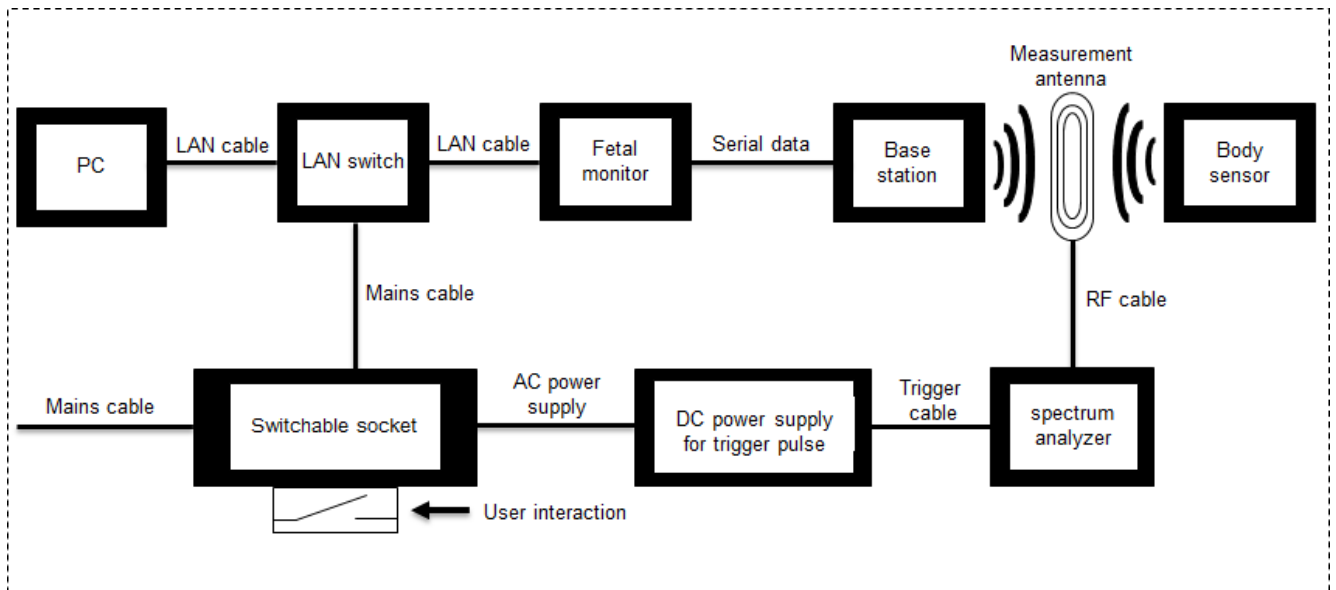
Test setup:**Test description (KDB 550599 D01 v01):**

1. Switchable socket with manual interaction to switch off the DC power supply and the LAN switch
2. DC power supply for a low ramp trigger pulse to trigger the spectrum analyzer
3. LAN switch to release the connection between PC (Server) and monitor (Main station)
4. Monitor, base station and body sensor – complete test setup in normal use constellation
5. Measurement antenna and spectrum analyzer to perform the test

Test execution:

1. Establishing a normal system connection
2. Manual interaction to switch off the DC power supply and the LAN switch
3. Spectrum analyzer – start of the measurement and connection lost between PC and monitor
4. Monitor deactivate the base station RF connection
5. Base station deactivate the body sensor
6. End of test

Step 1 (KDB 550599 D01 v01):

- (a) Establish a LAN connection between the MBAN P/C device and the simulated control point.
- (b) Establish connection between the MBAN P/C and the body-worn sensor device under test (DUT).

Plot 1:

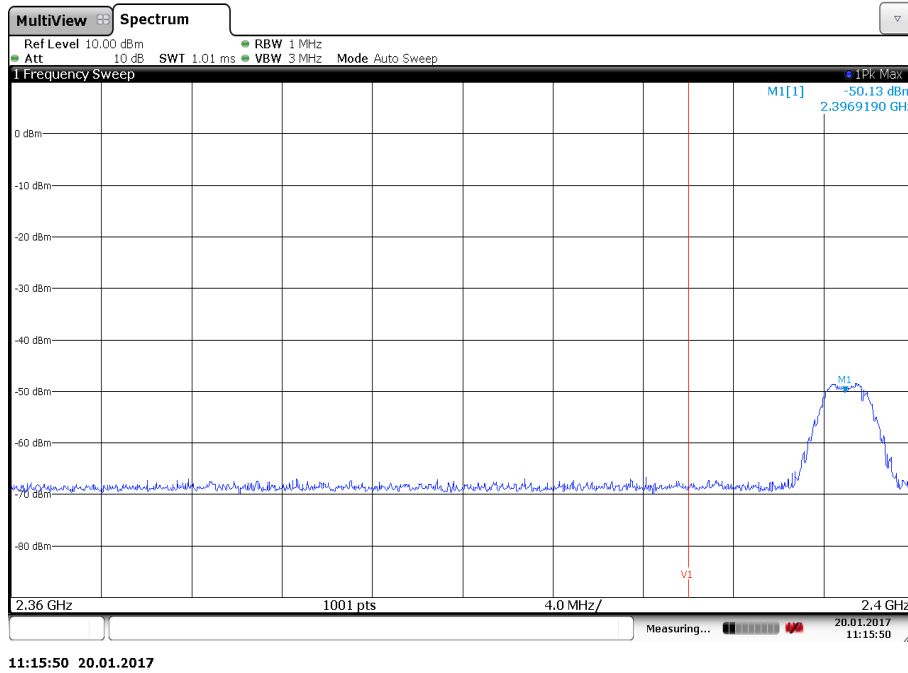

The plot shows the communication of the control message between the MBAN P/C and the body-worn sensor in the 2390-2400 MHz band (Marker 1 @ 2397 MHz). The V1 frequency line marks the end of lower and the start of the upper MBAN band.

Step 2 (KDB 550599 D01 v01):

- (c) Configure the control message to enable operation in the 2360–2390 MHz band.
- (d) Verify that transmissions between DUT and its associated MBAN P/C are consistent with the control message configuration.

Plot 2:

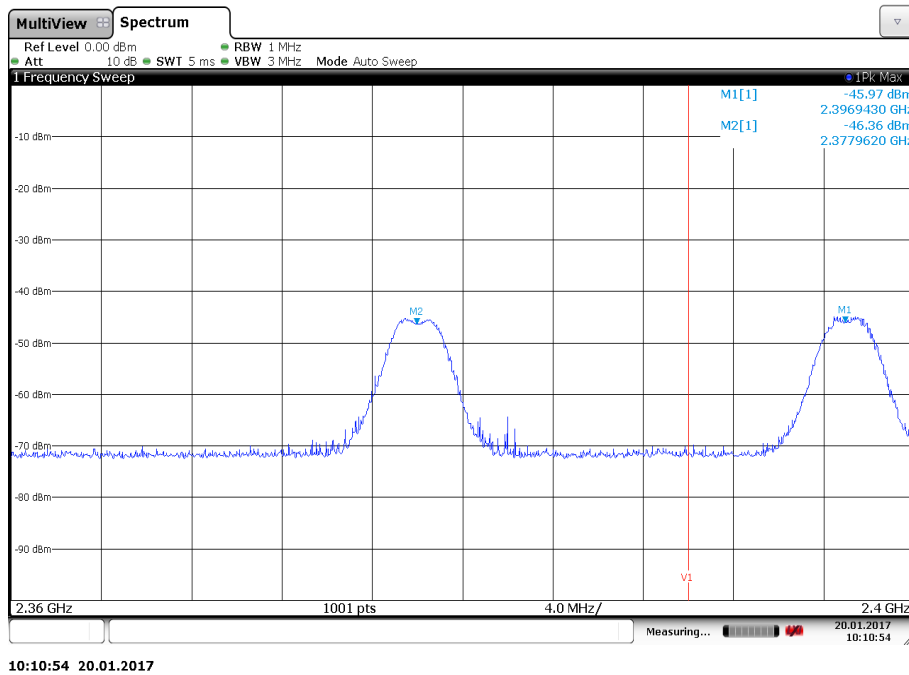

The 2360-2390 MHz band (Marker 2 @ 2378 MHz) was enabled for the body-worn sensor communication and the sensor transmits on the channel defined by the MBAN P/C. The control message of the MBAN P/C is transmitted in the 2390-2400 MHz band (Marker 1 @ 2397 MHz). The V1 frequency line marks the end of lower and the start of the upper MBAN band.

Step 3 (KDB 550599 D01 v01):

(e) Interrupt the RF and verify that the DUT ceases transmission in the 2360–2390 MHz band with a latency period not exceeding the maximum control message periodicity as specified in the operational description of the device. Additionally, if the DUT operating frequency is now moved to 2390–2400 MHz band verify the channel transition time (latency) is less than the maximum control message periodicity as specified in the operational description of the device.

Plot 3:

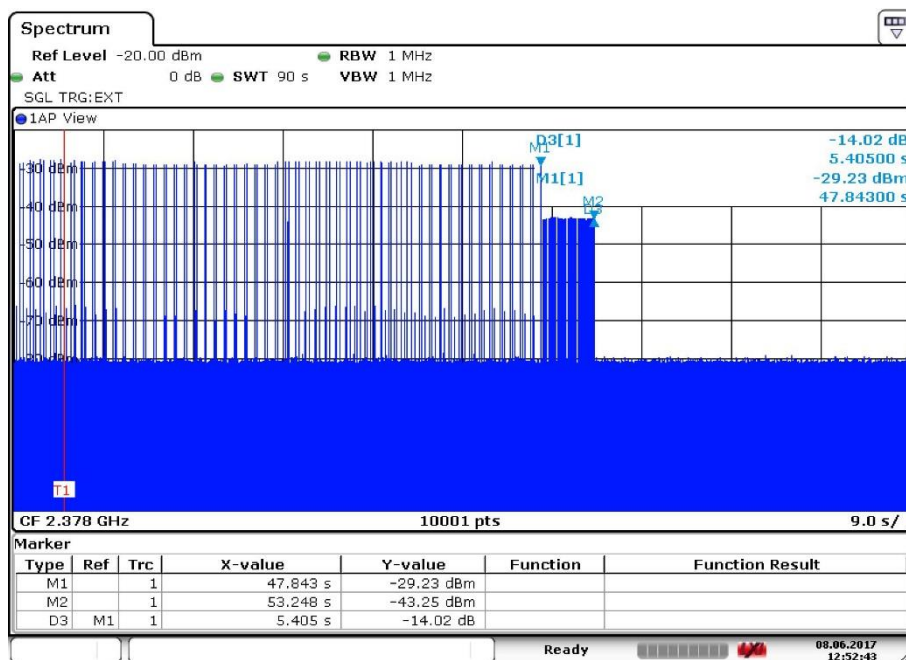

The communication between the MBAN P/C and the simulated control point was interrupted via LAN disconnection. MBAN P/C and body-worn sensor stop the communication within the MBAN frequency bands.

The plot shows the communication between the MBAN P/C and the body-worn sensor in the 2360-2390 MHz band. The red trigger line (T1) indicates the interrupt between the MBAN P/C and the simulated control point within the communication timeline. The base station stops communication within 47.8 seconds (Marker 1) and the body-worn sensor runs another 5.4 seconds and finished the communication within 53.2 seconds. (Marker 2 and delta marker 3).

Plot 4: Spectrum after marker 2 plot 3

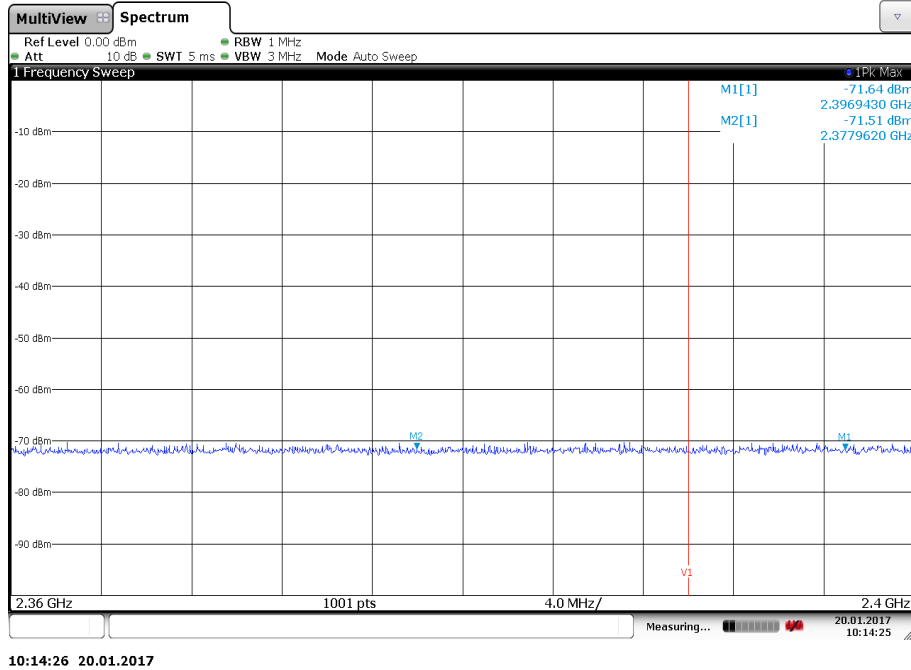

MBAN P/C and body-worn sensor stop the communication within the MBAN frequency bands. The V1 frequency line marks the end of lower and the start of the upper MBAN band.

13 Observations

No observations except those reported with the single test cases have been made.

Annex A Glossary

EUT	Equipment under test
DUT	Device under test
UUT	Unit under test
ETSI	European Telecommunications Standard Institute
EN	European Standard
FCC	Federal Communication Commission
FCC ID	Company Identifier at FCC
IC	Industry Canada
PMN	Product marketing name
HMN	Host marketing name
HVIN	Hardware version identification number
FVIN	Firmware version identification number
EMC	Electromagnetic Compatibility
HW	Hardware
SW	Software
Inv. No.	Inventory number
S/N or SN	Serial number
C	Compliant
NC	Not compliant
NA	Not applicable
NP	Not performed
PP	Positive peak
QP	Quasi peak
AVG	Average
OC	Operating channel
OCW	Operating channel bandwidth
OBW	Occupied bandwidth
OOB	Out of band
DFS	Dynamic frequency selection
CAC	Channel availability check
OP	Occupancy period
NOP	Non occupancy period
DC	Duty cycle
PER	Packet error rate
CW	Clean wave
MC	Modulated carrier
WLAN	Wireless local area network
RLAN	Radio local area network
DSSS	Dynamic sequence spread spectrum
OFDM	Orthogonal frequency division multiplexing
FHSS	Frequency hopping spread spectrum

Annex B Document history

Version	Applied changes	Date of release
-/-	Initial release	2016-10-06
A	Added chapter	2017-08-16
B	Editorial changes, plots of the output power measurements added	2017-09-05
C	Editorial change in Chapter 11	2017-09-20

Annex C Accreditation Certificate

first page	last page			
 <p>Deutsche Akkreditierungsstelle GmbH</p> <p>Beliehene gemäß § 8 Absatz 1 AkkStelleG i.V.m. § 1 Absatz 1 AkkStelleGBV Unterzeichnerin der Multilateralen Abkommen von EA, ILAC und IAF zur gegenseitigen Anerkennung</p> <p>Akkreditierung </p> <p>Die Deutsche Akkreditierungsstelle GmbH bestätigt hiermit, dass das Prüflaboratorium</p> <p>CTC advanced GmbH Untertürkheimer Straße 6-10, 66117 Saarbrücken</p> <p>die Kompetenz nach DIN EN ISO/IEC 17025:2005 besitzt, Prüfungen in folgenden Bereichen durchzuführen:</p> <ul style="list-style-type: none"> Funk Mobilfunk (GSM / DCS) + OTA Elektromagnetische Verträglichkeit (EMV) Produktsicherheit SAR / EMF Umwelt Smart Card Technology Bluetooth® Automotive Wi-Fi Services Kanadische Anforderungen US-Anforderungen Akustik Near Field Communication (NFC) <p>Die Akkreditierungsurkunde gilt nur in Verbindung mit dem Bescheid vom 25.11.2016 mit der Akkreditierungsnummer D-PL-12076-01 und ist gültig bis 17.01.2018. Sie besteht aus diesem Deckblatt, der Rückseite des Deckblatts und der folgenden Anlage mit insgesamt 63 Seiten.</p> <p>Registrierungsnummer der Urkunde: D-PL-12076-01-01</p> <p>Frankfurt, 25.11.2016</p> <p> Im Auftrag Dipl.-Ing. Jörg Ralf Egner Abteilungsleiter</p> <p><small>Siehe Hinweise auf der Rückseite</small></p>	<p>Deutsche Akkreditierungsstelle GmbH</p> <table border="0"> <tr> <td>Standort Berlin Spittelmarkt 10 10117 Berlin</td> <td>Standort Frankfurt am Main Europa-Allee 52 60327 Frankfurt am Main</td> <td>Standort Braunschweig Bundesallee 100 38116 Braunschweig</td> </tr> </table> <p>Die auszugsweise Veröffentlichung der Akkreditierungsurkunde bedarf der vorherigen schriftlichen Zustimmung der Deutsche Akkreditierungsstelle GmbH (DAKKS). Ausgenommen davon ist die separate Weiterverbreitung des Deckblattes durch die uneinseitig genannte Konformitätsbewertungsstelle in unveränderter Form.</p> <p>Es darf nicht der Anschein erweckt werden, dass sich die Akkreditierung auch auf Bereiche erstreckt, die über den durch die DAkKS bestätigten Akkreditierungsbereich hinausgehen.</p> <p>Die Akkreditierung erfolgte gemäß des Gesetzes über die Akkreditierungsstelle (AkkStelleG) vom 31. Juli 2009 (BGBl. I S. 2625) sowie der Verordnung (EG) Nr. 765/2008 des Europäischen Parlaments und des Rates vom 9. Juli 2008 über die Vorschriften für die Akkreditierung und Marktüberwachung im Zusammenhang mit der Vermarktung von Produkten (Abi. L 218 vom 9. Juli 2008, S. 30). Die DAkKS ist Unterzeichnerin der Multilateralen Abkommen zur gegenseitigen Anerkennung der European co-operation for Accreditation (EA), des International Accreditation Forum (IAF) und der International Laboratory Accreditation Cooperation (ILAC). Die Unterzeichner dieser Abkommen erkennen ihre Akkreditierungen gegenseitig an.</p> <p>Der aktuelle Stand der Mitgliedschaft kann folgenden Webseiten entnommen werden: EA: www.european-accreditation.org ILAC: www.ilac.org IAF: www.iaf.nu</p>	Standort Berlin Spittelmarkt 10 10117 Berlin	Standort Frankfurt am Main Europa-Allee 52 60327 Frankfurt am Main	Standort Braunschweig Bundesallee 100 38116 Braunschweig
Standort Berlin Spittelmarkt 10 10117 Berlin	Standort Frankfurt am Main Europa-Allee 52 60327 Frankfurt am Main	Standort Braunschweig Bundesallee 100 38116 Braunschweig		

Note: The current certificate including annex is published on the website (link see below) of the Accreditation Body DAkKS or may be received by CTC advanced GmbH on request

<http://www.dakks.de/as/ast/d/D-PL-12076-01-01.pdf>

<http://www.dakks.de/as/ast/d/D-PL-12076-01-02.pdf>