

TEST REPORT

Test report no.: 1-5420/12-01-11-A



Testing laboratory

CETECOM ICT Services GmbH
 Untertuerkheimer Strasse 6 – 10
 66117 Saarbruecken / Germany
 Phone: + 49 681 5 98 - 0
 Fax: + 49 681 5 98 - 9075
 Internet: <http://www.cetecom.com>
 e-mail: ict@cetecom.com

Accredited Testing Laboratory:

The testing laboratory (area of testing) is accredited according to DIN EN ISO/IEC 17025 (2005) by the Deutsche Akkreditierungsstelle GmbH (DAkkS). The accreditation is valid for the scope of testing procedures as stated in the accreditation certificate with the registration number: D-PL-12076-01-01
 Area of Testing: Radio/Satellite Communications

Applicant

Philips Medizin Systeme Böblingen GmbH
 Hewlett-Packard-Strasse 2
 71034 Böblingen / GERMANY
 Phone: -/-
 Fax: +49 7031 463-2442
 Contact: Markus Stacha
 e-mail: markus.stacha@philips.com
 Phone: +49 7031 463-2840

Manufacturer

Philips Medizin Systeme Böblingen GmbH
 Hewlett-Packard-Strasse 2
 71034 Böblingen / GERMANY

Test standard/s

47 CFR Part 15	Title 47 of the Code of Federal Regulations; Chapter I Part 15 - Radio frequency devices
RSS - 210 Issue 8	Spectrum Management and Telecommunications - Radio Standards Specification Low-power Licence-exempt Radiocommunication Devices (All Frequency Bands): Category I Equipment

For further applied test standards please refer to section 3 of this test report.

Test Item

Kind of test item: 2.4 GHz Transceiver
Model name: SRR Module BV3
FCC ID: PQC-SRRBV3
IC: 3549C-SRRBV3
 Frequency: ISM band 2400 MHz to 2483.5 MHz
 (lowest channel 11 – 2405 MHz;
 highest channel 26 – 2480 MHz)
 Technology tested: proprietary
 Antenna: Integrated chip antenna
 Power supply: 3.3 V DC
 Temperature range: -20°C to +55°C



This test report is electronically signed and valid without handwriting signature. For verification of the electronic signatures, the public keys can be requested at the testing laboratory.

Test report authorised:



Marco Bertolino
 Testing Manager

Test performed:



Christoph Schneider
 Expert

1 Table of contents

1 Table of contents2

2 General information3

 2.1 Notes and disclaimer3

 2.2 Application details.....3

3 Test standard/s3

4 Test environment.....4

5 Test item4

 5.1 Additional information4

6 Test laboratories sub-contracted4

7 Summary of measurement results5

8 RF measurements6

 8.1 Description of test setup6

 8.1.1 Radiated measurements.....6

 8.1.2 Conducted measurements.....7

 8.2 Additional comments7

 8.3 RSP100 test report cover sheet / performance test data8

9 Measurement results.....9

 9.1 Antenna gain9

 9.2 Maximum output power10

 9.3 Power spectral density13

 9.4 Spectrum bandwidth – 6 dB bandwidth16

 9.5 Spectrum bandwidth – 99% emission bandwidth19

 9.6 Band edge compliance conducted22

 9.7 Band edge compliance radiated24

 9.8 TX spurious emissions conducted27

 9.9 TX spurious emissions radiated31

 9.10 RX spurious emissions radiated42

 9.11 TX spurious emissions radiated < 30 MHz46

 9.12 TX spurious emissions conducted < 30 MHz.....48

10 Test equipment and ancillaries used for tests49

11 Observations50

Annex A Document history51

Annex B Further information.....51

Annex C Accreditation Certificate52

2 General information

2.1 Notes and disclaimer

The test results of this test report relate exclusively to the test item specified in this test report. CETECOM ICT Services GmbH does not assume responsibility for any conclusions and generalizations drawn from the test results with regard to other specimens or samples of the type of the equipment represented by the test item.

The test report may only be reproduced or published in full. Reproduction or publication of extracts from the report requires the prior written approval of CETECOM ICT Services GmbH.

The testing service provided by CETECOM ICT Services GmbH has been rendered under the current "General Terms and Conditions for CETECOM ICT Services GmbH".

CETECOM ICT Services GmbH will not be liable for any loss or damage resulting from false, inaccurate, inappropriate or incomplete product information provided by the customer.

Under no circumstances does the CETECOM ICT Services GmbH test report include any endorsement or warranty regarding the functionality, quality or performance of any other product or service provided.

Under no circumstances does the CETECOM ICT Services GmbH test report include or imply any product or service warranties from CETECOM ICT Services GmbH, including, without limitation, any implied warranties of merchantability, fitness for purpose, or non-infringement, all of which are expressly disclaimed by CETECOM ICT Services GmbH.

All rights and remedies regarding vendor's products and services for which CETECOM ICT Services GmbH has prepared this test report shall be provided by the party offering such products or services and not by CETECOM ICT Services GmbH.

In no case this test report can be considered as a Letter of Approval.

This test report is electronically signed and valid without handwritten signature. For verification of the electronic signatures, the public keys can be requested at the testing laboratory.

2.2 Application details

Date of receipt of order:	2012-10-08
Date of receipt of test item:	2013-05-22
Start of test:	2013-07-05
End of test:	2013-09-18
Person(s) present during the test:	-/-

3 Test standard/s

Test standard	Date	Test standard description
47 CFR Part 15	01.10.2010	Title 47 of the Code of Federal Regulations; Chapter I Part 15 - Radio frequency devices
RSS - 210 Issue 8	01.12.2010	Spectrum Management and Telecommunications - Radio Standards Specification Low-power Licence-exempt Radiocommunication Devices (All Frequency Bands): Category I Equipment

4 Test environment

Temperature:	T_{nom}	+22 °C during room temperature tests
	T_{max}	+55 °C during high temperature tests
	T_{min}	-20 °C during low temperature tests
Relative humidity content:		50 %
Barometric pressure:		not relevant for this kind of testing
Power supply:	V_{nom}	5.0 V DC, USB powered reduced via adapter board to 3.3 V
	V_{max}	5.25 V
	V_{min}	4.0 V

5 Test item

Kind of test item	:	2.4 GHz Transceiver
Type identification	:	SRR Module BV3
S/N serial number	:	Rad. 1311 FT 318 000338 Cond. 1311 FT 318 000351
HW hardware status	:	1311
SW software status	:	B.02.11
Frequency band [MHz]	:	ISM band 2400 MHz to 2483.5 MHz (lowest channel 11 – 2405 MHz; highest channel 26 – 2480 MHz)
Type of radio transmission	:	Modulated carrier
Use of frequency spectrum	:	
Type of modulation	:	O-QPSK
Number of channels	:	16
Antenna	:	Integrated chip antenna
Power supply	:	3.3 V DC
Temperature range	:	-20°C to +55 °C

Maximum power conducted: 1.00 mW (0.00 dBm)
Maximum power radiated: 2.08 mW (3.19 dBm)

5.1 Additional information

Test setup - and EUT - photos are included in the following test reports:

External EUT photos: 1-5420/12-01-01_AnnexA
Internal EUT photos: 1-5420/12-01-01_AnnexB
Test setup: 1-5420/12-01-01_AnnexD

6 Test laboratories sub-contracted

None

7 Summary of measurement results

- No deviations from the technical specifications were ascertained
- There were deviations from the technical specifications ascertained

TC Identifier	Description	Verdict	Date	Remark
RF-Testing	CFR Part 15 RSS 210, Issue 8, Annex 8	Passed	2013-10-17	-/-

Test specification clause	Test case	Temperature conditions	Power source voltages	Pass	Fail	NA	NP	Remark
§15.247(b)(4) RSS 210 / A8.4(2)	Antenna gain	Nominal	Nominal	<input checked="" type="checkbox"/>	<input type="checkbox"/>	<input type="checkbox"/>	<input type="checkbox"/>	complies
§15.247(e) RSS 210 / A8.2(b)	Power spectral density	Nominal	Nominal	<input checked="" type="checkbox"/>	<input type="checkbox"/>	<input type="checkbox"/>	<input type="checkbox"/>	complies
§15.247(a)(2) RSS 210 / A8.2(a)	Spectrum bandwidth 6dB bandwidth	Nominal	Nominal	<input checked="" type="checkbox"/>	<input type="checkbox"/>	<input type="checkbox"/>	<input type="checkbox"/>	complies
§15.247(a)(2) RSS 210 / A8.2(a)	Spectrum bandwidth 20dB bandwidth	Nominal	Nominal	<input checked="" type="checkbox"/>	<input type="checkbox"/>	<input type="checkbox"/>	<input type="checkbox"/>	complies
§15.247(b)(3) RSS-210 / A8.4(4)	Maximum output power	Nominal	Nominal	<input checked="" type="checkbox"/>	<input type="checkbox"/>	<input type="checkbox"/>	<input type="checkbox"/>	complies
§15.247(d) RSS-210 / A8.5	Band edge compliance conducted	Nominal	Nominal	<input checked="" type="checkbox"/>	<input type="checkbox"/>	<input type="checkbox"/>	<input type="checkbox"/>	complies
§15.205 RSS-210 / A8.5	Band edge compliance radiated	Nominal	Nominal	<input checked="" type="checkbox"/>	<input type="checkbox"/>	<input type="checkbox"/>	<input type="checkbox"/>	complies
§15.247(d) RSS-210 / A8.5	TX spurious emissions conducted	Nominal	Nominal	<input checked="" type="checkbox"/>	<input type="checkbox"/>	<input type="checkbox"/>	<input type="checkbox"/>	complies
§15.247(d) RSS-210 / A8.5	TX spurious emissions radiated	Nominal	Nominal	<input checked="" type="checkbox"/>	<input type="checkbox"/>	<input type="checkbox"/>	<input type="checkbox"/>	complies
§15.109 RSS-Gen.	RX spurious emissions radiated	Nominal	Nominal	<input checked="" type="checkbox"/>	<input type="checkbox"/>	<input type="checkbox"/>	<input type="checkbox"/>	complies
§15.209(a) RSS-Gen	TX spurious emissions radiated < 30 MHz	Nominal	Nominal	<input checked="" type="checkbox"/>	<input type="checkbox"/>	<input type="checkbox"/>	<input type="checkbox"/>	complies
§15.107(a)	Conducted emissions < 30 MHz	Nominal	Nominal	<input checked="" type="checkbox"/>	<input type="checkbox"/>	<input type="checkbox"/>	<input type="checkbox"/>	complies

Note: NA = Not Applicable; NP = Not Performed

8 RF measurements

8.1 Description of test setup

8.1.1 Radiated measurements

The radiated measurements are performed in vertical and horizontal plane in the frequency range from 9 kHz to 25 GHz in semi-anechoic chambers. The EUT is positioned on a non-conductive support with a height of 0.80 m above a conductive ground plane that covers the whole chamber. The receiving antennas are confirmed with specifications ANSI C63.2-1996 clause 15 and ANSI C63.4-2009 clause 4.1.5. These antennas can be moved over the height range between 1.0 m and 4.0 m in order to search for maximum field strength emitted from EUT. The measurement distances between EUT and receiving antennas are indicated in the test setups for the various frequency ranges. For each measurement, the EUT is rotated in all three axes until the maximum field strength is received. The wanted and unwanted emissions are received by spectrum analysers where the detector modes and resolution bandwidths over various frequency ranges are set according to requirement ANSI C63-4-2009 clause 4.2.

Antennas are confirmed with ANSI C63.2-1996 item 15.

Semi anechoic chamber

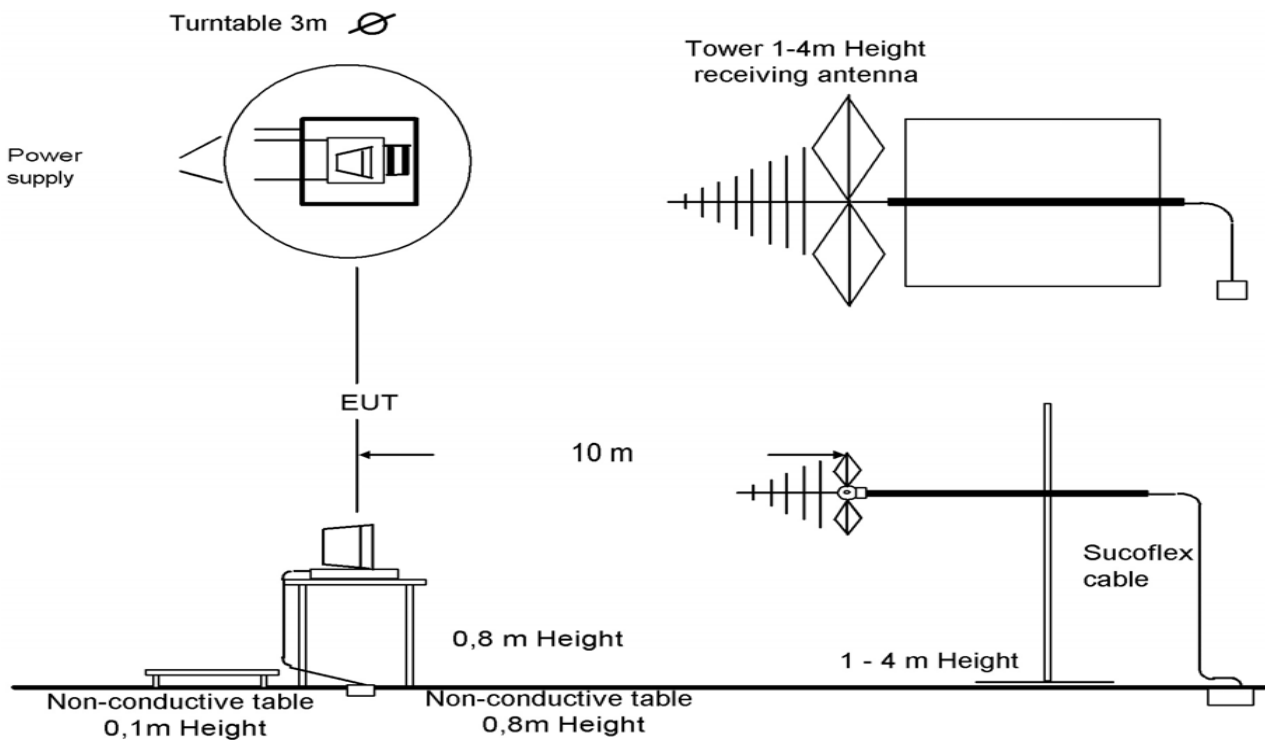

Picture 1: Diagram radiated measurements

9 kHz - 30 MHz:	active loop antenna
30 MHz – 1 GHz:	tri-log antenna
> 1 GHz:	horn antenna

The EUT is powered by an external power supply with nominal voltage

8.1.2 Conducted measurements

The EUT's RF signal is coupled out by the antenna connector which is supplied by the manufacturer. The signal is first 10dB attenuated before it is power divided (~6dB loss per branch). One of the signal paths is connected to the communication base Station (CMU200 or other), the other one is connected to the spectrum analyzer. The specific losses for both signal paths are first checked within a calibration. The measurement readings on the signalling unit/spectrum analyzer are corrected by the specific test set-up loss. The attenuator, power divider, signalling unit and the spectrum analyzer are impedance matched on 50 Ohm.

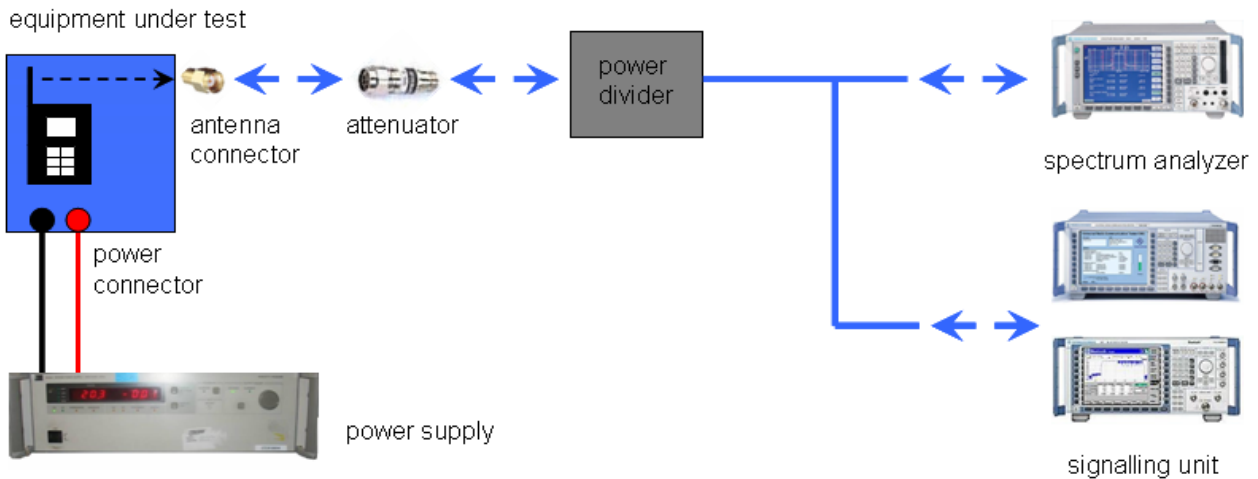

Picture 2: Diagram conducted measurements

8.2 Additional comments

Reference documents: None

Special test descriptions: None

Configuration descriptions: Power settings (software provided by customer):
 Channel 11 (Low, 2405 MHz): 0 dBm
 Channel 18 (Mid, 2440 MHz): 0 dBm
 Channel 26 (high, 2480 MHz): -5 dBm

Test mode: No test mode available.
 Special software is used.
 EUT is transmitting pseudo random data by itself

8.3 RSP100 test report cover sheet / performance test data

Test report number	:	1-5420/12-01-11
Equipment model number	:	SRR Module BV3
Certification number	:	3549C-SRRBV3
Manufacturer (complete address)	:	Philips Medizin Systeme Böblingen GmbH Hewlett-Packard-Strasse 2 71034 Böblingen / GERMANY
Tested to radio standards specification no.	:	RSS 210, Issue 8, Annex 8
Open area test site IC No.	:	IC 3462C-1
Frequency range	:	Lowest channel: 2405 MHz Highest channel: 2480 MHz
RF-power [mW] (max.)	:	cond.: 1.00 EIRP: 2.08
Occupied bandwidth (99%-BW) [MHz]	:	3.38
Type of modulation	:	O-QPSK
Emission designator (TRC-43)	:	3M38G1D
Antenna information	:	Integrated chip antenna
Transmitter spurious (worst case)[dB μ V/m@10m]:	:	22.4 dB μ V/m (Quasi Peak, noise floor)

ATTESTATION:

DECLARATION OF COMPLIANCE:

I attest that the testing was performed or supervised by me; that the test measurements were made in accordance with the above-mentioned Industry Canada standard(s); and that the equipment identified in this application has been subjected to all the applicable test conditions specified in the Industry Canada standards and all of the requirements of the standard have been met.

Laboratory manager:

2013-10-17

Date

Christoph Schneider

Name

Signature

9 Measurement results

9.1 Antenna gain

Measurement:

The antenna gain of the complete system is calculated by the difference of radiated power in EIRP and the conducted power of the module.

Measurement parameters:

Measurement parameter	
Detector:	Peak
Sweep time:	Auto
Video bandwidth:	3 MHz
Resolution bandwidth:	3 MHz
Trace-Mode:	Max hold

Limits:

FCC	IC
Antenna Gain	
6 dBi	

Results:

T _{nom}	V _{nom}	lowest channel	middle channel	highest channel
Conducted power [dBm] Measured		0.6	0.5	-3.5
Radiated power [dBm] Measured		2.8	3.8	-1.9
Gain [dBi] Calculated		2.2	3.3	1.6

Result: Passed

9.2 Maximum output power

Description:

Measurement of the maximum output power conducted and radiated

Measurement:

Measurement parameter	
According to DTS clause: 10.2	
Detector:	Peak
Sweep time:	Auto
Resolution bandwidth:	1 MHz
Video bandwidth:	3 MHz
Span:	10 MHz
Integration bandwidth:	75 % power - bandwidth (DTS BW)
Trace-Mode:	Max hold (allow trace to fully stabilize)
Measurement function:	Channel power with DTS BW

Limits:

FCC	IC
Maximum Output Power	
Conducted: 1.0 W – Antenna Gain max. 6 dBi	

Result:

Modulation Channel			
	Lowest	Middle	Highest
Maximum output power conducted [dBm]	0.00	-0.11	-4.33
Maximum output power radiated* - EIRP [dBm]	2.20	3.19	-2.73
Measurement uncertainty	± 3 dB		

*) calculated with Antenna gain

Result: Passed

Plots:

Plot 1: lowest channel

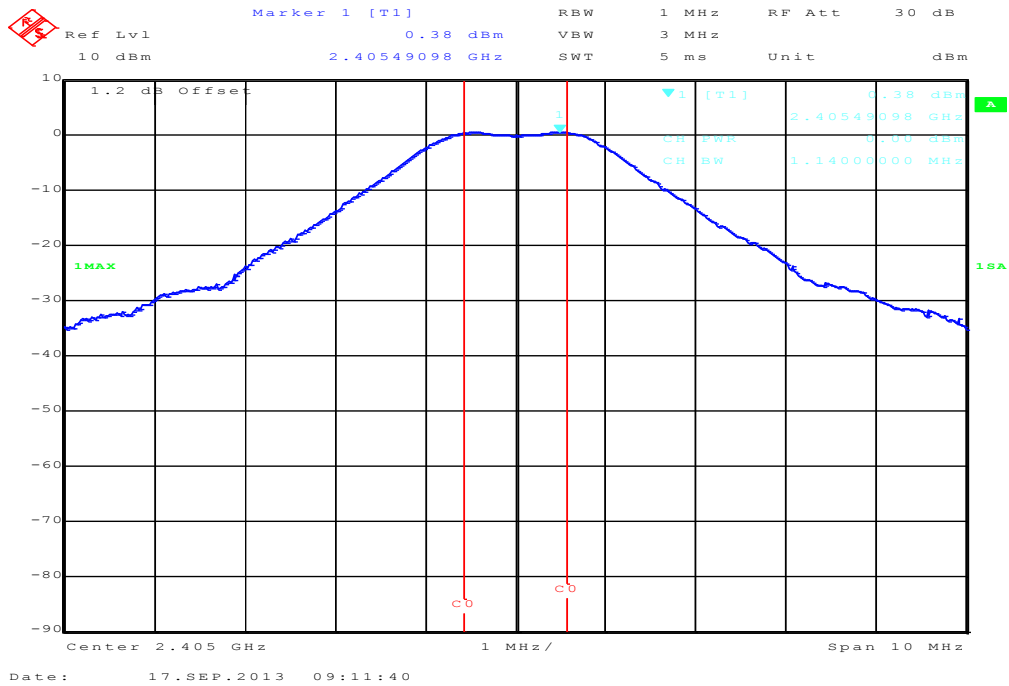

Plot 2: middle channel

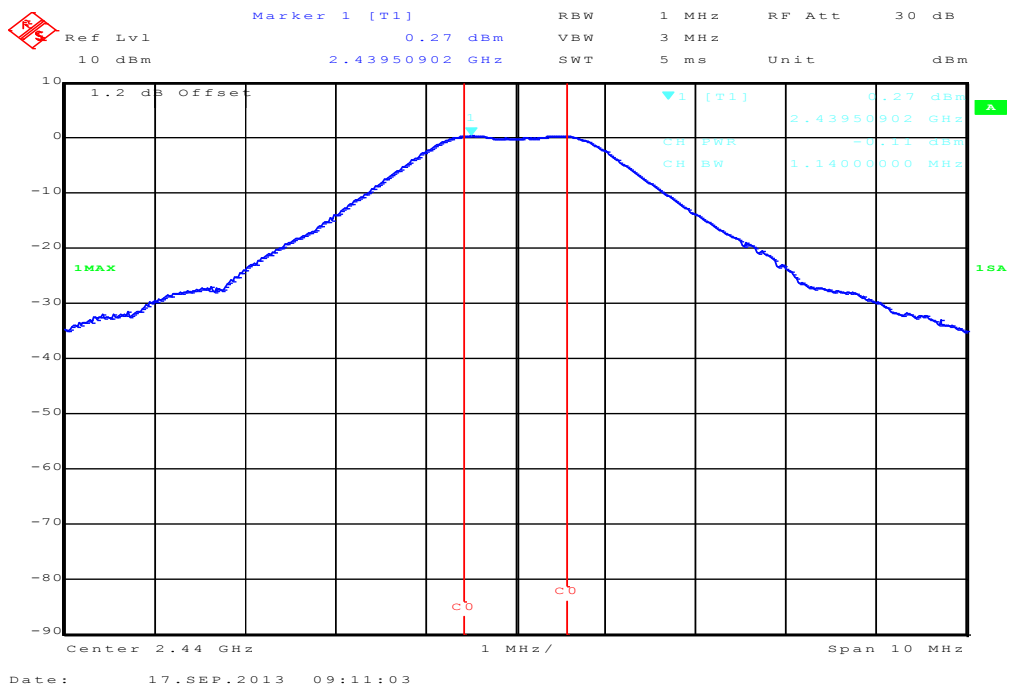

Plot 3: highest channel

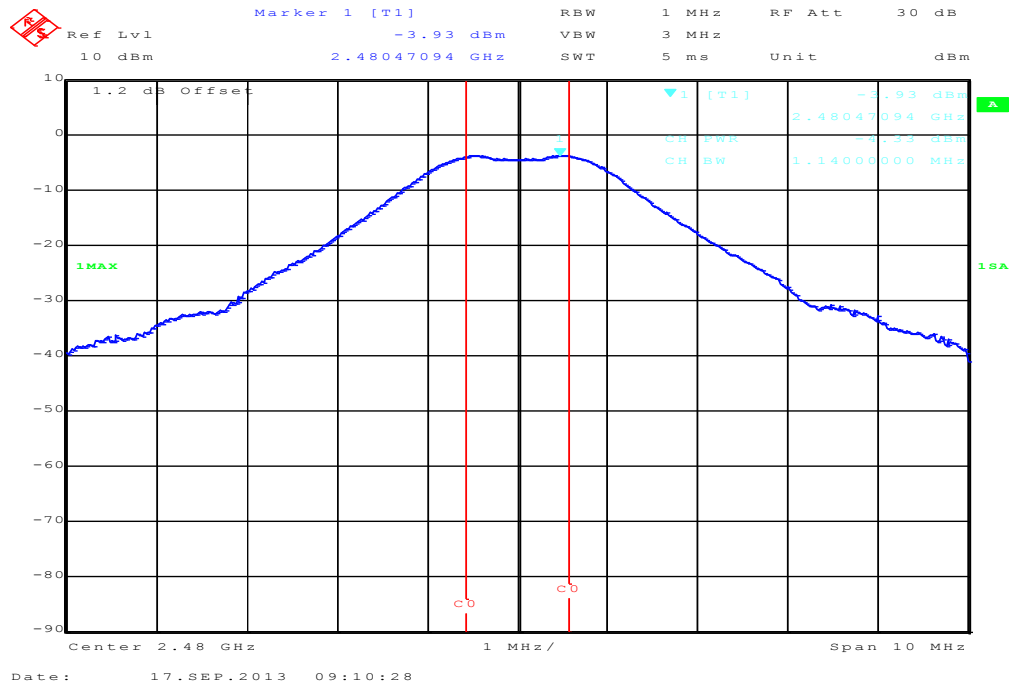

9.3 Power spectral density

Description:

Measurement of the power spectral density of a digital modulated system. The measurement is repeated at the lowest, middle and highest channel.

Measurement:

Measurement parameter	
According to DTS clause: 10.2	
Detector:	Peak
Sweep time:	Auto
Resolution bandwidth:	3 kHz
Video bandwidth:	10 kHz
Span:	10 MHz
Trace-Mode:	Max hold (allow trace to fully stabilize)

Limits:

FCC	IC
Power Spectral Density	
8 dBm (conducted)	

Results:

Modulation Channel	Power Spectral density [dBm/3kHz]		
	Lowest	Middle	Highest
	-15.49	-16.72	-20.13
Measurement uncertainty	± 1.5 dB		

Result: Passed

Plots:

Plot 1: lowest channel

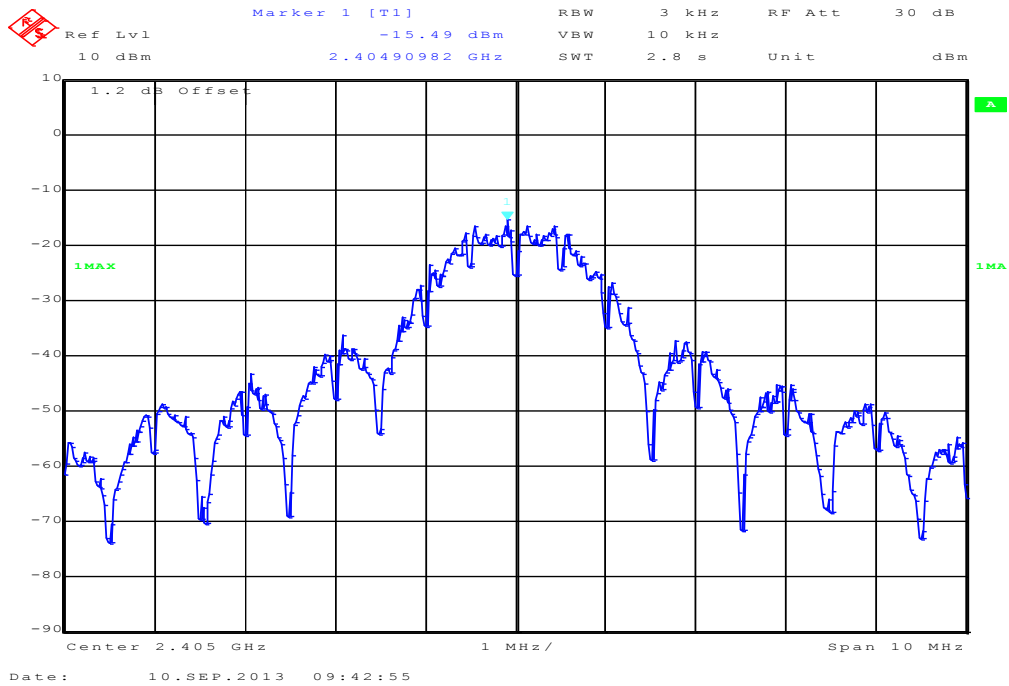

Plot 2: middle channel

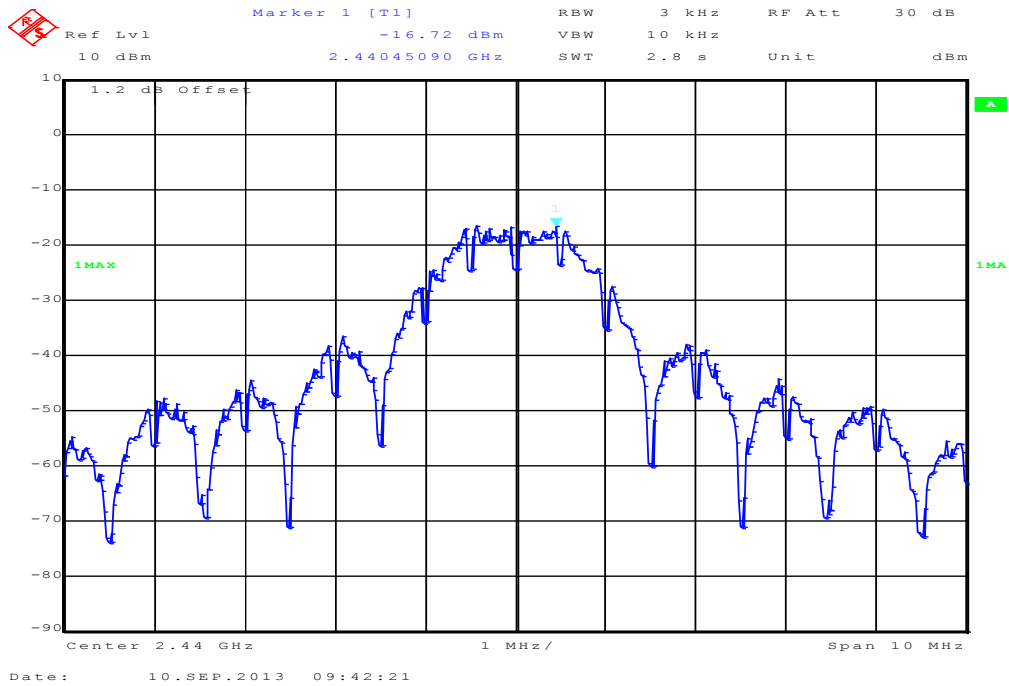

Plot 3: highest channel

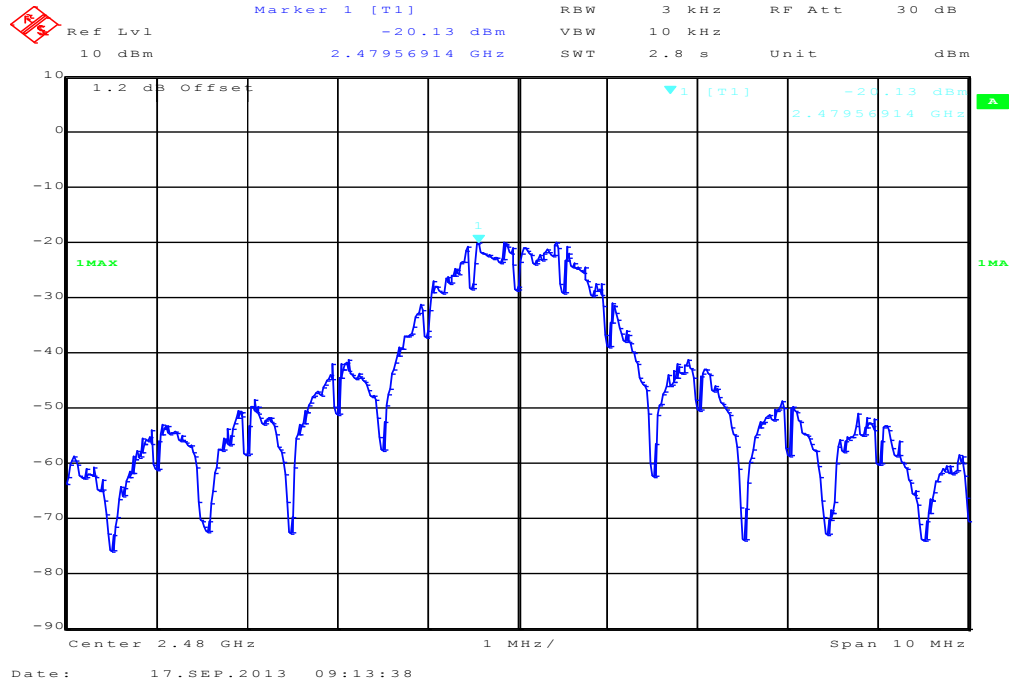

9.4 Spectrum bandwidth – 6 dB bandwidth

Description:

Measurement of the 6 dB bandwidth of the modulated signal.

Measurement:

Measurement parameter	
According to DTS clause: 8.2	
Detector:	Peak
Sweep time:	Auto
Resolution bandwidth:	100 kHz
Video bandwidth:	300 kHz
Span:	10 MHz
Measurement procedure:	Measurement of the 75% bandwidth using the integration function of the analyzer
Trace-Mode:	Max hold (allow trace to stabilize)

Limits:

FCC	IC
Spectrum Bandwidth – 6 dB Bandwidth	
Systems using digital modulation techniques may operate in the 2400–2483.5 MHz band. The minimum 6 dB bandwidth shall be at least 500 kHz.	

Results:

Modulation Channel	6 dB BANDWIDTH [MHz]		
	Lowest	Middle	Highest
	1.14	1.14	1.14
Measurement uncertainty	± 100 kHz		

Result: Passed

Plots:

Plot 1: lowest channel

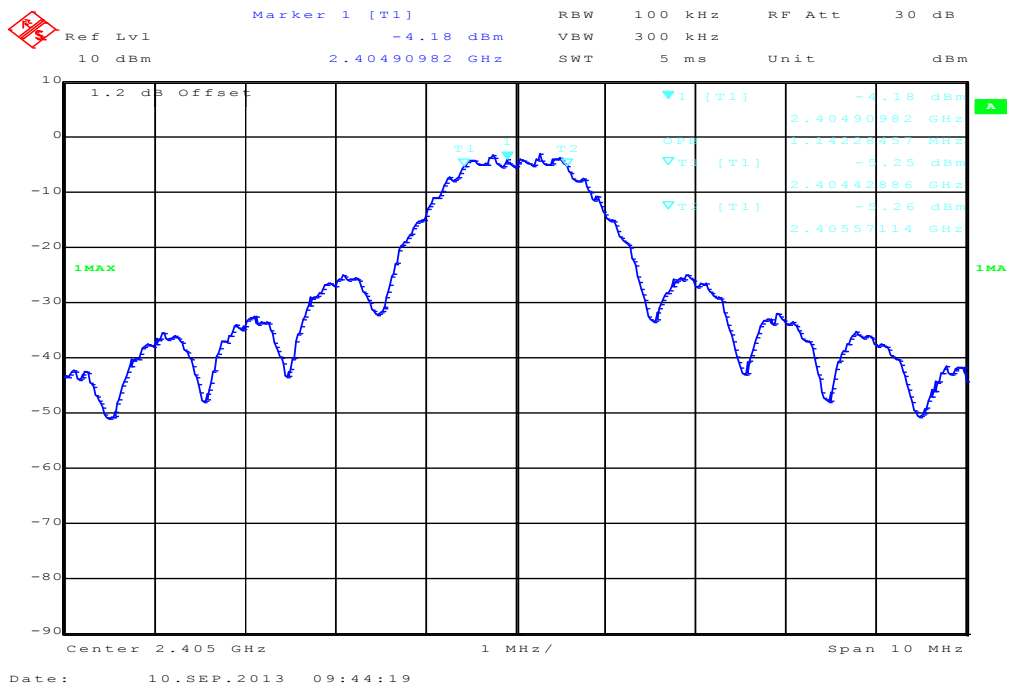

Plot 2: middle channel

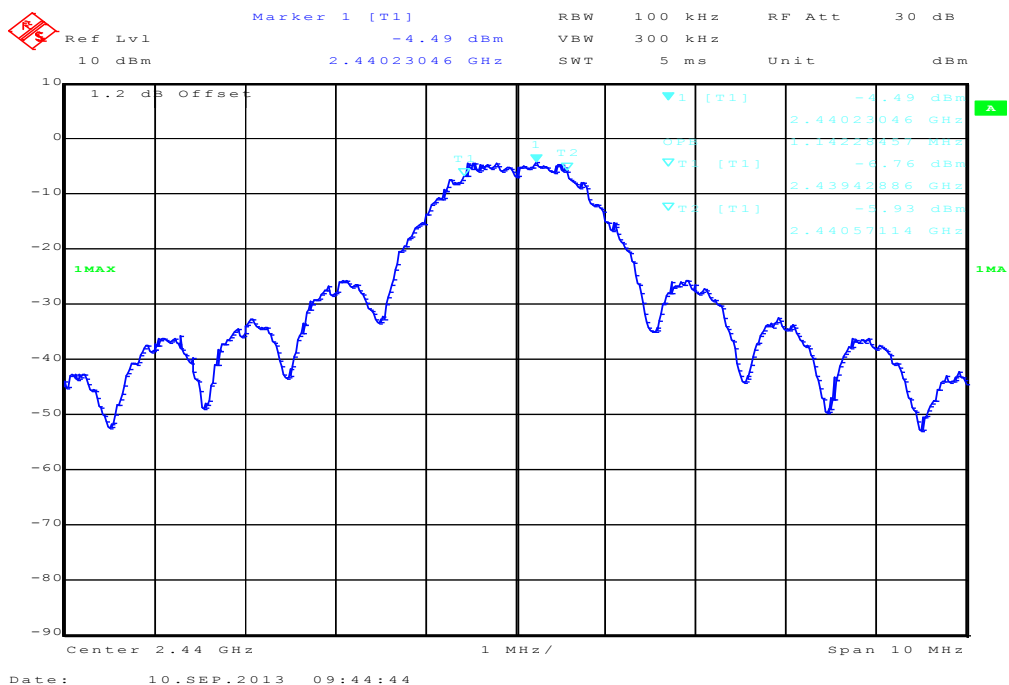

Plot 3: highest channel

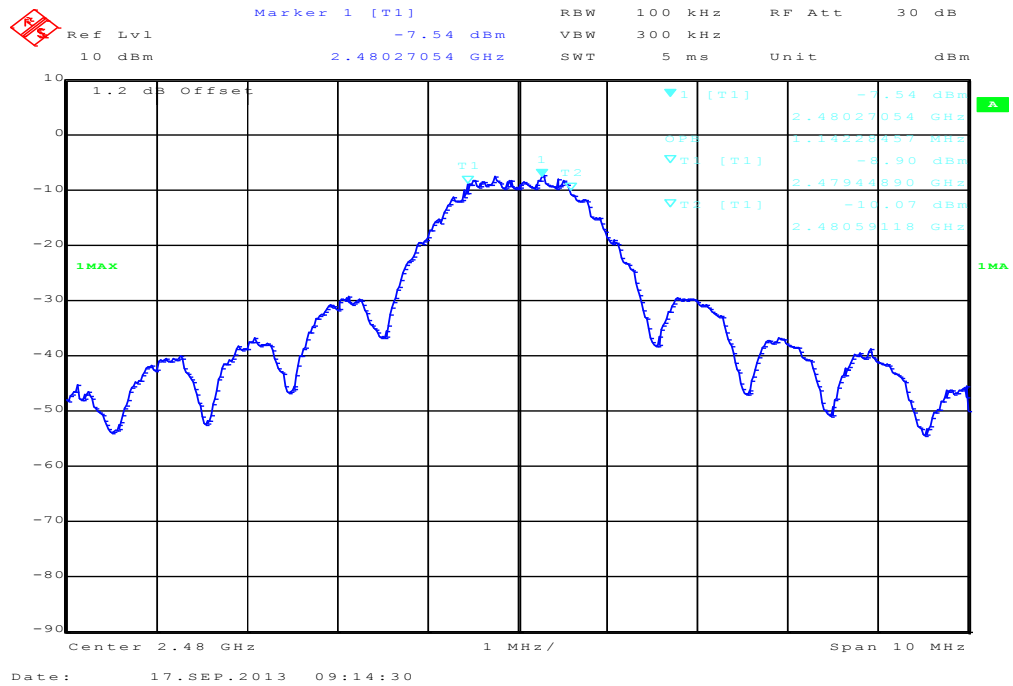

9.5 Spectrum bandwidth – 99% emission bandwidth

Description:

Measurement of the 99% bandwidth of the modulated signal acc. RSS-GEN.

Measurement:

Measurement parameter	
Detector:	Peak
Sweep time:	Auto
Resolution bandwidth:	500 kHz
Video bandwidth:	3 MHz
Span:	10 MHz
Measurement procedure:	Measurement of the 99% bandwidth using the integration function of the analyzer
Trace-Mode:	Max hold (allow trace to stabilize)

Usage:

-/-	IC
Occupied Bandwidth – 99% emission bandwidth	
OBW is necessary for Emission Designator	

Results:

Modulation Channel	20 dB BANDWIDTH [MHz]		
	Lowest	Middle	Highest
	3.37	3.37	3.38
Measurement uncertainty	± 100 kHz		

Result: Passed

Plots:

Plot 1: lowest channel

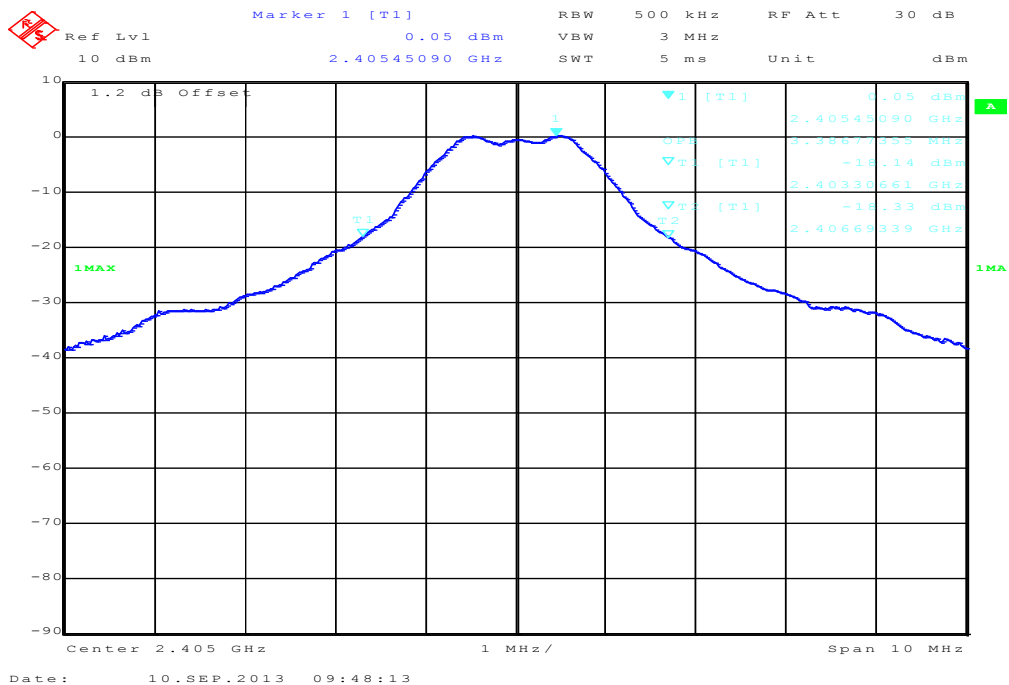

Plot 2: middle channel

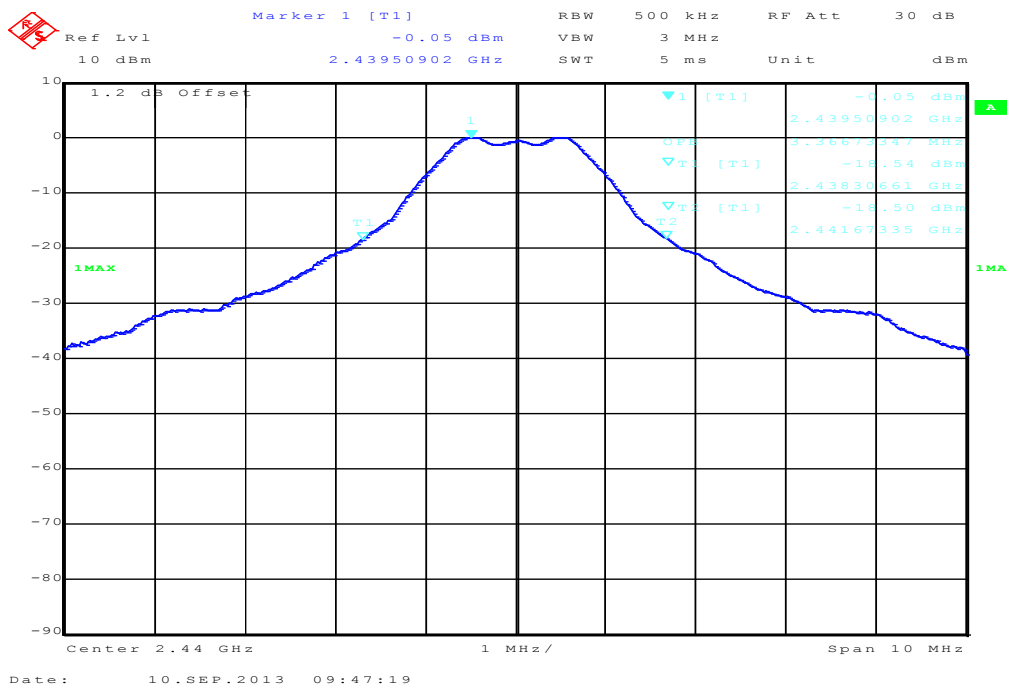

Plot 3: highest channel

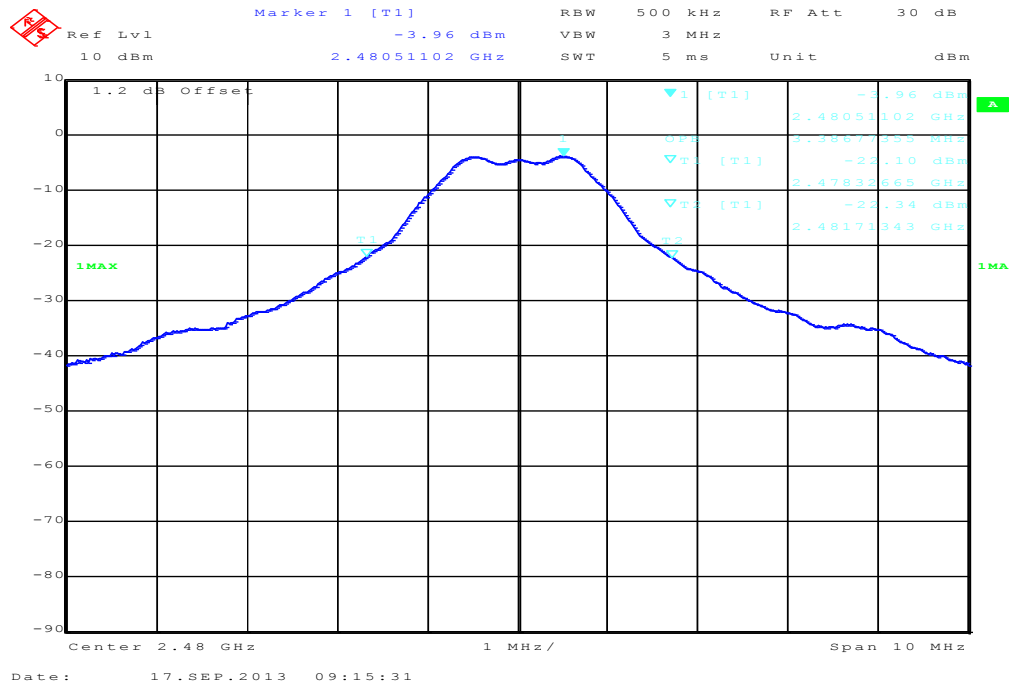

9.6 Band edge compliance conducted

Description:

Measurement of the conducted band edge compliance. EUT is measured at the lower and upper band edge.

Measurement:

Measurement parameter	
According to DTS clause: 13.2.1	
Detector:	Peak
Sweep time:	Auto
Resolution bandwidth:	100 kHz
Video bandwidth:	500 kHz
Span:	Lower Band Edge: 2300 – 2425 MHz Upper Band Edge: 2450 – 2550 MHz
Trace-Mode:	Max hold

Limits:

FCC	IC
Band Edge Compliance Conducted	
<p>In any 100 kHz bandwidth outside the frequency band in which the spread spectrum or digitally modulated intentional radiator is operating, the radio frequency power that is produced by the intentional radiator shall be at least 20 dB below that in the 100 kHz bandwidth within the band that contains the highest level of the desired power, based on either an RF conducted or a radiated measurement. Attenuation below the general limits specified in Section 15.209(a) is not required.</p>	

Result:

Scenario	Band Edge Compliance Conducted [dB]
Lower Band Edge	> 20 dB (see plot 1)
Upper Band Edge	> 20 dB (see plot 2)
Measurement uncertainty	± 1.5 dB

Result: **Passed**

Plots:

Plot 1: lowest channel

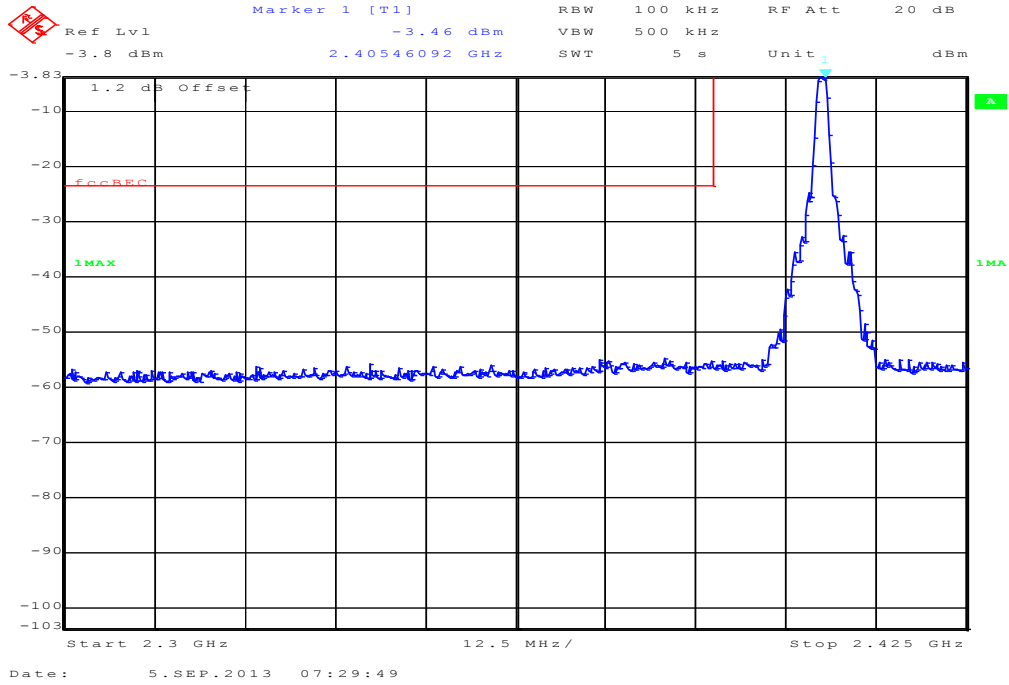

Plot 2: highest channel

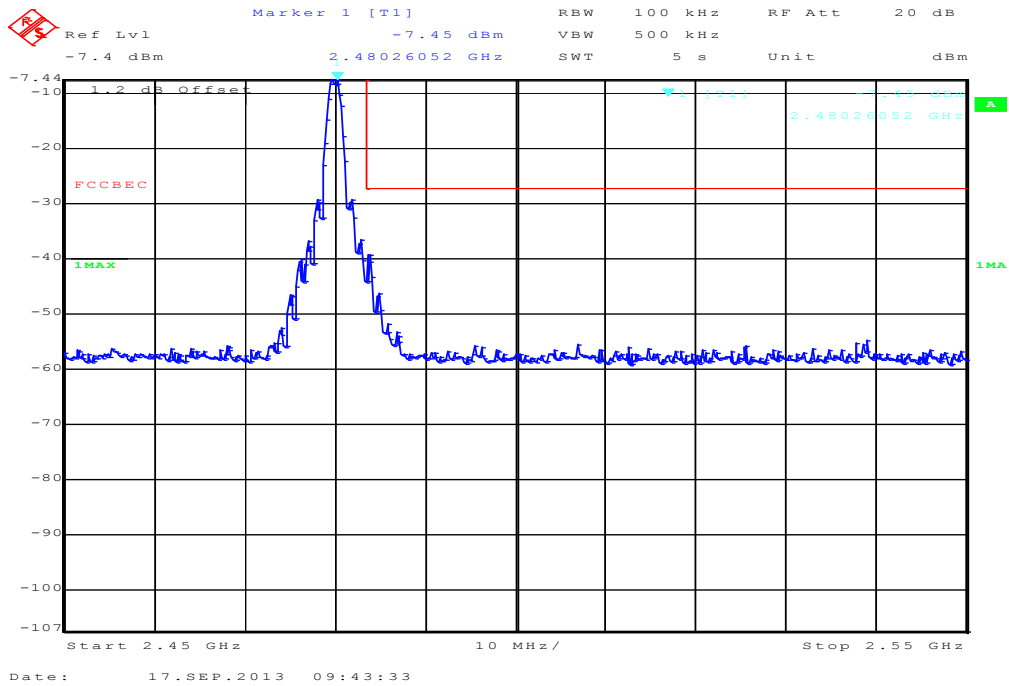

9.7 Band edge compliance radiated

Description:

Measurement of the radiated band edge compliance. The EUT is turned in the position that results in the maximum level at the band edge. Then a sweep over the corresponding restricted band is performed. The EUT is set to channel 1 for the lower restricted band and to channel 11 for the upper restricted band. The measurement is repeated for all modulations. Measurement distance is 3m.

Measurement:

Measurement parameter	
Detector:	Peak
Sweep time:	Auto
Resolution bandwidth:	1 MHz / 1 MHz
Video bandwidth:	1 MHz / 10 Hz
Span:	See plot!
Trace-Mode:	Max Hold

Limits:

FCC	IC
Band Edge Compliance Radiated	
<p>In any 100 kHz bandwidth outside the frequency band in which the spread spectrum or digitally modulated intentional radiator is operating, the radio frequency power that is produced by the intentional radiator shall be at least 20 dB below that in the 100 kHz bandwidth within the band that contains the highest level of the desired power, based on either an RF conducted or a radiated measurement. Attenuation below the general limits specified in Section 15.209(a) is not required. In addition, radiated emissions which fall in the restricted bands, as defined in Section 15.205(a), must also comply with the radiated emission limits specified in Section 15.209(a) (see Section 5.205(c)).</p>	
54 dB μ V/m AVG	

Result:

Scenario	Band Edge Compliance Radiated [dB μ V/m]
Lower Band Edge	< 54 dB μ V/m (see plot 1)
Upper Band Edge	< 54 dB μ V/m (see plot 2)
Measurement uncertainty	\pm 3 dB

Result: Passed

Plots:

Plot 1: TX mode, lower band edge, vertical & horizontal polarization

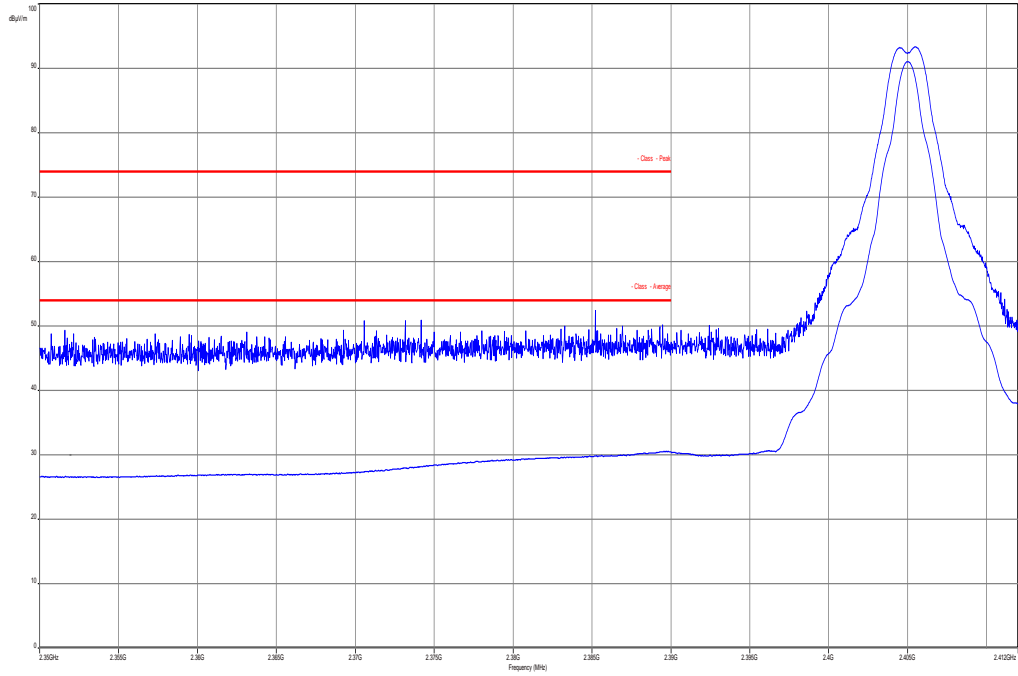

Plot 2: TX mode, upper band edge, vertical & horizontal polarization

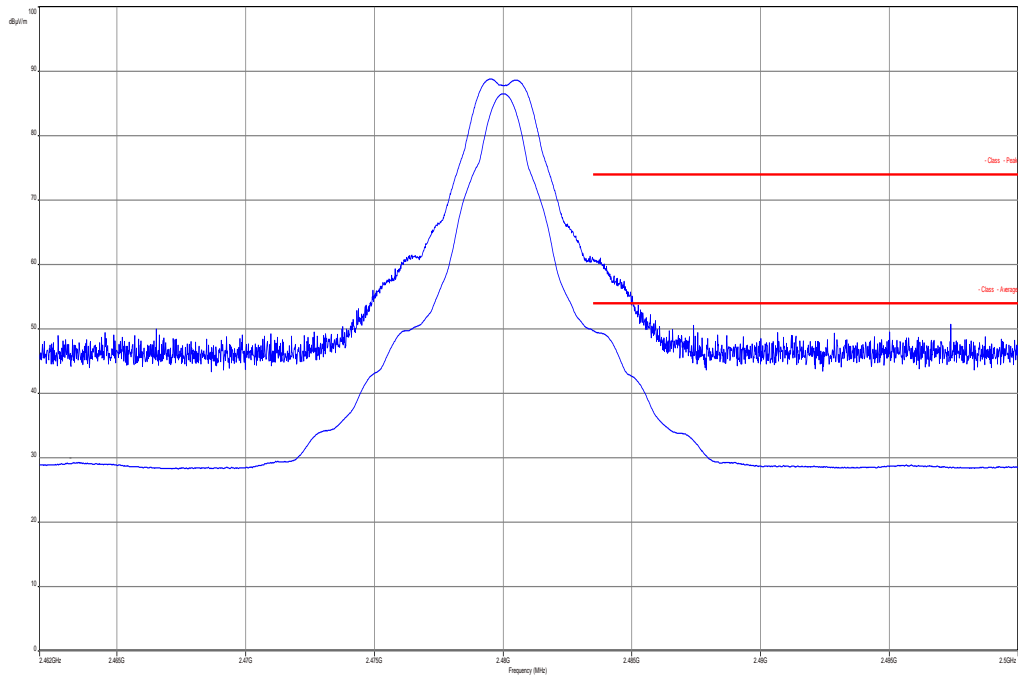

Plot 3: TX mode, upper band edge, according to DTS clause 13.2.2

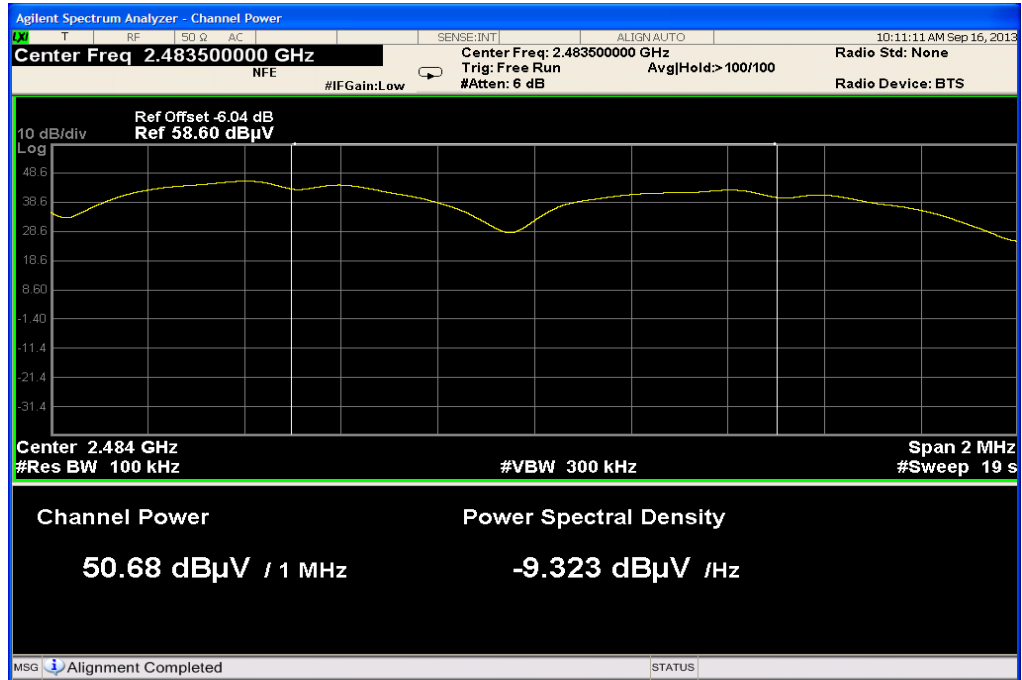

9.8 TX spurious emissions conducted

Description:

Measurement of the conducted spurious emissions in transmit mode. The measurement is performed at channel 11, 18 and 26.

Measurement:

Measurement parameter	
According to:	
Detector:	Peak
Sweep time:	Auto
Resolution bandwidth:	100 kHz
Video bandwidth:	500 kHz
Span:	9 kHz to 25 GHz
Trace-Mode:	Max Hold

Limits:

FCC	IC
TX Spurious Emissions Conducted	
<p>In any 100 kHz bandwidth outside the frequency band in which the spread spectrum or digitally modulated intentional radiator is operating, the radio frequency power that is produced by the intentional radiator shall be at least 20 dB below that in the 100 kHz bandwidth within the band that contains the highest level of the desired power, based on either an RF conducted or a radiated measurement. Attenuation below the general limits specified in Section 15.209(a) is not required</p>	

Results:

TX Spurious Emissions Conducted					
f [MHz]		amplitude of emission [dBm]	limit max. allowed emission power	actual attenuation below frequency of operation [dB]	results
Low		-5.40	30 dBm		Operating frequency
<i>No critical peaks found</i>			-20 dBc		complies
Middle		-4.14	30 dBm		Operating frequency
<i>No critical peaks found</i>			-20 dBc		complies
High		-9.07	30 dBm		Operating frequency
<i>No critical peaks found</i>			-20 dBc		complies
Measurement uncertainty			± 3 dB		

Result: Passed

Plots:

Plot 1: lowest channel

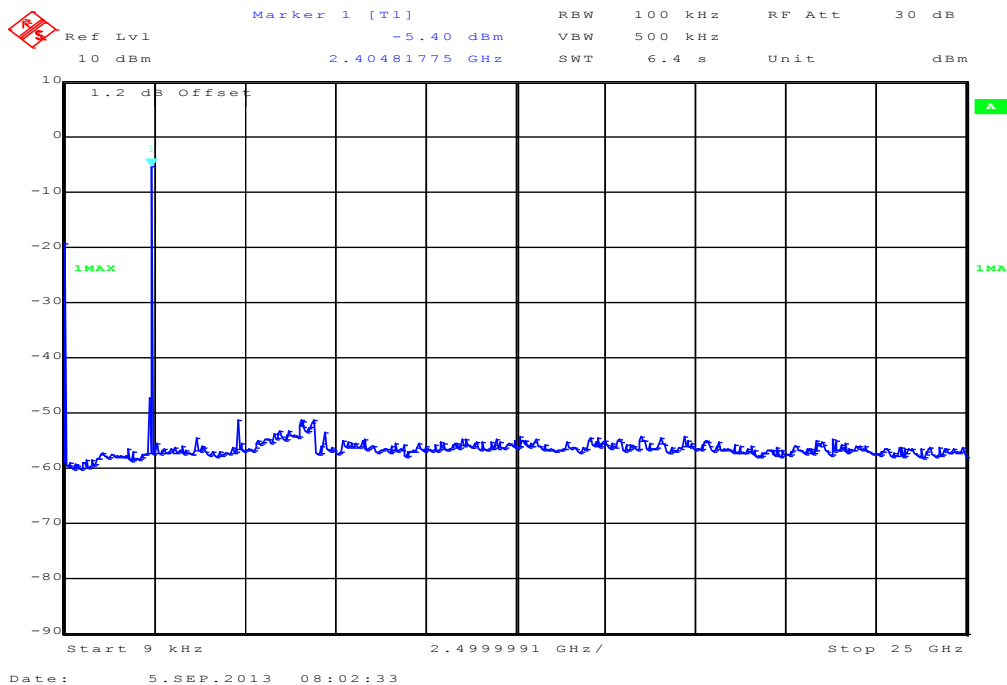

Plot 2: middle channel

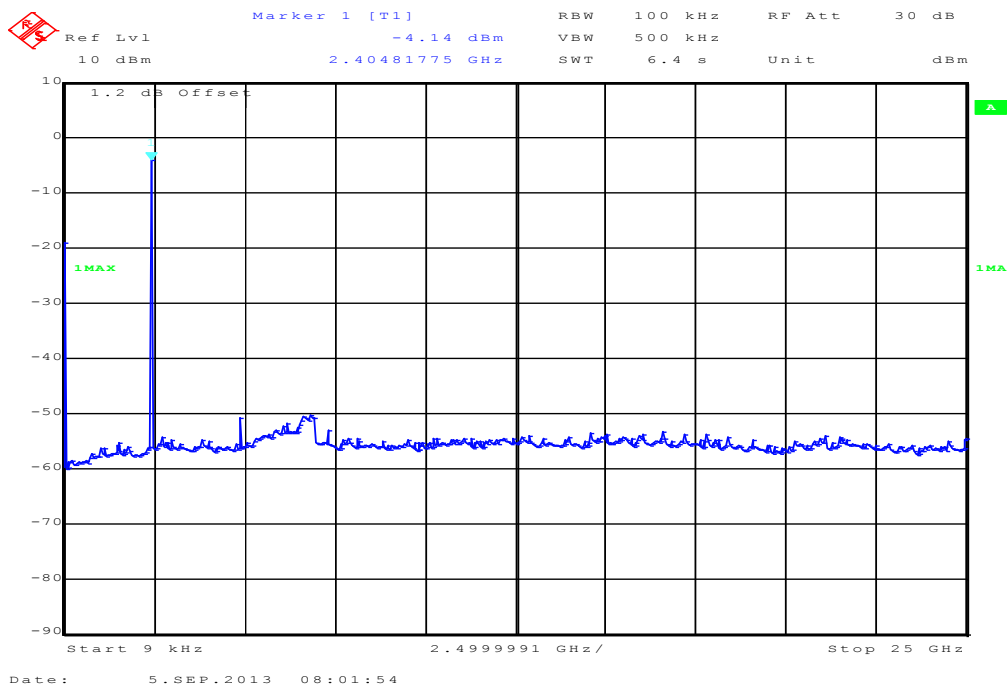

Plot 3: highest channel

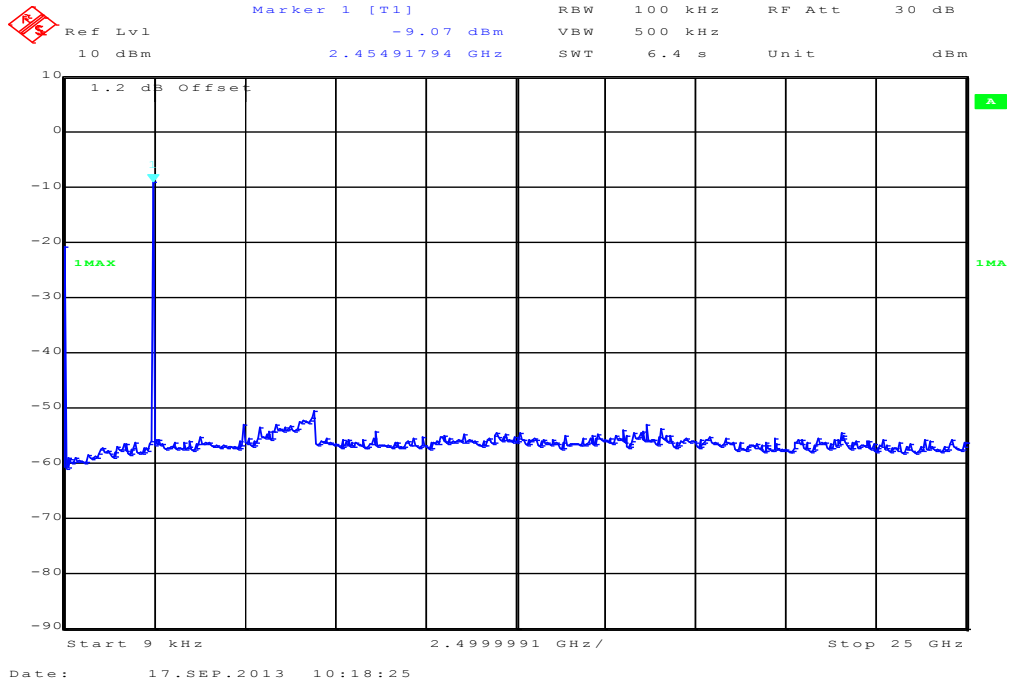

9.9 TX spurious emissions radiated

Description:

Measurement of the radiated spurious emissions in transmit mode. The measurement is performed at channel 11, 18 and 26.

Measurement:

Measurement parameter	
Detector:	Peak / Quasi Peak / RMS
Sweep time:	Auto
Resolution bandwidth:	F > 1 GHz: 1 MHz F < 1 GHz: 100 kHz
Video bandwidth:	Sweep: 100 kHz Remeasurement: 10 Hz / 3 MHz
Span:	30 MHz to 25 GHz
Trace-Mode:	Max Hold

The modulation with the highest output power was used to perform the transmitter spurious emissions. If spurious were detected a re-measurement was performed on the detected frequency with each modulation.

Limits:

FCC	IC	
TX Spurious Emissions Radiated		
<p>In any 100 kHz bandwidth outside the frequency band in which the spread spectrum or digitally modulated intentional radiator is operating, the radio frequency power that is produced by the intentional radiator shall be at least 20 dB below that in the 100 kHz bandwidth within the band that contains the highest level of the desired power, based on either an RF conducted or a radiated measurement. Attenuation below the general limits specified in Section 15.209(a) is not required. In addition, radiated emissions which fall in the restricted bands, as defined in §15.205(a), must also comply with the radiated emission limits specified in §15.209(a) (see §15.205(c)).</p>		
Frequency (MHz)	Field Strength (dBµV/m)	Measurement distance
30 - 88	30.0	10
88 – 216	33.5	10
216 – 960	36.0	10
Above 960	54.0	3

Results:

TX Spurious Emissions Radiated [dB μ V/m]								
Lowest			Middle			Highest		
F [MHz]	Detector	Level [dB μ V/m]	F [MHz]	Detector	Level [dB μ V/m]	F [MHz]	Detector	Level [dB μ V/m]
No critical peaks found			No critical peaks found			No critical peaks found		
Measurement uncertainty			± 3 dB					

Result: Passed

Plots:

Plot 1: Lowest channel, 30 MHz to 1 GHz, vertical & horizontal polarization

Common Information

EUT: SSR Module BV3
 Serial Number: 1311 FT 318 000338
 Test Description: FCC part 15 B class B @ 10 m
 Operating Conditions: testmode CH11, Tx, 0dB
 Operator Name: Medrow
 Comment: USB 5V

Scan Setup: STAN_Fin [EMI radiated]

Hardware Setup: Electric Field (NOS)
 Receiver: [ESCI 3]
 Level Unit: dBµV/m

Subrange	Step Size	Detectors	IF BW	Meas. Time	Preamp
30 MHz - 2 GHz	60 kHz	QPK	120 kHz	1 s	20 dB

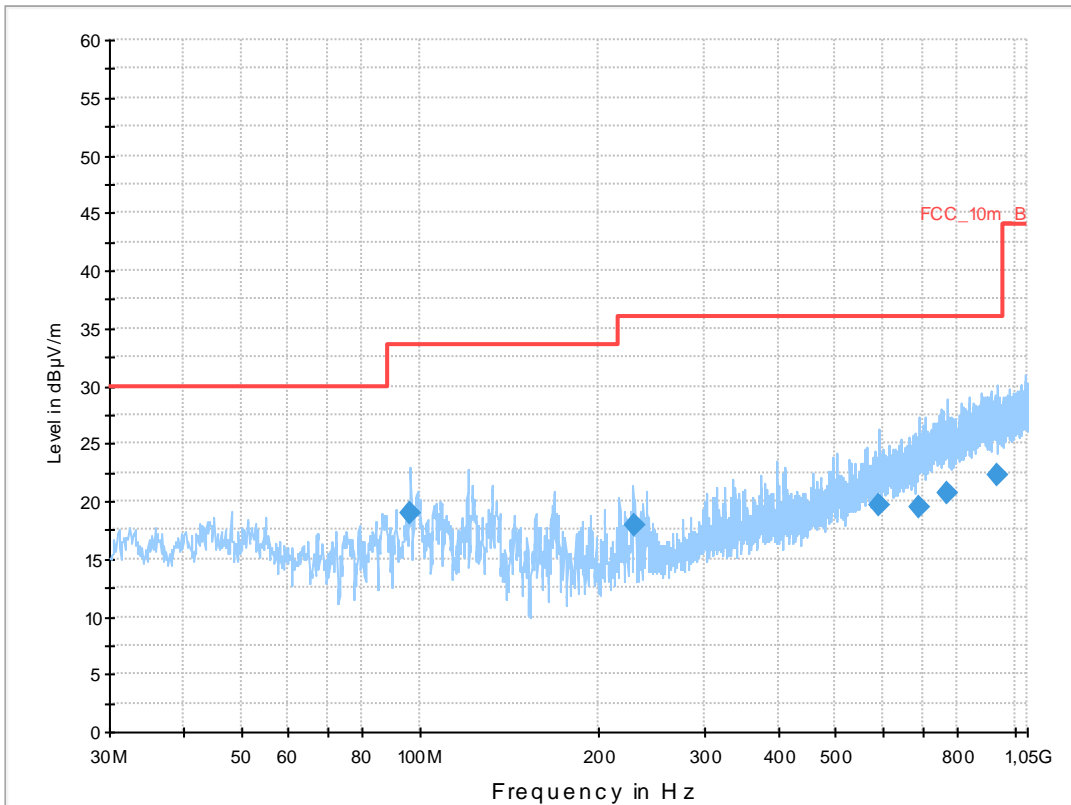

Final Result 1

Frequency (MHz)	QuasiPeak (dBµV/m)	Meas. Time (ms)	Bandwidth (kHz)	Height (cm)	Polarization	Azimuth (deg)	Corr. (dB)	Margin (dB)	Limit (dBµV/m)	Comment
95.891550	18.9	1000.0	120.000	111.0	V	261.0	11.4	14.6	33.5	
228.754800	18.0	1000.0	120.000	98.0	V	267.0	12.7	18.0	36.0	
589.335300	19.6	1000.0	120.000	122.0	V	100.0	20.5	16.4	36.0	
691.729050	19.4	1000.0	120.000	170.0	V	268.0	22.3	16.6	36.0	
769.994100	20.7	1000.0	120.000	170.0	H	10.0	23.7	15.3	36.0	
937.620900	22.3	1000.0	120.000	170.0	H	0.0	25.3	13.7	36.0	

Plot 2: lowest channel, 1 GHz to 12.75 GHz, vertical & horizontal polarization

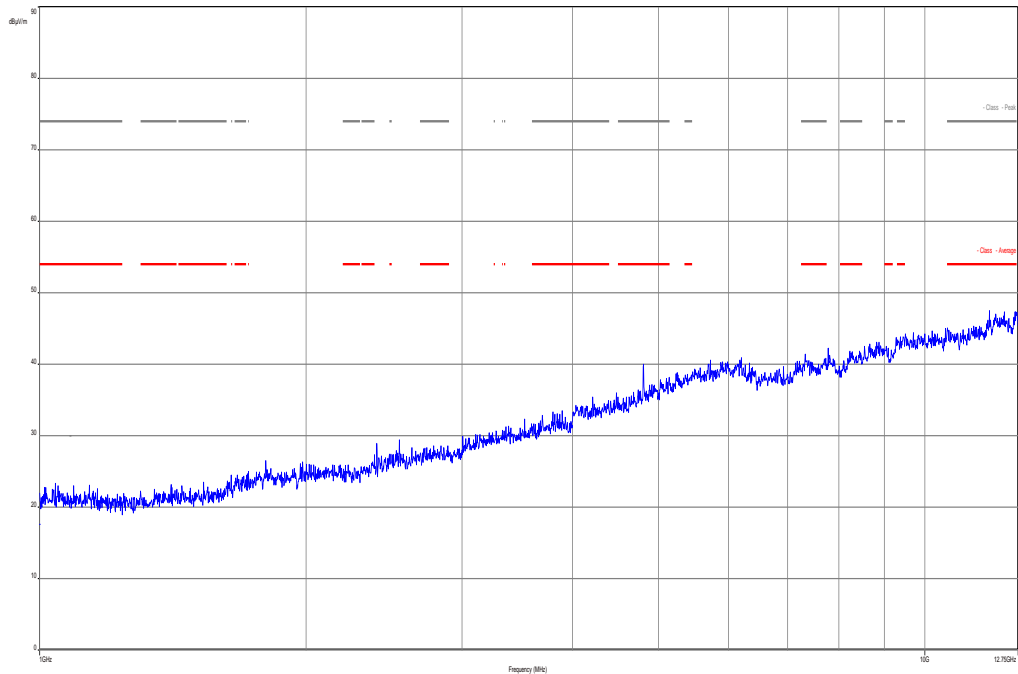

The carrier signal is notched with a 2.4 GHz band rejection filter.

Plot 3: Lowest channel, 12 GHz to 18 GHz, vertical & horizontal polarization

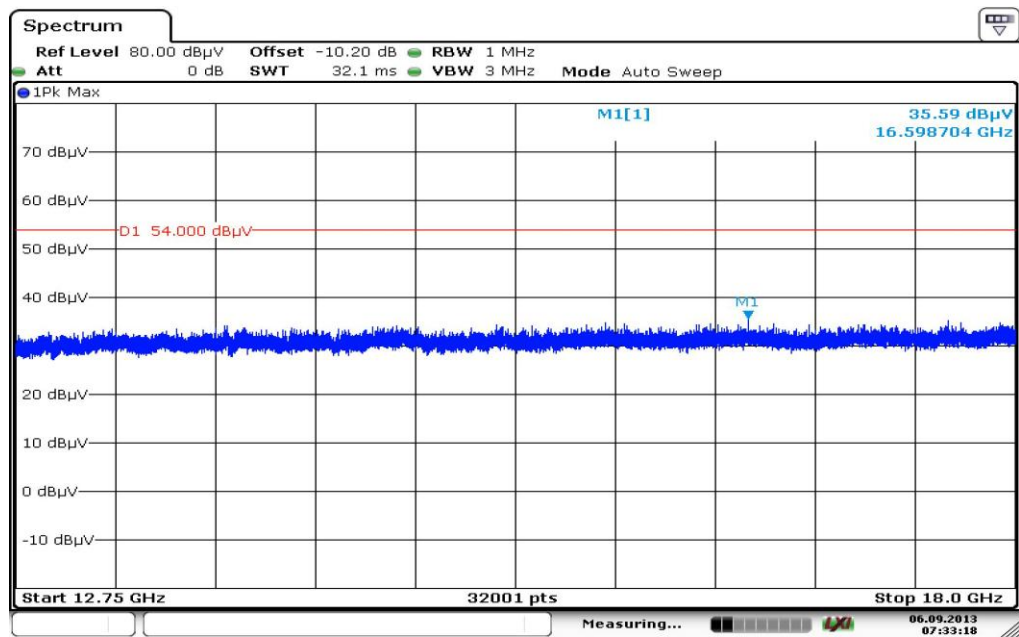

Date: 6.SEP.2013 07:33:18

Plot 4: Lowest channel, 18 GHz to 26 GHz, vertical & horizontal polarization

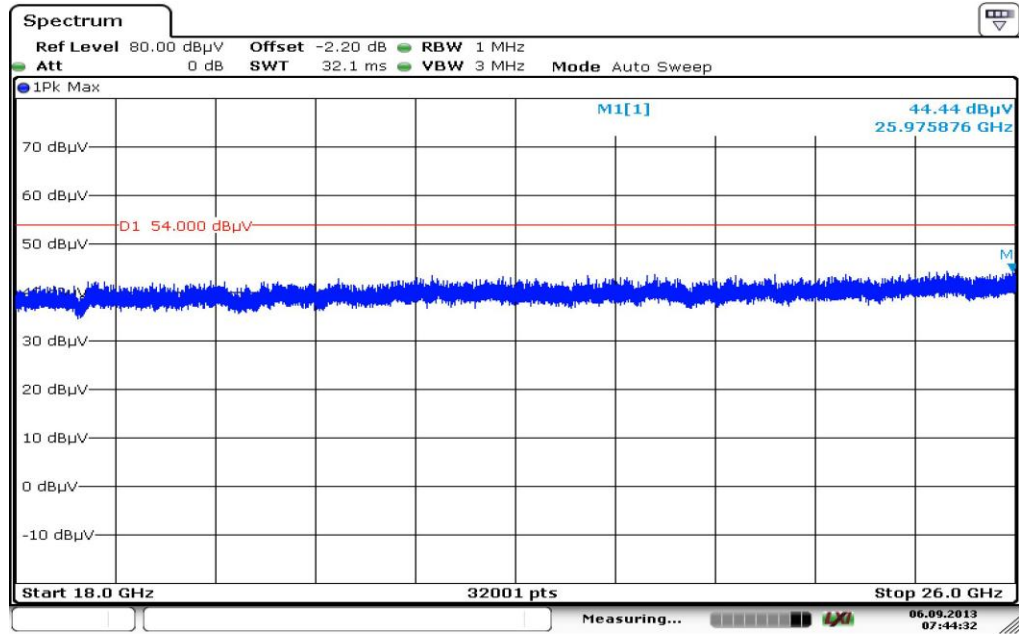

Date: 6.SEP.2013 07:44:32

Plot 5: Middle channel, 30 MHz to 1 GHz, vertical & horizontal polarization

Common Information

EUT: SSR Module BV3
 Serial Number: 1311 FT 318 000338
 Test Description: FCC part 15 B class B @ 10 m
 Operating Conditions: testmode CH18, 0dB
 Operator Name: Medrow
 Comment:

Scan Setup: STAN_Fin [EMI radiated]

Hardware Setup: Electric Field (NOS)
 Receiver: [ESCI 3]
 Level Unit: dBµV/m

Subrange	Step Size	Detectors	IF BW	Meas. Time	Preamp
30 MHz - 2 GHz	60 kHz	QPK	120 kHz	1 s	20 dB

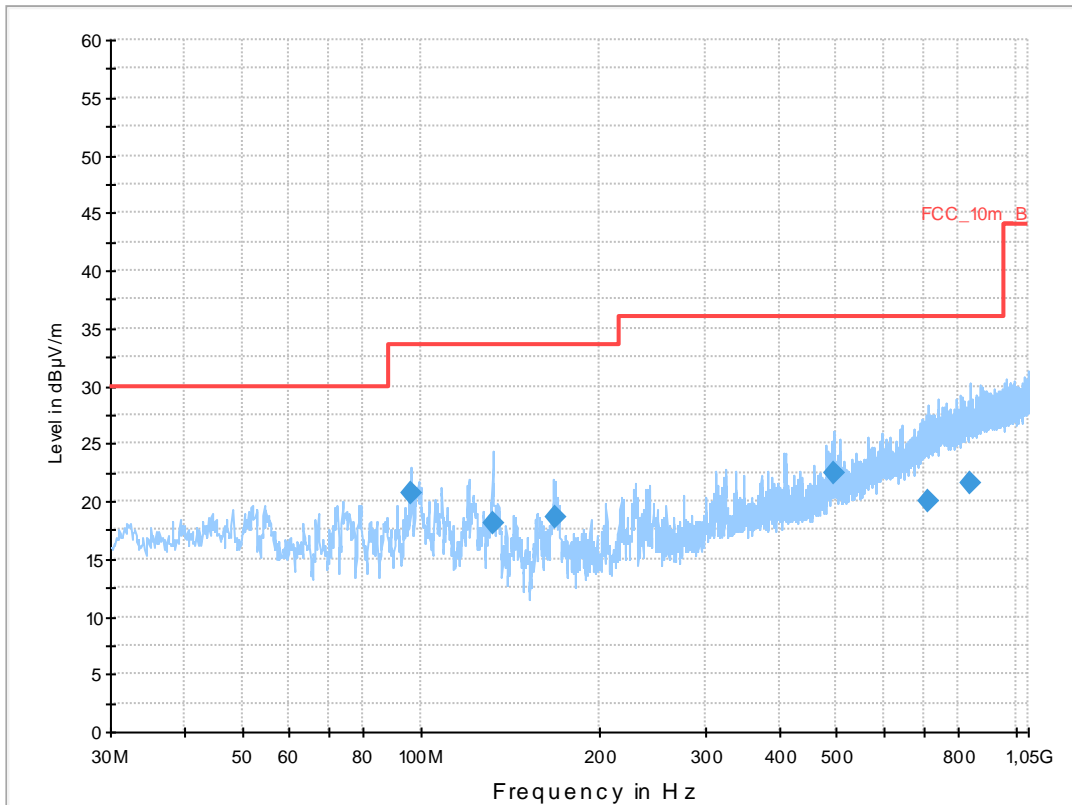

Final Result 1

Frequency (MHz)	QuasiPeak (dBµV/m)	Meas. Time (ms)	Bandwidth (kHz)	Height (cm)	Polarization	Azimuth (deg)	Corr. (dB)	Margin (dB)	Limit (dBµV/m)	Comment
96.117450	20.7	1000.0	120.000	100.0	V	140.0	11.4	12.8	33.5	
132.202650	18.0	1000.0	120.000	118.0	V	220.0	9.2	15.5	33.5	
168.096300	18.6	1000.0	120.000	130.0	V	277.0	9.7	14.9	33.5	
493.695000	22.4	1000.0	120.000	308.0	V	103.0	18.6	13.6	36.0	
712.551900	20.0	1000.0	120.000	100.0	H	246.0	22.8	16.0	36.0	
837.899550	21.6	1000.0	120.000	134.0	H	192.0	24.4	14.4	36.0	

Plot 6: Middle channel, 1 GHz to 12.75 GHz, vertical & horizontal polarization

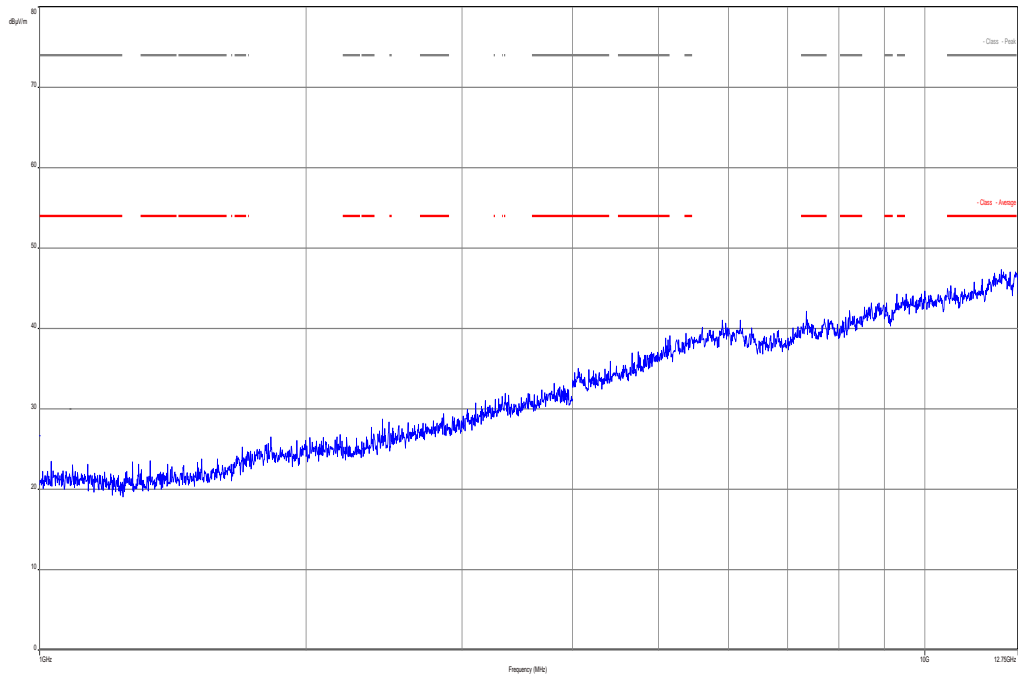

The carrier signal is notched with a 2.4 GHz band rejection filter.

Plot 7: Middle channel, 12 GHz to 18 GHz, vertical & horizontal polarization

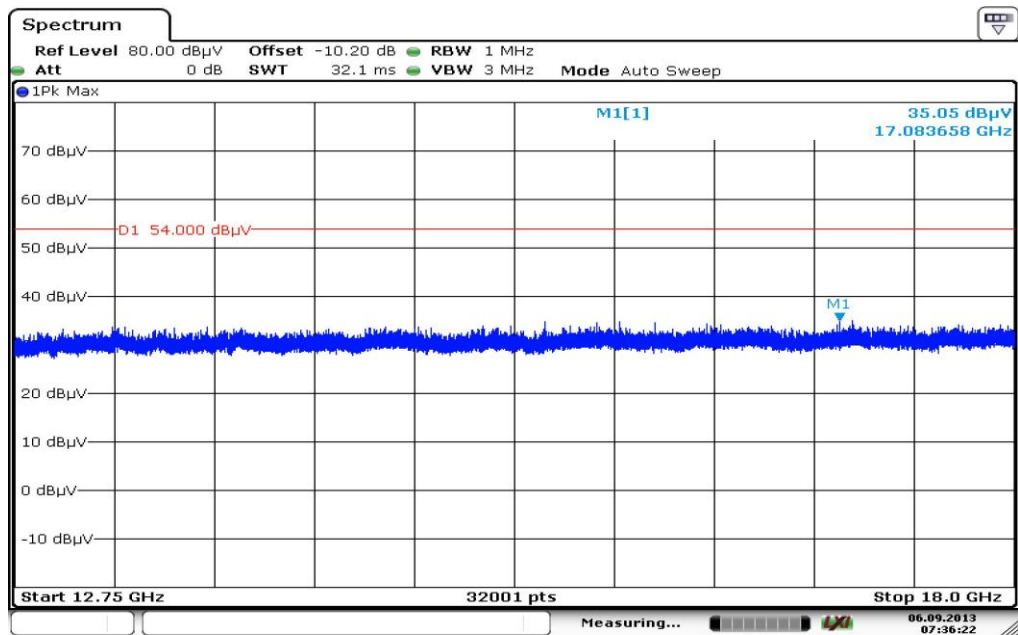

Date: 6.SEP.2013 07:36:22

Plot 8: Middle channel, 18 GHz to 26 GHz, vertical & horizontal polarization

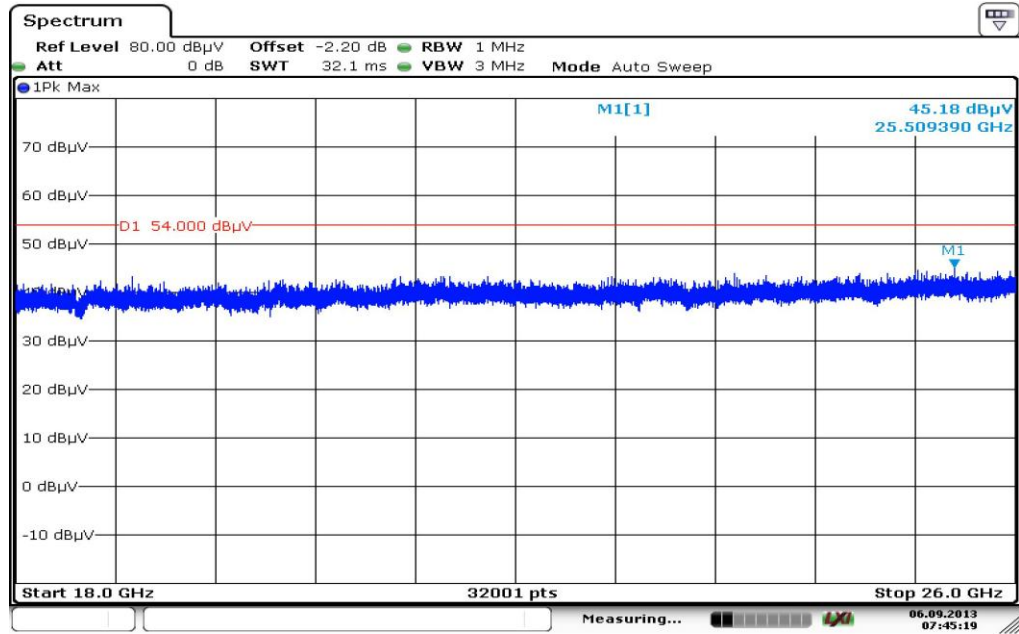

Date: 6.SEP.2013 07:45:19

Plot 9: Highest channel, 30 MHz to 1 GHz, vertical & horizontal polarization

Common Information

EUT: SSR Module BV3
 Serial Number: 1311 FT 318 000338
 Test Description: EN 55022 class B @ 10 m
 Operating Conditions: testmode CH26, Tx, -5dB
 Operator Name: Medrow
 Comment: USB 5V

Scan Setup: STAN_Fin [EMI radiated]

Hardware Setup: Electric Field (NOS)
 Receiver: [ESCI 3]
 Level Unit: dBµV/m

Subrange	Step Size	Detectors	IF BW	Meas. Time	Preamp
30 MHz - 2 GHz	60 kHz	QPK	120 kHz	1 s	20 dB

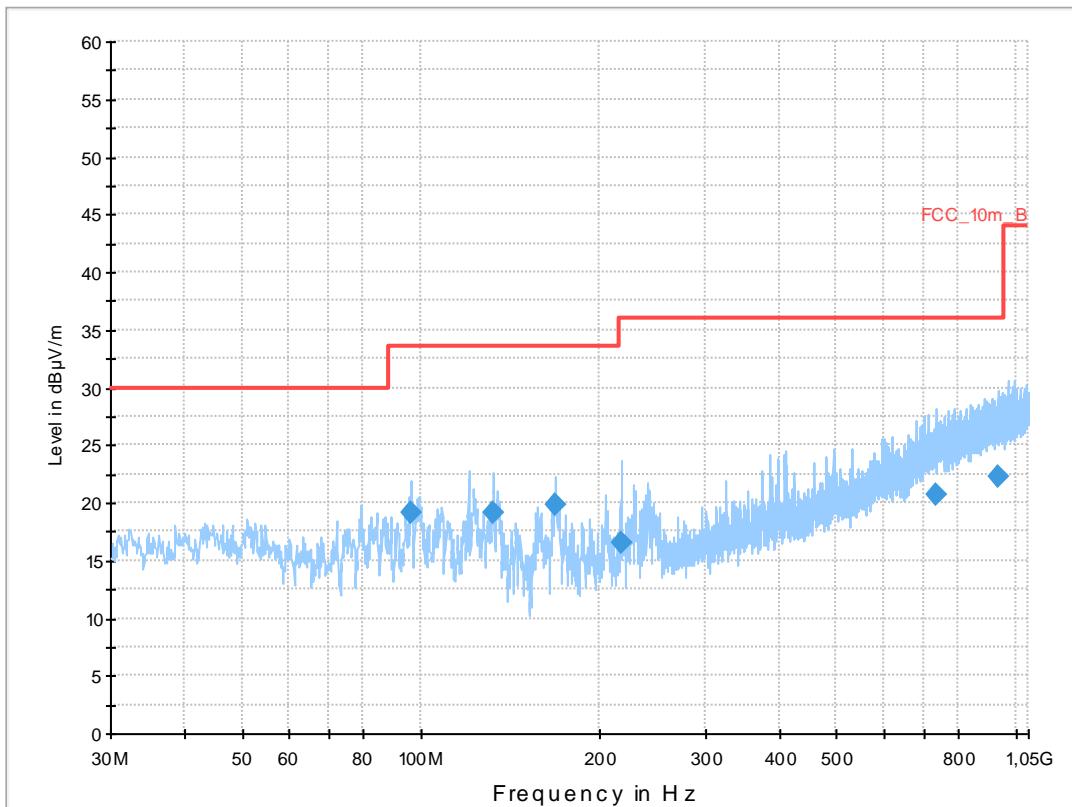

Final Result 1

Frequency (MHz)	QuasiPeak (dBµV/m)	Meas. Time (ms)	Bandwidth (kHz)	Height (cm)	Polarization	Azimuth (deg)	Corr. (dB)	Margin (dB)	Limit (dBµV/m)	Comment
96.177750	19.2	1000.0	120.000	98.0	V	190.0	11.4	14.3	33.5	
132.346950	19.1	1000.0	120.000	98.0	V	190.0	9.2	14.4	33.5	
168.277650	19.8	1000.0	120.000	105.0	V	280.0	9.7	13.7	33.5	
216.701850	16.5	1000.0	120.000	98.0	V	270.0	12.3	19.5	36.0	
733.001250	20.6	1000.0	120.000	170.0	V	190.0	23.3	15.4	36.0	
933.361200	22.3	1000.0	120.000	170.0	H	270.0	25.3	13.7	36.0	

Plot 10: Highest channel, 1 GHz to 12.75 GHz, vertical & horizontal polarization

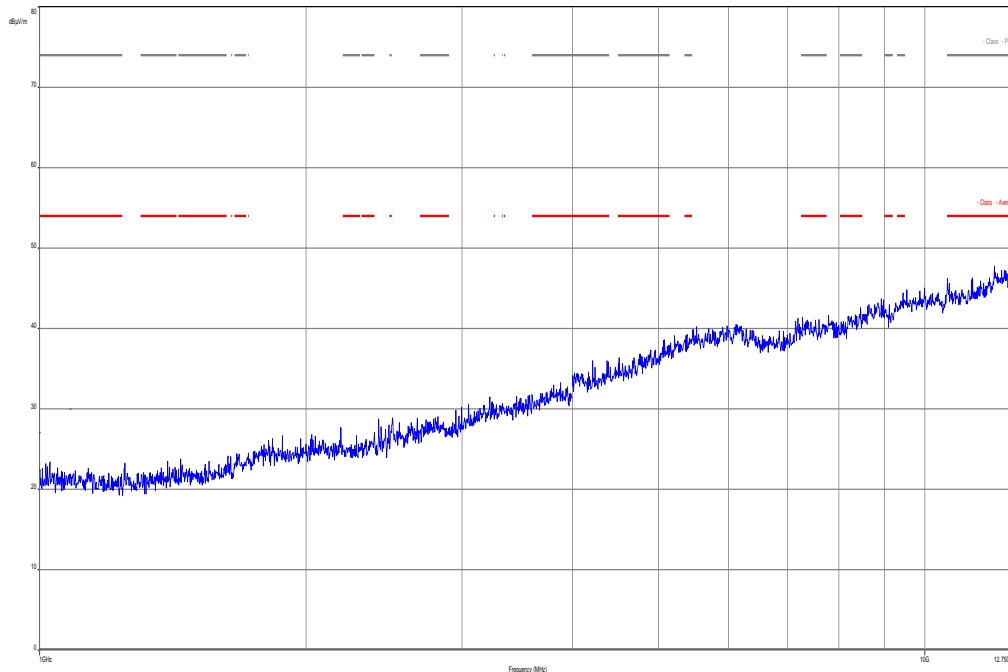

The carrier signal is notched with a 2.4 GHz band rejection filter.

Plot 11: Highest channel, 12 GHz to 18 GHz, vertical & horizontal polarization

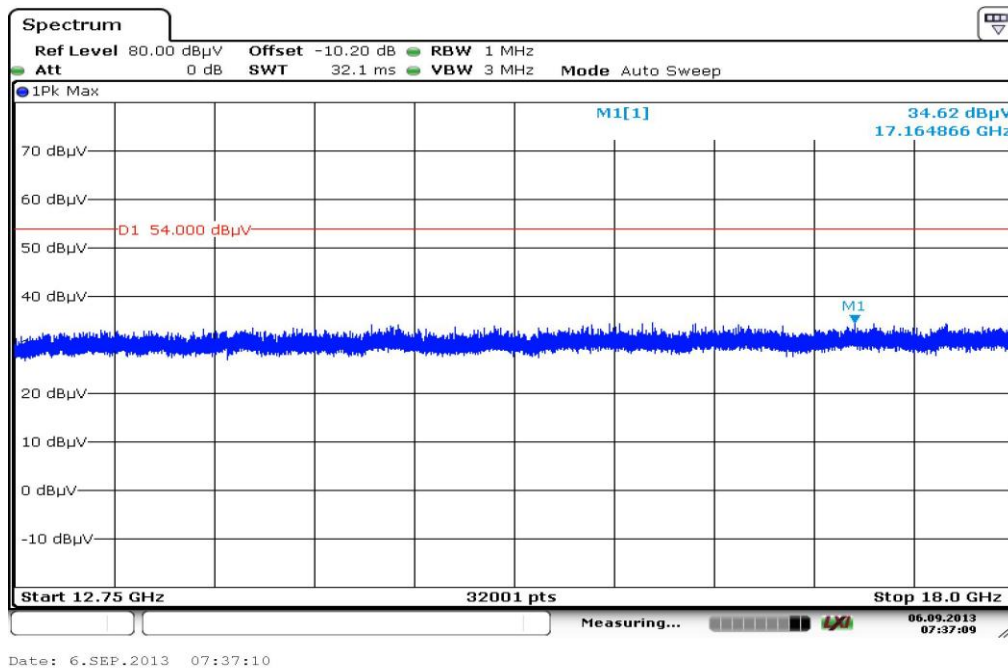

Plot 12: Highest channel, 18 GHz to 26 GHz, vertical & horizontal polarization

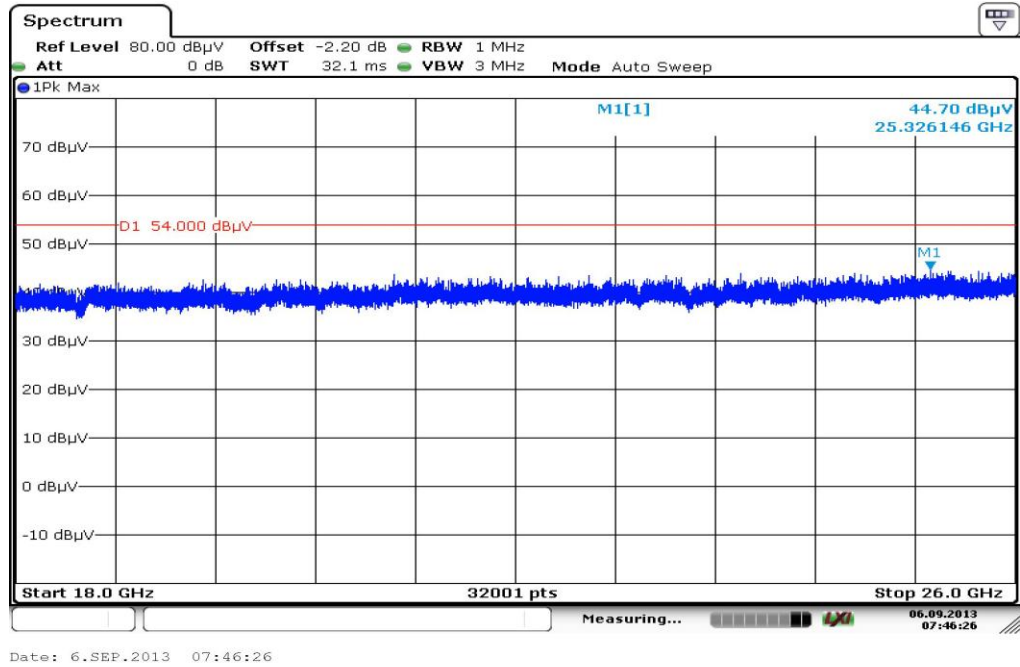

9.10 RX spurious emissions radiated

Description:

Measurement of the radiated spurious emissions in idle/receive mode. The results are valid for both modes.

Measurement:

Measurement parameter	
Detector:	Peak / Quasi Peak / RMS
Sweep time:	Auto
Resolution bandwidth:	F > 1 GHz: 1 MHz F < 1 GHz: 100 kHz
Video bandwidth:	Sweep: 100 kHz Remeasurement: 10 Hz / 3 MHz
Span:	30 MHz to 25 GHz
Trace-Mode:	Max Hold

Limits:

FCC		IC
RX Spurious Emissions Radiated		
Frequency (MHz)	Field Strength (dB μ V/m)	Measurement distance
30 - 88	30.0	10
88 – 216	33.5	10
216 – 960	36.0	10
Above 960	54.0	3

Results:

RX Spurious Emissions Radiated [dB μ V/m]		
F [MHz]	Detector	Level [dB μ V/m]
No critical peaks detected!		
Measurement uncertainty	± 3 dB	

Result: Passed

Plots: RX / Idle – mode

Plot 1: 30 MHz to 1 GHz, vertical & horizontal polarization

Common Information

EUT: SSR Module BV3
 Serial Number: 1311 FT 318 000338
 Test Description: FCC part 15 B class B @ 10 m
 Operating Conditions: testmode CH18, Rx
 Operator Name: Medrow
 Comment: USB 5V

Scan Setup: STAN_Fin [EMI radiated]

Hardware Setup: Electric Field (NOS)
 Receiver: [ESCI 3]
 Level Unit: dBµV/m

Subrange	Step Size	Detectors	IF BW	Meas. Time	Preamp
30 MHz - 2 GHz	60 kHz	QPK	120 kHz	1 s	20 dB

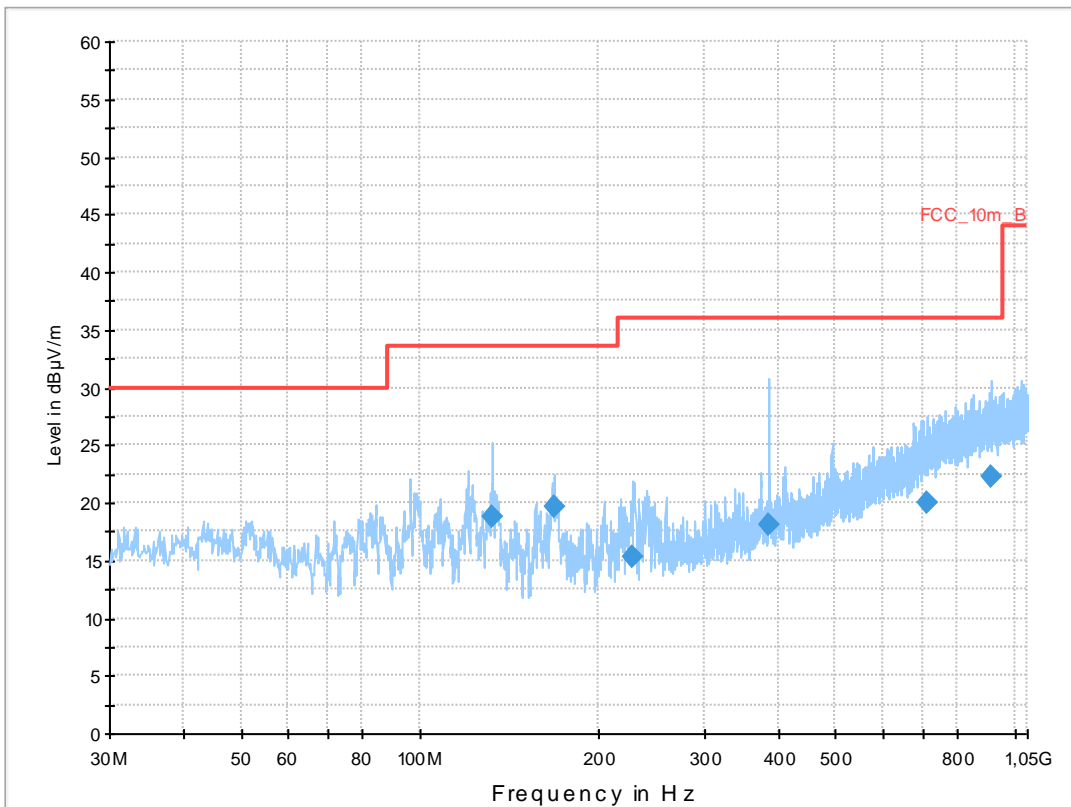

Final Result 1

Frequency (MHz)	QuasiPeak (dBµV/m)	Meas. Time (ms)	Bandwidth (kHz)	Height (cm)	Polarization	Azimuth (deg)	Corr. (dB)	Margin (dB)	Limit (dBµV/m)	Comment
132.194550	18.8	1000.0	120.000	133.0	V	265.0	9.2	14.7	33.5	
167.718150	19.7	1000.0	120.000	98.0	V	190.0	9.7	13.8	33.5	
228.378450	15.4	1000.0	120.000	170.0	V	266.0	12.7	20.6	36.0	
385.298250	18.2	1000.0	120.000	98.0	V	10.0	16.7	17.8	36.0	
712.342050	19.9	1000.0	120.000	170.0	H	261.0	22.8	16.1	36.0	
911.043450	22.3	1000.0	120.000	170.0	V	10.0	25.2	13.7	36.0	

Plot 2: 1 GHz to 12.75 GHz, vertical & horizontal polarization

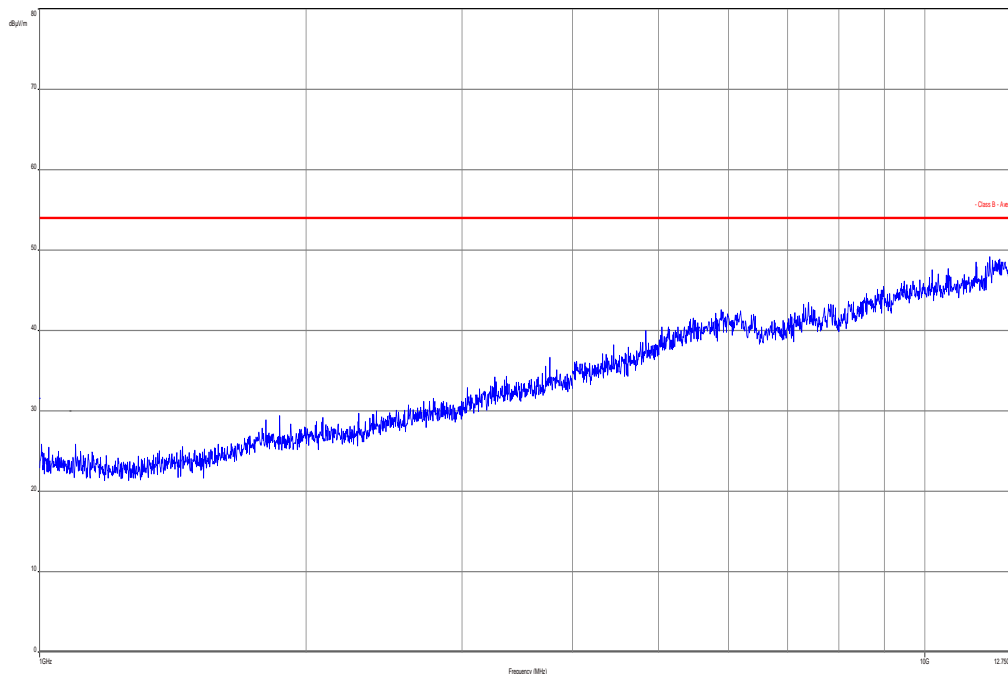

Plot 3: 12.75 GHz to 18 GHz, vertical & horizontal polarization

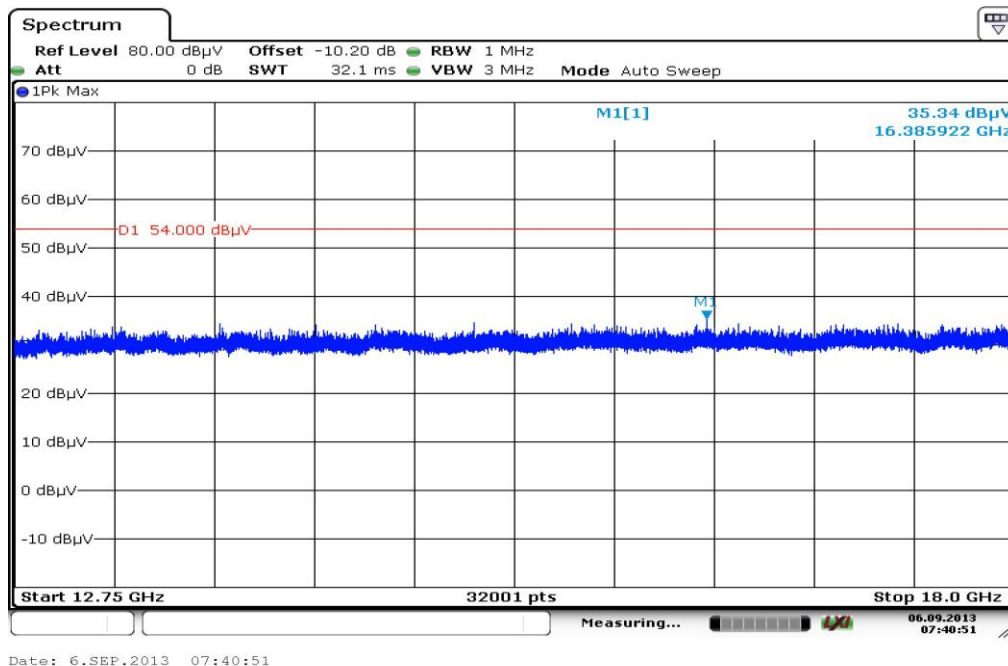

Plot 4: 18 GHz to 26 GHz, vertical & horizontal polarization

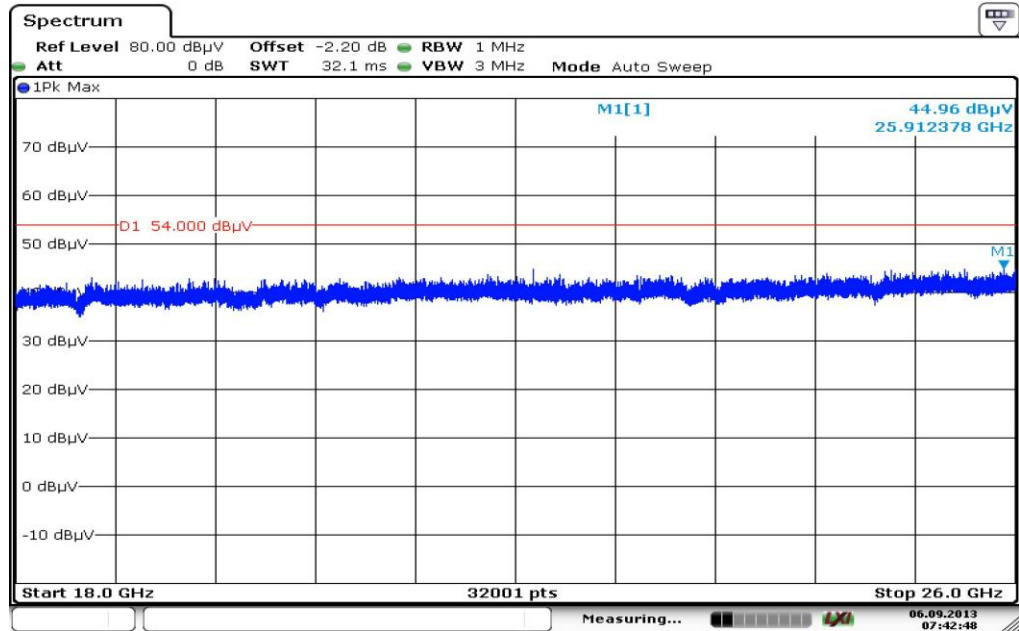

Date: 6.SEP.2013 07:42:49

9.11 TX spurious emissions radiated < 30 MHz

Description:

Measurement of the radiated spurious emissions in transmit mode below 30 MHz. The EUT is set to channel 39. This measurement is representative for all channels and modes. If critical peaks are found channel 00 and channel 78 will be measured too. The limits are recalculated to a measurement distance of 3 m with 40 dB/decade according CFR Part 2.

Measurement:

Measurement parameter	
Detector:	Peak / Quasi Peak
Sweep time:	Auto
Video bandwidth:	F < 150 kHz: 200 Hz F > 150 kHz: 9 kHz
Resolution bandwidth:	F < 150 kHz: 1 kHz F > 150 kHz: 100 kHz
Span:	9 kHz to 30 MHz
Trace-Mode:	Max Hold

Limits:

FCC		IC
TX Spurious Emissions Radiated < 30 MHz		
Frequency (MHz)	Field Strength (dBµV/m)	Measurement distance
0.009 – 0.490	2400/F(kHz)	300
0.490 – 1.705	24000/F(kHz)	30
1.705 – 30.0	30	30

Results:

TX Spurious Emissions Radiated < 30 MHz [dBµV/m]		
F [MHz]	Detector	Level [dBµV/m]
No critical peaks detected!		
Measurement uncertainty	± 3 dB	

Result: Passed

Plots: TX mode

Plot 1: 9 kHz to 30 MHz

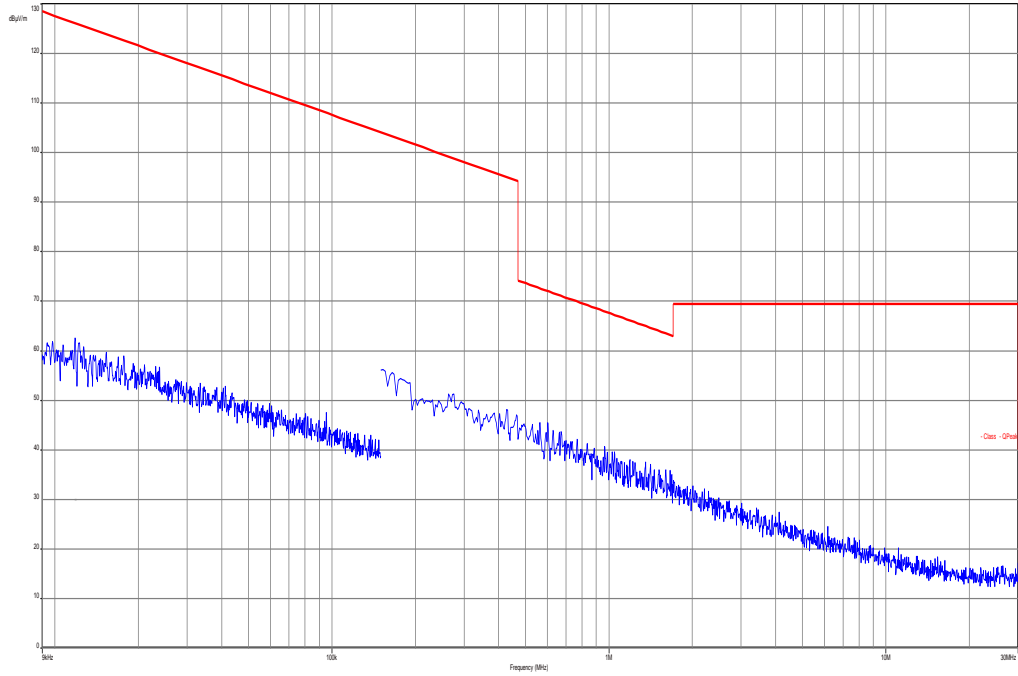

Plots: RX / Idle – mode

Plot 1: 9 kHz to 30 MHz

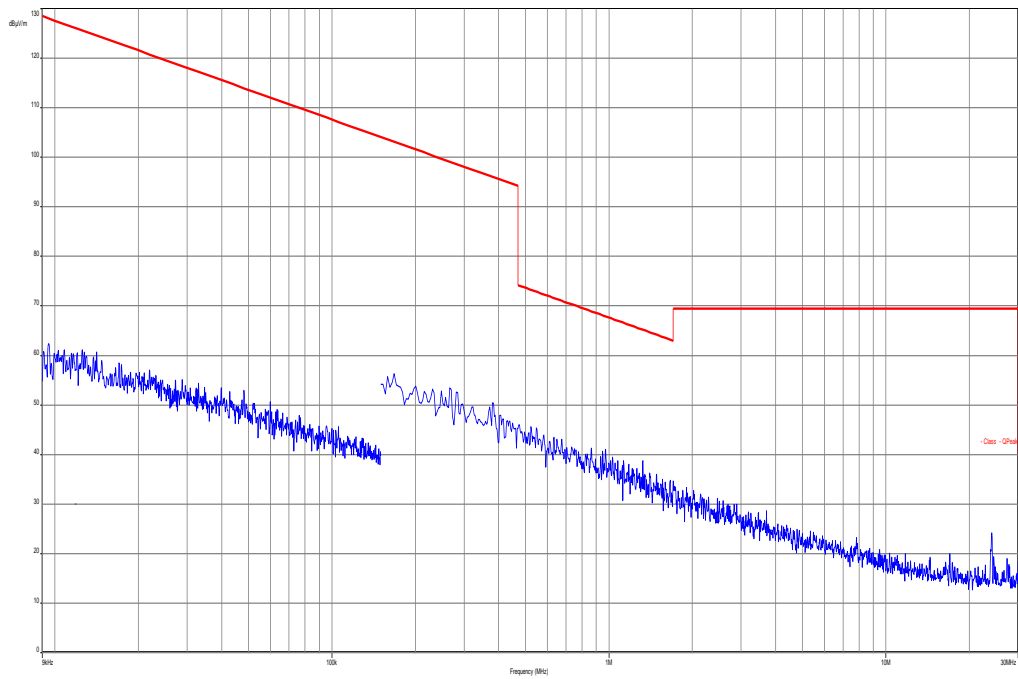

9.12 TX spurious emissions conducted < 30 MHz

Not applicable!

10 Test equipment and ancillaries used for tests

Typically, the calibrations of the test apparatus are commissioned to and performed by an accredited calibration laboratory. The calibration intervals are determined in accordance with the DIN EN ISO/IEC 17025. In addition to the external calibrations, the laboratory executes comparison measurements with other calibrated test systems or effective verifications. Weekly chamber inspections and range calibrations are performed. Where possible, rf-generating and signalling equipment as well as measuring receivers and analyzers are connected to an external high-precision 10 MHz reference (GPS-based or rubidium frequency standard).

In order to simplify the identification of the equipment used at some special tests, some items of test equipment and ancillaries can be provided with an identifier or number in the equipment list below (Labor/Item).

No.	Lab / Item	Equipment	Type	Manufact.	Serial No.	INV. No Cetecom	Kind of Calibration	Last Calibration	Next Calibration
1	n. a.	DC power supply, 60Vdc, 50A, 1200 W	6032A	HP Meßtechnik	2818A03450	300001040	Ve	12.01.2012	12.01.2015
2	n. a.	Double-Ridged Waveguide Horn Antenna 1-18.0GHz	3115	EMCO	8812-3088	300001032	vIKI!	08.05.2013	08.05.2015
3	n. a.	Anechoic chamber	FAC 3/5m	MWB / TDK	87400/02	300000996	ev		
4	n. a.	Switch / Control Unit	3488A	HP Meßtechnik	*	300000199	ne		
5	9	Artificial Mains 9 kHz to 30 MHz	ESH3-Z5	R&S	828576/020	300001210	Ve	06.01.2012	06.01.2014
6	n. a.	Switch / Control Unit	3488A	HP Meßtechnik	2719A15013	300001156	ne		
7	9	Isolating Transformer	MPL IEC625 Bus Regeltrennt ravo	Erfi	91350	300001155	ne		
8	n. a.	Three-Way Power Splitter, 50 Ohm	11850C	HP Meßtechnik		300000997	ne		
9	90	Active Loop Antenna 10 kHz to 30 MHz	6502	Kontron Psychotech	8905-2342	300000256	k	13.06.2013	13.06.2015
10	n. a.	Amplifier	js42-00502650-28-5a	Parzich GMBH	928979	300003143	ne		
11	n. a.	Band Reject filter	WRCG185 5/1910-1835/1925-40/8SS	Wainwright	7	300003350	ev		
12	n. a.	Band Reject filter	WRCG240 0/2483-2375/2505-50/10SS	Wainwright	11	300003351	ev		
13	n. a.	Highpass Filter	WHKX7.0/1 8G-8SS	Wainwright	18	300003789	ne		
14	n. a.	TRILOG Broadband Test-Antenna 30 MHz - 3 GHz	VULB9163	Schwarzbeck	371	300003854	vIKI!	14.10.2011	14.10.2014
15	n. a.	MXE EMI Receiver 20 Hz bis 26,5 GHz	N9038A	Agilent Technologies	MY51210197	300004405	k	21.02.2013	21.02.2014
16	11b	Microwave System Amplifier, 0.5-26.5 GHz	83017A	HP Meßtechnik	00419	300002268	ev		
17	A025	Std. Gain Horn Antenna 12.4 to 18.0 GHz	639	Narda		300000786	ne		
18	A027	Std. Gain Horn Antenna 18.0 to 26.5 GHz	638	Narda		300000486	ne		
19	n. a.	Spectrum Analyzer 9kHz to 30GHz - 140..+30dBm	FSP30	R&S	100886	300003575	k	22.08.2012	22.08.2014

20	n. a.	Signal Analyzer 40 GHz	FSV40	R&S	101042	300004517	k	22.10.2012	22.10.2013
----	-------	---------------------------	-------	-----	--------	-----------	---	------------	------------

Agenda: Kind of Calibration

k	calibration / calibrated	EK	limited calibration
ne	not required (k, ev, izw, zw not required)	zw	cyclical maintenance (external cyclical maintenance)
ev	periodic self verification	izw	internal cyclical maintenance
Ve	long-term stability recognized	g	blocked for accredited testing
vkl!	Attention: extended calibration interval		
NK!	Attention: not calibrated	*)	next calibration ordered / currently in progress

11 Observations

No observations exceeding those reported with the single test cases have been made.

Annex A Document history

Version	Applied changes	Date of release
1.0	Initial release	2013-10-17
-A	Additional information and editorial changes	2013-10-16

Annex B Further information**Glossary**

AVG	-	Average
DUT	-	Device under test
EMC	-	Electromagnetic Compatibility
EN	-	European Standard
EUT	-	Equipment under test
ETSI	-	European Telecommunications Standard Institute
FCC	-	Federal Communication Commission
FCC ID	-	Company Identifier at FCC
HW	-	Hardware
IC	-	Industry Canada
Inv. No.	-	Inventory number
N/A	-	Not applicable
PP	-	Positive peak
QP	-	Quasi peak
S/N	-	Serial number
SW	-	Software

Annex C Accreditation Certificate

Front side of certificate

Deutsche Akkreditierungsstelle GmbH
 Bellehene gemäß § 8 Absatz 1 AkkStelleG i.V.m. § 1 Absatz 1 AkkStelleGBV
 Unterzeichnerin der Multilateralen Abkommen
 von EA, ILAC und IAF zur gegenseitigen Anerkennung

Akkreditierung

Die Deutsche Akkreditierungsstelle GmbH bestätigt hiermit, dass das Prüflaboratorium
CETECOM ICT Services GmbH
 Untertürkheimer Straße 6-10, 66117 Saarbrücken

die Kompetenz nach DIN EN ISO/IEC 17025:2005 besitzt, Prüfungen in folgenden Bereichen durchzuführen:

- Drahtgebundene Kommunikation einschließlich xDSL
- VoIP und DECT
- Akustik
- Funk einschließlich WLAN
- Short Range Devices (SRD)
- RFID
- WiMax und Richtfunk
- Mobilfunk (GSM / DCS, Over the Air (OTA) Performance)
- Elektromagnetische Verträglichkeit (EMV) einschließlich Automotive
- Produktsicherheit
- SAR und Hearing Aid Compatibility (HAC)
- Umweltsimulation
- Smart Card Terminals
- Bluetooth
- Wi-Fi-Services

Die Akkreditierungsurkunde gilt nur in Verbindung mit dem Bescheid vom 18.01.2013 mit der Akkreditierungsnummer D-PL-12076-01 und ist gültig 17.01.2018. Sie besteht aus diesem Deckblatt, der Rückseite des Deckblatts und der folgenden Anlage mit insgesamt 80 Seiten.

Registrierungsnummer der Urkunde: D-PL-12076-01-01

Frankfurt am Main, 18.01.2013

Im Auftrag
 Dr. Ingrid Pflüger
 Abteilungsleiter

Siehe Hinweise auf der Rückseite

Back side of certificate

Deutsche Akkreditierungsstelle GmbH

Standort Berlin Spittelmarkt 10 10117 Berlin	Standort Frankfurt am Main Gartenstraße 6 60594 Frankfurt am Main	Standort Braunschweig Rundesallee 100 38116 Braunschweig
--	---	--

Die auszugsweise Veröffentlichung der Akkreditierungsurkunde bedarf der vorherigen schriftlichen Zustimmung der Deutsche Akkreditierungsstelle GmbH (DAkkS). Ausgenommen davon ist die separate Weiterverbreitung des Deckblattes durch die umseitig genannte Konformitätsbewertungsstelle in unveränderter Form.

Es darf nicht der Anschein erweckt werden, dass sich die Akkreditierung auch auf Bereiche erstreckt, die über den durch die DAkkS bestätigten Akkreditierungsbereich hinausgehen.

Die Akkreditierung erfolgte gemäß des Gesetzes über die Akkreditierungsstelle (AkkStelleG) vom 31. Juli 2009 (BGBl. I S. 2625) sowie der Verordnung (EG) Nr. 765/2008 des Europäischen Parlaments und des Rates vom 9. Juli 2008 über die Vorschriften für die Akkreditierung und Marktüberwachung im Zusammenhang mit der Vermarktung von Produkten (AbL L 218 vom 9. Juli 2008, S. 30). Die DAkkS ist Unterzeichnerin der Multilateralen Abkommen zur gegenseitigen Anerkennung der European co-operation for Accreditation (EA), des International Accreditation Forum (IAF) und der International Laboratory Accreditation Cooperation (ILAC). Die Unterzeichner dieser Abkommen erkennen ihre Akkreditierungen gegenseitig an.

Der aktuelle Stand der Mitgliedschaft kann folgenden Webseiten entnommen werden:
 EA: www.european-accreditation.org
 ILAC: www.ilac.org
 IAF: www.iaf.nu

Note:

The current certificate including annex is published on our website (see link below) or may be received from CETECOM ICT Services on request.

<http://www.cetecom.com/eu/de/cetecom-group/europa/deutschland-saarbruecken/akkreditierungen.html>