



INSTRUCTIONS FOR USE

IntelliVue MP2

Patient Monitor

Release G.0 with Software Revision G.0x.xx

Patient Monitoring

PHILIPS

Printed in Germany 09/08



Part Number M8102-9001B
4512 610 28821



Table Of Contents

1 Installation		1
<hr/>		
Installation Checklist	1	
Unpacking and Checking the Shipment	2	
Mounting the Monitor	3	
Mounting the External Power Supply (M8023A)	3	
Connecting the Monitor to AC Mains	3	
Checking Out the Monitor	5	
Operating the Monitor	6	
Setting the Date and Time	7	
Checking Country-Specific Default Settings	7	
Handing Over the Monitor	7	
2 Basic Operation		9
<hr/>		
Introducing the IntelliVue MP2	10	
Controls, Indicators and Connectors	10	
Extending Measurements	13	
Operating and Navigating	16	
Operating Modes	22	
Understanding Screens	23	
Using the XDS Remote Display	24	
Using the Visitor Screen	24	
Understanding Profiles	25	
Understanding Settings	26	
Changing Measurement Settings	27	
Switching a Measurement On and Off	27	
Adjusting a Measurement Wave	27	
Using Labels	28	
Changing Monitor Settings	30	
Checking Your Monitor Revision	30	
Getting Started	31	
Disconnecting from AC Mains Power	32	
Monitoring After a Power Failure	32	
Networked Monitoring	32	
Capturing Alarm Reports and Printing	33	
3 What's New?		35
<hr/>		
What's New in Release G.0?	35	
What's New in Release F.0?	36	
4 Alarms		39
<hr/>		
Visual Alarm Indicators	40	
Audible Alarm Indicators	41	
Acknowledging Alarms	42	

Pausing or Switching Off Alarms	43	
Alarm Limits	45	
Reviewing Alarms	49	
Latching Alarms	50	
Testing Alarms	51	
Alarm Behavior at On/Off	51	
Alarm Recordings	51	
5 Patient Alarms and INOPs		53
Patient Alarm Messages	53	
Technical Alarm Messages (INOPs)	59	
6 Managing Patients		83
Admitting a Patient	83	
Quick Admitting a Patient	85	
Editing Patient Information	85	
Discharging a Patient	85	
Transferring Patients	86	
7 ECG, Arrhythmia, ST and QT Monitoring		89
Skin Preparation for Electrode Placement	89	
Connecting ECG Cables	89	
Selecting the Primary and Secondary ECG Leads	90	
Checking Paced Status	90	
Understanding the ECG Display	91	
Monitoring Paced Patients	92	
Changing the Size of the ECG Wave	93	
Changing the Volume of the QRS Tone	94	
Changing the ECG Filter Settings	94	
Selecting Positions of Va and Vb Chest Leads (for 6-lead placement)	95	
Choosing EASI or Standard Lead Placement	95	
About ECG Leads	95	
ECG Lead Fallback	96	
ECG Lead Placements	96	
Capture 12-Lead	100	
EASI ECG Lead Placement	101	
ECG and Arrhythmia Alarm Overview	102	
Using ECG Alarms	103	
ECG Safety Information	104	
About Arrhythmia Monitoring	105	
Switching Arrhythmia Analysis On and Off	106	
Choosing an ECG Lead for Arrhythmia Monitoring	106	
Understanding the Arrhythmia Display	107	
Arrhythmia Relearning	110	
Arrhythmia Alarms	111	
About ST Monitoring	117	

Switching ST On and Off	117	
Understanding the ST Display and Windows	118	
Updating ST Baseline Snippets	119	
About the ST Measurement Points	120	
ST Alarms	122	
Viewing ST Maps	122	
About QT/QTc Interval Monitoring	127	
QT Alarms	130	
Switching QT Monitoring On and Off	131	
8 Monitoring Pulse Rate		133
<hr/>		
Entering the Setup Pulse Menu	133	
System Pulse Source	133	
Switching Pulse On and Off	134	
Using Pulse Alarms	134	
9 Monitoring Respiration Rate (Resp)		137
<hr/>		
Lead Placement for Monitoring Resp	137	
Understanding the Resp Display	138	
Changing Resp Detection Modes	138	
Changing the Size of the Respiration Wave	139	
Changing the Speed of the Respiration Wave	140	
Using Resp Alarms	140	
Changing the Apnea Alarm Delay	140	
Resp Safety Information	140	
10 Monitoring SpO₂		143
<hr/>		
SpO ₂ Sensors	143	
Applying the Sensor	143	
Connecting SpO ₂ Cables	144	
Measuring SpO ₂	144	
SpO ₂ Signal Quality Indicator (Fast SpO ₂ only)	145	
Assessing a Suspicious SpO ₂ Reading	145	
Changing the Averaging Time	146	
Setting the Measurement Mode	146	
Understanding SpO ₂ Alarms	146	
Pleth Wave	147	
Perfusion Numeric	148	
Perfusion Change Indicator	148	
Setting SpO ₂ /Pleth as Pulse Source	148	
Setting Up Tone Modulation	148	
Setting the QRS Volume	149	
11 Monitoring NBP		151
<hr/>		
Introducing the Oscillometric NBP Measurement	151	
Preparing to Measure NBP	152	

Starting and Stopping Measurements	154
Enabling Automatic Mode and Setting Repetition Time	154
Enabling Sequence Mode and Setting Up The Sequence	154
Choosing the NBP Alarm Source	154
Switching Pulse from NBP On/Off	155
Assisting Venous Puncture	155
Calibrating NBP	156
12 Monitoring Temperature	157
Making a Temp Measurement	157
Calculating Temp Difference	158
13 Monitoring Invasive Pressure	159
Setting up the Pressure Measurement	159
Zeroing the Pressure Transducer	161
Adjusting the Calibration Factor	162
Displaying a Mean Pressure Value Only	162
Changing the Pressure Wave Scale	163
Optimizing the Waveform	163
Non-Physiological Artifact Suppression	163
Choosing the Pressure Alarm Source	163
Calibrating Reusable Transducer CPJ840J6	165
Calculating Cerebral Perfusion	166
14 Monitoring Carbon Dioxide	167
Measuring CO ₂ using the CO ₂ Option or M3014A	168
Measuring Mainstream CO ₂ using M3016A	171
Measuring Microstream CO ₂ using M3015A	173
Setting up all CO ₂ Measurements	174
15 Assigning Two Devices to One Patient	177
How Can You Combine Devices?	177
Functions Available When the Telemetry Data Window is Displayed	181
Functions Available For Devices Connected Via SRR	182
General Telemetry-related Functions	182
16 Enhancing Telemetry Monitoring with the Monitor	185
17 Trends	187
Viewing Trends	187
Setting Up Trends	189
Documenting Trends	192
Trends Databases	192
Screen Trends	193

18 Recording	199
Starting and Stopping Recordings	199
Overview of Recording Types	200
Creating and Changing Recordings Templates	200
Recorder Status Messages	201
19 Printing Patient Reports	203
Starting Report Printouts	203
Stopping Reports Printouts	204
Setting Up Reports	204
Setting Up Individual Print Jobs	205
Checking Printer Settings	206
Printing a Test Report	206
Switching Printers On Or Off for Reports	206
Dashed Lines on Reports	207
Unavailable Printer: Re-routing Reports	207
Checking Report Status and Printing Manually	207
Printer Status Messages	208
Sample Report Printouts	209
20 Care and Cleaning	213
General Points	213
Cleaning the Monitor	214
Disinfecting the Monitor	214
Sterilizing the Monitor	214
Cleaning, Sterilizing and Disinfecting Monitoring Accessories	215
Cleaning Batteries and the Battery Compartment	215
21 Using Batteries	217
Battery Power Indicators	218
Checking Battery Charge	220
Replacing a Battery	220
Optimizing Battery Performance	221
Battery Safety Information	222
22 Maintenance and Troubleshooting	225
Inspecting the Equipment and Accessories	225
Inspecting the Cables and Cords	225
Maintenance Task and Test Schedule	226
Troubleshooting	227
Disposing of the Monitor	227
Disposing of Empty Calibration Gas Cylinders	227
23 Accessories	229
ECG/Resp Accessories	229
NBP Accessories	233

Invasive Pressure Accessories	234
SpO ₂ Accessories	235
Temperature Accessories	239
Mainstream CO ₂ Accessories	239
Sidestream CO ₂ Accessories	240
Mainstream CO ₂ Accessories (for M3016A)	240
Microstream CO ₂ Accessories	240
Battery Accessories	241

24 Specifications

243

Intended Use	243
Manufacturer's Information	244
Symbols	244
Installation Safety Information	246
Altitude Setting	246
Monitor Safety Specifications	246
EMC And Radio Regulatory Compliance	247
Out-Of-Hospital Transport - Standards Compliance	248
Monitor Performance Specifications	251
M4607A Battery Specifications	254
Measurement Specifications	255
Safety and Performance Tests	267

25 Default Settings Appendix

271

Country-Specific Default Settings	271
Alarm and Measurement Default Settings	277
Alarm Default Settings	277
ECG, Arrhythmia, ST and QT Default Settings	278
Pulse Default Settings	281
Respiration Default Settings	281
SpO ₂ Default Settings	282
NBP Default Settings	283
Temperature Default Settings	283
Invasive Pressure Default Settings	283
CO ₂ Default Settings	286

Installation

Installation should be carried out by qualified service personnel, either by the hospital's biomedical department, or by Philips Support.

If you have purchased a "customer-installable bundle", it is assumed that your own hospital personnel will install and, if necessary, configure the monitor. You can contact Philips Support for assistance if required; any assistance will be associated with additional costs.

For mechanical and electrical installation, you need technically qualified personnel with a knowledge of english. Additionally, for monitor configuration, you need clinically qualified personnel with a knowledge of the use environment. For further information on Installation, refer to the *Service Guide*.

-
- WARNING**
- Monitor configuration settings must be specified by authorized hospital personnel.
 - For installation of the device as part of a system, always refer to the *Service Guide*.
 - As the first step in preparing the monitor for use, follow the installation instructions given in this chapter.
-

Installation Checklist

Use this checklist to document your installation.

Step	Task	Check Box when Task Done
1	Perform initial inspection of delivery, unpack and check the shipment (see "Unpacking and Checking the Shipment" on page 2).	<input type="checkbox"/>
2	Mount the monitor as appropriate for your installation (see "Mounting the Monitor" on page 3).	<input type="checkbox"/>
3	Insert the battery into the battery compartment (the battery must always be in the battery compartment during use). Connect the monitor to AC mains via the external power supply using the supplied power cord (see "Connecting the Monitor to AC Mains" on page 3).	<input type="checkbox"/>
4	Perform Visual, Power On and Functional test blocks (see "Checking Out the Monitor" on page 5).	<input type="checkbox"/>
5	Perform Safety Tests, if required by local laws and regulations (see "Checking Out the Monitor" on page 5).	<input type="checkbox"/>

Step	Task	Check Box when Task Done
6	Check/set the time and date (see “Setting the Date and Time” on page 7).	<input type="checkbox"/>
7	Check that the country-specific default settings are appropriate (see “Checking Country-Specific Default Settings” on page 7)	<input type="checkbox"/>
8	Perform System Test as necessary (see the <i>Service Guide</i>)	<input type="checkbox"/>

Unpacking and Checking the Shipment

The monitor and any supporting options ordered are supplied packed in protective shipping cartons.

Initial Inspection

Before unpacking, check the packaging and ensure that there are no signs of mishandling or damage.

Open the package carefully and remove the monitor and accessories.

Check that the contents are complete and that the correct options and accessories have been delivered.

System Components, Accessories and Supplies	Comments
Monitor with options as ordered	1
ECG accessories	optional
NBP accessories	optional
SpO ₂ accessories	optional
Pressure accessories	optional
Temperature accessories	optional
CO ₂ Accessories	optional
External Power Supply including AC power cord and MSL cable	1
Rechargeable battery	1
Instructions for Use	1
Quick Guide	1
Documentation CD-ROM (includes Service Guide and Instructions for Use)	1

Claims for Damage

If the shipping cartons are damaged, contact the carrier.

If any of the equipment is damaged, contact both the carrier and your local Philips service organization for repair or replacement arrangements.

Repacking

Retain the original packing carton and material, in case you need to return equipment to Philips for service. If you no longer have the original packing materials, Philips can advise you on alternatives.

Mounting the Monitor

The monitor can be rested on a flat, level surface, hung on the bed rail, or mounted on a wall or on a rollstand. See the *Service Guide* for details.

Mounting the External Power Supply (M8023A)

The external power supply (M8023A) can be rested on its rubber feet on a flat, level surface, or mounted as described in the *Service Guide*.

The following pictures show examples of correct (☺) and incorrect (☹) ways to mount the power supply.

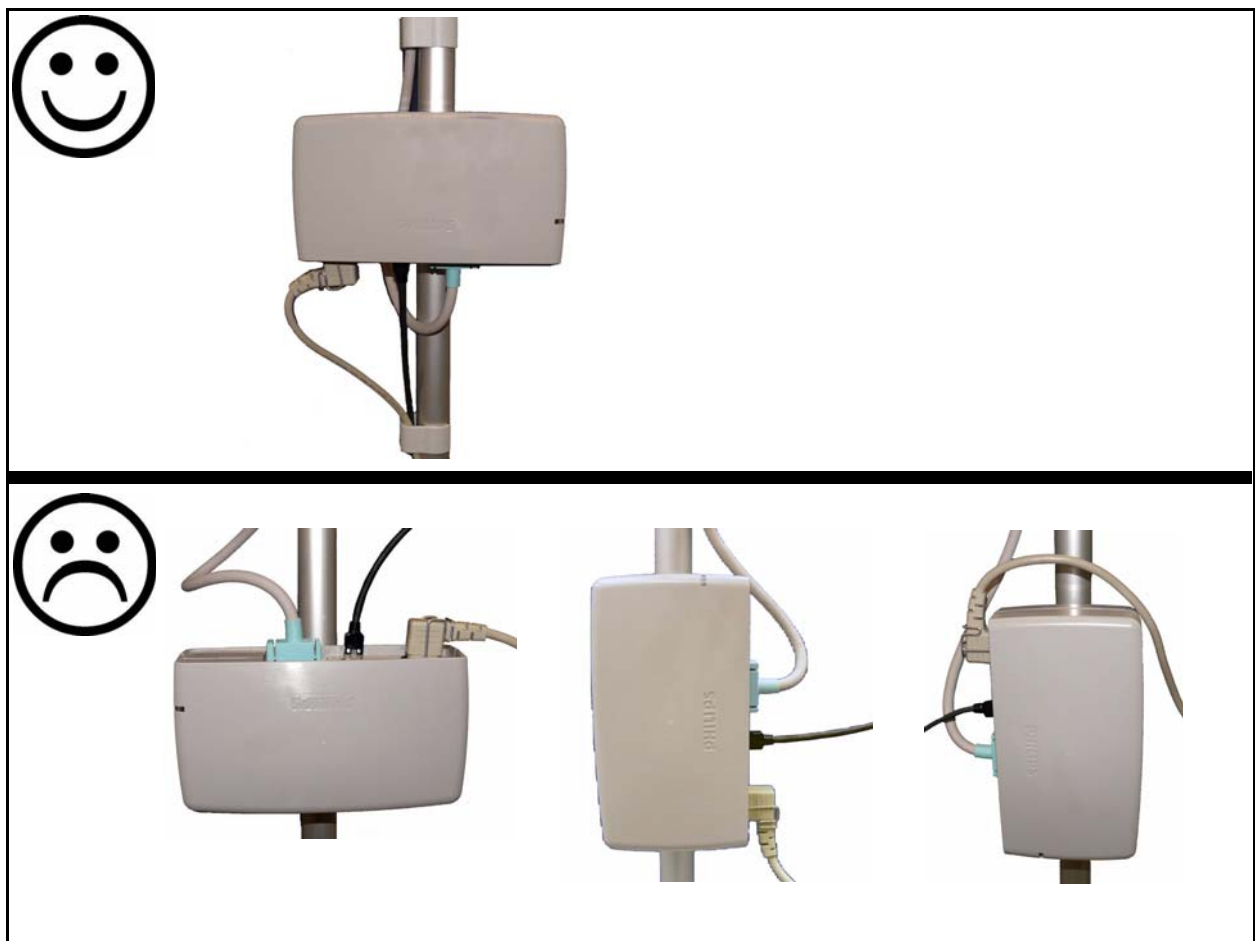

Connecting the Monitor to AC Mains

The monitor is an electrical Class II device in which the protection against electric shock does not rely on basic insulation and a protective earth conductor but on double and/or reinforced insulation.

The monitor has a wide-range external power supply (M8023A) that allows you to operate the monitor from an AC (alternating current) power source of 100 V to 240 V ($\pm 10\%$) and 50/60 Hz ($\pm 5\%$). The external power supply also charges the monitor's battery.

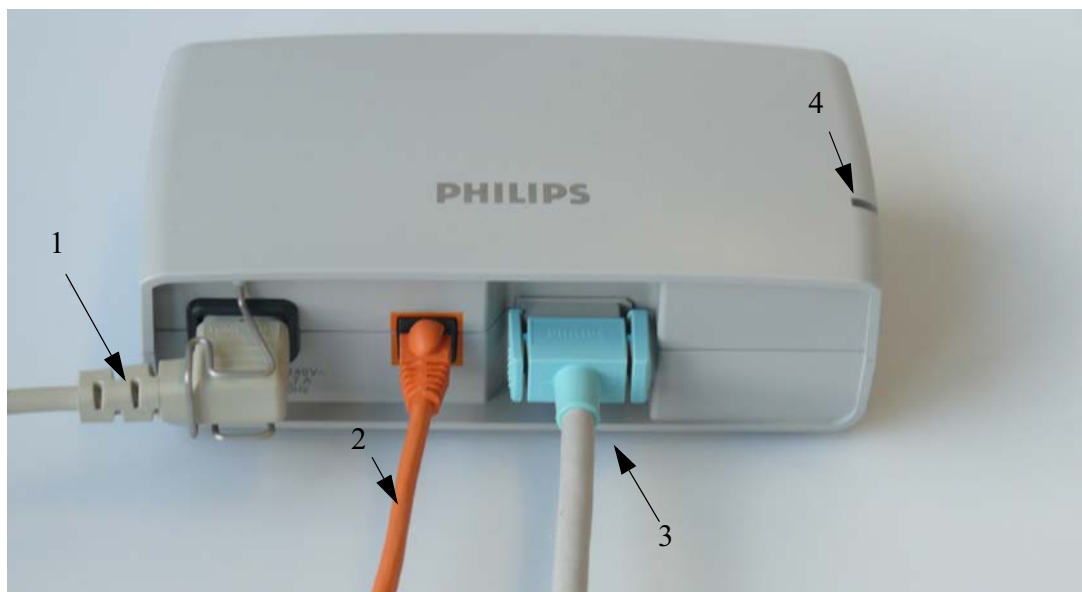

1	AC power cord. Connect to AC mains socket.
2	Connect LAN cable here. For connection to a PC or Information Center.
3	Measurement Link (MSL) cable. Supplies AC input power to the monitor for AC operation and for battery charging. When there is a LAN connection to a PC or Information Center, the MSL cable also carries this data to and from the monitor.
4	Power-on LED. The green light is on when the external power supply is connected to AC mains.

- WARNING**
- Always use the supplied power cord with the earthed mains plug to connect the external power supply (M8023A) to an earthed AC mains socket. Never adapt the mains plug from the power supply to fit an unearthed AC mains socket.

- Do not use AC mains extension cords or multiple portable socket-outlets. If a multiple portable socket-outlet without an approved isolation transformer is used, the interruption of its protective earthing may result in enclosure leakage currents equal to the sum of the individual earth leakage currents, so exceeding allowable limits.
- Do not connect any devices that are not supported as part of a system.
- Any non-medical device placed and operated in the patient's vicinity must be powered via an approved isolation transformer that ensures mechanical fixing of the power cords and covering of any unused power outlets.

Checking Out the Monitor

The following table defines which tests and inspections need to be performed, and when they are required.

Test	Test or Inspection to be Performed
Visual	Inspect the monitor, measurement accessories and cables for any damage. Are they free of damage?
Power On	Power on the monitor. Does it start up successfully without errors? Do all alarm lamps light up during power up? After start up, the monitor sounds a tone, and you can see the monitoring main screen (normally with measurement wave channels and numeric positions).
Functionality Test	After power up, touch the battery status indicator in the bottom right of the screen. The battery status window should open. Press the blue Main Screen key to close the window and return to the main screen.
Safety Tests (1) to (4)	Perform safety tests (1) to (4), as described in the <i>Service Guide</i> , for standalone devices if required by local laws and regulations, and each time you combine equipment to form a system, or exchange system components. Details of the safety tests and procedures are described in the <i>Service Guide</i> . These safety tests are derived from international standards but may not always be sufficient to meet local requirements.
System	Perform the system test according to IEC 60601-1-1, if applicable, after combining equipment to form a system (see the <i>Service Guide</i>).

For test and inspection information regarding repairs, upgrades and all other service events, refer to the *Service Guide*.

Operating the Monitor

To complete installation you will need to operate the monitor to check basic functionality. Here is a quick introduction to the monitor.



1 Switch on the monitor. After start-up the monitor display will become active. You operate the monitor using the touch screen.



2 Touch something on the screen (numerics, waves, other screen items) to enter the corresponding menu. Touching the NBP numeric, for example, brings you to the Setup NBP menu.



3 Touch again to select an item on the menu and work through the menu activities.

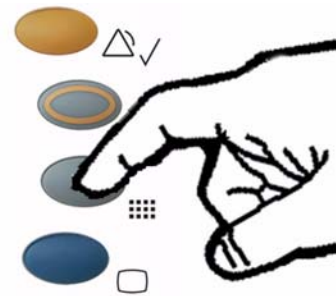

4 To access SmartKeys, press the SmartKeys key. **Main Setup** is one of the SmartKeys.



5 If you cannot find a menu by touching the screen you can always use the **Main Setup** SmartKey which will get you to all menus on the monitor.



6 Press the Main Screen key to close all open menus/windows and return to the main screen. Press again to enter the **Change Screen** window, where you can choose from a number of pre-configured screens.

Setting the Date and Time

To set the date and time:

- 1 Press the SmartKeys key  to enter the SmartKeys window.
- 2 Select the **Main Setup** SmartKey to enter the Main Setup menu.
- 3 Select the **Date, Time** screen element from the monitor's info line to enter the **Date, Time** menu.
- 4 Select, in turn, the **Year, Month, Day, Hour** (in 24 hour format, only) and **Minute** as necessary. Select the correct values from the pop-up list.
- 5 Select **Store Date, Time** to change the date and time.

If your monitor is connected to an Information Center, the date and time are automatically taken from this.

Once it is set, the internal clock retains the setting even when you switch off the monitor.

Checking Country-Specific Default Settings

Some settings are made in the factory to match the typical requirements in a specific country. Line frequency, units for weight and height, and ECG cable colors (AAMI or IEC) have been set to appropriate values. If you suspect that these settings may not match your institution's requirements, check the settings and change them if necessary as described in the *Configuration Guide*.

WARNING Before starting monitoring, check that the current configuration meets your requirements, especially patient category, alarm limits and paced setting.

If you need to enter configuration mode:

- 1 In the **Main Setup** menu, select **Operating Modes**.
- 2 Select **Config** and enter the passcode.
The passcode for configuration mode is given in the monitor's service documentation.

The monitor displays **Config** at the right hand side of the status line and in the center of the Screen while you are in configuration mode.

Before you leave configuration mode, always be sure to store any changes you made. You must store changes made to each Settings Block and to each Profile, individually. As it may be difficult to remember whether the settings you changed belong to a Monitor Settings block or a Measurement Settings block, we recommend that you store each block before you leave configuration mode.

To leave configuration mode:

- ◆ In the **Main Setup** menu, select **Operating Modes** and then select **Monitoring**.

Handing Over the Monitor

If you are handing over the monitor to the end-users directly after configuration, make sure that it is in Monitoring mode.

Users must be adequately trained to use the monitor before monitoring a patient. To achieve this, they should have access to, and read, the following documentation delivered with the monitor:

- Instructions for Use (this book) - for full operating instructions
- Quick Guide - for quick reminders during use

Additionally, we recommend working through the Training Guide for self-training on the monitor before use (not available in all languages). The part number is M8102-944XB, where X is a digit dependent on the language. The English training guide is M8102-9441B.

Basic Operation

These Instructions for Use are for clinical professionals using the IntelliVue MP2 (M8102A) patient monitor.

This basic operation section gives you an overview of the device and its functions. It tells you how to perform tasks that are common to all measurements (such as entering data, switching a measurement on and off, setting up and adjusting wave speeds, working with profiles). The alarms section gives an overview of alarms. The remaining sections tell you how to perform individual measurements, and how to care for and maintain the equipment.

Familiarize yourself with all instructions including warnings and cautions before starting to monitor patients. Read and keep the Instructions for Use that come with any accessories, as these contain important information about care and cleaning that is not repeated here.

This guide describes all features and options. Your monitor may not have all of them; they are not all available in all geographies. Your monitor is highly configurable. What you see on the screen, how the menus appear and so forth, depends on the way it has been tailored for your hospital and may not be exactly as shown here.

In this guide:

- A **warning** alerts you to a potential serious outcome, adverse event or safety hazard. Failure to observe a warning may result in death or serious injury to the user or patient.
- A **caution** alerts you to where special care is necessary for the safe and effective use of the product. Failure to observe a caution may result in minor or moderate personal injury or damage to the product or other property, and possibly in a remote risk of more serious injury.
- **Monitor** refers to the entire patient monitor. **Display** refers to the physical display unit. **Display Screen** and **Screen** refer to everything you see on monitor's display, such as measurements, alarms, patient data and so forth.

Introducing the IntelliVue MP2

The Philips IntelliVue MP2 monitor provides a comprehensive set of basic physiological measurements: ECG (including ST analysis and optional 10-lead ECG), NBP, SpO₂, and optionally invasive blood pressure, temperature and CO₂. Through networking it provides information integration, documentation and information access. The MP2 can be used with adult, pediatric and neonatal patients in a hospital environment and during patient transport both inside and outside hospitals.

The monitor stores data in trend databases. You can see tabular trends (vital signs) and document them on a central printer. You can view measurement trend graphs, including horizon trends, to help you identify changes in the patient's physiological condition.

The monitor can be powered by a rechargeable battery, or from AC mains using the external power supply (M8023A). For battery charging, care and status information, refer to the chapter "Using Batteries" on page 217.

Controls, Indicators and Connectors

MP2 Overview

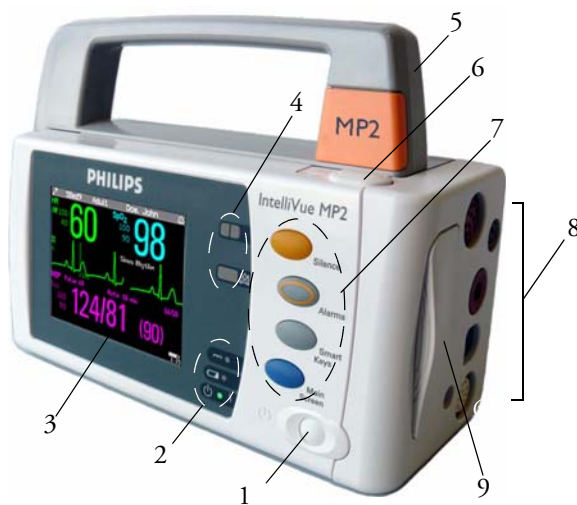

- 1 On/Standby Switch
- 2 Power and battery indicators (see "MP2 Controls and Indicators" on page 11)
- 3 3.5-inch TFT LCD touchscreen QVGA display
- 4 Alarm lamps (see "MP2 Controls and Indicators" on page 11)
- 5 Built-in carrying handle
- 6 Battery eject button
- 7 Keys (see "MP2 Controls and Indicators" on page 11)
- 8 Measurement connectors (see "MP2 Patient Connectors, Right Side" on page 12)
- 9 Battery

MP2 Controls and Indicators

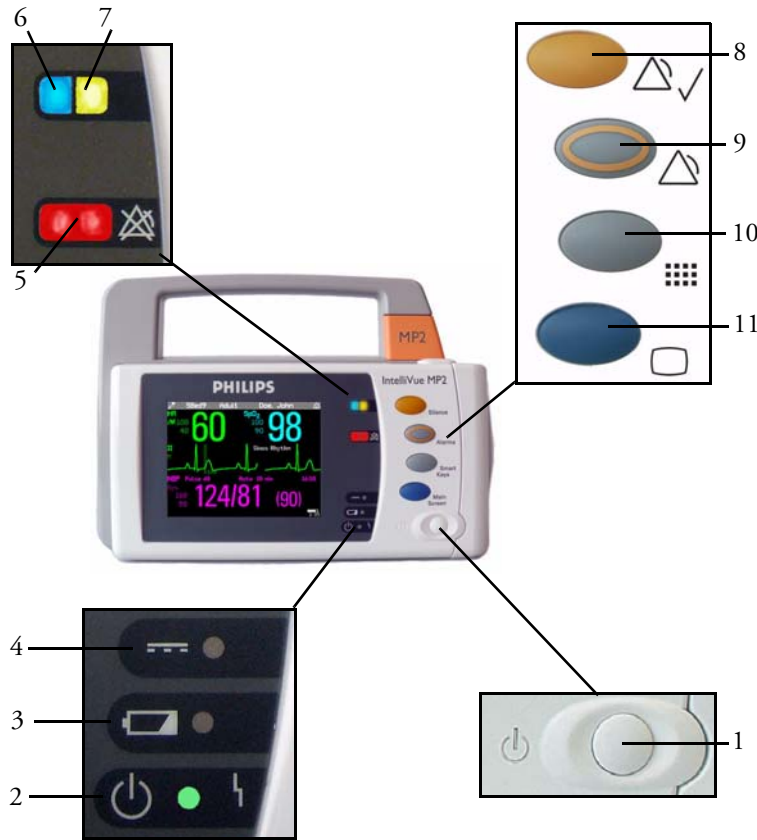

- 1 On/Standby switch
- 2 On/Standby LED. Green when monitor is on. Red indicates an error.
- 3 Battery status LED. Yellow when charging. Flashing red when battery is empty, or a battery malfunction is detected.
- 4 External power LED. Green when monitor is powered from an external power source.
- 5 Alarms off indicator. When alarms are suspended, the lamp is red, and the ALARMS OFF message appears on the screen.
- 6 Active INOP alarm lamp in light blue. Stays lit until active INOP is acknowledged.
- 7 Active alarm lamp. Red or yellow, depending on alarm level. Stays lit until active alarm is acknowledged.
- 8 Silence key
- 9 Alarms key: turns alarms On/Off, or pauses them
- 10 SmartKeys key: brings up SmartKeys on the screen
- 11 Main Screen key: closes all open menus/windows and returns to the main screen, or selects current screen.

MP2 Patient Connectors, Right Side

Symbols (International)

Text (English versions only)

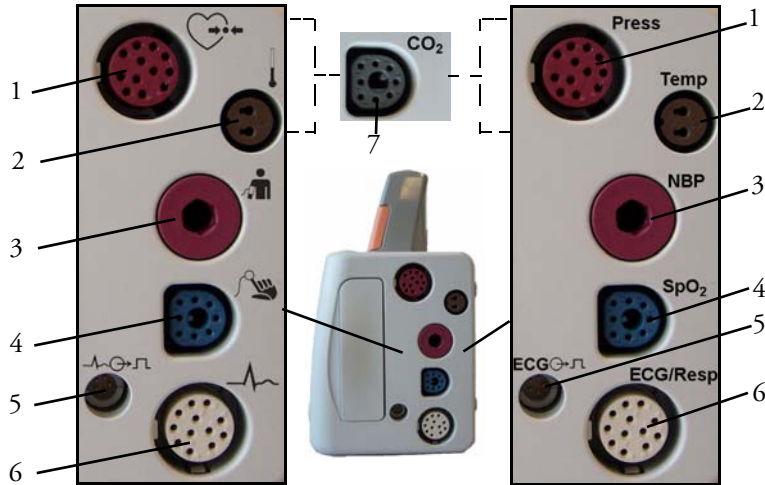

- 1 Pressure (option)
- 2 Temperature (option)
- 3 Noninvasive blood pressure
- 4 SpO₂
- 5 ECG sync pulse output
(See page 252 for specifications)
- 6 ECG/Respiration
- 7 CO₂ (option)

MP2 Left Side



- 1 Loudspeaker
- 2 MSL Connector. Connects to the external power supply via the MSL cable for AC mains operation, battery charging, and communication with a network.

Extending Measurements

Your monitor is compatible with Philips measurement extensions for use with other IntelliVue patient monitoring devices. These allow you to add specific measurements to those already integrated into your monitor. These measurement extensions are referred to as MMS extensions.



MMS Extension
M3014A attached to
the MP2

The MMS extensions connect to the monitor and use the monitor's settings and power. Trend data and measurement settings from the measurements in the extensions are stored in the monitor.

-
- WARNING**
- Measurements from a MMS extension are only available when the extension is connected to the monitor, and the monitor is running on AC mains via the external power supply (M8023A). Measurements from a MMS extension connected to the monitor are not available when the monitor is running on battery power.
 - Any measurements on a MMS extension that conflict with those in the monitor cannot be used. For example, only one CO₂ measurement is supported.
-

To separate an extension from the monitor, press the release lever and push the extension forward.

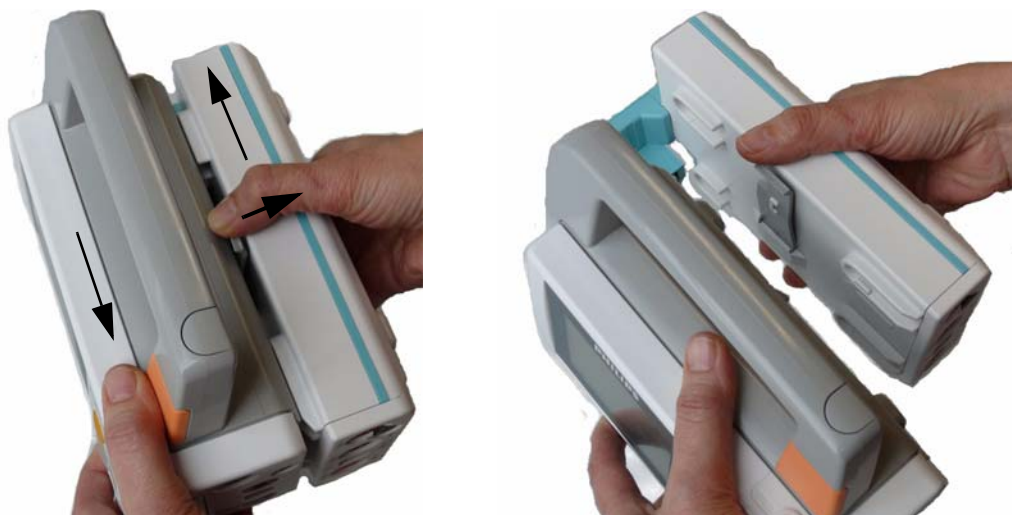

M3014A, M3015A and M3016A Measurement Extensions

The optional M3014A Capnography extension adds mainstream capnography, and optionally one pressure plus either a pressure or a temperature to the monitor. Cardiac Output and Continuous Cardiac Output are not available when used with the MP2.

The optional M3015A Microstream CO₂ extension adds microstream capnography and optionally either pressure or temperature to the monitor. The optional M3016A Mainstream CO₂ extension adds mainstream capnography and optionally either pressure or temperature to the monitor.

Only one CO₂ measurement at a time is supported.



- | | | | |
|---|--|---|---------------------------------------|
| 1 | Pressure connectors (red) | 5 | Inlet |
| 2 | Temperature connector (brown) | 6 | Microstream connector CO ₂ |
| 3 | Mainstream/sidestream connector CO ₂ (optional) | 7 | Gas sample outlet |
| 4 | Cardiac Output connector | | |

M3012A Hemodynamic MMS Extension

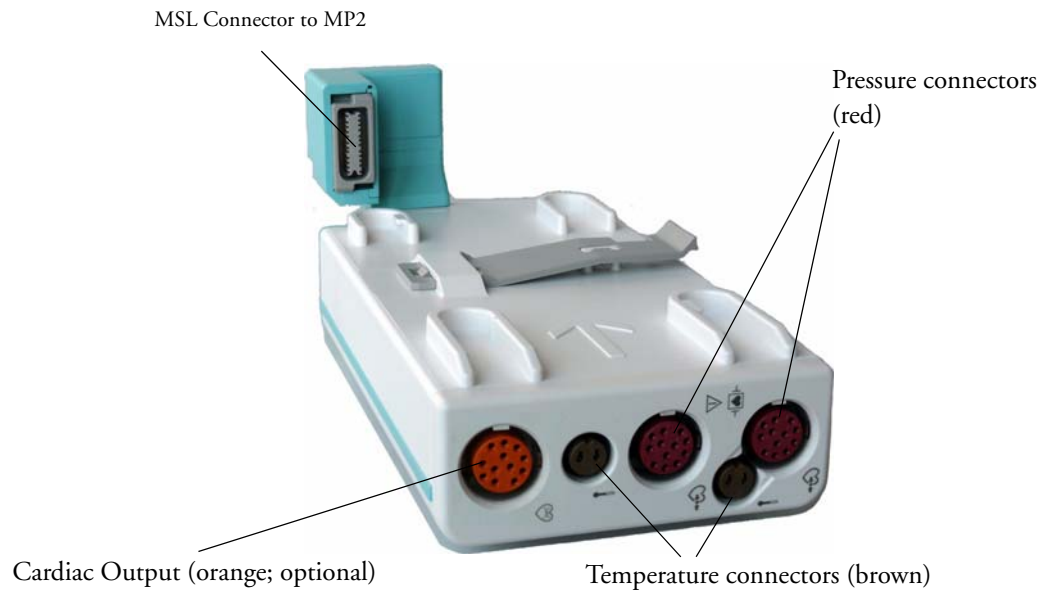





When attached to the MP2 connected to the external power supply, the optional M3012A Hemodynamic extension adds temperature, pressure, and an additional pressure or a temperature to the monitor.

Cardiac Output and Continuous Cardiac Output are not available when used with the MP2.

Operating and Navigating



The principle method of operating your monitor is via the touchscreen. Almost every element on the screen is interactive. Screen elements include measurement numerics, information fields, alarms fields, waveforms and menus.

There are also four keys to the right of the screen (see also “MP2 Controls and Indicators” on page 11).

These let you:	Key with symbol (international)	Text replaces symbol (English versions only)
<ul style="list-style-type: none"> Silence alarms: the Silence key acknowledges all active alarms by switching off audible alarm indicators and lamps. 		Silence
<ul style="list-style-type: none"> Switch alarms on or off, or pause alarms. 		Alarms
<ul style="list-style-type: none"> Call up SmartKeys on the screen (see below). 		Smart Keys
<ul style="list-style-type: none"> Close all open menus/windows and return to the main screen. If you are already in the main screen (no additional menus/windows are open), then pressing this key opens the Change Screen window, where you can choose from a number of pre-configured screens. To temporarily disable the touchscreen operation, press and hold this key for 2 seconds. Press the key again to re-enable the touchscreen operation. 		Main Screen

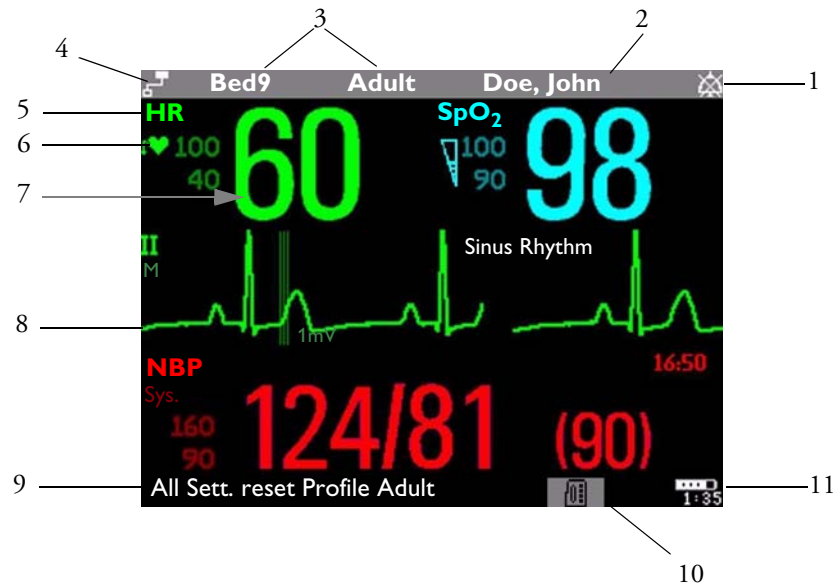
A typical main screen looks like this:

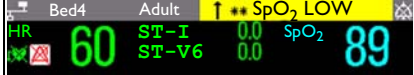
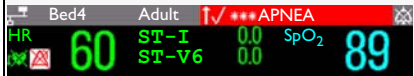

MP2 Screen Elements		
Item	Description	Comments
1	Alarm volume off indicator	 is displayed when the alarm volume is set to zero (0).
2	Patient name / alarm message field	<p>Patient name can be covered by alarm messages or alarms On/Off/Paused message.</p>  <p>If red and yellow alarms are active at the same time, they rotate in the alarm field.</p> 
3	Patient category and bed label / INOP message field	<p>Patient category and bed label can be covered by INOP messages. If there are multiple red/yellow/cyan INOPs active at the same time, they rotate in the INOP field.</p> 
4	Network connection indicator	Documented in Information Center Instructions for Use.
5	Measurement label	Touch the measurement to enter the measurement setup menu.
6	Paced status	Displayed below the HR label.

MP2 Screen Elements		
Item	Description	Comments
7	Measurement numeric/values	Touch the numeric to enter the measurement setup menu.
8	Measurement wave	Touch the wave to enter the measurement setup menu.
9	Status line	Shows information and messages prompting you for action.
10	Battery status indicator	Gives information about remaining battery charge, estimated operating time, maintenance requirements and malfunctions. See the chapter “Using Batteries” on page 217.

Using the Touchscreen

Touch a screen element to get to the actions linked to that element. For example, touch a measurement numeric and the setup menu for that measurement opens. Touch a wave to enter the setup menu for that wave.

Measurement Setup Menus

Each measurement has a setup menu where you can perform operations or change settings. Typically, the setup menu window covers the whole screen, with the exception of the INOP and alarm message fields, which are always displayed at the top. The following picture is for illustration purposes, and may not exactly represent what you see on the screen. We are using non invasive blood pressure as an example, but all measurement setup windows are similar and share the same basic layout and components.

Touch the measurement numeric on the screen to enter the setup menu.

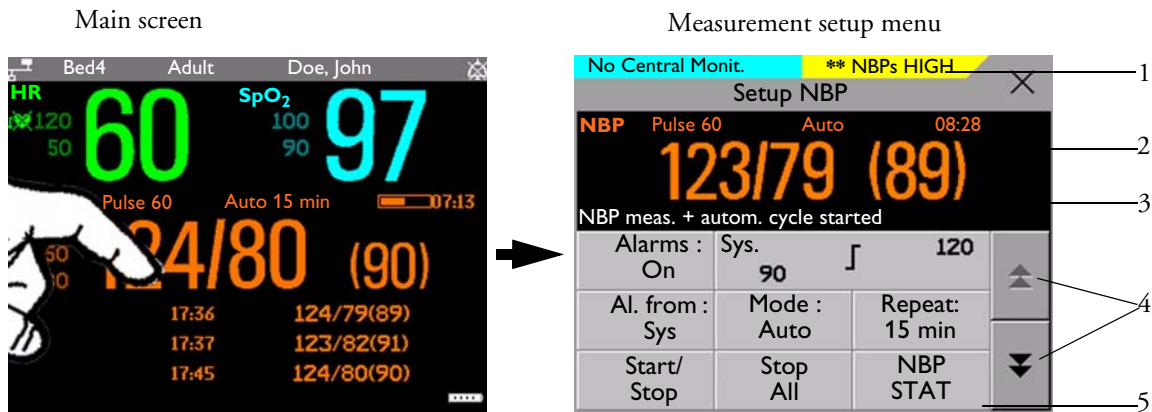

Key to measurement setup menu:		
Item	Description	Comment
1	INOP and alarm message field.	These are always displayed at the top of the screen.
2	Wave/numerics window.	The main measurement numeric and wave (if applicable) are shown in this window so that you do not lose sight of the current measurement while making changes in the menu.
3	Status/prompt message.	Status/prompt messages related to the measurement menu are displayed below the wave/numerics. General status/prompt messages on the main screen are covered by the measurement setup menu.
4	Next page arrows.	The menu may have more than one page, as shown here. Move to another page by touching these arrows.
5	Measurement menu buttons.	Each button has two lines of text. To perform an operation on a measurement, press one of the buttons. Some buttons lead directly to a task. For example, pressing the Start/Stop button for noninvasive blood pressure starts a measurement. Other buttons open a pop-up window, which can have more than one page, from which you make a selection. Again, using noninvasive blood pressure as an example, pressing the Repeat Time button for setting the repetition time opens a pop-up window from which you pick a time, scrolling if necessary.

Main Setup Menu

There is usually more than one way to enter a setup menu for a measurement, to change a setting or to execute a task. Some routes are more direct than others. You can use whichever method you find most convenient. Which routes are available to you, however, can vary depending on your monitor's configuration.

For this reason, this book generally describes entry to a measurement's setup menu via the Main Setup menu, as this route is always available and is not subject to configuration dependencies. You can get to all setup windows from the Main Setup menu. You enter the Main Setup menu by pressing the SmartKeys key, then selecting the **Main Setup** SmartKey.

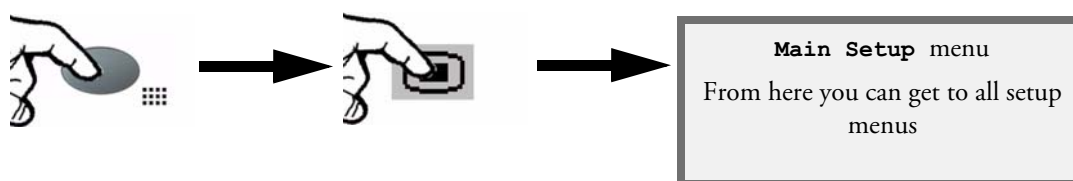





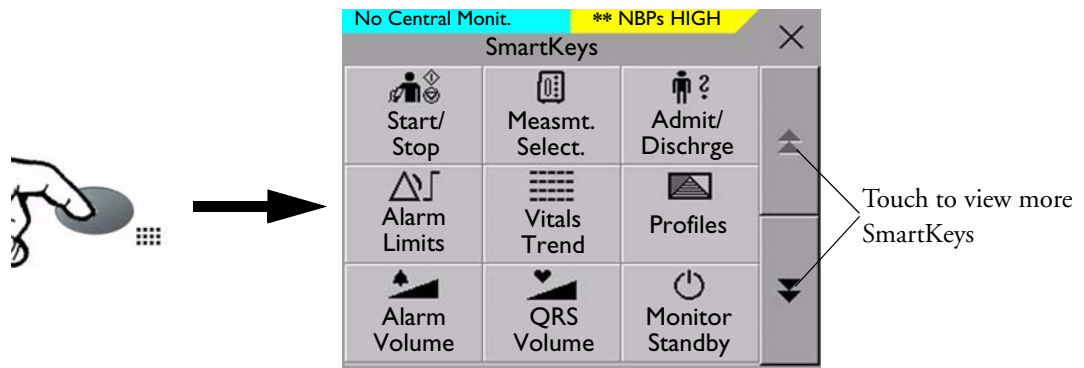









SmartKeys

A SmartKey is a configurable graphical key on the screen allowing fast access to frequently used functions. Press the SmartKeys hard key to call up a set of SmartKeys on the screen. Although the selection of SmartKeys available on your monitor depends on the monitor configuration and on the options purchased, the SmartKeys window generally looks like this:



Main Setup is one of the SmartKeys.

- | | | | |
|--|--|--|--|
| | enter Main Setup menu - you can get to all setup windows using this key | | enter standby mode - suspends patient monitoring. All waves and numerics disappear from the display. All settings and patient data information are retained. |
| | enter profile menu, or revert to default profile | | change Screen, or revert to default screen |
| | previous Screen | | quick admit a patient |
| | enter patient identification menu to admit/discharge/transfer | | end case to discharge a patient |
| | lock touchscreen operation | | set alarm limits |
| | change alarm volume | | change screen brightness (not for independent displays) |
| | change QRS volume | | change amplitude (size) of ECG wave |
| | review beat labels (annotate arrhythmia wave) | | re-learn arrhythmia |
| | - start/stop manual NBP measurement
- start auto series
- stop current automatic measurement within series | | start NBP STAT measurement |
| | stop automatic or STAT NBP measurement and measurement series | | start NBP measurement and measurement series |

	start veni puncture (inflate cuff to subdiastolic pressure)		stop current NBP measurement
	set the NBP repeat time		access patient reports
	switch CO ₂ pump off		zero invasive pressure transducer
	new lead setup		set standard or EASI lead placement
	review vital signs trend		review graph trend
	unpair equipment and continue central monitoring with the monitor		unpair equipment and continue central monitoring with the telemetry device
	start 12-Lead Capture (only available if Information Center is connected)		access ST Map application
	select measurement device		

Pop-Up Keys

Pop-up keys are task-related graphical keys that appear automatically on the monitor screen when required. For example, the confirm pop-up key appears only when you need to confirm a change.

Using the On-Screen Keyboard

Use this as you would a conventional keyboard. Enter the information by selecting one character after another. Use the **Shift** key to access uppercase letters. Use the **Back** key to delete single characters, or use the **Clr** key to delete entire entries. Select **Enter** to confirm what you have entered and close the on-screen keyboard.



Operating Modes

When you switch the monitor on, it starts up in monitoring mode. To change to a different mode:

- 1 Select the **Main Setup** menu.
- 2 Select **Operating Modes** and choose the mode you require.

Your monitor has four operating modes. Some are passcode protected.

- **Monitoring Mode:** This is the normal, every day working mode that you use for monitoring patients. You can change elements such as alarm limits, patient category and so forth. When you discharge the patient, these elements return to their default values. Changes can be stored permanently only in Configuration Mode. You may see items, such as some menu options or the altitude setting, that are visible but 'grayed out' so that you can neither select nor change them. These are for your information and can be changed only in Configuration Mode.
- **Demonstration Mode:** Passcode protected, this is for demonstration purposes only. You must not change into Demonstration Mode during monitoring. In Demonstration Mode, all stored trend information is deleted from the monitor's memory.
- **Configuration Mode:** Passcode protected, this mode is for personnel trained in configuration tasks. These tasks are described in the Configuration Guide. During installation the monitor is configured for use in your environment. This configuration defines the default settings you work with when you switch on, the number of waves you see and so forth.
- **Service Mode:** Passcode protected, this is for trained service personnel.

When the monitor is in Demonstration Mode, Configuration Mode, or Service Mode, this is indicated by a box with the mode name in the center of the Screen and a symbol in the bottom right-hand corner. Select this field to change to a different mode.



Standby Mode

Standby mode can be used when you want to temporarily interrupt monitoring.

To enter Standby mode,

- 1 Press the SmartKeys key .
- 2 *Either* select the **Monitor Standby** SmartKey
Or select the **Main Setup** SmartKey, then select **Monitor Standby**.

The Standby screen looks like this:



The monitor enters Standby mode automatically after the End Case function is used to discharge a patient. Standby suspends patient monitoring. All waves and numerics disappear from the display but all settings and patient data information are retained. A special **Standby** screen is displayed.

If a patient location is entered at the Information Center, this will also be displayed on the **Standby** screen (availability depends on Information Center revision).

To resume monitoring,

- ◆ Select anything on the screen or press any key.

Understanding Screens

Your monitor comes with a set of pre-configured Screens, optimized for common monitoring scenarios. A Screen defines the overall selection, size and position of waves and numerics on the monitor screen when you switch on. You can easily switch between different Screens during monitoring. Screens do NOT affect alarm settings, patient category and so forth.

Switching to a Different Screen

To switch to a different Screen:

- 1 After closing any open menus or windows, press the **Main Screen** key to access the **Change Screens** menu.
- 2 Choose the new Screen from the **Change Screens** menu.

Changing a Screen's Content

If you do not want to change the entire Screen content, but only some parts of it, you can substitute individual waves, numerics, or trends. Be aware that these changes cannot be stored permanently in Monitoring Mode.

To change the selection of elements on a Screen,

- 1 Select the element you want to change. For example, touch the wave to enter the wave setup menu, or touch the numeric to enter the numeric setup menu.
- 2 From the menu that appears, select **Change Wave** or **Change Numeric**, and then select the wave or numeric you want.

In the **Change Screen** menu, the changed Screen is shown linked to the original Screen and marked with an asterisk.

Up to three modified Screens can be accessed via the **Change Screen** menu.

To recall Screens, select the name of the Screen in the **Change Screen** menu.

After a patient discharge, the monitor's default Screen is shown. Modified Screens are still available in the **Change Screen** menu.



If the monitor is switched off and then on again, modified Screens are erased from the monitor's memory and cannot be recalled. If a modified Screen was the last active Screen when the monitor was switched off, it is retained (unless **Automat. Default** is set to **Yes** in Configuration Mode).

Using the XDS Remote Display

Using the IntelliVue XDS solution it is possible to view an independent monitor screen on an external display. The XDS solution consists of a medical grade PC-based hardware platform, XDS application software and the XDS connectivity option on the monitor. Depending on the configuration you can also operate the monitor from the external display. The XDS must be connected to the same Local Area Network (LAN) as the monitor.

It is also possible to use an existing PC, connected to the same LAN, to host the XDS Application software.

For more details, including limitations and restrictions, refer to the Instructions for Use for the XDS Application.

Using the Visitor Screen

If a visitor Screen is configured for your monitor, you can use it to clear the screen of all waves and numerics but continue to monitor the patient with active alarms and trend storage at the bedside and Information Center. You can change the name of the visitor Screen in Configuration Mode.

To activate this Screen,

- 1 Press the **Main Screen** key to open the **Change Screen** menu.
- 2 Select the name of the visitor Screen configured for your monitor from the list of available Screens.

To select a Screen with waves and numerics again,

- ◆ Touch the gray rectangle in the center of the screen showing the visitor Screen's name, or press the **Main Screen** key, to open the **Change Screen** menu and then select a Screen from the list.

Understanding Profiles

Profiles are predefined monitor configurations. They let you change the configuration of the whole monitor so you can adapt it to different monitoring situations. The changes that occur when you change a complete profile are more far reaching than those made when you change a Screen. Screens affect only what is shown on the display. Profiles affect all monitor and measurement settings.

The settings that are defined by Profiles are grouped into three categories. Each category offers a choice of 'settings blocks' customized for specific monitoring situations. These categories are:

Display (screens)

- Each profile can have a choice of many different predefined screens. When you change the profile, the screen selection configured for the new profile becomes active.

• Measurement Settings

- Each profile can have a choice of different predefined measurement settings. These relate directly to individual measurements, for example, measurement on/off, measurement color, alarms limits, NBP alarm source, NBP repeat time, temperature unit (°F or °C) pressure unit (mmHg or kPa).

• Monitor Settings

- Each profile can have a choice of different predefined monitor settings. These relate to the monitor as a whole; for example, display brightness, alarms off/paused, alarm volume, QRS tone volume, tone modulation, prompt tone volume, wave speed, resp wave speed, pulse source.

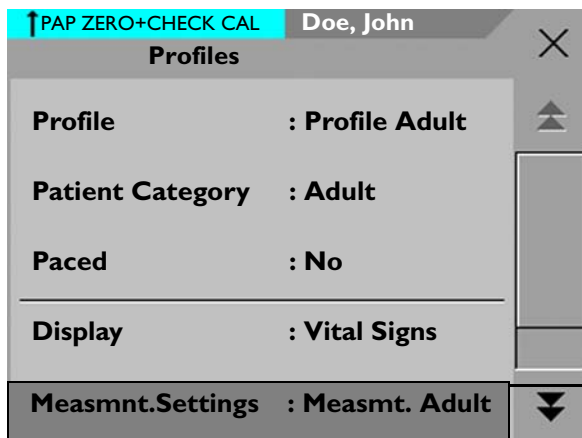

Profiles Menu, showing current settings

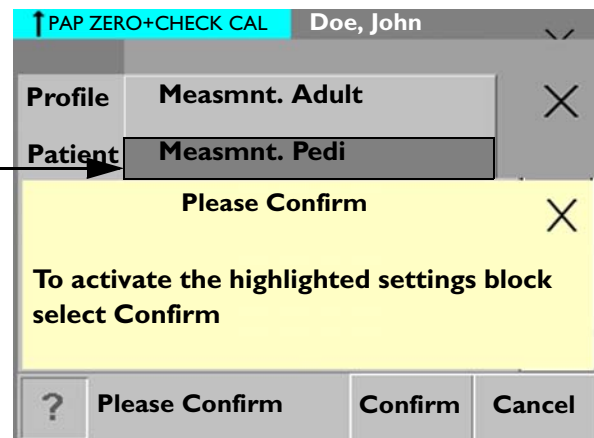

Available choices in measurement menu. Confirm your choice when prompted.

You can change from one complete profile to another or swap individual settings blocks (display screen/monitor settings/measurement settings) to change a subset of a profile. Changes you make to any element within the settings blocks are not saved when you discharge the patient, unless you save them in Configuration Mode.

Depending on your monitor configuration, when you switch on or discharge a patient the monitor either continues with the previous profile, or resets to the default profile configured for that monitor.

WARNING If you switch to a different profile, the patient category and paced status normally change to the setting specified in the new profile. However some profiles may be setup to leave the patient category and paced status unchanged. Always check the patient category, paced status, and all alarms and settings, when you change profiles.

When you leave Demonstration Mode, the monitor uses the default profile.

Swapping a Complete Profile

- 1 Press the **SmartKeys** key and
 - *Either* select Main Setup and then **Profiles** in the **Setup** menu.
 - *Or* select the **Profiles** SmartKey .
- 2 In the **Profiles** menu, select **Profile**.
- 3 Chose a profile from the pop-up list.
- 4 Confirm your selection.

Swapping a Settings Block

- 1 Select the **Main Setup** SmartKey and then **Profiles** in the Main Setup menu, or select the Profiles SmartKey. 
- 2 In the **Profiles** menu, select **Display** or **Measmnt. Settings** or **Monitor Settings** to call up a list of the settings blocks in each category.
- 3 Choose a settings block from the pop-up list.
- 4 Confirm your selection.

Default Profile

Your monitor has a default profile that it uses when you leave Demonstration, or Service modes, or when you discharge a patient. This profile is indicated by a diamond .

Locked Profiles



Some profiles are locked, so that you cannot change them, even in Configuration Mode. These are indicated by this lock symbol.

Understanding Settings

Each aspect of how the monitor works and looks is defined by a setting. There are a number of different categories of settings, including,

Screen Settings, to define the selection and appearance of elements on each individual Screen

Measurement settings, to define settings unique to each measurement, for example, high and low alarm limits

Monitor settings, including settings that affect more than one measurement or Screen and define general aspects of how the monitor works, for example, alarm volume, reports and recordings, and display brightness.

You must be aware that, although many settings can be changed in Monitoring Mode, permanent changes to settings can only be done in the monitor's Configuration Mode. All settings are reset to the stored defaults:

- when you discharge a patient
- when you load a Profile
- when the monitor is switched off for more than one minute (if **Automat. Default** is set to **Yes**).

Changing Measurement Settings

Each measurement has a setup menu in which you can adjust all of its settings. You can enter a setup menu:

- via the measurement numeric - select the measurement numeric to enter its setup menu. For example, to enter the **Setup ECG** menu, select the HR (heart rate) numeric.
- via the **Main Setup** SmartKey - if you want to setup a measurement when the measurement is switched off, use the **Main Setup** SmartKey and select **Measurements**. Then select the measurement name from the popup list. With this permanent key you can access any setup menu in the monitor.
- via the Measurement Selection key.

Switching a Measurement On and Off

When a measurement is off, its waves and numerics are removed from the monitor's screen. The monitor stops data acquisition and alarming for this measurement.

- 1 Enter the measurement's setup menu and select the measurement.
- 2 Select the measurement name to toggle between on and off. The screen display indicates the active setting.

Adjusting a Measurement Wave

To quickly adjust wave-related measurement settings (such as speed or size), select the measurement wave itself. This displays the measurement **Wave** menu, which has only wave-related measurement settings.

Changing Wave Speeds

Lowering the wave speed compresses the wave and lets you view a longer time period. Increasing the speed expands the waveform, giving you a more detailed view.

The monitor distinguishes two groups of wave speed settings,

- **RespiratorySpeed**, for CO₂ waves.
- **Global Speed**, for all waves not included in the other group.

Changing the Wave Group Speed

The wave speed group setting defines the speed of all the waves in the group.

To change the wave speed of a wave speed group,

- 1 Select **Main Setup** -> **User Interface**
- 2 Select **Global Speed** or **RespiratorySpeed**, as required
- 3 Select a value from the list of available speeds.

Changing Wave Speed for a Channel

To change the wave speed of an individual wave channel,

- 1 Enter the **Wave** menu for a measurement by selecting its wave.
- 2 Select **Change Speed**.
- 3 To set the speed to the wave group speed, select **RespiratorySpeed** or **Global Speed**.
To set an individual channel speed, select a numeric value from the list of available speeds. This overrides the wave group speed setting and sets the speed for the individual wave channel on the monitor Screen. The wave channel speed is independent of the wave (label) depicted in the channel, if you change the wave, the new wave will retain the set channel speed.

Using Labels

You can measure up to three invasive pressures and temperatures simultaneously. The monitor uses labels to distinguish between them. The default settings defined in the profile (such as measurement color, wave scale, and alarm settings) are stored within each label. When you assign a label to a measurement, the monitor automatically applies these default settings to the measurement. The labels assigned are used throughout the monitor, in reports, recordings, and in trends.

Changing Measurement Labels (e.g. Pressure)

To change a measurement label of a measurement with multiple labels (invasive pressure or temperature),

- 1 Enter the **Wave** menu of the measurement.
- 2 Select **Label**.
- 3 Choose a label from the list.

The monitor automatically applies the scale, color, etc. settings stored in the Profile for the label you select. You can change scale settings in Monitoring Mode, but color can only be changed in the monitor's Configuration Mode.

Any labels already being used in the monitor are shown "grayed-out" in the list and cannot be selected.

Resolving Label Conflicts

Each label must be unique, that is, it can only be assigned once. If you have a MMS Extension equipped with a pressure measurement connected to the monitor, there is a potential conflict with, for example, the ABP label. If you manually enter measurement values these may also conflict with existing labels on the monitor.

Depending on your configuration, the monitor will either

- display the **Measurement Selection** window automatically for you to resolve the conflict
- take no action, you must enter the **Measurement Selection** window and resolve the conflict



measurement selection key

All the currently available measurements are depicted in the **Measurement Selection** window. Any measurement labels causing a label conflict are shown in red. If a measurement is connected but currently unavailable, for example, because it was deactivated due to a label conflict, that measurement is shown “grayed-out”. If a MMS Extension is not available, for example if monitor is running on battery power and not an external power source, the MMS Extension is not displayed.

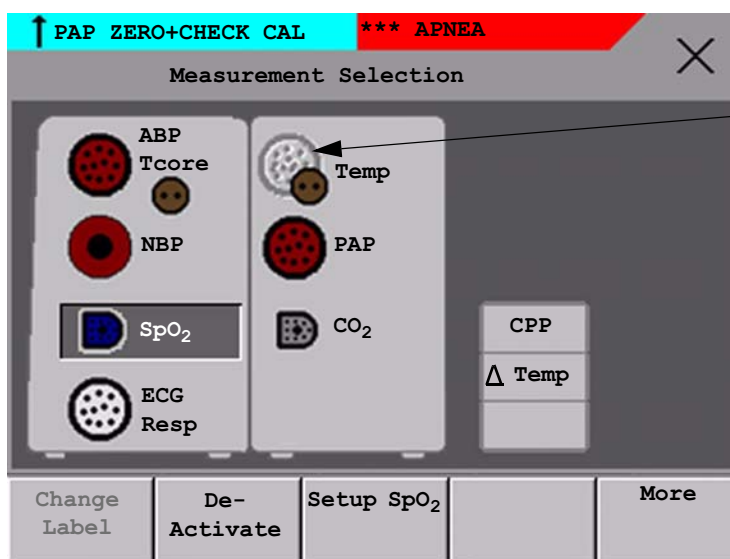

Unavailable measurements are grayed-out

A MMS Extension is only shown in the **Measurement Selection** window when the monitor is connected to the external power supply (M8023A) and running on AC mains power, and not when running on battery power.

To resolve a label conflict:

- 1 Press the **SmartKeys** key and
 - Either select **Main Setup** and then **Meas. Selection**
 - Or select the **Meas. Select.** SmartKey to display the **Measurement Selection** window.
- 2 Select the label to be corrected.
- 3 Use the measurement selection keys to resolve the conflict. Select either:
 - **Change Label**: to assign a different label to the conflicting label.
 - **De-activate**: to disable the conflicting measurement. It retains its label for future use but becomes invisible to the monitor, as though it had been unplugged.
 - **Setup <Measurement label>**: to enter the Setup menu for the measurement and change the conflicting device’s label to a different label.
- 4 Select the **De-activate** pop-up key to disable the conflicting measurement.

Label Compatibility



When a new measurement is introduced, or new labels for an existing measurement, these labels will not be shown on older Information Centers, and consequently not on the Overview screen sourced from the Information Center.

When a patient is transferred from a monitor with these new labels to one with an older software revision, the labels will be replaced with a generic label for that measurement. The settings for that generic label will then be used.

If it is critical that the measurement labels are available at the Information Center and after transfers, the older monitors and the Information Center must be upgraded to the appropriate software revision.

Changing Monitor Settings

To change monitor settings such as brightness, or QRS tone volume:

- 1 Press the SmartKeys key .
- 2 *Either* Enter the **Main Setup** menu by selecting the SmartKey . Select the setting you want to change, or select **User Interface** to enter a submenu where you can change user interface settings.
Or Select the appropriate SmartKey for the setting you want to change.

Adjusting the Screen Brightness

- 1 Select the **Brightness** SmartKey. 
- 2 Select the appropriate setting for the screen brightness. 10 is the brightest, 1 is the least bright. **Optimum** is suitable for most monitoring locations and optimizes power usage for battery powered monitors.

Your monitor may be configured with a lower brightness for Standby mode and also for transport to conserve battery power. These settings can only be changed in the monitor's Configuration Mode.

Setting the Date and Time

If your monitor is connected to an Information Center, the date and time are automatically taken from this.

Once it is set, the internal clock retains the setting even when you switch off the monitor.

- 1 In the **Main Setup** menu, select **Date, Time**.
- 2 Select, in turn, the **Year, Month, Day, Hour** (in 24 hour format, only) and **Minute** as necessary. Select the correct values from the pop-up list.
- 3 Select **Store Date, Time** to change the date and time.

Checking Your Monitor Revision

- 1 Select **Main Setup** -> **Revision** to open the **Monitor Revision** menu.
- 2 Select the correct device from the device pop-up keys.

- 3 From the **Monitor Revision** menu, select the monitor component for which you need revision information.

Getting Started

Once you understand the basic operation principles, you can get ready for monitoring.

Inspecting the Monitor

WARNING If the monitor is mechanically damaged, or if it is not working properly, do not use it for any monitoring procedure on a patient. Contact your service personnel.

- 1 Before you start to make measurements, carry out the following checks on the monitor.
 - Check for any mechanical damage.
 - Check all the external cables, plug-ins and accessories.
- 2 Always ensure that the battery is loaded in the battery compartment when monitoring a patient, even when the monitor is running on external power.
- 3 If you are using battery power, ensure that the battery has sufficient power for monitoring. Before using a battery for the first time, you must charge it, following the instructions given in the section on Charging Batteries.
- 4 Measurements from measurement extensions attached to the monitor are only available when the monitor is operating from AC mains power. The measurement extensions are not active when the monitor is operating from battery power.
- 5 Check all the functions of the instrument that you need to monitor the patient, and ensure that the instrument is in good working order.

Switching On

Press the on/off switch on the monitor for one second. The monitor performs a self test and is then ready to use. If you see a message such as **CO₂ SENSOR WARMUP** wait until it disappears before starting to monitor that measurement.

Power On/Power Off Behavior

The general rules determining the behavior of the monitor when connected to, or disconnected from power are as follows:

- A monitor that was switched on prior to a temporary power loss switches on again when power is restored.
- A monitor that was switched off prior to a temporary power loss remains off when power is restored.
- When AC mains power is lost, a battery powered monitor continues to run without interruption on battery power.

Setting up the Measurements

- 1 Decide which measurements you want to make.

- 2 Connect the required patient cables and sensors. The connectors are color-coded to the patient cables and sensors for easy identification.

WARNING When connecting devices for acquiring measurements, always position cables and tubing carefully to avoid entanglement or potential strangulation.

Starting Monitoring

After you switch on the monitor,

- 1 Admit your patient to the monitor.
- 2 Check that the profile, alarm limits, alarm and QRS volumes, patient category and paced status and so forth are appropriate for your patient. Change them if necessary.
- 3 Refer to the appropriate measurement section for details of how to perform the measurements you require.

Disconnecting from AC Mains Power

To disconnect the monitor from AC mains power, unplug the power cord for the external power supply (M8023A) from the mains socket.

Monitoring After a Power Failure

If external power is disconnected or there is a power failure, the monitor continues to run on its rechargeable battery.

If the monitor is without any power (no external power or the battery is empty) for less than one minute, monitoring will resume with all active settings unchanged. If the monitor is without power for more than one minute, the behavior depends on your configuration. If **Automat. Default** is set to **Yes**, the default profile will be loaded when power is restored. If **Automat. Default** is set to **No**, all active settings are retained, if power is restored within 48 hours. The **Automat. Default** setting is made in Configuration Mode.

Networked Monitoring

You can connect your monitor to an Information Center on a network, using one of the optional interfaces:

- Standard wired LAN
- Wireless LAN
- IntelliVue Instrument Telemetry System (IIT)

WARNING Do not connect patient monitors to the standard hospital network.

If your monitor is connected to a network, a network symbol is displayed in the upper left corner next to the bed label. To see details about the monitoring equipment and technical information about the network, select the **Main Setup** SmartKey to enter the **Setup** menu, then select **Bed Information**.

Be aware that some network-based functions may be limited for monitors on wireless networks in comparison to those on wired networks.

Capturing Alarm Reports and Printing

You can print out standard reports, alarm reports and trends with the IntelliVue PC Printing Solution. This is a software package which allows you to print to a standard, off-the-shelf printer or to an electronic file such as PDF. You can download the IntelliVue PC Printing Solution free-of-charge from the Internet and install it on an existing PC.

Capturing Alarm Reports

The monitor can be set up to automatically capture alarm reports, triggered by selected alarms. The necessary settings must be made in Configuration mode.

When one of the selected alarms occurs, the monitor automatically captures the alarm and creates a report which is stored in the database. As soon as the monitor is connected to a PC or network with the IntelliVue PC Printing Solution software, it will automatically print the reports, or send them to a patient-specific folder as an electronic file.

What's New?

This section lists the most important new features and improvements to the monitor and its user interface introduced with each release. Further information is provided in other sections of this book.

You may not have all of these features, depending on the monitor configuration purchased by your hospital.

What's New in Release G.0?

Short Range Radio Interface for MP2

A short range radio interface is now available for the MP2 monitor. This allows a telemetry transceiver with a short range radio adapter to be assigned to the monitor, resulting in a direct connection. The measurement data from the telemetry transceiver appear directly on the monitor screen with a minimal delay and are combined with the monitor data in one sector at the Information Center.

IntelliVue XDS Solution

Using the IntelliVue XDS solution it is possible to view an independent monitor screen on an external display. The XDS solution consists of a medical grade PC-based hardware platform, XDS application software and the XDS connectivity option on the monitor. Depending on the configuration you can also operate the monitor from the external display. The XDS must be connected to the same Local Area Network (LAN) as the monitor.

It is also possible to use an existing PC, connected to the same LAN, to host the XDS Application software.

New Fields in the Admission Form

A Middle Name field is now available in the admission form - whether it appears is configurable. Two additional ID fields, Lifetime Id and Encounter Id, can also be configured to appear and their names can be customized to fit hospital requirements.

SpO₂ Enhancements

- Additional SpO₂ Labels - **SpO₂pr** and **SpO₂po** labels have been added.
- New **manual measurement mode** when telemetry devices are connected via a short range radio link.
- **Signal Quality Indicator** displayed with the SpO₂ numerics.

ECG Enhancements

- New ***/**Afib** yellow alarm when an atrial fibrillation waveform is detected.
- **QT View** window - shows current wave and baseline wave with Q and T points marked so that you can verify that the QT algorithm detects correct Q and T points.

What's New in Release F.0?

QT/QTc Interval Monitoring

QT interval monitoring is used to assist in the detection of prolonged QT interval syndrome. The QT interval is measured and the heart-rate corrected QT value, QTc, is calculated. The monitor also provides a Δ QTc value which tracks variation in the QT interval in relation to a baseline value. High alarm limits can be set for QTc and Δ QTc enabling alarm notification.

Manual Data Entry

Measurement values (for example lab data or manually measured temperatures) can be entered manually into the monitor and stored in the database. They can then be used for trends, reports and also be displayed as a numeric on screen, if required.

Horizon Trend Enhancements

The trend indicator arrow indicates how the patient trend has developed in a set time period. This period is now configurable and can be set to 10 minutes, 5 minutes or 2 minutes. The horizon (or baseline) can now be set to a range or to a specific value.

Connecting an MP5 to a Monitor (**Companion Mode** is indicated)

The MP5 monitor can be connected to one of the MP20 to MP90 monitors (then called the host monitor) and used like an MMS. This provides monitoring continuity in transport situations allowing measurement data and patient demographics from the MP5 to be transferred to another monitor. When the MP5 is connected to a host monitor, no alarms will be announced on the MP5.

NBP - Programmable Measurement Sequence

Up to four measurement cycles can be set up which will run consecutively. For each cycle you can set the number of measurements and the interval between them. By setting the last cycle to run continuously you can have regular measurements continue after the sequence has run.

New Printing Options For Reports

Reports can now also be printed via an external PC-based print server or to an internal print database, when no printer is available (for example, during transport). As soon as a printer becomes available, the reports stored in the database will print automatically.

Manual Pairing At Monitor

Previously, devices could only be manually paired at the Information Center. You can now pair devices at the monitor as long as the monitor is already connected to the Information Center.

Moving Windows And Menus

Windows and menus can now be moved on the monitor screen. Using touch or a mouse you can select the title of a window and then "drag" it across the screen. Some positions on the screen are not allowed, such as ones overlapping the alarm field or the monitor info line.

Invasive Pressure Changes

Wave cursor - A cursor is now available on the realtime pressure wave to allow you to define a position and store the corresponding value.

Reduced alarm limit steps in lower ranges - The alarm limits setting in 2 mmHg steps is now possible in ranges up to 50 mmHg (previously up to 30 mmHg).

New Patient Check

The monitor can be configured to ask you in certain situations: after a specified power-off period, after a specified standby period and when no basic vitals (HR, RR, Pulse, SpO₂, NBP) have been measured for a specified period, whether a new patient is now being monitored. By selecting the **Yes** pop-up key you can discharge the previous patient and reset settings.

New Smart Keys

A SmartKey is available for **New Lead Setup** when a new ECG lead set with fewer leads than previously is being used.

Better Visibility Of Gridlines

The brightness of the gridlines on the realtime waves has been increased for better visibility.

Alarms

The alarm information here applies to all measurements. Measurement-specific alarm information is discussed in the sections on individual measurements.

The monitor has two different types of alarm: patient alarms and INOPs.

Patient Alarms are red and yellow alarms. A red alarm indicates a high priority patient alarm such as a potentially life threatening situation (for example, asystole). A yellow alarm indicates a lower priority patient alarm (for example, a respiration alarm limit violation). Additionally there are short yellow alarms, most of which are specific to arrhythmia-related patient conditions (for example, ventricular bigeminy).

INOPs are technical alarms, they indicate that the monitor cannot measure or detect alarm conditions reliably. If an INOP interrupts monitoring and alarm detection (for example, LEADS OFF), the monitor places a question mark in place of the measurement numeric and an audible indicator tone will be sounded. INOPs without this audible indicator indicate that there may a problem with the reliability of the data, but that monitoring is not interrupted.

Most INOPs are light blue, however there are a small number of INOPS which are **always** yellow or red to indicate a severity corresponding to red and yellow alarms. The following INOPs can also be **configured** as red or yellow INOPs to provide a severity indication:

- **ECG LEADS OFF**
- **ECG/ARRH ALARM OFF** (yellow only, no red INOP)
- **CUFF OVERPRESS**
- **CUFF NOT DEFLATED**
- **OCCLUSION**
- **TELE DISCONNECT.**
- **Replace TeleBatt**

All monitors in a unit should have the same severity configured for these INOPs.

Alarms are indicated after the alarm delay time. This is made up of the system delay time plus the trigger delay time for the individual measurement. See the specifications section for details.

If more than one alarm is active, the alarm messages are shown in the alarm status area in succession. An arrow symbol next to the alarm message informs you that more than one message is active.

↑ ** HR HIGH

The monitor sounds an audible indicator for the highest priority alarm. If more than one alarm condition is active in the same measurement, the monitor announces the most severe. Your monitor may be configured to increase alarm indicator volume automatically during the time when the alarm is not acknowledged.

Visual Alarm Indicators

Alarm message: An alarm message text appears in the alarm status area at the top of the screen indicating the source of the alarm. There is a field for INOPs (light blue, red or yellow) and a field for patient alarms, which is shared for red and yellow alarms. If more than one measurement is in an alarm condition, the message changes every two seconds, and has an arrow (↑) at the side. If both red and yellow alarm conditions are active simultaneously, they alternate every two seconds in the patient alarms field. The background color of the alarm message matches the alarm priority: red for red alarms, yellow for yellow alarms, light blue for standard INOPs, red for red INOPs and yellow for yellow INOPs. The asterisk symbols (*) beside the alarm message match the alarm priority: *** for red alarms, ** for yellow alarms, * for short yellow alarms. Standard INOPs do not have a symbol, red and yellow INOPs have exclamation marks beside the alarm message: !!! for red INOPs and !! for yellow INOPs.

Depending on how your monitor is configured, it may display alarm limit violation messages

- in text form, for example “**SpO₂ LOW” or
- in numeric form, for example “**SpO₂ 94<96”, where the first number shows the maximum deviation from the alarm limit, and the second number shows the currently set limit.

Flashing numeric: The numeric of the measurement in alarm flashes.

Bright alarm limits: If the alarm was triggered by an alarm limit violation, the corresponding alarm limit on the monitor screen is shown more brightly if **Show AlarmLimits** is enabled and there is sufficient room on the screen.

Alarm lamp: A lamp on the monitor’s front panel flashes. The alarm lamp is divided into two sections. The right one flashes for a patient alarm, except for short yellow alarms where the lamp will light for approximately six seconds. The color is yellow or red corresponding to the highest priority patient alarm currently present. The left one lights continuously for a light blue INOP and flashes for yellow or red INOPs as follows:

INOP Lamp Color	Modulation (how long the lamp is on or off while flashing)	
	On	Off
Yellow	1.0 seconds	1.0 seconds
Red	0.25 seconds	0.25 seconds

If only patient alarms are present, and no INOPs, the patient alarms will use both left and right sections to flash (for red and yellow alarms) or light for approximately six seconds (for short yellow alarms). If only INOPs are present, and no patient alarms, red and yellow INOPs will use both left and right sections to flash but light blue INOPs will always light continuously in the left section only.

Audible Alarm Indicators

The audible alarm indicators configured for your monitor depend on which alarm standard applies in your hospital. Audible alarm indicator patterns are repeated until you acknowledge the alarm by switching it off or pausing it, or until the alarm condition ceases (if audible alarm indication is set to non-latching).

-
- WARNING**
- Do not rely exclusively on the audible alarm system for patient monitoring. Adjustment of alarm volume to a low level or off during patient monitoring may result in patient danger. Remember that the most reliable method of patient monitoring combines close personal surveillance with correct operation of monitoring equipment.
-

Alarm Tone Configuration

The audible alarm indicators of your monitor are configurable. In the monitor's Configuration Mode, you can:

- increase the alarm volume of unacknowledged alarms at regular intervals
- change the interval between alarm sounds (ISO/IEC Standard alarms only)
- change the base volume of the red and yellow alarm tones and the INOP tones
- change the alarm sound to suit the different alarm standards valid in different countries.

Traditional Audible Alarms (HP/Agilent/Philips/Carenet)

- Red alarms and red INOPs: A high pitched sound is repeated once a second.
- Two-star yellow alarms and yellow INOPs: A lower pitched sound is repeated every two seconds.
- One-star yellow alarms (short yellow alarms): The audible indicator is the same as for yellow alarms, but of shorter duration.
- Standard INOPs: an INOP tone is repeated every two seconds.

ISO/IEC Standard Audible Alarms

- Red alarms and red INOPs: A high pitched tone is repeated five times, followed by a configurable pause.
- Two-star yellow alarms and yellow INOPs: A lower pitched tone is repeated three times, followed by a configurable pause.
- One-star yellow alarms (short yellow alarms): The audible indicator is the same as for yellow alarms, but of shorter duration.
- Standard INOPs: a lower pitched tone is repeated twice, followed by a pause.

Changing the Alarm Tone Volume

- ◆ If you want to see a numerical indication of the current alarm volume on a scale from zero to 10, or change the setting, select the **Alarm Volume** SmartKey. The volume scale pops up. The current setting is indented. To change the setting, select the required number on the scale. Any settings that are inactive (“grayed out”) have been disabled in the monitor’s Configuration Mode.



When the alarm volume is set to zero (off), the alarm volume symbol reflects this. If you switch the alarm volume off, you will not get any audible indication of alarm conditions.



Minimum Volume for No Central Monitoring INOP

If your monitor is connected to an Information Center, and the connection is interrupted, the INOP message **No Central Monit.** will appear within 30 seconds, accompanied by an INOP tone. To help ensure that this INOP, and any other active alarm, is not overlooked, the INOP and alarm tones may be configured to have a minimum volume. In this case, INOP and alarm tones will sound even if the monitor alarm volume is set to zero.

Minimum Volume for Severe Yellow or Red INOPs

Severe yellow or red INOPs require action to ensure the well-being of the patient. Therefore the minimum volume for the INOP tone is set to at least alarm volume 8, irrespective of the current alarm volume setting. The INOP tone will sound even if the monitor alarm volume is set to zero.

The severe INOPs for which this applies are:

Cuff Not Deflated (configurable to yellow or red)

NBP Cuff Overpress (configurable to yellow or red)

Insert Battery (yellow)

Acknowledging Alarms

To acknowledge all active alarms and INOPs, press the **Silence** key. This switches off the audible alarm indicators and alarm lamps.



A check mark beside the alarm message indicates that the alarm has been acknowledged. If the monitor is configured to re-alarm, a dashed check mark will be shown.



If the condition that triggered the alarm is still present after the alarm has been acknowledged, the alarm message stays on the screen with a check mark symbol beside it, except for NBP alarms. When an NBP alarm is acknowledged the alarm message disappears.



If the alarm condition is no longer present, all alarm indicators stop and the alarm is reset.

Switching off the alarms for the measurement in alarm, or switching off the measurement itself, also stops alarm indication.

Acknowledging Disconnect INOPs

Acknowledging an INOP that results from a disconnected transducer switches off the associated measurement. The only exception is ECG/Resp: acknowledging a disconnect INOP for ECG leads does not switch off the ECG and Resp measurements. Acknowledging a disconnect INOP at the Information Center switches off the audible INOP indicator but does not switch off the measurement.

Alarm Reminder (ReAlarm)

If Alarm Reminder is configured on for your monitor, you will get an audible reminder of alarm conditions that remain active after you have acknowledged the alarm. This reminder may take the form of a repetition of the alarm tone for a limited time, or an unlimited repetition of the alarm tone (this is the same as a new alarm). Alarm reminder is not available for standard, light blue INOPs but for yellow and red INOPs.

In Configuration Mode, you can set the interval between silencing the alarm and sounding the reminder tone to one, two, or three minutes.

The alarm reminder behavior at the Information Center is different to that at the monitor. Refer to the Information Center Instructions for Use for further information.

Pausing or Switching Off Alarms

If you want to temporarily prevent alarms from sounding, for example while you are moving a patient, you can pause alarms. Depending on your monitor configuration, alarms are paused for one, two, or three minutes, or infinitely.

To view the alarm pause setting chosen for your unit,

- 1 Select **Main Setup** -> **Alarms** -> **Alarm Settings**
- 2 Check the **Alarms Off** setting.

This setting can only be changed in Configuration Mode.

To Pause All Alarms

- ◆ Press the **Alarms** key.
- ◆ If your monitor is configured to infinite pause time, the lamp next to the alarms off symbol is red, and pressing this key switches alarms off.



Depending on the configuration, you may need to select **Confirm** to complete the change.

To Switch All Alarms Off

You can only switch alarms off permanently if your monitor is configured to allow infinite alarms pause.



- ◆ Press the Alarms key.

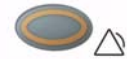

Pausing alarms indefinitely is the same as switching them off.

To Switch Individual Measurement Alarms On or Off

- 1 Select the measurement numeric to enter its setup menu.
- 2 Select **Alarms** to toggle between **On** and **Off**.



The alarms off symbol is shown beside the measurement numeric.

While Alarms are Paused or Off

- The red Alarms Paused lamp on the monitor front panel is lit.

- In the alarm field, the monitor displays the message **ALARMS PAUSED** or **ALARMS OFF**, together with the alarms paused symbol and the remaining pause time in minutes and seconds, or alarms off symbol.



ALARMS PAUSED 1:28

- No alarms are sounded and no alarm messages are shown.
- INOP messages are shown but no INOP tones are sounded.



ALARMS OFF

The only exceptions are the INOPs **CUFF NOT DEFLATED**, **CUFF OVERPRESS** and INOPs relating to empty, missing and malfunctioning batteries.

These INOPs switch the alarms on, and the INOP tones are sounded, even if alarms are paused or off. You need to remove the INOP condition first before you can switch the alarm tones off again.

If a **NO SENSOR** or **NO TRANSDUCER** INOP is present and alarms are paused or switched off, the measurement in question is switched off.

Restarting Paused Alarms

- ◆ To manually switch on alarm indication again after a pause, press the Alarms key again.

Alarm indication starts again automatically after the pause period expires. If the monitor is configured to stay paused indefinitely, you must select **ALARMS OFF** again to restart alarm indication.

Resetting Arrhythmia Alarm Timeouts

- ◆ To reset the arrhythmia alarm timeout period, press the **Alarms** key and then press it again.

Extending the Alarm Pause Time

If your monitor has extended alarm pause enabled, you can extend the alarm pause time. Use this to prevent alarms being indicated, for example, while you are washing a patient or carrying out a procedure. Only extend the alarm pause time when you are sure that clinical personnel are available to monitor the patient's condition closely.

To extend the alarm pause time to five or 10 minutes,

- 1 Select one of the alarm fields. This calls up the **Review Alarms** window.
- 2 Select either the pop-up key **Pause Al. 5 min** or the pop-up key **Pause Al. 10 min**. Each time you select one of these pop-up keys, the Alarm Pause Time is reset to five (or 10) minutes.

Alarm Limits

The alarm limits you set determine the conditions that trigger yellow and red limit alarms. For some measurements (for example, SpO₂), where the value ranges from 100 to 0, setting the high alarm limit to 100 switches the high alarm off. In these cases, the alarms off symbol is not displayed.

WARNING Be aware that the monitors in your care area may each have different alarm settings, to suit different patients. Always check that the alarm settings are appropriate for your patient before you start monitoring.

Viewing Individual Alarm Limits



Alarm limits

You can usually see the alarm limits set for each measurement next to the measurement numeric on the main screen.

If your monitor is not configured to show the alarm limits next to the numeric, you can see them in the appropriate measurement setup menu. Select the measurement numeric to enter the menu and check the limits.

Viewing All Alarm Limits

The **Alarm Limits** overview window lists the currently set alarm limits for all measurements. If an Apnea alarm delay time is set, this is also shown. The **ALARMS OFF** symbol is shown beside the measurement label of any measurement whose alarm switched off.

To open the Alarm Limits window, either select one of the alarm fields then select the **Alarm Limits** pop-up key, or select the **Alarm Limits** SmartKey, if configured.



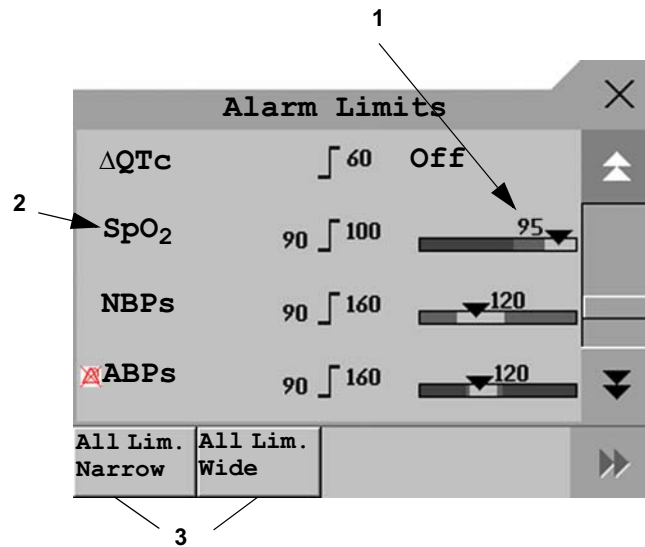

- 1 Graphic view of current yellow and red alarm limits and currently monitored measurement value
Off indicates the measurement is switched off
- 2 Measurement labels, with alarms off symbol where appropriate
- 3 Set narrow or wide alarm AutoLimits for all measurements

- ◆ Select **Show ST Limits** to expand the list of ST leads and view the currently set alarm limits. Selecting **Hide ST Limits** hides the list again.

You can use the pop-up keys that open with the **Alarm Limits** window to perform common tasks:

- **All Lim. Narrow/All Lim. Wide** to set narrow or wide alarm AutoLimits for all measurements.

These pop-up keys are not available in the window for changing individual alarm limits which you access by selecting the measurement label in the **Alarm Limits** window.

Changing Alarm Limits

To change individual measurement alarm limits using the measurement's Setup Menu,

- 1 In the measurement's setup menu, select the alarm limit you want to change. This calls up a list of available values for the alarm limit.
- 2 Select a value from the list to adjust the alarm limit.

For example, to change the alarm limits for SpO₂:

- Touch the high limit on the alarm limits menu button. Choose the high alarm limit from the pop-up list that opens.
- Touch the low limit on the alarm limits menu button. Choose the low alarm limit from the pop-up list that opens.

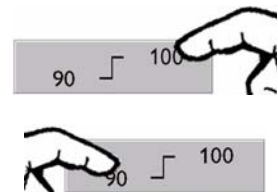

Alternatively, you can use the keys in the measurement Change Limits window, which you access by selecting the measurement label in the **Alarm Limits** window.

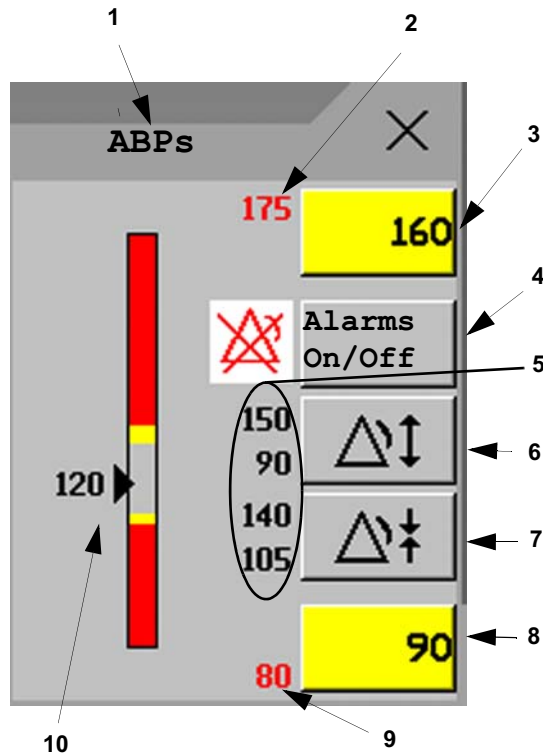

- 1 Parameter label
- 2 High red alarm (view only)
- 3 High yellow alarm field
Select to open a pop-up list of high alarm limits
- 4 Alarms On/Off key - select to toggle between alarms on or off
- 5 Preview Alarm AutoLimits for a measurement before applying
- 6 Select to apply wide AutoLimits
- 7 Select to apply narrow AutoLimits
- 8 Low yellow alarm field
Select to open a pop-up list of low alarm limits
- 9 Low red alarm (view only)
- 10 Graphic view of alarm limits with currently measured value

To change alarm limits,

- 1 Enter the **Alarm Limits** window.
- 2 To set the high alarm limit, select the high yellow alarm field to open a pop-up list of high alarm limits. Select a limit from the list. Repeat to set the low yellow alarm field.

If you set the yellow alarm limit outside the red alarm limit, the monitor will automatically set the red alarm to the yellow alarm limit.

When an ST measurement is in the Change Limits window there are also two pop-up keys available labeled **All ST Narrow**/**All ST Wide**. With these keys you can set Auto Limits for all ST Leads.

About Automatic Alarm Limits (AutoLimits)

The monitor can automatically set alarm limits suited to your individual patient, using the Automatic Alarm Limits function. This tells the monitor to adapt the alarm limits of selected measurements to the measured vital signs within a defined safe limit. The monitor calculates safe AutoLimits for each patient based on the measured values from the last 12 seconds.

The wide and narrow limits have a fixed relationship to the measured value within the non-pathological range. Outside of this range, no auto limits are calculated. To set values outside of the non-pathological range, limits must be changed manually, based on the clinician's judgement about the specific patient.

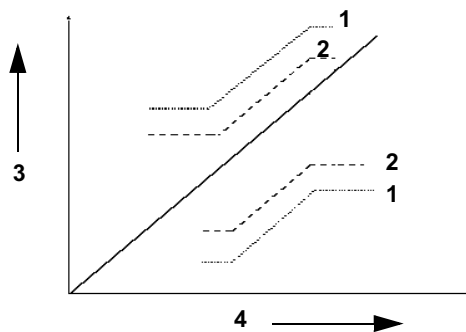

- 1 Wide alarm limits
- 2 Narrow alarm limits
- 3 Alarm Limits
- 4 Measurement value

Limits Narrow sets limits close to the currently measured values for situations where it is critical for you to be informed about small changes in your patient's vital signs.

Limits Wide sets limits further away from the currently measured values for situations where small changes are not so critical.

- ◆ Use the keys in the Change Limits window to apply AutoLimits for individual measurements. These keys are not available if AutoLimits have been disabled for the measurement in the monitor's Configuration Mode.

AutoLimits are not available for all measurements. The list of measurements for which AutoLimits can be used is defined in the monitor's Configuration mode.

Use the Change Limits window to check AutoLimits before you apply them to ensure that they are appropriate for your individual patient and their clinical condition. Once applied, AutoLimits are shown on the monitor screen just like manually-set alarm limits. If the AutoLimits are not appropriate for your patient, you must set alarm limits manually. The limits remain unchanged until you set them again or change them manually.

Documenting Alarm Limits

To print a list of all current alarm limit settings on an available printer:

- 1 Select the **Main Setup** SmartKey.
- 2 Select **Reports** from the Main Setup menu.
- 3 Select **Alarm Limits**.

Reviewing Alarms

You can see which alarms and INOPs are currently active in the respective alarms and INOPs fields at the top of the screen.

To review the history of alarms and INOPs, select the alarms or INOPs field to open the **Review Alarms** window.

All alarms and INOPs are erased from the **Review Alarms** window when you discharge a patient, or if you change to Demonstration Mode.

Review Alarms Window

The **Review Alarms** window contains a list of the most recent alarms and INOPs with date and time information.

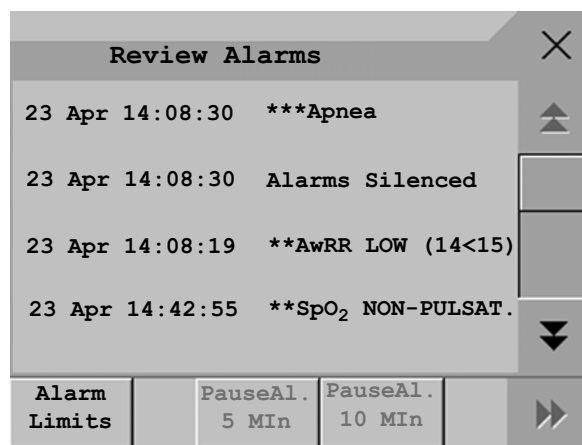

If configured to do so, each alarm is shown with the alarm limit active when the alarm was triggered and the maximum value measured beyond this limit. The **Review Alarms** window also shows when the monitor was switched on (after being switched off for longer than 1 minute) and any changes made to the Alarms On/Off, Standby, Silence or ECG source.

When you select an item from the list, you can get additional information about that item. If you select a high or low limit alarm in the list, the **Graphical Trends** window will open to provide further data. If you select an alert other than a high or low alarm, a help text window opens with more information. Some items in the list are simply log items not related to a patient alert as such (for example, Alarms On or Alarms Off). You cannot see any further information if you select one of these items. When you close these windows you will return to the **Review Alarms** window.

The information in the Review Alarms window is deleted when a patient is discharged, and when you leave Demonstration Mode.

The **Review Alarms** window pop-up keys appear when the window is opened. If alarm pause extension is disabled, the pause pop-up keys are inactive.

Alarm Limits		Pause Al. 5 Min.	Pause Al. 10 Min.
---------------------	--	-----------------------------	------------------------------

Latching Alarms

The alarm latching setting for your monitor defines how the alarm indicators behave when you do not acknowledge them. When alarms are set to non-latching, their indicators end when the alarm condition ends. Switching alarm latching on means that visual and/or audible alarm indications are still displayed or announced by the monitor after the alarm condition ends. The indication lasts until you acknowledge the alarm.

Viewing the Alarm Latching Settings

To see the alarm latching setting for your monitor

- 1 In the monitor's **Main Setup** menu, select **Alarms**.
- 2 Select **Alarm Settings**, and see the **Visual Latching** and **Audible Latching** settings.

This setting can only be changed in Configuration Mode. You should be aware of the settings chosen for your unit. There are three possible choices each for visual and audible latching, Red, Red and Yellow, and Off. These choices can be combined to give the following settings:

Visual Latching	R&Y	R&Y	R&Y	R	R	Off
Audible latching	R&Y	R	Off	R	Off	Off

R = red alarms, Y = yellow alarms

Alarm Latching Behavior

Red and Yellow Measurement Alarms		Non-latching alarms	Visual and audible latching	Visual latching, audible non-latching
Alarm has not been acknowledged.	Alarm condition still present.	Alarm tone on. Alarm lamp on. Alarm message. Flashing numerics.		
	Alarm condition no longer present.	All audible and visual alarm indicators automatically stop.	Alarm tone on. Alarm lamp on. Alarm message. Flashing numerics.	Alarm message. Flashing numerics. Audible alarm indicators automatically stop.
Alarm has been acknowledged.	Alarm condition still present.	Alarm tone off. Alarm lamp off. Alarm message. Flashing numerics. Audible alarm reminder (if configured).		
	Alarm condition no longer present.	Audible and visual alarm indicators automatically stop.		

All INOPs are non-latching. See "Yellow Arrhythmia Alarms" on page 112 for information on one-star yellow alarms latching behavior.

Testing Alarms

When you switch the monitor on, a selftest is started. You must check that the alarms lamps light, one after the other, and that you hear a single tone. This indicates that the visible and audible alarm indicators are functioning correctly. For further testing of individual measurement alarms, perform the measurement on yourself (for example SpO₂ or CO₂) or use a simulator. Adjust alarm limits and check that appropriate alarm behavior is observed.

Alarm Behavior at On/Off

When you switch alarms on, the settings defined in the currently active Profile are used.

If the monitor is switched off for longer than one minute and then switched on again, or after a loss of power lasting longer than one minute, or when a patient is discharged, the monitor can be configured to restore either the alarm settings from the monitor's configured default Profile, or the most recently used alarm settings. After any of these situations, you should check that the alarm settings are appropriate for your patient, and if necessary, select the correct Profile and patient category.

If power is lost for less than one minute, the alarm settings prior to the power loss are restored.

Alarm Recordings

You can set up your monitor so that it automatically triggers alarm recordings at the Information Center, or if configured, to a printer as a realtime report.

- 1 Press the **Main Setup** SmartKey.
- 2 Select **Alarms** from the Main Setup menu.
- 3 Select **Alarm Recording** from the Alarms menu to open the Alarm Recordings menu.
- 4 Select a measurement from those listed for which you want to change the alarm condition that triggers an alarm recording. This opens a pop-up list.
- 5 For the desired measurement(s), choose the alarm condition to trigger an alarm recording:
 - Red Only:** an alarm recording will automatically be triggered when the measurement enters a red alarm condition.
 - Red&Yell:** both yellow and red alarms will trigger an alarm recording.
 - Off:** disables automatic alarm recording.

Refer to the chapter “Recording” for details of how to set up a recording.

Patient Alarms and INOPs

This chapter lists patient alarms and technical alarms (INOPs) alphabetically, irrespective of their priority. INOPs start on page 59. All alarms and INOPs are listed here; the ones which can appear on your monitor will depend on the model and the individual options.

Patient Alarm Messages

The measurement labels and abbreviations for pressure, temperature, SpO₂, and anesthetic agent alarms are explained in the individual chapters.

Some alarms may be shown at the Information Center in shortened form, when transferred through IntelliVue Instrument Telemetry. These shortened alarm texts are included in the list and identified with the note “at Information Center”.

Note that yellow arrhythmia alarms may be shown with one or with two stars, depending on your monitor configuration and the Information Center revision you are using.

Refer to your IntelliBridge Device Driver Instructions for Use for patient alarms from connected external devices.

Alarm Message	From	Condition	Indication
*/**AFIB	ECG/ Arrhythmia	Atrial fibrillation waveform detected	yellow alarm lamp, short yellow audible alarm.
***APNEA or ***APNEA mm:ss sec or ***APNEA >10min	CO ₂ , Resp, Spirometry	Respiration has stopped for longer than the preset apnea time. “mm:ss” denotes the Apnea duration in minutes and seconds.	numeric flashes, red alarm lamp, alarm tone.
***ASYSTOLE	ECG	No QRS detected for a period greater than the asystole threshold (in the absence of Vfib or chaotic ECG).	numeric flashes, red alarm lamp, alarm tone.
**awRR HIGH	CO ₂ , Resp, AGM	The airway respiration rate has exceeded the high alarm limit.	numeric flashes and high limit is highlighted, yellow alarm lamp, alarm tone.
**awRR LOW	CO ₂ , Resp, AGM	The airway respiration rate has dropped below the low alarm limit.	numeric flashes and low limit is highlighted, yellow alarm lamp, alarm tone.
**BIS HIGH	BIS	The Bispectral Index value has exceeded the high alarm limit.	numeric flashes and high limit is highlighted, yellow alarm lamp, alarm tone.

Alarm Message	From	Condition	Indication
**BIS LOW	BIS	The Bispectral Index value has dropped below the low alarm limit.	numeric flashes and low limit is highlighted, yellow alarm lamp, alarm tone.
***BRADY/P xxx<yyy or ***BRADY xxx<yyy	Press, SpO ₂	The heart rate from the Pulse signal has fallen below the bradycardia limit. xxx denotes the lowest measured value; yyy is the bradycardia limit.	numeric flashes and alarm limit is highlighted, red alarm lamp, alarm tone.
**CCO/CCI HIGH	CCO	Continuous Cardiac Output or CC Index is above the high alarm limit.	numeric flashes and high alarm limit is highlighted, yellow alarm lamp, alarm tone.
**CCO/CCI LOW	CCO	Continuous Cardiac Output or CC Index is below the low alarm limit.	numeric flashes and low alarm limit is highlighted, yellow alarm lamp, alarm tone.
**CPP HIGH	CPP	The CPP value has exceeded the high alarm limit.	numeric flashes and high limit is highlighted, yellow alarm lamp, alarm tone
**CPP LOW	CPP	The CPP value has fallen below the low alarm limit.	numeric flashes and low limit is highlighted, yellow alarm lamp, alarm tone.
***DESAT or ***DESAT xxx<yyy	SpO ₂	The SpO ₂ value has fallen below the desaturation alarm limit. xxx denotes the lowest measured value, and yyy is the desaturation limit.	numeric flashes, red alarm lamp, alarm tone.
**etCO₂ HIGH	CO ₂ , Resp, AGM	The end tidal CO ₂ high alarm limit has been exceeded.	numeric flashes and high limit is highlighted, yellow alarm lamp, alarm tone.
**etCO₂ LOW	CO ₂ , Resp, AGM	The end tidal CO ₂ value has fallen below the low alarm limit.	numeric flashes and low limit is highlighted, yellow alarm lamp, alarm tone.
**etO₂ HIGH	O ₂ , AGM	The end tidal O ₂ high alarm limit has been exceeded.	numeric flashes and high limit is highlighted, yellow alarm lamp, alarm tone.
**etO₂ LOW	O ₂ , AGM	The end tidal O ₂ value has fallen below the low alarm limit.	numeric flashes, and low limit is highlighted, yellow alarm lamp, alarm tone.
*/**/*** EVENT : <GRP>	Event surveillance	An event has occurred and the event notification is configured to alarm. <GRP> is the event group	event group name flashes, yellow or red alarm lamp and alarm tone
*/**/*** EVENT at Information center	Event surveillance	An event has occurred and the event notification is configured to alarm. Check on the monitor for more details on event group.	(on monitor) event group name flashes, yellow or red alarm lamp and alarm tone
***EXTREME BRADY	ECG	The bradycardia limit has been exceeded.	numeric flashes and alarm limit is highlighted, red alarm lamp, alarm tone.
***EXTREME TACHY	ECG	The tachycardia limit has been exceeded.	numeric flashes and alarm limit is highlighted, red alarm lamp, alarm tone.

Alarm Message	From	Condition	Indication
**HR HIGH	ECG	The heart rate high alarm limit has been exceeded.	numeric flashes and high limit is highlighted, yellow alarm lamp, alarm tone. If configured to short yellow, the sound switches off after 5 seconds if Arrhythmia is On.
**HR LOW	ECG	The heart rate has fallen below the low alarm limit.	numeric flashes and low limit is highlighted, yellow alarm lamp, alarm tone. If configured to short yellow, the sound switches off after 5 seconds if Arrhythmia is On.
*/**IRREGULAR HR	ECG/ Arrhythmia	Consistently irregular heart rhythm.	numeric flashes, yellow alarm lamp, short yellow audible alarm.
*/**MISSED BEAT	ECG/ Arrhythmia	No beat detected for 1.75*R-R interval, or if HR>120bpm no beat detected for one second (non-paced patients only).	numeric flashes, yellow alarm lamp, short yellow audible alarm.
*/**MULTIFORM PVCs	ECG/ Arrhythmia	Two differently shaped Vs detected, each occurring at least twice within the last 300 beats and at least once within the last 60 beats.	numeric flashes, yellow alarm lamp, short yellow audible alarm.
**NBP HIGH	NBP	The measured NBP value is above the high alarm limit. s, d, or m after the label indicates whether the systolic, diastolic or mean pressure has crossed the limit.	numeric flashes and high limit is highlighted, yellow alarm lamp, alarm tone.
**NBP LOW	NBP	The measured NBP value is below the low alarm limit. s, d, or m after the label indicates whether the systolic, diastolic or mean pressure has crossed the limit.	numeric flashes and low limit is highlighted, yellow alarm lamp, alarm tone.
*/**NON-SUSTAIN VT	ECG/ Arrhythmia	A run of Vs having a ventricular HR>V-Tach HR limit, but lasting for less than the V-Tach Run limit has been detected.	numeric flashes, yellow alarm lamp, short yellow audible alarm.
*/**PACER NOT CAPT	ECG/ Arrhythmia (paced patients only)	A missed beat with a pace pulse was detected.	numeric flashes, yellow alarm lamp, short yellow audible alarm.
*/**PACER NT PACING	ECG/ Arrhythmia (paced patients only)	A missed beat without a pace pulse was detected.	numeric flashes, yellow alarm lamp, short yellow audible alarm.
*/**PAIR PVCs	ECG/ Arrhythmia	A non-ventricular contraction, followed by two ventricular contractions, followed by a non-ventricular contraction has been detected.	numeric flashes, yellow alarm lamp, short yellow audible alarm.
*/**PAUSE	ECG/ Arrhythmia	No beat detected for a period greater than the pause threshold.	numeric flashes, yellow alarm lamp, short yellow audible alarm.

Alarm Message	From	Condition	Indication
***<Pressure> DISCONNECT	PRESS	The pressure is non-pulsatile and the mean pressure is continuously less than 10mmHg (1.3kPa). This alarm occurs only with arterial pressures (P, ABP, ART, Ao, BAP, FAP, PAP, UAP, P1, P2, P3, P4).	numeric flashes, red alarm lamp, alarm tone.
***<Pressure> HIGH	PRESS	The measured pressure value is above the extreme high alarm limit. s, d, or m after the label indicates whether the systolic, diastolic or mean pressure has crossed the limit.	numeric flashes, high limit is highlighted, red alarm lamp, alarm tone.
**<Pressure> HIGH	PRESS	The measured pressure value is above the high alarm limit. s, d, or m after the label indicates whether the systolic, diastolic or mean pressure has crossed the limit.	numeric flashes, high limit is highlighted, yellow alarm lamp, alarm tone.
***<Pressure> LOW	PRESS	The measured pressure value is below the extreme low alarm limit. s, d, or m after the label indicates whether the systolic, diastolic or mean pressure has crossed the limit.	numeric flashes and low limit is highlighted, red alarm lamp, alarm tone.
**<Pressure> LOW	PRESS	The measured pressure value is below the low alarm limit. s, d, or m after the label indicates whether the systolic, diastolic or mean pressure has crossed the limit.	numeric flashes and low limit is highlighted, yellow alarm lamp, alarm tone.
**Pulse HIGH	PRESS SpO ₂	The pulse rate has exceeded the high alarm limit.	numeric flashes and high limit is highlighted, yellow alarm lamp, alarm tone.
**Pulse LOW	PRESS SpO ₂	The pulse rate has dropped below the low alarm limit.	numeric flashes and low limit is highlighted, yellow alarm lamp, alarm tone.
*/**PVCs/min HIGH	ECG/ Arrhythmia	More premature ventricular contractions have been detected in a minute than the limit.	numeric flashes, yellow alarm lamp, short yellow audible alarm.
**QTc HIGH	ECG/QT	QTc value has exceeded the QTc high limit for more than 5 minutes	numeric flashes, yellow alarm lamp, alarm tone.
**ΔQTc HIGH	ECG/QT	ΔQTc value has exceeded the ΔQTc high limit for more than 5 minutes	numeric flashes, yellow alarm lamp, alarm tone.
*/**R-ON-T PVCs	ECG/ Arrhythmia	For HR <100, a PVC with R-R interval < 1/3 the average interval followed by a compensatory pause of 1.25 x average R-R interval or two such Vs without compensatory pause occurring within 5 minutes of each other. (When HR >100, 1/3 R-R interval is too short for detection.)	numeric flashes, yellow alarm lamp, short yellow audible alarm.
**RR HIGH	RESP	The respiration rate has exceeded the high alarm limit.	numeric flashes and high limit is highlighted, yellow alarm lamp, alarm tone.

Alarm Message	From	Condition	Indication
**RR LOW	RESP	The respiration rate has dropped below the low alarm limit.	numeric flashes and low limit is highlighted, yellow alarm lamp, alarm tone.
*/**RUN PVCs HIGH	ECG/ Arrhythmia	A run of PVCs greater than 2 was detected.	numeric flashes, yellow alarm lamp, short yellow audible alarm.
**<SO₂ label> HIGH	SvO ₂ /SO ₂	The the measured intravascular oxygen saturation has exceeded the high limit.	numeric flashes and high alarm limit is highlighted, yellow alarm lamp, alarm tone.
**<SO₂ label> LOW	SvO ₂ /SO ₂	The measured intravascular oxygen saturation has fallen below the low limit.	numeric flashes and low alarm limit is highlighted, yellow alarm lamp, alarm tone.
**<SpO₂ label> HIGH	SpO ₂	The arterial oxygen saturation has exceeded the high alarm limit.	numeric flashes and high limit is highlighted, yellow alarm lamp, alarm tone.
**<SpO₂ label> LOW	SpO ₂	The arterial oxygen saturation has fallen below the low alarm limit.	numeric flashes and low limit is highlighted, yellow alarm lamp, alarm tone.
**ST<n> HIGH	ECG/ST	The ST elevation in lead <n> is higher than the limit.	numeric flashes and high alarm limit is highlighted, yellow alarm lamp, alarm tone.
**ST<n> LOW	ECG/ST	The ST depression in lead <n> is lower than the limit.	numeric flashes and low alarm limit is highlighted, yellow alarm lamp, alarm tone.
**ST MULTI <n>,<n>	ECG/ST	The ST depression or elevation is outside of the limit in two or more leads <n> and <n>	numeric flashes, yellow alarm lamp, alarm tone
**ST MULTI at Information Center	ECG/ST	The ST depression or elevation is outside of the limit in two or more leads. Check on the monitor for more details about which leads are affected.	(on monitor) numeric flashes, yellow alarm lamp, alarm tone
*/**SVT	ECG/ Arrhythmia	A run of supraventricular beats greater than the SVT run limit has been detected and the HR has exceeded the SVT HR limit.	numeric flashes, yellow alarm lamp, alarm tone.
***TACHY/P xxx>yyy or ***TACHY xxx>yyy	Press, SpO ₂	The heart rate from the Pulse signal has exceeded the tachycardia limit. xxx denotes the highest measured value; yyy is the tachycardia limit.	numeric flashes, alarm limit is highlighted, red alarm lamp, alarm tone.
**Tblood HIGH	C.O.	The blood temperature value has exceeded the high alarm limit.	numeric flashes, high alarm limit is highlighted, yellow alarm lamp, alarm tone.
**Tblood LOW	C.O.	The blood temperature value has fallen below the low alarm limit.	numeric flashes, low alarm limit is highlighted, yellow alarm lamp, alarm tone.
**tcpO₂ HIGH/ **tcpCO₂ HIGH	tcGas	The tcpO ₂ or tcpCO ₂ value has exceeded the high alarm limit.	numeric flashes, high alarm limit is highlighted, yellow alarm lamp, alarm tone.
**tcpO₂ LOW/ **tcpCO₂ LOW	tcGas	The tcpO ₂ or tcpCO ₂ value has fallen below the low alarm limit.	numeric flashes, low alarm limit is highlighted, yellow alarm lamp, alarm tone.

Alarm Message	From	Condition	Indication
//****TELE ALARM	Telemetry	This is a generic alarm from the telemetry system. The specific alarm cause is indicated in the alarm message in the Telemetry Data Window.	yellow or red alarm lamp and alarm tone
**<Temperature label> HIGH	TEMP	The temperature has exceeded the high alarm limit.	numeric flashes and high limit is highlighted, yellow alarm lamp, alarm tone.
**<Temperature label> LOW	TEMP	The temperature has fallen below the low alarm limit.	numeric flashes and low limit is highlighted, yellow alarm lamp, alarm tone.
/VENT BIGEMINY	ECG/ Arrhythmia	A dominant rhythm of N, V, N, V (N = supraventricular beat, V = ventricular beat) was detected.	numeric flashes, yellow alarm lamp, short yellow audible alarm.
***VENT FIB/TACH	ECG	A fibrillatory waveform for 4 consecutive seconds was detected.	numeric flashes, red alarm lamp, alarm tone.
/VENT RHYTHM	ECG/ Arrhythmia	A dominant rhythm of adjacent Vs > vent rhythm limit and ventricular HR < VTach HR limit was detected.	numeric flashes, yellow alarm lamp, short yellow audible alarm.
/VENT TRIGEMINY	ECG/ Arrhythmia	A dominant rhythm of N, N, V, N, N, V (N = supraventricular beat, V = ventricular beat) was detected.	numeric flashes, yellow alarm lamp, short yellow audible alarm.
***VTACH	ECG, Arrhythmia	Ventricular tachycardia has been detected (Consecutive PVCs exceed V-Tach Run limit and HR exceeds V-Tach HR limit).	numeric flashes, red alarm lamp, alarm tone.
/**VueLink ALARM at Information Center	VueLink	A yellow (**) or red (***) patient alarm is present on the VueLink module. Check the monitor display for more detailed alarm information.	(on monitor) yellow or red alarm lamp, alarm tone

Technical Alarm Messages (INOPs)

If an INOP interrupts monitoring and alarm detection, the measurement numeric will be replaced by –?–. If an INOP may lead to unreliable measurement values, a ? appears next to the numeric.

INOP Message, Indication	Source	What to do
ABP INOPS	PRESS	See <Pressure label> INOPS (under Pressure).
ALL ECG ALARMS OFF	ECG/ Arrhythmia	All ECG alarms have been switched off, or the HR alarm source is not ECG. To resume ECG alarm generation, switch ECG alarms on or select ECG as the alarms source.
Ao INOPS	PRESS	See <Pressure label> INOPS (under Pressure).
ART INOPS	PRESS	See <Pressure label> INOPS (under Pressure).
AWF CHANGE SCALE	Spirometry	Airway flow signal exceeds range of selected scale. Adjust scale to display complete wave.
AWP CHANGE SCALE	Spirometry	Airway pressure signal exceeds range of selected scale. Adjust scale to display complete wave
AWV CHANGE SCALE	Spirometry	Airway volume signal exceeds range of selected scale. Adjust scale to display complete wave.
Bad Serverlink INOP tone	Monitor	1) An MMS with an incompatible software revision is connected to the monitor. This combination does not allow monitoring, OR 2) You cannot use this combination of monitor, MMS and cable. Switch off the monitor and contact your service personnel.
BAP INOPS	PRESS	See <Pressure label> INOPS (under Pressure).
BATT EMPTY INOP tone, battery LED flashes During this INOP, alarms cannot be paused or switched off.	Battery	The estimated remaining battery-powered operating time is less than 10 minutes. Replace the battery immediately. If the condition persists and the monitor is not connected to mains power, this INOP is re-issued two minutes after you acknowledge it.
BATT INCOMPAT INOP tone	Battery	The battery cannot be used with this monitor. Replace with the correct battery (M4607A).
BATT LOW INOP tone	Battery	The estimated battery-powered operating time remaining is less than 20 minutes.
BATT MALFUNCTION INOP tone, battery LED flashes During this INOP, alarms cannot be paused or switched off unless the monitor is connected to mains power.	Battery	The monitor cannot determine the battery status. If this INOP persists, replace the faulty battery. If the condition persists and the monitor is not connected to mains power, this INOP is re-issued two minutes after you acknowledge it. Place the battery in a different monitor or in a battery charger. If the same INOP is shown, contact your service personnel.
BATTERIES EMPTY or BATT 1/ BATT 2 EMPTY INOP tone, battery LED flashes During this INOP, alarms cannot be paused or switched off.	Batteries	The estimated remaining battery-powered operating time of the indicated battery or batteries is less than 10 minutes. Replace the batteries immediately. If the condition persists and the monitor is not connected to mains power, this INOP is re-issued two minutes after you acknowledge it.
BATTERIES INCOMP or BATT 1/ BATT 2 INCOMPAT INOP tone	Batteries	The indicated battery or batteries cannot be used with this monitor. Replace with the correct battery or batteries as specified in this book.

INOP Message, Indication	Source	What to do
BATTERIES LOW or BATT 1/ BATT 2 LOW INOP tone	Batteries	The estimated battery-powered operating time remaining is less than 20 minutes.
BATTERIES MALFUNC. or BATT 1/BATT 2/ BATTERY MALFUNC. INOP tone, battery LED flashes During this INOP, alarms cannot be paused or switched off unless the monitor is connected to mains power.	Batteries	The monitor cannot determine the battery status. If this INOP persists, replace the faulty battery or batteries. If the condition persists and the monitor is not connected to mains power, this INOP is re-issued two minutes after you acknowledge it. Place the batteries in a different monitor or in a battery charger. If the same INOP is shown, contact your service personnel.
BATTERY LOW T	Telemetry	The battery in the Telemetry device is low and must be replaced soon.
BATT 1/BATT 2 MISSING INOP tone. During this INOP, alarms cannot be paused or switched off.	Batteries	The monitor requires two batteries but can detect only one battery. Insert the missing battery immediately.
BIS CABLE INCOMPAT INOP tone.	BIS	The semi-reusable sensor cable connected is unknown or not supported by your software revision. Replace it with a Philips-supported sensor cable.
BIS CABLE USAGE INOP tone.	BIS	The semi-reusable sensor cable has exceeded the maximum number of uses. Replace the cable.
BIS DSC DISCONN INOP tone	BIS	DSC is not properly connected OR either DSC or BIS engine may be faulty. Make sure that the DSC is properly connected to the BIS Engine. If INOP persists, replace DSC with a known good one of the same type. If INOP persists replace BIS engine. Silencing this INOP switches the measurement off.
BIS DSC INCOMPT INOP tone	BIS	DSC is not supported by the BIS engine or new DSC connected to an old BIS engine. A software upgrade may be required. Contact your service personnel.
BIS DSC MALFUNC	BIS	Electrocautery used during self-test OR malfunction in the DSC hardware. Make sure not to use electrocautery during the self-test procedure. Disconnect and reconnect the DSC to the BIS engine. If the INOP persists, replace the DSC or contact your service personnel.
BIS DSC UPDATE INOP tone	BIS	DSC update currently being carried out. This INOP will disappear when the DSC update is finished. Do not disconnect the DSC during the update. No action is needed.
BIS ELECTR. DISC INOP tone.	BIS	One or more electrodes are not connected to the semi-reusable sensor cable. Check all electrode connections.
BIS ENGINE DISCONN INOP tone	BIS	BIS engine not connected OR Module Cable defective. Make sure that the Module Cable is properly connected. If INOP persists, replace the Module Cable. Silencing this INOP switches the measurement off.
BIS ENGINE INCOMPT INOP tone	BIS	BIS engine software is not supported. A software upgrade may be required. Contact your service personnel. MP20/30 - BIS engine not supported.

INOP Message, Indication	Source	What to do
BIS ENGINE MALFUNC INOP tone	BIS	Malfunction in the BIS engine hardware. Disconnect and reconnect the BIS engine. If the INOP persists, replace BIS engine.
BIS EQUIP MALF INOP tone	BIS	There is a malfunction in the BIS hardware. Unplug and replug the BIS module. If the INOP persists, contact your service personnel.
BIS HIGH IMPEDANCE INOP tone may sound	BIS	Impedance of one or more electrode(s) is above the valid range, most often caused by bad skin preparation. Check the sensor montage and press the electrode pads firmly. If this INOP persists, replace the sensor(s) in question using correct skin preparation. If INOP persists, contact your service personnel.
BIS IMPEDANCE CHCK INOP tone may sound	BIS	The Cyclic Impedance check is running. It will stop automatically if all impedances are within the valid range. If any electrodes do not pass the impedance test, check the sensor montage and press the electrode pads firmly. To manually stop the Cyclic Impedance Check, select Cyclic Check off in the Setup BIS menu.
BIS ISOELECTRC EEG	BIS	No discernible EEG activity is detected for longer than one minute. Check the patient. Check that the electrodes are properly connected.
BIS LEAD OFF INOP tone may sound	BIS	One or more electrodes have no skin contact and therefore impedances cannot be measured. Check the sensor montage and press the electrode pads firmly. If this INOP persists, replace the sensor(s) in question, using correct skin preparation.
BIS OVERCURRENT INOP tone	BIS	Unplug and replug the BIS module or, f or the MP20/MP30, disconnect and reconnect the BISx from the Interface board. If the INOP persists, contact your service personnel.
BIS SENSOR DISCONN INOP tone	BIS	The sensor is not properly connected to the patient interface cable (PIC) and/or the PIC is not properly connected to the DSC or BISx, or the sensor or PIC or DSC or BISx may be faulty. Check all the connections. Disconnect and reconnect the sensor, PIC, DSC, BISx. If the INOP persists, replace the sensor. If the INOP persists, replace PIC. If INOP persists, contact your service personnel. Silencing this INOP switches the measurement off.
BIS SENSOR INCOMPT INOP tone	BIS	Unsupported sensor connected or sensor type unknown or not supported by your software revision. Replace the sensor, using only Philips supported sensors.
BIS SENSOR MALFUNC INOP tone	BIS	Malfunction in the sensor hardware, most often caused by liquids permeating into the connectors OR patient interface cable (PIC) or DSC or BISx may be faulty. Replace the sensor. Manually initiate a Cyclic Impedance Check. Make sure all electrodes pass the test. Make sure that the both sides of the PIC connector (between PIC and sensor) are dry. If you are not sure that the connector is dry, replace the PIC until it has dried. If this INOP persists, contact your service personnel.

INOP Message, Indication	Source	What to do
BIS SENSOR USAGE INOP tone	BIS	Excessive sensor usage. Replace sensor. A Cyclic Impedance Check will start automatically.
BIS SQI < 15% (INOP tone) OR BIS SQI < 50% (no INOP tone)	BIS	If the signal quality is below 50%, BIS numerics cannot be reliably derived. If the signal quality is below 15%, no BIS numerics can be derived. This may occur as a result of artifacts such as those generated from motion or the presence of electrocautery devices. Make sure the sensor is properly attached to the patient. Manually initiate a Cyclic Impedance Check. Make sure all electrodes pass the test. Make sure the patient is completely relaxed (even small motions of the facial muscles affect the signal quality).
BIS UNPLUGGED INOP tone	BIS	Plug in the BIS module. Silencing this INOP switches off the measurement.
BISx DISCONNECTED INOP tone	BIS	The BISx is not connected to the BIS module or the BIS interface board. Silencing this INOP switches the measurement off.
BISx INCOMPATIBLE INOP tone	BIS	The BISx software is not compatible with the BIS module or with the MP20/MP30 monitor software. A software upgrade may be required. Contact your service personnel.
BISx MALFUNCTION INOP tone	BIS	The BISx is faulty. Disconnect and reconnect it to the module or BIS interface board. If the INOP persists, replace the BISx. MP20/MP30 - Malfunction on interface board. If the INOP persists, contact your service personnel.
CANNOT ANALYZE ECG	ECG/ Arrhythmia	The arrhythmia algorithm cannot reliably analyze the ECG data. Check the ECG signal quality of the selected primary and secondary leads. If necessary, improve lead position or reduce patient motion. If you have arrhythmia analysis on, and you are not getting a reliable HR because the signal is below a minimum amplitude, unstable, or contains artifact, <i>and</i> you have tried to improve the system performance by choosing another lead and changing electrodes, you should consider turning arrhythmia analysis off.
CANNOT ANALYZE QT	QT	The QT algorithm cannot generate a valid QT value for more than 10 minutes, or 1 minute in the initial phase.
CANNOT ANALYZE ST	ST	The ST algorithm cannot generate a valid ST value. Possible causes are large variations in the measured ST values for consecutive beats, or ventricular paced beats. Review the ECG signal quality and the ST measurement points. If the patient has a ventricular pacemaker, ST analysis is not possible.
CCI NO BSA CCI numeric unavailable INOP tone	C.O.	CCI cannot be calculated because the patient's body surface area is unknown. Enter the patient weight and height to provide the BSA for CCI calculation.
CCO BAD PRESS SIGN numeric is replaced by -?- INOP tone	C.O.	The arterial pressure wave can currently not be used for pulse contour calculation for CCO or CCI measurement. Possible causes are air bubbles in the tubing or a physiological condition, for example severe arrhythmia.

INOP Message, Indication	Source	What to do
CCO NO <Pressure label> numeric is replaced by -?- INOP tone may sound	C.O.	CCO/CCI cannot be calculated. Make sure that the pressure chosen in the Setup CCO menu under CCO From matches the pressure measured with the arterial catheter for CCO measurement. A pressure from an external device cannot be used. Select another pressure label, either ABP, Ao, ART, BAP, FAP, or UAP.
CCO NO CALIBRATION numeric is replaced by -?-	C.O.	The CCO measurement is currently not calibrated.
CCO NO PRESS at Information Center	C.O.	CCO/CCI cannot be calculated. Make sure that the pressure chosen in the Setup CCO menu under CCO From matches the pressure measured with the arterial catheter for CCO measurement. A pressure from an external device cannot be used. Select another pressure label, either ABP, Ao, ART, BAP, FAP, or UAP.
CCO NOT SUPPORTED numeric is replaced by -?- INOP tone	C.O.	A catheter for transpulmonary C.O. measurements has been unplugged and replaced with a Right Heart C.O. catheter, or the measurement mode has been changed manually. Silencing this INOP switches the measurement off.
CCO/CCI OVERRANGE numeric is replaced by -?- INOP tone	C.O.	The measured CCO or CCI value is not within the specified range for CCO/CCI measurement.
CCO <Pressure label> INVALID numeric is replaced by -?- INOP tone may sound	C.O.	The arterial pressure selected for pulse contour calculation for CCO is available but currently invalid. Make sure the pressure transducer is connected and the zero calibration is valid.
CCO PRESS INVALID at Information Center	C.O.	The arterial pressure selected for pulse contour calculation for CCO is available but currently invalid. Make sure the pressure transducer is connected and the zero calibration is valid.
CCO PRESS OVERRANG numeric is replaced by -?- INOP tone	C.O.	The mean value of the arterial pressure values used for pulse contour calculation for CCO is below 0 mmHg or above 300 mmHg.
CCO PULSE OVERRANG numeric is replaced by -?- INOP tone	C.O.	The pulse rate of the pressure used for pulse contour calculation for CCO is below 30 bpm or above 240 bpm.
CCO/Tb1 NO TRANSD Numeric is replaced by -?- INOP tone	C.O.	No transducer attached to the module or catheter disconnected.
CCO RECALIBRATE numeric is replaced by -?-	C.O.	The most recent CCO or CCI calibration was made over 8 hours ago or the arterial pressure measurement used for CCO calculation has been zeroed after the CCO calibration was performed. You should recalibrate CCO or CCI with transpulmonary C.O. measurements at least every 8 hours or when the hemodynamic condition of the patient has changed. The pressure measurement must be zeroed before a CCO calibration.
CENTRAL : TELE ONLY INOP tone	Monitor	System connectivity via telemetry device is limited (No alarms, only local numerics) when in companion mode and host monitor does not have system connectivity. Only telemetry device parameters can be displayed at central station.
Charge BATT1/BATT2 now INOP tone	Batteries	Battery must be charged. Connect the monitor to mains power or exchange the battery.

INOP Message, Indication	Source	What to do
CHARGER MALFUNC INOP tone, battery LED may flash	Batteries	There is a problem with the battery charger in the monitor. Connect the monitor to mains power and contact your service personnel.
Check Alarm Lamps INOP tone.	Monitor	Perform a visual check of the alarm lamp to establish whether there is a problem. Contact your service personnel to check the internal connections to the alarm lamps.
CHECK BATT TEMP INOP tone	Battery	The temperature of one or both batteries is too high. Check that ventilation openings (if applicable) are not blocked and monitor is not exposed to heat.
Check DrugSettings INOP tone	Monitor	There was a problem loading the drug settings. Check that the settings are complete and correct.
Check ECG Settings INOP tone	Telemetry	Synchronization of ECG settings between the monitor and Information Center has failed. Check that the ECG settings in use are appropriate.
!!CHECK ECG SOURCE INOP tone	Monitor	The telemetry device and the monitor both have valid ECG signals. Unpair the telemetry device and the monitor if they are no longer used for the same patient.
Check Flex Texts INOP tone	Monitor	Check the names of the monitor menus, for example the labels for screens, profiles, event or trend group names, before you resume monitoring. If they are unexpected, there may be a problem with the monitor software. Contact your service personnel.
CheckInternVoltage at Information Center	Monitor	Potential problem with alarm lamps, display or interfaces detected. Contact your service personnel. This INOP will appear on the monitor as Check Monitor Func .
Check Keyboard INOP tone	Monitor	Perform a visual and functional check of the keyboard. Contact your service personnel.
Check Main Board 2 INOP tone.	Monitor	There is a problem with the second main board in the monitor. Contact your service personnel.
Check Monitor Func INOP tone.	Monitor	Potential problem with alarm lamps, display or interfaces detected. Contact your service personnel. This INOP may appear on the Information Center as CheckInternVoltage .
Check Monitor Temp INOP tone	Monitor	The temperature inside the monitor is too high. Check that the monitor ventilation is not obstructed. If the situation continues, contact your service personnel.
Check Mouse Device INOP tone.	Monitor	Perform a visual and functional check of the mouse input device. Contact your service personnel.
Check MSL Voltage INOP tone	Monitor/ Multi- Measuremt Module	There is a problem with the voltage of the Measurement Link (MSL). Contact your service personnel.
Check Network Conf INOP tone	Monitor	The monitor is receiving network topology information from more than one source, e.g. the Database Server and an Application Server. Contact your service personnel.
Check Nurse Relay INOP tone	Monitor	There is a problem with the connection to the nurse relay. Contact your service personnel.
!!Check Pairing INOP tone	Monitor	There is a problem with device pairing. Check that the monitor and telemetry device are correctly paired.

INOP Message, Indication	Source	What to do
Check Screen Res INOP tone	Monitor	The Screen you have selected uses a resolution which is not supported by the display. The monitor will show a generic Screen instead until you select a different Screen. Contact your service personnel if you want the Screen deleted from the Profile(s) to avoid this in future.
Check Settings INOP tone	Monitor	If this INOP appears, check the monitor and patient settings before you resume monitoring. If the settings are unexpected, there may be a problem with the monitor software. Contact your service personnel.
Check SpeedPoint INOP tone.	Monitor	Perform a visual and functional check of the SpeedPoint input device. Contact your service personnel.
Check Touch Input INOP tone	Monitor	Perform a visual and functional check of the touch input device. Contact your service personnel.
Check Waves INOP tone	Monitor	The options purchased with this monitor may not support the number of waves required to show the selected Screen, so some waves or high resolution trends are missing from the Screen. Select a different Screen with fewer waves. Contact your service personnel if you want the Screen deleted from the Profile(s) to avoid this in future.
CHK ECG Sync Cable INOP tone	Monitor	The ECG Sync is detecting an invalid signal, or the ECG Sync cable is disconnected.
Chk IndepDsp Cable	Monitor	The monitor cannot communicate with the D80 Intelligent Display. Check the MSL coupling cable. The end with the grey connector must be connected to the Intelligent Display.
CHK MSL Connection INOP tone	Monitor	Check that the MSL connector or cable are properly connected. Check the cable and connector for damage.
Chk SpO₂T Settings INOP tone	Telemetry	Synchronization of SpO ₂ T settings between the monitor and Information Center has failed. Check that the SpO ₂ T settings in use are appropriate.
C LEAD OFF HR Numeric is replaced by -?- for 10 seconds. INOP tone.	ECG	The C electrode (AAMI: V electrode) has become detached from the patient or the lead set has been changed. Reattach the electrode or select New Lead Setup in the Setup ECG menu to confirm the new lead set.
CO₂ AUTO ZERO Numeric is replaced by a -?- if the Autozero lasts >15 sec, INOP tone sounds.	CO ₂	The automatic zero calibration is in progress. This typically takes 10 seconds. During this time the CO ₂ values may not be updated, or they may be replaced by -?-. Wait until the zero calibration is complete to resume monitoring.
CO₂ CAL MODE CO ₂ numeric displays current CO ₂ value for accuracy check	CO ₂	Currently no calibration is running. Accuracy can be checked by placing the transducer on the two cells of the calstick and starting calibration. To start monitoring, leave Cal. Mode.
CO₂ CAL RUNNING Numeric is replaced by a -?-	CO ₂	Wait until calibration is finished.
CO₂ CHANGE SCALE	CO ₂	The CO ₂ wave is clipped. Select a more appropriate wave scale to display the whole wave.
CO₂ CHK ADAPTER Numeric is replaced by a -?- INOP tone.	CO ₂	Check that the sensor is connected to the airway adapter, clean the airway adapter, if necessary. Perform a zero calibration. If the INOP persists, contact your service personnel.
CO₂ CHECK CAL Numeric is replaced by a -?- INOP tone.	CO ₂	The CO ₂ value is outside the measurement range. Perform an accuracy check for both calstick cells and, if necessary, recalibrate the transducer.

INOP Message, Indication	Source	What to do
CO₂ DEACTIVATED INOP tone.	CO ₂	The CO ₂ measurement label in the measurement device has been deactivated by deactivating the label in the Measurement Selection window. The measurement automatically disappears from the display. To switch the measurement on again, reactivate the measurement label in the Measurement Selection window.
C.O. DEACTIVATED INOP tone.	C.O.	The Cardiac Output measurement label in the measurement device has been deactivated by deactivating the label in the Measurement Selection window. The measurement automatically disappears from the display. To switch the measurement on again, reactivate the measurement label in the Measurement Selection window.
C.O. EQUIP MALF Numeric is replaced by a -?- INOP tone.	C.O.	There is a problem with the C.O. hardware. Contact your service personnel.
CO₂ EQUIP MALF Numeric is replaced by -?- INOP tone.	CO ₂	The Measurement Extension is faulty. Unplug and replug the Multi-Measurement Module with Extension. If you are using the mainstream method, unplug and replug the transducer or try another transducer. If the INOP persists, contact your service personnel.
CO₂ FAILED CAL Numeric is replaced by -?- INOP tone.	CO ₂	Make sure that the Cal cell was changed between CAL1 and CAL2. Repeat the calibration. If the INOP reappears, try another transducer. If the INOP persists, contact your service personnel.
CO₂ NO SENSOR Numeric is replaced by -?- INOP tone.	CO ₂	There is no CO ₂ sensor connected. If you silence this INOP the CO ₂ measurement will be switched off.
CO₂ NO TRANSDUC Numeric is replaced by -?- INOP tone.	CO ₂	There is no CO ₂ transducer connected. If you replace the transducer, the new transducer must be calibrated. If you silence this INOP the CO ₂ measurement will be switched off.
CO₂ NO TUBING Numeric is replaced by -?- INOP tone.	CO ₂	Either the sample line is disconnected, or an incorrect line is attached. Check the connection. If necessary, connect another sample line (Use only the approved accessories). If you silence this INOP, the measurement will be switched off.
(!!!) CO₂ OCCLUSION Numeric is replaced by a -?- INOP tone.	CO ₂	The sample line or exhaust tube is blocked. Check the tubing, then disconnect and reconnect the sample line. If the INOP persists, connect a new sample line.
CO₂ OVERRANGE Numeric is replaced by -?- INOP tone.	CO ₂	The CO ₂ value is higher than the measurement range. If you suspect a false high value, contact your service personnel.
CO₂ PUMP OFF Numeric is replaced by a -?-.	CO ₂	The pump has been switched off for fifteen minutes. To switch it on again, select Pump On in the Setup CO ₂ menu.
CO₂ PURGING Numeric is replaced by a -?- INOP tone.	CO ₂	The Filterline is being purged to remove an occlusion in the line or airway adapter. If the occlusion is removed, the INOP will disappear. If not, the INOP CO₂ OCCLUSION is displayed.
CO₂ SENS. WARMUP Numeric is displayed with a -?- Microstream CO ₂ : INOP tone. Mainstream CO ₂ : no INOP tone	CO ₂	Wait until the sensor reaches operating temperature and the INOP disappears.

INOP Message, Indication	Source	What to do
C.O. UNPLUGGED numeric is replaced by -?- INOP tone.	C.O.	Plug in the C.O. module. Silencing this INOP switches off the measurement.
CO₂ UPDATE FW Numeric is replaced by a -?- INOP tone.	CO ₂	The software in the Measurement Extension does not match the software in the MMS. Contact your service personnel.
CO₂ WAIT CAL2 Numeric is replaced by a -?- INOP tone.	CO ₂	Calibration on the first calstick cell is complete. Place the transducer on the other calstick cell and start the CAL2 calibration cycle.
CO₂ ZERO FAILED Numeric is replaced by a -?- INOP tone.	CO ₂	An error occurred during the last zero calibration. Check the airway adapter and clean, if necessary. Perform another zero calibration. If the INOP persists, contact your service personnel.
CO₂ ZERO REQU'D Numeric is replaced by a -?- INOP tone	CO ₂	Perform zero calibration for the CO ₂ sensor. If the INOP persists, contact your service personnel.
CO₂ ZERO RUNNING	CO ₂	Wait until zero calibration is finished.
CPP CHK SOURCES Numeric is replaced by a -?- INOP tone.	CPP	Not all measurements or values required to perform the calculation are available. Check the measurement sources.
CPP CHK UNITS Numeric is replaced by a -?- INOP tone.	CPP	The monitor has detected a conflict in the units used for this calculation. Check the unit settings.
!!!/!!!!CUFF NOT DEFLAT Numeric is displayed with a -?- Severe yellow/red INOP tone. During this INOP, alarms cannot be paused or switched off.	NBP	Remove the cuff from the patient. Make sure that the tubing is not kinked or twisted and that the correct patient category is selected. Try repeating the measurement. You can silence the INOP, but the INOP message remains visible until the next NBP measurement is started or the Stop All SmartKey is selected. <i>[Adult or pediatric patients: The NBP cuff pressure has exceeded 15mmHg (2kPa) for more than 3 minutes.</i> <i>[Neonatal patients: The NBP cuff pressure has exceeded 5mmHg (0.7kPa) for more than 90 seconds.]</i>
!!!/!!!!CUFF OVERPRESS Numeric displayed with -?- ; Severe yellow/red INOP tone. During this INOP, alarms cannot be paused or switched off.	NBP	The NBP cuff pressure exceeds the overpressure safety limits. Remove the cuff from the patient. Make sure that the tubing is not kinked or twisted and that the correct patient category is selected. Try restarting the measurement. You can silence this INOP, but the INOP message remains visible until the next measurement is started or the Stop All SmartKey is selected.
CVP INOPS	PRESS	See <Pressure label> INOPS (under Pressure).
DEVICE CHECK SETUP INOP tone.	IntelliBridge	Device identification completed, but communication could not be established due to timeout. IntelliBridge INOP abbreviations may differ slightly depending on the device category.
DEVICE CHECK CONF. INOP tone.	IntelliBridge	Device identification completed, but communication could not be established due to error. IntelliBridge INOP abbreviations may differ slightly depending on the device category.
DEVICE DEMO DATA INOP tone	IntelliBridge	The device connected to the IntelliBridge module reports demo data but the monitor is not in DEMO mode.

INOP Message, Indication	Source	What to do
DEVICE REAL DATA INOP tone	IntelliBridge	The monitor is in DEMO mode but the device connected to the IntelliBridge module reports data that are not flagged as demo data.
<Device> UNPLUGGED INOP tone.	IntelliBridge	The IntelliBridge module has been unplugged from the rack, or the whole rack has been disconnected. Silencing this INOP switches off the measurement. IntelliBridge INOP abbreviations may differ slightly depending on the device category.
DEVICE UNSUPPORTED INOP tone.	IntelliBridge	Device identification completed, but no appropriate device driver installed. IntelliBridge INOP abbreviations may differ slightly depending on the device category.
<EC10/EC40> EQUIP MALF INOP tone.	IntelliBridge	Malfunction in the IntelliBridge module. If this message appears repeatedly, the module must be replaced. Contact your service personnel.
ECG/ARRH ALARM OFF !!ECG/AR ALARM OFF	ECG	All ECG alarms have been switched off, or the HR alarm source is not ECG. To resume ECG alarm generation, switch ECG alarms on or select ECG as the alarm source.
ECG EQUIP MALF Numeric is displayed with a -?- INOP tone.	ECG	Contact your service personnel. The ECG hardware is faulty.
ECG EQUIP MALF T Numeric is displayed with a -?- INOP tone.	Monitor	Contact your service personnel. The ECG in the Telemetry device is faulty.
(!!/!!!)<ECG LEAD> LEAD OFF Numeric is displayed with a -?- INOP tone.	ECG	Not all the required leads for ECG monitoring are connected. Check the ECG connections and make sure that the electrode indicated by <ECG lead> [RA, LA, LL, RL, V or C] electrodes is attached. In EASI mode, all 5 electrodes must be connected.
ECG EL. NOISY <ECG LEAD>	ECG	The ECG signal from the named ECG electrodes [RA, LA, LL, RL, V (or C)] is noisy. Check the ECG connections and make sure that the electrode indicated is attached.
(!!/!!!)ECG LEADS OFF	ECG	Check that all of the required ECG leads are attached, and that none of the electrodes have been displaced.
ECG NOISY SIGNAL INOP tone.	ECG	The ECG signal is too noisy. Check that the electrodes are properly placed and have not dried out. Remove any possible sources of signal noise (such as power cords) from the area around the cable and the patient. The ECG signal may be saturated or overloaded.
EcgOut EQUIP MALF INOP tone	ECG	Check that the ECG out cable is securely connected. Contact your service personnel.
EEG EQUIP MALF INOP tone	EEG	The EEG hardware is faulty. Contact your service personnel.
EEG IMPEDANCE HIGH or EEG1 and/or EEG2 IMPED. HIGH	EEG	The signal electrode in one or both channels exceeds the user-selected impedance limit, or the impedance of a single electrode exceeds the limit. Check the impedance. If the impedance is too high, reconnect the electrodes according to the EEG monitoring setup guidelines. If the INOP persists, contact your service personnel.
EEG<X> LEAD OFF <n> [X = channel, n = electrode]	EEG	Reconnect specified electrode.

INOP Message, Indication	Source	What to do
EEG<X> LEAD OFF [X = channel] at Information Center	EEG	One or more electrodes are not connected. Check in the EEG Impedance/Montage window on the monitor which electrode(s) are affected and reconnect the electrodes.
EEG<X> LEADS OFF [X = channel]	EEG	Two or more electrodes are not connected. Check in the EEG Impedance/Montage window which electrodes are affected and reconnect the electrodes.
EEG LINE NOISE EEG 1 or 2 LINE NOISE	EEG	Excessive line noise has been detected in either channel EEG1 or EEG2, or in both EEG channels. Keep all cables together and away from metallic bodies, other cables & radiated fields.
EEG MUSCLE NOISE EEG 1 or 2 MUSCLE NOISE	EEG	Too much power above 30 Hz has been detected in channel EEG1 or EEG2, or both. Check the Electrode-to-Skin Impedance and reposition the electrode away from possible muscle activity, if necessary.
EEG NO TRANSDUCER INOP tone	EEG	The trunk cable is disconnected from the EEG plug-in module. Reconnect the trunk cable. Silencing this INOP switches the measurement off.
EEG UNPLUGGED INOP tone	EEG	Plug in module. Silencing this INOP switches off the measurement.
EEG OVERRANGE , or EEG<X> OVERRANGE	EEG	Input signal is too high in one or both channels. This is usually caused by interfering signals such as line noise or electro-surgery. X denotes the EEG channel.
FAP INOPS	PRESS	See <Pressure label> INOPS (under Pressure).
FMS UNPLUGGED INOP tone.	FMS	Make sure that the Flexible Module Rack is connected to the monitor. All FMS measurements are off while the FMS is unplugged.
FMS UNSUPPORTED INOP tone.	FMS	The Flexible Module Rack is not supported by your monitor. Contact your service personnel.
IC1/IC2 INOPS	PRESS	See <Pressure label> INOPS (under Pressure).
ICP INOPs	PRESS	See <Pressure label> INOPS (under Pressure).
Indep.Dsp Malfunc.	Display	A problem has occurred with the second main display. Contact your service personnel.
Indep.Dsp NotSupp.	Display	The monitor does not support a second main display. The monitor software is incompatible. Contact your service personnel.
!!INSERT BATTERY Severe yellow INOP tone. During this INOP, alarms cannot be paused or switched off.	Battery	X2/MP2 only: There is no battery in the battery compartment. You cannot operate the monitor on AC mains while the battery compartment is open (not sealed with a battery). Load a battery immediately.
Intell.Dsp Malf. INOP tone	Display	There is a problem with the Intelligent Display. Check the MSL coupling cable then contact your service personnel.
Intell.Dsp Missing	Display	The monitor has lost contact with the connected Intelligent Display. Contact your service personnel.
Intell.Dsp Unsupp.	Display	The monitor does not support the connected Intelligent Display. The monitor software is incompatible.
Internal.Comm.Malf INOP tone	Monitor	There is a problem with I2C Bus communication in the monitor. Contact your service personnel.
INVALID LEADSET	Telemetry	

INOP Message, Indication	Source	What to do
LA LEAD OFF Numeric is replaced by -?- for 10 seconds; INOP tone.	ECG	The LA electrode has become detached from the patient or the lead set has been changed. Reattach the electrode or select New Lead Setup in the Setup ECG menu to confirm the new lead set.
LAP INOPs	PRESS	See <Pressure label> INOPS (under Pressure).
LEADSET UNPLUGGED	Telemetry	The leadset has been unplugged from the telemetry device.
LL LEAD OFF Numeric is replaced by -?- for 10 seconds; INOP tone.	ECG	The LL electrode has become detached from the patient or the lead set has been changed. Reattach the electrode or select New Lead Setup in the Setup ECG menu to confirm the new lead set.
MCC Reversed INOP tone	Monitor	The MSL coupling cable is reversed. Connect the end with the grey connector to the Intelligent Display.
MCC Unsupported INOP tone	Monitor	An MSL coupling cable has been connected to a device which does not support MSL coupling.
Meas. DEACTIVATED		An X2 or MP5 has been connected to a host monitor (companion mode) and all derived measurements have been deactivated and/or measurements with a label conflict. The measurements can only be reactivated by disconnecting the measurement device from the host monitor.
MEASSRV UNSUPPORTD INOP tone	MMS	The Multi-Measurement module is not supported by the monitor. Contact your service personnel.
MMS Ext. EQUIP MALF INOP tone	MMS Extension	Loss of communication between the Multi-Measurement Module and the MMS extension. Contact your service personnel.
MMS Ext. UNPLUGGED INOP tone	MMS Extension	The MMS extension has been disconnected from the Multi-Measurement Module.
MMS Ext. Unpowered INOP tone	MMS Extension	The MMS extension cannot operate while the Multi-Measurement Module is running on battery power.
MMSExt. Unsupported INOP tone	MMS Extension	The MMS extensions not supported by your monitor. Contact your service personnel.
MMS UNPLUGGED INOP tone.	MMS	Make sure that the Multi-Measurement Module is connected to the monitor. All MMS measurements are off while the MMS is unplugged.
MMS UNSUPPORTED INOP tone.	MMS	The Multi-measurement Module is not supported by your monitor. Contact your service personnel.
!!/!!!MORE BED ALARMS At Information Center	Monitor	The monitor is associated with a telemetry device and is sending data to the Information Center via the telemetry device. There are currently more alarms at the bedside than can be transmitted to the Information Center.
MSL Power High	Monitor	The power consumption of the devices connected to the Measurement Link (MSL) cable is too high. If this situation continues, the MSL will be switched off. Contact your service personnel.
MSL Power Off INOP tone.	Monitor	The power consumption of the devices connected to the Measurement Link (MSL) cable was too high for too long and the MSL has been switched off. Contact your service personnel.
MSL Power Overload INOP tone.	Monitor	The power consumption of the devices connected to the Measurement Link (MSL) cable is much too high or there has been a short circuit. The MSL has been switched off. Contact your service personnel.

INOP Message, Indication	Source	What to do
NBP Deactivated INOP tone.	NBP	The NBP measurement label in the measurement device has been deactivated by deactivating the label in the Measurement Selection window. The measurement automatically disappears from the display. To switch the measurement on again, reactivate the measurement label in the Measurement Selection window.
NBP EQUIP MALF Numeric is replaced by -?- INOP tone.	NBP	Remove the cuff from the patient. The NBP hardware is faulty. Contact your service personnel. You can silence this INOP, but the INOP message remains visible until the next measurement is started or the Stop All SmartKey is selected.
NBP INTERRUPTED Numeric is replaced by -?- INOP tone.	NBP	Check the tubing and cuff for leakages or kinks. Check that you are using the correct cuff size and placement, and that the correct patient category is selected. Try restarting the measurement. If the INOP occurs repeatedly, contact your service personnel. You can silence this INOP, but the INOP message remains visible until the next measurement is started or the Stop All SmartKey is selected. This INOP arises when the measurement needed longer than the maximum time for inflation, deflation or the total measurement.
NBP MEASURE FAILED Numeric may be displayed with a -?- INOP tone.	NBP	Check that you are using the correct cuff size and placement, and that the correct patient category is selected. Try restarting the measurement. You can silence this INOP, but the INOP message remains visible until the next measurement is started or the Stop All SmartKey is selected. Check the condition and suitability of the patient for NBP monitoring. Use another cuff to continue measuring.
No Central Monit. INOP tone	Monitor	There is a problem with the communication to the network. Central monitoring is currently not possible (no patient alarms or information). Check the connection. Contact your service personnel.
!!/!!! NO DEVICE DATA NO DEVICE DATA	IntelliBridge	Communication with connected device has been lost.
NO ECG AT CENTRAL	Monitor	The ECG measured with the monitor ECG is not being sent to the Information Center via the telemetry device.
NO ECG SOURCE	Telemetry	A telemetry device is paired with the monitor but the Information Center is not detecting a valid ECG signal from either of them.
NO PPV FROM MeasSrv at Information Center	MMS or FMS	The measurement device does not supply a beat-to-beat arterial pressure value. Contact your service personnel.
NO PPV FROM <Device>	MMS or FMS	The measurement device does not supply a beat-to-beat arterial pressure value. Contact your service personnel.
OUT OF AREA	Telemetry	The telemetry device has left the access point coverage area.
P/P1/P2/P3/P4 INOPS	PRESS	See <Pressure label> INOPS (under Pressure).
PAP INOPS	PRESS	See <Pressure label> INOPS (under Pressure).
PPV BAD <Pressure Label> SIGNAL	PPV	The arterial pressure source selected for PPV is not providing a pulsatile signal.

INOP Message, Indication	Source	What to do
PPV BAD SIGNAL at Information Center	PPV	The arterial pressure source selected for PPV is not providing a pulsatile signal.
PPV CHK SOURCES	PPV	The arterial pressure source selected for PPV is unplugged or switched off. When this INOP has displayed for 1 minute PPV will be switched off.
<Pressure label> ARTIFACT Numeric questionable	PRESS	A non-physiological event is detected (for example, a flush or blood sample). A resulting high limit alarm will be suppressed.
<Pressure label> DEACTIVATED INOP tone	PRESS	A Pressure measurement label in the measurement device or extension has been deactivated, either by connecting a Temp transducer in the shared Press/Temp socket, or by deactivating the label in the Measurement Selection window. The measurement automatically disappears from the display. To switch the measurement on again, either reconnect a Pressure transducer or reactivate the measurement label in the Measurement Selection window.
<Pressure label> EQUIP MALF Numeric is replaced by -?- INOP tone.	PRESS	Contact your service personnel. The pressure hardware is faulty.
<Pressure label> NO TRANSDUCER Numeric is replaced by -?- INOP tone.	PRESS	Make sure that the pressure transducer is connected to the measurement device or module. If you silence this INOP, the measurement will be switched off.
<Pressure label> NOISY SIGNAL Pulse numeric is replaced by -?- INOP tone.	PRESS	This INOP can only arise when a pressure is selected as the pulse source. It occurs when the pulse detector finds a pulse rate above 350bpm. This is usually caused by movement artifact or electrical interference.
<Pressure label> NON-PULSATILE Pulse numeric is replaced by -?- INOP tone.	PRESS	This INOP can only arise when a pressure is selected as the pulse source. It occurs when the pulse rate being measured is less than 25 beats per minute or the amplitude is less than three mmHg. Check the catheter and connections to the patient.
<Pressure label> OVERRANGE Numeric is replaced by -?- INOP tone.	PRESS	Make sure that the measurement has been properly prepared and zeroed, and that the transducer is level with the heart. If this INOP persists, try another transducer. Possible causes are a measured pressure outside the allowed pressure range, or a broken wire to the transducer.
<Pressure label> REDUCE SIZE	PRESS	Increase the scale for the pressure wave.
<Pressure label> UNPLUGGED INOP tone.	PRESS	A Pressure measurement label has been deactivated, either by unplugging a module, or by deactivating the label in the Measurement Selection window. The measurement automatically disappears from the display. To switch the measurement on again, either replug the module or reactivate the measurement label in the Measurement Selection window.
<Pressure label> ZERO+CHECK CAL Numeric is replaced by -?-	PRESS	Perform a zero and check the calibration of the transducer.

INOP Message, Indication	Source	What to do
<pTemp label> CHECK PROBE Numeric is replaced by -?- INOP tone.	Predictive Temp	Check that the probe holder is correctly installed and that a compatible probe is in use. If the INOP does not clear, remove the probe from the holder then replace it. If the INOP still does not clear, disconnect and reconnect the probe.
<pTemp label> DEACTIVATED INOP tone.	Predictive Temp	The Predictive temperature has been deactivated.
<pTemp label> EQUIP MALF Numeric is replaced by -?- INOP tone.	Predictive Temp	The Predictive Temperature hardware is defective. Contact your service personnel.
<pTemp label> INCOMPAT.	Predictive Temp	The Predictive Temperature version is not supported by the monitor.
<pTemp label> MEAS FAILED Numeric is replaced by -?- INOP tone.	Predictive Temp	The ambient temperature is outside the specified range (10 to 40°C /50 to 104°F). Bring the temperature into range to continue monitoring. If the INOP does not clear, disconnect and reconnect the probe.
<pTemp label> NO PROBE Numeric is replaced by -?- INOP tone.	Predictive Temp	Connect a probe to the Predictive temperature unit.
<pTemp label> OVERRANGE Numeric is replaced by -?- INOP tone.	Predictive Temp	The temperature at the measurement site is out of range. Check that the probe is correctly located. If the INOP does not clear, disconnect and reconnect the probe.
<pTemp label> PROBE MALF Numeric is replaced by -?- INOP tone.	Predictive Temp	The connected probe may be defective. Disconnect and reconnect the probe. If the INOP does not clear, try another probe.
pTaxil INOPS	Predictive Temp	See <pTemp label> INOPS
pToral INOPS	Predictive Temp	See <pTemp label> INOPS
pTrect INOPS	Predictive Temp	See <pTemp label> INOPS
(!!)PW:Action Required	Protocol Watch	The protocol currently running requires a user response. Check which pop-up window is displayed and provide the appropriate response.
PW:Check Settings	Protocol Watch	Contact your service personnel. Settings could not be loaded or interpreted correctly
PW in conflict	Protocol Watch	There is a patient information mismatch which has not yet been resolved (>15 minutes).
RA LEAD OFF Numeric is replaced by -?- INOP tone.	ECG	The RA electrode has become detached from the patient or the lead set has been changed. Reattach the electrode or select New Lead Setup in the Setup ECG menu to confirm the new lead set.
RAP INOPS	PRESS	See <Pressure label> INOPS (under Pressure).
Rem. Alarmdev.Malf INOP tone	Monitor	There is a problem with the connection to the remote alert device. Contact your service personnel to check the remote alert device and its connections.
Rem. Display Malf.	Remote display	There is a problem with an input device at the remote display. Perform a visual and functional check of all input devices. Contact your service personnel.

INOP Message, Indication	Source	What to do
!!/!!! REPLACE BATTERY T Severe yellow/red INOP tone. During this INOP, alarms cannot be paused or switched off.	Telemetry	The battery in the telemetry device is almost empty and must be replaced.
RESP EQUIP MALF Numeric is replaced by -?- INOP tone.	RESP	Contact your service personnel. The RESP hardware is faulty.
RESP ERRATIC Numeric is replaced by -?-	RESP	The monitor has detected too many artifacts in the measured Resp signal. Check that the RA and LL electrodes are correctly attached and have not dried out.
RESP LEADS OFF Numeric is replaced by -?- INOP tone.	RESP	Not all the required leads for Resp monitoring are attached. Make sure that the RA and LL leads are attached.
RL LEAD OFF Numeric is replaced by -?- for 10 seconds; INOP tone.	ECG	The RL electrode has become detached from the patient or the lead set has been changed. Reattach the electrode or select New Lead Setup in the Setup ECG menu to confirm the new lead set.
Settings Malfunc. INOP tone.	Monitor	The monitor cannot use the predefined settings for monitoring. Contact your service personnel.
<SO₂ Label> CAL FAILED Numeric is replaced by -?- INOP tone.	SO ₂	The calibration failed. Check the catheter-to-Optical-Module connection. Manually restart the calibration. Try another catheter and Optical Module. If the catheter is already inserted, perform an in-vivo calibration.
<SO₂ Label> CAL MODE Numeric is replaced by -?- INOP tone.	SO ₂	Pre-insertion calibration is complete, but the catheter tip is still inside the optical reference. The catheter is now ready for insertion.
<SO₂ Label>CAL REQUIRED Numeric is replaced by -?- INOP tone.	SO ₂	There is no valid calibration data in the Optical Module. Perform either a pre-insertion or an in-vivo calibration.
<SO₂ Label> CANNOT MEAS Numeric is replaced by -?- INOP tone.	SO ₂	The signal is out of the normal range, and no oxygen saturation can be derived. Perform an in-vivo calibration. If the INOP persists, try another Optical Module and catheter.
<SO₂ Label>CONFIG ERROR Numeric is replaced by -?- INOP tone.	SO ₂	The Optical Module has been configured to SaO ₂ Mode. Use Change to Venous in the setup menu to reconfigure to venous saturation mode.
<SO₂ Label> CONN OPTMOD Numeric is replaced by -?- INOP tone.	SO ₂	The Optical Module was disconnected during data storage. Reconnect the Optical Module for at least 20 seconds.
<SO₂ Label> EQUIP MALF Numeric displays -?-. INOP tone	SO ₂	The SO ₂ /SvO ₂ Module or Optical Module is faulty. Unplug and replug the Optical Module and SO ₂ /SvO ₂ module. Exchange the modules. If the INOP persists, contact your service personnel.
SO₂ INCOMPATIBLE INOP tone	SO ₂	The SO ₂ Module or Optical Module is not supported. Contact your service personnel.
<SO₂ Label> IN-VIVO CAL	SO ₂	The in-vivo calibration is not yet complete. Lab values must be stored to the Optical Module to complete the calibration. Either continue with the next steps of the current calibration or recall the previous calibration.

INOP Message, Indication	Source	What to do
<SO₂ Label>LIGHT INTENS Numeric is replaced by -?- INOP tone.	SO ₂	The intensity changed considerably since the last light intensity calibration. This may indicate that the catheter tip is positioned against a blood vessel wall or that there is low blood flow. Reposition the catheter (and perform a Light Intensity Calibration).
<SO₂ Label> LOW LIGHT Numeric is replaced by -?- INOP tone.	SO ₂	The optical signal levels are too low. Check that the catheter is either in the optical reference or inserted into the patient. Check the catheter-to-Optical Module connection. If INOP persists, try another catheter and Optical Module.
<SO₂ Label> NO OPTMOD Numeric is replaced by -?- INOP tone.	SO ₂	Connect the Optical Module. If the INOP persists, try another Optical Module. Silencing this INOP switches the measurement off.
<SO₂ Label> OPTMOD MALF	SO ₂	The Optical Module memory is faulty, and calibration data cannot be stored for transport or during power failure. If this capability is needed, use another Optical Module.
<SO₂ Label> PRE-INS CAL Numeric displays -?- INOP tone	SO ₂	The pre-insertion calibration is running. This typically takes one minute. During this time alarms are switched off. Wait until the calibration is complete.
<SO₂ Label> UNPLUGGED Numeric displays -?-. INOP tone	SO ₂	Measurement switched on and SO ₂ /SvO ₂ module unplugged from the rack.
SO₂ UPGRADE INOP tone	SO ₂	The SO ₂ module is currently in upgrade mode. Monitoring is not possible in this mode.
<SO₂ Label> WARMUP Numeric is displayed with ?	SO ₂	The Optical Module has not yet reached the operating temperature. Wait a few minutes until warm-up is finished.
SOME ECG ALRMS OFF	Arrhythmia	This message appears (if configured to do so) when the on/off settings of the yellow arrhythmia alarms differ from the current Profile.
Speaker Malfunct. INOP tone	Monitor	Contact your service personnel to check the speaker and the connection to the speaker.
SPIRO MALFUNCTION	Spirometry	Module failure detected. Contact your service personnel.
SPIRO INCOMPATIBLE	Spirometry	Module revision not compatible with the host monitor software revision. Contact your service personnel.
SPIRO UPGRADE	Spirometry	The module is running a firmware upgrade. Wait until upgrade is completed before resuming monitoring.
SPIRO CANNOT MEAS	Spirometry	Measurement is at its limit, e.g. ambient pressure out of range.
SPIRO PURGE FAILED	Spirometry	The purge operation could not be completed successfully. Check for kinked sensor tubings, hard occlusions and make sure that the pump is running and all valves are switching.
SPIRO UNKN. SENSOR	Spirometry	An unknown sensor ID code was detected. Use only the sensors listed in the Accessories chapter.
SPIRO ALARMS SUPPR	Spirometry	Alarming is suppressed for the spirometry module.
SPIRO PURGING	Spirometry	A purge operation is in progress - no data update on the screen. Wait until purge is complete.
SPIRO NO SENSOR	Spirometry	No sensor detected. Make sure the correct sensor is attached to the breathing circuit.

INOP Message, Indication	Source	What to do
SPIRO NO BREATH	Spirometry	No breath was detected for more than 25 seconds. Breath derived numerics are not available.
SPIRO GAS COMPENS?	Spirometry	Gas compensation is set to "gas analyzer" but not all gases necessary for compensation are measured by a gas monitor. Some of the fall-back values provided by the user are used. Measurement accuracy might be reduced.
SPIRO PATIENT CAT.	Spirometry	Mismatch of patient size configured in the host monitor and sensor type plugged into the module. Check the instructions on selecting the correct sensor in the Spirometry chapter.
ΔSpO₂ CHK SOURCES Numeric is replaced by -?-	SpO ₂ Difference	Not all measurements or values required to perform the calculation are available. Check measurement sources.
ΔSpO₂ CHK UNITS Numeric is replaced by -?-	SpO ₂ Difference	The monitor has detected a conflict in the units used for this calculation. Check the unit settings.
<SpO₂ label> DEACTIVATED INOP tone	SpO ₂	The SpO ₂ measurement label in the measurement device has been deactivated by deactivating the label in the Measurement Selection window. The measurement automatically disappears from the display. To switch the measurement on again, reactivate the measurement label in the Measurement Selection window.
<SpO₂ label> EQUIP MALF Numeric is replaced by -?- INOP tone.	SpO ₂	The MMS or module is faulty. Unplug and replug the MMS or module. If the INOP persists, contact your service personnel.
<SpO₂ label> ERRATIC Numeric is replaced by -?- INOP tone.	SpO ₂	Check the sensor placement. Try another adapter cable and sensor. If the INOP persists, contact your service personnel.
<SpO₂ label> EXTD. UPDATE Label is displayed with a -?- (questionable numeric)	SpO ₂	The update period of displayed values is extended due to an NBP measurement on the same limb or an excessively noisy signal.
<SpO₂ label> INTERFERNCE Numeric is replaced by -?- INOP tone.	SpO ₂	There is too much interference, caused by a high level of ambient light and/or electrical interference. Cover the sensor to minimize ambient light. If the INOP persists, make sure that the sensor cable is not damaged or positioned too close to power cables.
<SpO₂ label> LOW PERF Label is displayed with a -?- (questionable numeric)	SpO ₂	Accuracy may be compromised due to very low perfusion. Stimulate circulation at sensor site. If INOP persists, change the measurement site.
<SpO₂ label> NOISY SIGN. Numeric is replaced by -?- INOP tone.	SpO ₂	Excessive patient movement or electrical interference is causing irregular pulse patterns. Try to reduce patient movement or to relieve the cable strain on the sensor.
<SpO₂ label> NON-PULSAT. Numeric is replaced by -?- INOP tone.	SpO ₂	Check the perfusion at measurement site. If necessary, stimulate circulation or change measurement site. If the INOP is due to NBP measurement on the same limb, wait until the NBP measurement is finished.
<SpO₂ label> NO SENSOR Numeric is replaced by -?- INOP tone.	SpO ₂	Make sure the SpO ₂ sensor is connected. If the INOP persists, try another adapter cable and sensor. If you silence this INOP, the measurement will be switched off.
<SpO₂ LABEL> POOR SIGNAL Label is displayed with a -?- (questionable numeric)	SpO ₂	The signal condition of the SpO ₂ measurement is poor and measurement accuracy may be compromised.

INOP Message, Indication	Source	What to do
<SpO₂ LABEL> PULSE? Numeric is replaced by -?- INOP tone	SpO ₂	The detectable pulsations of the SpO ₂ signal are outside the specified pulse rate range.
<SpO₂ LABEL> SEARCHING Numeric unavailable	SpO ₂	SpO ₂ is analyzing the patient signal to derive Pulse, SpO ₂ and Perf values. Please wait until the search analysis is complete.
<SpO₂ label> SENSOR MALF Numeric is replaced by -?- INOP tone.	SpO ₂	The SpO ₂ sensor or adapter cable is faulty. Try another adapter cable and sensor. If the INOP persists, contact your service personnel.
<SpO₂ LABEL> SENSOR OFF Numeric is replaced by -?- INOP tone	SpO ₂	The SpO ₂ sensor is not properly applied to the patient. Apply the sensor following the instructions supplied by the manufacturer.
<SpO₂ LABEL> UNKN. SENSOR Numeric is replaced by a -?-	SpO ₂	The connected sensor or adapter cable is not supported by the SpO ₂ measurement. Use only specified sensors and cables.
<SpO₂ LABEL> UNPLUGGED Numeric is replaced by -?- INOP tone	SpO ₂	An SpO ₂ measurement label has been deactivated, either by unplugging a module, or by deactivating the label in the Measurement Selection window. The measurement automatically disappears from the display. To switch the measurement on again, either replug the module or reactivate the measurement label in the Measurement Selection window.
<SpO₂ LABEL> UPGRADE Label is displayed with a -?-, numeric is unavailable	SpO ₂	The SpO ₂ measurement is currently in UPGRADE mode. Monitoring is not possible in this mode.
Sp - vO₂ CHK SOURCES Numeric is replaced by -?-	Sp - vO ₂	Not all measurements or values required to perform the calculation are available. Check measurement sources.
Sp - vO₂ CHK UNITS Numeric is replaced by -?-	Sp - vO ₂	The monitor has detected a conflict in the units used for this calculation. Check the unit settings.
SRR INTERFERENCE INOP tone	Monitor	The short range radio connection has interference from another device. Try using another channel.
SRR INVALID CHAN INOP tone	Monitor	The channel configuration of the Short Range Radio is invalid. Check channel and channel mask configuration.
SRR MALFUNCTION		Malfunction in the short range radio device. If the INOP persists contact your service personnel.
SVR/SVRI CHK SOURCES Numeric is replaced by -?-	SVR/SVRI	Not all measurements or values required to perform the calculation are available. Check measurement sources.
SVR/SVRI CHK UNITS Numeric is replaced by -?-	SVR/SVRI	The monitor has detected a conflict in the units used for this calculation. Check the unit settings.
SVR/SVRI SET CVP USED Numeric is replaced by -?-	SVR/SVRI	A CVP value is required for this calculation, but is not currently being measured. The monitor is using the CVP value preset in the Setup SVR menu.
T/T1/T2/T3/T4 INOPs	TEMP	See <Temp label> INOPs (under Temp)
TAAP DISABLED INOP tone	Monitor	The currently selected telemetry configuration on the monitor does not allow connection of telemetry devices to the monitor.
Tamb INOPs	TEMP	See <Temp label> INOPs (under Temp)
Tart INOPs	TEMP	See <Temp label> INOPs (under Temp)

INOP Message, Indication	Source	What to do
Tblood NO TRANSDUC Numeric is replaced by -?- INOP tone	C.O.	No transducer attached to the module or catheter disconnected.
Tblood OVERRANGE Numeric is replaced by -?-	C.O.	Tblood out of range 17°C - 43°C.
Tcereb INOPS	TEMP	See <Temp label> INOPs (under Temp)
Tcore INOPs	TEMP	See <Temp label> INOPs (under Temp).
tcpO₂ (or tcpCO₂ or tcGas) CAL FAILED Numeric is replaced by -?- INOP tone.	tcGas	A calibration failed. Check the calibration unit, gas pressure, and tubing connections, then restart the calibration. If the calibration has failed more than once, remembrance the transducer and restart the calibration. If this INOP persists, contact your service personnel.
tcpO₂ (or tcpCO₂ or tcGas) CAL REQUIRD Numeric is replaced by -?- INOP tone.	tcGas	Calibration is required before applying the transducer to the patient. Insert a membraned transducer into the calibration chamber on the module, connect the calibration unit to the calibration chamber, open the gas valve and start the calibration. If this INOP occurs during a calibration, there may be a module or transducer malfunction: contact your service personnel.
tcpO₂ (or tcpCO₂ or tcGas) CAL RUNNING Numeric displays first -?- , then numeric is displayed with a ?	tcGas	Wait until the tcpO ₂ /tcpCO ₂ calibration is finished.
tcpO₂ (or tcpCO₂ or tcGas) CHECK TIME	tcGas	Site Timer due to time out in 15 minutes or less.
tcpO₂ (or tcpCO₂ or tcGas) CHANGE SITE If Heat Switch Off is configured to Yes, numeric is replaced by -?- INOP tone.	tcGas	Site Timer has timed out. Change the application site to avoid skin burns. To reset the Site Timer, either calibrate and change the measurement site, or change the measurement site and reset the Site Timer manually by selecting the appropriate site time from the Setup TCGas menu.
tcpO₂ (or tcpCO₂ or tcGas) EQUIP MALF Numeric is replaced by -?- INOP tone.	tcGas	There is a malfunction in the transducer or module. Connect another transducer. If this INOP persists, contact your service personnel.
tcpO₂ (or tcpCO₂ or tcGas) NO TRANSDUC Numeric is replaced by -?- INOP tone.	tcGas	No transducer is connected to the tcpO ₂ /tcpCO ₂ module. Silencing the alarm switches off the measurement.
tcpO₂ (or tcpCO₂ or tcGas) STABILIZING Numeric is displayed with a ?	tcGas	The transducer has not yet reached the selected temperature and/or skin hyperemization is not yet finished. This INOP will disappear within three minutes.
tcpO₂ (or tcpCO₂ or tcGas) UNPLUGGED Numeric is replaced by -?- INOP tone.	tcGas	The measurement is switched on but the module is unplugged. The measurement automatically disappears from the display. Silencing this INOP switches off the measurement.
TELE CONFIG UNSUPP INOP tone	Monitor	Telemetry device not supported (companion mode)

INOP Message, Indication	Source	What to do
!!/!!!TELE DISCONNECT INOP tone	Telemetry	Telemetry transceiver was disconnected or short range radio link was lost. For cable connections; check Telemetry interface, cable connection and setup. For short range radio connections: if the telemetry transceiver has not moved out-of-range, check for interference sources close to the monitor (bluetooth devices, DECT phones, cellular phones, microwaves, etc.) If this INOP persists, ask your service personnel to survey the interference sources.
TELE EQUIP MALF INOP tone	Monitor	The telemetry device has a malfunction. Disconnect and reconnect the telemetry device. If the INOP reappears, replace the telemetry device.
TELE INCOMPATIBLE	Monitor	SRR-enabled telemetry device is not supported by this central software revision. Please check configuration.
!!/!!! TELE INOP Severe yellow/red INOP tone.	Telemetry	Check for further details at the Information Center or in the Telemetry Data window on the monitor.
Tele Sync Unsupp. INOP tone	Telemetry	The MMS in use does not support synchronization of ECG and SpO ₂ settings between the monitor and central station after a telemetry device has been paired. Use an MMS with revision E.0 or above.
TELE UNSUPPORTED INOP tone	Monitor	This telemetry device is not supported for direct connection to the monitor.
<ΔTemp> CHK SOURCES Numeric is replaced by -?-	TEMP Difference	Not all measurements or values required to perform the calculation are available. Check measurement sources.
<ΔTemp> CHK UNITS Numeric is replaced by -?-	TEMP Difference	The monitor has detected a conflict in the units used for this calculation. Check the unit settings.
<Temp label> DEACTIVATED INOP tone	TEMP	A Temp measurement label in the measurement device has been deactivated, either by connecting a Pressure transducer in the shared Press/Temp socket, or by deactivating the label in the Measurement Selection window. The measurement automatically disappears from the display. To switch the measurement on again, either reconnect a Temp transducer or reactivate the measurement label in the Measurement Selection window.
<Temp label> EQUIP MALF Numeric is replaced by -?- INOP tone.	TEMP	Contact your service personnel. The temperature hardware is faulty.
<Temp label> NO TRANSDUCER Numeric is replaced by -?- INOP tone.	TEMP	Make sure the TEMP probe is connected to the MMS or module. If you silence this INOP, the measurement will be switched off.
<Temp label> UNPLUGGED INOP tone	TEMP	A Temp measurement label has been deactivated, either by unplugging a module, or by deactivating the label in the Measurement Selection window. The measurement automatically disappears from the display. To switch the measurement on again, either replug the module or reactivate the measurement label in the Measurement Selection window.

INOP Message, Indication	Source	What to do
<Temp label> OVERRANGE Numeric is replaced by -?- INOP tone.	TEMP	Try changing the application site of the transducer. [The temperature is less than -1°C, or greater than 45°C.]
Tesoph INOPS	TEMP	See <Temp label> INOPs (under Temp).
TEXT UPLOAD FAILED INOP tone	IntelliBridge	Incoming text from the IntelliBridge modules exceeds the maximum limit. Try unplugging one of the IntelliBridge modules. If the INOP occurs repeatedly contact your service personnel; a software upgrade may be necessary.
TimeExpired: <timer label> INOP tone	Monitor	The time has expired for the timer indicated in the INOP text. Clearing the timer clears the INOP.
Tnaso INOPS	TEMP	See <Temp label> INOPs (under Temp).
Trect INOPS	TEMP	See <Temp label> INOPs (under Temp).
Tskin INOPS	TEMP	See <Temp label> INOPs (under Temp).
Ttymp INOPS	TEMP	See <Temp label> INOPs (under Temp)
Tven INOPS	TEMP	See <Temp label> INOPs (under Temp).
Tvesic INOPS	TEMP	See <Temp label> INOPs (under Temp)
UAP INOPS	PRESS	See <Pressure label> INOPS (under Pressure).
Unsupported LAN INOP tone	Monitor	There is a problem with the communication to the network and central monitoring is currently not possible. Check the connection. If the INOP persists, switch off the monitor and contact your service personnel.
User I/F Malfunct. INOP tone.	Monitor	Perform a visual and functional check of all the monitor input devices. Contact your service personnel.
UVP INOPS	PRESS	See <Pressure label> INOPS (under Pressure).
V LEAD OFF Numeric is replaced by -?- for 10 seconds; INOP tone.	ECG	The V electrode (IEC: C electrode) has become detached from the patient or the lead set has been changed. Reattach the electrode or select New Lead Setup in the Setup ECG menu to confirm the new lead set.
<VueLink option> CHK CABLE INOP tone.	VueLink	No cable or the wrong cable connected to the VueLink module, or incorrect device selected. Silencing this INOP switches the measurement off. VueLink INOP abbreviations may differ slightly depending on the device category.
<VueLink option> CHK CONF. INOP tone.	VueLink	The wrong external device has been selected on the VueLink module, or the external device has not been correctly setup, or the wrong cable has been used to connect the device to the VueLink module. VueLink INOP abbreviations may differ slightly depending on the device category.

INOP Message, Indication	Source	What to do
<p><VueLink option> CHECK SETUP INOP tone.</p>	<p>VueLink</p>	<p>No information was received from the external device. The device may be switched off or disconnected. VueLink INOP abbreviations may differ slightly depending on the device category.</p>
<p>VueLnk EQUIP MALF INOP tone.</p>	<p>VueLink</p>	<p>Malfunction in the VueLink module. If this message appears repeatedly, the module must be replaced. Contact your service personnel. VueLink INOP abbreviations may differ slightly depending on the device category.</p>
<p>VueLnk NO CONFIG INOP tone.</p>	<p>VueLink</p>	<p>The VueLink module has not been configured during installation. The installation process should be completed by either your biomedical engineering department or the Philips service engineer. VueLink INOP abbreviations may differ slightly depending on the device category.</p>
<p>VueLnk UNPLUGGED INOP tone.</p>	<p>VueLink</p>	<p>The VueLink module has been unplugged from the rack, or the whole rack has been disconnected. The measurement automatically disappears from the display. Silencing this INOP switches off the measurement. VueLink INOP abbreviations may differ slightly depending on the device category.</p>

Managing Patients

Use the Patient Demographics window and its associated pop-up keys to admit, discharge, and transfer (ADT) patients.

All patient demographic and ADT information is shared between the patient monitor and the Information Center, for example, patients admitted to the monitor are automatically admitted to a connected Information Center.

Admitting a Patient

The monitor displays physiological data and stores it in the trends as soon as a patient is connected. This lets you monitor a patient who is not yet admitted. It is however important to admit patients properly so that you can identify your patient on recordings, reports, and networked devices.

During admission you enter data that the monitor needs for safe and accurate operation. For example, the patient category setting determines the algorithm the monitor uses to process and calculate some measurements, the safety limits that apply for some measurements, and the alarm limit ranges.

NOTE It is strongly recommended that the same patient data fields be configured to be mandatory at the monitor and the Information Center.

To admit a patient,

- 1 Select the patient name field or select the **Admit/Discharge** SmartKey to open the **Patient Demographics** window.

SBed10 Adult Doe, John		Patient Demographics		×
Last Name	: Doe			▲
First Name	: John			
MRN	: 12345678			
Patient Cat.	: Adult			▼
Admit Patient	Transfer	Discharge Patient	End Case	▶▶

- 2 Clear any previous patient data by selecting the **Discharge Patient** or **End Case** pop-up key and then **Confirm**.
If you do not discharge the previous patient, you will not be able to distinguish data from the previous and current patients, for example, in the trend database.
- 3 Select **Admit Patient**.
- 4 Enter the patient information: select each field and use the on-screen keyboard or choose from the pop-up list of alternatives to input information.
 - **Last Name**: Enter the patient's last name (family name), for example **Smith**.
 - **First Name**: Enter the patient's first name, for example **Joseph**.
 - **Middle Name** (if configured to appear): Enter the patient's middle name.
 - **Lifetime Id, Encounter Id**: Whether these fields appear and how they are labelled can be configured for your hospital. One or both fields may be displayed and the labels may read: MRN, Case Id, Visit Id, etc. Enter the appropriate data for the fields displayed.
 - **Patient Cat**: Choose the patient category, either Adult, Pediatric, or Neonatal.
 - **Paced**: Choose **Yes** or **No** (You must use "Yes" if your patient has a pacemaker).
 - **Height**: Enter the patient's height.
 - **Weight**: Enter the patient's weight.
 - **BSA**: The monitor calculates the body surface area automatically.
 - **Date Of Birth**: Enter the patient's date of birth. Enter this in the form dd/mm/yyyy.
 - **Age**: The monitor calculates the patient age automatically.
 - **Gender**: Choose **Male** or **Female**.
 - **Notes**: Enter any extra information about the patient or treatment.
- 5 Select **Confirm**. The patient status changes to admitted.

Patient Category and Paced Status

The patient category setting determines the algorithm the monitor uses to process and calculate some measurements, the safety limits that apply for some measurements, and the alarm limit ranges.

The paced setting determines whether the monitor shows pacemaker pulses or not. When **Paced** is set to **No**, pace pulses are filtered and therefore do not show in the ECG wave.

WARNING **Patient Category** and **Paced** status will always contain a value, regardless of whether the patient is fully admitted or not. If you do not specify settings for these fields, the monitor uses the default settings from the current profile, which might not be correct for your patient.

Patient category Changing the patient category may change the arrhythmia and NBP alarm limits. Always check alarm limits to make sure that they are appropriate for your patient.

Paced status For paced patients, you must set **Paced** to **Yes**. If it is incorrectly set to **No**, the monitor could mistake a pace pulse for a QRS and fail to alarm during asystole.

Admitting a Centrally-Monitored Patient

You can admit a patient at either the bedside or the Information Center. When you admit a patient, the patient's name appears on the bedside monitor and the Information Center.

If you do not fill in all patient information required by the Information Center, the Information Center may reject the admission. Complete all the required fields and try again to admit the patient.

Quick Admitting a Patient

Use Quick Admit only if you do not have the time or information to fully admit a patient. Complete the rest of the patient demographic details later.

- 1 Select the **Quick Admit** SmartKey.
- 2 Enter the required data (ID fields or Last Name depending on configuration) with the keyboard.
- 3 Select **Enter**.
- 4 In the confirmation window, select **Confirm** to discharge the previous patient (if confirmation is configured).
- 5 Check that patient category and paced status are correct for the new patient.

If the monitor is connected to an Information Center and only the ID field is entered, the patient name is set to - - - at the Information Center. Complete the rest of the demographic details as soon as possible to fully identify the patient on the network, on the monitor and on printed reports. To complete the details, select **Admit Patient** again and complete all required fields.

Editing Patient Information

To edit the patient information after a patient has been admitted, select the patient name field on the Main Screen to open the **Patient Demographics** window, and make the required changes.

Discharging a Patient

WARNING Always perform a discharge before starting monitoring for a new patient, even if your previous patient was not admitted. Failure to do so can lead to data being attributed to the wrong patient.

A discharge:

- clears the information in the **Patient Demographics** window
- erases all patient data (including trend data) from the monitor and Information Center. This ensures that data from a previous patient are not mixed with data from the new patient.
- resets patient category and paced settings to the settings defined in the default Profile
- resets all monitor and measurement settings as well as the active Screen to the settings defined in the default Profile
- discharges the patient from the Information Center.

When a patient is discharged from the monitor or from an Information Center, all patient data is deleted. Make sure that you have printed out any required reports before discharging. Check that a functioning central printer is available before you use **End Case**.

To discharge a patient,

- 1 Select the patient name field or select the **Admit/Discharge** SmartKey to open the **Patient Demographics** window and associated pop-up keys.

2 Select the pop-up key for either:

- **End Case** - to print any configured end case reports or vital signs recording, discharge the patient and clear the patient database, then enter standby mode. If an **End Case** SmartKey is configured for your monitor, you can also select this instead and then confirm.

To see which end case reports are set up for your monitor, select **Main Setup** -> **Reports** -> **Auto Reports**. For each auto report, if **End Case Report** is set to **On**, this report will be printed when you select **End Case**. See the section on AutoReports for information on setting up end case reports.

- **Discharge Patient** - to discharge the patient without printing any reports.

New Patient Check

The monitor can be configured to ask you in certain situations:

- after a specified power-off period
- after a specified standby period
- when no basic vitals (HR, RR, Pulse, SpO₂, NBP) have been measured for a specified period

whether a new patient is now being monitored. The pop-up window is entitled **Is this a new Patient?**. The monitor offers a **Yes** key to discharge the previous patient and begin monitoring a new patient and a **No** key to continue monitoring with the current patient data and settings.

The time periods for the three conditions can be configured independently.

Transferring Patients

To save you from having to enter the same patient data multiple times and enable patient transfer without loss of data, patient demographic information is shared between patient monitors and Information Centers.

Transferring a Centrally-Monitored Patient with the Monitor

Scenario: A centrally-monitored patient is moved with the monitor to another monitoring location on the same Information Center database server without interrupting the collection of patient trend information.

- 1 Select the patient name field or select the **Admit/Discharge** SmartKey to open the **Patient Demographics** window, then select the **Transfer** pop-up key. If the patient is not admitted or not monitored by an Information Center, the **Transfer** key is inactive (“grayed-out”).
This step preserves the patient’s demographic data during the transfer.
- 2 At the new location, connect the monitor to the network (only needed for wired networks). If the monitor detects a patient mismatch, a window will open showing your patient’s data and asking **Complete transfer of this patient?**.
- 3 Select **Yes** to complete the transfer.
- 4 Verify that the settings for patient category and paced mode are correct.

If you accidentally transfer a patient, use **Re-Admit** to restore this patient’s data to the Information Center. If you are not connected to the network, select **Clear Transfer** to leave transfer mode. The patient data remains in the monitor.

Data Exchange Between Information Centers

You can transfer demographic data and trend data from one IIC to another by selecting **Transfer** on the patient monitor. Trend data is not shared between Information Centers and monitors.

Resolving Patient Information Mismatch

When you connect together devices which store patient demographic data, for example:

- an MMS and a monitor,
- an X2 or MP5 and a host monitor,
- a monitor and an Information Center,

the system compares patient category, paced status, and unique patient identification in order to synchronize this information. If configured to do so, the monitor indicates a mismatch if the information is not identical.

-
- WARNING**
- 1 When a monitor is connected to an Information Center by the wireless IntelliVue Instrument Telemetry interface, the patient data will automatically be merged in the case of a transfer. This means there is no patient discharge at the monitor and settings and trend data will be retained. You will see a message on the monitor and the Patient Demographics window will automatically appear so that you can check the data and change it if necessary.
 - 2 It is important to resolve the mismatches as soon as they are identified. Failure to do so could result in using incorrect/confusing data to make clinical decisions. Certain settings, for example Paced and Patient Category, may not match between the Information Center and the monitor. If the Paced status is set incorrectly, the system could mistake a pace pulse for a QRS and fail to alarm in the case of asystole. It is important that the Patient Category is set correctly so the ECG can be analyzed correctly and initial arrhythmia alarm limits set.
In the case where an MP5 or X2 with an IntelliVue Instrument Telemetry interface is declared as a “telemetry device” at the Information Center and is connected to a host monitor, it is important to resolve an existing mismatch between the monitor and the Information Center before disconnecting the MP5/X2. Failure to do so discharges the MP5/X2 and synchronizes the demographics and settings to the Information Center.
-

Manually Resolving Patient Mismatch

The source of the patient mismatch is indicated by question marks (???) and displayed in the status line at the bottom of the screen (**Patient ???**, **Patient Category ???** or **Paced ???**).

The **Select Patient** window automatically opens so you can decide which patient data to use. You do not have to resolve the mismatch immediately, but the indicators remain until you do.

For some common mismatch situations, the monitor will simplify the resolution by suggesting a solution for the mismatch. For example, when a patient arrives after transport and the **Transfer** key has been selected, the monitor will show this patient’s data and ask **Complete transfer of this patient?**. You can then select **Yes** to complete the transfer. If you select **No** you will go to the **Select Patient** window.

After you resolve the mismatch, the monitor displays a confirmation window that shows the patient that has been selected and where data will be erased, if applicable. Confirm your choice. The monitor automatically displays the **Patient Demographics** window after confirmation. Verify that the settings shown are correct for the patient.





Gender, date of birth, height, weight, and nursing notes do not generate a mismatch. If these fields are different on different devices, the monitor resolves them itself. For example, it may take date of birth from the Information Center, whilst taking gender from the monitor. Always check the Patient Demographics after combining patients, to ensure that you are satisfied with the results. Change them if necessary.

WARNING After resolving a patient mismatch, check that the monitor settings (especially patient category, paced status and alarm limits) are correct for the patient.

Patient Mismatch - If One Set of Patient Data is Correct

- ◆ If there is a mismatch between an Information Center and a monitor, choose the data set you want to continue using for this patient by selecting one of the sectors in the **Select Patient** window.

After you resolve the mismatch, the monitor displays a confirmation window that shows the patient that has been selected and where data will be erased, if applicable. Confirm your choice. The monitor automatically displays the **Patient Demographics** window after confirmation. Verify that the settings shown are correct for the patient.

Select Patient		✕
	DOE, JOHN F 1234HG9556, 2008/00123 Adult Non-Paced	
	MILLER, Adult Paced	
	Same Patient	
	New Patient	

Patient Mismatch - If Neither Patient Data Set is Correct

A patient mismatch where neither set of patient data is correct might occur if you connect a new MMS to a monitor in order to prepare for a new patient, before you actually start measuring.

- ◆ Select **New Patient** if you are sure that none of the information is correct. This discharges all patients, erases all data in both the monitor and MMS, resets all settings to the default Profile, and lets you admit a new patient.

Patient Mismatch - If Both Patient Data Sets Are Correct

A patient mismatch where both sets of patient data are correct might occur if you admit a new patient at the monitor (or Information Center) before the patient arrives at your unit and then connect the MMS that was used during the patient transport to the monitor.

- ◆ Select **Same Patient** if the patient information is different, but you are sure it is the same patient. This merges the demographics and updates them in the Information Center, monitor, and MMS, according to this table. Be aware that your monitor may be configured to merge trend data from the MMS and the monitor, and to upload measurement settings from the MMS to the monitor.

ECG, Arrhythmia, ST and QT Monitoring

The electrocardiogram (ECG) measures the electrical activity of the heart and displays it on the monitor as a waveform and a numeric. This section also tells you about arrhythmia monitoring (see page 105), ST monitoring (see page 117) and QT monitoring (see page 127).

Skin Preparation for Electrode Placement

Good electrode-to-skin contact is important for a good ECG signal, as the skin is a poor conductor of electricity.

- 1 Select sites with intact skin, without impairment of any kind.
- 2 Clip or shave hair from sites as necessary.
- 3 Wash sites thoroughly with soap and water, leaving no soap residue.
We do not recommend using ether or pure alcohol, because this dries the skin and increases the resistance.
- 4 Dry skin thoroughly.
- 5 Gently abrade the skin using ECG skin preparation paper to remove dead skin cells to improve the conductivity of the electrode site.

Connecting ECG Cables

- 1 Attach the clips or snaps to the electrodes before placing them. If you are not using pre-gelled electrodes, apply electrode gel to the electrodes before placement.
- 2 Place the electrodes on the patient according to the lead placement you have chosen.



1 - ECG Connector

- 3 Attach the electrode cable to the patient cable.
- 4 Plug the patient cable into the white ECG connector on the monitor. An ECG waveform and numeric appears on the monitor display.

CAUTION To protect the monitor from damage during defibrillation, for accurate ECG information and to protect against noise and other interference, use only ECG electrodes and cables specified by Philips.

Selecting the Primary and Secondary ECG Leads

The monitor uses the primary and secondary lead to compute HR and to analyze and detect cardiac arrhythmias. They are also available for recordings and for display on the Information Center.

The secondary lead is only used if your monitor is configured for multi-lead (instead of single-lead) arrhythmia analysis.



You should choose a lead as primary or secondary lead that has the following characteristics:

- the QRS complex should be either completely above or below the baseline and it should not be biphasic
- the QRS complex should be tall and narrow
- the P-waves and T-waves should be less than 0.2 mV

To select a lead as primary or secondary lead:

- ◆ In the **Setup ECG** menu, select **Primary** or **Secondary**, then select the appropriate lead. You can assign any available lead whether it is currently displayed or not.

Checking Paced Status

It is important to set the paced status correctly when you start monitoring ECG.

- ◆ To change the paced status in the **Setup ECG** menu, select **Paced** to toggle between **Yes** or **No**.

WARNING Pace pulse rejection must be switched on for paced patients by setting “Paced” to Yes. Switching pace pulse rejection off for paced patients may result in pace pulses being counted as regular QRS complexes, which could prevent an asystole event from being detected. When changing profiles, and at admission/discharge, always check that paced status is correct for the patient.

Some pace pulses can be difficult to reject. When this happens, the pulses are counted as a QRS complex, and could result in an incorrect HR and failure to detect cardiac arrest or some arrhythmias. Make sure that pace pulses are detected correctly by checking the pace pulse markers on the display. Keep pacemaker patients under close observation.

Understanding the ECG Display

Your display may be configured to look slightly different.

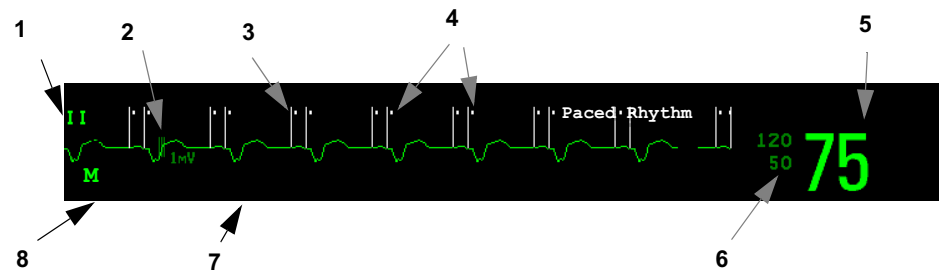

- 1 Lead label of the displayed wave
- 2 1 mV calibration bar
- 3 Pacer spikes
- 4 Pace pulse markers
- 5 Current heart rate
- 6 Current heart rate alarm limits
- 7 EASI lead placement label
- 8 ECG Filter label

ECG HR numeric: This is the heart rate derived from the monitored ECG.

Pace pulse markers: These are shown if the **Paced** status has been set to **Yes**, the pacer spikes are not configured to have a fixed size, and the patient has a paced signal.

Pacer Spikes: The pacer spikes are shown in white, unless the ECG wave is white, then they will be green. If the pacer spikes have been configured to have a fixed size, they will be displayed in the background as a dotted line.

- 1 Pacer spikes configured to have a fixed size

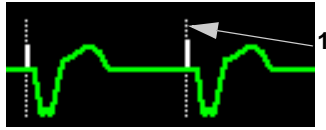

Defibrillator synchronization marks: If an HP/Agilent/Philips defibrillator is connected, the synchronization marks (vertical lines on the ECG wave) are shown on the ECG wave. The synchronization marks will be shown in yellow, unless the ECG wave is yellow, then they will be green.

If so configured, the monitor can supply its own synchronization marks; in this case the synchronization marks from a defibrillator will not be shown.

ST numerics in ECG wave: ST numerics can be configured to show underneath the ECG wave on the left side.

Monitoring Paced Patients

An ECG optimized for monitoring a paced patient should look like this:



- 1 Normal Beats
2 Pace Pulses/Beats

You should choose a lead as primary or secondary lead that has these characteristics:

- the normal QRS complex should be either completely above or below the baseline and it should not be biphasic. For paced patients, the QRS complexes should be at least twice the height of pace pulses.
- the QRS complex should be tall and narrow
- the P-waves and the T-waves should be less than 0.2 mV.

For ease of identification on the screen, the pacemaker spikes can be configured to have a fixed size. They are then shown in the background as a dotted lines. The length of the dotted line is fixed to the wave channel height and is independent of the actual pacemaker amplitude.

Setting the Paced Status (Pace Pulse Rejection)

- ◆ In the **Setup ECG** menu, select **Paced** to toggle between **Yes** and **No**.

You can also change the paced status in the Patient Demographics window.

When **Paced** is set to **Yes**:

- Pace Pulse Rejection is switched on. This means that pacemaker pulses are not counted as extra QRS complexes.
- pace pulse marks are shown on the ECG wave as a small dash (only when the pacer spikes are not configured to have a fixed size)
- the paced symbol is displayed under the HR label.

When **Paced** is set to **No**, pacer spikes are not shown in the ECG wave. Be aware that switching pace pulse rejection off for paced patients may result in pace pulses being counted as regular QRS complexes, which could prevent an asystole event from being detected.

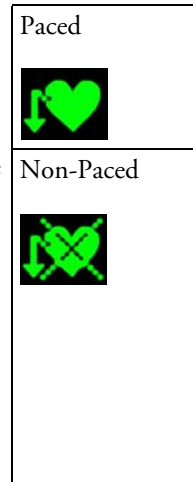

Avoiding Pace Pulse Repolarization Tails

Some unipolar pacemakers display pace pulses with repolarization tails. These tails may be counted as QRSs in the event of cardiac arrest or other arrhythmias.

If you note a visible repolarization tail, choose a lead that decreases the size of the repolarization tail.

- 1 Repolarization tail (note width)



Changing the Size of the ECG Wave

If any of the displayed ECG waves is too small or clipped, you can change the size of one or all of the ECG waves on the screen.

Changing the adjustment factor only changes the visual appearance of the ECG wave on the screen. It does not affect the ECG signal analyzed by the monitor.

Comparing the wave size to the 1 mV calibration bar on the ECG wave segment can help you to get an idea of the true ECG signal strength. If you choose a fixed adjustment factor, the 1 mV calibration bar will be the same size for all the displayed ECG waves. If you choose **AutoSize**, or an individual size using the **Size Up / Size Down** keys, the calibration bar may be a different size for each wave.

To Change the Size of an Individual ECG Wave

- 1 Select the wave segment you want to change. This calls up the lead menu for this segment.

- 2 In the lead menu, select **Size Up** to increase wave size or **Size Down** to decrease the size. Selecting **AutoSize** lets the monitor choose the optimal adjustment factor for all displayed ECG waves.

To Change the Size of all the ECG Waves

To change the size of all the ECG waves on the screen by a fixed adjustment factor,

- 1 In the **Setup ECG** menu, select **Adjust Size**.
- 2 Select the required adjustment factor from the line of pop-up keys.
 - **Size x0.5** to halve the wave size
 - **Size x1** to display the wave without zoom
 - **Size x2** to double the wave size
 - **Size x4** to multiply the wave size by four

Changing the Volume of the QRS Tone

The QRS tone is derived from either the HR or Pulse, depending on which is currently selected as the alarm source. The QRS volume can be set from 0 to 10 (0 means off).

- ◆ To change the QRS volume, in the **Setup ECG** menu select **QRS Volume** and then select the appropriate volume from the pop-up list.

Changing the ECG Filter Settings

The ECG filter setting defines how ECG waves are smoothed. An abbreviation indicating the filter type is shown underneath the lead label on the monitor display. Filter settings do not affect ST measurement.

- ◆ To change the filter setting, in the **Setup ECG** menu, select **Filter** and then select the appropriate setting.
 - **Monitor**: Use under normal measurement conditions.
 - **Ext. Monitor**: Use for pediatric and neonatal patients when diagnostic quality is required but low frequency interference or a wandering baseline may be expected. The upper edge frequency is the same as the **Diag** setting and the lower edge frequency is the same as the **Monitor** setting.
 - **Filter**: The filter reduces interference to the signal. It should be used if the signal is distorted by high frequency or low frequency interference. High frequency interference usually results in large amplitude spikes making the ECG signal look irregular. Low frequency interference usually leads to a wandering or rough baseline. In the operating room, the Filter reduces artifacts and interference from electro-surgical units. Under normal measurement conditions, selecting **Filter** may suppress the QRS complexes too much and thus interfere with the clinical evaluation of the ECG displayed on the monitor. This does not affect the ECG analysis performed by the monitor.
If **AutoFilter** is set to **On** in Configuration Mode, the filter setting will automatically be set to **Filter** if electromagnetic interference is detected.

- **Diag**: Use when diagnostic quality is required. The unfiltered ECG wave is displayed so that changes such as R-wave notching or discrete elevation or depression of the ST segments are visible.

The setting **Diag** selects the highest available ECG bandwidth which is 0.05 to 150 Hz for the Adult, Pedi and Neo patient category. The term “diagnostic” relates only to the ECG bandwidth requirements for diagnostic electrocardiographic devices as outlined in the ANSI/AAMI standard EC11-1991.

When you are using a telemetry transmitter connected via short range radio to the monitor, the upper bandwidth for all filter settings is limited to 40 Hz.

Selecting Positions of Va and Vb Chest Leads (for 6-lead placement)

The two chest leads for the 6-lead placement can be positioned at any two of the V1 to V6 positions. Select the positions you have used in the **Setup ECG** menu, so that the chest leads will be correctly labeled.

- 1 In the **Setup ECG** menu, select **Va Lead**.
- 2 Select the position used from the list.
- 3 Select **Vb Lead** and select the position used from the list

Choosing EASI or Standard Lead Placement

You must enable either standard lead placement or EASI lead placement.

- ◆ In the **Setup ECG** menu, select **Placement** and then **Standard** or **EASI**.

EASI is shown beside the 1mV calibration bar on the ECG wave on the display, and **EASI** is marked on any printouts.

See the section on EASI ECG Lead Placement for electrode placement diagrams.

About ECG Leads

To make it possible to compare measured ECG signals, the electrodes (or lead sets) are placed in standardized positions, forming so-called “leads”. To obtain ECG signals optimized for use in diagnosis and patient management in different care environments, different lead sets in varying lead placements can be used. You can use either standard lead placements or EASI lead placements with this monitor.

When placing electrodes, choose a flat, non-muscular site where the signal will not be interfered with by either movement or bones. Correct lead placement is always important for accurate diagnosis. Especially in the precordial leads, which are close to the heart, QRS morphology can be greatly altered if an electrode is moved away from its correct location.

ECG Leads Monitored

If you are using	these leads are available:	Resp is measured between electrodes:
a 3-electrode set	I, II, III	RA and LL
a 5-electrode set	I, II, III, aVR, aVL, aVF, V and MCL	RA and LL
a 6-electrode set	I, II, III, aVR, aVL, aVF, Va, Vb	RA and LL
a 10-electrode set	I, II, III, aVR, aVL, aVF, V1, V2, V3, V4, V5, V6	RA and LL
an EASI 5-electrode set	I, II, III, aVR, aVL, aVF, V1, V2, V3, V4, V5, V6	I and A

Changing Lead Sets

To change the ECG lead set,

- **When adding leads:** place the additional electrodes as required - the monitor automatically recognizes the new lead placement.
- **When removing leads:** there are two possibilities - removing the complete chest leads block or removing individual leads. If you unplug the chest lead block from the trunk cable connector, the monitor will automatically recognize the new lead placement. Remove individual leads by removing the electrodes. The monitor will issue a **Lead Off** INOP message; select **New Lead Setup** in the **Setup ECG** menu and the INOP message will disappear.

ECG Lead Fallback

If fallback is configured on and there is a leads off INOP in the primary lead (and in the secondary lead, if you are using multi-lead monitoring) for longer than 10 seconds, and if another lead is available, this available lead automatically becomes the primary lead. This is known as lead fallback. When the Leads Off condition is corrected, the leads are automatically switched back.

This setting can only be changed in Configuration Mode.

ECG Lead Placements

The labels and colors of the ECG electrodes differ according to the standards that apply for your hospital. The electrode placement illustrations in this chapter use the AAMI labels and colors.

Electrode labels			Electrode colors	
AAMI	EASI	IEC	AAMI	IEC
RA	I	R	White	Red
LA	S	L	Black	Yellow
LL	A	F	Red	Green
RL	N	N	Green	Black
V	E	C	Brown	White
V1		C1	Brown/Red	White/Red
V2		C2	Brown/Yellow	White/Yellow

Electrode labels			Electrode colors	
AAMI	EASI	IEC	AAMI	IEC
V3		C3	Brown/Green	White/Green
V4		C4	Brown/Blue	White/Brown
V5		C5	Brown/Orange	White/Black
V6		C6	Brown/Violet	White/Violet

Standard 3-Lead Placement

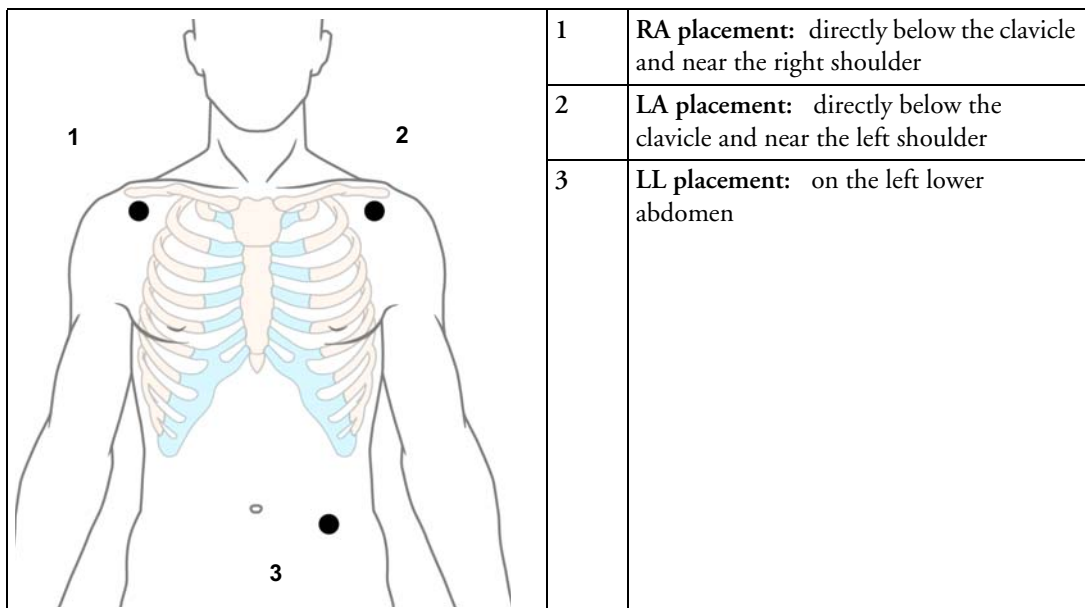

Standard 5-Lead Placement

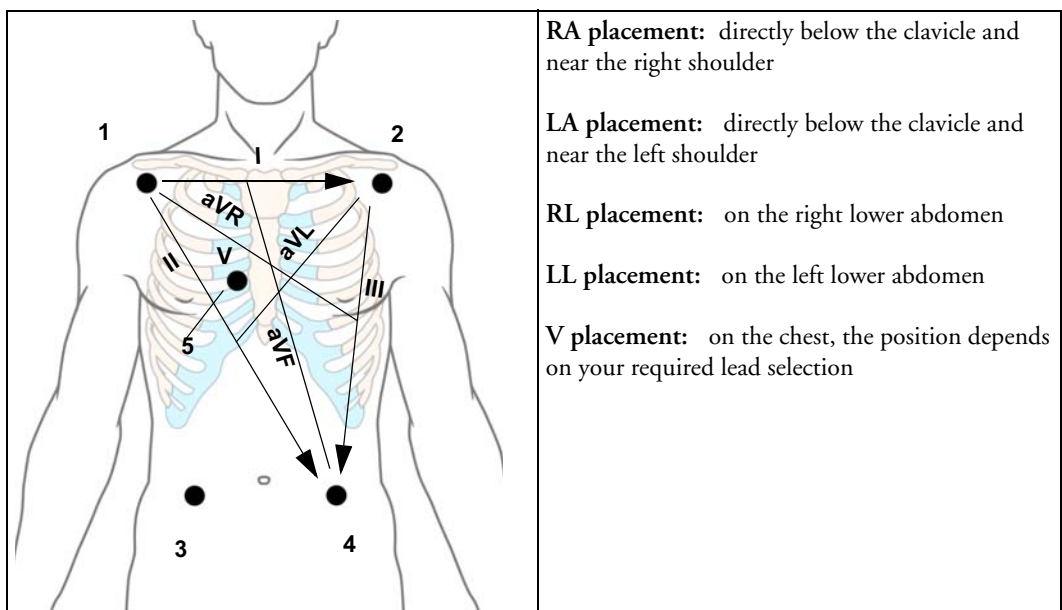

6-Lead Placement

For a 6-lead placement use the positions from the 5-lead diagram above but with two chest leads. The two chest leads, Va and Vb, can be positioned at any two of the V1 to V6 positions shown in the chest electrode diagram below. The Va and Vb lead positions chosen must be selected in the ECG Setup Menu to ensure correct labeling.

Chest Electrode Placement

For accurate chest electrode placement and measurement, it is important to locate the fourth intercostal space.

- 1 Locate the second intercostal space by first palpating the Angle of Lewis (the little bony protuberance where the body of the sternum joins the manubrium). This rise in the sternum is where the second rib is attached, and the space just below this is the second intercostal space.
- 2 Palpate and count down the chest until you locate the fourth intercostal space.

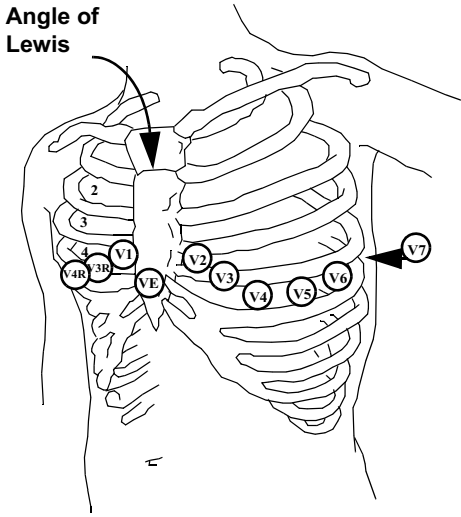
 <p>Angle of Lewis</p>	<p>V1 placement: on the fourth intercostal space at the right sternal border</p> <p>V2 placement: on the fourth intercostal space at the left sternal border</p> <p>V3 placement: midway between the V2 and V4 electrode positions</p> <p>V4 placement: on the fifth intercostal space at the left midclavicular line</p> <p>V5 placement: on the left anterior axillary line, horizontal with the V4 electrode position</p>
<p>V6 placement: on the left midaxillary line, horizontal with the V4 electrode position</p> <p>V3R to V6R placement: on the right side of the chest in positions corresponding to those on the left</p> <p>VE placement: over the xiphoid process</p> <p>V7 placement: on posterior chest at the left posterior axillary line in the fifth intercostal space</p> <p>V7R placement: on posterior chest at the right posterior axillary line in the fifth intercostal space</p>	

10-Lead Placement

When monitoring 12-leads of ECG, using a 10-Electrode Lead Placement, it is important to correctly place electrodes and to label all 12-lead ECG reports with the correct lead placement.

Conventional 12-Lead ECG

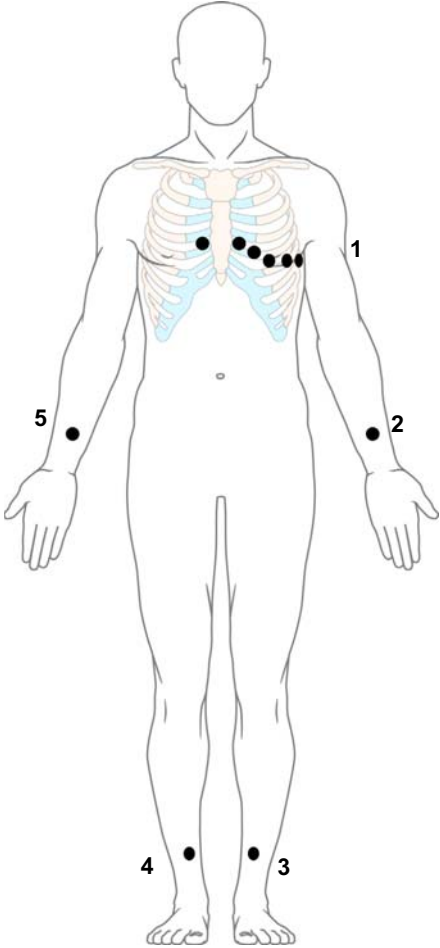
 <p>1 - V1 - V6 2 - LA 3 - LL 4 - RL 5 - RA</p>	<p>In conventional 12-Lead ECG using 10 electrodes, an electrode is placed on the right arm, left arm, right leg, and left leg. Six V-electrodes are placed on the chest. The right leg electrode is the reference electrode.</p> <p>Limb electrodes:</p> <ul style="list-style-type: none"> - Place arm electrodes on the inside of each arm, between the wrist and the elbow. - Place leg electrodes inside of each calf, between the knee and the ankle. <p>Chest electrodes:</p> <p>V1 - on the 4th intercostal space at the right sternal border</p> <p>V2 - on the 4th intercostal space at the left sternal border</p> <p>V3 - midway between the V2 and V4 electrode positions</p> <p>V4 - on the 5th intercostal space at the left midclavicular line</p> <p>V5 - on the left anterior axillary line, horizontal with the V4 electrode position</p> <p>V6 - on the left midaxillary line, horizontal with the V4 electrode position</p>
---	--

Modified 12-Lead ECG

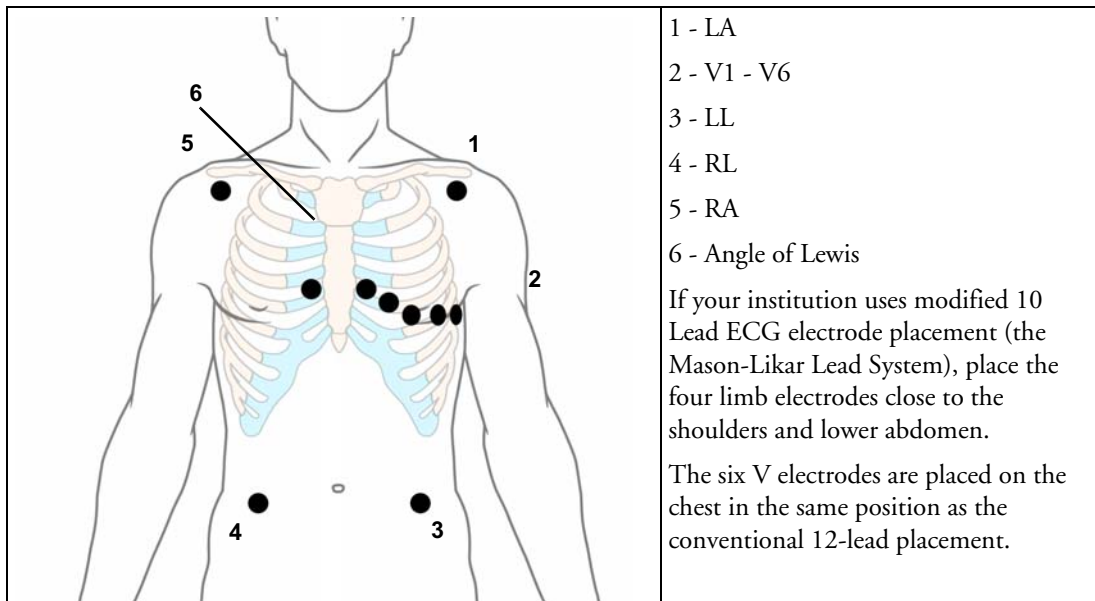

Choosing Standard or Modified Electrode Placement

If your institution uses modified 10 Lead ECG electrode placement (the Mason-Likar Lead System), you must switch **ModLdPlcmt** to **On** in the monitor. To do this,

- ◆ in the **Setup ECG** menu, select **ModLdPlcmt** to toggle between **On** and **Off**.
 - When **ModLdPlcmt** is set to **On**, 12 Lead ECG Reports will be labelled **12 Lead ECG Report (Mason-Likar)**, and captured 12-lead ECGs will be labelled **Mason-Likar** to the right of the bandwidth annotation at the Information Center.
 - When **ModLdPlcmt** is set to **Off**, 12 Lead ECG Reports will be labelled **12 Lead ECG Report**, and captured 12-lead ECGs will not be annotated at the Information Center.

WARNING Do not use ECG analysis interpretation statements and measurements for 12-lead ECGs obtained using the modified (Mason-Likar) limb electrode placement. This may lead to misdiagnosis since the modified (Mason-Likar) limb electrode placement does not look the same as the conventional 12-lead ECG and may mask inferior infarction due to calculated axis, R, P and T wave magnitudes shifts and ST slope.

Do not export 12-lead ECGs obtained using the modified (Mason-Likar) limb electrode placement. Captured 12-Lead ECGs using the modified (Mason-Likar) limb electrode placement exported from the Information Center are not annotated with the Mason-Likar label.

Capture 12-Lead

If the monitor is connected to an Information Center via a wired network, the **Capture 12-Lead** SmartKey may be configured. Selecting this exports 12-Lead ECG information to the Information Center for analysis. For details see the Instructions for Use supplied with the Information Center.

EASI ECG Lead Placement

Using a standard 5-electrode set in EASI lead placement you can monitor up to 12 standard ECG leads simultaneously and continuously at the bedside. EASI provides a monitoring method for trending ST segment changes that can provide an early indication of ischemia.

WARNING EASI-derived 12-lead ECGs and their measurements are approximations to conventional 12-lead ECGs. As the 12-lead ECG derived with EASI is not exactly identical to the 12-lead conventional ECG obtained from an electrocardiograph, it should not be used for diagnostic interpretations.

Respiratory monitoring is also possible with the EASI placement; respiration is measured between the I and A electrodes.

Place the electrodes as accurately as possible to obtain the best quality EASI measurements.

When EASI lead placement is selected, **EASI** is shown beside the 1mV calibration bar on the ECG wave on the display, and **EASI** is marked on any recorder strips and printouts.

When EASI lead placement is selected, **EASI** is shown beside the 1mV calibration bar on the ECG wave on the display, and **EASI** is marked on any printouts.

EASI Monitoring During INOP Conditions If one of the derived EASI leads has an INOP condition (for example, **LEAD OFF**), a flat line is displayed. After 10 seconds, the directly acquired EASI AI, AS, or ES lead (depending on which is available) is displayed with the corresponding lead label. This causes an arrhythmia relearn.

EASI Electrode Placement		
1	E (V)	on the lower sternum at the level of the fifth intercostal space
2	A (LL)	on the left midaxillary line at the same level as the E electrode
3	S (LA)	on the upper sternum
4	I (RA)	on the right midaxillary line at the same level as the E electrode
5	N	reference electrode - can be anywhere, usually below the sixth rib on the right hip

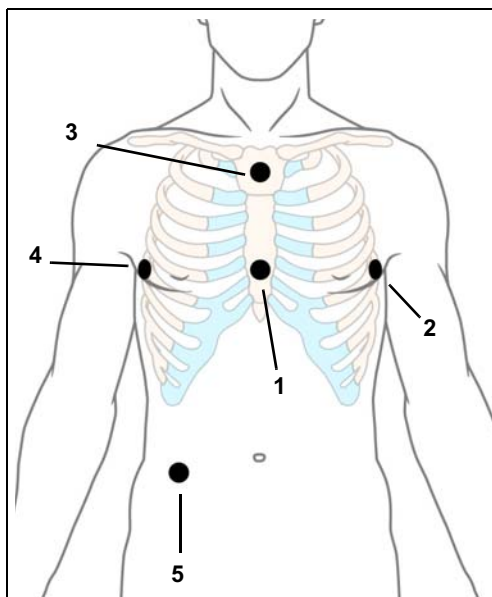

ECG and Arrhythmia Alarm Overview

The ECG and arrhythmia alarms available depend on which measurements are switched on, and the arrhythmia option enabled for your monitor.

- Cardiotach alarms are available when HR is on and the active alarm source is ECG, but arrhythmia is switched off
- Basic arrhythmia alarms are available when Arrhythmia is switched on
- Advanced arrhythmia alarms are available when Arrhythmia is switched on and the Advanced Arrhythmia option has been enabled for your monitor

Cardiotach Alarms	Additional Alarms with Basic Arrhythmia Option	Additional Alarms with Enhanced Arrhythmia Option
***Asystole ***Ventricular Fibrillation/ Tachycardia ***Extreme Bradycardia ***Extreme Tachycardia **High heart rate **Low heart rate	***Ventricular Tachycardia **Pacer Not Capture **Pacer Not Pacing **PVCs/min HIGH(PVC > limit/min)	**Afib **Supraventricular Tach **Missed Beat **Pause **Irregular HR **Ventricular Rhythm **Run PVCs High **Pair PVCs **R-on-T PVCs **Ventricular bigeminy **Ventricular trigeminy **Non-sustain VT **Multiform PVCs

Using ECG Alarms

ECG alarms can be switched on and off and the high and low alarm limits changed just like other measurement alarms, as described in the Alarms section. Special alarm features which apply only to ECG are described here.

Extreme Alarm Limits

The extreme rate alarms, Extreme Tachy and Extreme Brady, generated by the active alarm source, either HR or Pulse, are set in Configuration Mode by adding a set value (the Δ value) to the high and low alarm limits.

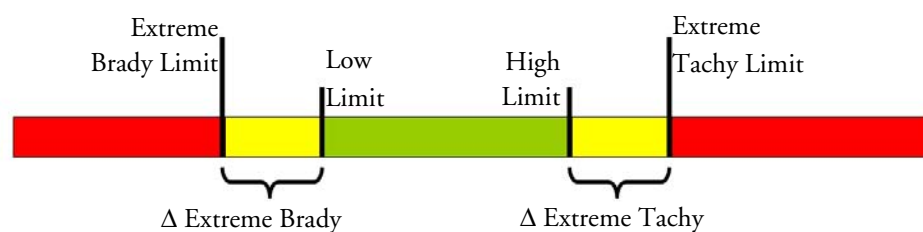

You need to know which value has been configured for your monitor. Changing the high and low alarm limits automatically changes the extreme alarm limits within the allowed range.

- ◆ To see the extreme rate alarms set for your monitor, in the **Setup ECG** menu, see the menu items **ΔExtrTachy** and **ΔExtrBrady**.

ECG Alarms Off Disabled

Be aware that your hospital department may have decided to disable the setting ECG Alarms Off in the monitor's Configuration Mode. In this case, HR alarms cannot be switched off in Monitoring Mode. If you try to switch off the HR alarms, you will see the message **To activate enter Config and enable Alarms Off**.

HR Alarms When Arrhythmia Analysis is Switched Off

When arrhythmia analysis is switched off, only these HR-related alarms will be detected:

- the asystole alarm
- the ventricular fibrillation/tachycardia alarm
- the extreme tachycardia and extreme bradycardia alarms
- the high heart rate and low heart rate alarms.

Enhanced Asystole Detection

In order to improve alarming on asystole under certain conditions, you can set **Asystole Detect** in Configuration Mode to **Enhanced**. In enhanced mode an asystole alarm will be suppressed for up to five seconds if a valid beat-to-beat Pulse is detected from a Pressure.

ECG Safety Information

CAUTION Interference from instruments near the patient and ESU interference can cause problems with the ECG wave. See the monitor specifications for more information.

WARNING **Defibrillation and Electrosurgery:** Do not touch the patient, or table, or instruments, during defibrillation.
After defibrillation, the screen display recovers within 10 seconds if the correct electrodes are used and applied in accordance with the manufacturers instructions.

ECG cables can be damaged when connected to a patient during defibrillation. Check cables for functionality before using them again.

According to AAMI specifications the peak of the synchronized defibrillator discharge should be delivered within 60 ms of the peak of the R wave. The signal at the ECG output on the IntelliVue patient monitors is delayed by a maximum of 30 ms. Your biomedical engineer should verify that your ECG/Defibrillator combination does not exceed the recommended maximum delay of 60 ms.

When using electrosurgical (ES) equipment, never place ECG electrodes near to the grounding plate of the ES device, as this can cause a lot of interference on the ECG signal.

General: When you are connecting the electrodes or the patient cable, make sure that the connectors never come into contact with other conductive parts, or with earth. In particular, make sure that all of the ECG electrodes are attached to the patient, to prevent them from contacting conductive parts or earth.

During surgery: Use the appropriate orange electrode ECG safety cable, or lead cable with an orange connector, for measuring ECG in the operating room. These cables have extra circuitry to protect the patient from burns during cautery, and they decrease electrical interference. This also reduces the hazard of burns in case of a defective neutral electrode at the HF device. These cables cannot be used for measuring respiration.

Pacemaker failure: During complete heart block or pacemaker failure to pace/capture, tall P-waves (greater than 1/5 of the average R-wave height) may be erroneously counted by the monitor, resulting in missed detection of cardiac arrest.

Patients exhibiting intrinsic rhythm: When monitoring paced patients who exhibit only intrinsic rhythm, the monitor may erroneously count pace pulses as QRS complexes when the algorithm first encounters them, resulting in missed detection of cardiac arrest.

The risk of missing cardiac arrest may be reduced by monitoring these patients with low heart rate limit at or slightly above the basic/demand pacemaker rate. A low heart rate alarm alerts you when the patient's heart rate drops to a level where pacing is needed. Proper detection and classification of the paced rhythm can then be determined.

Filtered ECG signal from external instruments: Instruments such as defibrillators or telemetry units produce a filtered ECG signal. When this signal is used as an input to the bedside monitor, it is filtered again. If this twice-filtered signal is passed to the arrhythmia algorithm, it may cause the algorithm to fail to detect pace pulses, pacemaker non-capture, or asystole, thus compromising paced patient monitoring performance.

External pacing electrodes: When a pacemaker with external pacing electrodes is being used on a patient, arrhythmia monitoring is severely compromised due to the high energy level in the pacer pulse. This may result in the arrhythmia algorithm's failure to detect pacemaker noncapture or asystole.

Fusion beat pacemakers: Pacemakers that create fusion beats (pace pulse on top of the QRS complex) cannot be detected by the monitor's QRS detector.

Rate adaptive pacemakers: Implanted pacemakers which can adapt to the Minute Ventilation rate may occasionally react on the Impedance measurement used by patient monitors for the determination of the Resp value and execute pacing with the maximum programmed rate. Switching off the Resp measurement can prevent this.

About Arrhythmia Monitoring

Arrhythmia analysis provides information on your patient's condition, including heart rate, PVC rate, rhythm, and ectopics. The monitor uses the user-selected primary and secondary ECG leads for single-lead or multi-lead arrhythmia analysis. During arrhythmia analysis, the monitor continuously

- optimizes ECG signal quality. This is important for arrhythmia analysis. The monitor continuously filters the ECG signal to remove baseline wander, muscle artifact, and signal irregularities. Also, if the Patient Paced status is set to Yes, pace pulses are filtered out to avoid processing them as QRS beats.
- detects beats, for example, QRS complexes, identifying them for further analysis.
- measures signal features such as R-wave height, width, and timing.
- creates beat templates, and classifies and labels beats to aid in rhythm analysis and alarm detection.
- examines the ECG signal for ventricular fibrillation, asystole, and noise.

Arrhythmia Options

Your monitor has either the basic or the enhanced arrhythmia option. Both options provide rhythm and ectopic status messages and beat labelling. The number of rhythms being classified, events being detected, and alarms generated differs according to the option. The alarms available with the different options are listed in the section "ECG and Arrhythmia Alarm Overview" on page 102, the rhythm and ectopic messages detected are listed in "Arrhythmia Status Messages" on page 109.

Where Can I Find More Information?

See the Application Notes on ST and Arrhythmia supplied on your documentation DVD for detailed information on the arrhythmia algorithm and its clinical application.

Switching Arrhythmia Analysis On and Off

- 1 In the **Setup Arrhy** menu, select **Arrhythmia** to toggle between **On** and **Off**.
- 2 Select the **Confirm** pop-up key which appears at the bottom of the screen.

Be aware that when arrhythmia analysis is switched off,

- the message **Arrhythmia Off** appears beside the ECG wave, if configured to do so
- only the HR-related alarms are detected (the asystole alarm, the ventricular fibrillation/tachycardia alarm, the extreme tachycardia and extreme bradycardia alarms, the high heart rate and low heart rate alarms)
- HR High and HR Low alarms behave like normal yellow alarms, no timeout periods are active.

Choosing an ECG Lead for Arrhythmia Monitoring

It is important to select a suitable lead for arrhythmia monitoring.

Guidelines for non-paced patients are:

- QRS complex should be tall and narrow (recommended amplitude > 0.5 mV)
- R-Wave should be above or below the baseline (but not bi-phasic)
- T-wave should be smaller than 1/3 R-wave height
- the P-wave should be smaller than 1/5 R-wave height.

For paced patients, in addition to the above, the pace pulse should be:

- not wider than the normal QRS
- the QRS complexes should be at least twice the height of pace pulses
- large enough to be detected, with no re-polarization.

To prevent detection of P-waves or baseline noises as QRS complexes, the minimum detection level for QRS complexes is set at 0.15 mV, according to AAMI-EC 13 specifications. Adjusting the ECG wave size on the monitor display (gain adjustment) does not affect the ECG signal which is used for arrhythmia analysis. If the ECG signal is too small, you may get false alarms for pause or asystole.

Aberrantly-Conducted Beats

As P-waves are not analyzed, it is difficult and sometimes impossible for the monitor to distinguish between an aberrantly-conducted supraventricular beat and a ventricular beat. If the aberrant beat resembles a ventricular beat, it is classified as ventricular. You should always select a lead where the aberrantly-conducted beats have an R-wave that is as narrow as possible to minimize incorrect calls. Ventricular beats should look different from these 'normal beats'. Instead of trying to select two leads with a narrow R-wave, it may be easier to just select one lead and use single lead arrhythmia monitoring. Extra vigilance is required by the clinician for this type of patient.

Atrial Fibrillation Alarm

The monitor performs atrial fibrillation analysis using information about the RR irregularity, PR interval variability and P wave variability.

In order to generate an Afib alarm the following criteria must be detected for 1 minute:

- normal beat RR intervals must be irregular

- PR interval deviation must be large
- P-wave region must not match well

Atrial fibrillation analysis is only available for adult patients and atrial fibrillation detection cannot be performed on PVCs or Paced beats.

Since most atrial flutters have regular RR intervals, they cannot be detected by the atrial fibrillation algorithm.

An Afib alarm can be falsely detected in the presence of:

- sinus arrhythmia,
- muscle noise, or
- electrode motion artifact.

If you also have monitors with earlier software revisions, the Afib alarm will not be generated after a transfer to one of these monitors. Always leave the Irregular HR alarm switched on, so that this alarm can be generated in such situations.

See the Application Note on Arrhythmia/ST supplied on your documentation DVD for detailed information on the arrhythmia algorithm and ECG analysis.

Intermittent Bundle Branch Block

Bundle branch and the other fascicular blocks create a challenge for the arrhythmia algorithm. If the QRS during the block changes considerably from the learned normal, the blocked beat may be incorrectly classified as ventricular, causing false PVC alarms. You should always select a lead where the bundle branch block beats have an R-wave that is as narrow as possible to minimize incorrect calls. Ventricular beats should look different from these 'normal beats'. Instead of trying to select two leads with a narrow R-wave, it may be easier to just select one lead and use single lead arrhythmia monitoring. Extra vigilance is required by the clinician for this type of patient.

Understanding the Arrhythmia Display

Your monitor screen may look slightly different from the illustration.

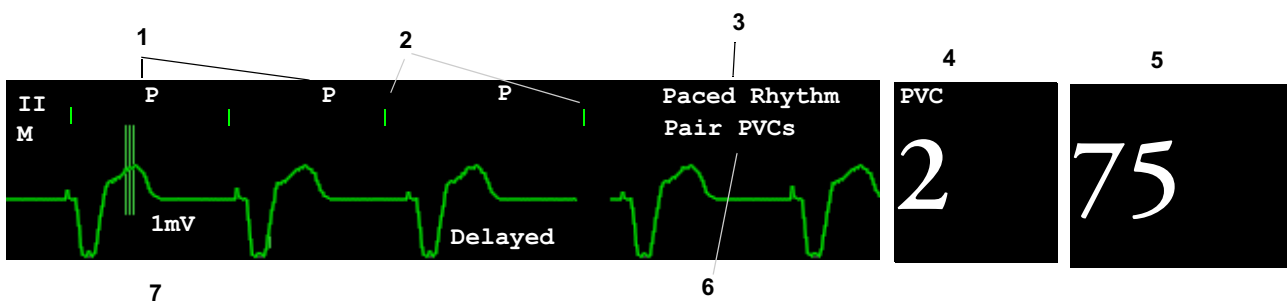

- | | |
|---|-----------------------|
| 1 | Beat label |
| 2 | Pace pulse marks |
| 3 | Rhythm status message |

- 4 PVC Numeric
- 5 HR Numeric
- 6 Ectopic status message
- 7 Delayed arrhythmia wave

Viewing Arrhythmia Waves

- ◆ To review arrhythmia beat labels, in the **Setup Arrhy** menu, select **Annotate Arrhy**.
The wave showing the primary ECG lead will be delayed by six seconds and shown on a grey background. Beat labels will be annotated above the ECG wave and **Delayed** will be written beside it.
- ◆ To return to the normal ECG primary lead display, select **Annotate Arrhy** again.

Arrhythmia Beat Labels

Arrhythmia beat labels tell you how the monitor is classifying beats.

- N** = Normal
- V** = Ventricular Ectopic
- S** = Supra-ventricular Premature
- P** = Paced
- ' = Pacer spike
- “ = Biventricular Pacer Spike
- L** = Learning patient's ECG
- A** = Artifact (noisy episode)
- ? = Insufficient information to classify beats
- I** = Inoperative condition (e.g., LEADS OFF)
- M** = Pause or missed beat

Arrhythmia Status Messages

The monitor displays two types of status messages:

- Rhythm Status Messages -- to indicate the patient's rhythm.
- Ectopic Status Messages -- to indicate the presence of ectopic beats.

These status messages are shown on the right hand side of the primary ECG wave. They are updated every second, with the exception of the Sinus and Supraventricular (SV) rhythm messages.

The Sinus and SV rhythm messages are updated based on the current heart rate, taking into account the patient category (adult, pediatric, or neonatal). For the message to change from one rhythm status to another, the HR must be in the new range for five beats.

If you have basic arrhythmia capability, you will get only messages for the alarms provided with this level.

Rhythm Status Messages

The label B or E indicates basic (B) or enhanced (E) arrhythmia capability.

Rhythm Status Message	Description	B or E
ASYSTOLE	No QRS for 4 consecutive seconds in absence of vent fib or chaotic signal	B, E
VENT FIB/TACH	A fibrillatory wave for 4 consecutive seconds	B, E
V-TACH	A dominant rhythm of adjacent Vs and a HR > the V-Tach Heart Rate Limit	B, E
SUSTAINED V-TACH	Ventricular tachycardia rhythm for more than 15 seconds	E
VENT RHYTHM	A dominant rhythm of adjacent PVCs and a HR ≤ the V-Tach HR Limit	E
VENT BIGEMINY	A dominant rhythm of N, V, N, V	E
VENT TRIGEMINY	A dominant rhythm of N, N, V, N, N, V	E
PACED RHYTHM	A dominant rhythm of paced beats	B, E
IRREGULAR HR	Consistently irregular rhythm	E
SINUS BRADY SINUS RHYTHM SINUS TACHY	A dominant rhythm of SV beats preceded by P-waves	B, E
SV BRADY SV RHYTHM SV TACHY	A dominant rhythm of SV beats not preceded by P-waves	B, E
UNKNOWN ECG RHYTHM	Rhythm cannot be determined	B, E
LEARNING ECG	Algorithm is learning the ECG beat morphology	B, E
LEARNING RHYTHM	Algorithm is learning the rhythm of the classified beats	B, E
CANNOT ANALYZE ECG	ECG signal is predominantly invalid and therefore cannot be analyzed	B, E

Ectopic Status Messages

The label B or E indicates basic (B) or enhanced (E) arrhythmia capability.

Ectopic Status Message	Explanation	B or E
(No message displayed)	No ectopic activity within the last minute	
RUN PVCs	More than 2 consecutive PVCs within the last minute	E
PAIR PVCs	Pair PVCs within the last minute	E
PACER NOT CAPT	Pause with pace pulse (paced patient only) within the last minute	B, E
PACER NT PACING	Pause without pace pulse (paced patient only) within the last minute	B, E
PAUSE	No beat detected for 1.75 x average R-R interval for HR <120, or No beat for 1 second with HR >120 (non-paced patient only), or No beat detected for more than the set pause threshold.	E
R-ON-T PVCs	R-ON-T detected within the last minute	E
MULTIFORM PVCs	Multiform PVCs detected within the last minute	E
FREQUENT SVPBs	SVPB count within last minute is greater than 5	E
SVPBs	1-5 SVPBs in the last minute with a sinus rhythm and no Vs	E
SV BEATS	SV count within last minute and rhythm status is PACED	B, E
PACED BEATS	Paced beat count within last minute and rhythm status is NOT PACED	B, E

Arrhythmia Relearning

During a learning phase:

- Alarm timeout periods are cleared
- Stored arrhythmia templates are cleared
- Asystole, Vfib, and HR alarms (when there are enough beats to compute the HR) are active. No other alarms are active.

Initiating Arrhythmia Relearning Manually

- 1 To initiate relearning manually, in the **Setup Arrhy** menu, select **Relearn Arrhy**.
 - While the monitor is learning, the delayed arrhythmia wave displays the beat label **L** and the rhythm status message **Learning ECG**.
 - Next, the monitor determines the dominant rhythm. The beats are labeled **N**, and the rhythm status message changes to **Learning Rhythm**.
- 2 After relearning is complete, you should check the delayed arrhythmia wave to ensure that the algorithm is labeling the beats correctly.
- 3 If beats are still not classified correctly, check that the ECG is optimized for arrhythmia monitoring. You may need to select a different lead or change the electrodes or electrode positions if there is excessive noise, unstable voltage, low amplitude, or large P- or T-waves.

Automatic Arrhythmia Relearn

Arrhythmia relearning is initiated automatically whenever:

- ECG monitoring is switched on
- The ECG Lead or Lead Label of the primary/secondary lead is changed manually, or when fallback occurs
- A **Leads Off** INOP condition (that has been active for > 60 seconds) ends.

If you are monitoring multi-lead arrhythmia and there is a change in one lead only, relearning happens only in the affected lead. During this learning phase, the system will continue monitoring using the other lead. Therefore, the delayed arrhythmia wave is not labeled **L** and there is no **Learning ECG** rhythm status message. In addition, alarm timeout periods are maintained, stored arrhythmia templates are maintained for the operative lead, and all alarms switched on are active.

Arrhythmia Relearn and Lead Fallback

Lead fallback triggers an automatic arrhythmia relearn.

WARNING If arrhythmia learning takes place during ventricular rhythm, the ectopics may be incorrectly learned as the normal QRS complex. This may result in missed detection of subsequent events of V-Tach and V-Fib.

For this reason you should:

- take care to initiate arrhythmia relearning only during periods of predominantly normal rhythm and when the ECG signal is relatively noise-free
 - be aware that arrhythmia relearning can happen automatically
 - respond to any INOP messages (for example, if you are prompted to reconnect electrodes)
 - be aware that a disconnected EASI electrode triggers an arrhythmia relearn on all leads
 - always ensure that the arrhythmia algorithm is labeling beats correctly.
-

Arrhythmia Alarms

Arrhythmia alarms can be switched on and off and the alarm settings changed just like other measurement alarms, as described in the Alarms section. Special alarm features which apply only to arrhythmia are described here.

The different alarms detected and generated by the monitor depend on the level of arrhythmia analysis that is enabled. For a complete list of arrhythmia alarms and INOPs, see the Alarms chapter.

The monitor detects arrhythmia alarm conditions by comparing ECG data to a set of pre-defined criteria. An alarm can be triggered by a rate exceeding a threshold (for example, HR >xx), an abnormal rhythm (for example, Ventricular Bigeminy), or an ectopic event (for example, Pair PVCs).

Yellow Arrhythmia Alarms

Yellow arrhythmia alarms are short yellow alarms specific to arrhythmia-related patient conditions. Depending on your monitor and Information Center configuration, they may be shown with one or two stars. The heart rate alarms (High HR and Low HR) can be configured as short yellow or standard yellow alarms. When they are standard yellow alarms they exist independently of the other arrhythmia alarms and no timeout periods apply.

WARNING When arrhythmia analysis is on, all yellow ECG and arrhythmia alarms are short yellow alarms (one-star). This means that the yellow alarm lamp and the tones are active for six seconds only, after which the blinking numeric and the alarm message remain for up to three minutes. The only exception to this are the HR High and Low alarms which can be configured as standard yellow alarms. Red alarms behave as usual.

Arrhythmia Alarms and Latching

When using arrhythmia analysis, **Visual Latching** and **Audible Latching** should be on for red alarms, or at least **Visual Latching** should be on. Because of the transient nature of arrhythmia alarms, many arrhythmia conditions may go unnoticed if alarm latching is off. This setting can only be changed in Configuration Mode.

Switching Individual Arrhythmia Alarms On and Off

Some arrhythmia alarms can be individually switched on or off. They are:

Pacer not capture, Pacer not pace, Non-Sustain VT, Vent Rhythm, Run PVCs, Pair PVCs, R-on-T PVCs, V.Bigeminy, V.Trigeminy, Multif.PVCs, Pause, SVT, Irregular HR, Missed Beat, PVCs/min and Afib.

- ◆ To switch individual alarms on or off, in the **Setup Arrhythmia** menu, select the alarm from the list to toggle between **On** and **Off**. The monitor displays the INOP message **SOME ECG ALARMS OFF**, if configured, when more alarms are switched off than configured in your active profile.

Switching All Yellow Arrhythmia Alarms On or Off

All yellow arrhythmia alarms can be switched on and off together. To do this,

- ◆ In the **Setup Arrhythmia** menu, select **All Yellow Off** or **All Yellow On**.

Adjusting the Arrhythmia Alarm Limits

Some arrhythmia alarms have limits which can be individually adjusted. They are:

Vtach HR, Vtach Run, PVCs/min, Vent Rhythm, SVT HR, SVT Run, Asystole Thresh., Pause Threshold.

- 1 To adjust alarm limits, in the **Setup Arrhythmia** menu, select the alarm to be adjusted.
- 2 Select the appropriate setting from the pop-up list.

Arrhythmia Alarm Timeout Periods

Normally, an arrhythmia alarm is announced when an alarm condition is detected. However, there are certain situations that can inhibit the audible and visible indications of the alarm even though the alarm condition was detected. These include:

- if a more serious alarm condition is active in the same chain
- if a timeout period is in effect for a particular alarm
- if a timeout period is in effect for a higher alarm in that chain.

See “Arrhythmia Alarm Chaining” on page 114 for more details on alarm chains.

What is a Timeout Period?

Timeout periods are automatically started when a yellow arrhythmia alarm is detected. During this period, the same alarm condition will not generate another alarm. Alarm conditions further down the same arrhythmia alarm chain will also not generate an alarm, but alarms further up the chain will: see “Arrhythmia Alarm Chaining” on page 114).

This setting can only be changed in Configuration Mode.

- ◆ To view the timeout period configured for your monitor, in the **Setup Arrhythmia** menu, see the menu items **TimeOut 1st** and **TimeOut 2nd**.

Resetting the Timeout Period

- ◆ To reset the timeout period, press the **Alarms** key and then reselect it.

How are Yellow Arrhythmia Alarms Indicated?

When a yellow arrhythmia alarm is generated, it triggers visual and audible indicators. Yellow arrhythmia alarms are always set to latch visually for three minutes except HR High/Low alarms, if configured to standard yellow. Depending on the alarm condition, audible and visual alarm indicators will appear as follows:

Alarm Condition	Example	Audible Indicators Short yellow alarm tone sounds ...	Visual Indicators Alarm message displayed ...
Single alarm instance	Non-sustained V-tach	when alarm condition is initially detected	for 3 minutes (latching time)
Continuous alarm condition	PVCs/min HIGH	when alarm condition is initially detected and - as an alarm reminder - every time the configured time out period has expired	until the alarm condition stops, plus a maximum of three minutes latching time
Same intermittent alarm condition	Pair of PVCs	each time the alarm condition is detected, provided that the configured timeout period has expired	

If you silence a yellow arrhythmia alarm and the alarm condition still exists, the visual indicators continue until the condition stops. You will get an alarm reminder every time the configured timeout period has expired.

If you silence a yellow arrhythmia alarm and the alarm condition has stopped, the visual indicators are immediately cleared. Silencing an alarm does not reset its time out period, so you will not get a realarm for the same condition or lower on the chain until the timeout expires.

Arrhythmia Alarm Chaining

When arrhythmia analysis is switched on, multiple alarm conditions may be present. Announcing all of the detected alarm conditions would be confusing, and might hide a more serious condition. For this reason, arrhythmia alarms are prioritized in three alarm “chains”: PVC Alarms; Beat Detection Alarms, and Rate Alarms.

Only the highest priority alarm condition in each chain is announced. Lower priority alarms in the same chain will not be announced while an alarm is active or during the configured timeout period. If alarm conditions of equal severity from different chains are detected, the alarm condition that occurred most recently is announced. The exception is Irregular HR, which only occurs if no other alarms are occurring.

See “ECG and Arrhythmia Alarm Overview” on page 102 for information on which alarms are included in the different arrhythmia options. See “Arrhythmia Alarm Timeout Periods” on page 113 for an explanation of how alarm timeouts work.

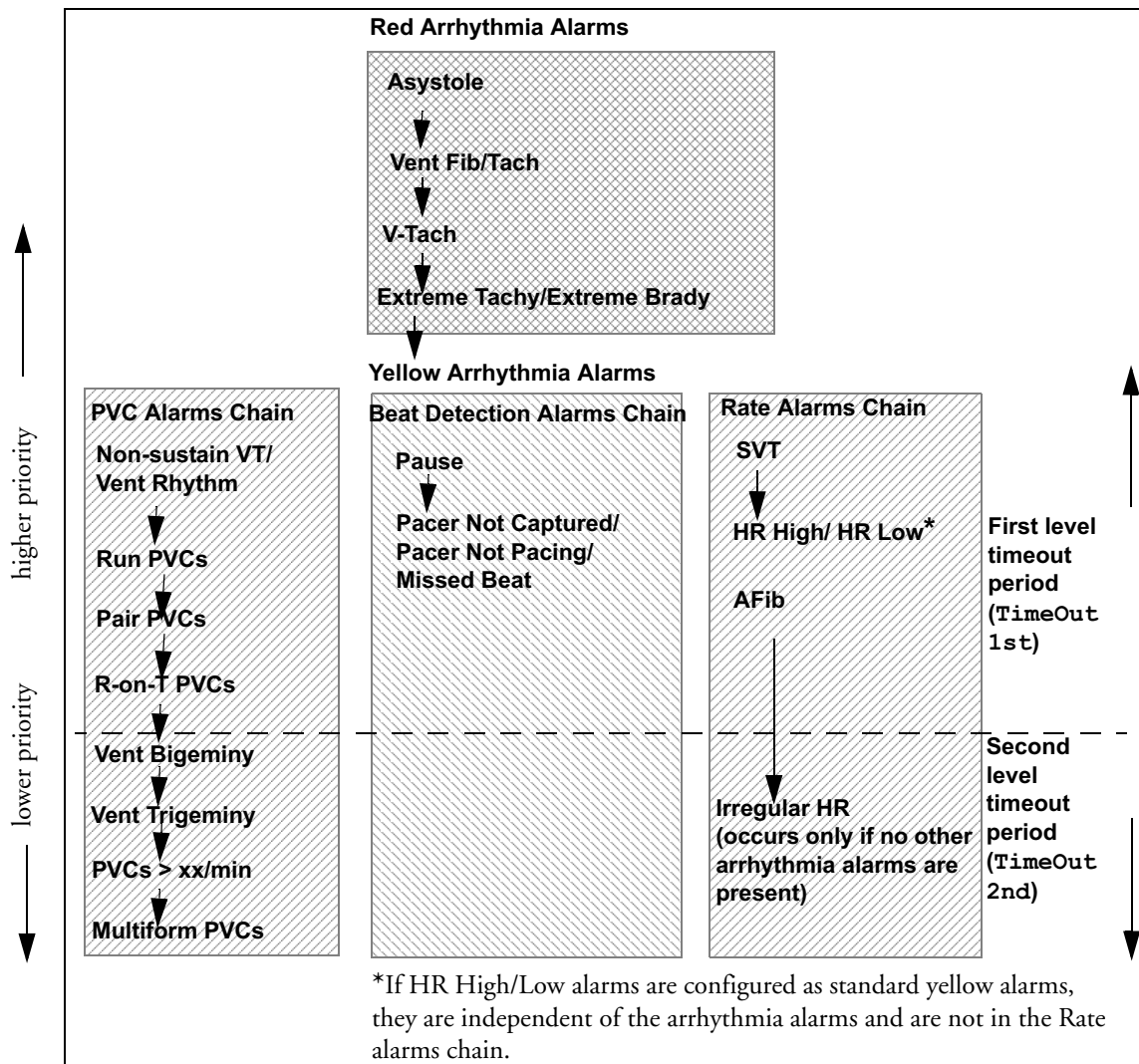

- If there is an active Vent Bigeminy alarm, a PVCs > xx/min will not be triggered because it is lower on the same chain. However, a high HR alarm will become active because it is on a different chain.
- Higher priority alarms supersede previous alarms. For example, if a Vent Trigeminy alarm is active and a Pair PVCs occurs, the Pair alarm will be activated.

Understanding PVC-Related Alarms

PVC-related alarms are detected on the basis of the current ventricular heart rate and the number of consecutive PVCs counted (referred to as PVC Runs).

Example: This diagram illustrates the conditions under which PVC alarms would be generated if the Vent Rhythm Run limit is set to 12, the V-Tach Run Limit is set to eight, and the V-Tach HR Limit is set to 100.

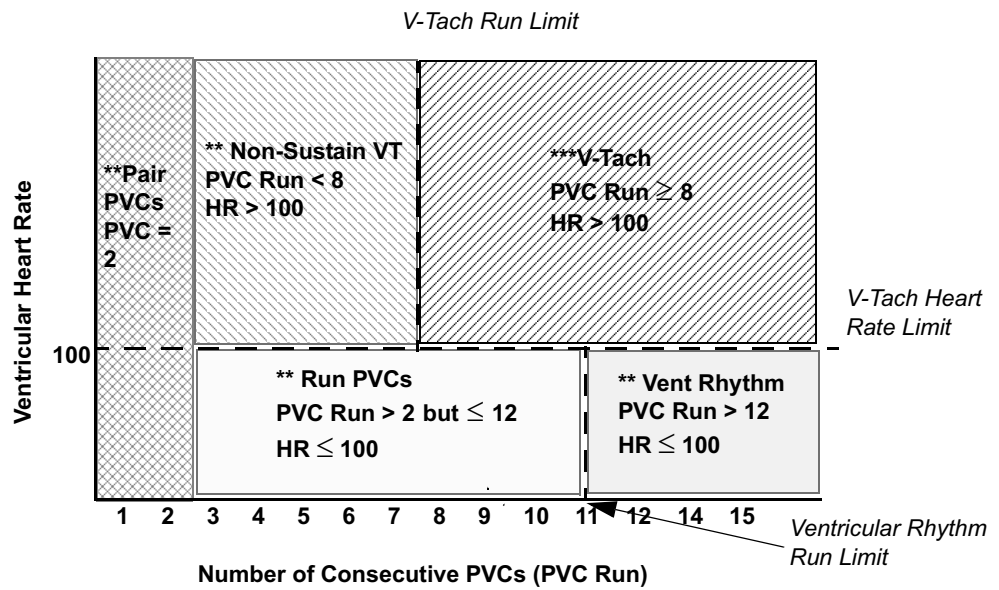

You will see that

- if both the V-Tach Heart Rate Limit and the V-Tach Run Limit are exceeded, a red V-Tach alarm is generated
- if the ventricular heart rate exceeds the V-Tach Heart Rate Limit but not the V-Tach Run Limit, a yellow Non-Sustain VT alarm is generated.

About ST Monitoring

The monitor performs ST segment analysis on normal and atrially paced beats and calculates ST segment elevations and depressions. This information can be displayed in the form of ST numerics and snippets on the monitor.

All available leads can be monitored continuously. The ECG waveform does not need to be displayed on the monitor for ST Segment analysis.

ST analysis is always performed using a dedicated filter which ensures diagnostic quality. If you are monitoring ECG using an ECG filter mode other than Diagnostic, the ST segment of the ECG wave may look different from the ST segment of the ST snippet for the same wave. For diagnostic evaluation of the ST segment, always switch to Diagnostic filter mode or use the ST snippet.

WARNING Some clinical conditions may make it difficult to achieve reliable ST monitoring, for example:

- if you are unable to get a lead that is not noisy
- if arrhythmias such as atrial fib/flutter are present, which may cause an irregular baseline
- if the patient is continuously ventricularly paced
- if the patient has left bundle branch block.

You should consider switching ST monitoring off if these conditions are present.

This monitor provides ST level change information; the clinical significance of the ST level change information should be determined by a physician.

ST segment monitoring is intended for use with adult patients only and is not clinically validated for use with neonatal and pediatric patients. For this reason, the recommended - and default - setting for ST monitoring in neonatal and pediatric modes is **ST Analysis: Off**.

Switching ST On and Off

- ◆ To switch all ST monitoring on or off, in the **Setup ST Analysis** menu, select **ST Analysis** to toggle between **On** and **Off**.

Selecting Leads for ST Analysis

You select which leads to use for ST analysis in the **Setup ST Analysis** menu.

To see the current list of leads selected for ST analysis:

- 1 Enter the **Setup ST Analysis** menu.
- 2 Select **Setup ST Leads**. This opens the **Setup ST Leads** pop-up window. Leads chosen for ST monitoring are listed here. There are two pop-up keys at the bottom of the screen:

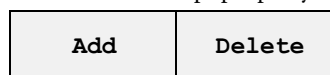

If all leads are already selected, the **Add** pop-up key is disabled.

To choose a lead for ST monitoring:

- 1 Select the **Add** key at the bottom of the **Setup ST Leads** window. This opens the **Choices** pop-up window.

- 2 Choose a lead from the list for ST monitoring. This closes the **Choices** window and adds the selected lead to the list of chosen leads.

To disable ST monitoring for a lead:

- 1 Choose a lead from the list in the **Setup ST Leads** window.
- 2 Select the **Delete** key. This removes this lead from the list.

NOTE The order in which ST leads are listed in the Setup ST Leads menu determines the order in which ST leads are displayed on the monitor screen.

To change the order in which ST leads are displayed,

- 1 In the Setup ST Leads menu, choose a lead from the list.
- 2 Select the Sort Up or Sort Down key to move the lead up or down in the list.

Understanding the ST Display and Windows

Your monitor screen may be configured to look slightly different from the illustrations.

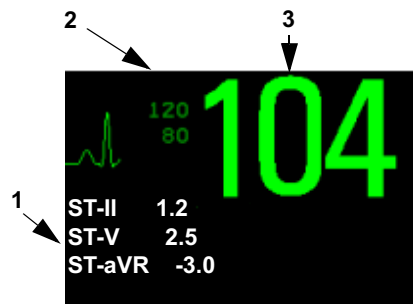

- 1 ST numerics
- 2 Current HR alarm limits
- 3 Current heart rate

ST Numerics Up to 12 ST numerics plus the ST index can be displayed on the monitor screen. They can be configured to show beside the measurement numerics, beside the ECG wave, or beside the ST snippet.

A positive ST value indicates ST segment elevation; a negative value indicates depression.

ST numerics are displayed in the order in which you select ST leads for analysis. If there is additional space in the field assigned to ST numerics, the monitor will display extra numerics in the order in which they appear in the **Setup ST Analysis** -> **Setup ST Leads** list. Any ST leads switched on for analysis that do not fit in the assigned numerics field are shown in succession in place of the last ST numeric.

ST Index The ST index numeric (**STindx**) is the sum of the absolute values for the ST leads V2, V5, aVF. Because it is based on absolute values, it is always a positive number. If you haven't selected one of the leads V2, V5, and aVF for ST analysis, the STindx numeric will display a question mark "?".

- ◆ To switch the ST index numeric on or off for display, in the **Setup ST Analysis** menu, select **ST-Index** to toggle between **On** and **Off**.

ST Snippets ST snippets show a one second wave segment for each measured ST lead. The most recent snippet is drawn in the same color as the ECG wave, usually green, superimposed over the stored baseline snippet, drawn in a different color. The comparison shows any deviation in the measurement since the baseline snippet was stored, for example as a result of a procedure carried out on the patient.

The information is updated once per minute.

You can see ST snippets in the **Adjust ST Points** window or the **ST Baseline** window.

ST Baseline Window The ST Baseline Window shows an ST snippet drawn on a grid. The current ST numeric and the ST numeric stored with the baseline are shown, as well as the difference between these two numerics.

A “?” in front of the difference numeric indicates that the ST measurement points were adjusted since the baseline snippet was stored.

◆ To view the **ST Baseline** window, select the ST numerics, then **ST Baseline**.

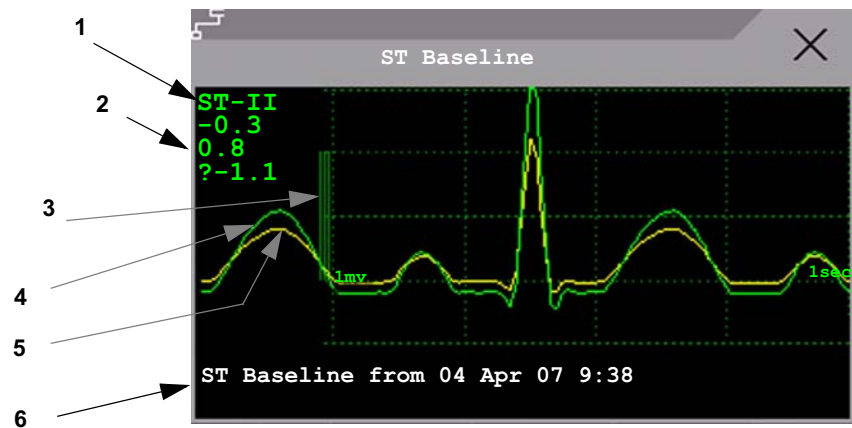

- 1 ST label and numeric
- 2 Baseline ST numeric and difference since baseline was stored
- 3 1mV calibration bar
- 4 Current snippet
- 5 ST baseline
- 6 Timestamp of most recently stored baseline snippet

Updating ST Baseline Snippets

ST analysis requires valid samples to measure and store a snippet. ST Snippets and ST values are updated every minute. If there is artifact in the signal, it may take longer for an ST snippet and an ST value to appear.

The first baseline is stored automatically after ST monitoring is started, or when a new patient is admitted. To update ST baselines,

- 1 Select the ST numerics then **ST Baseline** to open the **ST Baseline** window.
- 2 In the **ST Baseline** window, select **Update Baseline** to store all current snippets as baselines. This deletes all previously-stored baselines.

About the ST Measurement Points

The ST value for each beat complex is the vertical difference between the ISO point and the ST point, as shown in the diagram below. The isoelectric (ISO) point provides the baseline, the ST point is at the midpoint of the ST segment. The J point is where the QRS complex changes its slope; as it is a fixed distance away from the ST point, it can be useful to help you position the ST point correctly.

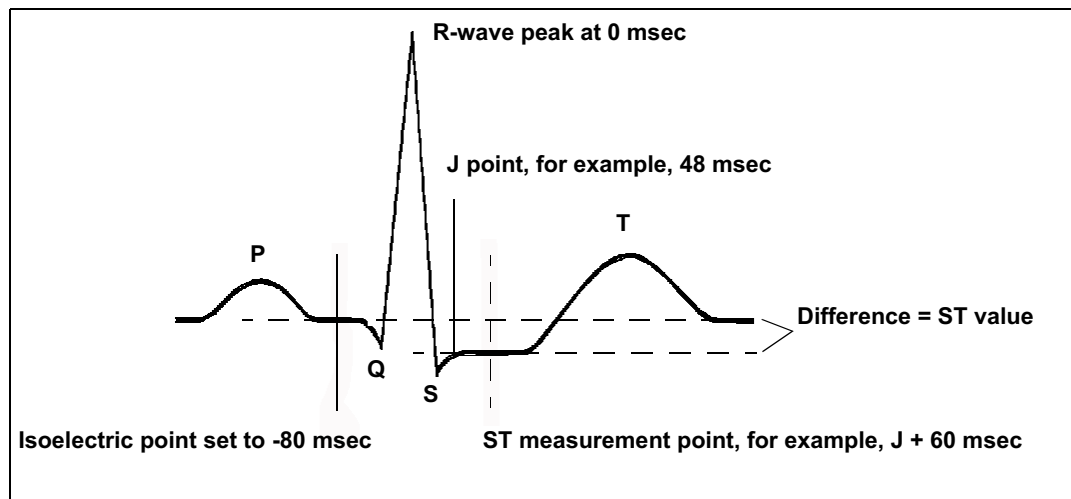

CAUTION The ST measurement points need to be adjusted when you start monitoring, and if the patient's heart rate or ECG morphology changes significantly, as this may affect the size of the QT interval and thus the placement of the ST point. Artifactual ST segment depression or elevation may occur if the isoelectric point or the ST point is incorrectly set.

Always ensure that ST measurement points are appropriate for your patient.

Adjusting ST Measurement Points

Depending on your monitor's configuration, the ST point can be positioned either

- relative to the J-point.
In the **Adjust ST Points** window, the pop-up keys ISO Point, J Point and ST Point are visible and can be adjusted.
- or
- directly by selecting a numeric value for the ST point.
In the **Adjust ST Points** window, you can adjust the ISO and ST point.

The **ST Uses** setting can only be changed in Configuration Mode.

To adjust the ST measurement points,

- 1 In the **Setup ST Analysis** menu, select **Adjust ST Points** to open the **Adjust ST Points** window. Alternatively, you can use the **Adjust ST Points** pop-up key in the **ST Baseline** window.
- 2 Select a suitable ECG lead for ST measurement, with a visible J-point and a visible P wave. Use the up and down arrow keys to scroll through the ST snippets for the other ECG leads.

- 3 Select the ST point you need to adjust by touching the appropriate point on the screen. The current choice is highlighted (ISO point -80 in the screen example).

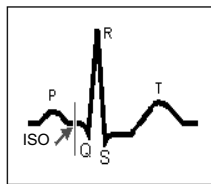
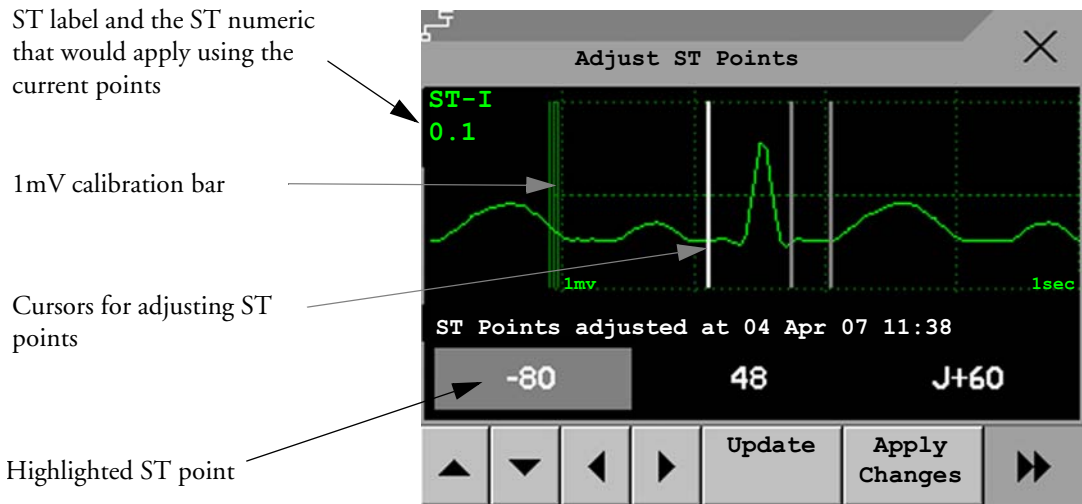

The ISO-point cursor positions the isoelectric point relative to the R-wave peak. The relation is shown beside the ISO-point in milliseconds. Position the ISO-point in the middle of the flattest part of the baseline (between the P and Q waves or in front of the P wave).

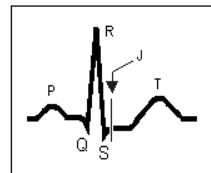

The J-point cursor positions the J-point relative to the R-wave peak. It helps you to correctly position the ST-point. Position the J-point at the end of the QRS complex and the beginning of the ST segment. The J-point cursor is not available if your monitor is configured to let you set the ST point directly.

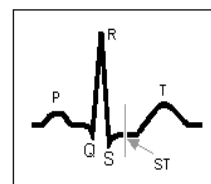

To position the ST-point relative to the J-point: select either **J + 60** or **J + 80**. Select **J Point** and use the arrow keys to move the J-Point and position the ST-point at the midpoint of the ST segment.

To position the ST-point directly: select **ST Point** and use the left and right arrow keys to position the ST point at the midpoint of the ST segment.

- 4 Select the **Apply Changes** pop-up key to activate the new ST measurement points and recalculate all ST values.

The most recent ST Points adjustment time is displayed in the **Adjust ST Points** window. This information is cleared when a patient is discharged or when a new Profile is loaded into the monitor.

- To update the ST snippet shown in the **Adjust ST Points** window, select the **Update** pop-up key.

ST Alarms

ST alarms are yellow alarms. Each ST lead has its own alarm limit. ST alarms are triggered when an ST value exceeds its alarm limit for more than one minute. Switching ST alarms off switches off alarms for all ST leads.

If more than one ST measurement is in alarm, the monitor only displays the alarm message of the ST lead which is currently furthest from its set alarm limits.

Single- or Multi-lead ST Alarming

Be aware that if multi-lead ST alarming is switched on, only alarms involving more than one ST lead will be announced.

To choose individual or multi-lead ST alarming,

- ◆ In the **Setup ST Analysis** menu, select **ST Alarm Mode** and select either **Single ST** or **Multi ST**.

Changing ST Alarm Limits

The monitor can detect alarms on each ST lead separately, so you can set high and low ST alarm limits individually for each ST lead. You can also set separate alarm limits for single-lead and multi-lead ST monitoring. Set the high and low alarm limits based on your assessment of the patient's clinical condition, unit protocols, physician orders or medication specified limits. A good guideline is + 1.0 mm or - 1.0 mm from the patients's ST, or follow your hospital protocol.

- In the **Setup ST Analysis** menu, select **ST Alarm Mode** and select **Single ST** or **Multi ST**.
- Select the alarm to be adjusted.
- Select the appropriate setting.

Viewing ST Maps

The monitor can derive a multi-axis portrait (map) from the ST analysis to help you detect changes in ST values. It displays two planes obtained from a multilead ECG in a multi-axis diagram, where each axis represents a lead. The ST value at the J point is given. The position of the axes within the diagram correspond to the placement of the ECG leads. Each ST value is assigned to either a limb lead, or to a chest lead. Every axis shows the polarity of the lead it represents. By joining adjacent ST values, the monitor obtains the ST map. The contour line, and the map shading, is shown in the same color as the ECG parameter.

Current View

In current view, the monitor displays an ST map that corresponds to the current ST values. Three or more leads per plane are necessary to display a map.

The left of the following diagram shows leads I, II, III, aVR, aVL, and aVF on the limb leads. On the right, the V-leads (V1, V2, V3, V4, V5, and V6) are on the chest leads.

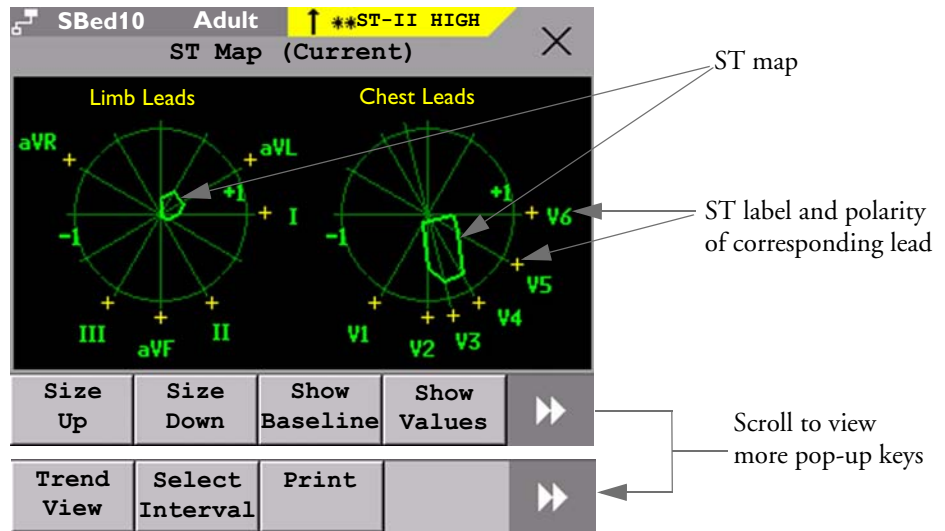

If an ST lead is switched off, its axis is not shown in the map.

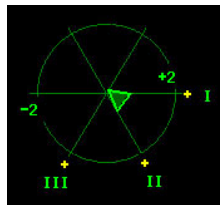

If a lead is in INOP (the value is being measured but is invalid or unavailable because, for example, the corresponding ECG electrode is unplugged), the area formed by the remaining ST leads is left open.

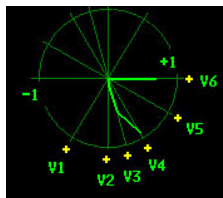

If there is insufficient information (for example, there are less than three chest leads) for a second ST map to be displayed, the currently available ST values are displayed in place of the second ST map.

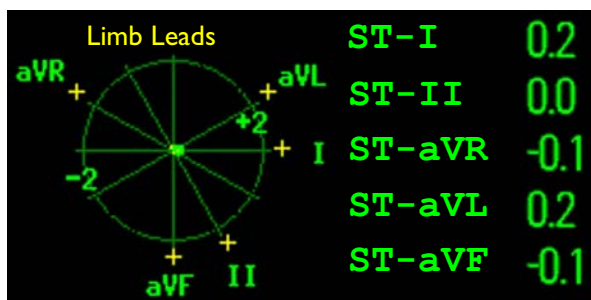

Additionally, when both ST maps are displayed, you can view the currently available ST values in the ST Map window (Current or Trend) at any time. To do this, select the **Show Values** pop-up key. The ST values are shown in place of the second ST map, and the pop-up key text changes to **Hide Values**. Select the **Hide Values** pop-up key and the display shows both ST maps again.

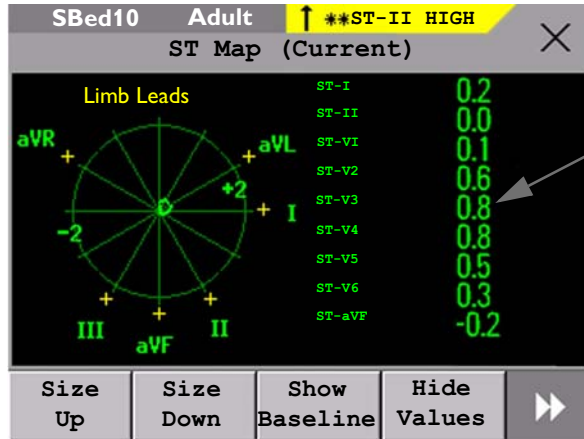

ST values are shown where the STmap for the chest leads is normally displayed.

Select the **Show Values** pop-up key to see the current ST values. Select **Hide Values** and the display shows both ST maps again.

Trend View

In trend view, you can see up to four trended ST maps, and the current ST map, simultaneously. You can configure the time interval between trended samples. The most recent map is shown in the same color as the parameter itself. Past values change from white through dark gray. In the diagram below, the time interval between trends is 12 seconds. The first trended sample is white and is 12 seconds old. The second trended sample corresponds to the ST values 24 seconds ago and so forth. The ST values on the diagrams show the current ST values.

If a lead is turned off, its axis is no longer shown. This has no impact on the presentation of trended values that were recorded while the lead was still on. In the diagram below, lead V4 was switched off 20 seconds ago. The current ST values and the first trended value reflect this change in the lead setup. All other maps are displayed the way in which they were recorded.

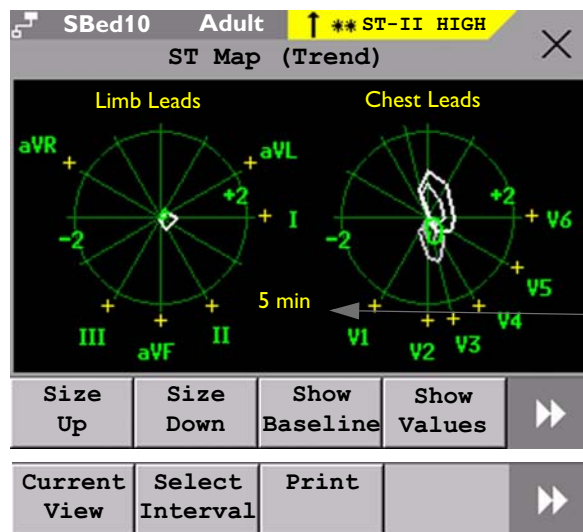

trending interval

Scroll to view more pop-up keys

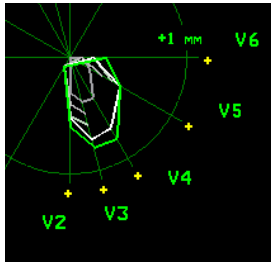

In this diagram, V4 was either temporarily switched off, or in INOP, for around 30 seconds. No data was recorded. Consequently, the affected maps are not closed.

Viewing an ST Map

To display an ST map,

- ◆ In the **Setup ST Analysis** menu, select **ST Map**.

Working in the ST Map Task Window

You may need to activate the ST map task window to see all the data, and to access the pop-up keys. Select the map view on screen to activate its task window. Once you activate it, you can perform the tasks detailed here.

Switching Between ST Map Views

To switch between views,

- ◆ Select **Current View** or **Trend View** to toggle between views.

If your trend view is empty, you need to adjust the priority of this measurement in the trending priority list. See “Trend Priority” on page 191.

Displaying an ST Reference Baseline

You can display an ST reference baseline for the current view, or for the trended view. The baseline is shown in yellow. However, if the ECG color is yellow, the baseline is shown in green. Use this baseline to detect ST changes. The baseline is derived automatically whenever the monitor relearns arrhythmia and also on user request.

- ◆ Select **Show Baseline/Hide Baseline** to toggle between baseline display on and off.

Updating an ST Map Reference Baseline

To update the baseline,

- ◆ In the **Setup ST Analysis** menu, select **ST Baseline -> Update baseline**.

Changing the Scale of the ST Map

To change scale,

- ◆ Select **Size Up** or **Size Down** to alter the size at which monitor displays the map.

Changing the Trending Interval

To determine how frequently the monitor displays a trended sample,

- 1 In Trend view, select **Select Interval**.
- 2 Select the required interval from the menu. The interval ranges between 12 seconds to 30 minutes.

Printing an ST Map Report

To print the most recently viewed (current or trend) window,

- 1 Select **Main Setup -> Reports**.
- 2 Select **ST Map**.
- 3 Press **Print**.

About QT/QTc Interval Monitoring

The QT interval is defined as the time between the beginning of the Q-wave and the end of the T-wave. It measures the total duration of the depolarization (QRS duration) and repolarization (ST-T) phases of the ventricular action potential. QT interval monitoring can assist in the detection of prolonged QT interval syndrome.

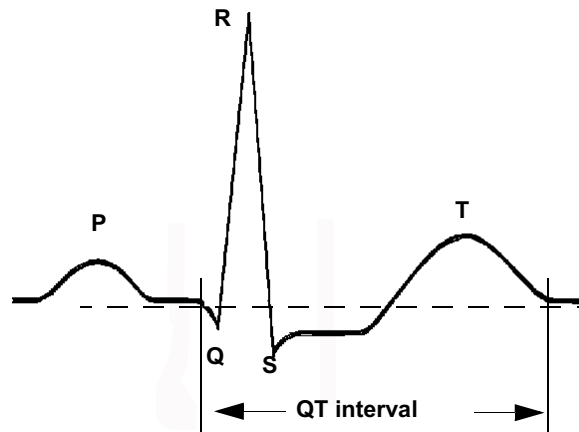

The QT interval has an inverse relationship to heart rate. Faster heart rates shorten the QT interval and slower heart rates prolong the QT interval. Therefore there are several formulas used to correct the QT interval for heart rate. The heart rate corrected QT interval is abbreviated as QTc. The monitor uses as a default the Bazett correction formula and the alternative Fridericia formula can be selected in Configuration Mode.

For QT interval monitoring to be effective, basic or enhanced arrhythmia monitoring should be turned on.

QT Measurement Algorithm

The QT values are updated every five minutes except in the initial phase (first five minutes) where they are updated once per minute. Normal or atrial paced beats and beats with a similar morphology are averaged to form a representative waveform for further processing. Normal beats followed by a premature QRS will be excluded from the measurements to prevent the premature beat from obscuring the end of the T-wave. If the algorithm cannot form a representative waveform, for example because the morphology of the beats is too varied, a **CANNOT ANALYZE QT** INOP will be generated after 10 minutes. This is also the case if normal beats have been falsely labelled so that the algorithm does not have enough valid beats to make QT measurements. No QT value is calculated if the QT-HR is >150 bpm (Adult) or >180 bpm (Pedi/Neo).

Because of the different algorithm approaches, a QT/QTc measurement from a diagnostic 12-lead program may differ from the realtime measurement on the monitor.

Where Can I Find More Information?

See the Application Note on QT/QTc Interval Monitoring and the QT Interval Monitoring Quick Guide supplied on your documentation DVD for detailed information on the QT algorithm and performance.

Indications For Use Of QT Interval Monitoring

Of special concern for QT monitoring is the administration of QT prolonging drugs to patients identified with risk factors for Torsade de Pointe. Females, older patients and patients with bradycardia, impaired left ventricular function (ischemia, left ventricular hypertrophy), hypokalemia and hypomagnesemia are in this increased risk category.

Limitations For Use Of QT Interval Monitoring

Some conditions may make it difficult to achieve reliable QT monitoring, for example:

- the T-wave is very flat
- T-waves are not well defined due to atrial flutter or atrial fibrillation
- the end of the T-wave is difficult to define because of the presence of U-waves
- a high heart rate causes the P-wave to encroach on the end of the previous T-wave
- noise or high QRS morphology variation

For these cases you should select a lead with a good T-wave amplitude and no visible flutter activity, and without a predominant U-wave or P-wave.

Some conditions such as left or right bundle branch block or hypertrophy can lead to a widened QRS complex. If a long QTc is observed you should verify it to ensure that it is not caused by QRS widening.

Because normal beats followed by ventricular beats are not included in the analysis, no QT measurement will be generated in the presence of a bigeminy rhythm.

If the heart rate is extremely high (over 150 bpm for adults and over 180 bpm for pediatrics and neonates) QT will not be measured.

When the heart rate changes, it can take several minutes for the QT interval to stabilize. For reliable QTc calculation it is important to avoid a region where the heart rate is changing.

WARNING QT/QTc measurements should always be verified by a qualified clinician.

Selecting The QT Leads

For QT Monitoring you can select one of the following three modes:

- All Leads mode - all available leads (I, II, III, V, MCL, V1 - V6) are used to produce a global QT measurement. For EASI lead placement, directly acquired AI, AS and ES leads are used.
- Primary-Lead mode - the primary lead will be used for QT measurement. If the original primary lead becomes unavailable or is changed, QT measurement will continue with the new primary lead.
- Single-Lead mode - a single lead selected from all available leads (except the augmented leads) will be used for QT measurement. QT measurement will stop if the selected lead becomes unavailable.

To select the mode,

- 1 Select the QT numeric to enter the **Setup QT Analysis** window.
- 2 Select QT Lead and select **All, Primary Lead** or one of the available single leads.

When using the All Leads mode, make sure when you compare QT values that they are based on the same set of leads.

Changing the lead(s) used for QT measurements will not cause the baseline to be reset.

QT View

In the **QT View** window you can verify that the QT algorithm detects correct Q and T points.

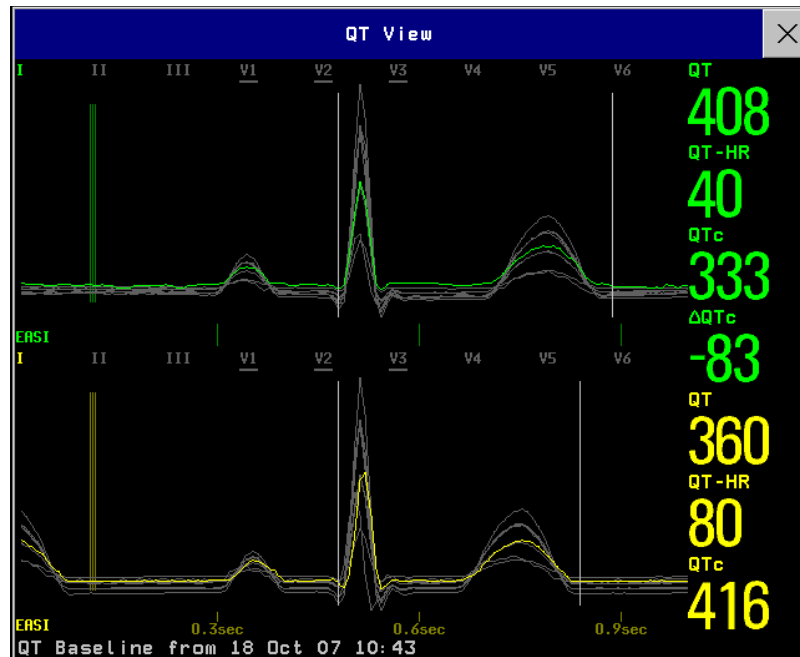

The current waves are shown in the upper half of the window and the baseline waves in a different color below. The Q and T points are marked with a vertical line. By selecting one of the lead labels at the top of the window you can highlight the corresponding wave; the other waves are shown in gray. The underlined lead labels are the leads used for the QT calculation. By selecting the numeric area you can highlight all underlined leads.

Changing The View To A Single Wave Set

To view one set of waves in a larger scale, you can cycle through the different views,

- 1 Select **Current** view to see the set of current waves.
- 2 Select **Baseline** view to see the set of baseline waves.
- 3 Select **Split** view to return to the combined view with current and baseline waves.

Setting The QT Baseline

In order to quantify changes in the QTc value, you can set a QTc baseline. For example to assess the effect of medication on the QT interval you can set the current value as the baseline before you begin medication. This baseline will then be used to calculate the Δ QTc value.

To set the baseline,

- ◆ Select **Set Baseline** and set the value.

If no baseline has been set for this patient, the first five minute value after the start of monitoring is automatically set as baseline. If you set a new baseline the previous baseline is discarded. As the Δ QTc alarm is based on the difference between the baseline and the current value, setting an inappropriate new baseline may prevent a Δ QTc alarm from being generated. Discharging a patient clears the baseline.

Printing The QT Waves

To start a printout,

- ◆ Select **Print QT**.

Recording The QT Waves

To start a recording,

- ◆ Select **Record QT**.

QT Alarms

There are two QT alarms, QTc high limit alarm and Δ QTc high alarm. The QTc high limit alarm is generated when the QTc value exceeds the set limit for more than 5 minutes. The Δ QTc alarm is generated when the difference between the current value and the baseline value exceeds the set limit for more than 5 minutes.

The **CANNOT ANALYZE QT** INOP and the ?_ will be displayed when no QT measurement could be calculated for 10 minutes. Up to this time the previous valid value will be displayed. The following additional messages on the cause of the invalid measurements may also be displayed.

Additional Message	Cause of Invalid QT Measurement
QT Startup	QT monitoring was just turned on or has been reset
Asystole or Leads Off	1 Not all specified leads needed to perform QT analysis are available, or 2 Asystole condition is detected
Insufficient Valid Leads	Not enough valid QRS complexes to generate a QT measurement
Invalid rhythm for QTc	Not enough valid RR intervals to generate QT-HR, the averaged HR used for QTc calculation
High QT-HR	QT-HR exceeds the specified upper limit of 150 bpm (for adults) or 180 bpm (for neonates and pediatrics)
Small R Wave	R-wave of the signal is too small
Small T Wave	T-wave of the signal is too small
End of T Not detected	End of the T-Wave cannot be accurately detected
QT Out Of Range	QT measurement is outside the specified range of valid QT values (200-800 msec)
QTc Out Of Range	QTc measurement is outside the specified range of valid QTc values (200-800 msec)
QTc Erratic	QTc measurements are not stable

Switching Individual QTc Alarms On and Off

Each QTc alarm can be switched off individually.

- ◆ To switch an alarm on or off, in the **Setup QT Analysis** menu, select **QTc Alarm** or **ΔQTc Alarm** to toggle between **On** and **Off**.

Changing QTc Alarm Limits

Set the high alarm limits based on your assessment of the patient's clinical condition, unit protocols, physician orders or medication specified limits.

- 1 In the **Setup QT Analysis** menu, select **High Limit**.
- 2 Select the appropriate setting.
- 3 Select **ΔHigh Limit**.
- 4 Select the appropriate setting.

Switching QT Monitoring On and Off

- ◆ To switch all QT monitoring on or off, in the **Setup QT Analysis** menu, select **QT Analys.** to switch between **On** and **Off**.

Monitoring Pulse Rate

The pulse numeric counts the arterial pulsations that result from the mechanical activity of the heart in beats per minute (bpm). You can display a pulse from any measured SpO₂ signal (pleth wave), or any arterial pressure (P, ABP, ART, Ao, PAP, UAP, FAP, BAP: see the pressure section for an explanation of the pressure labels). The displayed pulse numeric is labeled and color-coded to match its source wave. If the pulse numeric is not displayed, see the **Setup Pulse** menu to check whether it is switched on.

Entering the Setup Pulse Menu

If a pulse numeric is displayed on the screen, select it to enter the **Setup Pulse (Pulse Source)** menu. If no pulse numeric is visible, in the **Setup SpO₂** menu or a **Setup** arterial pressure menu, select **Pulse (Pulse Source)**.

System Pulse Source

The currently selected system pulse source is shown in the setup menus of the pulse source measurements. The pulse rate chosen as system pulse:

- is monitored as system pulse and generates alarms when you select pulse as the active alarm source
- is sent via the network to the Information Center, if available
- is trended in the HighRes Trends and stored in the monitor's databases.

To define which pulse rate is used as system pulse,

- 1 In the **Setup Pulse** menu, select **System Pulse**.
- 2 Select one of the SpO₂ or arterial pressure labels from the pop-up list, or select **Auto**.
If you select **Auto**, the monitor automatically chooses a pulse rate to be used as system pulse. It looks through the list from top to bottom and activates the first pulse rate that is switched on and available.

If your selected pulse source measurement becomes unavailable or is switched off, the monitor will use the next measurement from the list as system pulse until the selected pulse source measurement becomes available again.

Switching Pulse On and Off

To switch a particular pulse numeric on or off, enter the **Setup Pulse** menu via the measurement setup menu or wave menu of the pulse source. For example, to switch an SpO₂ pulse numeric on or off,

- 1 Enter the **Setup Pulse** menu by selecting the Pulse numeric or by selecting **Pulse** in the **Setup SpO₂** menu.
- 2 In the **Setup Pulse** menu, select **Pulse (Pulse Source)** to toggle between **On** and **Off**.

Using Pulse Alarms

You can change pulse rate alarm limits in the **ECG/Pulse Alarms** menu which can be accessed from the **Setup Pulse** menu or the **Setup ECG** menu by selecting **AlarmSrc (xxx)** where xxx is the current alarm source. Changing the alarm limits for a specific Pulse numeric changes the alarm limits for all pulse rate alarms and heart rate alarms.

Pulse alarms are only generated when the active alarm source is set to Pulse, a pulse source is set as system pulse and pulse alarms are switched on.

Selecting the Active Alarm Source: ECG or Pulse?

In most cases the HR and Pulse numerics are identical. In order to avoid simultaneous alarms on HR and Pulse, the monitor uses either ECG or Pulse as its active alarm source. To change the alarm source, select **AlarmSrc** in the **ECG/Pulse Alarms** menu, then select

- **ECG**: if you want the HR to be the alarm source for HR/Pulse.
- **Pulse**: If you select Pulse as the active alarm source, the monitor will prompt you to confirm your choice. Be aware that if you select Pulse as the alarm source, all arrhythmia and ECG HR alarms are switched off.
- **Auto**: If the **AlarmSrc** is set to **Auto**, the monitor will use the heart rate from the ECG measurement as the alarm source whenever the ECG measurement is switched on and at least one ECG lead can be measured without an INOP condition.

The monitor will automatically switch to Pulse as the alarm source if:

- a valid ECG lead can no longer be measured
- and
- a Pulse source is switched on and available,

The monitor then uses the pulse rate from the measurement currently active as system pulse. While Pulse is the alarm source, all arrhythmia and ECG HR alarms are switched off. If an ECG lead becomes available again, the monitor automatically uses HR as alarm source.

Note: If ECG is switched off, the monitor will always change to Pulse as alarm source, if a Pulse is available. One exception to this rule can arise when you have a telemetry device paired with your monitor. The monitor ECG is then deactivated but the monitor may be configured to allow only ECG as the active alarm source. In this case the monitor will not switch to Pulse as alarm source and Pulse will not be available as a selection in the **ECG/Pulse Alarms** menu.

WARNING Selecting Pulse as the active alarm source for HR/Pulse switches off the arrhythmia alarms listed in the section “ECG and Arrhythmia Alarm Overview” on page 102, including **Asystole**, **Vfib** and **Vtach** alarms, and the heart rate alarms. This is indicated by the message **ECG/ARRH ALARM OFF** (unless this has been configured off for your monitor), and the crossed-out alarm symbol beside the ECG heart rate numeric. The message **ECG/ARRH ALARM OFF** can be configured off, or to switch to a yellow (medium severity) INOP after a fixed number of hours.

High and low pulse rate and extreme bradycardia and extreme tachycardia alarms from pulse are active.

Alarm Source Selection Disabled

If Alarm Source Selection is disabled, you cannot change the alarm source. If you try to change the source, the monitor displays the message **To activate enter Config and enable Alarm Source Selection**. This setting can only be changed in Configuration Mode.

Changing HR/Pulse Alarm Limits

As Pulse and HR share the same high and low alarm limits, if you change the alarm limit in the **Setup Pulse** menu, the high or low alarm limits for HR in the **Setup ECG** menu change automatically, and vice versa. The only exceptions are caused by a low limit clamp for each measurement: the lowest value for Pulse when derived from SpO₂ is 30 bpm; for HR 15 bpm, and for Pressure 25 bpm.

Extreme Alarm Limits

The extreme rate alarms, Extreme Tachy and Extreme Brady, generated by the active alarm source, either HR or Pulse, are set in Configuration Mode by adding a set value to the high and low alarm limits. You need to know what value has been configured for your monitor. Changing the high and low alarm limits automatically changes the extreme alarm limits within the allowed range.

- ◆ To see the values added to the high and low limit alarms to create the extreme rate alarms for your monitor, in the **Setup ECG** menu, see the menu items **Extr. Tachy** and **Extr. Brady**.

QRS Tone

The active alarm source is also used as a source for the QRS tone. You can change the tone volume in the **Setup SpO₂** and **Setup ECG** menus and the QRS tone modulation in the **Setup SpO₂** menu.

WARNING The audible QRS tone might be influenced by external interference and is not intended to be used as a substitute for ECG based arrhythmia analysis.

If arrhythmia detection is needed, do not rely on the audible QRS tone.

Monitoring Respiration Rate (Resp)

For the respiratory measurement (Resp), the monitor measures the thoracic impedance between two ECG electrodes on the patient's chest. Changes in the impedance due to thoracic movement produce the Resp waveform on the monitor screen. The monitor counts the waveform cycles to calculate the respiration rate (RR).

Lead Placement for Monitoring Resp

Correct patient skin preparation techniques for electrode placement are important for Resp measurement: you will find this information in the chapter on ECG.

The Resp measurement uses the standard ECG cable sets and lead placements. You can use any of the different types of ECG cable sets - 3-lead, 5-lead, 6-lead or 10-lead, using either standard or EASI™ placement - to measure Resp, as long as you use ICU ECG cables.

The Resp signal is always measured between two of the ECG electrodes. If you are using standard ECG electrode placement, Resp is measured between the RA and LL electrodes. If you are using EASI™ ECG electrode placement, Resp is measured between the I and A electrodes.

Optimizing Lead Placement for Resp

If you want to measure Resp and you are already measuring ECG, you may need to optimize placement of the two electrodes between which Resp will be measured for some patients. Repositioning ECG electrodes from standard positions, especially when you are using EASI™ ECG electrode placement, results in changes in the ECG waveform and may influence ST and arrhythmia interpretation.

Cardiac Overlay

Cardiac activity that affects the Resp waveform is called cardiac overlay. It happens when the Resp electrodes pick up impedance changes caused by the rhythmic blood flow. Correct electrode placement can help to reduce cardiac overlay: avoid the liver area and the ventricles of the heart in the line between the respiratory electrodes. This is particularly important for neonates.

Lateral Chest Expansion



Some patients, especially neonates, expand their chests laterally. In these cases it is best to place the two respiratory electrodes in the right midaxillary and left lateral chest areas at the patient's maximum point of breathing movement to optimize the respiratory wave.

Abdominal Breathing

Some patients with restricted chest movement breathe mainly abdominally. In these cases, you may need to place the left leg electrode on the left abdomen at the point of maximum abdominal expansion to optimize the respiratory wave.

Understanding the Resp Display

The Resp measurement is displayed on the monitor as a continuous wave and a numeric respiration rate. If the detected respiration rate is close to the heart rate, this is indicated by the text **HR = RR** next to the respiration wave if you are in manual monitoring mode. Your monitor screen may look slightly different from the illustration.

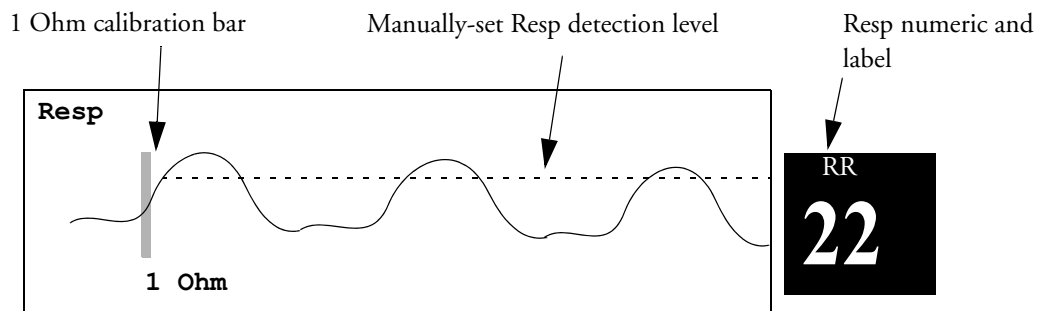

Changing Resp Detection Modes

The Resp detection level can be set either automatically or manually.

- ◆ To change the resp detection mode, in the **Setup Resp** menu, select **Detection** to toggle between the settings.

Auto Detection Mode

In Auto Detection Mode, the monitor adjusts the detection level automatically, depending on the wave height and the presence of cardiac artifact. Note that in Auto Detection Mode,

- the detection level (a dotted line) is not displayed on the waveform,

- the algorithm expects a heart rate and therefore needs at least 3 electrodes attached to the patient. If you are monitoring respiration with only two electrodes, the detection algorithm becomes less sensitive which may result in reduced breath detection performance.

Use Auto Detection Mode for situations where:

- the respiration rate is not close to the heart rate
- breathing is spontaneous, with or without continuous positive airway pressure (CPAP)
- patients are ventilated, except patients with Intermittent Mandatory Ventilation (IMV).

Manual Detection Mode

In Manual Detection Mode you must set the Resp detection level.

- ◆ In the **Setup Resp** menu, select **Manual Up** or **Manual Down**. Use the dotted detection level line in the Resp waveform to determine when the desired level is reached.

Once set, the detection level will not adapt automatically to different respiration depths. It is important to remember that if the depth of breathing changes, you may need to change the detection level.

Use Manual Detection Mode for situations where:

- the respiration rate and the heart rate are close.
- patients have Intermittent Mandatory Ventilation.
- respiration is weak. Try repositioning the electrodes to improve the signal.

Resp Detection Modes and Cardiac Overlay

In Auto Detection Mode: If you are monitoring Resp and the ECG is switched off, the monitor cannot compare the ECG and Resp rates to detect cardiac overlay. The respiration detection level is automatically set higher to prevent the detection of cardiac overlay as respiration.

In Manual Detection Mode: Cardiac overlay can in certain situations trigger the respiration counter. This may lead to a false indication of a high respiration rate or an undetected apnea condition. If you suspect that cardiac overlay is being registered as breathing activity, raise the detection level above the zone of cardiac overlay. If the Resp wave is so small that raising the detection level is not possible, you may need to optimize the electrode placement as described in the section "Lateral Chest Expansion".

Changing the Size of the Respiration Wave

WARNING When monitoring in Manual Detection Mode, make sure to check the respiration detection level after you have increased or decreased the size of the respiration wave.

- ◆ In the **Setup Resp** menu, select **Size Up** to increase the size of the wave or **Size Down** to decrease it.

Changing the Speed of the Respiration Wave

Resp waveforms are usually viewed at a slower speed than other waveforms. For this reason, the Resp measurement has its own speed control and is not affected by the wave speed settings of the other measurements.

- ◆ Select the Resp wave to enter the **Resp Wave** menu, then select **Change Speed**. Choose the required speed from the pop-up list. This defines the speed at which the wave is drawn across the screen in millimeters per second (mm/s).

Using Resp Alarms

Resp alarms can be switched on and off and the high and low alarm limits can be changed just like other measurement alarms, as described in the Alarms chapter.

Changing the Apnea Alarm Delay

The apnea alarm is a high priority red alarm used to detect apneas. The apnea alarm delay time defines the time period between the point where the monitor cannot detect any respiration activity and the indication of the apnea alarm.

- 1 In the **Setup Resp** menu, select **Apnea Time**.
- 2 Select the appropriate setting.

Resp Safety Information

WARNING **Respiration detection level** If you do not set the detection level for the respiration correctly in manual detection mode, it may not be possible for the monitor to detect apnea. If you set the detection level too low, the monitor is more likely to detect cardiac activity, and to falsely interpret cardiac activity as respiratory activity in the case of apnea.

Apnea The respiration measurement does not recognize obstructive and mixed apneas — it only indicates an alarm when a pre-adjusted time has elapsed since the last detected breath.

The safety and effectiveness of the respiration measurement method in the detection of apnea, particularly the apnea of prematurity and apnea of infancy, has not been established.

Interference If operating under conditions according to the EMC Standard EN 60601-1-2 (Radiated Immunity 3V/m), field strengths above 1V/m may cause erroneous measurements at various frequencies. Therefore it is recommended to avoid the use of electrically radiating equipment in close proximity to the respiration measurement unit.

Resp Accessories To monitor respiration, use only the non-OR ECG accessories listed in the Resp section of the accessories chapter. You cannot measure respiration if you are using an orange OR ECG cable set. This is because of the higher internal impedance of the OR cable set, required for use if electro-surgery is being performed.

Rate adaptive pacemakers: Implanted pacemakers which can adapt to the Minute Ventilation rate may occasionally react on the Impedance measurement used by patient monitors for the determination of the Resp value and execute pacing with the maximum programmed rate. Switching off the Resp measurement can prevent this.

Monitoring SpO₂

Philips pulse oximetry uses a motion-tolerant signal processing algorithm, based on Fourier artefact suppression technology (FAST). It provides four measurements:

- Oxygen saturation of arterial blood (SpO₂) - percentage of oxygenated hemoglobin in relation to the sum of oxyhemoglobin and deoxyhemoglobin (functional arterial oxygen saturation).
- Pleth waveform - visual indication of patient's pulse.
- Pulse rate (derived from pleth wave) - detected pulsations per minute.
- Perfusion indicator - numerical value for the pulsatile portion of the measured signal caused by arterial pulsation.

The monitors are also compatible with SpO₂ technologies from other manufacturers. Please refer to the instructions for use provided with these devices for further information.

SpO₂ Sensors

Familiarize yourself with the instructions for use supplied with your sensor before using it. In particular, check that the sensor being used is appropriate for your patient category and application site.

CAUTION Do not use OxiCliq disposable sensors in a high humidity environment, such as in neonatal incubators or in the presence of fluids, which may contaminate sensor and electrical connections causing unreliable or intermittent measurements. Do not use disposable sensors on patients who have allergic reactions to the adhesive.

Applying the Sensor

- 1 Follow the SpO₂ sensor's instructions for use, adhering to all warnings and cautions.
- 2 Remove colored nail polish from the application site.
- 3 Apply the sensor to the patient. The application site should match the sensor size so that the sensor can neither fall off, nor apply excessive pressure. When using the M1195A Infant Finger Sensor, select a finger or toe with a diameter of between 7 and 8 mm (0.27" and 0.31"). When applying a M1193A neonatal sensor do not overtighten the strap.

- 4 Check that the light emitter and the photodetector are directly opposite each other. All light from the emitter must pass through the patient's tissue.

WARNING **Loose Sensor:** If a sensor is too loose, it might compromise the optical alignment or fall off. If it is too tight, for example because the application site is too large or becomes too large due to edema, excessive pressure may be applied. This can result in venous congestion distal from the application site, leading to interstitial edema, hypoxemia and tissue malnutrition. Skin irritations or lacerations may occur as a result of the sensor being attached to one location for too long. To avoid skin irritations and lacerations, periodically inspect the sensor application site and change the application site at least every four hours.

Venous Pulsation: Do not apply sensor too tightly as this results in venous pulsation which may severely obstruct circulation and lead to inaccurate measurements.

Ambient Temperature: At elevated ambient temperatures be careful with measurement sites that are not well perfused, because this can cause severe burns after prolonged application. All listed sensors operate without risk of exceeding 41°C on the skin if the initial skin temperature does not exceed 35°C.

Extremities to Avoid: Avoid placing the sensor on extremities with an arterial catheter, or intravascular venous infusion line.

Connecting SpO₂ Cables

- ◆ Connect the sensor cable to the color-coded socket on the monitor. You can connect some Philips sensors directly to the monitor. For other sensors, use the corresponding adapter cable.

CAUTION **Extension cables:** Do not use more than one extension cable (M1941A). Do not use an extension cable with Philips reusable sensors or adapter cables with part numbers ending in -L (indicates "long" cable version).

Electrical Interference: Position the sensor cable and connector away from power cables, to avoid electrical interference.

Humidity: For neonatal patients, make sure that all sensor connectors and adapter cable connectors are outside the incubator. The humid atmosphere inside can cause inaccurate measurements.

Measuring SpO₂

- 1 Select the correct patient category setting (adult/pediatric and neonatal), as this is used to optimize the calculation of the SpO₂ and pulse numerics.
- 2 During measurement, ensure that the application site:
 - has a pulsatile flow, ideally with a perfusion indicator value above 1.0.
 - has not changed in its thickness (for example, due to edema), causing an improper fit of the sensor.

WARNING Inspect the application site every two to three hours to ensure skin quality and correct optical alignment. If the skin quality changes, move the sensor to another site. Change the application site at least every four hours.

- CAUTION**
- Injected dyes such as methylene blue, or intravascular dyshemoglobins such as methemoglobin and carboxyhemoglobin may lead to inaccurate measurements.
 - Interference can be caused by:
 - High levels of ambient light or strobe lights or flashing lights (such as fire alarm lamps). (Hint: cover application site with opaque material.)
 - Electromagnetic interference.
 - Excessive patient movement and vibration.

SpO₂ Signal Quality Indicator (Fast SpO₂ only)

The SpO₂ numeric is displayed together with a signal quality indicator (if configured and enough space is available) which gives an indication of the reliability of the current values.

The level to which the triangle is filled shows the quality of the signal; the indicator below shows a medium signal quality, the signal quality is at a maximum when the triangle is completely filled.



Assessing a Suspicious SpO₂ Reading

Traditionally, pulse rate from SpO₂ was compared with heart rate from ECG to confirm the validity of the SpO₂ reading. With newer algorithms, such as FAST-SpO₂, this is no longer a valid criteria because the correct calculation of SpO₂ is not directly linked to the correct detection of each pulse.

When pulse rate is very low, or strong arrhythmia is present, the SpO₂/Pleth pulse rate may differ from the heart rate calculated from ECG but this does not indicate an inaccurate SpO₂ value.

If you doubt the measured SpO₂, use the signal quality indicator (if available) or the pleth wave and perfusion indicator instead to assess the signal quality.

NOTE With pulse oximetry, sensor movement, ambient light (especially strobe lights or flashing lights) or electromagnetic interference can give unexpected intermittent readings when the sensor is not attached to a patient. Especially bandage-type sensor designs are sensitive to minimal sensor movement that might occur when the sensor is dangling.

Changing the Averaging Time

Depending on the monitor configuration, you may be able to change the averaging time for the SpO₂ values. The averaging time represents the approximate time period used for the calculation. The exact averaging algorithm depends on the SpO₂ technology (option) used and on the signal conditions. The longer the averaging time, the longer the time needed until the SpO₂ value reflects the physiological event. Fast averaging is useful for situations where an extremely fast measurement is required or few artifacts are expected. Use slow averaging where you expect the number of artifacts to be relatively high.

- 1 In the **SpO₂ Setup**, select **Average**.
- 2 Select the required averaging time from the list.

Setting the Measurement Mode

When a telemetry device supplies SpO₂T to the monitor via short range radio transmission, the monitor will have a manual measurement mode available. This allows SpO₂ measurements to be made on request and not continuously, helping to save the telemetry device's battery power.

To set the measurement mode,

- 1 In the **SpO₂ Setup**, select **Mode**.
- 2 Select **Continuous** or **Manual** mode.

Making a Manual Measurement

When the measurement mode is set to manual,

- ◆ In the **SpO₂ Setup**, select **Measure SpO₂**.

When manual measurements are made, there will be no continuous SpO₂ monitoring or alarming. The manual measurement value reflects a momentary status. The numerics from SpO₂T measurements made in manual mode, for example SpO₂T, PerfT, PulseT, will remain for a time on the main screen. They are annotated with the time that the measurement was made to distinguish them from continuously measured values.

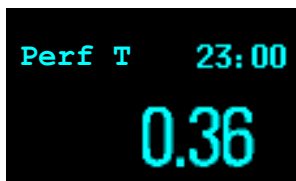

Understanding SpO₂ Alarms

This refers to SpO₂ specific alarms. See the Alarms section for general alarm information. SpO₂ offers high and low limit alarms, and a high priority desat alarm. You cannot set the low alarm limit below the desat alarm limit.

CAUTION If you measure SpO₂ on a limb that has an inflated NBP cuff, a non-pulsatile SpO₂ INOP can occur. If the monitor is configured to suppress this alarm there may be a delay of up to 60 seconds in indicating critical patient status, such as sudden pulse loss or hypoxia.

Alarm Delays

There is a delay between a physiological event at the measurement site and the corresponding alarm at the monitor. This delay has two components:

- The time between the occurrence of the physiological event and when this event is represented by the displayed numerical values. This delay depends on the algorithmic processing and the configured averaging time. The longer the averaging time configured, the longer the time needed until the numerical values reflect the physiological event.
- The time between the displayed numerical values crossing an alarm limit and the alarm indication on the monitor. This delay is the combination of the configured alarm delay time plus the general system delay time (see “Monitor Performance Specifications” on page 251).

Adjusting the Alarm Limits

In the **Setup SpO₂** menu:

- Touch the high limit on the alarm limits menu button. Choose the high alarm limit from the pop-up list that opens.
- Touch the low limit on the alarm limits menu button. Choose the low alarm limit from the pop-up list that opens.

WARNING High oxygen levels may predispose a premature infant to retrolental fibroplasia. If this is a consideration do NOT set the high alarm limit to 100%, which is equivalent to switching the alarm off.

Adjusting the Desat Limit Alarm

The Desat alarm is a high priority (red) alarm notifying you of potentially life threatening drops in oxygen saturation.

- 1 In the **Setup SpO₂** menu, select **DesatLimit**.
- 2 Adjust the limit.

Pleth Wave

The Pleth wave is autoscaled to maximum display size. It decreases only when the signal quality becomes marginal. It is NOT directly proportional to the pulse volume. If you need an indication of change in pulse volume, use the perfusion indicator.

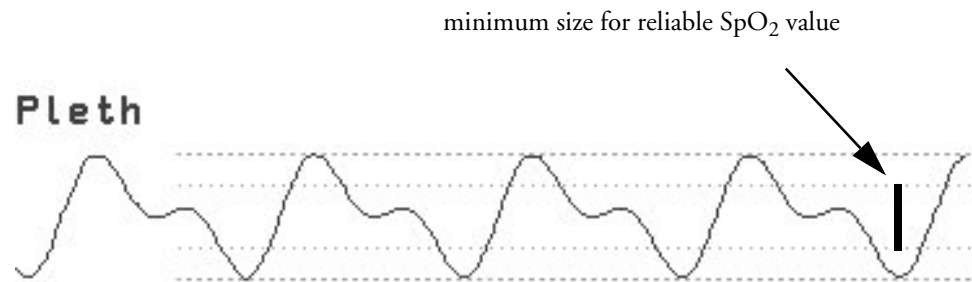

Perfusion Numeric

The perfusion numeric (**Perf**) gives a value for the pulsatile portion of the measured signal caused by the pulsating arterial blood flow.

As pulse oximetry is based on the pulsatile nature of the signal, you can also use the perfusion numeric as a quality indicator for the SpO₂ measurement. Above 1 is optimal, between 0.3-1 is acceptable. Below 0.3 is marginal; reposition the sensor or find a better site.

Perfusion Change Indicator

The perfusion change indicator is a graphic symbol which shows the change in the perfusion value, relative to a reference value which you can set.

To set the current perfusion value as the reference value:

- ◆ In the **Setup SpO₂** menu, select **Set Perf Ref..**

When a reference value has been set, the perfusion change indicator is displayed next to the perfusion numeric.

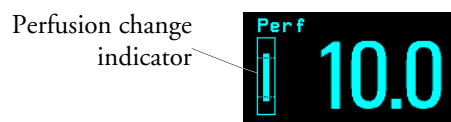

Setting SpO₂/Pleth as Pulse Source

- 1 In the **Setup SpO₂** menu, select **Pulse (SpO₂)** to enter the **Setup Pulse** menu.
- 2 In the **Setup Pulse** menu, select **SystPulse** and select **SpO₂** from the pop-up list.

Setting Up Tone Modulation

If tone modulation is on, the QRS tone pitch lowers when the SpO₂ level drops. Remember, the QRS tone is derived from either heart rate or pulse depending on which is currently selected as the active alarm source.

- ◆ In the **Setup SpO₂** menu, select **Tone Mod.** to toggle between **Yes** (for on) and **No** (for off).

Tone modulation is licensed under US patent US 4,653,498 from Nellcor Puritan Bennett Incorporated.

Setting the QRS Volume

- ◆ In the **Setup SpO₂** menu, select **QRS Volume** and set the appropriate QRS tone volume.

Monitoring NBP

This monitor uses the oscillometric method for measuring NBP. In adult and pediatric mode, the blood pressure measurements determined with this device comply with the American National Standard for Electronic or Automated Sphygmomanometers (ANSI/AAMI SP10-1992) in relation to mean error and standard deviation, when compared to intra-arterial or auscultatory measurements (depending on the configuration) in a representative patient population. For the auscultatory reference, the fifth Korotkoff sound was used to determine the diastolic pressure.

In neonatal mode, the blood pressure measurements determined with this device comply with the American National Standard for Electronic or Automated Sphygmomanometers (ANSI/AAMI SP10-1992) in relation to mean error and standard deviation, when compared to intra-arterial measurements in a representative patient population.

The NBP measurement is suitable for use in the presence of electrosurgery and during the discharge of a cardiac defibrillator according to IEC 601-2-30:1999/EN 60601-2-30:2000.

A physician must determine the clinical significance of the NBP information.

Introducing the Oscillometric NBP Measurement

Oscillometric devices measure the amplitude of pressure changes in the occluding cuff as the cuff deflates from above systolic pressure. The amplitude suddenly increases as the pulse breaks through the occlusion in the artery. As the cuff pressure decreases further, the pulsations increase in amplitude, reach a maximum (which approximates to the mean pressure), and then diminish.

Studies show that, especially in critical cases (arrhythmia, vasoconstriction, hypertension, shock), oscillometric devices are more accurate and consistent than devices using other noninvasive measuring techniques.

WARNING **Patient Category:** Select the correct patient category setting for your patient. Do not apply the higher adult inflation, overpressure limits and measurement duration to neonatal patients.

Intravenous infusion: Do not use the NBP cuff on a limb with an intravenous infusion or arterial catheter in place. This could cause tissue damage around the catheter when the infusion is slowed or blocked during cuff inflation.

Skin Damage: Do not measure NBP on patients with sickle-cell disease or any condition where skin damage has occurred or is expected.

Unattended measurement: Use clinical judgement to decide whether to perform frequent unattended blood pressure measurements on patients with severe blood clotting disorders because of the risk of hematoma in the limb fitted with the cuff.

CAUTION If you spill liquid onto the equipment or accessories, particularly if there is a chance that it can get inside the tubing or the measurement device, contact your service personnel.

Measurement Limitations

Measurements are impossible with heart rate extremes of less than 40 bpm or greater than 300 bpm, or if the patient is on a heart-lung machine.

The measurement may be inaccurate or impossible:

- if a regular arterial pressure pulse is hard to detect
- with cardiac arrhythmias
- with excessive and continuous patient movement such as shivering or convulsions
- with rapid blood pressure changes
- with severe shock or hypothermia that reduces blood flow to the peripheries
- with obesity, where a thick layer of fat surrounding a limb dampens the oscillations coming from the artery
- on an edematous extremity.

Measurement Methods

There are three methods of measuring NBP:

- **Manual** - measurement on demand.
- **Auto** - continually repeated measurements (between one and 120 minute adjustable interval).
- **Sequence** - up to four measurement cycles which will run consecutively, with number of measurements and interval between them configurable for each cycle.
- **STAT** - rapid series of measurements over a five minute period, then the monitor returns to the previous mode. Use only on supervised patients.

Reference Method

The NBP measurement reference method can be Auscultatory (manual cuff) or Invasive (intra-arterial). For further information, see the Application Note on NBP supplied on the monitor documentation CD-ROM.

In Adult and Pediatric mode to check the current setting, select **Main Setup -> Measurements -> NBP**, and check whether the **Reference** setting is set to **Auscult.** or **Invasive**. This setting can only be changed in Configuration Mode.

In Neonatal mode, to comply with safety standards, invasive is always used as the reference method. This setting cannot be changed and is not visible in any operating mode.

Preparing to Measure NBP

- 1 Connect the cuff to the air tubing.

- 2 Plug the air tubing into the red NBP connector. Avoid compression or restriction of pressure tubes. Air must pass unrestricted through the tubing.
- 3 Make sure that you are using a Philips-approved correct sized cuff and that the bladder inside the cover is not folded or twisted.
A wrong cuff size, and a folded or twisted bladder, can cause inaccurate measurements. The width of the cuff should be in the range from 37% to 47% of the limb circumference. The inflatable part of the cuff should be long enough to encircle at least 80% of the limb.
- 4 Apply the cuff to a limb at the same level as the patient’s heart. If it is not, you must use the measurement correction formula to correct the measurement.
The marking on the cuff must match the artery location. Do not wrap the cuff too tightly around the limb. It may cause discoloration, and ischemia of the extremities. Inspect the application site regularly to ensure skin quality and inspect the extremity of the cuffed limb for normal color, warmth and sensitivity. If the skin quality changes, or if the extremity circulation is being affected, move the cuff to another site or stop the blood pressure measurements immediately. Check more frequently when making automatic or stat measurements.

Correcting the Measurement if Limb is not at Heart Level

To correct the measurement if the limb is not at heart level, to the displayed value

add 0.75mmHg (0.10kPa) for each centimeter higher or	deduct 0.75mmHg (0.10kPa) for each centimeter lower or
add 1.9mmHg (0.25kPa) for each inch higher.	deduct 1.9mmHg (0.25kPa) for each inch lower.

Understanding the NBP Numerics

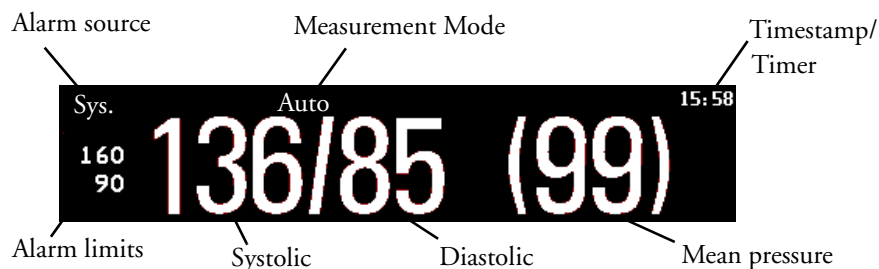

Depending on the NBP numeric size, not all elements may be visible. Your monitor may be configured to display only the systolic and diastolic values.

Alarm Sources if you have parallel alarm sources, the sources are displayed instead of the alarm limits.

NBP Timestamp depending on the configured **NBP Time** setting, the time shown beside the NBP numeric can be:

- **Meas Time:** the time of the most recent NBP measurement, or
- **Next Meas:** the time until the next measurement in an automatic series, displayed with a graphic representation of the remaining time, as shown here.



During measurements the cuff pressure is displayed instead of the units and the repeat time. An early systolic value gives you a preliminary indication of the systolic blood pressure during measurement.

Starting and Stopping Measurements

Use the Setup menu or SmartKeys to start and stop measurements.

CAUTION Use clinical judgement to decide whether to perform repeated series of STAT measurements because of the risk of purpura, ischemia and neuropathy in the limb with the cuff.

Enabling Automatic Mode and Setting Repetition Time

- 1 In the **Setup NBP** menu, select **Mode** and select **Auto** from the pop-up menu.
- 2 For an automatic measurement, select **Repeat** and set the time interval between two measurements.

Enabling Sequence Mode and Setting Up The Sequence

- 1 In the **Setup NBP** menu, select **Mode** and select **Sequence** from the pop-up menu.
- 2 Select **Setup Sequence** to open the **Setup Sequence** window.
Up to four measurement cycles can be setup which will run consecutively. For each cycle you can set the number of measurements and the interval between them. If you want to run less than four cycles in a sequence, you can set the number of measurements for one or more cycles to **Off**.
- 3 Select each sequence in turn and select the number of measurements and the time interval between the measurements.
- 4 To have measurements continue after the sequence, set the number of measurements for your last cycle to **Continuous** and this cycle will run indefinitely.

CAUTION Be aware that, if none of the cycles are set to **Continuous**, NBP monitoring will end after the last measurement of the cycle.

When the NBP measurement mode is set to **Sequence**, the repetition time for **Auto** mode cannot be changed.

Choosing the NBP Alarm Source

You can monitor for alarm conditions in systolic, diastolic and mean pressure, either singly or in parallel. Only one alarm is given, with the priority of mean, systolic, diastolic.

In the **Setup NBP** menu, select **Al . from** and choose from:

Menu option	Pressure value monitored
Sys.	systolic
Dia.	diastolic
Mean	mean
Sys&Dia	systolic and diastolic in parallel
Dia&Mean	diastolic and mean in parallel
Sys&Mean	systolic and mean in parallel
Sys&Dia&Mean	all three pressures in parallel

If mean is not selected as alarm source (Sys, Dia, or Sys&Dia selected), but the monitor can only derive a mean value, mean alarms will nevertheless be announced using the most recent mean alarm limits. When no value can be derived an **NBP MEASURE FAILED INOP** will be displayed.

Switching Pulse from NBP On/Off

In the process of making the NBP measurement, a pulse value can be derived and displayed. The pulse value is displayed together with the time the measurement was made. After one hour the value becomes invalid. There are no alarms associated with pulse from NBP.

To switch the display of the pulse value on or off:

- ◆ In the **NBP Setup** menu select **Pulse (NBP)**.



Assisting Venous Puncture

You can use the NBP cuff to cause sub-diastolic pressure. The cuff deflates automatically after a set time (adult/pediatric 170 seconds, neonatal 85 seconds) if you do not deflate it.

- 1 In the **NBP Setup** menu select **VeniPuncture**.
- 2 Puncture vein and draw blood sample.
- 3 Reselect **VeniPuncture** to deflate the cuff.

During measurement, the NBP display shows the inflation pressure of the cuff and the remaining time in venous puncture mode.

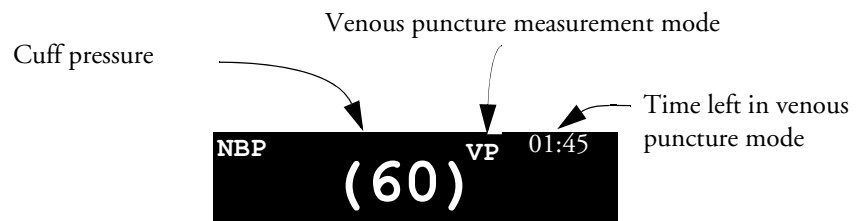

Calibrating NBP

NBP is not user-calibrated. Cuff-pressure transducers must be verified and calibrated, if necessary, at least once every two years by a qualified service professional. See the Service Guide for details.

Monitoring Temperature

WARNING Measurements from an MMS extension connected to the monitor are not available when the monitor is running on battery power. They are only available when the monitor is powered by the external power supply (M8023A).

You can measure temperature using the built-in temperature measurement (optional), or one of the MMS extensions.

Temp measurement automatically switches on when you connect a probe. You can switch the measurement off manually.

Making a Temp Measurement

- 1 Select the correct type and size of probe for your patient.
- 2 If you are using a disposable probe, connect the probe to the temperature cable.
- 3 Plug the probe or temperature cable into the temperature connector socket.

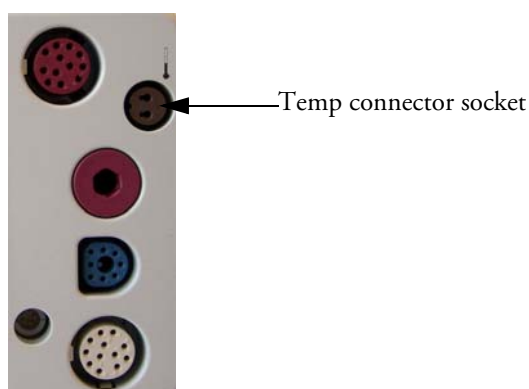

- 4 Apply the probe to the patient. You are advised to use a protective rubber cover on rectal probes.
- 5 Select an appropriate temperature label.
- 6 Check that the alarm settings (on or off, high and low limits) are appropriate for this patient and this type of temperature measurement.

WARNING Make sure you set alarm limits for the correct label. The alarm limits you set are stored for that particular label only. Changing the label may change the alarm limits.

Selecting a Temperature for Monitoring

Tell the monitor which temperature you want to monitor by selecting its temperature label. The label is a unique identifier for each type of temperature. When you choose a label, the monitor uses that label's stored color and alarm settings.

- 1 In the **Setup <Temp>** menu, select **Label**.
- 2 Select the appropriate label from the list.

Ttemp	non-specific temperature label.	Trect	rectal temperature
Tart	arterial temperature	Tskin	skin temperature
Tcore	core temperature	Tven	venous temperature
Tesoph	esophageal temperature	Tnaso	nasopharyngeal temperature

Extended Temperature Label Set

The following additional labels are available if **Label Set** is set to **Full**. This setting can only be changed in Configuration Mode.

Note that if your monitor is connected to an Information Center, the additional labels in the extended label set may not be correctly displayed. See the Configuration Guide for your monitor for more information.

T1, T2, T3, T4	Non-specific temperature labels
Tamb	ambient temperature
Tcereb	cerebral temperature
Ttymp	tympanic temperature
Tvesic	vesical temperature

Calculating Temp Difference

The monitor can calculate and display the difference between two temperature values by subtracting the second value from the first. The difference is labeled **ΔTemp**.

- 1 In the **Main Setup** menu, select **Measurements**.
- 2 In the **Setup ΔTemp** menu, select **First Temp**.
- 3 Label the measurement source as appropriate.
- 4 Select **Second Temp**.
- 5 Label the measurement source as appropriate.

Monitoring Invasive Pressure

WARNING Measurements from an MMS extension connected to the monitor are not available when the monitor is running on battery power. They are only available when the monitor is powered by the external power supply (M8023A).

CAUTION Do not use the MP2 in combination with other monitors using an M1006A pressure module and the HP1290A pressure transducer. This may cause interference on the respiration or invasive pressure signals.

You can measure pressure using the monitor's built-in pressure measurement (optional), or one of the MMS extensions.

Setting up the Pressure Measurement

- 1 Plug in the pressure cable.

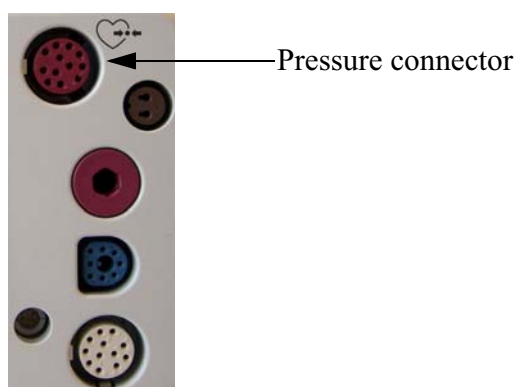

- 2 Prepare the flush solution.
- 3 Flush the system to exhaust all air from the tubing. Ensure that the transducer and stopcocks are free of air bubbles.

WARNING If air bubbles appear in the tubing system, flush the system with the infusion solution again. Air bubbles may lead to a wrong pressure reading.

- 4 Connect the pressure line to the patient catheter.
- 5 If you are using an infusion pressure cuff with the pressure line, attach the pressure cuff to the fluid to be infused. Inflate it according to your standard hospital procedure, then start the infusion.
- 6 Position the transducer so that it is level with the heart, approximately at the level of the midaxillary line.

WARNING If measuring intracranial pressure (ICP, IC1 or IC2) with a sitting patient, level the transducer with the top of the patient's ear. Incorrect leveling may give incorrect values.

Selecting a Pressure for Monitoring

Tell the monitor which pressure you want to monitor by selecting its pressure label. The label is a unique identifier for each type of pressure. When you choose a label, the monitor uses that label's stored settings, for example color, wave scale and alarm settings. The label also determines which algorithm is used to process the pressure signal, so an incorrect label can lead to incorrect pressure values.

- 1 In the **Setup <Press>** menu, select **Label**.
- 2 Select the appropriate label from the list.

Label	Description	Label	Description
ABP	Arterial blood pressure	P	Non-specific pressure label
ART	Arterial blood pressure (alternative)	PAP	Pulmonary artery pressure
Ao	Aortic pressure	RAP	Right atrial pressure
CVP	Central venous pressure	UAP	Umbilical arterial pressure
ICP	Intracranial pressure	UVP	Umbilical venous pressure
LAP	Left atrial pressure		

Extended Pressure Label Set

The following additional labels are available if **Label Set** is set to **Full**. This setting can only be changed in Configuration Mode.

Note that if your monitor is connected to an Information Center, the additional labels in the extended label set may not be correctly displayed. See the Configuration Guide for your monitor for more information.

Label	Description
BAP	Brachial arterial pressure
FAP	Femoral arterial pressure
IC1, IC2	Alternative intracranial pressures
P1, P2, P3, P4	Alternative non-specific pressure labels

Zeroing the Pressure Transducer

To avoid inaccurate pressure readings, the monitor requires a valid zero. Zero the transducer in accordance with your hospital policy (at least once per day). You must perform a zero:

- when you use a new transducer or tubing
- every time you reconnect the transducer cable to the monitor
- if you think the monitor's pressure readings are not correct.

Zeroing ICP (or IC1/IC2)

Your hospital guidelines may require you to zero the ICP transducer less frequently than other transducers, due to the need for aseptic conditions. When you zero an ICP transducer, the zero values are automatically stored and you will not be prompted to repeat the zero procedure.

If you want to simultaneously zero all pressures except ICP, disconnect the ICP transducer from the monitor while zeroing. Reconnecting the transducer recalls the stored values.

WARNING If you select the label ICP (or IC1/IC2), the measurement device uses the most recently stored zero. Therefore, make sure you zeroed the transducer correctly in accordance with the transducer manufacturer's instructions and your hospital policy. When you use a transducer that you cannot rezero after placement, ensure that you keep the measuring device with the patient so that you are certain you have the correct zero data for this patient.

Determining a Pressure's Most Recent Zero

The monitor displays the most recent zero on the status line. If this has "timed-out" after you have performed a zero, redisplay the information in the status line by entering the pressure's setup menu.

Zeroing a Pressure Measurement

WARNING Invasive pressure alarms (and pulse alarms, if derived from invasive pressure) are temporarily suppressed until 30 seconds after the transducer finishes zeroing.

- 1 Turn off the stopcock to the patient.
- 2 Vent the transducer to atmospheric pressure, to compensate for the static and atmospheric pressure exerted on the transducer.
- 3 In the setup menu for the pressure, select **Zero <Press>**.
- 4 When you see the message **<Press> zero done at <date and time>** on the status line, (for example, **ABP zero done at 13 Mar 02 23.35**) close the stopcock to atmospheric pressure, and open the stopcock to the patient.

CAUTION When using high frequency ventilation, ensure that the tubing from the ventilator does not touch the arterial line, or connect with it indirectly, while zeroing the pressure. This could cause small pressure variations which can interfere with the zero procedure.

Zeroing All Pressures Simultaneously

WARNING Before zeroing all pressures, make sure that all pressure transducers are vented to atmospheric pressure.

If you are measuring pressures with more than one measuring device, using the **Zero Press** SmartKey to initiate the zeroing calls up a list of all active pressures. Select the pressure you want to zero or select **All Press** to zero all pressures simultaneously.

Troubleshooting the Zero

The status line lists the probable cause of an unsuccessful zero:

Message	Corrective Action
can't zero; equipment malf.	The hardware is faulty. Contact your service personnel.
can't zero; excessive offset	Make sure the transducer is vented to air and try again. If this fails, the hardware may be faulty. Replace the adapter cable and try again. If it fails, replace the transducer and try again. If it still fails, contact your service personnel.
can't zero - unstable signal	
can't zero - no transducer	Make sure that the transducer is connected and try again. If this fails, exchange the adapter cable and try again. If this fails, exchange the transducer.
can't zero; pulsat. pressure	Make sure that the transducer is vented to air, not to the patient, and try again.
unable to zero - timed out	Try pressing the Zero key again. If this fails, replace the transducer and adapter cable and contact your service personnel.
switch <Press> on first	Pressure measurement is switched off. To switch it on, in the Setup Pressure menu, select the pressure's label.

Adjusting the Calibration Factor

Each time you use a reusable transducer, compare the calibration factor written on your transducer with the calibration factor shown on the monitor. To ensure accurate measurement, they must be the same.

- 1 In the **Setup <Press>** menu, select **Cal. Factor**.
If the value here does **not** match that on the transducer, select the corresponding value from the list now in accordance with your hospital's procedure.
- 2 To confirm you want to use the new calibration factor, select the Confirm popup.

Displaying a Mean Pressure Value Only

Use this when you want to see only the mean pressure.

- ◆ In the pressure's setup menu, select **Mean only**. Toggle between **On** to display mean pressure value only, and **Off** to display all pressure values (systolic, diastolic and mean).

Changing the Pressure Wave Scale

- 1 Select the label of the pressure wave whose scale you want to set to enter the **Setup** menu.
- 2 In the **Setup <Press>** menu, (for example **ABP**) select **Scale**.
- 3 Select a value from the pop-up list:
 - a positive value sets the top gridline. The bottom gridline is set at zero.
 - a negative value sets the bottom gridline. The middle gridline is set at zero.

Optimizing the Waveform

- ◆ In the **Setup <Press>** menu, select **Optimum Scale** to let the monitor select the best minimum and maximum scales for the current wave.

Non-Physiological Artifact Suppression

Some clinical procedures may affect blood pressure, for example, a flush procedure or a blood sample. Your monitor may be configured to suppress these non-physiological artifacts for a specified duration (**Artifact Suppression** is configured to 30, 60, or 90 seconds). During artifact suppression, the monitor shows the INOP message **<Pressure label> ARTIFACT**, and a question mark is shown beside the pressure numerics. Pressure alarms and the **Pulse NON-PULSATILE INOP** are suppressed during the configured period. The CPP high alarm is not suppressed.

Choosing the Pressure Alarm Source

WARNING Make sure you set alarm limits for the correct label. The alarm limits you set are stored for that particular label only. Changing the label may change the alarm limits.

You can monitor for alarm conditions in systolic, diastolic and mean pressure, either singly or in parallel. Only one alarm is given at a time, in this order of priority: mean, systolic, diastolic.

- ◆ In the **Setup <Press>** menu, select **Al. from** and choose the source.

Menu option	Pressure value monitored
Sys.	systolic
Dia.	diastolic
Mean	mean
Sys & Dia	systolic and diastolic in parallel
Dia & Mean	diastolic and mean in parallel
Sys & Mean	systolic and mean in parallel
Sys&Dia&Mean	all three pressures in parallel

- ◆ Select and set the **High Limit** and **Low Limit** for the pressure(s) you have selected.

Extreme Alarm Limits

The extreme pressure alarms, Extreme High and Extreme Low, can be made available for your monitor in Configuration Mode and are additional to the standard High and Low limit alarms. They are generated by the active pressure alarm source, and are setup in Configuration Mode by adding a set value (the Δ value) to the high and low alarm limits. This value can be set for each pressure label individually.

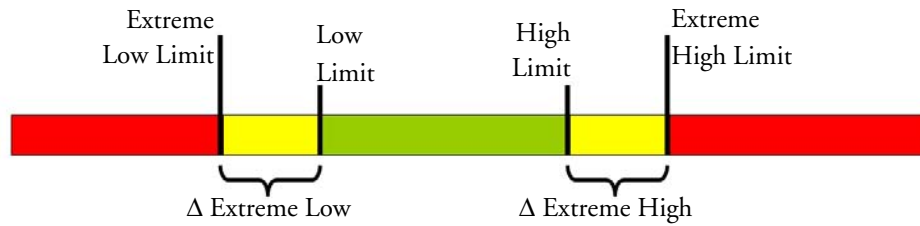

You need to know which values have been configured for your monitor. Changing the high and low alarm limits automatically changes the extreme alarm limits within the allowed range.

- ◆ To see the extreme pressure alarms set for your monitor, in the **Setup <Press>** menu, see the menu items **Δ Extr. High** and **Δ Extr. Low**.

The extreme pressure alarms are high priority, red alarms, marked ******* in the alarm message.

Calibrating Reusable Transducer CPJ840J6

Depending on your monitor's configuration, you may be able to perform a calibration in monitoring mode. Perform a mercury calibration when you use a new transducer, and at regular intervals according to your hospital policy. You require:

- standard sphygmomanometer.
- sterile 10cc syringe with heparinised solution.
- 3-way stopcock.
- approximately 25cm of tubing.

Making the Pressure Calibration

WARNING Never perform the invasive pressure calibration while a patient is being monitored.

- 1 Zero the transducer.
- 2 Connect the syringe and manometer.
 - a. Attach the tubing to the manometer.
 - b. Connect the 3-way stopcock to the stopcock that is not connected to the patient catheter when you measure a patient.
 - c. Attach the syringe to one port and the manometer tubing to the other port.
 - d. Open the port to the manometer.

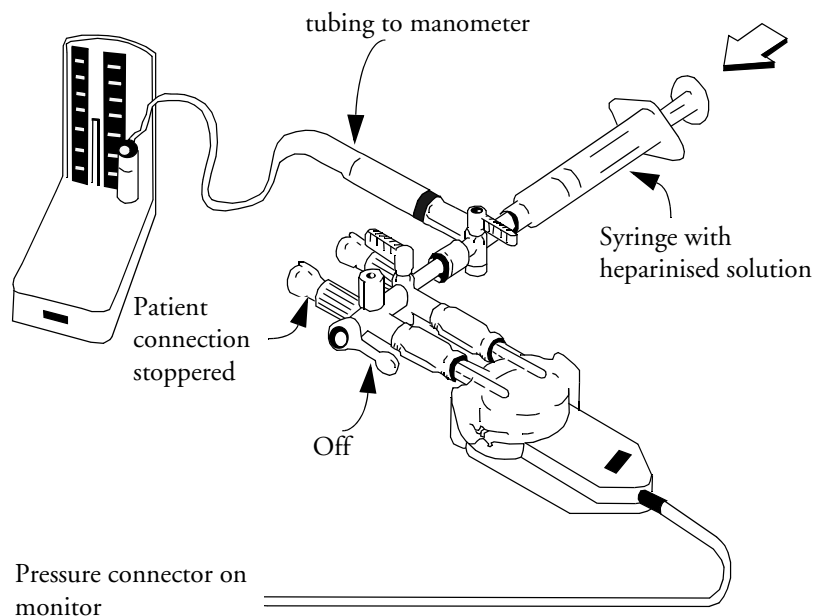

- 3 Move the syringe barrel in and raise the mercury to 200mmHg (30kPa). 200mmHg is the recommended calibration pressure.
- 4 In the **Setup Pressure** menu, select **Cal. Press.**

- 5 Select the calibration pressure from the list, for example 200 mmHg.
- 6 Select **Confirm** to recalculate the calibration factor using the applied pressure.
- 7 When the monitor displays **<Press> calibration done at <date and time>**, remove the manometer tubing, syringe and extra stopcock. We recommend you replace the transducer dome and tubing with sterile ones.
- 8 Label the transducer with the calibration factor shown in the **Cal. Factor** field in the pressure's setup menu.
- 9 Reconnect the patient and start measuring again.

Troubleshooting the Pressure Calibration

The status line lists the probable cause of an unsuccessful calibration.

Message	Corrective Action
can't calibr. ; equipmt malf.	Contact your service department. The pressure hardware is faulty.
can't calibrate;out of range	Make sure that you have selected the value for Cal. Press that you are applying to the transducer, and repeat the calibration.
can't calibr. ; no transd.	Make sure that the transducer is connected and try again.
can't cal. ; unstable signal	Make sure there are no disturbances to the transducer, and repeat the calibration.
can't calibr. ;do zero first	No valid zero. Zero the transducer.

Calculating Cerebral Perfusion

The monitor can calculate the difference between mean arterial pressure and the intracranial pressure. The difference is labeled CPP.

- 1 In the **Main Setup** menu, select **Measurements**.
- 2 In the **Setup CPP** menu, select **ABP, ART, Ao, BAP** or **FAP** as the arterial pressure source.

Monitoring Carbon Dioxide

-
- WARNING**
- Measurements from an MMS extension connected to the monitor are not available when the monitor is running on battery power. They are only available when the monitor is powered by the external power supply (M8023A).
 - Only one CO₂ measurement at a time is supported.
-

Use the CO₂ measurement to monitor the patient's respiratory status and to control patient ventilation.

There are two methods for measuring carbon dioxide in the patient's airway:

- Mainstream measurement uses a CO₂ sensor attached to an airway adapter directly inserted into the patient's breathing system. This method is available using the monitor's built-in CO₂ measurement (optional), the M3014A Capnography Extension or the M3016A Mainstream Extension.
- Sidestream measurement takes a sample of the respiratory gas with a constant sample flow from the patient's airway and analyzes it with a remote CO₂ sensor. You can measure sidestream CO₂ using the monitor's built-in CO₂ measurement (optional) or using the M3014A Capnography Extension, or the M3015A Microstream CO₂ Extension.

In both cases, the measurement principle is infrared transmission, where the intensity of infrared light passing the respiratory gas is measured with a photo detector. As some of the infrared light is absorbed by the CO₂ molecules, the amount of light passing the gas probe depends on the concentration of the measured CO₂.

When using a wet ventilator circuit, monitor mainstream CO₂ if available, in preference to sidestream CO₂.

The partial pressure is calculated from the gas concentration by multiplying the concentration value with the ambient pressure.

The measurement provides:

- a CO₂ waveform.
- an end tidal CO₂ (etCO₂) value: the CO₂ value measured at the end of the expiration phase.
- an inspired minimum CO₂ (imCO₂): the smallest value measured during inspiration.
- an airway respiration rate (awRR): the number of breaths per minute, calculated from the CO₂ waveform.

Depending on the **Max Hold** setting configured for your monitor, the etCO₂ numeric shows either the highest CO₂ value measured within the configured time period (**Max Hold** set to **10 sec** or **20 sec**) or the etCO₂ numeric shows breath-to-breath value (**Max Hold** set to **Off**).

WARNING **Correlation:** The etCO₂ readings do not always correlate closely with paCO₂, especially in neonatal patients and patients with pulmonary disease, pulmonary embolism or inappropriate ventilation.

Pharmaceuticals in aerosols: Do not measure CO₂ in the presence of pharmaceuticals in aerosols.

Explosion Hazard: Do not use in the presence of flammable anesthetics or gases, such as a flammable anesthetic mixture with air, oxygen or nitrous oxide. Use of the devices in such an environment may present an explosion hazard.

Failure of operation: if the measurement or a sensor fails to respond as described, do not use it until the situation has been corrected by qualified personnel.

Low etCO₂ values: Leakages in the breathing system or sampling system may cause the displayed etCO₂ values to be significantly too low. Always connect all components securely and check for leaks according to standard clinical procedures. Displacement of the nasal or combined nasal oral cannulas can cause lower than actual etCO₂ readings. Even with combined nasal oral cannulas, the etCO₂ readings may be slightly lower than actual in patients breathing through the mouth only.

Measuring CO₂ using the CO₂ Option or M3014A

The monitor (with the CO₂ option) or the M3014A Capnography Extension measures partial pressure of carbon dioxide in a patient's expired gas using the mainstream method or the sidestream method.

The mainstream CO₂ measurement can be used, with appropriate accessories, with intubated adult, pediatric and neonatal patients. The sidestream CO₂ measurement can be used, with appropriate accessories, with intubated and nonintubated adult, pediatric, infant and neonatal patients. With intubated patients, a sample of the respiratory gas is drawn from the patient's breathing circuit through an airway adapter and a gas sampling tube. With non-intubated patients, the gas sample is drawn through a nasal or oral-nasal cannula.

WARNING **Altitude Setting:** The monitor is not equipped with automatic barometric pressure compensation. Before the CO₂ measurement is used for the first time, the altitude must be set to the correct value. An incorrect altitude setting will result in incorrect CO₂ readings. The CO₂ readings will typically deviate 5% for every 1000m difference.

Electrical Shock Hazard: Do not open the monitor or measurement device. Contact with exposed electrical components may cause electrical shock. Always turn off and remove power before cleaning the sensor, monitor or measurement device. Do not use a damaged sensor or one with exposed electrical contacts. Refer servicing to qualified service personnel.

Preparing to Measure Mainstream CO₂

You must perform a zero as described in this procedure each time you use a new airway adapter.

- 1 Attach the sensor connector to the CO₂ connector on the monitor (when the optional CO₂ measurement is integrated) or on the extension.

- 2 Wait 2 minutes, allowing the sensor to reach its operating temperature and a stable thermal condition.
- 3 Choose the appropriate airway adapter and connect it to the sensor head. The airway adapter clicks into place when seated correctly.
- 4 To zero the sensor:
 - expose the sensor to room air and keep it away from all sources of CO₂ including the ventilator, the patient's breath and your own.
 - in the setup menu for the CO₂, select **Start Zero Cal.**
 - When you see the message **Zero done at <date and time>** on the status line, the zero calibration is finished and you can begin monitoring.
- 5 Install the airway adapter at the proximal end of the circuit between the elbow and the ventilator Y-section.

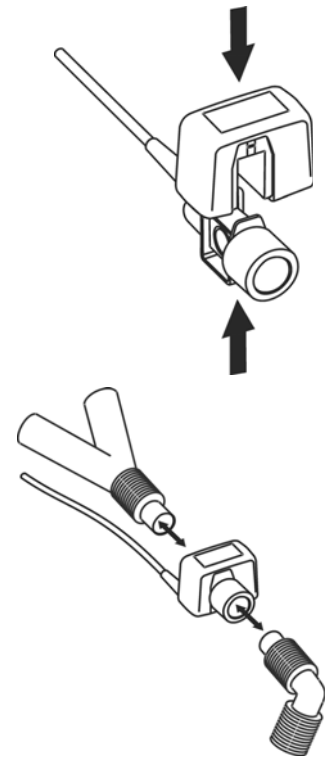

WARNING To prevent stress on the endotracheal tube, support the sensor and airway adapter.

Position sensor cables and tubing carefully to avoid entanglement or potential strangulation. Do not apply excessive tension to any cable.

Replace the airway adapter, if excessive moisture or secretions are observed in the tubing or if the CO₂ waveform changes unexpectedly without a change in patient status.

To avoid infection, use only sterilized, disinfected or disposable airway adapters.

Inspect the airway adapters prior to use. Do not use if airway adapter appears to have been damaged or broken. Observe airway adapter color coding for patient population.

Preparing to Measure Sidestream CO₂

- 1 Plug the sensor cable into the monitor's CO₂ input connector. Allow the sensor two minutes warm up time
- 2 Connect the cannula, airway adapter, or sample line as appropriate, to the sensor. It will click into place when seated correctly.
- 3 To zero the sensor:

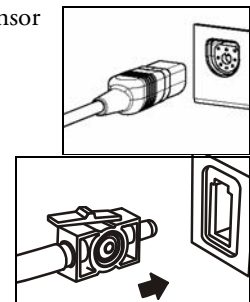

- expose the sensor to room air and keep it away from all sources of CO₂ including the ventilator, the patient's breath and your own.
 - In the setup menu for the CO₂, select **Start Zero Cal.**
 - When you see the message **Zero done at <date and time>** on the status line, the zero calibration is finished and you can begin monitoring.
- 4 For intubated patients requiring an airway adapter: Install the airway adapter at the proximal end of the circuit between the elbow and the ventilator Y-section.

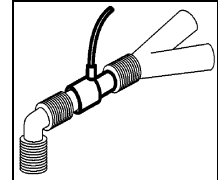

For intubated patients with an integrated airway adapter in the breathing circuit.: Connect the male luer connector on the straight sample line to the female port on the airway adapter.

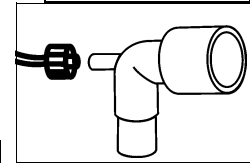

For non-intubated patients: Place the nasal cannula onto the patient.

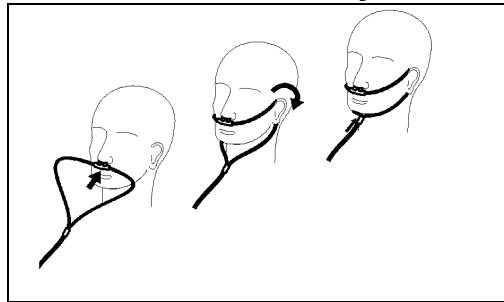

For patients prone to mouth breathing use an oral-nasal cannula.

For nasal or oral-nasal cannulas with oxygen delivery, place the cannula on the patient as shown then attach the oxygen supply tubing to the oxygen delivery system and set the prescribed oxygen flow.

WARNING Always connect the airway adapter to the sensor before inserting the airway adapter into the breathing circuit. In reverse, always remove the airway adapter from the breathing circuit before removing the sensor.

CAUTION Always disconnect the cannula, airway adapter or sample line from the sensor when not in use.

Using the Sidestream Sensor Holder

The holder delivered with the sensor can be used to clamp the sensor onto an IV pole or a shelf.

- 1 Push the sensor into the holder until it clicks into position.
- 2 Clamp the holder onto an IV pole, a shelf or another appropriate location.

To remove the sensor from the holder, release the clip and pull the sensor out of the holder.

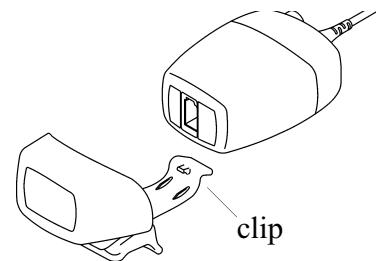

Removing Exhaust Gases from the System

WARNING **Anesthetics:** When using the sidestream CO₂ measurement on patients who are receiving or have recently received anesthetics, connect the outlet to a scavenging system, to avoid exposing medical staff to anesthetics.

Use an exhaust tube to remove the sample gas to a scavenging system. Attach it to the sidestream sensor at the outlet connector.

Measuring Mainstream CO₂ using M3016A

The M3016A Mainstream CO₂ Extension measures partial pressure of carbon dioxide in a patient's expired gas using the mainstream method. When using the appropriate accessories you can use the mainstream CO₂ measurement with ventilated adults, pediatric and neonatal patients.

WARNING **Infra-red radiation:** Do not expose the airway adapter or M1460A transducer to infra-red radiation during use. This may cause incorrect readings.

Preparing to Measure Mainstream CO₂

- 1 Attach the transducer connector to the CO₂ connector on the M3016A extension.
- 2 Wait 20 minutes, allowing the transducer to reach its operating temperature and a stable thermal condition.
- 3 Perform an accuracy check and then, if necessary, calibrate the transducer.

Checking Transducer Accuracy

WARNING Check transducer accuracy at least once a week or if you doubt the CO₂ readings.

- 1 In **Setup CO₂** menu, select **Cal. Mode** to switch on calibration mode.
- 2 Look at the calibration value displayed in the **Setup CO₂** menu next to **Start CAL1**. Is it the same as the value on the calstick? If not, calibrate the transducer now.
- 3 Place the transducer on the low cell of the calstick (labelled 0.0 mmHg or "ZERO"). The reading on the screen should be zero within ± 1 mmHg within one minute.
- 4 Place the transducer on the high cell of the calstick. The reading on the screen should be within ± 1 mmHg of the value on the calstick within one minute.
- 5 If both readings are in range, you can leave calibration mode and begin monitoring. If either of the readings is out of range, calibrate the transducer.

Calibrating the Transducer

- 1 Check that the windows on the calstick are clean and clear.
- 2 Place the transducer on one of the calstick cells and select **Start CAL1**.

- 3 Enter the calibration value printed on the calstick then press **Confirm** to start calibration.
- 4 When the message **CO₂ CAL1 done; Start CAL2 cal** appears, put the transducer on the other cell and select **Start CAL2** then press **Confirm**.
- 5 When you see the message **CO₂ cal done; leave Cal. Mode**, calibration is complete.
- 6 Select **Cal. Mode** to switch calibration mode off. You cannot monitor in calibration mode.

Attaching and Removing the CO₂ Transducer

- 1 Open the latch and place the transducer onto the airway adapter. Place the airway adapter in the patient's breathing circuit between the endotracheal tube and the Y-piece. You may see the **CO₂ SENSOR WARMUP** message until the transducer reaches operating temperature. Wait until this disappears before starting the measurement.
- 2 To remove the transducer from the airway adapter, open the latch and pull out the airway adapter.

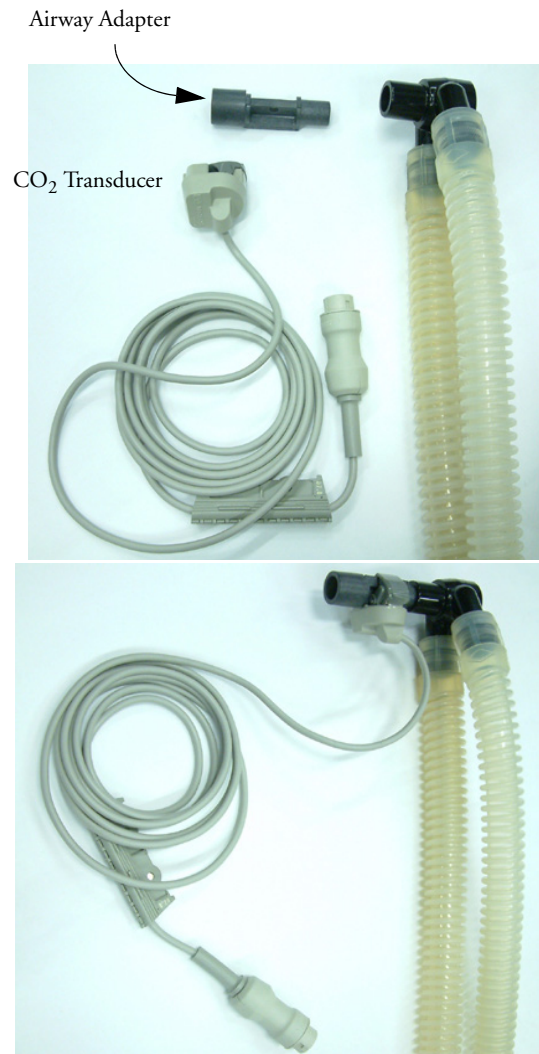

WARNING To prevent stress on the endotracheal tube, support the transducer and airway adapter.
To avoid infection, use only sterilized airway adapters.

Measuring Microstream CO₂ using M3015A

The M3015A Microstream CO₂ Extension measures the partial pressure of carbon dioxide in a patient's expired gas using Microstream technology.

The measurement is equipped with an automatic barometric pressure compensation.

Preparing to Measure Microstream CO₂

Use appropriate accessories for:

- the patient type (adult, pediatric or neonatal),
- the ventilation situation (including humidification)
- the duration - short term use, up to 24 hours (typically OR), or long term use (typically ICU).

All accessories are for single patient use only.

Using Microstream Accessories

The Microstream measurement can be operated with the special Microstream accessories only. Refer to the instructions for use provided with the accessory.

For intubated patient with non-humidified ventilation, you can use a Microstream FilterLine set. For humidified ventilation, use a FilterLine H Set.

For non-intubated patients, the gas sample is taken through a Nasal FilterLine, or a Smart CapnoLine (which is a combined oral-nasal FilterLine). In parallel to the measurement of the CO₂, oxygen (O₂) may be delivered to the patient to support gas exchange. This is done by using an O₂/CO₂ FilterLine, or a Smart CapnoLine O₂ (a combined oral-nasal O₂/CO₂ FilterLine).

Using the FilterLine and Airway Adapter

- 1 Attach the female Luer connector to the CO₂ inlet connector on the extension by pushing the socket cover down and screwing the connector into place.

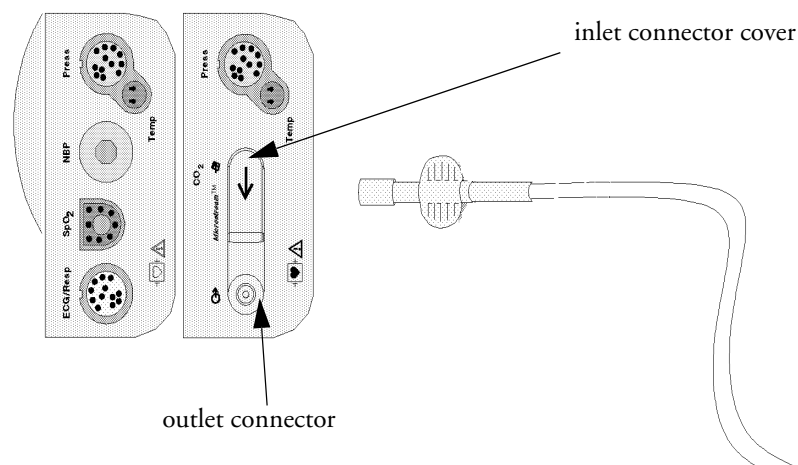

- 2 Check that the FilterLine is not kinked.
- 3 Change the FilterLine if a **CO₂ OCCLUSION INOP** appears on the monitor or if the readings become extremely erratic.

Disconnect the FilterLine during suctioning and nebulizing therapies.

Check the table in the Microstream CO₂ Accessories section of the Accessories chapter for typical usage times for the different Microstream accessories.

CO₂ values for non-intubated patients using Microstream accessories will always tend to be lower than for intubated patients. If values appear extremely low, check whether the patient is breathing through the mouth or whether one nostril is blocked

Removing Exhaust Gases from the System

WARNING **Anesthetics:** When using the Microstream CO₂ measurement on patients who are receiving or have recently received anesthetics, connect the outlet to a scavenging system, or to the anesthesia machine/ventilator, to avoid exposing medical staff to anesthetics.

Use an exhaust tube to remove the sample gas to a scavenging system. Attach it to the MMS Extension at the outlet connector.

Suppressing Zero Calibration

To prevent an automatic zero calibration from being started in the next five minutes,

- ◆ in the **Setup CO₂** menu, select **No Zero For 5Min**, or select the **Suppress CO₂ Zero** SmartKey, if configured.

Selecting **No Zero For 5Min** or selecting the **Suppress CO₂ Zero** SmartKey again before the timer has timed out resets the timer to five minutes, unless an AutoZero became due during the previous suppression.

Setting up all CO₂ Measurements

These tasks are common to all CO₂ measurements except where otherwise noted.

Adjusting the CO₂ Wave Scale

- 1 In the **CO₂ Wave** menu or the **Setup CO₂** menu, select **Scale**.
- 2 Choose a suitable scale range from the pop-up list.

Setting up CO₂ Corrections

Temperature, water vapor in the patient's breath, barometric pressure, and the proportions of O₂, N₂O and Helium in the mixture all influence CO₂ absorption. If values seem inaccurately high or low, check that the monitor is using the appropriate corrections.

Correction	
Altitude (M3014A only)	Altitude is set during installation. The monitor automatically applies an appropriate correction.

Correction	
O ₂ (M3014A only)	In the Setup CO₂ menu, select Oxy. Corr and select a value between 20% and 100%, the default value is 20%. If you are not measuring the expired O ₂ , estimate it by subtracting 5% from the inspired O ₂ then select the nearest value from the list.
Humidity	At installation, the monitor is configured to automatically apply either Body Temperature Pressure Saturated (BTPS) or Ambient Temperature Pressure Dry (ATPD). To see which, go to the Setup CO₂ menu, and scroll down to look at Hum. Corr or HumidityCorr .
N ₂ O (M3016A mainstream and M3015A microstream only)	In the Setup CO₂ menu, select N₂O Corr. and turn on or off. If N ₂ O is present in the ventilation gas mixture, you must turn this on. If the N ₂ O correction is not available in the Setup CO₂ menu, the CO ₂ measurement in your MMS Extension does not require N ₂ O correction or it is setup with Gas Corr. (see below).
Gas (M3014A only)	In the Setup CO₂ menu, select Gas Corr. and select Helium, N₂O or turn off. If Helium or N ₂ O is present in the ventilation gas mixture, you must make the appropriate selection. If the Gas correction is not available in the Setup CO₂ menu, the CO ₂ measurement in your MMS Extension does not require N ₂ O or Helium correction or the N ₂ O correction is setup with N₂O Corr. (see above).
Agent (M3014A only)	In the Setup CO₂ menu, select Agt. Corr. and select the concentration of the anesthetic agent (between 0.0% and 20.0%). If an anesthetic agent is present in the ventilation gas mixture, you must select the appropriate concentration.

Suppressing Sampling (not Mainstream CO₂)

To temporarily stop sampling,

- ◆ in the **Setup CO₂** menu, select **Pump 15Min Off** or use the **CO₂ Pump Off** SmartKey if available.

Selecting **Pump 15Min Off** again before fifteen minutes have passed resets the timer to fifteen minutes.

To re-start the pump,

- ◆ in the **Setup CO₂** menu, select **Pump On**.

Changing CO₂ Alarms

This refers to CO₂ specific alarms. See the Alarms section for general alarm information.

You change CO₂ alarm settings in the **Setup CO₂** menu.

To switch etCO₂ alarms on and off:

- ◆ Select **etCO₂ Alarms** and toggle between **On** and **Off**.

To change the **etCO₂** alarm limits:

- Touch the high limit on the alarm limits menu button. Choose the high alarm limit from the pop-up list that opens.
- Touch the low limit on the alarm limits menu button. Choose the low alarm limit from the pop-up list that opens.

To change the imCO₂ high limit:

- ◆ Select **imCO₂ High** and choose the high alarm limit from the pop-up list that opens.

Changing the Apnea Alarm Delay

This determines the time limit after which the monitor alarms if the patient stops breathing.

- 1 In the **Setup CO₂** menu, select **awRR**.
- 2 In **Setup awRR** menu, select **Apnea**.
- 3 Choose the apnea alarm delay time.

WARNING Safety and effectiveness of the respiration measurement method in the detection of apnea, particularly the apnea of prematurity and apnea of infancy, has not been established.

Prolonged delay: The selected apnea alarm delay may be prolonged by up to 17 seconds, if an apnea occurs during the automatic zero process. This applies to the Microstream (M3015A) measurement only.

Deriving Alarms From awRR

- 1 In the **Setup CO₂** menu, select **awRR**.
- 2 In the **Setup awRR** menu, select **Alarms**.
- 3 Choose **On** to derive alarms from the airway respiration signal or **Off** to disable them.

Changing awRR Alarm Limits

- 1 In the **Setup CO₂** menu, select **awRR**.
- 2 Select **High Limit** to set the upper alarm limit.
Select **Low Limit** to set the lower alarm limit.
- 3 Select the appropriate setting.

Assigning Two Devices to One Patient

It is possible to assign a monitor and a telemetry device to the same patient, resulting in the information from both devices being combined in one sector at the Information Center. This is called “pairing” and when a telemetry device and a monitor are paired, the measurement data from the telemetry device will be displayed on the monitor screen.

A telemetry device can be:

- any Philips telemetry device (only for indirect connections, see below).
- a TRx+/TRx+ Intellivue Telemetry system transceiver.

How Can You Combine Devices?

- With an **indirect** connection, using standard telemetry transmission - the data are sent to the monitor via the Information Center and arrive with a delay of several seconds at the monitor.
- With a **direct** connection to the monitor, via a short range radio link - the data arrive with a minimal delay on the monitor screen.

Indirect Connection - Manual Pairing

The telemetry device can be paired with the monitor at the Information Center or at the monitor. For detailed information regarding pairing and configuration at the Information Center, see the Information Center Instructions for Use.

To pair the monitor with a telemetry device at the monitor:

- 1 Select **Main Setup** then **Measurements**
- 2 Select **Telemetry**

The **Setup Telemetry** menu will appear with only one entry **Paired Equipment**.

- 3 Enter here the equipment label of the telemetry device to be paired.

Pairing at the monitor is only possible when the monitor already has a connection to the Information Center and the Information Center software version allows pairing at the monitor.

Telemetry Data Window

The measurements from the telemetry device are shown in the telemetry data window on the monitor when there is no direct connection via short range radio link.

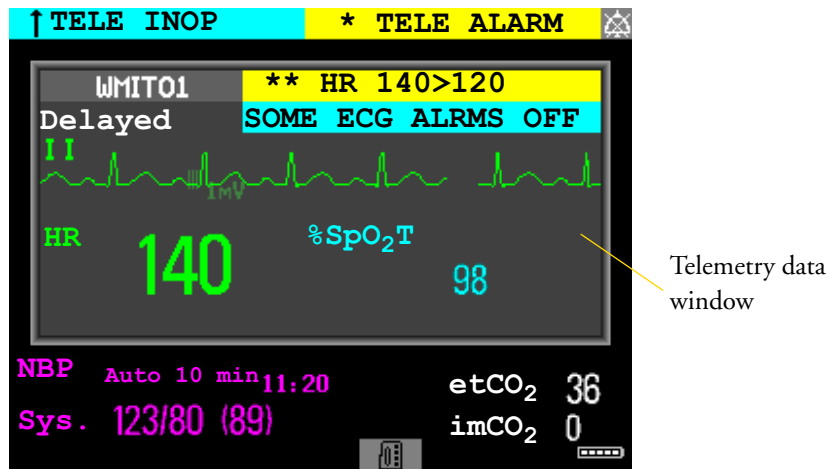

WARNING All data presented in the telemetry data window are delayed for several seconds.

If you need realtime data, for example for defibrillation, always use the monitor ECG instead of telemetry. As long as the ECG is being measured with the telemetry device there will be no ECG signal available at the ECG Sync Pulse output.

Direct Connection - Automatic Pairing

The following direct connections are possible:

- a TRx+4841A Intellivue Telemetry system transceiver connected via short range radio (SRR) link to an MP2 with SRR capability.

If a telemetry device is assigned to a monitor via a direct short range radio link, the monitor and the telemetry device are automatically paired at the Information Center (if configured).

The measured data from the telemetry device — ECG and, if available, SpO₂T— will appear on the monitor screen and will be sent through the monitor to the Information Center. The ECG waves and numerics appear in place of the monitor's own ECG, and SpO₂T is displayed as an additional measurement. When ECG is measured with the telemetry device there will be no Respiration measurement derived.

- WARNING**
- When ECG is being measured with a telemetry device directly connected to the monitor, there will be no ECG signal available at the ECG analog output or ECG Sync Pulse output and no synchronization marks on the ECG wave. A **No ECG Out** message will appear in the ECG wave channel.
 - When a telemetry device is connected to the monitor, arrhythmia relearning is initiated, and again when the telemetry device is disconnected.

- Controls on the Telemetry Device (e.g. nurse call) will be inactive when the device is directly connected to the monitor except in the case when the monitor has no network connection and data are transferred via the telemetry device. See the "Enhancing Telemetry Monitoring with the Monitor" chapter.

Assigning a Telemetry Transceiver with an SRR Adapter to a Monitor

Monitors which have this capability have a short range radio symbol  on the model label.

A telemetry device with a short range radio adapter can be assigned to a monitor directly. To assign a telemetry device to a monitor:

- 1 Press the Check button on the telemetry device.
The measurement selection key on the monitor will change to show the "assign telemetry" icon 
- 2 Select the assign telemetry icon.
- 3 In the **Assign Telemetry Device** menu, select the correct equipment label for the telemetry device.
- 4 Check that the assignment is successful and that transmission has begun:
 - A **Tele Device assigned** message appears on the monitor
 - a tone sounds at the telemetry device and the Laeds Off indicators light
 - the ECG wave appears on the monitor

To confirm that the correct telemetry device has been assigned, open the ECG Setup menu. The title of the menu contains the equipment label of the telemetry device; check that this is the correct label.

If a monitor is already paired to another device, you cannot assign a telemetry device to that monitor.

If the telemetry device goes out-of-range or loses the short range radio connection, it will switch over to standard telemetry transmission to the Information Center. In this case, the telemetry data is displayed in the Telemetry Data Window as described above.

If a monitor is manually paired with a telemetry device with a short range radio adapter, the short range radio assignment will be automatically made.

If a telemetry device disappears from the list in the **Assign Telemetry Device** menu, press the Check button on the telemetry device again. If the monitor is not configured to be used with a telemetry device, the "assign telemetry" icon will appear crossed out .

If the devices are unpaired, the short range radio connection will be ended.

WARNING Short range radio connections are subject to interruption due to interference from other radio sources in the vicinity, including microwaves, bluetooth devices and DECT phones. Outside the operating frequency band and 5% above and below, i.e. the exclusion band according IEC 60601-1-2, section 36.202.3a)4), the short range radio connection is immune up to 3V/m in the frequency range from 80 MHz to 2.0 GHz and up to 1V/m in the frequency range from 2.0 to 2.3 GHz. Depending on the strength and duration of the interference, the interruption may occur for an extended period. A loss of connection, due to moving out-of-range, interference, or for other reasons, is indicated with a **TELE DISCONNECT INOP**.

Correct channel configuration is important, refer to the Configuration Guide for details.

If a **TELE DISCONNECT** INOP occurs when the telemetry device goes out-of-range, the INOP will disappear (without being silenced) as soon as the ECG signal from the telemetry device is available at the Information Center via standard telemetry transmission.

SpO₂T Manual Mode

When a telemetry device with a short range radio connection supplies SpO₂T to the monitor, the monitor will have a manual measurement mode available. This allows SpO₂ measurements to be made on request and not continuously, helping to save battery power. To ensure there is no gap in SpO₂ measurements when moving from standard telemetry transmission to short range radio transmission, the measurement mode will always be set to continuous in this situation unless manual mode is set in both the telemetry device and the monitor.

Unassigning a Telemetry Transceiver with SRR Adapter at the Monitor

If a monitor and a telemetry device are paired, the assignment and the short range radio connection will be ended when the devices are unpaired (see “Unpairing the Monitor and Telemetry Device” on page 180).

If the monitor does not have a connection to an Information Center, you must manually end the assignment and the short range radio connection.

- 1 Select the Measurement Selection key.
- 2 In the **Measurement Selection** window, select the **Tele** pop-up key.
- 3 In the Tele device window select **Unassign Tele**.

Refer also to “Use Models With Telemetry” on page 202 for further related use modes.

Unpairing the Monitor and Telemetry Device

If the patient will no longer be monitored with the telemetry device, or only with the telemetry device and no longer with the monitor, you need to end the device pairing. After unpairing, the Information Center will receive data exclusively from the monitor or from the telemetry device:

- ◆ select the **Unpair To Mon.** SmartKey to end pairing and have the Information Center receive the measurement data from the monitor
- ◆ select the **Unpair To Tele** SmartKey to end pairing and have the Information Center receive the measurement data from the telemetry device

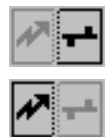

or

- ◆ use the Unpair function at the Information Center.

NOTE The **Unpair** SmartKeys and pop-up keys appear only on the monitor which is directly involved in pairing.

Functions Available When the Telemetry Data Window is Displayed

Controlling the Telemetry Device from the Bedside

You can change settings for a paired telemetry device at the monitor:

- 1 Select the telemetry data screen element
- 2 Select the **Setup Tele** pop-up key

The **Setup Telemetry** menu will appear with the settings available for the telemetry device. These will normally include: adjusting heart rate alarms, ECG size control, selecting primary/secondary lead, relearning arrhythmia, and selecting the arrhythmia analysis mode. The Equipment label of the paired device is also shown here.

Viewing and Silencing Telemetry Alarms at the Bedside

When a telemetry device is paired with the monitor, telemetry alarms will also be indicated on the monitor, in addition to the main indication at the Information Center.

If configured, a generic **Tele Alarm** message will appear in the alarm status area with standard alarm tones. The **Tele Alarm** message will have the color and * or ! coding corresponding to the severity of the alarm. The specific alarm message (for example ***HR Low**) will appear in the Telemetry Data Window.

If configured, alarms generated from a paired telemetry device can be silenced at the bedside. Either the monitor **Silence** key is configured to silence both monitor and telemetry alarms (must be configured at the Information Center) or the **Silence Bed** pop-up key will be available:

- 1 Select the telemetry screen element.
- 2 Select the **Silence Bed** pop-up key.

Depending on your Information Center configuration, the **Silence Bed** key may silence both telemetry alarms and bedside alarms.

WARNING Even when the telemetry data is not visible on the screen, you may be silencing telemetry and monitor alarms, if the Information Center and monitor are so configured.

Suspending Telemetry Alarms

When you select **Pause Alarms** or **Alarms Off** at the monitor, the alarms are off or paused for the bedside measurements. When you switch alarms off or pause alarms at the Information Center, both telemetry and monitor alarms are affected.

Refer to the Information Center Instructions for Use for more details on the Suspend/Pause alarms behavior of the Information Center and telemetry device.

Using Standby



When you select Standby mode at the monitor, the bedside goes into Standby mode but the telemetry device will continue monitoring.

Refer to the Information Center Instructions for Use for details on the Standby behavior of the Information Center and telemetry device.

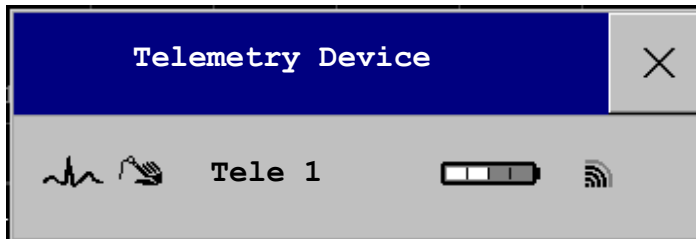
Functions Available For Devices Connected Via SRR



The **Telemetry Device** window can be opened from the **Measurement Selection** window, by selecting the **Tele** pop-up key, or via **Main Setup** -> **Telemetry Device**.

The window shows the equipment label of the assigned telemetry device and, for monitors with SRR capability, a battery status symbol  and a symbol indicating the signal quality of the SRR link .

If the monitor has a connection to an Information Center, the pop-up keys **Unpair to Mon.** and **Unpair to Tele** let you end the device pairing. After unpairing, the Information Center will receive data exclusively from the monitor or from the telemetry device.

If the monitor does not have a connection to an Information Center, or there is a pairing mismatch, the **Unassign Tele** pop-up key lets you end the telemetry device assignment and close the SRR link.

Temporarily Stopping the Short Range Radio Connection

To temporarily disable the SRR connection for this device, for example, in case of interference:

- ◆ Select the **Stop SRR** pop-up key.

This closes the SRR link and the telemetry device switches over to standard telemetry transmission. The battery status symbol will no longer be shown and the SRR quality indicator symbol will be crossed out.

To return to SRR use:

- ◆ Select the **Start SRR** pop-up key and press the Check button on the telemetry transceiver.

Setting Up Measurements

The **Setup ECG** and **Setup SpO₂T** pop-up keys give you access to the measurement setup menus. The **Measmt. Select.** pop-up key takes you directly to the Measurement Selection window where all connected measurement devices are shown.

General Telemetry-related Functions

The following functions are valid for directly and indirectly connected telemetry devices.

ECG Source Tracking at the Information Center

The Information Center continuously checks whether a valid ECG signal is coming from the monitor or the telemetry device. If you unplug the ECG patient cable from the monitor and plug it into the telemetry device, the Information Center will automatically switch to monitoring the ECG from the telemetry device. At the monitor, its own ECG measurement will be deactivated — the ECG Setup menu will no longer be accessible.

When you unplug the patient cable from the telemetry device and plug it back into the monitor again, the Information Center will switch back to monitoring the ECG from the monitor. The ECG measurement will be activated again at the monitor. Note that in this case, as the screen switches back to the monitor's own measurements, the SpO₂T measurement (if present) will no longer be displayed.

In the same way the source is tracked when a telemetry device is directly connected to a monitor, then disconnected and vice versa.

In case of ambiguity, a yellow INOP message **!!CHECK ECG SOURCE** indicates that more than one valid ECG source is active.

Synchronized Settings

If ECG is measured at the monitor, and then the patient is connected to a telemetry device for monitoring, the Information Center will use the monitor settings for the telemetry device. In general, the following settings will be synchronized:

Heart Rate	HR/Pulse Alarm On/Off, Heart Rate High/Low Limit,
ECG	Primary Lead, Secondary Lead, Va Lead ¹ , Vb Lead ¹ , Lead Placement
Arrhythmia	Analysis Mode, Asystole Threshold, Pause Threshold, VTach HR, VTach Run, PVCs/min, Vent. Rhythm, SVT HR, SVT Run, PVCs/min On/Off, Pacer not capture On/Off, Pacer not pace On/Off, Non-Sustain On/Off, Vent. Rhythm On/Off, Run PVCs On/Off, Pair PVCs On/Off, Missed Beat On/Off, Pause On/Off, R-on-T On/Off, Vent. Bigeminy On/Off, Vent. Trigeminy On/Off, Multiform PVCs On/Off, Irregular HR On/Off, SVT On/Off, Afib On/Off
ST	ST Analysis On/Off, ST Alarm On/Off, ISO Point, J point, ST point, ST Priority List, Single ST Alarm Limit, Multi ST Alarm Limit
QT	QT analysis On/Off, QT Lead, QTc High Alarm On/Off, ΔQTc Alarm On/Off, QTc High Limit, ΔQTc High Limit, QTc Formula ² , QT Baseline
SpO ₂ T	SpO ₂ Alarms on/off, SpO ₂ Alarm limits NBP Alarm Suppression On/Off, Pulse(SpO ₂) On/Off

1. Va and Vb leads are reset to default (V2, V5) if the configured Va or Vb lead for the telemetry device is not one of V1 through V6.

2. These setting will only be synchronized when the Information Center supports QT Analysis for Telemetry.

-
- WARNING**
- Not all settings are synchronized; after changing the ECG source, always check that the settings are appropriate.
 - Va and Vb leads are reset to default (V2, V5) if the configured Va or Vb lead for the telemetry device is not one of V1 through V6
-

If later the patient is disconnected from the telemetry device, and reconnected to the monitor again, any changes in the settings made in the meantime will be passed on to the monitor. In this way, settings continuity is preserved when the ECG source changes.

Settings synchronization can only take place when there is no patient information mismatch between the monitor and the Information Center. If a **Check ECG Settings** or **CHECK PAIRING INOP** appears always check that the ECG settings, especially the paced setting, are appropriate for your patient.

Enhancing Telemetry Monitoring with the Monitor

You can use a monitor without a network connection to view measurement data from a telemetry transceiver at the bedside. You can also use the monitor to make additional measurements and send this measurement data to the Information Center via the telemetry transceiver. The monitor can so be used as a mobile viewer and measurement device, and is set up to simplify the assign/unassign procedures when used with short range radio.

Monitor and Telemetry Transceiver Requirements

The monitor and the telemetry transceiver need a direct connection via a short range radio link. Not all revisions of the telemetry transceiver can be used directly with the monitor, if you connect a device that cannot be used you will see a **TELE UNSUPPORTED INOP**.

Data Sent to the Information Center

The data sent to the Information Center includes numerics from NBP, SpO₂, Pulse from SpO₂ and predictive temperature. INOPs from these measurements, battery INOPs and a general INOP generated by alarms from any other measurement (**MORE BED ALARMS**) will also be transmitted.

NOTE The monitor must be configured appropriately to support direct connection to a telemetry transceiver; refer to the *Configuration Guide* for details.

Changing Assignment to a New Telemetry Transceiver

- 1 Assign the telemetry transceiver to the monitor; see “Assigning a Telemetry Transceiver with an SRR Adapter to a Monitor” on page 179.
- 2 Make the required measurements; the data will be automatically sent to the Information Center via the telemetry transceiver.

It is not necessary to unassign the telemetry transceiver. This will happen automatically when the next telemetry transceiver is assigned. The patient is also discharged (if configured), ensuring that the measurement data is erased before data from the next patient appears. Always assign the telemetry transceiver before you start making measurements.

Trends

Trends are patient data collected over time and displayed in graphic or tabular form to give you a picture of how your patient's condition is developing. Trend information is stored in the trends database for continuously-monitored measurements, such as ECG, as well as for aperiodically-measured parameters, such as Cardiac Output.

Viewing Trends

Trend information can be viewed embedded as a screen element on specially-designed Screens, or you can open a trend window over the current Screen.

- ◆ To view trends embedded as a screen element, enter the **Change Screen** window, then select a Screen designed to show an embedded trend window.
- ◆ To open the tabular trends window, select **Main Setup > Trends > Vitals Trend**, or select the **Vitals Trend** SmartKey.
- ◆ To open the graphic trends window over the current Screen, select **Main Setup > Trends > Graph Trend**, or select the **Graph Trend** SmartKey.

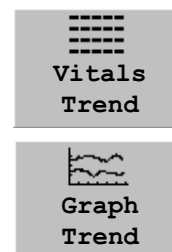



The trend windows open displaying the most recent data and are updated as new data is stored. A timescale along the bottom of the screen shows you where you are in the trends database. The preview column on the right-hand side shows the latest available measurement value. The preview column is updated every five minutes or whenever an NBP or other aperiodic measurement is completed.

A question mark (?) beside a value means that the data may not be reliable, due perhaps to an INOP condition in the measurement.

Your monitor screen may look slightly different to the examples shown in this chapter.

Trends Pop-Up Keys

When you open the graphic or tabular trends window, a selection of pop-up keys appears to let you navigate through the stored trend data and carry out trends-related tasks.

Pop-Up Keys	Selecting this pop-up key lets you....
Select Group	see a pop-up list of trend groups and select a group for viewing.
Select Interval	see a pop-up list of available data resolution settings and select the level of detail shown in the trend view.
Print	print a graphic trends report of the data in the current window. The report will use the current trend interval settings.
	move the cursor one step to the left or right to navigate through the trends database timeline.
	move the cursor one page to the left or right to navigate through the trends database timeline.
	scroll up and down the screen to see measurement trends that do not fit in the current view.
Vital Signs	open the current trend view in tabular form. The displayed time period and resolution stay the same.
Graph Trend	open the current trend view in graphic form. The displayed time period and resolution stay the same.

Viewing Graphic Trends

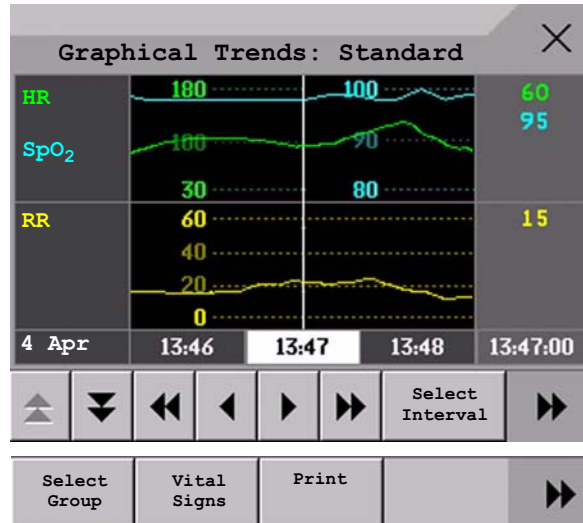

Scroll to view more pop-up keys

A cursor spanning all measurements in the trend group helps you to navigate through the trends database and shows you your current position in the database. When the cursor is moved across the time line, the values measured at the cursor time are shown in the right hand column.

In graphical trends, aperiodic measurement trends are shown as an asterisk, NBP has a special symbol.

To use the trend cursor to navigate in time through the trends database,

- 1 Select the graphical trend or the arrow pop-up keys to activate the cursor.
- 2 Use the arrow pop-up keys to move the trend cursor backwards and forwards in time, or

- Place the cursor at a specific time by touching the graph.

Viewing Vital Signs Trends

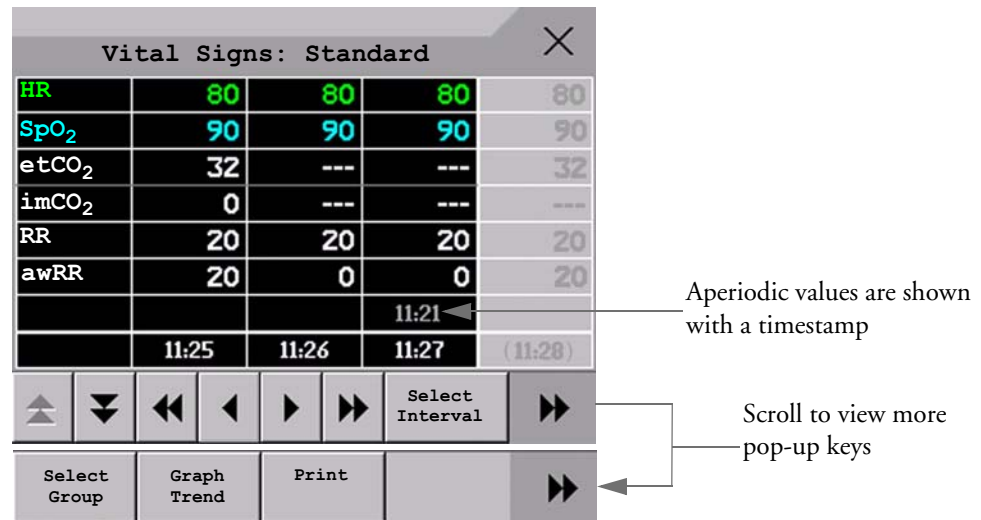

The currently-selected column is highlighted. The values can be configured to display in the same colors as the waves and numerics on the realtime display.

Any values available for display before the next scheduled update are shown in the right hand column, with a timestamp in brackets.

If more than one value is available for an aperiodic trend for a certain trend period, all measured values are stored in the database and the value closest to the timestamp is shown in the Vital Signs display marked with an arrow.

Setting Up Trends

Trends are set up in Configuration Mode. You can make temporary changes to trends settings such as trend groups, priorities, or scales in Monitoring Mode. The general settings for all Trends are under **Main Setup -> Trends**.

Settings for a single segment in graphical trends or for the corresponding trend group can be made more easily in that segment menu.

Making Segment Settings

The **Graphical Trends** window is divided into measurement segments, each of which has its own settings.

To enter the segment menu,

- ◆ select the left hand column of the segment, where the measurement label is displayed.

Expanded View

To expand the segment to fill the **Graphical Trends** window,

- ◆ in the **Segment** menu, select **Expand** to have that segment enlarged to fill the window.

In the expanded view, you can also highlight a measurement to make it more easily visible (for example when multiple ST trends are in one segment). To highlight a measurement,

- ◆ in the **Segment** menu, select **Highlight** repeatedly until the highlight is on the required measurement.

To return the segment to its original size,

- ◆ in the **Segment** menu, select **Expand** again.

Trend Scales for Segment Measurements

To change the trend scales for a measurement in the current segment:

- 1 In the segment menu, select the measurement label
- 2 Select **Upper** to change the upper limit of the scale or **Lower** to change the lower limit of the scale.

Optimum Scale

To have the monitor automatically select an optimum scale for viewing, based on current values,

- ◆ in the **Segment** menu, select **Optimum Scale**.

This scale change is temporary. When the graphical trend window is closed the scale reverts back to the setting in **Parameter Scales**.

To switch off automatic optimum scaling,

- ◆ in the **Segment** menu, select **Optimum Scale** again.

Trend Group

To add or remove measurements for this trend group or change the order of the existing measurements:

- 1 In the **Segment** menu, select **Change Group**
- 2 Use the **Add, Change, Sort Up** and **Sort Down** popup keys to change or re-order the group as required.

No. of Segments

In an embedded graphical trend window, you can select the number of segments to be displayed in the **Segment** menu:

- ◆ In the **Segment** menu, select **No. of Segments**

Trend Groups

The measurements grouped in trend groups define the trends displayed together in the Vital Signs or Graphics Trends windows and printed in trends reports and recordings. The sequence of the measurements in the group defines the order in which they are displayed. Measurements listed between dotted line separators are displayed overlapping. The trend group **All** contains all available measurements, you cannot change the order or selection of this group.

To change the selection of measurements in a trend group, either use the **Change Group** setting in the **Segment** menu or:

- 1 Select **Main Setup** -> **Trends** -> **Trend Groups**
- 2 Select the Trend Group you want to change and use the pop-up keys to **Add**, **Change**, or **Delete** the selection of measurements trended.

To temporarily change the order in which the measurements are displayed in a group,

- 1 Select **Main Setup** -> **Trends** -> **Trend Groups**
- 2 Select the Trend Group and then the measurement you want to move and use the **Sort Up**/**Sort Down** pop-up keys.

Trend Interval

The trend interval defines the resolution of trend data shown on the Screen.

To set the trend resolution, in the Vital Signs or Graphical Trends window,

- ◆ Select the **Select Interval** pop-up key and then select the required interval from the list.

Trend Priority

The monitor stores trend information for all monitored measurements, if configured to do so. If your configuration restricts the number of measurements trended, you must choose which measurements will be included. A priority list is used to select the trended measurements.

To see the measurement priority list for trending,

- 1 In the **Main Setup** menu, select **Trends**.
- 2 Select **Trend Priority**.

To add measurements to the priority list,

- 1 Select the pop-up key **Add** and choose from the pop-up list of available measurements.
- 2 Use the **Sort Up** and **Sort Down** pop-up keys to change the priority order.

Trend Parameter Scales

Parameter scales define how the trend waveform will appear on the screen and in trend reports. Separate scales can be set for adult, pediatric, and neonatal patient trends.

To change the trend parameter scales settings, either use the **Scale** setting in the **Segment** menu or:

- 1 In the **Main Setup** menu, select **Trends**.
- 2 Select **Parameter Scales**.
- 3 Select the measurement or parameter you want to change from the list.
- 4 Select the pop-up key **Change** to call up the **Scale** menu.
- 5 In the **Scale** menu, select the parameter label you want to define settings for. Select **Adult**, **Pedi**, and **Neo** and use the pop-up keypad to enter new upper and lower scale definitions.

Graphical Trend Presentation

Graphical trends and screen trends for measurements with compound values (for example ABP or CO₂) can be viewed in line or band form.

To change the presentation style,

- 1 Select **Main Setup** -> **Trends**

- 2 Select **Global Style** and choose
 - **Line** to display the trends as a continuous line
 - **Band** to fill the area between the trend lines, for example, between the systolic and diastolic pressures, with color.

This sample ABP trend shows the continuously-measured values for the systolic, diastolic and mean pressures displayed in band form.

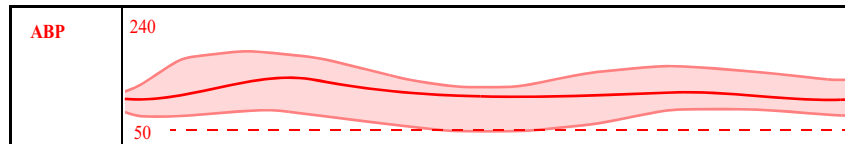

Documenting Trends

To print a Vital Signs or Graphical Trends report,

- ◆ in the **Vital Signs** or **Graph Trends** window, select the pop-up key **Print** to print a report for the trend group currently on the monitor screen.

Reports include the most recent information in the trends database and extend backwards in time according to the selected trend interval and your monitor's configuration. Trends reports can be printed on central or local printers.

Trends Databases

The trend databases store information for up to 16 measurements for up to 48 hours.

The values in the trends database are stored as measured by the monitor, they are not averaged values. The trend resolution defines how often a value is stored. In general, if more than one value is available for storage in the trends database, the most recent value is used. Some values in the trends are marked with arrows. This indicates that for this time period, more values were available and the most recent one is shown.

Example database configuration In this example, we see that the monitor stores the most recent data at the highest resolution, older data are stored at a lower resolution.

"4 hours @ 12 second resolution" means that the monitor stores trend data every 12 seconds, for the most recent four hours.

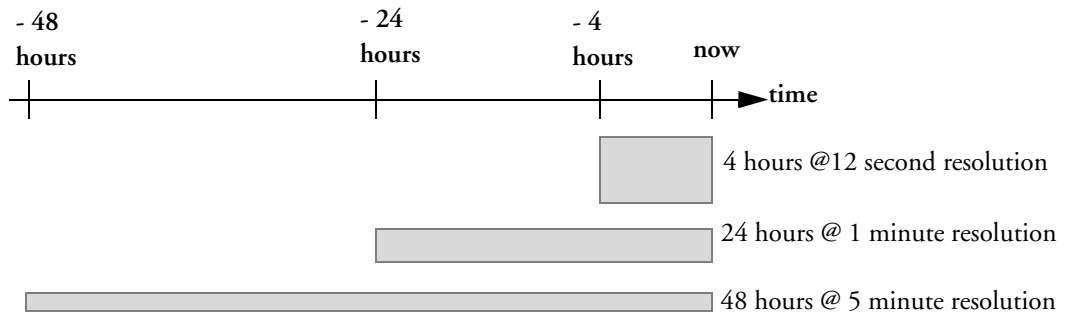

Aperiodic Trends Database

Aperiodic trends do not count toward the maximum number of trends allowed by the trend configuration. Trend data for aperiodic measurements is stored in a separate database and timestamped with the measurement time.

Trending Multiple-Value Measurements

Some measurements generate multiple values, for example invasive pressure measurements can provide systolic, diastolic, and mean values. These values are trended as separate measurements.

Screen Trends

Trends configured to display permanently on special monitor Screens are called screen trends. The selection and number of measurement waves in the Screen Trend segment depends on your monitor configuration. Screen trends are color-coded to match the measurement wave and numerics, and they can be viewed in graphical, tabular, histogram or horizon format.

If you do not see screen trends on the monitor Screen, select a different Screen, one that is configured to show screen trends. Screen trends are only available on specially designed Screens.

Screen Trend information is taken from the Trends database. If you do not see a Screen Trend for a particular measurement on the Screen, check the trend priority list to ensure that this measurement is being trended.

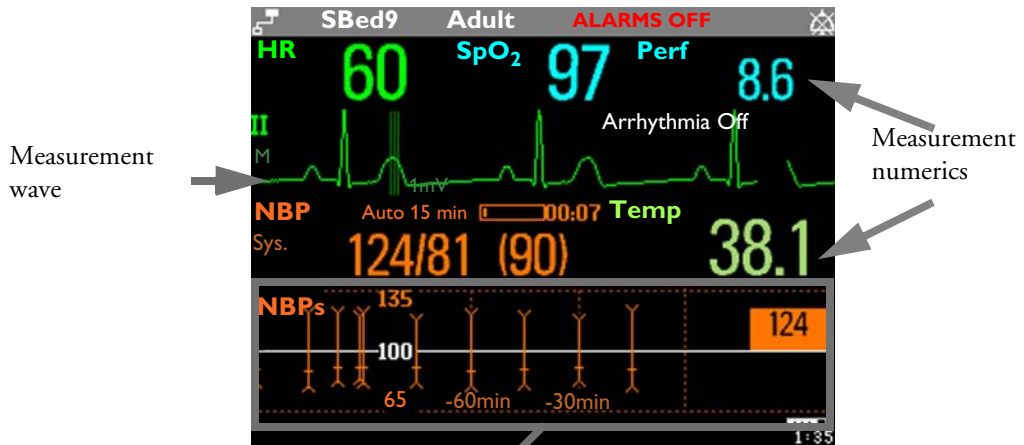

NBP graphical screen trend

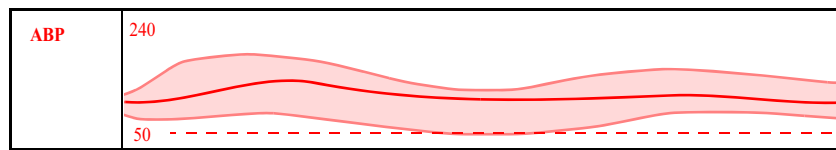

Example of other graphical screen trends: ABP

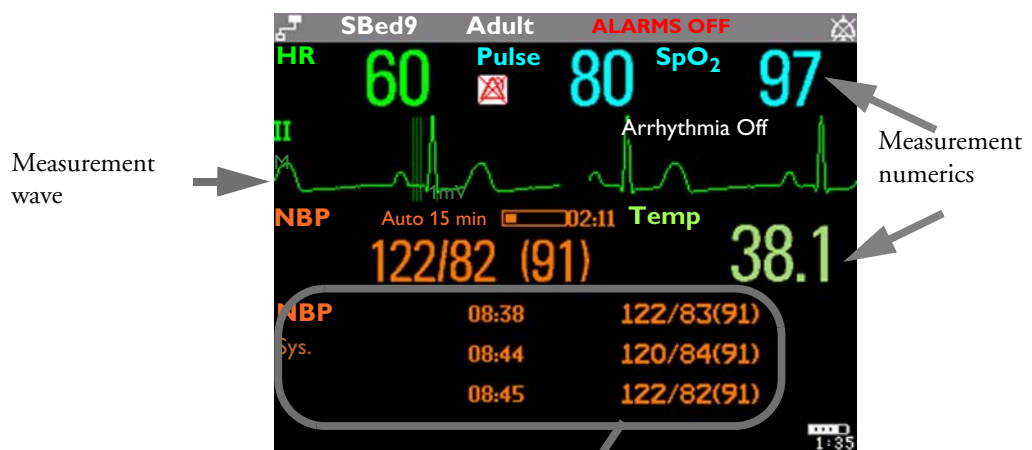

Tabular screen trend

Setting the Screen Trend Time

To set the **ScreenTrend Time** for all graphical, histogram and horizon screen trends (“global” trend time),

- 1 Select a screen trend then select **Setup Trend**, or select **Main Setup -> Trends**.
- 2 Select **ScreenTrend Time** and select the required time: 30 minutes, one, two, four, eight, or twelve hours.

This is now the Global screen trend time and defines the period of trend information shown for all screen trends.

To set a different **ScreenTrend Time** for a screen trend or a group of aligned screen trends,

- 1 Select a screen trend
- 2 Select **Change TrendTime**
- 3 Select the required trend time.

Selecting **Global** leaves the trend time set to the global screen trend time.

Changing the Selection of Screen Trends Displayed

- 1 Select the screen trend.
- 2 Select **Change Trend** and select the required trend from the list of available trends.
Select **Blank** to remove the selected trend from the Screen.

If you do not see **Change Trend** in the screen trend menu, the trend is aligned to display with the measurement wave. Changing the wave automatically changes the trend.

To display two or more screen trends overlapping,

- 1 Select the screen trend to open the screen trend menu,
- 2 Select **Change Trend -> Add Trend** and select a screen trend from the pop-up list.

Activating the Cursor for Screen Trends

To activate the cursor for Screen Trends:

- 1 Select the screen trend.
- 2 Select **Activate Cursor**

You can now use the arrow keys to move the cursor across the time line. The values measured at the cursor time are shown next to the cursor.

To de-activate the cursor,

- ◆ Press the **Main Screen** key.

Changing the Screen Trend View

- ◆ To switch between tabular, graphic, histogram and horizon views, select the screen trend then select **Change View** and select the required view.

Tabular View

Aperiodic measurements such as NBP, can be viewed as a screen trend in tabular form. The measured values and their timestamps are shown, with the measurement label.

NBP	08:38	122/83(91)
Sys.	08:44	120/84(91)
	08:45	122/82(91)

Horizon View

The horizon view presents trend information superimposed over a defined baseline or base range. This helps you visualize changes in your patient's condition since the baseline was set.

The horizon view is made up of:

- a horizon, drawn in white, as a reference point or baseline to help you visualize changes in your patient's condition. The horizon can be set to represent your patient's current condition, or a target condition and can be a single value or a range.
- a graphical trend, displaying patient data for the set TrendTime (1).
- a trend indicator arrow, indicating how the patient trend has developed in the set time period (10 minutes, 5 minutes or 2 minutes) (2).
- a deviation bar, showing how the currently measured value deviates from the set horizon (3). The height of the deviation bar is an indication of the extent of the change in your patient's condition relative to the (horizon) baseline.

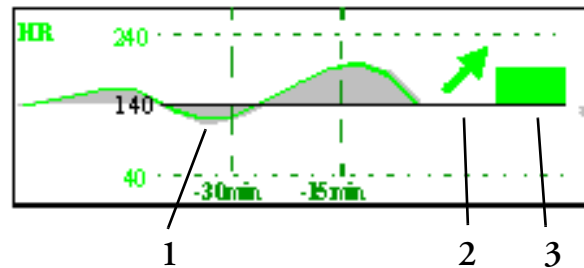

Your monitor may not be configured to show all elements of the screen trend horizon view.

Setting the Horizon

The horizon is the reference value to which deviations in the measurements are compared.

- 1 To set the horizon, select the horizon trend
- 2 Select
 - **Set High Horizon** to select the upper horizon value. If the high and low horizon values are the same, the horizon is a baseline - if the values are different the horizon is a range.
 - **Set Low Horizon** to select the lower horizon value.
 - **Auto Horizon** to set the horizon for the selected horizon trend to the currently-measured value
 - **Auto All** to reset the horizon for all horizon screen trends to the currently-measured values
 - **Set Horizon** to set the horizon to a specific value from a pop-up list.

Setting the Horizon Trend Scale

The horizon trend scale is defined with respect to the horizon. If your horizon is set to 100 and you select 20 as the horizon scale delta, the upper limit of the horizon scale will be 120 and lower limit 80.

To set the horizon trend scale delta,

- 1 Select the horizon trend.

- 2 Select **Set Scale Delta** and select a value to define the distance between the horizon and the upper and lower scale limits.

Be aware that changing the horizon trend scale can change the angle of the trend indicator, without the patient's condition having changed.

If a measurement exceeds the outer limits of the scale, the wave will be clipped and you must either reset the horizon or the horizon trend scale to display the values outside the scale limits.

Setting the Time Period for the Trend Indicator Arrow

The time period for which the trend indicator arrow can be set in the Trends window.

- 1 Select **Main Setup > Trends**
- 2 Select **HorizonArrowTime**.
- 3 Select 10, 5 or 2 minutes.

Recording

Central Recording For central recording from the bedside, your monitor must be connected via a network to an Information Center. You can use either the M1116B 2-Channel Recorder or the standalone M3160A 4-Channel Recorder. See the documentation supplied with the Information Center for information on the 4-Channel Recorder.

Starting and Stopping Recordings

The recordings pop-up keys let you start and stop recordings. Select the **Main Setup** SmartKey then select **Recordings** to call up the line of pop-up keys. Scroll right or left to see any pop-up keys not displayed.

Delayed Recordng	RT A Recordng	RT B Recordng	Select Waves	Setup Recordng	Stop all Recordng	
---------------------	------------------	------------------	-----------------	-------------------	----------------------	--

Recording Without a Template

To record without a preconfigured template, selecting the waves you require,

- 1 Select the **Main Setup** SmartKey then select **Recordings**.
- 2 Select the pop-up key **Select Waves**,
- 3 Use the pop-up keys to choose up to three measurement waves to be printed on the recording. If you want fewer than three waves on the recording, select the waves you want then select the **Continue** pop-up key.
- 4 Select one of the recording speed pop-up keys to set the required recording speed.
- 5 Select the **Start** pop-up key to start the recording.

Select Waves recordings use default values for any recorder settings not defined: runtime is continuous, overlapping is set to non-overlapping.

Overview of Recording Types

	Delayed	Alarm		Realtime (RT)
Type of recording	manual	automatic, triggered by defined alarm conditions		manual
Recording Destination	central	central	printer	central
Information recorded	from the start trigger minus the delay time	from the start trigger minus the delay time	N/A	from the start trigger
Number of waves	up to 2	up to 2	N/A	up to 2
Speed	50, 25, 6.25 mm/sec	25 mm/sec	N/A	50, 25, 6.25 mm/sec
Runtime	N/A	N/A	N/A	continuously
Stops	automatically	automatically	N/A	manually
Delay Time	10, 15 seconds	10, 15 seconds	N/A	none
Overlap	Off On (up to 2 waves)	Off On (up to 2 waves)	N/A	Off On (up to 2 waves)

N/A = not applicable

Creating and Changing Recordings Templates

To save you defining recording settings each time you start a recording, you can create templates for commonly-used types of recordings in the **Setup Recording** menu. You can create templates for one delayed recording, one alarm recording and two realtime recordings (**Realtime A** and **Realtime B**).

Changing recordings templates changes the settings that will be used each time a recording of this name is triggered.

- 1 Select the **Main Setup** SmartKey to call up the **Main Setup** menu.
- 2 Select **Recordings**.
- 3 Select the **Setup Recording** pop-up key to enter the **Setup Recordings** menu.
- 4 Select the name of the template you want to create or change. Each recording name is linked to a recording type: delayed, alarm, and realtime. Recording names can be changed in the monitor's Configuration Mode.
- 5 Design the template by selecting each menu item and entering the information for the template.
 - **Recorder:** choose which recorder the recording will print to (Central 2-Ch. or Central 4-Ch. recorder, or a printer (for realtime reports in alarm recording only)).
 - **Channels 1 - 4:** choose which waveform to record in each channel.

In addition to the currently available waves, you can choose from several other settings which make an automatic allocation when the recording starts:

- **Alarm Par** will always record the measurement in alarm in the chosen recorder channel
- **Primary Lead** will always record the current primary lead in the chosen recorder channel

- **Secondary Lead** will always record the current secondary lead in the chosen recorder channel
- **Overlap**: define whether the recorded waveforms will be printed overlapping or beside each other.
- **Speed**: choose the recording print speed.
- **Delay Time**: Delayed recordings start documenting on the recorder strip from a pre-set time before the recording is started. This interval is called the “Delay Time” and can be set as specified in the table on page 200. This setting can only be changed in Configuration Mode.
- **Runtime**: see how long this type of recording is configured to run. This setting can only be changed in Configuration Mode. Continuous recordings run indefinitely.
- **Central Config** - if available in the **General** menu, select this setting to use the recording settings made for the centrally-connected recorder.

Maintaining Recording Strips

Recording ink sometimes fades when covered with transparent tape. Avoid covering any part of a recording that is clinically relevant (annotation or waveforms) when taping a recording strip to a patient record or other patient documentation.

Recorder Status Messages

CAUTION If no central recorder is available, alarm recordings may be lost. The message **No alarm recording available** will be displayed. This message is not shown if **Printer** is configured as the alarm recording destination.

Recorder Status Messages	Explanation
<Recording name> running	The named recording is currently running.
No alarm recording available	No recorder available. Alarm recordings will be lost. Try configuring Printer as the alarm recording destination.
Central Recorder out of paper	The named recorder is out of paper.
Central Recorder door open	The door of the specified recorder is open.

Printing Patient Reports

Starting Report Printouts

Most patient reports can be printed by selecting **Main Setup - > Reports** (or the **Reports SmartKey**) and then selecting the report name in the top half of the **Reports** menu. Report names are shown only for reports that have been correctly set up.

Data from the time of the print request is printed, even if the print job is delayed in the printer queue.

Your monitor can also be set up to automatically print all reports when a matching printer is available. To set this up

- 1 Select **Main Setup - > Reports**
- 2 Select **Auto Print Dbs.**
 - **Always** will print all reports when a matching printer is available.
 - **Host only** will print the reports stored on the host monitor when a matching printer is available. Reports stored in the companion database (shown in grey on the Reports Job List) must be manually sent to the printer. See “Checking Report Status and Printing Manually” on page 207.
 - **Never** will print no reports automatically; all reports stored in the host or companion database must be manually sent to the printer. See “Checking Report Status and Printing Manually” on page 207.

Depending on availability, reports can be printed on printers connected to the Information Center, an external PC-based print server or into the print database. Print jobs stored in the database are automatically printed when a print device with a matching paper size becomes available.

Print jobs in the print database are **not deleted** after a patient discharge. A new patient can be admitted and their reports are saved in addition to the previous reports. Always admit your patient so that reports can be clearly assigned to a patient.

Report types	Report contents	How to start printing reports
Vital Signs Report	depends on selected trend group, data resolution, and period.	In the Vital Signs window, select Print
Graphic Trends Report		In the Graphic Trends window, select Print
ECG Reports	Depends on format selected	Select the ECG Report SmartKeys, if configured
ST Map Report	ST data in a transversal and/or horizontal multiaxis diagram,	In the ST Map window, select Print .

Report types	Report contents	How to start printing reports
Alarm Limits Report	Graphic and numeric report of all current alarm limits	In the Alarm Limits window, select Print Limits
Realtime Reports	Patient data and numerics, and either: all displayed waves OR all measured waves OR all measured RT waves	Select the Realtime Reports SmartKey, if configured
Battery Report	Battery serial number, information on the currently-measured and potential charge status of the battery	In the Battery Status window, select Print Status .
Central Report A/B/C	These are reports configured at the Information Center. Monitors connected via the IntelliVue Instrument Telemetry wireless network can have these reports available.	In the Main Setup select Reports then Central Report A, B or C .

Stopping Reports Printouts

- ◆ To stop Reports printing, in the **Reports** menu, select
 - **Delete Report** to stop the current print job
 - **Delete All Repts** to cancel all queued report printouts
 - **Scheduled Rep.** to toggle to **Off** and switch off scheduled reports.

Setting Up Reports

ECG report layout and Auto Reports settings must be defined in Configuration Mode.

The content you define in the individual **Setup Reports** menus will be used in all reports of this type: for example, if you set a print speed of 50 mm/sec in the **ECG Reports** menu, every ECG report will be printed at this speed, irrespective of format.

Setting Up ECG Reports

The settings you choose in the **ECG Reports** menu apply for all ECG reports printed. To set up ECG Reports,

- 1 Select **Main Setup** -> **Reports** -> **ECG Reports**. Note the report layout configured for your monitor, either Internat. or Cabrera. This setting is inactive (“grayed-out”) in Monitoring Mode and can only be changed in Configuration Mode.
- 2 Select **ECG Gain** and set the required ECG Gain to define how ECG waves will appear on the ECG report printouts.
- 3 Select **Speed** and select the report print speed.
- 4 Select **Annotation** and toggle to **On** if the printed ECG wave should be annotated with beat labels or not. See the chapter on ECG for a list of beat labels. Pace pulse marks are automatically printed beside the wave for paced patients.

Setting Up Vital Signs and Graphic Trend Reports

The settings you choose in the **Vital Signs Report** and **Graphical Trend Report** menus apply for all Vital Signs and Graphic Trend reports printed.

To set up Vital Signs and Graphic Trend reports,

- 1 Select Main Setup -> Reports -> Vital Signs Rep. or Graph Trend Rep.
- 2 Select Trend Group and select the group you want to print on the report. The groups available depend on your monitor's trend configuration.
- 3 Select Period and select the period of time for which trend data should be printed on the report. If **Automatic Period** is configured to **On**, all trend data for the current patient will be printed, irrespective which trend period is selected.
- 4 Select Interval (Vital Signs Reports only) and select the resolution of the trend data printed on the report,

Setting Up Auto Reports

Auto Reports print automatically when a specified trigger occurs. There are two types of Auto Reports: Scheduled Reports, which print at predefined intervals, and End Case Reports, which print when a patient is discharged using the End Case function. An Auto Report can be both a Scheduled Report and an End Case report.

To set up Auto Reports,

- 1 Select Main Setup -> Reports -> Auto Reports and select the Auto Report you want to set up (A, B, C, or D).
- 2 Select **Report** and assign a report type to the Auto Report.
- 3 Select **End Case Report** and toggle to **On** if you want the selected report to print automatically when you select **End Case** to discharge a patient.
Toggle **End Case Report** to **Off** if the report is a Scheduled Report only.
- 4 Select **Scheduled Rep.** and toggle to **On** if you want the selected report to print at predefined intervals, starting at a predefined time of day. The start time you set applies for every following day. For example, if you set a start time of 07:00 and a repeat time of six hours, the first report will print at 07:00 every day, the next at 13:00 and so on.
 - To set the time of day at which you want the report to print every day: select **Start Hour** and **Start Minute** and select the required time from the pop-up list
 - To set the time interval in minutes between two scheduled reports: select **Rep. Freq. (Hr)** and **Rep. Freq. (Min)** and select the time interval from the pop-up list.
 If you are setting up an end case report, these settings will be inactive ("grayed-out").
Toggle **Scheduled Rep.** to **Off** if the report is an End Case Report only.
- 5 Repeat the procedure for all Auto Reports you want to set up.
All Auto Reports or Scheduled Reports set to **On** print automatically at the predefined trigger.

Be aware that the monitor's memory for reports is limited. If the memory is full, Auto Reports cannot be printed and the information may be lost.

Setting Up Individual Print Jobs

To adjust the appearance of individual print jobs, in the **Reports** menu,

- 1 Select **Main Setup** -> **Reports** -> **Setup Reports** to enter the **Setup Reports** menu.

- 2 Select **Report** and then select the report you want to set up.
- 3 Select **Report Type** and then select the reports template you want the report selected in Step 2 to use. The selection of templates listed depends on the report type selected.
Each template includes patient demographic data, and each Realtime Report also includes alarm and INOP information. In addition, the templates include:
 - VisibleWaves:** all waves currently visible, in the order they appear on the screen.
 - All Waves:** all measured waves,
 - RT Waves:** all currently measured realtime waves, according to the monitor's priority list.
 - Vital Signs:** trend information in tabular form.
 - Graph Trend:** trend information in graphic form.
 - ECG3X4, ECG6X2, ECG12X1, ECG4X2, ECG8X1, ECG12X1 (2P):** ECG reports.
 - Alarm Limits:** a list of all currently set alarm limits.
- 4 Select **Report Size** to set the paper size to be used for the report: **Unspecified** to use the default size for the template chosen, **Universal, A4, Letter, LrgUniversal, A3,** or **Ledger**. The list of available sizes depends on the report type selected.
- 5 Select **Orientation** to set the orientation of the report printout: **Unspecified** to use the default size for the template chosen, **Landscape** or **Portrait**.
- 6 Select **Target Device** and choose which printer the print job will be sent to: **Unspec.** to use the default printer, or choose from the list of printer names defined at the Information Center or in the monitor's Configuration Mode (for example, **Remote 1** or **Database**).

Some settings may be inactive ("grayed-out") in this menu for reports that can only be started in a special window.

Checking Printer Settings

The printer settings for your monitor are defined in Configuration Mode. The printer settings **Paper Size, Resolution, Color Support,** and **Duplex Option** for the active printer are visible but inactive ("grayed-out") in the **Setup Printers** menu. When **Print Database** is selected as active printer only the **Paper Size** setting will be shown.

- ◆ To enter the **Setup Printers** menu, in the **Reports** menu, select **Setup Printers**.

Printing a Test Report

A test report can be printed in Configuration mode, refer to the Service Guide for details.

Switching Printers On Or Off for Reports

You can enable or disable printer status to switch individual printers on or off for report printouts.

- 1 In the **Setup Printers** menu, select **Printer** and then select the name of the device you want to switch on or off for Reports printing from the pop-up list.

- 2 Select **Printer Status** to toggle between the settings **Enabled** and **Disabled**. If you set this to **Disabled**, no reports will be printed to the named printer.
If the monitor detects that no printer of a particular type is available, the **Enabled/Disabled** setting will automatically be set to **Disabled** and “grayed out”.

Dashed Lines on Reports

If a section of a wave on a report is drawn with dashed lines, this tells you that a setting that affects the appearance of the wave on the screen was changed while the report was printing.

For example, if you change the wave scale while a report is printing, the wave scale and wave size are changed immediately on the monitor screen and on the report. To indicate that the scale information printed at the beginning of the report no longer matches the currently used scale, the wave will be printed using dashed lines, starting from the moment the change took place.

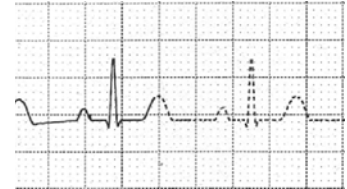

Some examples of settings that cause dashed lines in reports if changed during printing are: Filter mode, ECG lead placement, wave scale, measurement unit, paced/non-paced setting, and measurement mode. Note that as ECG waves are drawn with a fixed gain on reports (either 10 mm/mV or 20 mm/mV), changing the ECG wave scale will not cause dashed-line reports.

To avoid dashed lines on reports, wait 15 seconds after changing a setting before you trigger a report.

Unavailable Printer: Re-routing Reports

If you send a report to be printed on a printer that is not available, for example, because it has run out of paper, this print job is suspended and stored in the monitor's memory.

If the target device of this print job was set to **Unspecified**, the monitor will periodically try to resend the print job to the first printer listed in the **Setup Printers** menu under **Printer** that is set to **Enabled** and that has paper of the correct size.

To allow the report to print, you must either solve the problem with the target printer, or re-route the print job to another printer with paper of the correct size. To re-route a print job,

- ◆ Enable the new target printer by selecting it in the **Setup Printers** menu and toggling to **Enabled**. As the monitor tries to send the report to the printers in the order they are listed, you must make sure that all the printers above the new target printer are disabled.

If the target device of the print job was set to a specific printer, re-routing is not possible.

Checking Report Status and Printing Manually

A list of all print requests which are waiting, printing or stored can be viewed in the Reports Job List. To view the list,

- ◆ in the **Reports** menu, select **Reports Job List**.

The following information is displayed for each print request:

- Report title
- Patient name (except for system reports such as the battery status report)

- Request date and time
- Report paper format
- Job status: Preparing, Printing, Waiting, In Database, In Companion, Retry, Cancelling, Error

Individual reports can be deleted from the list with the **Delete Report** key, and all reports with the **Delete All Reps** key.

CAUTION The reports job list includes privacy information, in the form of the patient name with the related report title and date. It is advisable to provide controlled access to this data to ensure confidentiality.

Printing Manually

Those jobs shown in black will be printed automatically when a matching printer is available. If the **Auto Print Dbs** setting is **Host only** or **Never**, some or all reports will not be printed automatically and will be shown in grey. Any jobs shown in grey must be printed manually; to do this,

- 1 In the **Reports Job List**, select the required report
- 2 Select **Print Report**.

Selecting **Print All Reps**. will send all reports to the printer.

Printer Status Messages

Printer Status Message	Possible causes and suggested action
Print job queued <Printer name>	The report has been placed in the queue for the named printer.
Print job can't queue;queue full	The printer queue is full and the monitor cannot accept another report request. Wait until some more reports have been printed, then try again, OR A report has been triggered that uses a paper size unavailable with the target printer. Try another printer, if available, or change the paper size of the print request.
Cancelling all print jobs	Stop All Reports has been selected in the Report menu, OR The Operating Mode has been changed from Monitoring Mode to Demonstration or Service Mode.
Cancelling the active print job	The current report is being cancelled as the result of a user request.
Deleted N print jobs;discharge	When a patient is discharged, all queued reports are cancelled except those stored in the print database. " N " is the number of reports cancelled.
Deleted N print jobs; hotstart	The monitor has restarted and all report requests have been cancelled except those stored in the print database. " N " is the number of reports cancelled.
Print failed;No report configurd	A report has been triggered which has not been correctly set up. Enter the setup menu for the report type to set up the report.
Printing on <Printer name>	A report is in progress, or the monitor is waiting for the central printer to accept the print job.

Printer Status Message	Possible causes and suggested action
NoPrinter <Printer name>;job susp	The chosen device is unavailable. Check that the printer is properly connected and that paper is available. The requested report will start printing when the printer becomes available.
Print Database full->job suspnd.	The requested report does not fit into the print database. You can select another printer to print the report (see “Unavailable Printer: Re-routing Reports” on page 207). Alternatively you can delete another report from the Reports Job List (using the Stop report key) to create space for your report.
Job <Printer name> fail;	A report cannot be started on the requested printer. One of three reasons will also be shown in the status message: <ul style="list-style-type: none"> • data requisition error (data error) - an internal error has caused data required for the report to be unavailable, try starting the report again. • printer unavailable (no printer)- make sure the printer is plugged in, switched on, and has paper loaded. • data unavailable (no data) - the connected X2 or MP5 has been removed before the data for the report was transferred.
Print job on <Printer name> done	The report has been printed.

Sample Report Printouts

Each report header contains the patient’s bed label, last name and first name, middle name (if there is enough space) the patient ID, the date and time, and the name of the report. The report footer contains the hospital label and page number, and the last page contains a note to mark the report end.

The monitor may be configured to leave a space on the top left or right of the report printout to enable you to stick a patient address label on it. This setting is called the Addressograph and it can only be changed in the monitor’s Configuration Mode.

Alarm Limits Report



Measurement labels, with alarms off symbol where alarms are switched off

Graphic view of current alarm limits in relation to currently monitored measurement value

Realtime Report

Patient demographic information, time stamp

NBed6		Doe, John		123456789-P1	
Realtime Report				19 Apr 07 15:59:54	

Active Alarms and INOPs, followed by vital signs

Patient Cat.: Adult	Date of Birth: 19 Nov 1963	Patient Cat.: Adult
Paced: No	Age: 43 years	Paced: No
Gender: Male	Height: 69 in	

**ABPs HIGH		ST-aVR	0.0 mm	ST-V6	0.0 mm
SpO2 NON-PULSAT .		ST-aVL	0.0 mm	SpO2	-?-%
HR	60 bpm	ST-aVF	0.0 mm	Pulse	-? - bpm
PVC	0 /m	ST-V1	0.0 mm	Perf	-? -
ST-I	0.0 mm	ST-V2	0.0 mm	NBP	
ST-II	0.0 mm	ST-V3	0.0 mm	Pulse	
ST-III	0.0 mm	ST-V4	-0.1 mm	ABP	119/81 (93) mmHg
		ST-V5	0.0 mm	ST-V5	0.0 mm

Measurement waves section

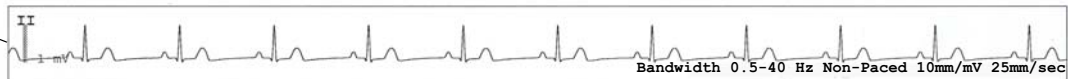

ECG Reports

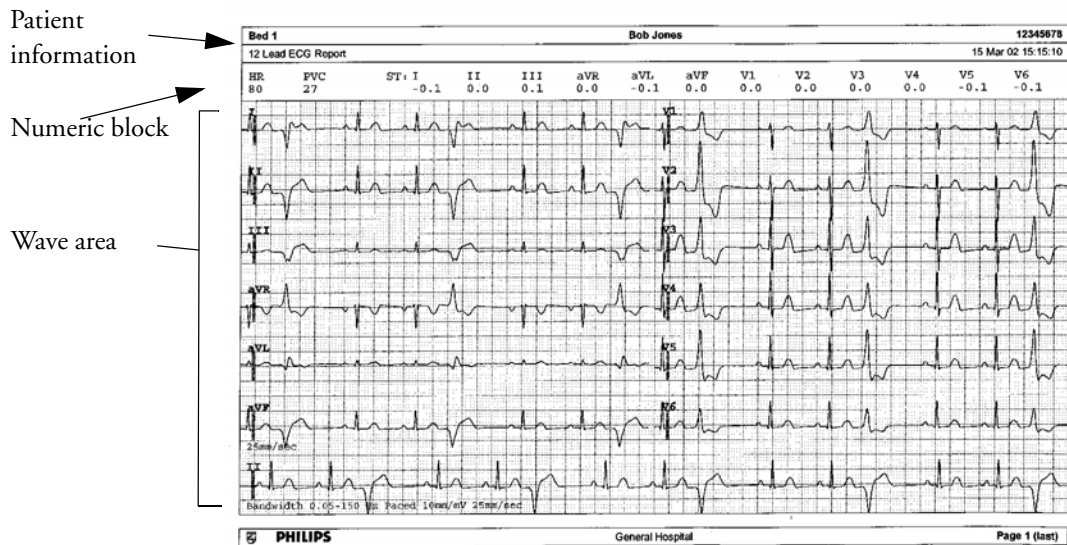

Below the header on ECG Reports, the numeric block shows the current HR, PVC, and ST values. The wave area shows the printed waves for all available ECG leads. A 1 mV calibration bar is printed at the beginning of each wave. With the 3X4, 6X2, and 2X4 formats, a rhythm stripe prints a longer section of the ECG wave from the primary ECG lead for ECG rhythm evaluation. The ECG signal bandwidth, the patient's paced status, the ECG gain, and the print speed are printed at the bottom of the wave area. Pace pulse marks are automatically printed beside the wave for paced patients. Beat labels can be set to print on the rhythm stripe. The 12X1 (2P) format prints the report over two pages.

ECG Report type	Available Formats	Available Paper Sizes
12-Lead ECG	3X4 landscape	A4, letter, A3, ledger
	6X2 landscape	A4, letter, A3, ledger
	12X1 portrait	A4 and letter only
	12X1 landscape	A4, letter, A3, ledger
	12X1 (2P) landscape	A4, letter (2 pages)
Multi-lead ECG	2X4 landscape	A4, letter, A3, ledger
	8X1 portrait	A4 and letter only
	8X1 landscape	A4, letter, A3, ledger

Other Reports

See the sections on Trends for other example reports.

Care and Cleaning

Use only the Philips-approved substances and methods listed in this chapter to clean or disinfect your equipment. Warranty does not cover damage caused by using unapproved substances or methods.

Philips makes no claims regarding the efficacy of the listed chemicals or methods as a means for controlling infection. Consult your hospital's Infection Control Officer or Epidemiologist. For comprehensive details on cleaning agents and their efficacy refer to "Guidelines for Prevention of Transmission of Human Immunodeficiency Virus and Hepatitis B Virus to Health Care and Public-Safety Workers" issued by the U.S. Department of Health and Human Services, Public Health Service, Centers for Disease Control, Atlanta, Georgia, February 1989. See also any local policies that apply within your hospital, and country.

General Points

Keep your monitor, cables and accessories free of dust and dirt. After cleaning and disinfection, check the equipment carefully. Do not use if you see signs of deterioration or damage. If you need to return any equipment to Philips, decontaminate it first.

Observe the following general precautions:

- Always dilute according to the manufacturer's instructions or use lowest possible concentration.
- Do not allow liquid to enter the case.
- Do not immerse any part of the equipment or any accessories in liquid.
- Do not pour liquid onto the system.
- Never use abrasive material (such as steel wool or silver polish).
- Never use bleach.

WARNING If you spill liquid on the equipment, battery, or accessories, or they are accidentally immersed in liquid, contact your service personnel or Philips service engineer. Do not operate the equipment before it has been tested and approved for further use.

Cleaning the Monitor

Clean with a lint-free cloth, moistened with warm water (40°C/104°F maximum) and soap, a diluted non-caustic detergent, tenside, ammonia- or alcohol-based cleaning agent. Do not use strong solvents such as acetone or trichloroethylene.

Take extra care when cleaning the screen of the monitor because it is more sensitive to rough cleaning methods than the housing. Do not permit any liquid to enter the monitor case and avoid pouring it on the monitor while cleaning. Do not allow water or cleaning solution to enter the measurement connectors. Wipe around, not over, connector sockets.

CAUTION To clean the touch-enabled display, disable the touch operation by switching off the monitor during the cleaning procedure, or by pressing and holding the Main Screen key for two seconds. Press the Main Screen key again to re-enable touch operation.

Recommended cleaning agents are:

Tensides (dishwasher detergents)	Edisonite Schnellreiniger [®] , Alconox [®]
Ammonias	Dilution of Ammonia <3%, Window cleaner
Alcohol	Ethanol 70%, Isopropanol 70%, Window cleaner

Disinfecting the Monitor

CAUTION Solutions: Do not mix disinfecting solutions (such as bleach and ammonia) as hazardous gases may result.

Hospital policy: Disinfect the product as determined by your hospital's policy, to avoid long term damage to the product.

Clean equipment before disinfecting. Recommended types of disinfecting agents are:

Base	Approved Agents
Alcohol	Ethanol up to 70% 1- and 2- Propanol up to 70%
Aldehyde	Glutaraldehyde up to 3.6%

Sterilizing the Monitor

Sterilization is not recommended for this monitor, related products, accessories or supplies unless otherwise indicated in the Instructions for Use that accompany the accessories and supplies.

Cleaning, Sterilizing and Disinfecting Monitoring Accessories

To clean, disinfect and sterilize reusable transducers, sensors, cables, leads, and so forth, refer to the instructions delivered with the accessory.

Cleaning Batteries and the Battery Compartment

Wipe with a lint-free cloth, moistened with warm water (40°C/104°F maximum) and soap. Do not use strong solvents. Do not soak the battery.

Using Batteries

When monitoring a patient, one Philips M4607A rechargeable Lithium Ion battery must **always** be inserted into the battery compartment on the right side of the monitor. This applies even when you are running the monitor from the external power supply. The battery seals the battery compartment, thereby preventing the ingress of fluids or foreign bodies. A severe yellow INOP (! ! **INSERT BATTERY**) will be issued if the monitor is connected to AC mains without a battery fully inserted in the battery compartment. This INOP will persist until a battery is loaded.



Battery compartment

To use the monitor with battery power, disconnect the MSL cable (connecting the external power supply) from the monitor.

You can switch between battery-powered and mains-powered (AC) operation without interrupting monitoring.

The battery recharges automatically when the monitor is connected to the external power supply (M8023A).

Battery Power Indicators

The battery LED and battery status information on the Main Screen, in combination with INOP messages and prompts, help you keep track of the battery power status. The indicators always show the remaining capacity in relation to the battery's actual maximum capacity, which may lessen as the battery ages. You can see the actual capacity in the **Battery Status** window.

Battery LED

The battery LED on the front panel of the monitor is indicated by a battery symbol.



Battery LED Colors	If the monitor is connected to the external power supply (M8023A), this means	If the monitor is running on battery power, this means
Yellow	battery charging	
Red, flashing		less than 10 minutes power remaining
Red, flashes intermittently	battery or charger malfunction	battery malfunction

The battery LED is yellow during charging and switches off when the battery is charged.



Battery Status on the Main Screen

Battery status information can be configured to display permanently on all Screens. It shows the status of the battery, with the battery power remaining and, when the battery is not charging, an estimate of the monitoring time this represents.



Battery power gauge: This shows the remaining battery power. It is divided into sections, each representing 20% of the total power. If three sections are filled, as in this example, this indicates that 60% battery power remains. If no battery is detected, a blank battery gauge marked with a flashing red X is displayed. If no data is available from the battery, a question mark is shown in the gauge.

Battery status/malfunction indicator: Normal battery function is indicated by the battery power gauge, together with the remaining operating time, on the Main Screen. You are informed of problems or changes in the status of the battery by the battery status/malfunction indicator. This consists of a blank battery gauge containing a symbol. If the symbol is red, this indicates a critical situation. You can check the specific cause of the problem by looking at the symbol(s) displayed in the **Battery Status** window (see page 219).

Battery status indicator		Battery malfunction indicator	
	<p>Alternates with the battery gauge on the Main Screen.</p> <p>Check in the Battery Status window to see which status symbol is displayed to identify the cause.</p>		<p>The red ! flashes. Critical battery situation or malfunction. Check in the Battery Status window to see which malfunction indicator is displayed, or refer to the INOP, to identify the cause.</p>
			<p>Indicator for missing battery (flashing red X). An INOP is issued when the battery compartment is empty, and the monitor is connected to AC mains via the external power supply. This !! INSERT BATTERY INOP is suppressed for 15 seconds while the monitor is connected to AC mains power, allowing you sufficient time to load a new battery. After silencing, the INOP cycles every 10 seconds until a battery is loaded.</p>

Monitoring Time Available: While the monitor is running on battery power, a time is displayed below the battery power gauge. No time is displayed when the monitor is running on AC mains power via the external power supply (M8023A). This is the estimated monitoring time available with the current battery power. Note that this time fluctuates depending on the system load (the display brightness and how many measurements you carry out), the age of the battery, and the remaining capacity of the battery.

Battery Status Window

- ◆ To access the **Battery Status** window and its associated pop-up keys, select the battery status information on the Screen, or select **Main Setup -> Battery**.

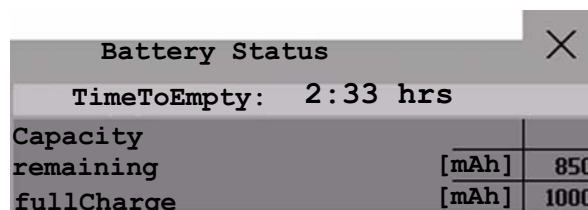









Capacity, remaining tells you how much power is left in the battery.

Capacity, fullCharge tells you how much power the battery can hold when fully charged.

TimeToEmpty tells you approximately how long you can continue to use the monitor with this battery. Note that this time fluctuates depending on the system load (the display brightness and how many measurements you carry out), the age of the battery, and the remaining capacity of the battery.

TimeToFull is shown in place of **TimeToEmpty** if the monitor is connected to mains power via the M8023A external power supply, and tells you how much time is left until the battery is charged to 90%. You can use the M8043A Smart Battery Charger to charge the batteries externally.

Battery status/malfunction symbols: If a problem is detected with the battery, an INOP may be issued, and the following symbols are displayed in the **Battery Status** window, where they may be accompanied by a battery status message providing more details. Messages appear in the line where **TimeToFull/TimeToEmpty** is shown. Symbols indicating critical situations are colored red.

Battery status symbols		Battery malfunction symbols	
	battery is empty		(red) incompatible battery
	battery not charging as the temperature is above or below the specified range		(red) battery malfunction
	battery requires maintenance		(red) battery has no power left
	charging stopped to protect the battery		(red) battery temperature too high

Printing Battery Reports

To print the information in the **Battery Status** window on a connected printer,

- 1 Select the battery status information on the Screen to open the **Battery Status** window
- 2 Select the **Print Status** pop-up key.

Checking Battery Charge

- ◆ To check the charge status of a battery in a monitor, see the battery power gauge on the Screen or select **Main Setup** -> **Battery** to enter the **Battery Status** window.
- ◆ To check the charge status of a battery that is not connected to a monitor or battery charger, press the black dot marked "PUSH" on the labeled side of the battery. The remaining charge is indicated by four LEDs on the electronic fuel gauge directly above the dot. Each LED represents 25% of charge. If all LEDs are lit, the battery is fully charged, if only one LED is lit, 25% or less charge is left.

Replacing a Battery

To replace the battery,

- 1 Press the battery eject button. This releases the battery.

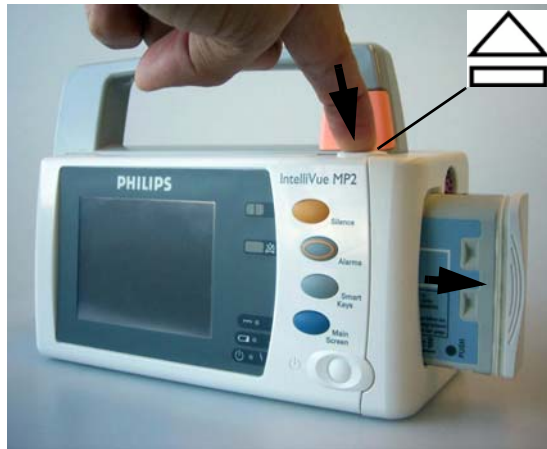

Battery eject button

The INOP **!! INSERT BATTERY** is suppressed for 15 seconds, allowing you sufficient time to load a new battery.

- 2 Remove the battery from the compartment.
- 3 Slide the new battery into position with the contacts facing downwards. It should ‘click’ into position when it is fully inserted.

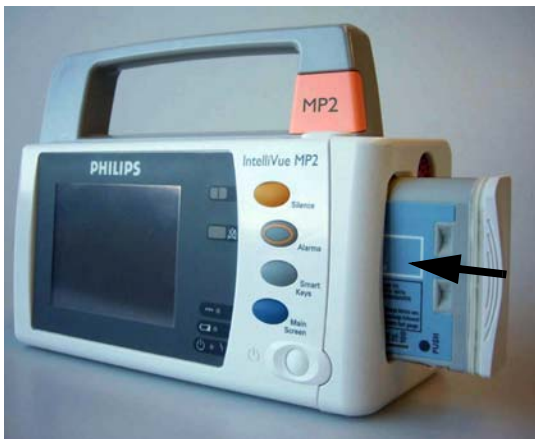

Optimizing Battery Performance

The performance of rechargeable batteries may deteriorate over time. Battery maintenance as recommended here can help to slow down this process.

Display Brightness Setting

- ◆ In the **Main Setup** menu, select **User Interface -> Brightness -> Optimum**. This selects a level of brightness suitable for most monitoring locations that uses less battery power than brighter settings.

Satisfy yourself that this level of brightness is suitable for your monitoring location.

Note that your monitor may be configured to dim or brighten the display brightness automatically when you disconnect from power, to suit the most common transport scenario (“**TransportBrightn**” setting).

Charging a Battery

A battery can be charged in a monitor during monitoring. You can also use the M8043A Smart Battery Charger to charge batteries.

- 1 Insert the battery into a monitor connected to the external power supply (M8023A).
- 2 Charge the battery until it is full, the battery LED goes out, and the battery power gauge is filled.

In certain situations, internal temperature conditions may mean that the battery will not charge. This is sometimes necessary to protect the battery from damage, and does not indicate a malfunction. In this case you must use the M8043A Smart Battery Charger to charge the battery.

Conditioning a Battery

You must condition a battery when its “battery requires maintenance” symbol shows on the Screen. Do not interrupt the charge or discharge cycle during conditioning.

CAUTION Do not use a monitor being used to monitor patients to condition batteries. The monitor switches off automatically when there is no battery power left.

You can also use the M8043A Smart Battery Charger for external battery conditioning (requires adapter, order number 4512 610 17451). For details please see the Instructions for Use for the Smart Battery Charger. Do not use any other battery chargers or conditioners.

To condition a battery using a monitor,

- 1 Insert the battery into a monitor connected to the external power supply.
- 2 Charge the battery until it is completely full. Open the **Battery Status** window and check that the **Batt Fully Charged** message is displayed.
- 3 Disconnect the monitor from mains power, and let the monitor run until there is no battery power left and the monitor switches itself off.
- 4 Reconnect the monitor to mains power and charge the battery until it is full for use or charge to 50% for storage.

Storing a Battery

A battery should not remain inside the monitor if it is not used for a longer period of time. Batteries should be charged to a maximum of 50% for storage.

NOTE The battery will discharge over time if it is stored inside the monitor when not connected to AC power via the external power supply (M8023A). The reported values for “remaining capacity” and “runtime” will become less accurate when the battery is stored in this way for a longer period of time (that is, several weeks).

Battery Safety Information

WARNING Use only Philips batteries part number M4607A. Use of a different battery may present a risk of fire or explosion.

Do not open batteries, or dispose of them in fire, or cause them to short circuit. They may ignite, explode, leak or heat up, causing personal injury.

Dispose of used batteries promptly and in an environmentally-responsible manner. Do not dispose of the battery in normal waste containers. Consult your hospital administrator to find out about local arrangements.

CAUTION Do not disassemble, heat above 100°C (212°F) or incinerate the batteries, to avoid the risk of fire and burns. Keep batteries out of the reach of children and in their original package until you are ready to use them.

If battery leakage should occur, use caution in removing the battery. Avoid contact with skin. Refer to qualified service personnel.

Maintenance and Troubleshooting

WARNING **Schedule:** Failure on the part of the responsible individual hospital or institution employing the use of this equipment to implement a satisfactory maintenance schedule may cause undue equipment failure and possible health hazards.

Contact: If you discover a problem with any of the equipment, contact your service personnel, Philips, or your authorized supplier.

Inspecting the Equipment and Accessories

You should perform a visual inspection before every use, and in accordance with your hospital's policy. With the monitor switched off:

- 1 Examine unit exteriors for cleanliness and general physical condition. Make sure that the housings are not cracked or broken, that everything is present, that there are no spilled liquids and that there are no signs of abuse.
- 2 Inspect all accessories (cables, transducers, sensors and so forth). If any show signs of damage, do not use.
- 3 Switch the monitor on and make sure the backlight is bright enough. Check that screen is at its full brightness. If the brightness is not adequate, contact your service personnel or your supplier.

Inspecting the Cables and Cords

- 1 Examine all system cables, the power plug and cord for damage. Make sure that the prongs of the plug do not move in the casing. If damaged, replace it with an appropriate Philips power cord.
- 2 Inspect the patient cables, leads and their strain reliefs for general condition. Make sure there are no breaks in the insulation. Make sure that the connectors are properly engaged at each end to prevent rotation or other strain.
- 3 Apply the transducer or electrodes to the patient, and with the monitor switched on, flex the patient cables near each end to make sure that there are no intermittent faults.

Maintenance Task and Test Schedule

The following tasks are for Philips-qualified service professionals only. All maintenance tasks and performance tests are documented in detail in the service documentation supplied on the monitor documentation CD.

Ensure that these tasks are carried out as indicated by the monitor's maintenance schedule, or as specified by local laws. Contact a Philips-qualified service provider if your monitor needs a safety or performance test. Clean and disinfect equipment to decontaminate it before testing or maintaining it.

Maintenance and Test Schedule	Frequency
Monitor Tests	
Safety checks. Selected tests on the basis of IEC 60601-1	At least once every two years, or as needed, after any repairs where the power supply is removed or replaced, or if the monitor has been dropped.
Monitor Maintenance	
Check ECG synchronization of the monitor and defibrillator (only if hospital protocol requires use of monitor during defibrillation)	At least once every two years, or as needed.
Measurement Tests	
Performance assurance for all measurements not listed below.	At least once every two years, or if you suspect the measurement values are incorrect.
Measurement Maintenance	
NBP calibration	At least once every two years, or as specified by local laws.
Microstream CO ₂ calibration and performance test	At least once a year or after 4000 operating hours.
Mainstream and sidestream CO ₂ calibration check	At least once a year, or if you suspect the measurement values are incorrect.
Battery Maintenance	
Battery	See the section on Maintaining Batteries

Troubleshooting

If you suspect a problem with an individual measurement, read the Instructions for Use and doublecheck that you have set up the measurement correctly.

If you suspect an intermittent, system-wide problem call your service personnel. You may be asked for information from the status log. To view the status log,

- 1 In the **Main Setup** menu, select **Revision**.
- 2 View the status log by selecting **Status Log** from the **Monitor Revision** window.

Disposing of the Monitor

WARNING To avoid contaminating or infecting personnel, the environment or other equipment, make sure you disinfect and decontaminate the monitor appropriately before disposing of it in accordance with your country's laws for equipment containing electrical and electronic parts. For disposal of parts and accessories such as thermometers, where not otherwise specified, follow local regulations regarding disposal of hospital waste.

You can disassemble the monitor as described in the Service Guide.

You will find detailed disposal information on the following web page:

http://www.medical.philips.com/main/company/sustainability/recycling/patient_monitoring/

The Recycling Passports located there contain information on the material content of the equipment, including potentially dangerous materials which must be removed before recycling (for example, batteries and parts containing mercury or magnesium).



Do not dispose of waste electrical and electronic equipment as unsorted municipal waste. Collect it separately, so that it can be safely and properly reused, treated, recycled, or recovered.

Disposing of Empty Calibration Gas Cylinders

- 1 Empty the cylinder completely by pushing in the pin of the regulator valve or by pulling out the pin of the fill valve using a tire valve stem wrench or a pair of needle nose pliers.
- 2 When the cylinder is empty, either remove the valve stem from the fill (or regulator) hole, or drill a hole in the cylinder.
- 3 Write "Empty" on the cylinder and dispose of it appropriately for scrap metal.

WARNING Ensure that the cylinder is completely empty before trying to remove the valve stem or drill a hole in the cylinder.

Accessories

You can order parts and accessories from Philips supplies at www.medical.philips.com or consult your local Philips representative for details.

WARNING **Reuse:** Never reuse disposable transducers, sensors, accessories and so forth that are intended for single use, or single patient use only. Reuse may compromise device functionality and system performance and cause a potential hazard.

Philips' approval: Use only Philips-approved accessories. Using non-Philips-approved accessories may compromise device functionality and system performance and cause a potential hazard.

Packaging: Do not use a sterilized accessory if its packaging is damaged.

ECG/Resp Accessories



This symbol indicates that the cables and accessories are designed to have special protection against electric shocks (particularly regarding allowable leakage currents), and are defibrillator proof.

The following cables may not all be available in all countries. Please check availability with your local Philips supplier.

Recommended Cables

Trunk Cables

	3-Electrode Cable Set	5-Electrode Cable Set	6-Electrode Cable Set	10-Electrode Cable set (5+5)	10-Electrode Cable set (6+4)
Part No.	M1669A	M1668A	M1667A	M1663A	M1665A
Length	2.7m	2.7m	2.7m	2.0m	2.7m

3-Electrode Cable Sets

Description	Length	AAMI Part No.	IEC Part No.
OR Grabber shielded	1.0m	M1675A	M1678A
ICU Grabber shielded	1.0m	M1671A	M1672A
ICU snap shielded	1.0m	M1673A	M1674A
ICU Clip non-shielded	0.45m	M1622A	--
ICU Clip non-shielded	0.7m	M1624A	M1626A

5-Electrode Cable Sets

Description	Length	AAMI Part No.	IEC Part No.
OR Grabber shielded	1.0m/1.6m	M1973A	M1974A
ICU Grabber shielded	1.0m/1.6m	M1968A	M1971A
ICU Snap shielded	1.0m/1.6m	M1644A	M1645A
ICU Miniclip non-shielded	0.7m/1.3m	M1647A	M1648A

6-Electrode Cable Sets

Description	Length	AAMI Part No.	IEC Part No.
OR Grabber	1.0m/1.6m	M1684A	M1685A
ICU Grabber	1.0m/1.6m	M1680A	M1681A
ICU Snap	1.0m/1.6m	M1682A	M1683A

10-Electrode (5+5) Cable Sets

Description	Length	AAMI Part No.	IEC Part No.
ICU Grabber, chest, shielded	1.0m	M1976A	M1978A
ICU Snap, chest, shielded	1.0m	M1602A	M1604A
OR Grabber, chest, shielded	1.0m	M1979A	M1984A
For Limb Leads see 5-electrode cable sets			

10-Electrode (6+4) Cable Sets

Description	Length	AAMI Part No.	IEC Part No.
ICU Grabber, chest, shielded	1.0m	M1532A	M1533A
ICU Snap, chest, shielded	1.0m	M1537A	M1538A
OR Grabber, chest, shielded	1.0m	M1557A	M1558A
For Limb Leads see 6-electrode cable sets			

One-piece Cables

Description	Length	AAMI Part No.	IEC Part No.
3-lead Grabber, ICU	1.0m	989803143181	989803143171
5-lead Grabber, ICU	1.0m	989803143201	989803143191

Radio-translucent Cables

Pack of five single wires, radio-translucent, 0.9m, M1649A

Set Combiners and Organizers

Set combiners and organizers		Part No.
Set combiner	3-electrode	M1501A
	5-electrode	M1502A
Set organizer for shielded leadsets - grabber and snap	3-electrode	M1503A
	4-electrode	M1664A
	5-electrode	M1504A
	6-electrode	M1679A
Set organizer for non-shielded lead sets - miniclip	3-electrode	M1636A
	5-electrode	M1638A
Bedsheet clip		M1509A
Replacement red cover for trunk cable (for 5-electrode cable sets)		989808148861

Supported Cables

Trunk Cables

Length	3-Electrode Cable Set		5-Electrode Cable Set	
	AAMI Part No.	IEC Part No.	AAMI Part No.	IEC Part No.
0.9m	M1540C	M1550C	M1560C	M1570C
2.7m	M1500A	M1510A	M1520A	M1530A

3-Electrode Cable Sets

Description	Length	AAMI Part No.	IEC Part No.
OR	1.0m	M1601A	M1611A
ICU Grabber shielded	1.0m	M1603A	M1613A
ICU snap shielded	1.0m	M1605A	M1615A
ICU Clip non-shielded	0.45m	M1608A	M1618A
ICU Clip non-shielded	0.7m	M1609A	M1619A

5-Electrode Cable Sets

Description	Length	AAMI Part No.	IEC Part No.
OR Grabber shielded	1.0m/1.6m	M1621A	M1631A
ICU Grabber shielded	1.0m/1.6m	M1623A	M1633A
ICU Snap shielded	1.0m/1.6m	M1625A	M1635A
ICU Clip non-shielded	0.7m/1.3m	M1629A	M1639A

3-Electrode One Piece Cables

AAMI 3-Electrode One Piece Cables	Length	AAMI Part No.	IEC 3-electrode One Piece Cables	IEC Part No.
OR Grabber	1.9m	M1970A	OR Grabber	M1980A
ICU Snap	1.9m	M1972A	ICU Grabber	M1981A

5-Electrode One Piece Cables

AAMI 5-electrode One Piece Cables	Length	AAMI Part No.	IEC 5-electrode One Piece Cables	IEC Part No.
OR Grabber	2.5m	M1975A	OR Grabber	M1985A
ICU Snap	2.5m	M1977A	ICU Grabber	M1986A

Set Combiners and Organizers

Set combiners and organizers		Part No.
Set combiner	3-electrode	M1501A
	5-electrode	M1502A
Set organizer	Shielded 3-electrode	M1503A
	Shielded 5-electrode	M1504A
Bedsheet clip		M1509A

NBP Accessories



These cuffs and tubings are designed to have special protection against electric shocks (particularly regarding allowable leakage currents), and are defibrillator proof. You can use them during electrosurgery.

Adult/Pediatric Multi-Patient Comfort Cuffs and Disposable Cuffs

Patient Category	Limb Circumference	Bladder Width	Disposable cuff Part No.	Reusable cuff Part No.	Tubing
Adult (Thigh)	42 to 54 cm	20 cm	M1879A	M1576A	M1598B (1.5m) or M1599B (3m)
Large Adult	34 to 43 cm	16 cm	M1878A	M1575A	
Adult	27 to 35 cm	13 cm	M1877A	M1574A	
Small Adult	20.5 to 28 cm	10.5 cm	M1876A	M1573A	
Pediatric	14 to 21.5 cm	8 cm	M1875A	M1572A	
Infant	10 to 15 cm	5.5 cm	M1874A	M1571A	

Reusable Cuff Kits

Cuff Kits	Part No.
Infant, pediatric, small adult, adult	M1577A
Small adult, adult, large adult, thigh	M1578A
Infant, pediatric, small adult, adult, large adult, thigh	M1579A

Adult/Pediatric Antimicrobial Coated Reusable cuffs

Patient Category (color)	Limb Circumference (cm)	Bladder Width	Part No.	Tubing
Adult Thigh (grey)	45 - 56.5	21.0 cm	M4559A	M1598B (1.5m) or M1599B (3m)
Large Adult X-Long (burgundy)	35.5 - 46.0	17.0 cm	M4558A	
Large Adult (burgundy)	35.5 - 46.0	17.0 cm	M4557A	
Adult X-Long (navy blue)	27.5 - 36.5	13.5 cm	M4556A	
Adult (navy blue)	27.5 - 36.5	13.5 cm	M4555A	
Small Adult (royal blue)	20.5 - 28.5	10.6 cm	M4554A	
Pediatric (green)	13.8 - 21.5	8.0 cm	M4553A	
Infant (orange)	9 - 14.8	5.4 cm	M4552A	

Adult/Pediatric Soft Single Patient Single-Hose Disposable Cuffs

Patient Category	Limb Circumference (cm)	Bladder Width	Part No.	Tubing
Adult (Thigh)	45 - 56.5 cm	20.4 cm	M4579A	M1598B (1.5m) or M1599B (3m)
Large Adult X-Long	35.5 - 46 cm	16.4 cm	M4578A	
Large Adult	35.5 - 46 cm	16.4 cm	M4577A	
Adult X-Long	27.5 - 36.5	13.1 cm	M4576A	
Adult	27.5 - 36.5 cm	13.1 cm	M4575A	
Small Adult	20.5 - 28.5 cm	10.4 cm	M4574A	
Pediatric	15.0 - 21.5 cm	8.0 cm	M4573A	
Infant	9 - 15 cm	5.6 cm	M4572A	

Neonatal/Infant Cuffs (Disposable, non-sterile)

Cuffs	Limb Circumference (cm)	Bladder Width	Part No.	Tubing
Size 1	3.1 to 5.7 cm	2.2 cm	M1866A	M1596B (1.5m) or M1597B (3m)
Size 2	4.3 to 8.0 cm	2.8 cm	M1868A	
Size 3	5.8 to 10.9 cm	3.9 cm	M1870A	
Size 4	7.1 to 13.1 cm	4.7 cm	M1872A	

Invasive Pressure Accessories



These transducers and accessories are designed to have special protection against electric shocks (particularly regarding allowable leakage currents), and are defibrillator proof.

Transducer, accessories, sensor kits	Part No
Reusable pressure transducer 5 μ V/.V/mmHg sensitivity	CPJ840J6
Sterile disposable pressure domes for CPJ840J6 (pack of 50)	CPJ84022
Transducer holder for CPJ840J6 (pack of 4)	CPJ84046
IV pole mount for CPJ840J6	CPJ84447
Single channel disposable sensor kit (20) - (EU/EFTA only)	M1567A
Dual channel disposable sensor kit (20) (EU/EFTA only)	M1568A
Transducer holder for M1567/8A (EU/EFTA only)	M2271A
IV pole mount for M1567/8A (EU/EFTA only)	M2272C
Adapter cable for disposable sensor kit 3,0m for M1567/8A	M1634A
Monitoring Line Set	CPJ84026

SpO₂ Accessories

Some Nellcor sensors contain natural rubber latex which may cause allergic reactions. See the Instructions for Use supplied with the sensors for more information. M1901B, M1902B, M1903B and M1904B disposable sensors are not available in USA from Philips. Purchase Nellcor sensors and adapter cables directly from Tyco Healthcare.

Do not use more than one extension cable with any sensors or adapter cables. Do not use an extension cable with:

- Masimo adapter cables,
- Philips reusable sensors or adapter cables with part numbers ending in -L (indicates “Long” version).

All listed sensors operate without risk of exceeding 41°C on the skin, if the initial skin temperature does not exceed 35°C.

Make sure that you use only the accessories that are specified for use with this device, otherwise patient injury can result.

Product Number	Description	Comments
Philips reusable sensors.		
M1191A/B	Adult sensor (2m cable), for patients over 50 kg. Any finger, except thumb.	No adapter cable required.
M1191AL/BL	M1191A/B with longer cable (3 m)	
M1192A	Small adult, pediatric sensor (1.5m cable) for patients between 15 kg and 50 kg. Any finger except thumb.	
M1193A	Neonatal sensor (1.5m cable) for patients between 1kg and 4 kg. Hand or foot.	
M1194A	Ear sensor (1.5m cable) for patients more than 40 kg.	
M1195A	Infant sensor (1.5m cable) for patients between 4kg and 15 kg. Any finger except thumb.	
M1196A	Adult clip sensor (3m cable) for patients over 40 kg. Any finger except thumb.	No adapter cable required.

Product Number	Description	Comments
M1191T	Adult sensor (0.45m cable), for patients over 50 kg. Any finger, except thumb.	Requires M1943 (1 m) or M1943AL (3 m) adapter cable
M1192T	Small adult, pediatric sensor (0.45m cable) for patients between 15 kg and 50 kg. Any finger except thumb.	
M1193T	Neonatal sensor (0.9m cable) for patients between 1kg and 4 kg. Hand or foot.	
M1196T	Adult clip sensor (0.9m cable) for patients over 40 kg. Any finger except thumb.	
M1191ANL	Special Edition (SE) Adult sensor (3m cable), for patients over 50 kg. Any finger, except thumb.	No adapter cable required.
M1192AN	Special Edition (SE) Small adult, pediatric sensor (1.5m cable) for patients between 15 kg and 50 kg. Any finger except thumb.	
M1193AN	Special Edition (SE) Neonatal sensor (1.5m cable) for patients between 1kg and 4 kg. Hand or foot.	
M1194AN	Special Edition (SE) Ear sensor (1.5m cable) for patients more than 40 kg.	No adapter cable required.
M1195AN	Special Edition (SE) Infant sensor (1.5m cable) for patients between 4 kg and 15 kg. Any finger except thumb.	
Philips disposable sensors. Not available in the USA and Canada.		
M1904B	Identical to OxiMax MAX-A	Use adapter cable M1943A or M1943AL.
M1903B	Identical to OxiMax MAX-P	
M1902B	Identical to OxiMax MAX-I	
M1901B	Identical to OxiMax MAX-N	
Philips disposable sensors. Available worldwide.		
M1131A	Adult/Pediatric finger sensor, 0.45m cable (patient size >20 kg)	Use adapter cable M1943A or M1943AL.

Product Number	Description	Comments
M1132A	Infant finger or toe sensor, 0.9m cable (patient size 3 - 10 kg)	Use adapter cable M1943A or M1943AL.
M1133A	Adult/Infant/Neonatal, 0.9m cable Foot or hand for neonates < 3 kg Big toe or thumb for patients between 10kg and 20kg Any finger except thumb for patients > 40kg	Use adapter cable M1943A or M1943AL.
NELLCOR disposable sensors (must be ordered from Nellcor)		
OxiMax MAX-A	Adult finger sensor (patient size >30 kg)	Use adapter cable M1943A or M1943AL.
OxiMax MAX-AL	OxiMax MAX-A with long cable	
OxiMax MAX-P	Pediatric foot/hand sensor (patient size 10-50 kg)	
OxiMax MAX-I	Infant foot/hand sensor (patient size 3-20 kg)	
OxiMax MAX-N	Adult finger or neonatal foot/hand sensor (patient size >40 kg or <3 kg)	
Oxisensor II D-25	Adult sensor (patient size >30kg)	Use adapter cable M1943A or M1943AL
Oxisensor II D-20	Pediatric sensor (patient size 10-50 kg)	
Oxisensor II I-20	Infant sensor (patient size 3-20 kg)	
Oxisensor II N-25	Neonatal sensor (patient size <3 kg or >40 kg)	
OxiCliq A	See OxiMax MAX-A	Use adapter cable M1943A or M1943AL together with OC-3 adapter cable.
OxiCliq P	See OxiMax MAX-P	
OxiCliq I	See OxiMax MAX-I	
OxiCliq N	See OxiMax MAX-N	
Extension / Adapter Cables for Philips and Nellcor Sensors		
M1941A	Extension cable (2 m)	For use with Philips reusable sensors and adapter cables.
M1943A	Adapter cable (1.1 m cable)	Adapter cable for Philips/Nellcor disposable sensors.
M1943AL	Adapter cable (3 m cable)	

Product Number	Description	Comments
OC-3	Adapter Cable for OxiCliq sensors	Available from Nellcor only.

Product Number	Description	Philips Part Number
MASIMO LNOP[®] reusable sensors.		
LNOP DC-I	Adult Finger Sensor (> 30 kg)	989803140321
LNOP DC-IP	Pediatric Finger Sensor (10 - 50 kg)	989803140331
LNOP YI	Multi-site Sensor (> 1 kg)	n/a
LNOP TC-I	Ear Sensor (> 30 kg)	989803140341
MASIMO LNCS[®] reusable sensors.		
LNCS DC-I	Adult reusable Sensor (> 30 kg)	989803148281
LNCS DC-IP	Pediatric reusable Sensor (10 - 50 kg)	989803148291
LNCS TC-I	Reusable ear Sensor (> 30 kg)	989803148301
MASIMO LNOP[®] disposable adhesive sensors.		
LNOP Adt	Adult Sensor (> 30 kg)	989803140231
LNOP Adtx	Adult Sensor (> 30 kg)	n/a
LNOP Pdt	Pediatric Sensor (10 - 50 kg)	989803140261
LNOP Pdtx	Pediatric Sensor (10 - 50 kg)	n/a
LNOP Inf-L	Infant Toe Sensor (3 - 20 kg)	989803140311
LNOP Neo-L	Neonatal Sensor (<3kg) or Adult adhesive Sensor (> 40 kg)	989803140291
LNOP NeoPt-L	Neonatal Pre-Term Sensitive Skin Sensors (<1kg)	989803140301
MASIMO LNCS[®] disposable adhesive sensors.		
LNCS Adtx	Adult Finger Sensor (> 30 kg)	989803148231
LNCS Pdtx	Pediatric Finger Sensor (10 - 50 kg)	989803148241
LNCS Inf-L	Infant Toe Sensor (3 - 20 kg)	989803148251
LNCS Neo-L	Neonatal Foot Sensor (< 3 kg) or Adult Finger Sensor (> 40 kg)	989803148271
LNCS NeoPt-L	Neonatal pre-term sensitive skin Sensor (< 1 kg)	989803148261
Adapter Cable for MASIMO sensors.		
LNOP MP12	LNOP MP Series Patient Cable (3.6 m) Adapter Cable for Masimo LNOP Sensors	451261000761
LNC MP10	LNCS MP Series Patient Cable (3.0 m) Adapter Cable for Masimo LNCS Sensors	989803148221



The monitor uses Masimo certified pulse oximetry for reduced noise and low perfusion performance with Masimo Sensors under the Masimo NR&LP protocol available from Masimo

Temperature Accessories

Temperature Probes	Part No.	Minimum measurement time for accurate readings
Reusable		
General purpose probe	21075A	90 sec
Small flexible vinyl probe (Infant/Pediatric)	21076A	60 sec
Attachable surface probe	21078A	60 sec
Disposable		
General purpose probe	M1837A	90 sec
Skin probe	21091A	60 sec
Esophageal/Stethoscope Probe (12 French)	21093A	180 sec
Esophageal/Stethoscope Probe (French 18)	21094A	210 sec
Esophageal/Stethoscope Probe (French 24)	21095A	310 sec
Foley Catheter Probe (12 French)	M2255A	180 sec
Foley Catheter Probe (16 French)	21096A	180 sec
Foley Catheter Probe (18 French)	21097A	180 sec
Adapter cable 1.5m	21082B	
Adapter cable 3.0m	21082A	

Mainstream CO₂ Accessories

Description	Part No.
CO ₂ Sensor	M2501A
Adult/Pediatric Airway Adapter (reusable)	M2513A
Infant Airway Adapter (reusable)	M2516A
Adult Airway Adapter (single-patient use)	M2533A
Infant Airway Adapter (single-patient use)	M2536A

Sidestream CO₂ Accessories

Description	Part No.
CO ₂ Sensor	M2741A
Nasal and Oral-Nasal Cannulas	
CO ₂ Nasal Cannula, Adult	M2744A
CO ₂ Nasal Cannula, Pediatric	M2745A
CO ₂ Nasal Cannula, Infant	M2746A
CO ₂ / O ₂ Nasal Cannula, Adult	M2750A
CO ₂ / O ₂ Nasal Cannula, Pediatric	M2751A
CO ₂ / O ₂ Nasal Cannula, Infant	989803144471
CO ₂ Oral-Nasal Cannula, Adult	M2756A
CO ₂ Oral-Nasal Cannula, Pediatric	M2757A
CO ₂ / O ₂ Oral-Nasal Cannula, Adult	M2760A
CO ₂ / O ₂ Oral-Nasal Cannula, Pediatric	M2761A
Airway Adapters	
Airway Adapter Set, ET > 4.0 mm	M2768A
Airway Adapter Set, ET =< 4.0 mm	989803144531
Airway Adapter Set H, ET > 4.0 mm	M2772A
Airway Adapter Set H, ET =< 4.0 mm	M2773A
Straight Sample Lines	
Straight Sample Line	M2776A
Straight Sample Line H	M2777A

Mainstream CO₂ Accessories (for M3016A)

Description	Part No.
CO ₂ Sensor	M1460A
Standard Airway Adapter (reusable)	M1465A
Small Airway Adapter (reusable)	14363A

Microstream CO₂ Accessories

- “FilterLine Set” is a combination of a FilterLine with an Airway Adapter.
- “H” in the accessory name indicates suitability for humidified ventilation and longer usage due to the active removal of humidity from the sample line.
- “Smart CapnoLine” is a combined oral-nasal FilterLine.

- “Smart CapnoLine O₂” is a combined oral-nasal-O₂-CO₂ FilterLine.
- “NIV Line” is a nasal FilterLine suitable for mask ventilation (for example, C-PAP).
- “Single purpose” means CO₂ measurement only, “dual purpose” means CO₂ measurement and O₂ delivery.
- The accessories are supplied in packs of 25.

Microstream accessory selection flowchart						
Is the patient intubated?						
Yes		No				
		Does the patient need oxygen?				
		Yes		No		
Short-term (up to 6 hours)	Long-term (up to 72 hours)	Short term (up to 8 hours)	Long term (up to 24 hours)	Long-term (up to 24 hours)	Short term (up to 8 hours)	Short term (up to 8 hours)
		Oral/Nasal	Nasal	Nasal	Oral/Nasal	Nasal
Key Applications						
Critical Care	OR, EMS, ED	Procedural Sedation, Critical Care, EMS, ED	Critical Care, Sleep Lab, Long-term Pain Management	Critical Care, Sleep Lab	Procedural Sedation, Critical Care, EMS, ED	EMS, ED
Philips part numbers (A = Adult, P= Pediatric, I = Infant, N = Neonate)						
FilterLine Set: A/P: M1920A	FilterLine H Set: A/P: M1921A	Smart CapnoLine O ₂ : A: M2522A P: M2520A	CapnoLine HO ₂ : A: M4680A P: M4681A	CapnoLine H: A: M4689A P: M4690A I/N: M4691A	Smart CapnoLine: A: M2526A P: M2524A	NIV Line: A: 4686A P: M4687A
FilterLine Set Long: A/P:989803160241*	FilterLine H Set Long A/P:989803160251*	Smart CapnoLine O ₂ Long A:989803160281* P:989803160271*			Smart CapnoLine Plus Long A:989803160301*	
FilterLine: M1925A*	I/N:989803160261* VitaLine H Set: A/P:989803159571* I/N: 989803159581* FilterLine H: M1926A*					
*Not available in all geographies.						

Battery Accessories

Description	Part No.
Battery Charger and Conditioner (requires size adapter 4512 610 17451 to charge M4607A battery)	M8043A
Size adapter for M4607A battery	4512 610 17451

Specifications

Intended Use

The monitor is intended to be used for monitoring and recording of, and to generate alarms for, multiple physiological parameters of adults, pediatrics, and neonates in a hospital environment and during patient transport inside and outside of the hospital environment. The monitor is intended for use by health care professionals.

The monitor is only for use on one patient at a time. It is not intended for home use. Not a therapeutic device.

Rx only: U.S. Federal Law restricts this device to sale by or on the order of a physician.

ST segment monitoring is intended for use with adult patients only and is not clinically validated for use with neonatal and pediatric patients.

The ECG measurement is intended to be used for diagnostic recording of rhythm and detailed morphology of complex cardiac complexes (according to AAMI EC 11).

NOTE 1 Hospital Environment

The monitor is suitable for use in all medically used rooms which fulfil the requirements regarding electrical installation according to IEC60364-7-710 “Requirements for special installations or locations - Medical locations”, or corresponding local regulations.

NOTE 2 EMC Environment

All measurements (except the sidestream CO₂ measurement with M2741A sensor) and system interfaces (except short range radio and wireless LAN) are, in addition, suitable for use in establishments directly connected to the public low-voltage supply network that supplies buildings used for domestic purposes (see table in “Electromagnetic Emissions” on page 267).

The monitor is indicated for use by health care professionals whenever there is a need for monitoring the physiological parameters of patients.

WARNING The monitors are not intended for use in an MRI environment or in an oxygen-enriched environment (for example, hyperbaric chambers).

Manufacturer's Information

You can write to Philips at this address

Philips Medizin Systeme Boeblingen GmbH
 Hewlett-Packard-Str. 2
 71034 Boeblingen
 Germany

Visit our website at: www.philips.com.

© Copyright 2002 - 2008. Koninklijke Philips Electronics N.V. All Rights Reserved.

Trademark Acknowledgement

The following are trademarks of Nellcor Puritan Bennett Incorporated: Nellcor[®], Durasensor[®], Dura-Y[®], Oxiband[®], Oxicliq[®], OxiMax[®]. MAX-FAST[®] is a trademark of Mallinckrodt Inc.

Microstream[®], FilterLine[®], and Smart CapnoLine[®] are trademarks or registered trademarks of Oridion Systems Ltd.













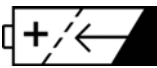

Masimo[®], Masimo SET[®], and LNOP are federally registered trademarks of the Masimo Corporation.

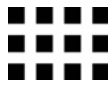









Other product and company names mentioned in this book may be trademarks of their respective owners.

Symbols

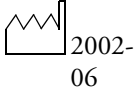
These symbols can appear on the monitor and its associated equipment.

*These symbols can appear on the monitor and its associated equipment (depending on options).

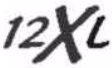
Symbols		
 Refer to accompanying documents	 On/Off/Standby	 Main Screen
 DC power source	 Battery symbol	 Battery Eject
 SmartKeys	 ECG Sync Pulse Output indicator	 Connection direction indicator
 Pressure connector	 Temperature connector	 Connector has special protection against electric shocks and is defibrillator proof
 NBP connector	 SpO ₂ connector	 Uses FAST SpO ₂ algorithm

Symbols		
 Silence Alarms	 Alarms	 Alarms Off
 ECG connector	 Error LED	 Identifies year and month of manufacture
 LAN connection indicator for connection to a wired network	 IntelliVue Instrument Telemetry wireless network	 Always use separate collection for waste electrical and electronic equipment (WEEE)
 Monitor supports 12-lead ECG	 built-in short range radio interface	 built-in wireless network

Installation Safety Information

WARNING If multiple instruments are connected to a patient, the sum of the leakage currents may exceed the limits given in IEC/EN60601-1, IEC60601-1-1, UL60601-1. Consult your service personnel.

Earthing	The monitor must be earthed during operation. The earthing is for functional purposes and does not provide protection against electric shock. The protection against electric shock in this device is provided by double and/or reinforced insulation. If a three-wire receptacle is not available, consult the hospital electrician. Never use a three-wire to two-wire adapter.
Combining equipment	Combinations of medical equipment with non-medical equipment must comply with IEC 60601-1-1. Never use a multiple portable socket-outlet or extension cord when combining equipment unless the socket outlet is supplied specifically for use with that equipment.
Network Cables	All network cables must be unshielded.

Connectors

The actual placement of boards and configuration of connections for your monitor depends on how your hardware has been configured. See the symbols table on page 244 to see which symbols are used to mark the connections.

- WARNING**
- Connect only medical devices to the ECG output connector socket.
 - Connecting the ECG sync out to external equipment should only be done by a qualified user. Do not touch the patient when you have contact to the ECG output connector socket.

- Always connect the ECG sync cable first to the external device and then to the monitor. Wherever possible, pre-install the cable before the patient is brought into the vicinity of the equipment.

Altitude Setting

Altitude affects CO₂ measurements. The monitor must be configured at installation to the correct altitude.

Monitor Safety Specifications



The monitor complies with the Medical Device Directive 93/42/EEC.

In addition, the product complies with:

IEC 60601-1:1988 + A1:1991 + A2:1995; EN60601-1:1990 + A1:1993 + A2:1995; UL 60601-1:2003; CAN/CSA C22.2#601.1-M90; JIS T 0601-1:1999; IEC 60601-1-1:2001; EN 60601-1-1:2001; IEC 60601-1-2:2001; EN 60601-1-2:2001.

Classification (according to IEC 60601-1): Class II, Type CF, Continuous Operation.

The possibility of hazards arising from software errors was minimized in compliance with ISO 14971:2000, EN60601-1-4:1996 + A1:1999 and IEC 60601-1-4:1996 + A1:1999.

EMC And Radio Regulatory Compliance

This ISM device complies with Canadian ICES-001. Cet appareil ISM est conforme a la norme NMB-001 du Canada.

The MP2 including IntelliVue Instrument Telemetry WMTS (US only) complies with part 15 of the FCC Rules. Operation is subject to the condition that this device does not cause harmful interference. Operation of this equipment requires the prior coordination with a frequency coordinator designated by the FCC for the Wireless Medical Telemetry Service.

The MP2 including IntelliVue Instrument Telemetry ISM (2.4 GHz) - FCC and Industry Canada Radio Compliance: This device complies with Part 15 of the FCC Rules and RSS-210 of Industry Canada. Operation is subject to the following two conditions: (1) this device may not cause harmful interference, and (2) this device must accept any interference received, including interference that may cause undesired operation. Any changes or modifications to this equipment not expressly approved by Philips Medical Systems may cause harmful radio frequency interference and void your authority to operate this equipment.



The radio device used in this product is in compliance with the essential requirements and other relevant provisions of Directive 1999/5/EC (Radio Equipment and Telecommunications Terminal Equipment Directive). Class 2 radio equipment. Member states may apply restrictions on putting this device into service or placing it on the market.

This product is intended to be connected to the Publicly Available Interfaces (PAI) and used throughout the EEA.

The MP2 including the Wireless IntelliVue Adapter - FCC and Industry Canada Radio Compliance: This device complies with Part 15 of the FCC Rules and RSS-210 of Industry Canada. Operation is subject to the following two conditions: (1) this device may not cause harmful interference, and (2) this device must accept any interference received, including interference that may cause undesired operation. Any changes or modifications to this equipment not expressly approved by Philips Medical Systems may cause harmful radio frequency interference and void your authority to operate this equipment.

The maximum antenna gain permitted (for devices in the 5250-5350 MHz and 5470-5725 MHz bands) complies with the e.i.r.p. limits as stated in RSS-210.

The maximum antenna gain permitted (for devices in the 5725-5825 MHz band) complies with the e.i.r.p. limits specified for point-to-point operation, as stated in RSS-210.

The device for the band 5150-5250 MHz is only for indoor usage to reduce potential for harmful interference to co-channel mobile satellite systems.

CAUTION High power radars are allocated as primary users (meaning they have priority) of 5250-5350 MHz and 5650-5850 MHz and these radars could cause interference and /or damage to LE-LAN devices.

The radio device used in this product is in compliance with the essential requirements and other relevant provisions of Directive 1999/5/EC. This product is intended to be connected to the Publicly Available Interfaces (PAI) and used throughout the EEA.



The radio component contained in this device is compliant to Council Directive 1999/5/EC (Radio Equipment and Telecommunications Terminal Equipment Directive)

In addition the product complies with: ETSI EN 300 328; ETSI EN 301 893; AS/NZS 4771+A1; ARIB STD-T66.

The MP2 including the short range radio interface - FCC and Industry Canada Radio Compliance: This device complies with Part 15 of the FCC Rules and RSS-210 of Industry Canada. Operation is subject to the following two conditions: (1) this device may not cause harmful interference, and (2) this device must accept any interference received, including interference that may cause undesired operation. Any changes or modifications to this equipment not expressly approved by Philips Medical Systems may cause harmful radio frequency interference and void your authority to operate this equipment.



The radio device used in this product is in compliance with the essential requirements and other relevant provisions of Directive 1999/5/EC (Radio Equipment and Telecommunications Terminal Equipment Directive). Class 1 radio equipment.

In addition the product complies with: ETSI EN 300 328; AS/NZS 4771+A1; ARIB STD-T66.

Out-Of-Hospital Transport - Standards Compliance

The MP2 patient monitor with measurements and interfaces other than those listed below cannot be used for patient transport outside of the hospital environment.

The MP2 patient monitor, with the following measurements and interfaces:

- ECG/Respiration, NBP, SpO₂, Pressure, Temperature, CO₂ (only Mainstream Sensor M2501A)
- LAN, Battery

can be used in a transport environment such as a road ambulance, airplane or helicopter. For this purpose the monitor fulfils the following additional mechanical, EMC and environmental requirements:

- **Shock Tests** according to IEC TR 60721-4-7, Class 7M3. Test procedure according to IEC/EN 60068-2-27 (peak acceleration up to 100 g).
- **Random Vibration** according to IEC TR 60721-4-7, Class 7M3. Test procedure according to IEC/EN 60068-2-64 (RMS acceleration 5 g).
- **Sinusoidal Vibration** according to IEC TR 60721-4-7, Class 7M3. Test procedure according to IEC/EN 60068-2-6 (acceleration up to amplitude 2 g).
- **Bump Test** according to IEC/EN60068-2-29 (peak acceleration 15 g, 1000 bumps).
- **Free Fall Test** according to EN1789 (covers also IEC TR 60721-4-7 and Class 7M3). Test procedure according to EN 60068-2-32 (height 0.75 m).
- Specification for degrees of protection provided by enclosures according to IEC/EN 60529: IP 32
- EN 1789 +A1:2003 Medical vehicles and their equipment - Road ambulances (chapter 6 - Medical Devices).
- **Radiated susceptibility 20 V/m** according to EN ISO 9919 (SpO₂) and EN ISO 21647 (CO₂).
- **Altitude Range** from -500 to 3000 m operating and -500 to 4600 m storage and transportation.
- **Extended radiated susceptibility tests**

The MP2 patient monitor with its out-of-hospital parameter set provides a general immunity level of 20 V/m with only few restrictions. Details are as listed below:

- GSM 900: Immunity at 900 MHz (uplink mobile phone), 20 V/m (ECG:10V/m), duty cycle 1:8
- GSM 1800: Immunity at 1800 MHz (uplink mobile phone), 20 V/m, duty cycle 1:8.
- DECT: Immunity at 1800 MHz (digital cordless phone), 20 V/m, duty cycle 1:24
- AM: 1 kHz Immunity from 80 MHz to 1.0 GHz (any radio communication unit, broadcasting and TV transmitter), 20 V/m, modulation factor 80%. (ECG: 20 V/m except 600-950 MHz where it is 10 V/m and Temperature which holds 3 V/m over the full range).

CAUTION Temperature measurement accuracy may be compromised in the presence of strong electromagnetic fields (>3 V/m) in certain small frequency bands.

- **Magnetic Field emission** according to MIL STD 461E, Chapter RE101: Radiated emissions, magnetic field, 30 Hz to 100 kHz. Limit class: Army.
- **Magnetic Field susceptibility:** Radiated susceptibility, magnetic field, 50, 60 and 400 Hz, 18 µT(15 A/m)
- **Operating ambient temperature** testing over the range from 0 to 40°C (32 to 100°F).
- **Operating ambient humidity** testing up to 95% RH at 40°C (100°F), non condensing.

NOTE Additional requirements can be necessary for transport situations in air, on water or in difficult terrain in certain countries, e.g. EU.

Physical Specifications

Specification	Comments
Maximum Weight	
1.25 kg (2.8 lb)	including battery, without options
Size (W x H x D)	
188 x 99 x 86 mm 7.4 x 3.9 x 3.4 in	without handle and options

M8023A External Power Supply Weight and Dimensions	
Maximum Weight	
700 g ±10% (1.5 lb ±10%)	
Size (W x H x D)	
207 x 70 x 113 mm 8.1 x 2.8 x 4.4 in	

Environmental Specifications

The monitor may not meet the performance specifications given here if stored or used outside the specified temperature and humidity ranges.

The monitor is protected against ingress of objects and fluids according to IEC 60529 IP32 (applies to all options intended for out-of-hospital use). However, do not expose the monitor directly to heavy rain.

When the monitor and related products have differing environmental specifications, the effective range for the combined products is that range which is common to the specifications for all products.

Item	Condition	Range
Temperature Range	Operating	0 to 40°C (32 to 104°F)
	Storage including transportation	-20 to 60°C (-4 to 140°F)
Temperature Range with the Wireless IntelliVue Adapter or IntelliVue Instrument Telemetry Wireless Network or when charging the battery	Operating	0 to 35°C (32 to 95°F)
Humidity Range	Operating	15% to 95% Relative Humidity (RH)
	Storage including transportation	5% to 95% Relative Humidity (RH)

Item	Condition	Range
Altitude Range	Operating	-500 m to 3000 m (10000 ft)
	Storage including transportation	-500 m to 4600 m ¹ (15000 ft)
Ingress Protection	Monitor	IP32 (protected against ingress of water when the water is dripping vertically and the monitor is tilted up to 15°)
	External Power Supply (M8023A)	IP31 (protected against the ingress of solid foreign objects 2.5 mm in diameter or larger, and the ingress of water when the water is dripping vertically) when rested on its rubber feet on a flat, level surface.
		IP32 when mounted as shown in the section “Mounting the External Power Supply (M8023A)” on page 3 of the Installation chapter and as described in the Service Guide.

1. Sufficient for flight altitudes up to 12,000 m with pressurized cabins.

Monitor Performance Specifications

Performance Specifications		
Power Specifications	Power consumption	<12 W average <30 W while battery is loading
	Operating Voltage	36 to 60 V DC floating
Battery Specifications	Operating Time (with new, fully charged battery at 25°C)	Basic monitoring configuration: 2.5 hours (Brightness set to Optimum, ECG/Resp, SpO₂ measurements in use, NBP measurement every 15 minutes)
	Charge Time	When monitor is off: 2 hours When monitor is in use, and connected to the external power supply (M8023A), without MMS extensions: 12 hours approx.
Indicators	Alarms Off	red (crossed-out alarm symbol) LED
	Alarms	red/yellow/light blue (cyan) LED
	On/Standby / Error	green / red LED
	AC Power	green LED
	Battery	yellow (charging)/red blinking (empty) LED
	External Power	green LED
Sounds	Audible feedback for user input Prompt tone QRS tone, or SpO ₂ modulation tone 4 different alarm sounds	
Trends	Resolution	12 or 16 numerics @ 12 sec, 1 minute, 5 minute resolution.
	Information	Multiple choices of number of numerics, resolution and duration depending on trend option and application area. For example: For neonatal, you can choose between 12 and 16 numerics.

Performance Specifications		
Alarm signal	System delay	less than 3 seconds
	Pause duration	1,2,3 minutes or infinite, depending on configuration
	Extended alarm pause	5 or 10 minutes
Review Alarms	Information	all alarms / inops, main alarms on/off, alarm silence and time of occurrence
	Capacity	300 items
Real Time Clock	Range	from: January 1, 1997, 00:00 to: December 31, 2080, 23:59
	Accuracy	<4 seconds per day (typically)
	Hold Time	infinite if powered by external power supply; otherwise at least 48 hours
Buffered Memory	Hold Time	if powered by external power supply: infinite without power: at least 48 hours
	Contents	Active settings, trends, patient data, realtime reports, review alarms

M8023A External Power Supply Performance Specifications		
Power Specifications	Power consumption	<12 W average <30 W peak
	Line Voltage	100 to 240 V ~
	Current	1.3 to 0.7 A
	Frequency	50/60 Hz ~
Indicators	AC Power	green LED

Monitor Interface Specifications			
Measurement Link (MSL)	Connectors	Female ODU (Proprietary)	
	Power	30 V to 60 V input	
	Power Sync.	RS-422 compliant input 78.125k Hz (typical)	
	LAN signals	IEEE 802.3 10-Base-T compliant	
	Serial signals	RS-422 compliant	
	Local signals	Provided for connecting measurement extensions	
ECG Sync Pulse Output (See "Connectors" on page 246 for safety-related information)	Cable detection	Yes	
	Marker In	No	
	Wave Output	No	
	Connector	Binder Series 709/719	
	Output levels	Output low	<0.8 V @ I = -4 mA
		Output high	>2.4 V @ I = 4 mA
	Isolation	None	
	Pulse Width	100 +/- 10 ms (high)	
	Delay from R-wave peak to start of pulse	20 ms maximum per AAMI EC13	
Minimum required R-wave amplitude	0.5 V		

Monitor Interface Specifications		
Wireless Network Device Interface (integrated, for compatible network options see below)	Signals	RD+/-, TD+/-: IEEE 802.3 10Base-T, PWR, GND 12.5 V \pm 20%, 3.5 W continuous
	Frequency Band	USA: 2.400 – 2.483GHz, 5.15 – 5.35Ghz, 5.725 – 5.825Ghz Europe: 2.400 – 2.483GHz, 5.15– 5.35Ghz, 5.47 – 5.725Ghz Japan: 2.400 – 2.483GHz, 4.90 – 5.091GHz, 5.15 – 5.25GHz China: 2.400 – 2.483GHz, 5.725 –5.85Ghz
	Modulation Technique	802.11b/g DSSS (DBPSK, DQPSK, CCK) OFDM (BPSK,QPSK, 16-QAM, 64-QAM) 802.11a OFDM (BPSK,QPSK, 16-QAM, 64-QAM)
	Effective radiated power	2.4 GHz FCC: max 18 dBm ETSI: max 18 dBm 5 GHz FCC: max 24 dBm ETSI: max 18 dBm
Short Range Radio Interface ¹	Type	Internal SRR interface
	Technology	IEEE 802.15.4
	Frequency Band	2.4 GHz ISM (2.400 - 2.483 GHz)
	Modulation Technique	DSSS (O -QPSK)
	Effective radiated power	max. 0 dBm (1 mW)

1. The short range radio interface is compatible with the following telemetry devices: TRx4841A/TRx4851A IntelliVue Telemetry System Transceiver.

M8023A External Power Supply Interface Specifications		
Measurement Link (MSL)	Connectors	Male ODU (Proprietary)
	Power	48 V output
	Power Sync.	RS-422 compliant output 78.125 kHz (typical)
	LAN signals	IEEE 802.3 10-Base-T compliant
	Serial signals	RS-422 compliant output 78.125 kHz (typical)
	Local signals	Not connected

Display Specifications		
Integrated QVGA Display	Sweep Speeds	6.25, 12.5, 25 and 50 mm/s;
	Resolution	320 x 240
	Refresh frequency	60 Hz
	Useful screen	72 x 54 mm (2.8 x 2.1 in)
	Pixel size	0.22 x 0.22 mm

Compatible Devices		
IntelliVue Instrument Telemetry Wireless Network (USA only)		
Internal WMTS Adapter	Technology	compatible with Philips Cellular Telemetry System (CTS), cellular infrastructure
	Frequency Band	WMTS, 1395-1400 MHz and 1427-1432 MHz
IntelliVue Instrument Telemetry Wireless Network (except USA)		
Internal ISM Adapter	Technology	compatible with Philips Cellular Telemetry System (CTS), cellular infrastructure
	Frequency Band	2.4 GHz ISM
IntelliVue 802.11 Bedside Adapter (Wireless Network Adapter)		
Internal Wireless Adapter	Technology	IEEE 802.11a/b/g
	Frequency Band	2.4 GHz and 5 GHz ISM Band

M4607A Battery Specifications

One battery is required for battery operation of the monitor.

M4607A Battery Specifications		
Physical Specifications		
	W x D x H	66 mm (2.36 in) x 80 mm (3.15 in) x 20 mm (0.79 in)
	Weight	160 g ±5%
Performance Specifications		
	Nominal Voltage	10.8 Volt
	Rated Capacity at discharge C/5	1000 mAh (typical)
Environmental Specifications		
	Temperature Range	Discharge 0 to 60°C (32 to 122°F) Charge 0 to 60°C (32 to 122°F) Storage and Transportation: -20 to 65°C (-4 to 140°F)
	Humidity Range	Operating: 15% to 95% Relative Humidity (RH) Storage and Transportation: 5% to 95% Relative Humidity (RH)
	Battery Type	Lithium Ion Mangan, 10.8 V, 1000 mAh,
	Safety	complies with UL 2054
	Electromagnetic Compatibility (EMC)	complies with the requirements for FCC Type B computing Device, and EN 61000-4-2 and EN 61000-3-2
	Communication Standard	complies with the SMBus specification v1.1

Measurement Specifications

See the Appendix on Default Settings for a list of the settings the monitor is initially shipped with.

ECG/Arrhythmia/ST/QT

Complies with IEC 60601-2-25:1993 + A1:1999 /EN60601-2-25:1995 + A1:1999, IEC 60601-2-27:2005/EN60601-2-27:2006, IEC 60601-2-51:2003 /EN 60601-2-51:2003 and AAMI EC11/EC13:1991/2002.

ECG/Arrhythmia/ST Performance Specifications		
Cardiotach	Range	Adult/pedi: 15 to 300 bpm Neo range: 15 to 350 bpm
	Accuracy	±1% of range
	Resolution	1 bpm
	Sensitivity	≥200 μV _{peak}
PVC Rate	Range	0 to 300 bpm
	Resolution	1 bpm
ST Numeric	Range	-20 to +20 mm
	Accuracy	±0.5 mm or 15%, whichever is greater
	Resolution	0.1 mm
QT Numeric	Range	200 to 800 ms
	Accuracy	±30 ms
	Resolution	8 ms
QTc Numeric	Range	200 to 800 ms
	Resolution	1 ms
ΔQTc Numeric	Range	-600 to +600 ms
	Resolution	1 ms
QT-HR Numeric	Range - adult	15 to 300 bpm
	Range - pediatric and neonatal	15 to 350 bpm
Sinus and SV Rhythm Ranges	Brady	Adult: 15 to 59 bpm Pedi: 15 to 79 bpm Neo: 15 to 89 bpm
	Normal	Adult: 60 to 100 bpm Pedi: 80 to 160 bpm Neo: 90 to 180 bpm
	Tachy	Adult: >100 bpm Pedi: >160 bpm Neo: >180 bpm
Bandwidth	Diagnostic Mode	Adult/neo/pedi: 0.05 to 150 Hz
	Extended Monitoring Mode	Neo/pedi: 0.5 to 150 Hz
	Monitoring Mode	Adult: 0.5 to 40 Hz Neo/pedi: 0.5 to 55 Hz
	Filter Mode	Adult/neo/pedi: 0.5 to 20 Hz

ECG/Arrhythmia/ST Performance Specifications		
Bandwidth when the ECG is transmitted from a telemetry device via short range radio	Diagnostic Mode	Adult/neo/pedi: 0.05 to 40 Hz
	Extended Monitoring Mode	Neo/pedi: 0.5 to 40 Hz
	Monitoring Mode	Adult: 0.5 to 40 Hz Neo/pedi: 0.5 to 40 Hz
	Filter Mode	Adult/neo/pedi: 0.5 to 20 Hz
Differential Input Impedance		>2 M Ω RA-LL leads (Resp) >5 M Ω at all other leads (at 10 Hz including patient cable)
Common Mode Rejection Ratio		Diagnostic mode: >86 dB (with a 51 k Ω /47 nF imbalance). Filter mode: >106 dB (with a 51 k Ω /47 nF imbalance).
Electrode Offset Potential Tolerance		\pm 500 mV
Auxiliary Current (Leads off Detection)		Active electrode: <100 nA Reference electrode: <900 nA
Input Signal Range		\pm 5 mV

ECG/Arrhythmia/ST/QT Alarm Specifications	Range	Adjustment
HR	15 to 300 bpm maximum delay: 10 seconds according to AAMI EC 13-1992 standard	Adult: 1 bpm steps (15 to 40 bpm) 5 bpm steps (40 to 300 bpm) Pedi/Neo: 1 bpm steps (15 to 50 bpm) 5 bpm steps (50 to 300 bpm)
Extreme Tachy	Difference to high limit 0 to 50 bpm	5 bpm steps
	Clamping at 150 to 300 bpm	5 bpm steps
Extreme Brady	Difference to low limit 0 to 50 bpm	5 bpm steps
	Clamping at 15 to 100 bpm	5 bpm steps
Run PVCs	2 PVCs	Not adjustable by user
PVCs Rate	1 to 99 PVCs/minute	1 PVC
Vent Tach HR	20 to 300 bpm	5 bpm
Vent Tach Run	3 to 99 PVCs/minute	1 PVC
Vent Rhythm Run	3 to 99 PVCs/minute	1 PVC
SVT HR	120 to 300 bpm	5 bpm
SVT Run	3 to 99 SV beats	1 SV beat
ST High	-19.8 to +20 mm	0.2 mm
ST Low	-20 to +19.8 mm	0.2 mm
QTc High	200 ms to 800 ms	10 ms steps
Δ QTc High	30 ms to 200 ms	10 ms steps

ECG/Arrhythmia/ST Supplemental Information as required by AAMI EC11/13	
Respiration Excitation Waveform	Sinusoidal signal, 260 μ A, 40.5 kHz
Noise Suppression	RL drive gain 44 dB max., max. voltage 1.8 V _{rms}

ECG/Arrhythmia/ST Supplemental Information as required by AAMI EC11/13		
Time to Alarm for Tachycardia	Vent Tachycardia 1 mV _{pp} , 206 bpm	Gain 0.5, Range 6.5 to 8.4 seconds, Average 7.2 seconds
		Gain 1.0 Range 6.1 to 6.9 seconds, Average 6.5 seconds
		Gain 2.0, Range 5.9 to 6.7 seconds, Average 6.3 seconds
	Vent Tachycardia 2 mV _{pp} , 195 bpm	Gain 0.5, Range 5.4 to 6.2 seconds, Average 5.8 seconds
		Gain 1.0, Range 5.7 to 6.5 seconds, Average 6.1 seconds
		Gain 2.0, Range 5.3 to 6.1 seconds, Average 5.7 seconds
Tall T-Wave Rejection Capability		Exceeds ANSI/AAMI EC 13 Sect. 3.1.2.1(c) minimum recommended 1.2 mV T-Wave amplitude
Heart Rate Averaging Method		Three different methods are used: Normally, heart rate is computed by averaging the 12 most recent RR intervals. For runs of PVCs, up to 8 RR intervals are averaged to compute the HR. If each of 3 consecutive RR intervals is greater than 1200 ms (that is, rate less than 50 bpm), then the 4 most recent RR intervals are averaged to compute the HR.
Response Time of Heart Rate Meter to Change in Heart Rate		HR change from 80 to 120 bpm: Range: [6.4 to 7.2 seconds] Average: 6.8 seconds HR change from 80 to 40 bpm: Range: [5.6 to 6.4 sec] Average: 6.0 seconds
Heart Rate Meter Accuracy and Response to Irregular Rhythm		Ventricular bigeminy: 80 bpm Slow alternating ventricular bigeminy: 60 bpm Rapid alternating ventricular bigeminy: 120 bpm Bidirectional systoles: 90 bpm
Accuracy of Input Signal Reproduction		Methods A and D were used to establish overall system error and frequency response.
Pacemaker Pulse Rejection Performance		Rejection of pacemaker pulses with amplitudes from ± 2 mV to ± 700 mV and widths from 0.1 ms to 2.0 ms (Method A)

Respiration

Respiration Performance Specifications		
Respiration Rate	Range	Adult/pedi: 0 to 120 rpm Neo: 0 to 170 rpm
	Accuracy	at 0 to 120 rpm ± 1 rpm at 120 to 170 rpm ± 2 rpm
	Resolution	1 rpm
Bandwidth		0.3 to 2.5 Hz (-6 dB)
Noise		Less than 25 m Ω (rms) referred to the input

Respiration Alarm Specifications	Range	Adjustment	Delay
High	Adult/pedi: 10 to 100 rpm Neo: 30 to 150 rpm	under 20 rpm: 1 rpm steps over 20 rpm: 5 rpm steps	max. 14 seconds
Low	Adult/pedi: 0 to 95 rpm Neo: 0 to 145 rpm	under 20 rpm: 1 rpm steps over 20 rpm: 5 rpm steps	for limits from 0 to 20 rpm: max. 4 seconds for limits above 20 rpm: max. 14 seconds
Apnea Alarm	10 to 40 seconds	5 second steps	

SpO₂

Complies with EN ISO 9919:2005 (except alarm system; alarm system complies with IEC 60601-2-49:2001).

Measurement Validation: The SpO₂ accuracy has been validated in human studies against arterial blood sample reference measured with a CO-oximeter. Pulse oximeter measurements are statistically distributed, only about two-thirds of the measurements can be expected to fall within the specified accuracy compared to CO-oximeter measurements. Display Update Period: Typical: 2 seconds, Maximum: 30 seconds. Maximum with NBP INOP suppression on: 60 seconds.

SpO ₂ Performance Specifications		
SpO ₂ The specified accuracy is the root-mean-square (RMS) difference between the measured values and the reference values	Range	0 to 100%
	Accuracy	<p>Philips Reusable Sensors: M1191A, M1191AL, M1191ANL, M1191B, M1191BL, M1192A, M1192AN = 2% (70% to 100%) M1193A, M1193AN, M1194A, M1194AN, M1195A, M1195AN, M1196A = 3% (70% to 100%) M1191T, M1192T, M1193T (Adult), M1196T = 3% (70% to 100%) M1193T (Neonate) = 4% (70% to 100%)</p> <p>Philips Disposable Sensors with M1943A(L): M1132A, M1133A (adult/infant) = 2% M1901B, M1902B, M1903B, M1904B, M1131A, M1133A (neonate) = 3% (70% to 100%)</p> <p>NellcorPB[®] Sensors with M1943A(L): MAX-A, MAX-AL, MAX-P, MAX-I, MAX-N, D-25, D-20, I-20, N-25, OxiCliq A, P, I, N = 3% (70% to 100%)</p> <p>Masimo Reusable Sensors[®] with LNOP MP12 or LNC MP10: LNOP DC-I, LNOP DC-IP, LNOP YI, LNCS DC-I, LNCS DC-IP: 2% (70% to 100%) LNOP TC-I, LNCS TC-I: 3.5% (70% to 100%)</p> <p>Masimo Disposable Sensors[®] with LNOP MP12 or LNC MP10: LNOP Adt, LNOP Adtx, LNOP Pdt, LNOP Pdtx, LNOP Inf-L, LNCS Adtx, LNCS Pdtx, LNCS Inf-L: 2% (70% to 100%) LNOP Neo-L, LNOP NeoPt-L, LNCS Neo-L, LNCS NeoPt-L: 3% (70% to 100%)</p>
	Resolution	1%
Pulse	Range	30 to 300 bpm
	Accuracy	±2% or 1 bpm, whichever is greater
	Resolution	1 bpm
Sensors	<p>Wavelength range: 500 to 1000 nm Emitted Light Energy: ≤15 mW</p> <p>Information about the wavelength range can be especially useful to clinicians (for instance, when photodynamic therapy is performed)</p>	
Pulse Oximeter Calibration Range	70% to 100%	

SpO ₂ Alarm Specifications	Range	Adjustment	Delay
SpO ₂	Adult: 50 to 100% Pedi/Neo: 30 to 100%	1% steps	(0, 1, 2, 3,... 30) +4 seconds
Desat	Adult: 50 to Low alarm limit Pedi/Neo: 30 to Low alarm limit	1% steps	
Pulse	30 to 300 bpm	Adult: 1 bpm steps (30 to 40 bpm) 5 bpm steps (40 to 300 bpm) Pedi/Neo: 1 bpm steps (30 to 50 bpm) 5 bpm steps (50 to 300 bpm)	max. 14 seconds
Tachycardia	Difference to high limit 0 to 50 bpm	5 bpm steps	max. 14 seconds
	Clamping at 150 to 300 bpm	5 bpm steps	
Bradycardia	Difference to low limit 0 to 50 bpm	5 bpm steps	max. 14 seconds
	Clamping at 30 to 100 bpm	5 bpm steps	

NBP

Complies with IEC 60601-2-30:1999/EN60601-2-30:2000.

NBP Performance Specifications		
Measurement Ranges	Systolic	Adult: 30 to 270 mmHg (4 to 36 kPa) Pedi: 30 to 180 mmHg (4 to 24 kPa) Neo: 30 to 130 mmHg (4 to 17 kPa)
	Diastolic	Adult: 10 to 245 mmHg (1.5 to 32 kPa) Pedi: 10 to 150 mmHg (1.5 to 20 kPa) Neo: 10 to 100 mmHg (1.5 to 13 kPa)
	Mean	Adult: 20 to 255 mmHg (2.5 to 34 kPa) Pedi: 20 to 160 mmHg (2.5 to 21 kPa) Neo: 20 to 120 mmHg (2.5 to 16 kPa)
	Pulse Rate	Adult: 40 to 300 Pedi: 40 to 300 Neo: 40 to 300
Accuracy	Max. Std. Deviation: 8 mmHg (1.1 kPa) Max. Mean Error: ± 5 mmHg (± 0.7 kPa)	
Pulse Rate Measurement Accuracy	40 to 100 bpm: ± 5 bpm 101 to 200 bpm: $\pm 5\%$ of reading 201 to 300 bpm: $\pm 10\%$ of reading (average over NBP measurement cycle)	
Pulse Rate Range	40 to 300 bpm	
Measurement Time	Typical at HR >60 bpm Auto/manual/sequence: 30 seconds (adult) 25 seconds (neonatal) Stat: 20 seconds Maximum time: 180 seconds (adult/pediatric) 90 seconds (neonates)	

NBP Performance Specifications		
Cuff Inflation Time	Typical for normal adult cuff: Less than 10 seconds Typical for neonatal cuff: Less than 2 seconds	
Initial Cuff Inflation Pressure	Adult: 165 ±15 mmHg Pedi: 130 ±15 mmHg Neo: 100 ±15 mmHg	
Auto Mode Repetition Times	1, 2, 2.5, 3, 5, 10, 15, 20, 30, 45, 60 or 120 minutes	
STAT Mode Cycle Time	5 minutes	
Venipuncture Mode Inflation		
Inflation Pressure	Adult	20 to 120 mmHg (3 to 16 kPa)
	Pediatric	20 to 80 mmHg (3 to 11 kPa)
	Neonatal	20 to 50 mmHg (3 to 7 kPa)
Automatic deflation after	Adult/pediatric	170 seconds
	Neonatal	85 seconds

Measurement Validation: In adult and pediatric mode, the blood pressure measurements determined with this device comply with the American National Standard for Electronic or Automated Sphygmomanometers (ANSI/AAMI SP10 - 1992) in relation to mean error and standard deviation, when compared to intra-arterial or auscultatory measurements (depending on the configuration) in a representative patient population. For the auscultatory reference the 5th Korotkoff sound was used to determine the diastolic pressure.

In neonatal mode, the blood pressure measurements determined with this device comply with the American National Standard for Electronic or Automated Sphygmomanometers (ANSI/AAMI SP10 - 1992 and AAMI/ANSI SP10A -1996) in relation to mean error and standard deviation, when compared to intra-arterial measurements in a representative patient population.

NBP Alarm Specifications	Range	Adjustment
Systolic	Adult: 30 to 270 mmHg (4 to 36 kPa)	10 to 30 mmHg: 2 mmHg (0.5 kPa) >30 mmHg: 5 mmHg (1 kPa)
	Pedi: 30 to 180 mmHg (4 to 24 kPa)	
	Neo: 30 to 130 mmHg (4 to 17 kPa)	
Diastolic	Adult: 10 to 245 mmHg (1.5 to 32 kPa)	
	Pedi: 10 to 150 mmHg (1.5 to 20 kPa)	
	Neo: 10 to 100 mmHg (1.5 to 13 kPa)	
Mean	Adult: 20 to 255 mmHg (2.5 to 34 kPa)	
	Pedi: 20 to 160 mmHg (2.5 to 21 kPa)	
	Neo: 20 to 120 mmHg (2.5 to 16 kPa)	

NBP Overpressure Settings		
Adult	>300 mmHg (40 kPa) >2 sec	not user adjustable
Pedi	>300 mmHg (40 kPa) >2 sec	
Neo	>150 mmHg (20 kPa) >2 sec	

Invasive Pressure and Pulse

Complies with IEC 60601-2-34:2000/EN60601-2-34:2000.

Invasive Pressure Performance Specifications		
Measurement Range		-40 to 360 mmHg
Pulse Rate	Range	25 to 350 bpm
	Accuracy	±1% Full Range
	Resolution	1 bpm
Input Sensitivity		Sensitivity: 5 $\mu\text{V}/\text{V}/\text{mmHg}$ (37.5 $\mu\text{V}/\text{V}/\text{kPa}$) Adjustment range: ±10%
Transducer		Load Impedance: 200 to 2000 Ω (resistive) Output Impedance: $\leq 3000 \Omega$ (resistive)
Frequency Response		dc to 12.5 Hz or 40 Hz
Zero Adjustment	Range:	±200 mmHg (±26 kPa)
	Accuracy	±1 mmHg (±0.1 kPa)
	Drift	Less than 0.1 mmHg/°C (0.013 kPa/°C)
Gain Accuracy	Accuracy	±1%
	Drift	Less than 0.05%/°C
	Non linearity and Hysteresis	Error of $\leq 0.4\%$ FS (@CAL 200 mmHg)
Overall Accuracy	(including transducer)	±4% of reading or ±4 mmHg (±0.5 kPa), whichever is greater
Volume displacement of CPJ840J6		0.1 mm ³ /100 mmHg

Invasive Pressure Alarm Specifications	Range	Adjustment	Delay
Pressure	-40 to 360 mmHg (-5.0 to 48 kPa)	-40 to 50 mmHg 2 mmHg (0.5 kPa) >50 mmHg 5 mmHg (1 kPa)	max. 12 seconds
Extreme High	Difference to high limit 0 to 25 mmHg	5 mmHg steps (0.5 kPa)	
	Clamping at -40 to 360 mmHg	5 mmHg steps (1.0 kPa)	
Extreme Low	Difference to low limit 0 to 25 mmHg	5 mmHg steps (0.5 kPa)	
	Clamping at -40 to 360 mmHg	5 mmHg steps (1.0 kPa)	
Pulse	25 to 300 bpm	Adult: 1 bpm steps (25 to 40 bpm) 5 bpm steps (40 to 300 bpm) Pedi/Neo: 1 bpm steps (25 to 50 bpm) 5 bpm steps (50 to 300 bpm)	

Invasive Pressure Alarm Specifications	Range	Adjustment	Delay
Tachycardia	Difference to high limit 0 to 50 bpm	5 bpm steps	max. 14 seconds
	Clamping at 150 to 300 bpm	5 bpm steps	
Bradycardia	Difference to low limit 0 to 50 bpm	5 bpm steps	max. 14 seconds
	Clamping at 25 to 100 bpm	5 bpm steps	

Temp

Complies with EN 12470-4:2000. Specified without transducer.

Temp Performance Specifications		
Temp	Range	-1 to 45°C (30 to 113°F)
	Resolution	0.1°C (0.2°F)
	Accuracy	±0.1°C (±0.2°F)
Average Time Constant		Less than 10 seconds

Temp Alarm Specifications	Range	Adjustment
Temp High/Low Alarms	-1 to 45°C (30 to 113°F)	-1 to 35°C (30 to 95°F), 0.5°C (1.0°F) steps 35 to 45°C (95 to 113°F), 0.1°C (0.2°F) steps

CO₂

The CO₂ measurement in the monitor, M3014A and M3015A complies with EN ISO 21647:2004 + Cor.1:2005 (except alarm system; alarm system complies with IEC 60601-2-49:2001).

M3015A Microstream CO ₂ Performance Specifications		
CO ₂	Range	0 to 150 mmHg (0 to 20 kPa), or 20% CO ₂ , whichever is lower
	Accuracy	Up to 5 minutes during warmup: ±4 mmHg or 12%, whichever is greater After 5 minutes warmup: 0 to 40 mmHg (0 to 5.3 kPa): ±2.2 mmHg (±0.3 kPa) Above 40 mmHg (5.3 kPa): ±(5.5% + (0.08%/mmHg above 40 mmHg)) of reading These specifications are valid for 21% O ₂ and N ₂ balance, up to 35°C ambient temperature, up to 60 rpm in adult mode and 100 rpm in neonatal mode. Outside of these conditions the accuracy reaches at a minimum ±4 mmHg or ±12% of the reading, whichever is greater.
	Resolution	Numeric: 1.0 mmHg (0.1 kPa) Wave: 0.1 mmHg (0.01 kPa)
	Stability	Included in Accuracy specifications
awRR	Range	0 to 150 rpm
	Accuracy	0 to 40 rpm: ±1 rpm 41 to 70 rpm: ±2 rpm 71 to 100 rpm: ±3 rpm >100 rpm: ±5% of reading
Warm-up Time		5 minutes for full accuracy specification

M3015A Microstream CO ₂ Performance Specifications	
Rise Time	190 ms for neonatal mode (measured with FilterLine H for neonatal) 240 ms for adult mode (measured with FilterLine H for adult)
Sample Flow Rate	50 + 15/-7.5 ml/minute
Gas Sampling Delay Time	Maximum: 3 seconds (2m sample lines) 6 seconds (4m sample lines)
Sound Pressure	Acoustic noise: <45 dBA
Total System Response Time	The total system response time is the sum of the delay time and the rise time.

M3014A Mainstream CO ₂ Performance Specifications		
CO ₂	Range	0 to 150 mmHg (0 to 20.0 kPa)
	Accuracy	after 2 minutes warmup: For values between 0 and 40 mmHg: ±2.0 mmHg (±0.29 kPa) For values from 41 to 70 mmHg: ±5% of reading For values from 71 to 100 mmHg: ±8% of reading The specifications are valid for standard gas mixtures, balance air, fully hydrated at 35°C, P _{abs} = 760 mmHg, flow rate = 2 l/min.
	Resolution	Numeric: 1.0 mmHg (0.1 kPa) Wave: 0.1 mmHg (0.01 kPa)
	Stability: Short term drift Long term drift	±0.8 mmHg over four hours Accuracy specification will be maintained over a 120 hour period
awRR	Range	2 to 150 rpm
	Accuracy	±1 rpm
Warm-up Time	2 minutes with CO ₂ transducer attached for full accuracy specification	
Response Time	Less than 60 ms (with adult or infant reusable or disposable adapter)	

M3014A Sidestream CO ₂ Performance Specifications		
CO ₂	Range	0 to 150 mmHg (0 to 20.0 kPa)
	Accuracy	after 2 minutes warmup: For values between 0 and 40 mmHg: ±2.0 mmHg (±0.29 kPa) For values from 41 to 70 mmHg: ±5% of reading For values from 71 to 100 mmHg: ±8% of reading For values from 101 to 150 mmHg: ±10% of reading At respiration rates above 80 rpm, all ranges are ±12% of actual. The specifications are valid for gas mixtures of CO ₂ , balance N ₂ , dry gas at 760 mmHg within specified operating temperature range.
	Resolution	Numeric: 1.0 mmHg (0.1 kPa) Wave: 0.1 mmHg (0.01 kPa)
	Stability: Short term drift Long term drift	±0.8 mmHg over four hours Accuracy specification will be maintained over a 120 hour period
awRR	Range	2 to 150 rpm
	Accuracy	±1 rpm

M3014A Sidestream CO ₂ Performance Specifications	
Warm-up Time	2 minutes with CO ₂ sensor attached for full accuracy specification
Sample Flow Rate	50 ±10 ml/minute
Total System Response Time	3 seconds
Operating Temperature	0 to 40°C (32 to 100°F)

M8102A/M3014A Mainstream and Sidestream CO₂ Humidity Correction Factor

Either BTPS or ATPD can be selected as the humidity correction factor for the CO₂ readings. The formula for the correction calculation is:

$$P_{\text{ATPD}} = P_{\text{BTPS}} \cdot \frac{P_{\text{abs}}}{P_{\text{abs}} - P_{\text{H}_2\text{O}}}$$

Where p = partial pressure, P_{abs} = absolute pressure, and P_{H₂O} = 42 mmHg @35°C and 100% RH.

M3016A Mainstream CO ₂ Performance Specifications		
CO ₂	Range	-4 to 150 mmHg (-0.5 to 20.0 kPa)
	Accuracy	after 20 minutes warmup and calibration: For values between 0 and 40 mmHg: ±2.2 mmHg (±0.29 kPa) For values between 40 and 76 mmHg: ±5.5% of reading The specifications are valid for 45% O ₂ and N ₂ or N ₂ O balance. Outside these conditions the accuracy reaches at a minimum the requirements of EN864/ISO9918.
	Resolution	Numeric: 1.0 mmHg (0.1 kPa) Wave: 0.1 mmHg (0.01 kPa)
	Stability	±1.0 mmHg over a 7 day period
awRR	Range	0 to 150 rpm
	Accuracy	±2 rpm
Warm-up Time	20 minutes with CO ₂ transducer attached for full accuracy specification	
Response Time	Less than 125 ms (for step from 10% to 90%)	

Mainstream CO₂ Humidity Correction Factor

Either BTPS or ATPD can be selected as the humidity correction factor for the Mainstream CO₂ readings. The formula for the correction calculation is:

$$P_{\text{ATPD}} = P_{\text{BTPS}} \cdot \frac{P_{\text{abs}}}{P_{\text{abs}} - P_{\text{H}_2\text{O}}}$$

Where p = partial pressure, P_{abs} = absolute pressure, and P_{H₂O} = 47 mmHg @37°C and 100% RH.

CO ₂ Alarm Specifications	Range	Adjustment	Delay
etCO ₂ High	20 to 95 mmHg (2 to 13 kPa)	1 mmHg (0.1 kPa)	M8102A/M3014A/M3016A: less than 14 seconds M3015A: less than 18 seconds.
etCO ₂ Low	10 to 90 mmHg (1 to 12 kPa)		
imCO ₂ High	2 to 20 mmHg (0.3 to 3.0 kPa)	steps of 1 mmHg (0.1 kPa)	M8102A/M3014A/M3016A: less than 14 seconds M3015A: less than 18 seconds.
awRR High	Adult/pedi: 10 to 100 rpm Neo: 30 to 150 rpm	under 20 rpm: 1 rpm steps over 20 rpm: 5 rpm steps	M8102A/M3014A/M3016A: less than 14 seconds M3015A: settings <20 rpm: less than 8 seconds >20 rpm: less than 18 seconds M8102A/M3014A/M3016A settings <20 rpm: less than 4 seconds >20 rpm: less than 14 seconds
awRR Low	Adult/pedi: 0 to 95 rpm Neo: 0 to 145 rpm		
Apnea delay	10 to 40 seconds	5 second steps	set apnea delay time +4 seconds (M8102A/M3014A/M3016A) or 8 seconds (M3015A)

Interfering Gas and Vapor Effects On CO₂ Measurement Values

The specified deviations for M8102A/M3014A are valid when the appropriate corrections are switched on and set correctly.

Gas or Vapor	Gas Level (% volume fraction)	M8102A/M3014A	M3015A
		Additional deviation due to gas interference, measured at 0 - 40 mmHg CO ₂	
Nitrous Oxide	60	±1 mmHg	±5%
Halothane	4	±2 mmHg	±5%
Enflurane	5	±2 mmHg	±5%
Isoflurane	5	±2 mmHg	±5%
Sevoflurane	5	±2 mmHg	±5%
Xenon	80	-5 mmHg	±5%
Helium	50	±1 mmHg	±5%
Metered dose inhaler propellants	-	not specified for use	
Desflurane	15	+5 mmHg	±5%
Ethanol	0.1	±1 mmHg	±5%
Isopropanol	0.1	±1 mmHg	±5%
Acetone	0.1	±1 mmHg	±5%
Methane	1.0	±1 mmHg	±5%

Safety and Performance Tests

You must observe any national regulations on the qualification of the testing personnel and suitable measuring and testing facilities. See the maintenance section for a list of required tests. Safety and performance tests, and what to do if the instrument does not meet these specifications are described in the Installation and Service guide.

Electromagnetic Compatibility (EMC) Specifications

Take special precautions regarding electromagnetic compatibility (EMC) when using medical electrical equipment. You must operate your monitoring equipment according to the EMC information provided in this book. Portable and mobile radio frequency (RF) communications equipment can affect medical electrical equipment.

Accessories Compliant with EMC Standards

All accessories listed in the accessories section comply, in combination with the monitor, with the requirements of IEC 60601-1-2:2001 + A1:2004.

WARNING Using accessories other than those specified may result in increased electromagnetic emission or decreased electromagnetic immunity of the monitoring equipment.

Electromagnetic Emissions

The monitor is suitable for use in the electromagnetic environment specified in the table below. You must ensure that it is used in such an environment

Emissions test	Compliance	Avoiding Electromagnetic Interference
Radio Frequency (RF) emissions	Group 1	The monitor uses RF energy only for its internal function. Therefore, its RF emissions are very low and are not likely to cause any interference in nearby electronic equipment
RF emissions CISPR 11 for the MP2 or X2 with all accessories except the M2741A Sidestream CO ₂ sensor	Class B	The monitor is suitable for use in all establishments, including domestic establishments and those directly connected to the public low-voltage supply network that supplies buildings used for domestic purposes.
RF emissions CISPR 11 for the MP2 or X2 whenever used with the M2741A Sidestream CO ₂ sensor	Class A	The monitor is suitable for use in all establishments other than those directly connected to the public low-voltage power supply network that supplies buildings used for domestic purposes.

Avoiding Electromagnetic Interference (Resp)

The respiration (Resp) measurement is a very sensitive measurement that measures a very small signal. Technological limitations do not allow higher immunity levels than 1 V/m for radiated RF electromagnetic fields and 1 V_{rms} for conducted disturbances induced by RF fields. Electromagnetic fields with field strengths above 1 V/m and conducted disturbances above 1 V_{rms} may cause erroneous measurements. Therefore Philips recommends that you avoid using electrically radiating equipment in the close proximity of this measurement.

WARNING The monitor should not be used next to or stacked with other equipment. If you must stack the monitor, you must check that normal operation is possible in the necessary configuration before you start monitoring patients.

Electromagnetic Immunity

The monitor is suitable for use in the specified electromagnetic environment. The user must ensure that it is used in the appropriate environment as described below.

Immunity test	IEC 60601-1-2 test level	Compliance level	Electromagnetic environment guidance
Electrostatic discharge (ESD) IEC 61000-4-2	±6 kV contact ±8 kV air	±6 kV contact ±8 kV air	Floors should be wood, concrete, or ceramic tile. If floors are covered with synthetic material, the relative humidity should be at least 30%.
Electrical fast transient/burst IEC 61000-4-4	±2 kV for power supply lines ±1 kV for input/output lines	±2 kV for power supply lines ±1 kV for input/output lines	Mains power quality should be that of a typical commercial and/or hospital environment
Surge IEC 61000-4-5	±1 kV differential mode ±2 kV common mode	±1 kV differential mode ±2 kV common mode	Mains power quality should be that of a typical commercial and/or hospital environment
Voltage dips, short interruptions and voltage variations on power supply input lines IEC 61000-4-11	<5% U_T (>95% dip in U_T) for 0.5 cycles 40% U_T (60% dip in U_T) for 5 cycles 70% U_T (30% dip in U_T) for 25 cycles <5% U_T (>95% dip in U_T) for 5 sec	<5% U_T (>95% dip in U_T) for 0.5 cycles 40% U_T (60% dip in U_T) for 5 cycles 70% U_T (30% dip in U_T) for 25 cycles <5% U_T (>95% dip in U_T) for 5 sec	Mains power quality should be that of a typical commercial and/or hospital environment. If the user of the monitor requires continued operation during power mains interruptions, it is recommended that the monitor is equipped with an internal battery or is powered from an uninterruptible power supply.
Power frequency (50/60 Hz) magnetic field IEC 61000-4-8	3 A/m	3 A/m	Power frequency magnetic fields should be at levels characteristic of a typical location in a typical commercial and/or hospital environment

In this table, U_T is the a.c. mains voltage prior to application of the test level.

Recommended Separation Distance

WARNING The monitor, equipped with a wireless network interface, intentionally receives RF electromagnetic energy for the purpose of its operation. Therefore, other equipment may cause interference, even if that other equipment complies with CISPR emission requirements.

In the following table, P is the maximum output power rating of the transmitter in watts (W) according to the transmitter manufacturer and d is the recommended separation distance in metres (m). The values given in brackets are for respiration.

Portable and mobile RF communications equipment should be used no closer to any part of the monitor, including cables, than the recommended separation distance calculated from the equation appropriate for the frequency of the transmitter.

Field strengths from fixed RF transmitters, as determined by an electromagnetic site survey, should be less than the compliance level in each frequency range.

Interference may occur in the vicinity of equipment marked with this symbol:



Immunity test	IEC 60601-1-2 test level	Compliance level	Electromagnetic environment guidance
Conducted RF IEC 61000-4-6	3 V _{RMS} 150 kHz to 80 MHz	3 V _{RMS} (1 V _{RMS} for respiration)	Recommended separation distance: d = 1,2√P : for respiration: d = 3,5√P :
Radiated RF IEC 61000-4-3	3 V/m 80 MHz to 2.5 GHz	3 V/m (1 V/m for respiration) For short range radio, see note ¹ .	Recommended separation distance: 80 MHz to 800 MHz d = 1,2√P 80 MHz to 800 MHz for respiration d = 3,5√P : 800 MHz to 2,5 GHz d = 2,3√P 800 MHz to 2,5 GHz for respiration d = 7,0√P 2.0 to 2,3 GHz for short range radio d = 7,0√P

1.If ECG/SpO₂ signals are acquired from a telemetry device via short range radio the compliance level is 3V/m except in the range 2.0 to 2.3 GHz where it is 1 V/m.

Field strengths from fixed transmitters, such as base stations for radio (cellular, cordless) telephones and land mobile radios, amateur radio, AM and FM radio broadcast and TV broadcast cannot be predicted theoretically with accuracy. To assess the electromagnetic environment due to fixed RF transmitters, an electromagnetic site survey should be considered. If the measured field strength in the location in which the monitor is used exceeds the applicable RF compliance level above, the monitor should be observed to verify normal operation. If abnormal performance is observed, additional measures may be necessary, such as reorienting or relocating the monitor.

These guidelines may not apply in all situations. Electromagnetic propagation is affected by absorption and reflection from structures, objects, and people.

Recommended separation distances from portable and mobile RF communication equipment

The monitor is intended for use in an electromagnetic environment in which radiated RF disturbances are controlled. The customer or user of the monitor can help prevent electromagnetic interference by maintaining a minimum distance between portable and mobile RF communications equipment and the monitor as recommended below, according to the maximum output power of the communications equipment.

In the following table, P is the maximum output power rating of the transmitter in watts (W) according to the transmitter manufacturer and d is the recommended separation distance in metres (m). The values given in brackets are for those measurements which do not use the general formula.

Frequency of transmitter	150 kHz to 80 MHz	80 MHz to 800 MHz	800 MHz to 2,5 GHz
Equation	$d = 1,2\sqrt{P}$ for respiration: $d = 3,5\sqrt{P}$	$d = 1,2\sqrt{P}$ for respiration: $d = 3,5\sqrt{P}$	$d = 2,3\sqrt{P}$ for respiration: $d = 7,0\sqrt{P}$ for short range radio in the range 2.0 to 2.3 GHz: $d = 7,0\sqrt{P}$
Rated max. output power of transmitter (W)	Separation distance (m)	Separation distance (m)	Separation distance (m)
0.01	0.1 (0.4)	0.1 (0.4)	0.2 (0.7)
0.1	0.4 (1.1)	0.4 (1.1)	0.7 (2.2)
1	1.3 (3.5)	1.3 (3.5)	2.3 (7.0)
10	3.8 (11.1)	3.8 (11.1)	7.3 (22.1)
100	12.0 (35.0)	12.0 (35.0)	23.0 (70.0)

Electrosurgery Interference/Defibrillation/Electrostatic Discharge

The equipment returns to the previous operating mode within 10 seconds without loss of any stored data. Measurement accuracy may be temporarily decreased while performing electro-surgery or defibrillation. This does not affect patient or equipment safety. Do not expose the equipment to x-ray or strong magnetic fields (MRI).

Fast Transients/Bursts

The equipment will return to the previous operating mode within 10 seconds without loss of any stored data. If any user interaction is required, the monitor indicates with a technical alarm (INOP).

Restart time

After power interruption, an ECG wave will be shown on the display after 30 seconds maximum.

Default Settings Appendix

This appendix documents the most important default settings of your monitor as it is delivered from the factory. For a comprehensive list and explanation of default settings, see the Configuration Guide supplied with your monitor. The monitor's default settings can be permanently changed in Configuration Mode.

Note: If your monitor has been ordered preconfigured to your requirements, the settings at delivery will be different from those listed here.

Country-Specific Default Settings

Certain default settings are specific to a particular country. These are listed here for all countries alphabetically.

Country-Description	Line Frequency	Units Weight	Units Height	ECG Cable Color
	50/60 [Hz]	kg, lb	in, cm	IEC, AAMI
Afghanistan	50	kg	cm	AAMI
Åland Islands	50	kg	cm	IEC
Albania	50	kg	cm	IEC
Algeria	50	kg	cm	IEC
American Samoa	60	lb	in	AAMI
Andorra	60	lb	in	AAMI
Angola	50	kg	cm	IEC
Anguilla	60	lb	in	AAMI
Antarctica	60	lb	in	AAMI
Antigua and Barbuda	50	kg	cm	AAMI
Argentina	50	kg	cm	AAMI
Armenia	50	kg	cm	IEC
Aruba	60	kg	cm	AAMI
Australia	50	kg	cm	AAMI
Austria	50	kg	cm	IEC
Azerbaijan	50	kg	cm	IEC
Bahamas, The	60	kg	cm	AAMI
Bahrain	50	kg	cm	AAMI
Bangladesh	60	lb	in	AAMI
Barbados	50	kg	cm	AAMI
Belarus	50	kg	cm	IEC
Belgium	50	kg	cm	IEC

Belize	60	lb	in	AAMI
Benin	60	lb	in	AAMI
Bermuda	60	kg	cm	AAMI
Bhutan	60	lb	in	AAMI
Bolivia	50	kg	cm	AAMI
Bosnia and Herzegovina	50	kg	cm	IEC
Botswana	50	kg	cm	IEC
Bouvet Island	60	lb	in	AAMI
Brazil	60	kg	cm	AAMI
British Indian Ocean Territory	60	lb	in	AAMI
Brunei Darussalam	50	kg	cm	AAMI
Brunei	50	kg	cm	IEC
Bulgaria	50	kg	cm	IEC
Burkina Faso	50	kg	cm	IEC
Burundi	50	kg	cm	IEC
Cambodia	50	kg	cm	IEC
Cameroon	50	kg	cm	IEC
Canada	60	kg	cm	AAMI
Cape Verde	60	lb	in	AAMI
Cayman Islands	60	kg	cm	AAMI
Central African Republic	50	kg	cm	IEC
Chad	60	lb	in	AAMI
Chile	50	kg	cm	AAMI
China	50	kg	cm	IEC
Christmas Islands	60	lb	in	AAMI
Cocos Keeling Islands	60	lb	in	AAMI
Colombia	60	kg	cm	AAMI
Comoros	60	lb	in	AAMI
Congo	50	kg	cm	IEC
Congo, Democratic Republic of the	50	kg	cm	IEC
Cook Islands	60	lb	in	AAMI
Costa Rica	60	kg	cm	AAMI
Côte d'Ivoire	50	kg	cm	IEC
Croatia	50	kg	cm	IEC
Cuba	60	kg	cm	IEC
Cyprus	50	kg	cm	IEC
Czech Republic	50	kg	cm	IEC
Denmark	60	lb	in	AAMI
Djibouti	50	kg	cm	IEC
Dominica	50	kg	cm	AAMI
Dominican Republic	60	kg	cm	AAMI
Ecuador	60	kg	cm	AAMI
Egypt	50	kg	cm	IEC
El Salvador	60	kg	cm	AAMI
Equatorial Guinea	50	kg	cm	IEC
Eritrea	50	kg	cm	IEC
Estonia	50	kg	cm	IEC
Ethiopia	50	kg	cm	IEC
Falkland Islands, Malvinas	60	lb	in	AAMI
Faroe Islands	60	lb	in	AAMI
Fiji	60	lb	in	AAMI

Finland	50	kg	cm	IEC
France	50	kg	cm	IEC
French Guiana	50	kg	cm	IEC
French Polynesia	60	lb	in	AAMI
French Southern Territories	60	lb	in	AAMI
Gabon	50	kg	cm	IEC
Gambia, The	50	kg	cm	IEC
Georgia	60	lb	in	AAMI
Germany	50	kg	cm	IEC
Ghana	50	kg	cm	IEC
Gibraltar	60	lb	in	AAMI
Greece	50	kg	cm	IEC
Greenland	60	lb	in	AAMI
Grenada	50	kg	cm	AAMI
Guadeloupe	50	kg	cm	IEC
Guam	60	lb	in	AAMI
Guatemala	60	kg	cm	AAMI
Guernsey	50	kg	cm	IEC
Guinea	60	lb	in	AAMI
Guinea-Bissau	60	lb	in	AAMI
Guyana	60	kg	cm	AAMI
Haiti	60	kg	cm	AAMI
Heard Island and McDonald Islands	60	lb	in	AAMI
Holy See, Vatican City State	60	lb	in	AAMI
Honduras	60	kg	cm	AAMI
Hong Kong	50	kg	cm	IEC
Hungary	50	kg	cm	IEC
Iceland	50	kg	cm	IEC
India	50	kg	cm	IEC
Indonesia	50	kg	cm	IEC
Iran, Islamic Republic of	50	kg	cm	AAMI
Iraq	50	kg	cm	AAMI
Ireland	50	kg	cm	IEC
Isle of Man	50	kg	cm	IEC
Israel	50	kg	cm	IEC
Italy	50	kg	cm	IEC
Jamaica	50	kg	cm	AAMI
Japan	60	kg	cm	IEC
Jersey	50	kg	cm	IEC
Jordan	50	kg	cm	AAMI
Kazakhstan	50	kg	cm	IEC
Kenya	50	kg	cm	IEC
Kiribati	60	lb	in	AAMI
Korea, Democratic People's Republic of	60	lb	in	AAMI
Korea, Republic of	60	kg	cm	AAMI
Kuweit	50	kg	cm	AAMI
Kyrgyzstan	60	lb	in	AAMI
Lao People's Democratic Republics	50	kg	cm	IEC
Latvia	50	kg	cm	IEC
Lebanon	50	kg	cm	AAMI
Lesotho	50	kg	cm	IEC

Liberia	50	kg	cm	IEC
Libyan Arab. Jamahiriya	60	lb	in	AAMI
Liechtenstein	60	lb	in	AAMI
Lithuania	50	kg	cm	IEC
Luxembourg	50	kg	cm	IEC
Macao	60	lb	in	AAMI
Macedonia, The former Yugoslavian Republic of	50	kg	cm	IEC
Madagascar	50	kg	cm	IEC
Malawi	50	kg	cm	IEC
Malaysia	50	kg	cm	IEC
Maldives	60	lb	in	AAMI
Mali	50	kg	cm	IEC
Malta	50	kg	cm	IEC
Marshall Islands	60	lb	in	AAMI
Martinique	60	kg	cm	IEC
Mauritania	50	kg	cm	IEC
Mauritius	60	lb	in	AAMI
Mayotte	60	lb	in	AAMI
Mexico	60	kg	cm	AAMI
Micronesia, Federal States of	60	lb	in	AAMI
Moldova, Republic of	60	lb	in	AAMI
Monaco	60	lb	in	AAMI
Mongolia	60	lb	in	AAMI
Montenegro	50	kg	cm	IEC
Montserrat	50	kg	cm	AAMI
Morocco	50	kg	cm	IEC
Mozambique	50	kg	cm	IEC
Myanmar	60	lb	in	AAMI
Namibia	50	kg	cm	IEC
Nauru	60	lb	in	AAMI
Nepal	60	lb	in	AAMI
Netherlands	50	kg	cm	IEC
Netherlands Antilles	50	kg	cm	AAMI
New Caledonia	60	lb	in	AAMI
New Zealand	50	kg	cm	AAMI
Nicaragua	60	kg	in	AAMI
Niger	50	kg	cm	IEC
Nigeria	50	kg	cm	IEC
Niue	60	lb	in	AAMI
Norfolk Islands	60	lb	in	AAMI
Northern Mariana Islands	60	lb	in	AAMI
Norway	50	kg	cm	IEC
Oman	50	kg	cm	AAMI
Pakistan	50	kg	cm	IEC
Palau	60	lb	in	AAMI
Palestinian Territory	50	kg	cm	AAMI
Panama	60	lb	in	AAMI
Papua New Guinea	60	lb	in	AAMI
Paraguay	50	kg	cm	AAMI
Peru	60	kg	cm	AAMI

Philippines	60	kg	cm	AAMI
Pitcairn	60	lb	in	AAMI
Poland	50	kg	cm	IEC
Portugal	50	kg	cm	IEC
Puerto Rico	60	lb	in	AAMI
Qatar	50	kg	cm	AAMI
Reunion	60	lb	in	AAMI
Romania	50	kg	cm	IEC
Russian Federation	50	kg	cm	IEC
Rwanda	50	kg	cm	IEC
Saint Helena	60	lb	in	AAMI
Saint Kitts and Nevis	60	kg	cm	AAMI
Saint Lucia	50	kg	cm	AAMI
Saint Pierre and Miquelon	60	lb	in	AAMI
Saint Vincent and the Grenadines	50	kg	cm	AAMI
Samoa	60	lb	in	AAMI
San Marino	60	lb	in	AAMI
Sao Tome and Principe	60	lb	in	AAMI
Saudi Arabia	50	kg	cm	AAMI
Senegal	50	kg	cm	IEC
Serbia	50	kg	cm	IEC
Serbia & Montenegro	50	kg	cm	IEC
Seychelles	60	lb	in	AAMI
Sierra Leone	50	kg	cm	IEC
Singapore	50	kg	cm	IEC
Slovakia	50	kg	cm	IEC
Slovenia	50	kg	cm	IEC
Solomon Islands	60	lb	in	AAMI
Somalia	50	kg	cm	IEC
South Africa	60	lb	in	AAMI
South Georgia and the South Sandwich Islands	60	lb	in	AAMI
Spain	50	kg	cm	IEC
Sri Lanka	60	lb	in	AAMI
Sudan	50	kg	cm	IEC
Suriname	60	kg	cm	AAMI
Svalbard and Jan Mayen	60	lb	in	AAMI
Swaziland	60	lb	in	AAMI
Sweden	50	kg	cm	IEC
Switzerland	50	kg	cm	IEC
Syrian Arab Rep	50	kg	cm	AAMI
Taiwan, Province of China	60	kg	cm	AAMI
Tajikistan	60	lb	in	AAMI
Tanzania, United Republic of	60	lb	in	AAMI
Thailand	50	kg	cm	AAMI
Timor-Leste	60	lb	in	AAMI
Togo	60	lb	in	AAMI
Tokelau	60	lb	in	AAMI
Tonga	60	lb	in	AAMI
Trinidad and Tobago	60	lb	in	AAMI
Tunisia	50	kg	cm	IEC

Turkey	50	kg	cm	IEC
Turkmenistan	60	lb	in	AAMI
Turks and Caicos Islands	60	kg	cm	AAMI
Tuvalu	60	lb	in	AAMI
Uganda	60	lb	in	AAMI
Ukraine	60	lb	in	AAMI
UK	50	kg	cm	IEC
United Arab Emirates	50	kg	cm	AAMI
United Kingdom	50	kg	cm	IEC
United States	60	lb	in	AAMI
United States Minor Outlying Islands	60	lb	in	AAMI
Uruguay	50	kg	cm	AAMI
Uzbekistan	60	lb	in	AAMI
Vanuatu	60	lb	in	AAMI
Venezuela	60	lb	in	AAMI
Viet Nam	50	kg	cm	IEC
Virgin Islands (British)	50	kg	cm	AAMI
Virgin Islands (US)	60	lb	in	AAMI
Wallis and Futuna Islands	60	lb	in	AAMI
Western Sahara	50	kg	cm	IEC
Yemen	50	kg	cm	AAMI
Zambia	60	lb	in	AAMI
Zimbabwe	60	lb	in	AAMI

Alarm and Measurement Default Settings

Settings are only entered once per table row if they are the same for all patient categories¹.

Alarm Default Settings

Alarm Settings	Factory Default
Alarm Volume	5
Alarms Off	2 min.
Pause Al. 5min	Enabled
Pause Al. 10min	Enabled
Auto Alarms Off	Off
Alarm Off Reminder	Off
Visual Latching	Red & Yell
Audible Latching	Red & Yell
Alarm Reminder	On
Reminder Time	3 min
Alarm Sounds	Traditional
Red Alarm Interval	10 sec
Yel. Al. Interval	20 sec
Alarm Low	4
Red Alarm Volume	AlarmVol +2
Yell. Alarm Volume	AlarmVol +0
Inop Volume	AlarmVol +0
Auto Increase Vol.	2 Steps
Increase Vol Delay	20 sec
Keep Blinking	No
Relay 1 Sensitiv.	R & Y & I
Relay 2 Sensitiv.	Red & Yell
Relay 3 Sensitiv.	Red
Inop Relay Latency	5 sec
Yel. Relay Latency	2 sec
Alarm Text	Standard
No Centr Mon Min Vol	4

¹A profile "Outdoor" exists for use in typical outdoor conditions (bright sunlight, higher ambient noise). See the Configuration Guide for details.

ECG, Arrhythmia, ST and QT Default Settings

ECG Settings	Factory Defaults		
	Adult	Pedi	Neo
High Limit	120 bpm	160 bpm	200 bpm
Low Limit	50 bpm	75 bpm	100 bpm
Alarms	On		
Alarm Source	Auto		
ECG	On		
QRS Volume	1		
Primary Lead	II		
Secondary Lead	V		
Analysis Mode	Multi-lead		
Lead Placement	Standard		
Mod. Lead Placment	Off		
Filter	Monitor		
Speed	25 mm/s		
Auto Filter	Off		
Default ECG Size	x1		
Color	Green		
Asystole Thresh	4.0 sec		3.0 sec
Δ ExtrTachy	20 bpm		
Tachy Clamp	200 bpm	220 bpm	240 bpm
Δ ExtrBrady	20 bpm		
Brady Clamp	40 bpm		50 bpm
ALL ECG IN.	On		
Fallback	On		
Alarms Off	Enabled		
Alarm Source Sel.	Enabled		
Va Lead	V2		
Vb Lead	V5		
SyncPulse sensit	Medium		
SyncPulse Marker	On		
Fallback ECGTele	Enabled		

Arrhythmia Settings	Factory Defaults		
	Adult	Pedi	Neo
Arrhythmia	On		Off
Pause Threshold	2.0 sec		1.5 sec
VTach HR	100	120	150
VTach Run	5		

Arrhythmia Settings	Factory Defaults		
	Adult	Pedi	Neo
Vent Rhythm	14		
SVT HR	180	200	210
SVT Run	5		
PVCs/min	10	5	5
Non-Sustain	On		
Vent Rhythm	On		
Run PVCs	On		
Pair PVCs	On		
R-On-T PVCs	On		
V.Bigeminy	On		
V.Trigeminy	On		
PVCs/min	On		
Multif. PVCs	On		
Pacer N. Cap	On		
Pacer N. Pac	On		
Pause	On		
Missed Beat	On		
SVT	On		
Afib	On		
IrregularHR	On		
HR Alarms	Short Yell		
TimeOut 1st	3 min		
TimeOut 2nd	10 min		
Arrhy Off Message	Yes		
SOME ECG IN	On		

Lead-independent ST Settings	Factory Defaults		
	Adult	Pedi	Neo
ST Alarm Mode	Single ST		
Alarms	On		
ST Analysis	On	Off	
ST-Index	On		
ISO Point	-80 ms		
J Point	48 ms		
ST Point	J+60		

Lead I, II, III, V, aVR, aVL, aVE, V1-6, MCL Settings	Factory Defaults		
	Factory Adult	Factory Pedi	Factory Neo
ST(Label)	On	Off	
For Alarm Mode = Single-ST			
ST(Label) High	+2.0 mm		
ST(Label) Low	-2.0 mm		
For Alarm Mode = Multi-ST			
ST(Label) High	+1.0 mm		
ST(Label) Low	-1.0 mm		

QT Settings	Factory Defaults		
	Factory Adult	Factory Pedi	Factory Neo
QT Lead	All		
QTc High Limit	500 ms	480 ms	460 ms
Δ QTc Limit	60 ms		
QTc High Alarm On/Off	On		
Δ QTc High Alarm On/Off	On		
QT Analysis	Off		
QTc Formula	Bazett		

Pulse Default Settings

Pulse Settings	Factory Defaults		
	Adult	Pedi	Neo
Alarms Source	Auto		
Pulse (Label)	On		
System Pulse	SpO ₂		
Alarms Off	Enabled		
Alarm Source Sel.	Enabled		

Pulse Alarm Settings	Factory Defaults		
	Adult	Pedi	Neo
Pulse (SpO ₂)	On		
Pulse Alarms	Off		
High Limit	120 bpm	160 bpm	200 bpm
Low Limit	50 bpm	75 bpm	100 bpm
Δ Extr Brady	20 bpm		
Brady Clamp	40 bpm	40 bpm	50 bpm
Δ Extr Tachy	20 bpm		
Tachy Clamp	200 bpm	220 bpm	240 bpm

Pulse alarms use the settings of the currently selected Pulse alarm source.

Respiration Default Settings

Respiration Settings	Factory Defaults		
	Adult	Pedi	Neo
High Limit	30 rpm		100 rpm
Low Limit	8 rpm		30 rpm
Apnea Time	20 sec		
Alarms	On		
Resp	On		
Auto/Manual	Auto (Trigger Mode)		
Resp Speed	6.25 mm/s		
Color	Yellow		

SpO₂ Default Settings

SpO ₂ Settings	Factory Defaults			
	Adult	Pedi	Neo	
Alarms	On			
QRS Volume	1			
Tone Modulation	Yes			
Tone Mod. Type	Enhanced			
Speed	25 mm/s			
Perfusion	On			
Average	10 sec			
NBP Alarm Suppr.	On			
Extd. Auto OnOff	Disabled			
Color	light blue (cyan)			

SpO ₂ Alarm Default Settings			
Setting	Adult	Pediatric	Neonatal
Desat Limit	80	80	80
Low Limit	90	90	85
High Limit	100	100	95
Desat delay	20 sec	20 sec	20 sec
High Alarm delay	10 sec	10 sec	10 sec
Low Alarm delay	10 sec	10 sec	10 sec
Parameter Alarms On/Off	on	on	on
Label	SpO ₂	SpO ₂	SpO ₂
Pulse Settings			
Pulse (SpO ₂) On/Off	on	on	on
Pulse Alarms On/Off	on	on	on
Pulse High Limit	120 bpm	160 bpm	200 bpm
Pulse Low Limit	50 bpm	75 bpm	100 bpm
Δ Extr Brady	20 bpm	20 bpm	20 bpm
Brady Clamp	40 bpm	40 bpm	50 bpm
Δ Extr Tachy	20 bpm	20 bpm	20 bpm
Tachy Clamp	200 bpm	220 bpm	240 bpm

NBP Default Settings

NBP Settings	Factory Defaults		
	Adult	Pedi	Neo
Mode	Auto		Manual
Alarms from	Sys.		
High Alarm Limit	160/90 (110)	120/70 (90)	90/60 (70)
Low Alarm Limit	90/50 (60)	70/40 (50)	40/20 (24)
Alarms	On		
NBP	On		
Repetition Time	10 min		
Pulse (NBP)	On		
Unit	mmHg		
Done Tone	Off		
Start Time	Synchronized		
VP Pressure	60 mmHg	40 mmHg	30 mmHg
Reference	Auscultatory		Invasive
Color	Red		

Temperature Default Settings

Temp Settings	Factory Defaults		
	Adult	Pedi	Neo
Low Limit	36		
High Limit	39		
Alarms	On		
Unit	°C		
Range	35...43		
Color	Green		

Invasive Pressure Default Settings

ABP, ART, Ao, BAP, FAP, P, P1, P2, P3, P4, UAP Settings	Factory Defaults		
	Adult	Pedi	Neo
Alarms from	Sys.		
High Limit	160/90 (110)	120/70 (90)	90/60 (70)
Low Limit	90/50 (70)	70/40 (50)	55/20 (36)
Alarms	On		
Extreme Alarms	Disabled		

ABP, ART, Ao, BAP, FAP, I, P1, P2, P3, P4, UAP Settings	Factory Defaults		
	Adult	Pedi	Neo
ΔExtreme High	15	10	5
ΔExtreme Low	15	10	5
High Clamp	190/100 (125)	140/80 (100)	105/75 (75)
Low Clamp	80/45 (65)	60/35 (45)	45/15 (30)
Scale	150	100	100
Speed	25 mm/s		
Mean Only	No		
Filter	12 Hz		
Mercury Cal.	Yes		
Artifact Suppr.	60 sec		
Unit	mmHg		
Color	Red		

CVP, RAP, LAP, UVP Settings	Factory Defaults		
	Adult	Pedi	Neo
Alarms from	Mean		
High Limit	14/6 (10)	10/2 (4)	10/2 (4)
Low Limit	6/-4 (0)	2/-4 (0)	2/-4 (0)
Alarms	On		
Extreme Alarms	Enabled		
ΔExtreme High	5	5	5
ΔExtreme Low	5	5	5
High Clamp	20/10 (15)	15/5 (10)	15/5 (10)
Low Clamp	0/-5 (-5)	0/-5 (-5)	0/-5 (-5)
Scale	30		
Speed	25 mm/s		
Mean Only	Yes		
Filter	12 Hz		
Mercury Cal.	Yes		
Artifact Suppr.	60 sec		
Unit	mmHg		
Color	light blue (cyan)		
Average in Mon.	No		
Signal Quality	On		

PAP Settings	Factory Defaults		
	Adult	Pedi	Neo
Alarms from	Dia.		
High Limit	34/16 (20)	60/4 (26)	60/4 (26)
Low Limit	10/0 (0)	24/-4 (12)	24/-4 (12)
Alarms	On		
Extreme Alarms	Enabled	Enabled	Enabled
ΔExtreme High	5	5	5
ΔExtreme Low	5	5	5
High Clamp	45/20 (25)	65/5 (35)	65/5 (35)
Low Clamp	5/-5 (-5)	15/-5 (5)	15/-5 (5)
Scale	30		
Speed	25 mm/s		
Mean Only	No		
Filter	12 Hz		
Mercury Cal.	Yes		
Artifact Suppr.	60 sec		
Unit	mmHg		
Color	Yellow		

ICP, IC1, IC2 Settings	Factory Defaults		
	Adult	Pedi	Neo
Alarms from	Mean		
High Limit	14/6 (10)	10/2 (4)	10/2 (4)
Low Limit	6/-4 (0)	2/-4 (0)	2/-4 (0)
Alarms	On		
Extreme Alarms	Enabled	Enabled	Enabled
ΔExtreme High	10	10	10
ΔExtreme Low	10	10	10
Low Clamp	20/10 (-5)	15/5 (-5)	15/5 (-5)
High Clamp	0/-5 (0)	0/-5 (0)	0/-5 (0)
Scale	30		
Speed	25 mm/s		
Mean Only	Yes		
Filter	12 Hz		
Mercury Cal.	Yes		
Artifact Suppr.	60 sec		
Unit	mmHg		
Color	Magenta		

CO₂ Default Settings

CO ₂ Settings	Factory Defaults		
	Adult	Pedi	Neo
etCO ₂ low	30		
etCO ₂ high	50		
imCO ₂ high	4		
CO ₂ Alarms	on		
Unit	mmHg		
Scale	40 mmHg		
ImCO ₂	on		
N ₂ O Corr (only M3015A/M3016A)	Off		
Oxygen Corr (only M3014A)	16%		
Gas Corr (only M3014A)	Off		
Humidity Corr	BTPS		
Max Hold	Off		
AwRR	On		
AwRR Alarms	On		
AwRR high limit	30		100
AwRR low limit	8		30
Apnea time	20 secs		
Color	Yellow		

Index

#

- 10-lead placement (ECG) 99
- 12-lead placement (ECG) 99
- 3-lead placement (ECG) 97
- 5-lead placement (ECG) 97

A

- AAMI ECG lead labels 96
- abdominal breathing
 - and Resp electrode placement 138
- aberrantly conducted beats 106
- accessories
 - 10-electrode cable sets 230
 - 3-electrode cable sets 230, 232
 - 5-electrode cable sets 230, 232
 - 5-electrode one piece cables 232
 - 6-electrode cable sets 230
 - CO2 173
 - CO2 (mainstream) 239, 240
 - CO2 (microstream) 240
 - ECG 229
 - NBP
 - adult cuffs 234
 - comfort cuffs 233
 - disposable cuffs 233
 - multi-patient comfort cuff kits 233
 - neonatal/infant cuffs (disposable) 234
 - reusable cuffs 233
 - single-hose disposable cuffs 234
 - Nellcor 235
 - pressure 234
 - Pulsion 234
 - resp 229
 - set combiners and organizers 231, 232
 - SpO2 235
 - Nellcor adhesive sensors (disposable) 235
 - Philips sensors (disposable) 235
 - Philips sensors (reusable) 235
 - temperature 239
 - trunk cables 229, 231
- active alarms 39
- address, Philips 244
- addressograph (printer configuration setting) 209
- adjusting ST measurement points 120
- adjusting wave scale (pressure) 163

- adjusting wave size (CO2) 174
- admit
 - editing information 85
 - quick admit 85
- admitting a patient 83
- airway adapter
 - CO2, microstream accessory 173
- alarm latching 50, 112
- alarm limits
 - changing 46
 - checking 45
 - manually adjusting 46
 - narrow 48
 - report 210
 - ST 122
 - switching auto limits on/off 48
 - using automatic limits 48
 - wide 48
 - window 45
- alarm recording
 - choosing recorded measurements 200
- alarm source selection, disabled 135
- alarms
 - acknowledging 42
 - active 39
 - active SpO2 source 148
 - alphabetical listing 53
 - apnea delay 176
 - apnea delay time (Resp) 140
 - arrhythmia 39
 - audible indicators 41
 - awrr limits 176
 - chaining 114
 - CO2 specific 175
 - CO2, apnea delay 176
 - CO2, awRR 176
 - desat, SpO2 147
 - effect on pressure alarms during zero 161
 - extending pause time 44
 - high priority 39
 - INOP 39
 - ISO/IEC standard 41
 - key 16
 - limit, SpO2 260
 - message field 17
 - NBP source 154
 - off indicator 17
 - patient messages 53
 - pausing 43

- physiological 53
 - pleth as source 148
 - recordings 51
 - red 39
 - reminder 43
 - restarting 44
 - reviewing window 49
 - selftest 51
 - silencing 42
 - SpO2 high and low limits 147
 - SpO2 specific 146
 - ST 122
 - suspended symbol 44
 - switching on and off 44
 - temperature 157
 - testing 51
 - tone configuration 41
 - traditional 41
 - visual indicators 40
 - volume, changing 41
 - yellow 39
- alarms key 16
 - alphabetical listing of alarms 53
 - analog output
 - ECG 246
 - apnea alarm delay
 - CO2 176
 - apnea alarm delay time (RESP) 140
 - apnea alarms
 - and Resp detection modes 140
 - arrhythmia
 - aberrantly conducted beats 106
 - analysis, how it works 105
 - atrial fibrillation and flutter 106
 - beat labels 108
 - initiating learning 110, 111
 - intermittent bundle branch block 107
 - learning during ventricular rhythm 111
 - levels of analysis 102, 105
 - monitoring non-paced patients 106
 - monitoring paced patients 106
 - options 105
 - relearning 110
 - relearning and lead fallback 111
 - status messages 109
 - switching on/off 106
 - understanding the display 107
 - arrhythmia alarms 39, 111
 - adjusting alarm limits 112
 - all yellow on/off 112

- chaining 114
- latching 112
- multiple 114
- pvc-related alarms 115
- sinus and SV rhythm ranges 257, 260
- switching on/off 112
- timeout periods 113
- arrhythmia monitoring and defibrillation 104
- arrhythmia options 102
- arrhythmia relearning with EASI INOP 101
- arterial pressure source 166
- arterial pulsation 143
- artifact suppression (pressure) 163
- atrial fibrillation and flutter 106
- audlatching (arrhythmia alarms) 112
- auto alarm limits
 - switching on/off 48
 - using 48
- auto detection mode (Resp) 138
- autofilter 94
- automatic arrhythmia relearn 111
- automatic default setting 27
- automatic NBP
 - repeat time 154
- autosize
 - ECG wave 94
- awRR alarm
 - limits 176
- awRR alarms
 - CO2 176

B

- baseline
 - ST map, updating 125
 - ST, updating 119
- basic arrhythmia option 102, 105
- battery
 - and display brightness 221
 - battery reports 220
 - battery status window 219
 - charge status 220
 - compartment 217
 - conditioning 222
 - conserving power 221
 - indicators 218
 - LED 218
 - malfunction indicator 219
 - malfunction symbols 218
 - monitoring time 219
 - power gauge 218
 - recharging 217
 - replacing 220
 - safety information 222

- status indicator 18, 219
- symbol 245
- time to empty 220
- time to full 220
- battery eject symbol 245
- battery performance
 - optimizing 221
- battery status indicator 18
- beat labels
 - arrhythmia 108
- bed information 33
- blood pressure. See also NBP (non-invasive) or PRESS (invasive)
- Brightness SmartKey 30
- brightness, adjusting 30

C

- calculating cerebral perfusion 166
- calculating temperature difference 158
- calibrating
 - CO2 transducer 171
- calibration
 - interval, NBP 226
 - NBP 156
 - pressure 165
 - pressure transducer 165
- capnography
 - mainstream 14
 - Microstream 14
- carbon dioxide, see CO2 167
- cardiac overlay
 - and Resp detection modes 139
 - when measuring Resp 137
- cardiotach alarms 102
- cautions 9
- central recorder
 - choosing 200
- cerebral perfusion 166
- chaining 114
- change screen menu 23
- change screen window 16, 24
- Changing 23
- changing ECG lead sets 96
- changing Resp detection mode 138
- changing Resp wave size 139
- changing Resp wave speed 140
- changing screen content 23
- channels
 - recorder 200
- checking battery charge 220
- checking paced status 90
- checklist
 - delivery 2

- installation 1
- cleaning
 - infection control 213
 - method 214
 - monitoring accessories 215
 - recommended substances 214

CO2

- airway adapter 173
- alarms, apnea delay 176
- alarms, awRR 176
- alarms, specific 175
- awRR alarm limits 176
- checking transducer accuracy 171
- correction, humidity 175
- correction, N2O 175
- corrections 174
- FilterLine 173
- measuring mainstream 168, 171
- measuring microstream 173
- method, mainstream 167
- method, microstream 167
- method, sidestream 167
- microstream accessories 173
- microstream extension 173
- removing exhaust gases 171, 174
- transducer, calibrating 171
- transducer, using 172
- troubleshooting 174
- wave scale, adjusting 174

CO2 (mainstream).

- accessories 239, 240

CO2 (microstream).

- accessories 240

- conditioning batteries 222

- configuration mode 22

- entering 7

- conflict

- label 28

- connecting power 4

- connecting temperature probe 157

- connection direction symbol 245

- connectors 246

- temp 157

- conventional 12-lead ECG 99

- correcting the NBP measurement 153

- CPAP (RESP) 139

- cuff

- pressure, NBP 154

- selection, NBP 153

- current view

- ST map 122

D

- damage

- mechanical 31

damage claims 2
 date, setting 7, 30
 DC power symbol 245
 default profile 26
 default settings 271
 checking country-specific 7
 defibrillation
 and arrhythmia monitoring 104
 and ECG monitoring 104
 synchronization marks 91
 defibrillator proof symbol 245
 defibrillator synch
 maintenance interval 226
 delay time
 recording 201
 demonstration mode 22
 desat alarm, SpO₂ 147
 detection modes (Resp) 138
 diagnostic (ECG filter setting) 95
 discharging a patient 85
 disconnect INOPs
 silencing 43
 disinfecting
 infection control 213
 recommended substances 214
 display
 arrhythmia 107
 ECG 91
 NBP 153
 Resp 138
 ST 118
 display brightness 221
 display settings 25
 disposal
 gas cylinder 227
 parts and accessories 227
 dual Temp measurement 158
 dyshemoglobins
 intravascular (SpO₂) 145

E

early systolic blood pressure, NBP 154
 EASI
 activating 95
 ECG monitoring 101
 lead placement 101
 EASI ECG lead labels 96
 ECG 89
 accessories 229
 alarms off (Config Mode) 103
 changing lead sets 96
 choosing electrode sites 95
 conventional 12-lead 99
 external pacing electrodes 105

 filter settings 94
 fusion beat pacemakers 105
 intrinsic rhythm 104
 modified 12-lead 99
 New Lead Setup 96
 pacemaker failure 104
 rate adaptive pacemakers 105
 unfiltered 95
 wave size 93

ECG analog output 246

ECG cable

 for operating room 104

ECG cables, connecting 90

ECG connector 90

ECG display 91

ECG electrode colors 96

ECG electrode placement
 during electro-surgery 104

ECG gain
 in reports 204

ECG lead labels 96

ECG lead placement

 choosing EASI/Standard 95

ECG leads monitored 96

ECG report 211

 lead layout 204

ECG safety information 104

ECG source tracking 183

ECG wave

 autosize 94

 calibration bar 94

ectopic status messages (arrhythmia monitoring) 110

electrical output symbol 245

electrode placement (ECG) 89

 conventional 12-lead 99

 modified 12-lead 99

electrode placement (Resp) 137

 with abdominal breathing 138

 with lateral chest expansion 138

electro-surgery

 and ECG 104

EMC interference

 Resp 140

EMI filter for ECG 94

end case

 discharging a patient 85

 report, printing 85

end case reports

 setup 205

enhanced arrhythmia option 102, 105

exclamation mark symbol 245

exhaust gases, removing 171, 174

extension cable for SpO₂ 144

external pacing electrodes

 and ECG monitoring 105

extreme bradycardia alarm 103, 135

extreme pressure alarms 164

extreme rate alarms 103, 135

extreme tachycardia alarm 103, 135

F

fallback (ECG) 96

FAST

 Fourier artefact suppression
 technology 143

filter (ECG filter setting) 94

filter (ECG) 94

FilterLine

 CO₂, microstream accessory 173

flushing invasive pressure accessories 159

functional arterial oxygen saturation 143

fusion beat pacemakers

 and ECG monitoring 105

G

gas cylinder

 empty, disposing of 227

getting started 31

global trend time 195

graphic trends 188

graphic trends report 192

H

hemodynamic measurement extension 15

hemodynamic MMS extension 15

horizon trend

 trend time 195

HR = RR (Resp) 138

HR alarms

 when arrhythmia off 103

HR alarms off (Config Mode) 103

HR and pulse alarm source selection 135

HR from (heart rate source) 134

humidity correction

 CO₂ 175

I

IEC ECG lead labels 96

If 183

IIT 32

IMV (Resp) 139

indicators

 battery malfunction 219

 battery status 18, 219

infection control

- cleaning 213
- disinfecting 213
- sterilizing 213
- Information Center
 - central recording 199
 - transferring patients 86
- INOPs
 - indicators 39
 - message field 17
 - silencing 43
- installation
 - checklist 1
 - connectors 246
 - personnel 1
- Instructions for Use
 - intended audience 9
- IntelliVue Instrument Telemetry System (IIT) 32
- intermittent bundle branch block 107
- intermittent mandatory ventilation (Resp) 139
- interruption symbol 245
- intravascular dyshemoglobins (SpO2) 145
- intrinsic rhythm 104
- ISO point (ST) 120

J

- J point (ST) 120

K

- keyboard, on screen 21
- keys
 - alarms 16
 - main screen 16
 - pop-up 21
 - silence 16
 - SmartKeys 16

L

- label conflict resolution 28
- label conflicts, resolving 28
- labels 28
 - changing 28
- LAN connection 4
- latching
 - alarms 50
 - alarms, behavior 50
- latching arrhythmia alarms 112
- lateral chest expansion (neonates)
 - monitoring Resp 138
- lead fallback
 - and arrhythmia relearning 111
- lead fallback (ECG) 96
- lead labels (ECG) 96

- lead placement
 - activating EASI/Standard 95
 - for Resp measurement 137
- leads monitored (ECG) 96
- Leads Off INOP (ECG) 96
- levels of arrhythmia analysis 105

M

- main screen key 16
- main setup 19
- mains power
 - connecting to 3
- mainstream
 - capnography 14
- mainstream CO2
 - measuring 168, 171
- maintenance
 - cables 225
 - cords 225
 - measurements, schedule 226
 - microstream CO2, calibration 226
 - schedule 225
 - visual inspection 225
- malfunction symbols
 - battery 218
- manual detection mode (Resp) 139
 - and apnea alarms 140
- manufacture date symbol 245
- manufacturer's information 244
- map
 - ST 122
- Mason-Likar lead system 99
- max hold setting (CO2) 168
- measurement
 - adjusting a wave 27
 - preparation 31
 - setting up 27
 - wave speed, changing 27
- measurement extension
 - M3012A 15
 - M3015A 14
 - M3016A 14
- measurement label 17
- measurement labels 28
 - changing 28
- measurement points, ST 120
- measurement server
 - ECG connector 90
- measurement settings 25
- measurement setup menu 18
- measurements
 - setting up 31
 - switching on and off 27
- mechanical damage 31

- menu
 - main setup 19
 - measurement setup 18
- merging patient data 88
- messages
 - alarm 17
 - INOP 17
 - status and prompt 18
- methemoglobin (SpO2) 145
- Microstream capnography 14
- microstream CO2 173
 - accessories 173
 - maintenance, calibration 226
 - measuring 173
- mismatch
 - patient data, resolving 87
- MMS extensions 14
- modified 12-lead ECG 99
- modifying
 - screens 23
- monitor
 - inspecting before use 31
 - quick operating guide 6
 - starting monitoring 32
 - switching on 31
- monitor (ECG filter setting) 94
- monitor defaults 271
- monitor revision
 - how to find 30
- monitor settings 25
 - changing 30
- monitoring
 - preparation 31
 - starting 31
- monitoring mode 22
- mounting
 - power supply 3
- mounting information 3
- MSL cable 4
- multi-lead ST alarming 122

N

- N2O correction
 - CO2 175
- narrow alarm limits 48
- NBP
 - adult cuffs 234
 - alarm source 154
 - ANSI/AAMI SP10-1992 151
 - automatic mode, enabling 154
 - calibrating 156
 - calibration interval 226
 - comfort cuff kits 233
 - comfort cuffs 233

cuff pressure 154
cuff, applying 153
cuff, selecting 153
cuff, tightness 153
disposable cuffs 233
how the measurement works 151
measurement correction 153
measurement limitations 152
measurement methods, auto 152
measurement methods, manual 152
measurement methods, sequence 152
measurement methods, stat 152
measurement, starting 154
measurement, stopping 154
neonatal cuffs (disposable) 234
numerics 153
oscillometric method 151
pediatric cuffs 234
preparing to measure 152
repeat time 153
repeat time for automatic 154
repetition time, setting 154
reusable cuffs 233
single-hose disposable cuffs 234
site inspection 153
time of last measurement 153
units 153
venous puncture 155

neonates
 Resp electrode placement 138

network connection indicator 17

networked monitoring 33

new features 35

non-invasive blood pressure. See NBP

non-paced patients
 arrhythmia monitoring 106

numerics
 explanation of NBP display 153

O

on-screen keyboard 21

operating modes 22
 configuration 22
 demonstration 22
 monitoring 22
 passcode protection 22
 service 22

operating room ECG cable 104

orange ECG cable 104

organizers 231, 232

Oridion Systems Ltd 244

oscillometric NBP measurement method 151

overlap
 in recordings 201

overlapping screen trends 195

P

pace pulse rejection (ECG)
 about 91
 switching on/off 93

paced patients
 arrhythmia monitoring 106
 repolarization tails 93
 safety information 104
 setting status 104

paced status 17
 checking 90

pacemaker failure 104

paper size
 for reports 206

parameter scales
 trends 191

passcode protection 22

patient
 admit 83
 category, NBP 151
 discharge 85
 end case 85

patient alarm messages 53

patient category field 17

patient demographics window 83

patient mismatch 87

patient name field 17

patient reports
 contents 209

patient trends
 viewing 187

paused alarms 43
 extending time 44
 restarting 44

performance specifications
 pressure 255, 262

performance test 267

perfusion indicator 143, 144, 148

Philips contact information 244

physiological alarms 39

pleth alarm source 148

pleth wave 147

pleth waveform 143

Pop 21

pop-up keys 21

power
 connecting 4
 connection 3
 disconnecting from
 mains power
 disconnecting from 32

power supply 4
 mounting 3

power-on LED 4

preparing skin
 for ECG 89

pressure
 alarms during zero 161
 arterial source 166
 calibration pressure 165
 cerebral perfusion, calculating 166
 performance specifications 255, 262
 wave scale 163
 wave size 163
 zeroing the transducer 161

pressure accessories 234

pressure artifact suppression 163

pressure of NBP cuff 154

pressure transducer
 calibration 165
 zeroing 161

primary lead (ECG)
 selecting 90

print job
 suspended 207

printer
 disabling 206
 settings 206
 status messages 208
 unavailable 207

printing
 ST map reports 126
 status log 227
 trends reports 192

priority list for trends 191

probes
 disposable temperature 157

profiles 25
 default profile 26
 patient category 26
 swapping a complete profile 26
 swapping setting block 26

prompts 18

pulse
 alarms 134
 system pulse source 133

pulse numerics for SpO2 144

PVC-related alarms 115

Q

QRS tone 135
 changing volume 30

QRS tone pitch, SpO2 148

QRS volume, changing 94

QT alarms 130

QT baseline 129

QT measurement algorithm 127

- QT monitoring
 - limitations 128
- QT/QTc monitoring 127
- quick admit 85
- R**

- radiated field immunity
 - Resp 140
- rate adaptive pacemakers
 - and ECG monitoring 105
- realtime report 210
- realtime reports
 - content 206
- recorder status messages 201
- recording
 - central 199
 - changing recording type 200
 - channels 200
 - choosing central recorder 200
 - choosing recording speed 201
 - creating templates 200
 - preventing fading ink 201
 - runtime 201
 - setting the runtime 201
 - setup menu 200
 - starting and stopping 199
 - wave overlap 201
- recording alarms 51
- recording delay time 201
- recycling 227
- rejecting pace pulses 91
- relearning arrhythmia 110
- reminder, alarm 43
- replacing batteries 220
- repolarization tails 93
- reports
 - alarm limits 210
 - battery reports 220
 - choosing paper size 206
 - contents 209
 - ECG 211
 - end case 205
 - patient trends 192
 - realtime report 210
 - re-routing 207
 - scheduled 205
 - setting up 204
 - ST map 126
 - stopping printouts 204
- re-routing reports 207
- resolution
 - trends 191
- resolving patient mismatch 87
- resp accessories 229
- Resp alarms
 - apnea alarm delay time 140
- Resp detection level
 - and apnea detection 140
- Resp detection modes
 - and cardiac overlay 139
 - changing 138
- Resp display 138
- Resp monitoring
 - and cardiac overlay 137
- Resp safety information 140
- Resp wave
 - changing size 139
 - changing speed 140
- restarting paused alarms 44
- retrolental fibroplasia (SpO2) 147
- reviewing alarms window 49
- rhythm status messages (arrhythmia monitoring) 109
- runtime
 - setting recording runtime 201
- S**

- safety
 - maintenance interval 226
 - monitor 246
- safety information
 - batteries 222
 - ECG 104
 - Resp 140
- safety test 267
- safety tests
 - performance tests 5
 - power on test 5
 - system 5
 - visual inspection 5
- same patient data merge 88
- scale
 - ECG wave 93
 - Resp wave 139
- scales
 - for trends waveforms 191
- scheduled reports 205
- screen
 - adjusting brightness 30
- screen trend
 - trend time 195
- screen trends 193
- screens
 - changing content 23
 - switching 23
 - understanding 23
 - visitor screen 24
- secondary lead (ECG)
 - selecting 90
- selecting the primary lead (ECG) 90
- selecting the secondary lead (ECG) 90
- selftest
 - alarms 51
- sensor
 - disposable SpO2 143
- sequence mode 154
- service mode 22
- set combiners 231, 232
- setting up
 - trends 189
- setting up reports 204
- setting up the sequence 154
- settings 26
 - about 26
 - default 271
 - measurement settings 26
 - monitor settings 26
 - screen settings 26
 - synchronized telemetry and monitor 183
- settings blocks 25
- Setup Recording menu 200
- short yellow alarms on/off 112
- signal quality of SpO2 145
- silence key 16
- sinus and SV rhythm ranges 257, 260
- skin preparation
 - ECG 89
- SmartKeys 19
 - key 16
- SmartKeys key 16
- SmartKeys symbol 245
- source tracking
 - ECG 183
- specifications 243
 - arrhythmia 255
- speed
 - recording 201
 - wave speed, changing 27
- SpO2
 - accessories 235
 - active alarm source 148
 - alarms specific to 146
 - arterial pulsation 143
 - assessing suspicious reading 145
 - connecting the cables 144
 - disposable sensors 143
 - extension cable 144
 - FAST technology 143
 - Nellcor adhesive sensors (disposable) 235
 - perfusion indicator 143, 144, 148
 - Philips sensors (disposable) 235
 - Philips sensors (reusable) 235

- pleth as alarm source 148
 - pleth wave 147
 - pleth waveform 143
 - pulse numerics 144
 - QRS tone 148
 - signal quality 145
 - site inspection 145
 - site selection 143
 - tone modulation 148
 - SpO2 desat alarm 147
 - SpO2 limit alarms 147
 - ST
 - adjusting alarm limits 122
 - alarms 102, 122
 - baseline, updating 119
 - ensuring diagnostic quality 117
 - filtering 117
 - measurement points, adjusting
 - adjusting 120
 - multi-lead alarms 122
 - numerics in ECG wave 92
 - snippets 119
 - ST display 118
 - ST map
 - baseline, updating 125
 - current view 122
 - report, printing
 - printing
 - ST map report 126
 - scale, changing
 - scale
 - ST map 125
 - task window 125
 - trend view 124
 - trending interval, changing 126
 - trending priority 125
 - ST maps 122
 - ST point 120
 - standard 10-lead placement 99
 - standard 3-lead placement 97
 - standard 5-lead placement (ECG) 97
 - standby mode 22
 - Standby screen 22
 - standby symbol 245
 - starting monitoring 32
 - status line 18
 - status log
 - printing 227
 - status messages
 - printer 208
 - recorder 201
 - status messages (arrhythmia) 109
 - ectopic 110
 - rhythm 109
 - sterilizing
 - infection control 213
 - stopping reports printouts 204
 - surgical ECG cable 104
 - suspended alarm 44
 - suspicious SpO2 reading 145
 - switching on
 - monitor 31
 - switching screens 23
 - symbols 244
 - battery 218
 - synchronization marks (defibrillator) 91
 - system pulse 133
 - systolic blood pressure, NBP, early 154
- ## T
-
- tabular trends 189
 - Tamb 158
 - task window for ST map 125
 - Tcereb 158
 - telemetry alarms 181
 - suspending at bedside 181
 - telemetry device
 - controlling from bedside 181
 - silencing alarms at bedside 181
 - unpairing 180
 - temperature 157
 - accessories 239
 - alarm settings 157
 - connecting probe to monitor 157
 - difference, calculating 158
 - dual Temp measurement 158
 - extended label set 158
 - first 158
 - label 158
 - making a measurement 157
 - probe, disposable 157
 - probe, selecting 157
 - second 158
 - temperature probe
 - connecting 157
 - templates
 - creating for recordings 200
 - test blocks, how to perform 5
 - testing alarms 51
 - time, setting 7, 30
 - tone configuration, alarm 41
 - tone mod (SpO2) 148
 - tone modulation 148
 - touchscreen
 - disable/re-enable 16
 - using 18
 - transducer
 - CO2, accuracy 171
 - CO2, calibrating 171
 - pressure, zeroing 161
 - transferring centrally-monitored patients 86
 - transport brightness setting 221
 - trend time 195
 - global 195
 - trend view
 - ST map 124
 - trending interval
 - ST map 126
 - trends
 - resolution 191
 - screen trends 193
 - setting parameter scales 191
 - setup 189
 - viewing 187
 - trends pop-up keys 187
 - trends priority list 191
 - ST map 125
 - troubleshooting
 - CO2 174
 - trunk cables
 - accessories 229, 231
 - Ttym 158
 - Tvesic 158
- ## U
-
- Understanding 25
 - unfiltered ECG signal 95
 - unpacking 2
 - unpairing 180
 - user interface settings
 - changing 30
- ## V
-
- V electrode placement (ECG) 98
 - venous puncture 155
 - viewing arrhythmia waves 108
 - viewing trends 187
 - visible waves report 206
 - visitor screen 24
 - vislatching (arrhythmia alarms) 112
 - vital signs report 192
 - voltage setting 4
 - volume
 - alarm 41
- ## W
-
- warnings 9
 - wave
 - adjusting 27
 - changing speed 27
 - scale (CO2) 174



scale (pressure) 163
size (CO2) 174
size (pressure) 163
wave channel speed 28
wave group speed 28
wave size
 Resp 139
wave size (ECG)
 changing 93
wave speed
 eg speed
 wave speed
 global speed 27
 respiratory speed 27
wave speed (Resp) 140
what's new 35
wide alarms limits 48
wired network connection symbol 245

Z

zero
 effect on pressure alarms 161
zeroing
 pressure transducer 161