



## TEST REPORT

Test report no.: 1-4695/12-01-03-D



### Testing laboratory

**CETECOM ICT Services GmbH**  
Untertuerkheimer Strasse 6 – 10  
66117 Saarbruecken / Germany  
Phone: + 49 681 5 98 - 0  
Fax: + 49 681 5 98 - 9075  
Internet: <http://www.cetecom.com>  
e-mail: [ict@cetecom.com](mailto:ict@cetecom.com)

#### Accredited Testing Laboratory:

The testing laboratory (area of testing) is accredited according to DIN EN ISO/IEC 17025 (2005) by the Deutsche Akkreditierungsstelle GmbH (DAkkS). The accreditation is valid for the scope of testing procedures as stated in the accreditation certificate with the registration number: D-PL-12076-01-01  
Area of Testing: Radio/Satellite Communications

### Applicant

**Philips Medizin Systeme Böblingen GmbH**  
Hewlett-Packard-Strasse 2  
71034 Böblingen / GERMANY  
Phone: -/-  
Fax: +49 7031 463-2944  
Contact: Hansjörg Geywitz  
e-mail: [hansjoerg.geywitz@philips.com](mailto:hansjoerg.geywitz@philips.com)  
Phone: +49 7031 463-1879

### Manufacturer

**Philips Medizin Systeme Böblingen GmbH**  
Hewlett-Packard-Strasse 2  
71034 Böblingen / GERMANY

### Test standard/s

47 CFR Part 95 Title 47 of the Code of Federal Regulations; Chapter I  
Subpart H—Wireless Medical Telemetry Service (WMTS); Part 95 - Personal radio services

RSS - 210 Issue 8 Spectrum Management and Telecommunications - Radio Standards Specification  
Low-power Licence-exempt Radiocommunication Devices (All Frequency Bands):  
Category I Equipment

For further applied test standards please refer to section 3 of this test report.

### Test Item

**Kind of test item:** CTG Base Station  
**Model name:** 866074  
**FCC ID:** PQC-OBRBSBV1  
**IC:** 3549C-OBRBSBV1  
**Frequency:** 608 MHz – 614 MHz  
Lowest Channel 3 (608.375 MHz) /  
Highest Channel 38 (613.625 MHz)  
**Antenna:** Integrated antenna  
**Power Supply:** 6.0 V Base station with 6V DC inlet powered by external connected fetal monitor)  
**Temperature Range:** -20°C to +55 °C

This test report is electronically signed and valid without handwriting signature. For verification of the electronic signatures, the public keys can be requested at the testing laboratory.

### Test report authorised:

Marco Bertolino  
Testing Manager

### Test performed:

Stefan Bös  
Senior Testing Manager

**1 Table of contents**

1 Table of contents .....2

2 General information .....3

    2.1 Notes and disclaimer .....3

    2.2 Application details.....3

3 Test standard/s .....3

4 Test environment.....4

5 Test item .....4

6 Test laboratories sub-contracted .....4

7 Additional information .....4

8 Summary of measurement results .....5

9 RF measurements .....6

    9.1 Description of test setup .....6

        9.1.1 Radiated measurements.....6

        9.1.2 Conducted measurements.....7

    9.2 Additional comments .....7

    9.3 RSP100 test report cover sheet / performance test data .....8

10 Measurement results .....9

    10.1 Radiated field strength .....9

    10.2 Frequency stability .....10

    10.3 Occupied bandwidth.....12

    10.4 Field strength of spurious radiation. ....15

    10.5 Receiver spurious emissions (radiated).....26

    10.6 RX Spurious Emissions Conducted < 30 MHz.....31

11 Test equipment and ancillaries used for tests .....34

12 Observations .....34

Annex A Document history .....35

Annex B Further information.....35

Annex C Accreditation Certificate .....36

## 2 General information

### 2.1 Notes and disclaimer

The test results of this test report relate exclusively to the test item specified in this test report. CETECOM ICT Services GmbH does not assume responsibility for any conclusions and generalizations drawn from the test results with regard to other specimens or samples of the type of the equipment represented by the test item.

The test report may only be reproduced or published in full. Reproduction or publication of extracts from the report requires the prior written approval of CETECOM ICT Services GmbH.

The testing service provided by CETECOM ICT Services GmbH has been rendered under the current "General Terms and Conditions for CETECOM ICT Services GmbH".

CETECOM ICT Services GmbH will not be liable for any loss or damage resulting from false, inaccurate, inappropriate or incomplete product information provided by the customer.

Under no circumstances does the CETECOM ICT Services GmbH test report include any endorsement or warranty regarding the functionality, quality or performance of any other product or service provided.

Under no circumstances does the CETECOM ICT Services GmbH test report include or imply any product or service warranties from CETECOM ICT Services GmbH, including, without limitation, any implied warranties of merchantability, fitness for purpose, or non-infringement, all of which are expressly disclaimed by CETECOM ICT Services GmbH.

All rights and remedies regarding vendor's products and services for which CETECOM ICT Services GmbH has prepared this test report shall be provided by the party offering such products or services and not by CETECOM ICT Services GmbH.

In no case this test report can be considered as a Letter of Approval.

This test report is electronically signed and valid without handwritten signature. For verification of the electronic signatures, the public keys can be requested at the testing laboratory.

### 2.2 Application details

Date of receipt of order:	2012-06-12
Date of receipt of test item:	2012-11-27
Start of test:	2012-11-27
End of test:	2013-02-13
Person(s) present during the test:	-/-

## 3 Test standard/s

Test standard	Date	Test standard description
47 CFR Part 95	2010-10	Title 47 of the Code of Federal Regulations; Chapter I Subpart H—Wireless Medical Telemetry Service (WMTS); Part 95 - Personal radio services
RSS - 210 Issue 8	2010-12	Spectrum Management and Telecommunications - Radio Standards Specification Low-power Licence-exempt Radiocommunication Devices (All Frequency Bands): Category I Equipment

#### 4 Test environment

Temperature:	$T_{nom}$	+22 °C during room temperature tests	
	$T_{max}$	+55 °C during high temperature tests	
	$T_{min}$	-20 °C during low temperature tests	
Relative humidity content:		54 %	
Barometric pressure:		not relevant for this kind of testing	
Power supply:	$V_{nom}$	6.0 V	Base station with 6V DC inlet powered by external connected fetal monitor)
	$V_{max}$	7.9 V	
	$V_{min}$	5.5 V	

#### 5 Test item

Kind of test item	:	CTG Base Station
Type identification	:	866074
S/N serial number	:	DE24600128
HW hardware status	:	1304
SW software status	:	A.02.04
Frequency band [MHz]	:	608 MHz – 614 MHz Lowest Channel 3 (608.375 MHz) / Highest Channel 38 (613.625 MHz)
Type of modulation	:	GFSK
Antenna	:	Integrated antenna
Power supply	:	6.0 V Base station with 6V DC inlet powered by external connected fetal monitor)
Temperature range	:	-20°C to +55 °C

#### 6 Test laboratories sub-contracted

None

#### 7 Additional information

Test setup - and EUT - photos are included in the following test reports:

External EUT photos: 1-4695/12-01-03\_AnnexA  
 Internal EUT photos: 1-4695/12-01-03\_AnnexB  
 Test setup: 1-4695/12-01-03\_AnnexC

## 8 Summary of measurement results

- No deviations from the technical specifications were ascertained**
- There were deviations from the technical specifications ascertained

TC Identifier	Description	Verdict	Date	Remark
RF-Testing	47 CFR Part 2 47 CFR Part 95 H RSS Gen Issue 3 RSS 210 Issue 8 Annex 4	Passed	2013-11-08	-/-

Test Specification Clause	Test Case	Temperature Conditions	Power Source Voltages	Pass	Fail	NA	NP	Remark
FCC 47 CFR § 2.1046 § 95.1115(a) RSS 210 Issue 8 A4.4	Radiated field strength	Nominal	Nominal	<input checked="" type="checkbox"/>	<input type="checkbox"/>	<input type="checkbox"/>	<input type="checkbox"/>	complies
FCC 47 CFR § 2.1055 § 95.1115(e) RSS Gen Issue 3 4.7	Frequency stability	Nominal	Extreme	<input checked="" type="checkbox"/>	<input type="checkbox"/>	<input type="checkbox"/>	<input type="checkbox"/>	complies
		Extreme	Nominal	<input checked="" type="checkbox"/>	<input type="checkbox"/>	<input type="checkbox"/>	<input type="checkbox"/>	
FCC 47 CFR § 2.1049 (1) RSS Gen Issue 3 4.6	Occupied bandwidth	Nominal	Nominal	<input type="checkbox"/>	<input type="checkbox"/>	<input type="checkbox"/>	<input type="checkbox"/>	No Pass/Fail criteria
FCC 47 CFR § 2.1053 § 95.1115(b) RSS Gen Issue 3 4.9	Field strength of spurious radiation	Nominal	Nominal	<input checked="" type="checkbox"/>	<input type="checkbox"/>	<input type="checkbox"/>	<input type="checkbox"/>	complies
	Transmitter unwanted emissions							
FCC 47 CFR § 15.209 RSS Gen Issue 3 4.10	Receiver spurious emissions (radiated)	Nominal	Nominal	<input checked="" type="checkbox"/>	<input type="checkbox"/>	<input type="checkbox"/>	<input type="checkbox"/>	complies
CFR Part 15.107 ICES-003, Issue 5	RX-Spurious Emissions Conducted < 30 MHz	Nominal	Nominal	<input checked="" type="checkbox"/>	<input type="checkbox"/>	<input type="checkbox"/>	<input type="checkbox"/>	complies

**Note:** NA = Not Applicable; NP = Not Performed

## 9 RF measurements

### 9.1 Description of test setup

#### 9.1.1 Radiated measurements

The radiated measurements are performed in vertical and horizontal plane in the frequency range from 9 kHz to 25 GHz in semi-anechoic chambers. The EUT is positioned on a non-conductive support with a height of 0.80 m above a conductive ground plane that covers the whole chamber. The receiving antennas are confirmed with specifications ANSI C63.2-1996 clause 15 and ANSI C63.4-2009 clause 4.1.5. These antennas can be moved over the height range between 1.0 m and 4.0 m in order to search for maximum field strength emitted from EUT. The measurement distances between EUT and receiving antennas are indicated in the test setups for the various frequency ranges. For each measurement, the EUT is rotated in all three axes until the maximum field strength is received. The wanted and unwanted emissions are received by spectrum analysers where the detector modes and resolution bandwidths over various frequency ranges are set according to requirement ANSI C63-4-2009 clause 4.2.

Antennas are confirmed with ANSI C63.2-1996 item 15.

Semi anechoic chamber

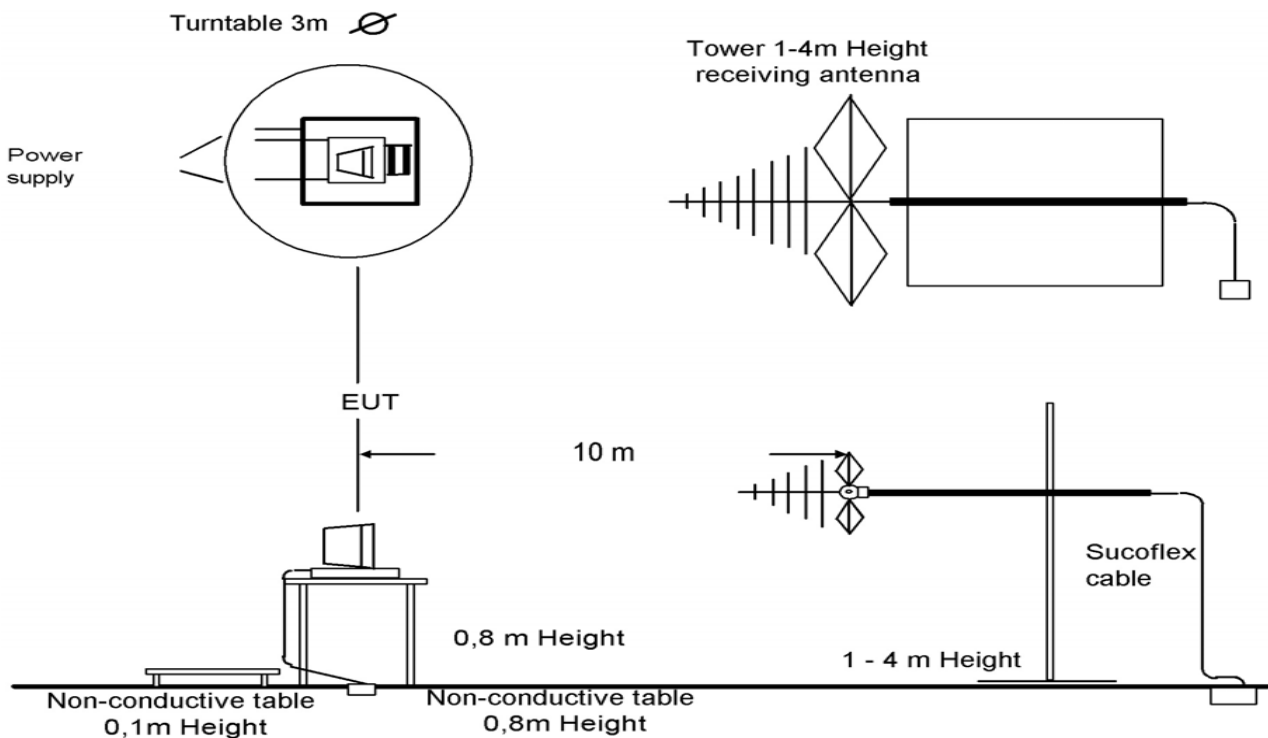

Picture 1: Diagram radiated measurements

9 kHz - 30 MHz:	active loop antenna
30 MHz – 1 GHz:	tri-log antenna
> 1 GHz:	horn antenna

The EUT is powered by an external power supply with nominal voltage. The signalling is performed from outside the chamber with a signalling unit (CMU200 or other) by air link using signalling antenna.

### 9.1.2 Conducted measurements

The EUT's RF signal is coupled out by the antenna connector which is supplied by the manufacturer. The signal is first 10dB attenuated before it is power divided (~6dB loss per branch). One of the signal paths is connected to the communication base Station (CMU200 or other), the other one is connected to the spectrum analyzer. The specific losses for both signal paths are first checked within a calibration. The measurement readings on the signalling unit/spectrum analyzer are corrected by the specific test set-up loss. The attenuator, power divider, signalling unit and the spectrum analyzer are impedance matched on 50 Ohm.

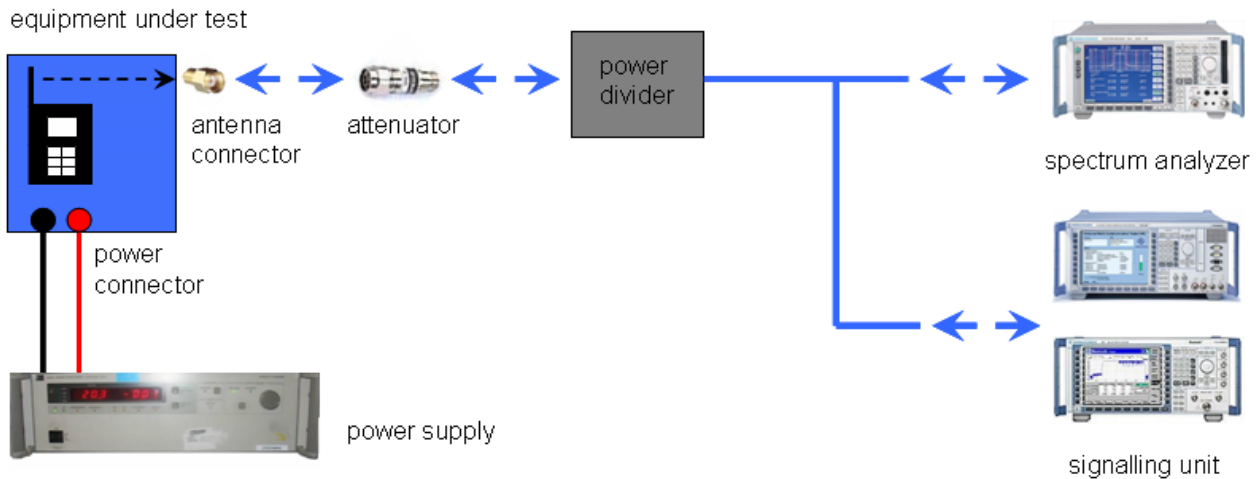

Picture 2: Diagram conducted measurements

### 9.2 Additional comments

Reference documents: None

Special test descriptions: None

Configuration descriptions: None

### 9.3 RSP100 test report cover sheet / performance test data

Test Report Number	:	1-4695/12-01-03-D
Equipment Model Number	:	866074
Certification Number	:	3549C-OBRBSBV1
Manufacturer (complete Address)	:	Philips Medizin Systeme Böblingen GmbH Hewlett-Packard-Strasse 2 71034 Böblingen / GERMANY
Tested to radio standards specification no.	:	RSS 210, Issue 8, Annex 4
Open Area Test Site IC No.	:	IC 3462C-1
Frequency Range or fixed frequency	:	608 MHz – 614 MHz Lowest Channel 3 (608.375 MHz) / Highest Channel 38 (613.625 MHz)
Field Strength [dB $\mu$ V/m] (@ 3m)	:	103.8
Occupied bandwidth (99%-BW) [kHz]	:	111.0 kHz
Type of modulation	:	GFSK
Emission Designator (TRC-43)	:	111KF1D
Antenna Information	:	Integrated antenna
Transmitter Spurious (worst case) [ $\mu$ V/m @ 3m]:	:	58.2 $\mu$ V/m @ 624.2 MHz

#### **ATTESTATION:**

#### **DECLARATION OF COMPLIANCE:**

I attest that the testing was performed or supervised by me; that the test measurements were made in accordance with the above-mentioned Industry Canada standard(s); and that the equipment identified in this application has been subjected to all the applicable test conditions specified in the Industry Canada standards and all of the requirements of the standard have been met.

#### **Laboratory Manager:**

2013-11-08	Stefan Bös	<div style="border: 1px solid black; width: 150px; height: 40px;"></div>
Date	Name	Signature



## 10 Measurement results

### 10.1 Radiated field strength

**Measurement:**

Measurement parameter	
Detector:	Quasi peak
Sweep time:	Auto
Resolution bandwidth:	120kHz
Video bandwidth:	Auto
Span:	> EBW
Trace-Mode:	Max. hold

**Limits:**

FCC	IC
CFR § 2.1046 CFR § 95.1115 (a)	RSS 210 Issue 8 A4.4
Radiated field strength	
200 mW/m @ 3 m (106 dBµV/m @ 3 m)	

**Result:**

Frequency	Radiated field strength
608.375 MHz	103.7 dBµV/m @ 3m
610.925 MHz	103.6 dBµV/m @ 3m
613.625 MHz	103.8 dBµV/m @ 3m

**Result:** Passed

## 10.2 Frequency stability

### Measurement:

Measurement parameter	
Detector:	Peak
Sweep time:	Auto
Resolution bandwidth:	100 Hz
Video bandwidth:	100 Hz
Span:	1 kHz
Trace-Mode:	Max. hold

### Limits:

FCC	IC
CFR § 2.1055 CFR § 95.1115 (e)	RSS Gen Issue 3 4.7
Manufacturers of wireless medical telemetry devices are responsible for ensuring frequency stability such that an emission is maintained within the band of operation under all of the manufacturer's specified conditions.	

### Results: lowest channel

Temperature	Deviation (kHz)	Emission within band
-20 °C	-0.26	Yes
-10 °C	-0.38	Yes
0 °C	-0.34	Yes
10 °C	-0.29	Yes
20 °C (V nom)	-0.33	Yes
30 °C	-0.74	Yes
40 °C	-1.14	Yes
55 °C	-1.55	Yes
Voltage		
90 %	-0.33	Yes
110 %	-0.33	Yes

**Results: highest channel**

Temperature	Deviation (kHz)	Emission within band
-20 °C	-0.26	Yes
-10 °C	-0.38	Yes
0 °C	-0.34	Yes
10 °C	-0.29	Yes
20 °C (V nom)	-0.35	Yes
30 °C	-0.77	Yes
40 °C	-1.17	Yes
55 °C	-1.55	Yes
Voltage		
90 %	-0.35	Yes
110 %	-0.35	Yes

**Result: Passed**

### 10.3 Occupied bandwidth

**Measurement:**

Measurement parameter	
Detector:	Peak
Sweep time:	Auto
Resolution bandwidth:	1 kHz
Video bandwidth:	300 kHz
Span:	300 kHz
Trace-Mode:	Max. hold

**Limits:**

FCC	IC
47 CFR § 2.1049 (1)	RSS Gen Issue 3 4.6
When an occupied bandwidth value is not specified in the applicable RSS, the transmitted signal bandwidth to be reported is to be its 99% emission bandwidth, as calculated or measured.	
Not limited	

**Result:**

Frequency	99% Bandwidth
608.375 MHz	109.5 kHz
610.925 MHz	111.0 kHz
613.625 MHz	110.7 kHz

**Result:** Not rated

Plots of the measurements

Plot 1: low channel

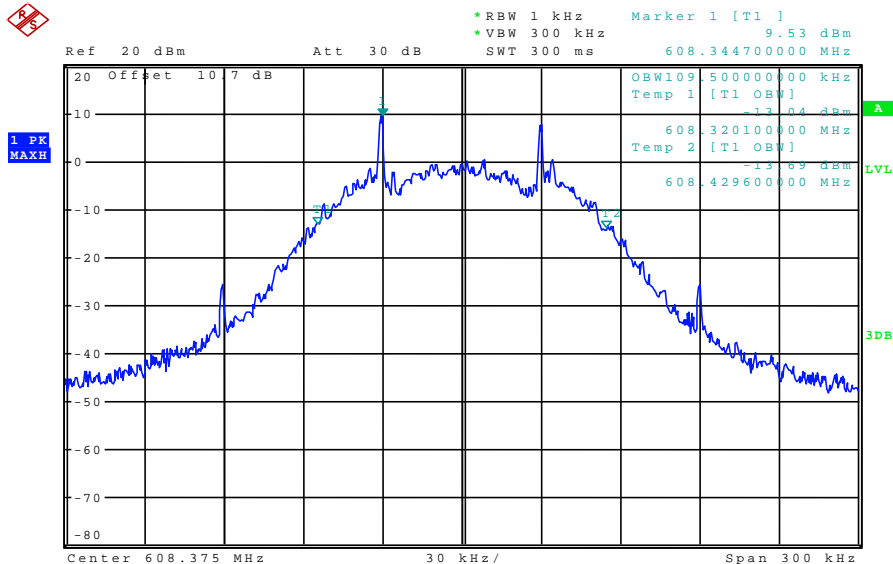

Date: 14.JAN.2013 11:09:39

Plot 2: middle channel

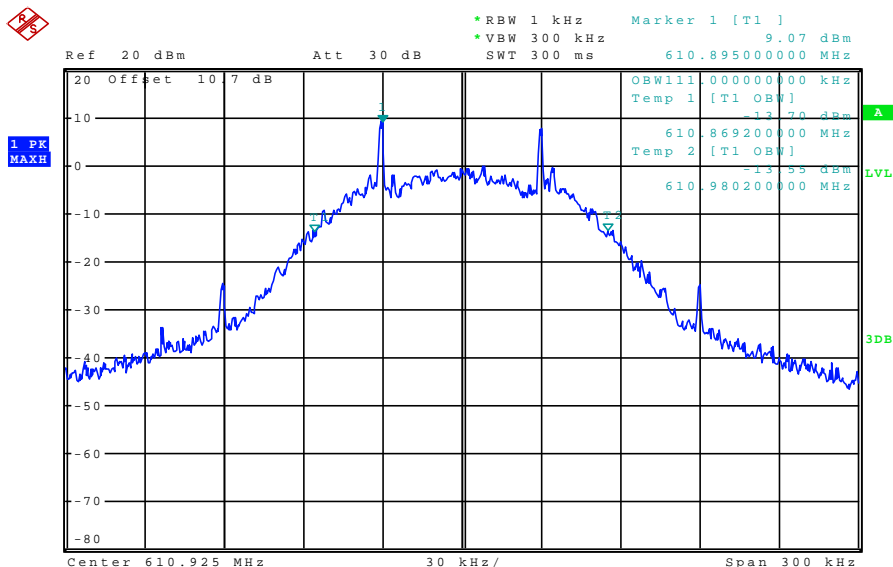

Date: 14.JAN.2013 11:10:41

Plot 3: high channel

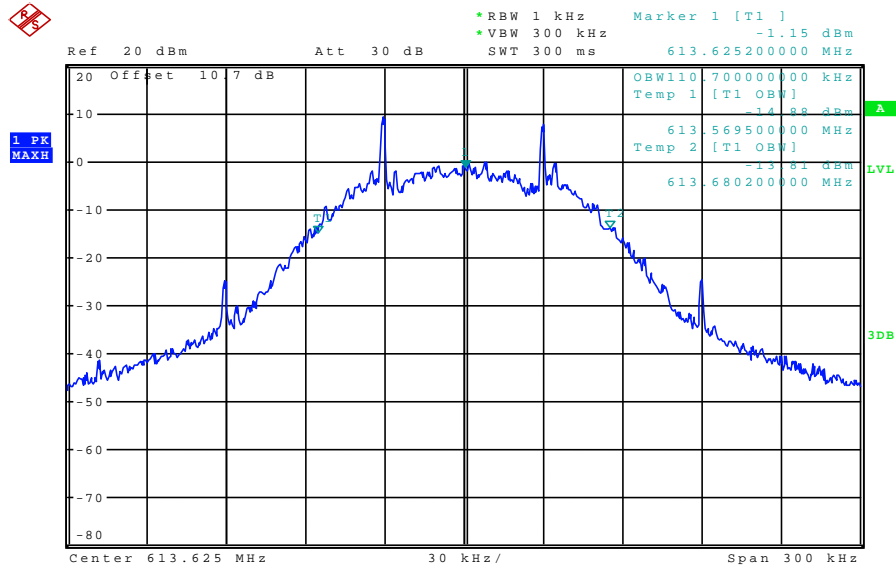

Date: 14.JAN.2013 11:02:23

### 10.4 Field strength of spurious radiation.

**Measurement:**

Measurement parameter	
Detector:	Peak / AVG
Sweep time:	Auto
Resolution bandwidth:	f < 1 GHz : 100 kHz f ≥ 1GHz : 1 MHz
Video bandwidth:	f < 1 GHz : 100 kHz f ≥ 1GHz : 1 MHz
Trace-Mode:	Max. hold

**Limits:**

FCC	IC
47 CFR § 2.1053 47 CFR § 95.1115 (b)	RSS Gen Issue 3 4.9
Out-of band emissions below 960 MHz are limited to 200 microvolts/meter, as measured at a distance of 3 meters, using measuring instrumentation with a CISPR quasi-peak detector. Out-of-band emissions above 960 MHz are limited to 500 microvolts/meter as measured at a distance of 3 meters, using measuring equipment with an averaging detector and a 1 MHz measurement bandwidth.	

**Result:**

SPURIOUS EMISSIONS LEVEL (dBµV/m)								
Lowest channel			Middle channel			Highest channel		
Frequency [MHz]	Detector	Level [dBµV/m]	Frequency [MHz]	Detector	Level [dBµV/m]	Frequency [MHz]	Detector	Level [dBµV/m]
1824.1	Pk	46.1	1832.8	Pk	46.6	1841.8	Pk	46.5
	AVG	34.2		AVG	34.7		AVG	34.6
2432.2	Pk	51.3	2443.6	Pk	50.9	2455.6	Pk	51.6
	AVG	39.4		AVG	39.0		AVG	39.7
3648.4	Pk	54.4	3665.5	Pk	55.0	3683.5	Pk	53.9
	AVG	42.5		AVG	43.1		AVG	42.0
4256.4	Pk	49.2	4276.5	Pk	47.2	4297.5	Pk	48.3
	AVG	37.3		AVG	35.3		AVG	36.4
4864.5	Pk	47.6	4887.3	Pk	46.1	4911.8	Pk	45.8
	AVG	35.7		AVG	34.2		AVG	33.9
5472.6	Pk	49.2	5498.0	Pk	47.0	5525.1	Pk	48.9
	AVG	37.3		AVG	35.1		AVG	37.0
Measurement uncertainty ± 3 dB								

**Result: Passed**

**Plots of the measurements**

Plot 1: 150 kHz – 30 MHz, low channel

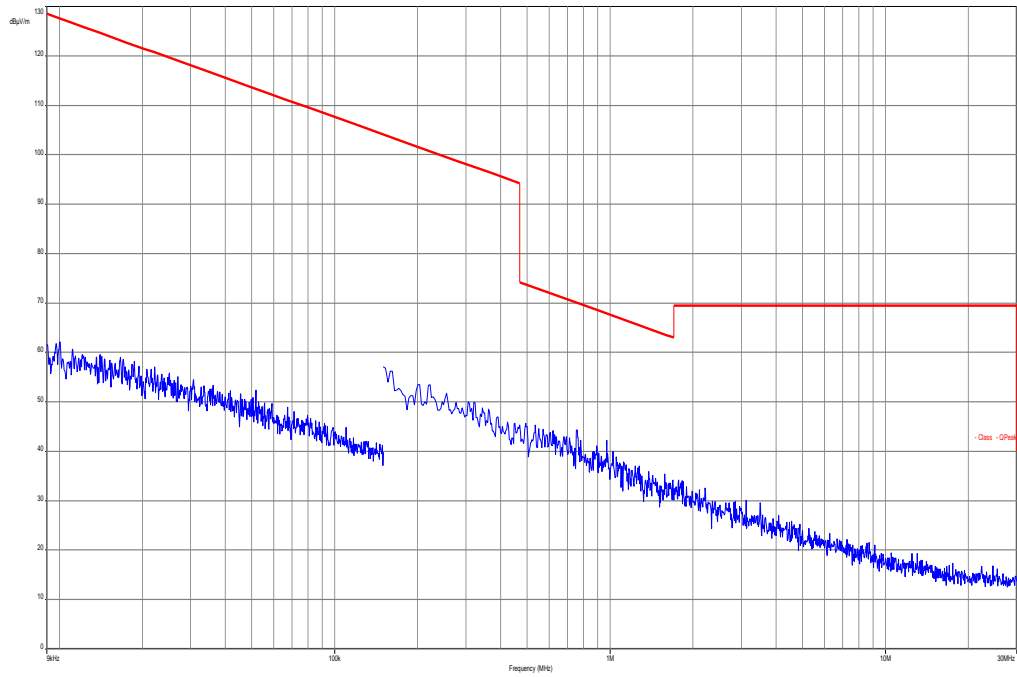



Plot 2: 30 MHz – 1 GHz, low channel

### Common Information

EUT: 866074 Avalon CL Base Station  
 Serial Number: DE24600128  
 Test Description: FCC part 95  
 Operating Conditions: TX channel 1  
 Operator Name: Kraus  
 Comment: system powered

### Scan Setup: STAN\_Fin [EMI radiated]

Hardware Setup: Electric Field (NOS)  
 Receiver: [ESCI 3]  
 Level Unit: dBµV/m

Subrange	Step Size	Detectors	IF BW	Meas. Time	Preamp
30 MHz - 2 GHz	60 kHz	QPK	120 kHz	1 s	20 dB

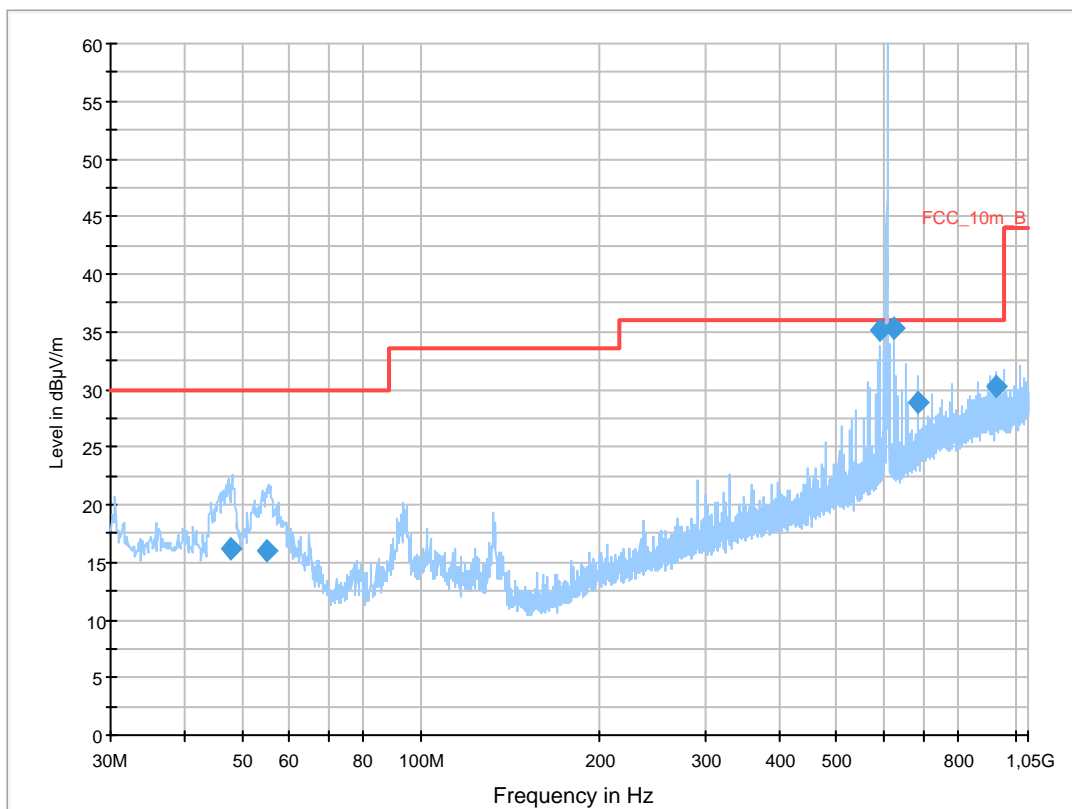

### Final Result 1

Frequency (MHz)	QuasiPeak (dBµV/m)	Meas. Time (ms)	Bandwidth (kHz)	Height (cm)	Polarization	Azimuth (deg)	Corr. (dB)	Margin (dB)	Limit (dBµV/m)	Comment
47.825700	16.1	1000.0	120.000	106.0	V	185.0	13.3	13.9	30.0	
54.979050	15.9	1000.0	120.000	281.0	V	247.0	12.9	14.1	30.0	
591.924150	35.2	1000.0	120.000	180.0	H	197.0	20.6	0.8	36.0	
624.242250	35.3	1000.0	120.000	147.0	H	201.0	21.0	0.7	36.0	
684.245700	28.9	1000.0	120.000	113.0	H	198.0	22.1	7.1	36.0	
927.344100	30.2	1000.0	120.000	100.0	V	-5.0	25.3	5.8	36.0	

## Hardware Setup: EMI radiated\Electric Field (NOS) - [EMI radiated]

Subrange 1

Frequency Range: 30 MHz - 2 GHz

Receiver: Receiver [ESCI 3]  
@ GPIB0 (ADR 20), SN 100083/003, FW 4.42

Signal Path: without Notch  
FW 1.0

Antenna: VULB 9163  
SN 9163-295, FW ---  
Correction Table (vertical): VULP6113  
Correction Table (horizontal): VULP6113  
Correction Table (vertical): Cable\_EN\_1GHz (1005)  
Correction Table (horizontal): Cable\_EN\_1GHz (1005)

Antenna Tower: Tower [EMCO 2090 Antenna Tower]  
@ GPIB0 (ADR 8), FW REV 3.12

Turntable: Turntable [EMCO Turntable]  
@ GPIB0 (ADR 9), FW REV 3.12

EMC 32 Version 8.52

Plot 3: 1 GHz – 4 GHz, low channel, antenna horizontal/vertical

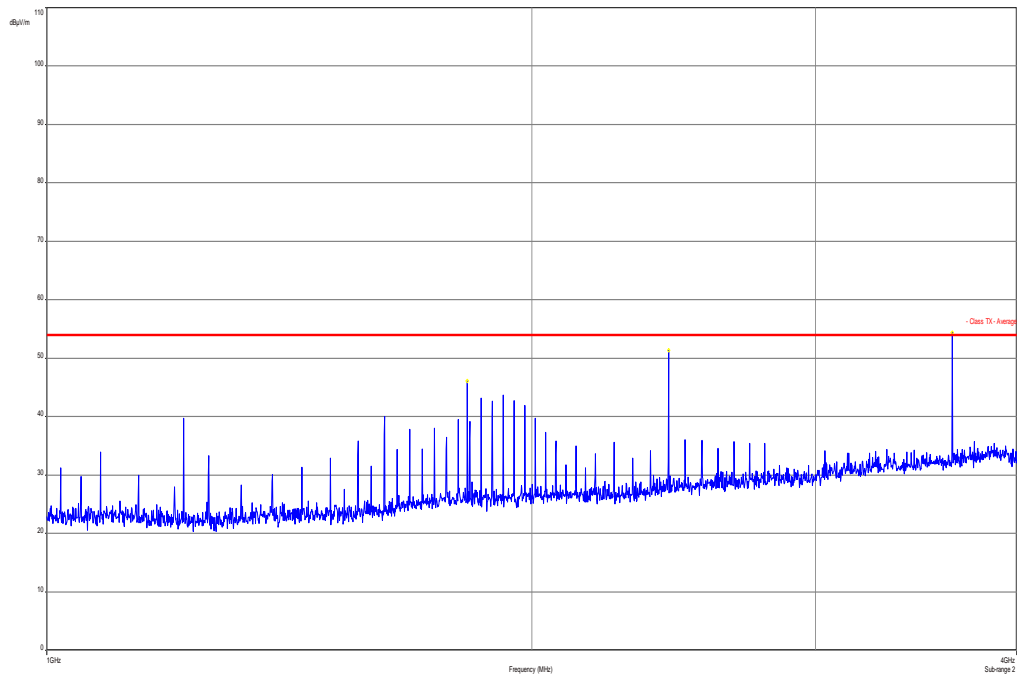

Plot 4: 4 GHz – 12.75 GHz, low channel, antenna horizontal/vertical

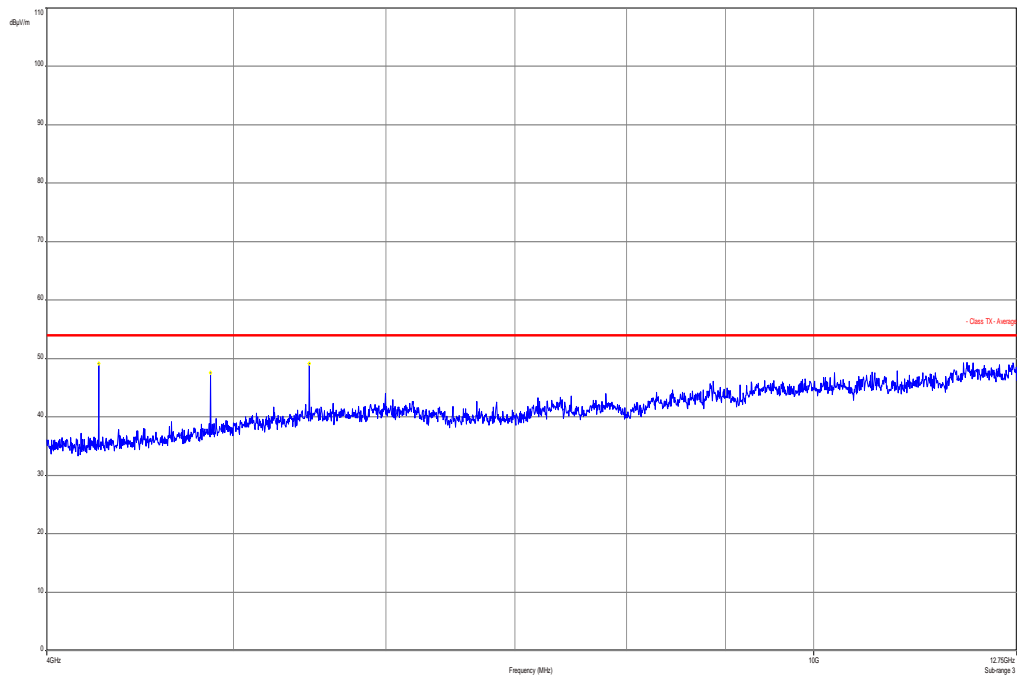

Plot 5: 150 kHz – 30 MHz, middle channel

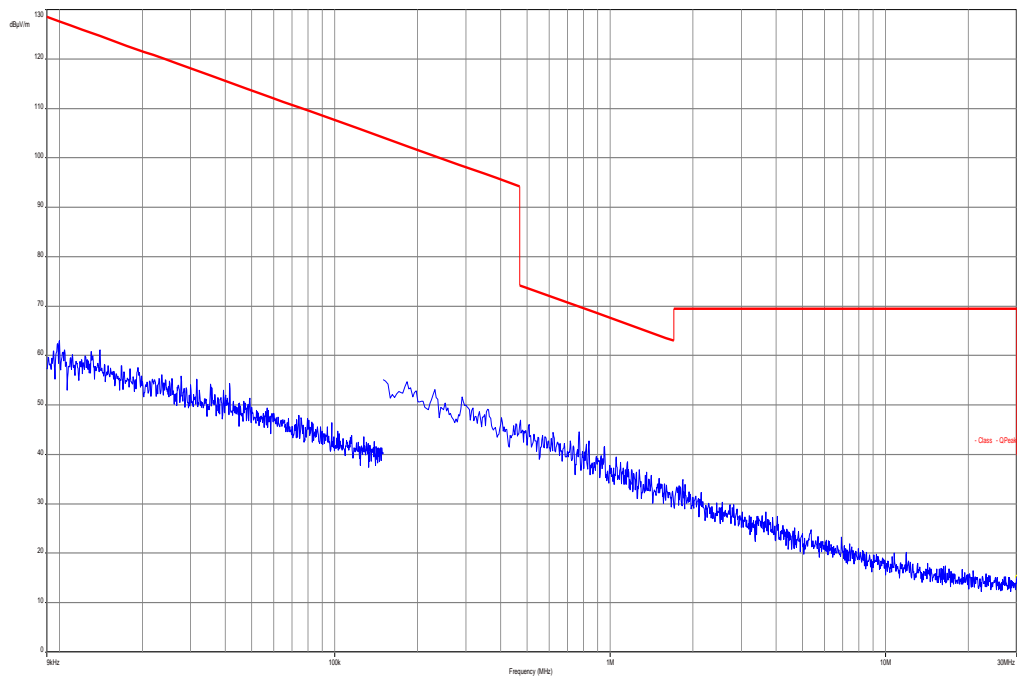

Plot 6: 30 MHz – 1 GHz, middle channel

### Common Information

EUT: 866074 Avalon CL Base Station  
 Serial Number: DE24600128  
 Test Description: FCC part 95  
 Operating Conditions: TX channel 20  
 Operator Name: Kraus  
 Comment: system powered

### Scan Setup: STAN\_Fin [EMI radiated]

Hardware Setup: Electric Field (NOS)  
 Receiver: [ESCI 3]  
 Level Unit: dBµV/m

Subrange	Step Size	Detectors	IF BW	Meas. Time	Preamp
30 MHz - 2 GHz	60 kHz	QPK	120 kHz	1 s	20 dB

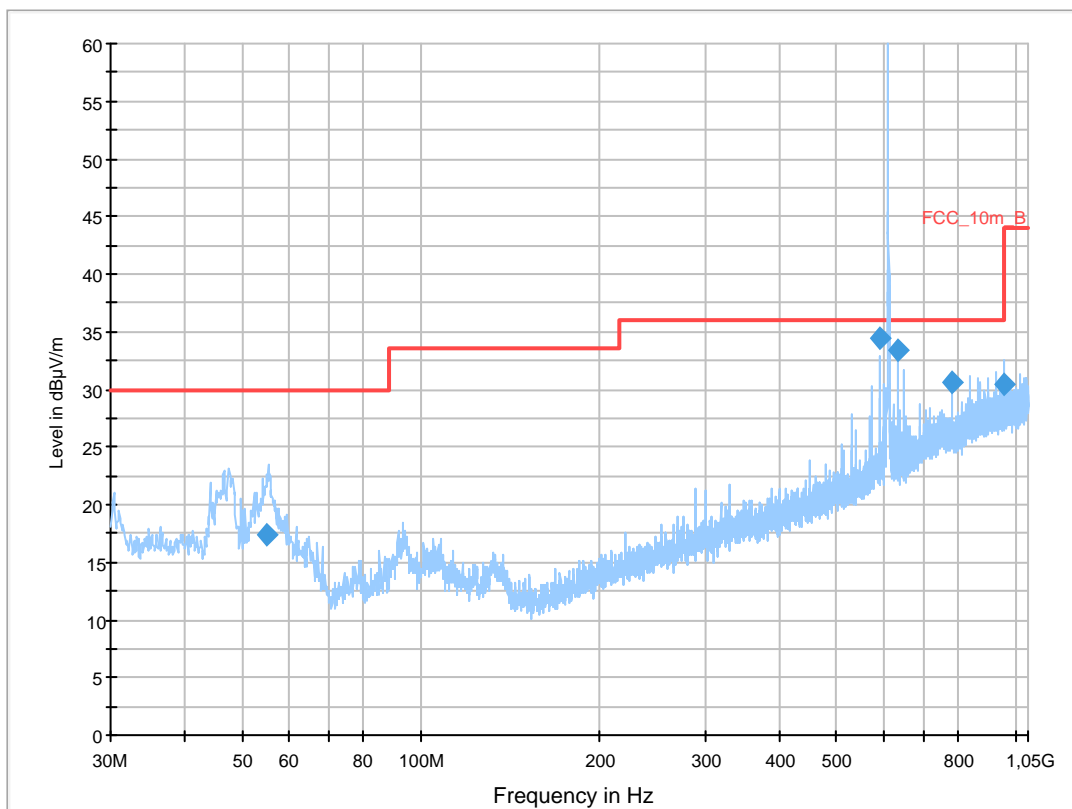

### Final Result 1

Frequency (MHz)	QuasiPeak (dBµV/m)	Meas. Time (ms)	Bandwidth (kHz)	Height (cm)	Polarization	Azimuth (deg)	Corr. (dB)	Margin (dB)	Limit (dBµV/m)	Comment
55.037250	17.4	1000.0	120.000	313.0	V	139.0	12.9	12.6	30.0	
589.071300	34.5	1000.0	120.000	180.0	H	187.0	20.5	1.5	36.0	
632.769600	33.4	1000.0	120.000	169.0	H	197.0	21.0	2.6	36.0	
779.992200	30.6	1000.0	120.000	113.0	H	26.0	23.7	5.4	36.0	
959.994300	30.4	1000.0	120.000	106.0	H	277.0	25.4	5.6	36.0	

## Hardware Setup: EMI radiated\Electric Field (NOS) - [EMI radiated]

Subrange 1

Frequency Range: 30 MHz - 2 GHz

Receiver: Receiver [ESCI 3]  
@ GPIB0 (ADR 20), SN 100083/003, FW 4.42

Signal Path: without Notch  
FW 1.0

Antenna: VULB 9163  
SN 9163-295, FW ---  
Correction Table (vertical): VULP6113  
Correction Table (horizontal): VULP6113  
Correction Table (vertical): Cable\_EN\_1GHz (1005)  
Correction Table (horizontal): Cable\_EN\_1GHz (1005)

Antenna Tower: Tower [EMCO 2090 Antenna Tower]  
@ GPIB0 (ADR 8), FW REV 3.12

Turntable: Turntable [EMCO Turntable]  
@ GPIB0 (ADR 9), FW REV 3.12

EMC 32 Version 8.52

Plot 7: 1 GHz – 4 GHz, middle channel, antenna horizontal/vertical

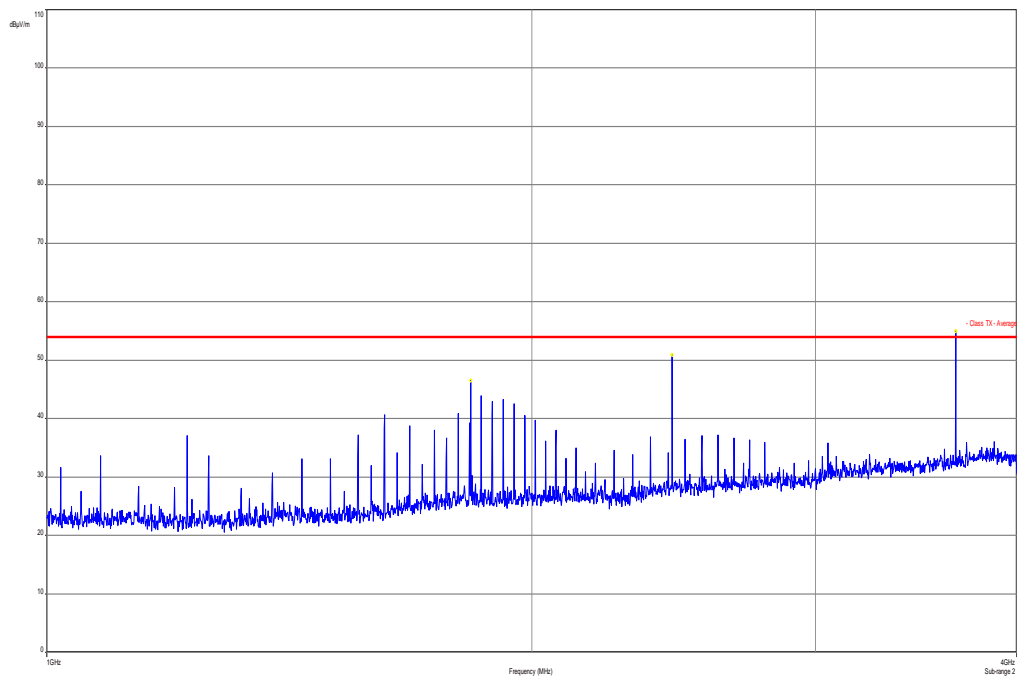

Plot 8: 4 GHz – 12.75 GHz, low channel, antenna horizontal/vertical

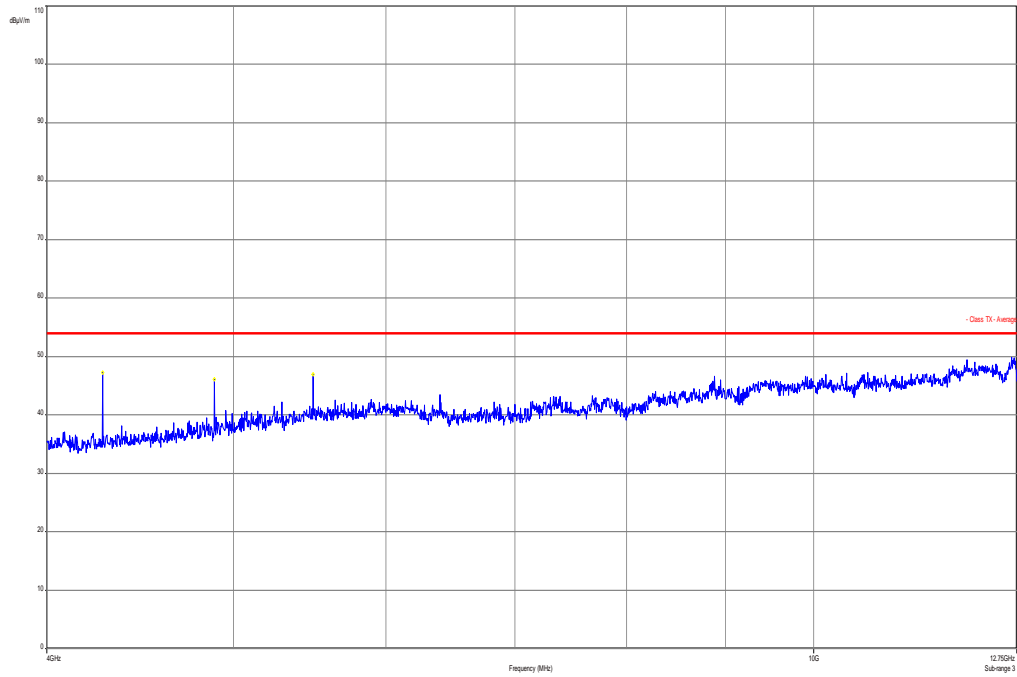

Plot 9: 150 kHz – 30 MHz, high channel

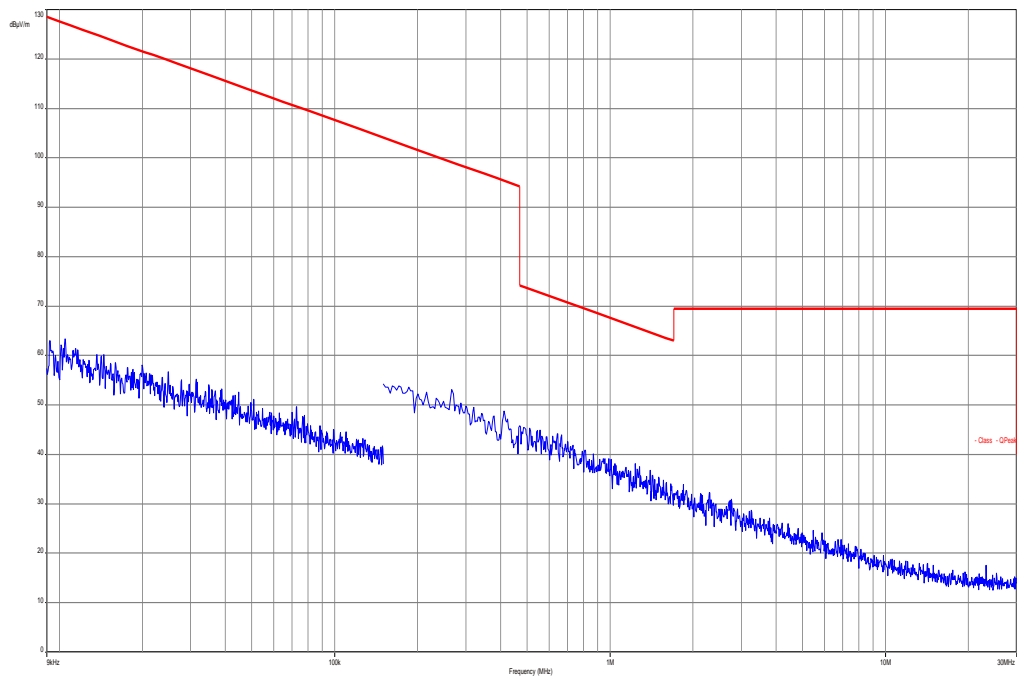

Plot 10: 30 MHz – 1 GHz, high channel

### Common Information

EUT: 866074 Avalon CL Base Station  
 Serial Number: DE24600128  
 Test Description: FCC part 95  
 Operating Conditions: TX channel 40  
 Operator Name: Kraus  
 Comment: system powered

### Scan Setup: STAN\_Fin [EMI radiated]

Hardware Setup: Electric Field (NOS)  
 Receiver: [ESCI 3]  
 Level Unit: dBµV/m

Subrange	Step Size	Detectors	IF BW	Meas. Time	Preamp
30 MHz - 2 GHz	60 kHz	QPK	120 kHz	1 s	20 dB

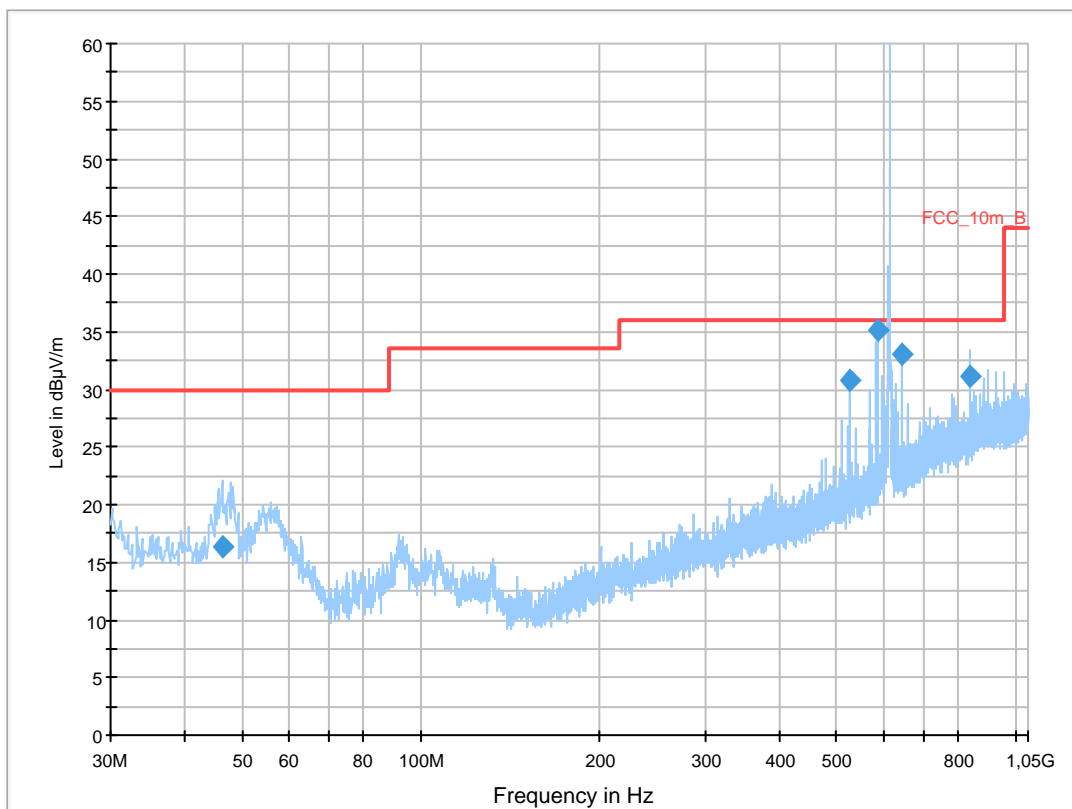

### Final Result 1

Frequency (MHz)	QuasiPeak (dBµV/m)	Meas. Time (ms)	Bandwidth (kHz)	Height (cm)	Polarization	Azimuth (deg)	Corr. (dB)	Margin (dB)	Limit (dBµV/m)	Comment
46.494300	16.3	1000.0	120.000	98.0	V	280.0	13.3	13.7	30.0	
526.080000	30.7	1000.0	120.000	170.0	H	190.0	19.0	5.3	36.0	
586.074900	35.1	1000.0	120.000	170.0	H	190.0	20.4	0.9	36.0	
641.790150	33.1	1000.0	120.000	135.0	H	190.0	21.1	2.9	36.0	
840.004350	31.1	1000.0	120.000	120.0	H	180.0	24.4	4.9	36.0	

## Hardware Setup: EMI radiated\Electric Field (NOS) - [EMI radiated]

Subrange 1

Frequency Range: 30 MHz - 2 GHz

Receiver: Receiver [ESCI 3]  
@ GPIB0 (ADR 20), SN 100083/003, FW 4.42

Signal Path: without Notch  
FW 1.0

Antenna: VULB 9163  
SN 9163-295, FW ---  
Correction Table (vertical): VULP6113  
Correction Table (horizontal): VULP6113  
Correction Table (vertical): Cable\_EN\_1GHz (1005)  
Correction Table (horizontal): Cable\_EN\_1GHz (1005)

Antenna Tower: Tower [EMCO 2090 Antenna Tower]  
@ GPIB0 (ADR 8), FW REV 3.12

Turntable: Turntable [EMCO Turntable]  
@ GPIB0 (ADR 9), FW REV 3.12

EMC 32 Version 8.52

Plot 11: 1 GHz – 4 GHz, high channel, antenna horizontal/vertical

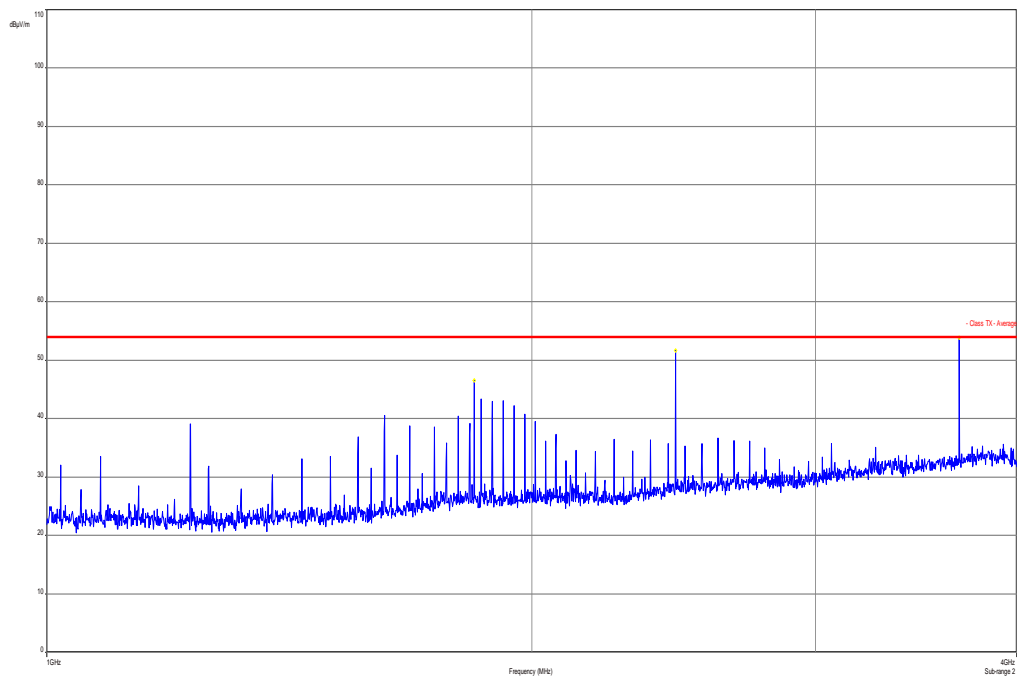



Plot 12: 4 GHz – 12.75 GHz, low channel, antenna horizontal/vertical

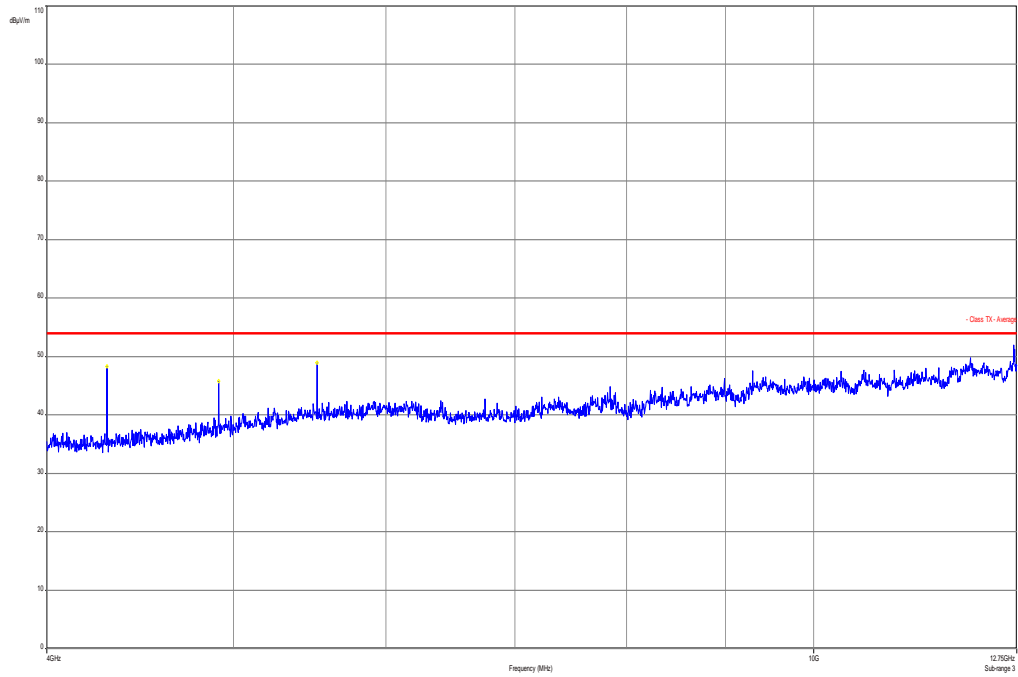

### 10.5 Receiver spurious emissions (radiated)

**Measurement:**

Measurement parameter	
Detector:	Peak / Quasi peak
Sweep time:	Auto
Video bandwidth:	F < 1 GHz: 100 kHz F > 1 GHz: 1 MHz
Resolution bandwidth:	Sweep: 100 kHz Remeasurement: 10 Hz
Span:	30 MHz to 25 GHz
Trace-Mode:	Max Hold

**Limits:**

FCC	IC	
SUBCLAUSE § 15.109	RSS-GEN Issue 3 4.10	
Receiver Spurious Emission (radiated)		
Frequency (MHz)	Field strength (µV/m)	Measurement distance (m)
30 - 88	100 (40 dBµV/m)	3
88 - 216	150 (43.5 dBµV/m)	3
216 - 960	200 (46 dBµV/m)	3
above 960	500 (54 dBµV/m)	3

**Result:**

SPURIOUS EMISSIONS LEVEL (dBµV/m)								
Idle / RX								
Frequency [MHz]	Detector	Level [dBµV/m]	Frequency [MHz]	Detector	Level [dBµV/m]	Frequency [MHz]	Detector	Level [dBµV/m]
All emissions measured with peak detector are more than 6 dB below the average limit.								
Measurement uncertainty ± 3 dB								

**Result: Passed**

**Plots of the measurements**

Plot 1: 150 kHz – 30 MHz

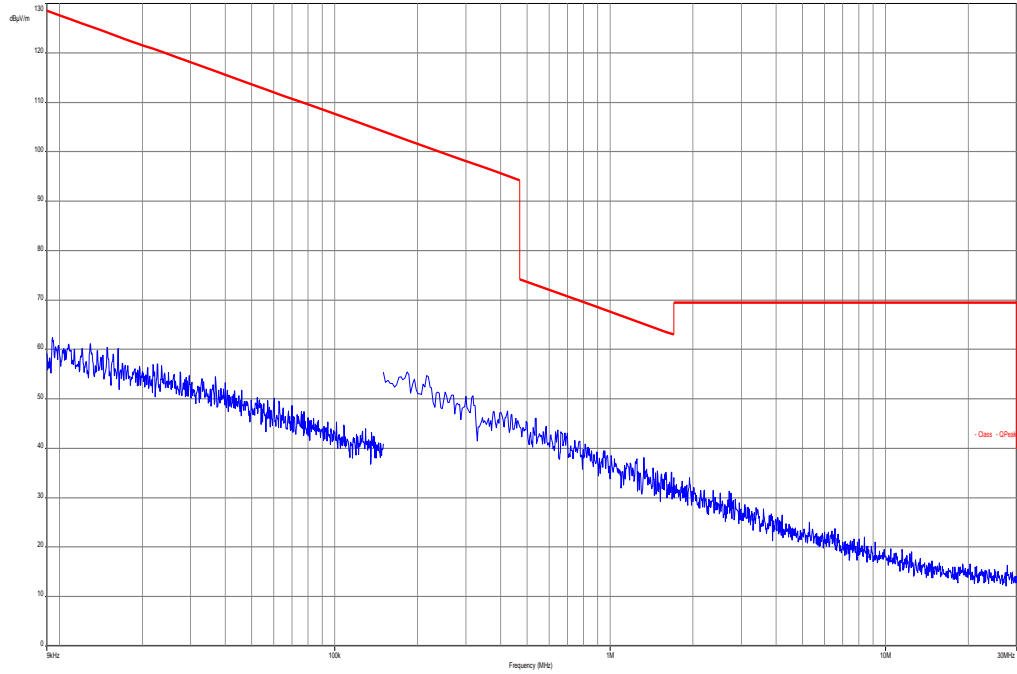

Plot 2: 30 MHz – 1 GHz

### Common Information

EUT: 866074 Avalon CL Base Station  
 Serial Number: DE24600128  
 Test Description: FCC part 15  
 Operating Conditions: RX  
 Operator Name: Kraus  
 Comment: system powered

### Scan Setup: STAN\_Fin [EMI radiated]

Hardware Setup: Electric Field (NOS)  
 Receiver:  
 Level Unit: dBµV/m

Subrange	Step Size	Detectors	IF BW	Meas. Time	Preamp
30 MHz - 2 GHz	60 kHz	QPK	120 kHz	1 s	20 dB

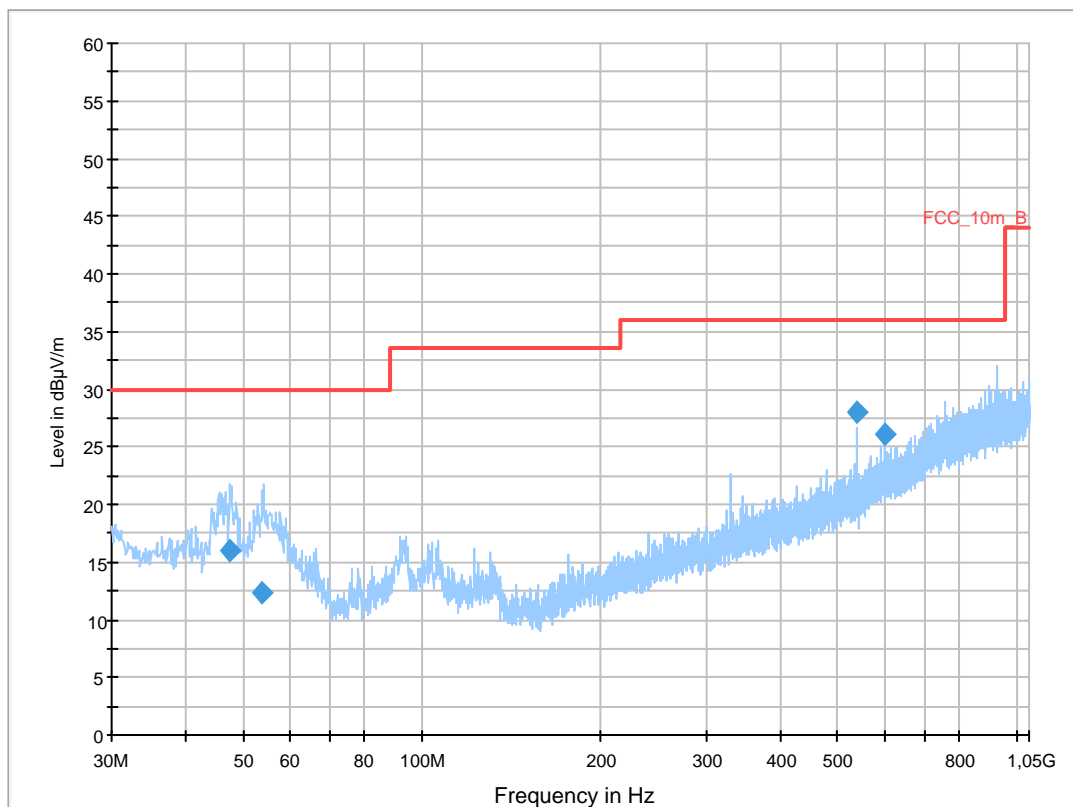

### Final Result 1

Frequency (MHz)	QuasiPeak (dBµV/m)	Meas. Time (ms)	Bandwidth (kHz)	Height (cm)	Polarization	Azimuth (deg)	Corr. (dB)	Margin (dB)	Limit (dBµV/m)	Comment
47.426400	16.0	1000.0	120.000	170.0	V	190.0	13.3	14.0	30.0	
53.560050	12.3	1000.0	120.000	98.0	V	171.0	13.0	17.7	30.0	
539.998350	28.1	1000.0	120.000	145.0	H	81.0	19.2	7.9	36.0	
600.006600	26.1	1000.0	120.000	170.0	H	80.0	20.8	9.9	36.0	

## Hardware Setup: EMI radiated\Electric Field (NOS) - [EMI radiated]

Subrange 1

Frequency Range: 30 MHz - 2 GHz

Receiver: Receiver [ESCI 3]  
@ GPIB0 (ADR 20), SN 100083/003, FW 4.42

Signal Path: without Notch  
FW 1.0

Antenna: VULB 9163  
SN 9163-295, FW ---  
Correction Table (vertical): VULP6113  
Correction Table (horizontal): VULP6113  
Correction Table (vertical): Cable\_EN\_1GHz (1005)  
Correction Table (horizontal): Cable\_EN\_1GHz (1005)

Antenna Tower: Tower [EMCO 2090 Antenna Tower]  
@ GPIB0 (ADR 8), FW REV 3.12

Turntable: Turntable [EMCO Turntable]  
@ GPIB0 (ADR 9), FW REV 3.12

EMC 32 Version 8.52

Plot 3: 1 GHz – 4 GHz, antenna horizontal/vertical

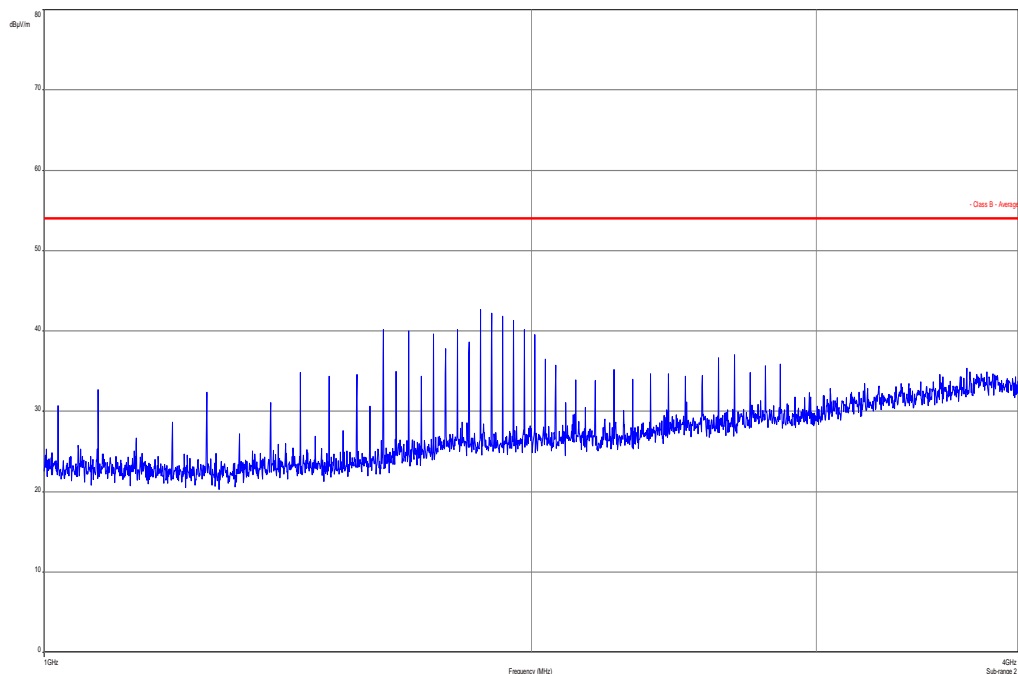

Plot 4: 4 GHz – 12.75 GHz, antenna horizontal/vertical

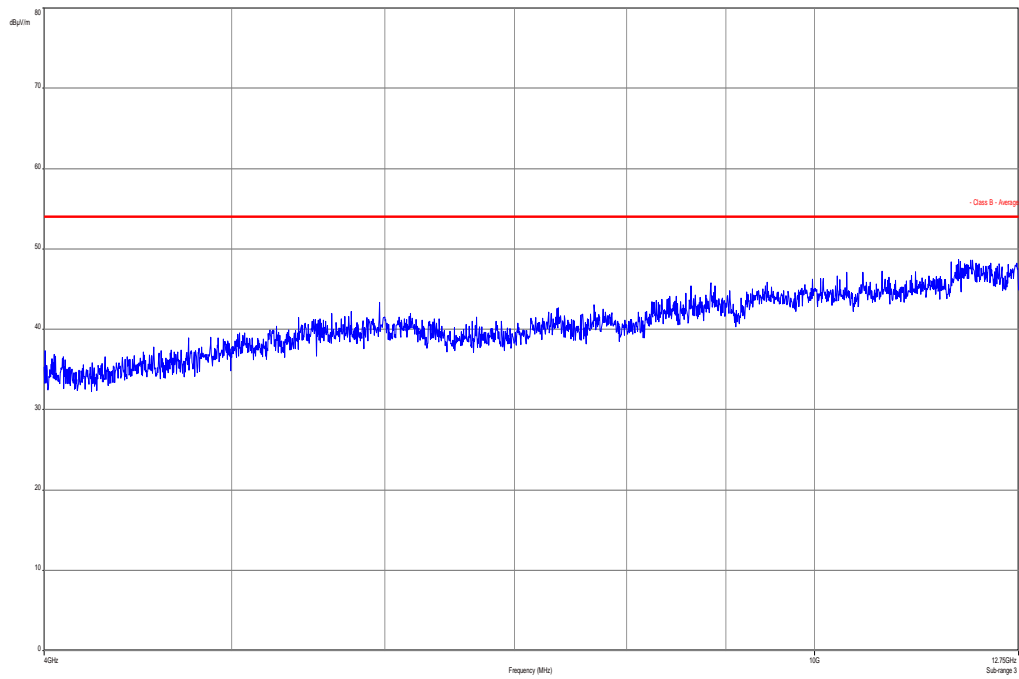

## 10.6 RX Spurious Emissions Conducted < 30 MHz

### Description:

Measurement of the conducted spurious emissions in transmit mode below 30 MHz. The EUT is set to Idle mode. Both power lines, phase and neutral line, are measured. Found peaks are remeasured with average and quasi peak detection to show compliance to the limits.

### Measurement:

Measurement parameter	
Detector:	Peak - Quasi Peak / Average
Sweep time:	Auto
Video bandwidth:	F < 150 kHz: 200 Hz F > 150 kHz: 9 kHz
Resolution bandwidth:	F < 150 kHz: 1 kHz F > 150 kHz: 100 kHz
Span:	9 kHz to 30 MHz
Trace-Mode:	Max Hold

### Limits:

FCC		IC	
CFR Part 15.107(a)		ICES-003, Issue 5	
RX Spurious Emissions Conducted < 30 MHz			
Frequency (MHz)	Quasi-Peak (dBµV/m)	Average (dBµV/m)	
0.15 – 0.5	66 to 56*	56 to 46*	
0.5 – 5	56	46	
5 – 30.0	60	50	

\*Decreases with the logarithm of the frequency

**Result: Passed**

**Plots:**

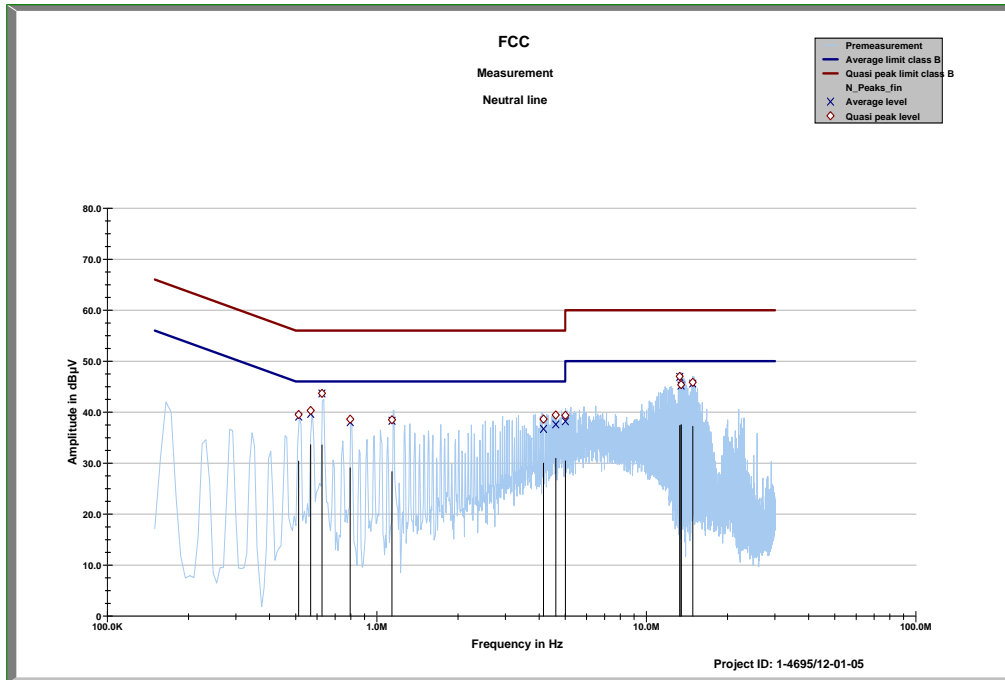

FCC  
Neutral line tbl

Project ID: 1-4695/12-01-05

11:55:55 AM, Friday, November 30, 2012

Frequency	Quasi peak level	Margin quasi peak	Average level	Margin average
MHz	dBµV	dBµV	dBµV	dBµV
0.51265	39.53	16.47	39.11	6.89
0.56822	40.32	15.68	39.65	6.35
0.62541	43.68	12.32	43.67	2.33
0.79605	38.61	17.39	38.01	7.99
1.1371	38.50	17.50	38.30	7.70
4.1517	38.63	17.37	36.71	9.29
4.6066	39.44	16.56	37.60	8.40
5.0037	39.36	20.64	38.20	11.80
13.282	46.99	13.01	46.90	3.10
13.44	45.39	14.61	45.21	4.79
14.845	45.85	14.15	45.60	4.40

Project ID - 1-4695/12-01-05  
 EUT - 866074 Avalon Cableless Base  
 Serial Number - DE2460128  
 Operating mode - TX charging, 115V/60Hz



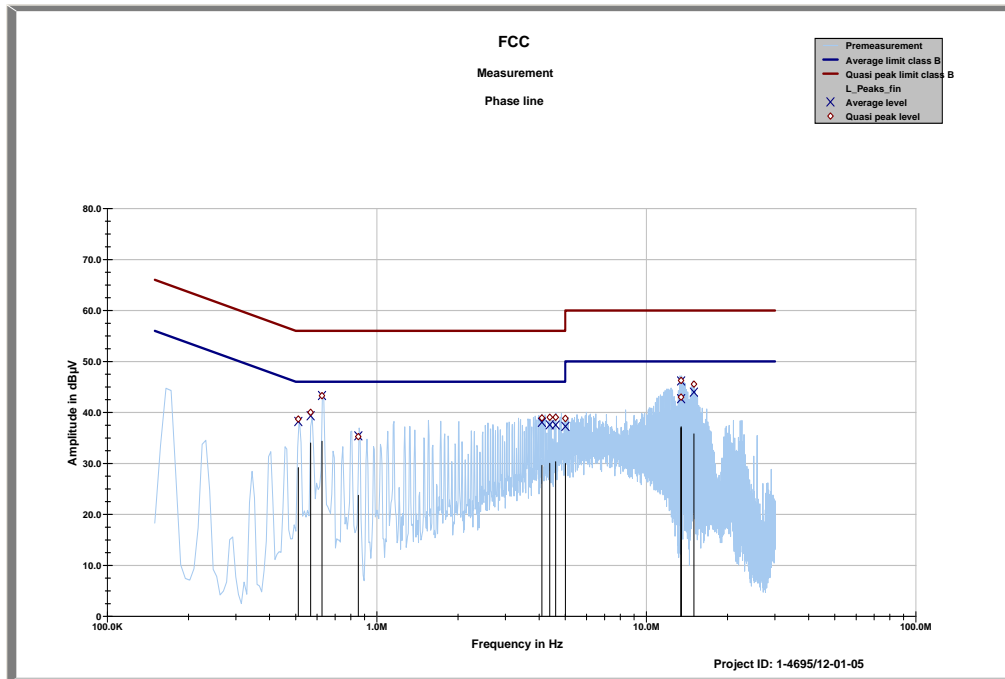

FCC  
Phase line tbl

Project ID: 1-4695/12-01-05

11:55:55 AM, Friday, November 30, 2012

Frequency	Quasi peak level	Margin quasi peak	Average level	Margin average
MHz	dBµV	dBµV	dBµV	dBµV
0.51093	38.71	17.29	38.21	7.79
0.56766	40.02	15.98	39.33	6.67
0.62541	43.28	12.72	43.31	2.69
0.85309	35.25	20.75	35.40	10.60
4.0935	38.92	17.08	38.05	7.95
4.3786	39.03	16.97	37.56	8.44
4.6043	39.04	16.96	37.54	8.46
5.0041	38.81	21.19	37.25	12.75
13.439	46.27	13.73	46.17	3.83
13.441	43.00	17.00	42.69	7.31
15.001	45.56	14.44	43.97	6.03

Project ID - 1-4695/12-01-05  
 EUT - 866074 Avalon Cableless Base  
 Serial Number - DE2460128  
 Operating mode - TX charging, 115V/60Hz

## 11 Test equipment and ancillaries used for tests

Typically, the calibrations of the test apparatus are commissioned to and performed by an accredited calibration laboratory. The calibration intervals are determined in accordance with the DIN EN ISO/IEC 17025. In addition to the external calibrations, the laboratory executes comparison measurements with other calibrated test systems or effective verifications. Weekly chamber inspections and range calibrations are performed. Where possible, rf-generating and signalling equipment as well as measuring receivers and analyzers are connected to an external high-precision 10 MHz reference (GPS-based or rubidium frequency standard).

In order to simplify the identification of the equipment used at some special tests, some items of test equipment and ancillaries can be provided with an identifier or number in the equipment list below (Labor/Item).

No.	Lab / Item	Equipment	Type	Manufact.	Serial No.	INV. No Cetecom	Kind of Calibration	Last Calibration	Next Calibration
1	n. a.	DC power supply, 60Vdc, 50A, 1200 W	6032A	HP Meßtechnik	2818A03450	300001040	Ve	12.01.2012	12.01.2015
2	n. a.	Double-Ridged Waveguide Horn Antenna 1-18.0GHz	3115	EMCO	8812-3088	300001032	vKI!	11.05.2011	11.05.2013
3	n. a.	Active Loop Antenna	6502	EMCO	2210	300001015	ne		
4	n. a.	Anechoic chamber	FAC 3/5m	MWB / TDK	87400/02	300000996	ev		
5	n. a.	Switch / Control Unit	3488A	HP Meßtechnik	*	300000199	ne		
6	n. a.	Switch / Control Unit	3488A	HP Meßtechnik	2719A15013	300001156	ne		
7	9	Isolating Transformer	MPL IEC625 Bus Regeltrennt ravo	Erfi	91350	300001155	ne		
8	n. a.	Three-Way Power Splitter, 50 Ohm	11850C	HP Meßtechnik		300000997	ne		
9	n. a.	Amplifier	js42-00502650-28-5a	Parzich GMBH	928979	300003143	ne		
10		Band Reject filter	WRCG240 0/2483-2375/2505-50/10SS	Wainwright	11	300003351	ev		
11	n. a.	Highpass Filter	WHKX7.0/1 8G-8SS	Wainwright	18	300003789	ne		
12	n. a.	TRIOLOG Broadband Test-Antenna 30 MHz - 3 GHz	VULB9163	Schwarzbeck	371	300003854	vKI!	14.10.2011	14.10.2014
13	n. a.	MXE EMI Receiver 20 Hz bis 26,5 GHz	N9038A	Agilent Technologies	MY51210197	300004405	k	19.12.2011	19.12.2014

### Agenda: Kind of Calibration

k	calibration / calibrated	EK	limited calibration
ne	not required (k, ev, izw, zw not required)	zw	cyclical maintenance (external cyclical maintenance)
ev	periodic self verification	izw	internal cyclical maintenance
Ve	long-term stability recognized	g	blocked for accredited testing
vKI!	Attention: extended calibration interval		
NK!	Attention: not calibrated	*)	next calibration ordered / currently in progress

## 12 Observations

No observations exceeding those reported with the single test cases have been made.

## Annex A Document history

Version	Applied changes	Date of release
1.0	Initial release	2013-03-20
-A	Editorial corrections	2013-04-18
-B	Editorial corrections (Voltage limits corrected)	2013-05-14
-C	Model name changed and photos extracted from test report	2013-07-09
-D	Editorial corrections	2013-11-08

## Annex B Further information

### Glossary

AVG	-	Average
DUT	-	Device under test
EMC	-	Electromagnetic Compatibility
EN	-	European Standard
EUT	-	Equipment under test
ETSI	-	European Telecommunications Standard Institute
FCC	-	Federal Communication Commission
FCC ID	-	Company Identifier at FCC
HW	-	Hardware
IC	-	Industry Canada
Inv. No.	-	Inventory number
N/A	-	Not applicable
PP	-	Positive peak
QP	-	Quasi peak
S/N	-	Serial number
SW	-	Software

**Annex C Accreditation Certificate**



Deutsche Akkreditierungsstelle GmbH  
German Accreditation Body

Entrusted according to Section 8 subsection 1 AkkStelleG in connection with Section 1 subsection 1 AkkStelleGBV  
Signatory to the Multilateral Agreements of EA, ILAC and IAF for Mutual Recognition

**Accreditation**



The Deutsche Akkreditierungsstelle GmbH (German Accreditation Body) attests that the testing laboratory

**CETECOM ICT Services GmbH**  
Untertürkheimer Straße 6-10  
66117 Saarbrücken

is competent under the terms of DIN EN ISO/IEC 17025:2005 to carry out tests in the following fields:

- Wired communications and DECT
- Acoustic
- Radio
- Shirt Range Devices (SRD)
- RFID
- WiMax and Richtfunk
- Mobile radio (GSM / DCS), Over the Air (OTA) Performance
- Electromagnetic Compatibility (EMC) incl. Automotive
- Product safety
- SAR and Hearing Aid Compatibility (HAC)
- Environmental simulation
- Smart Card Terminals
- Bluetooth
- Wi-Fi-Services

The accreditation certificate shall only apply in connection with the notice of accreditation of 13.04.2011 with the accreditation number D-PL-12076-01 and is valid until 03.09.2014. It comprises the cover sheet, the reverse side of the cover sheet and the following annex with a total of 82 pages.

Registration number of the certificate: **D-PL-12076-01-01**

Frankfurt am Main, 13.04.2011

Dipl.-Ing. (FH) Dr. Egner  
Head of Division 2

This document is a translation. The definitive version is the original German accreditation certificate.  
[www.dakks.de](http://www.dakks.de)

Deutsche Akkreditierungsstelle GmbH

Office Berlin  
Spittelmarkt 10  
10117 Berlin

Office Frankfurt am Main  
Gartenstraße 6  
60594 Frankfurt am Main

Office Braunschweig  
Bundesallee 100  
38116 Braunschweig

The publication of extracts of the accreditation certificate is subject to the prior written approval by Deutsche Akkreditierungsstelle GmbH (DAKKS). Exempted is the unchanged form of separate disseminations of the cover sheet by the conformity assessment body mentioned overleaf.

No impression shall be made that the accreditation also extends to fields beyond the scope of accreditation attested by DAKKS.

The accreditation was granted pursuant to the Act on the Accreditation Body (AkkStelleG) of 31 July 2009 (Federal Law Gazette I p. 2625) and the Regulation (EC) No 765/2008 of the European Parliament and of the Council of 9 July 2008 setting out the requirements for accreditation and market surveillance relating to the marketing of products (Official Journal of the European Union L 218 of 9 July 2008; p. 30). DAKKS is a signatory to the Multilateral Agreements for Mutual Recognition of the European co-operation for Accreditation (EA), International Accreditation Forum (IAF) and International Laboratory Accreditation Cooperation (ILAC). The signatories to these agreements recognise each other's accreditations.

The up-to-date state of membership can be retrieved from the following websites:  
EA: [www.european-accreditation.org](http://www.european-accreditation.org)  
ILAC: [www.ilac.org](http://www.ilac.org)  
IAF: [www.iaf.eu](http://www.iaf.eu)

Front side of certificate

Back side of certificate

**Note:**

The current certificate including annex is published on our website (see link below) or may be received from CETECOM ICT Services on request.

[http://www.cetecom.com/fileadmin/de/CETECOM\\_D\\_Saarbruecken/accreditations\\_Jan\\_2010/DAKKS\\_Akkredi\\_Urk\\_EN17025-En\\_incl\\_Annex.pdf](http://www.cetecom.com/fileadmin/de/CETECOM_D_Saarbruecken/accreditations_Jan_2010/DAKKS_Akkredi_Urk_EN17025-En_incl_Annex.pdf)