**COMPLIANCE WORLDWIDE INC.
TEST REPORT 264-11R4**

In Accordance with the Requirements of
**FCC PART 15.247, SUBPART C
INDUSTRY CANADA RSS 210, ISSUE 8**

**Low Power License-Exempt Radio Communication Devices
Intentional Radiators**

Issued to

**Philips Medical Systems
3000 Minuteman Drive
Andover, MA 01810
978-659-2800**

for the

**Philips Telemetry System
MX40 Patient Worn Monitor
2.4 GHz Short Range Radio (SRR)**

**FCC ID: PQC-MX40SH2B4
IC: 3549B-MX40SH2B4**

**Report Issued on April 23, 2012
Revision R4 Issued on May 9, 2012**

Tested by



Brian F. Breault

Reviewed by



Larry K. Stillings

This test report shall not be reproduced, except in full, without written permission from Compliance Worldwide, Inc.

Table of Contents

1. Scope	3
2 .Product Details.....	3
2.1 Manufacturer	3
2.3 Serial Number.....	3
2.4 Description.....	3
2.5 Power Source	3
2.6 EMC Modifications.....	3
3. Product Configuration	3
3.1 Operational Characteristics & Software	3
3.2 EUT Hardware.....	4
3.3 . EUT Hardware/Software/Firmware Revision Level.....	4
3.4 EUT Cables/Transducers	4
3.5 Support Equipment.....	4
3.6 Support Equipment Cables/Transducers	4
3.7 Miscellaneous.....	4
3.7 Block Diagram	5
4. Measurements Parameters	6
4.1 Measurement Equipment Used to Perform Test.....	6
4.2 Measurement & Equipment Setup	6
4.3 Measurement Procedure	6
5. Choice of Equipment for Test Suits.....	7
5.1 Choice of Model.....	7
5.2 Presentation	7
5.3 Choice of Operating Frequencies.....	7
6. Measurement Summary.....	8
7. Measurement Data.....	8
7.1 Antenna Requirement	8
7.2 Minimum 6 dB Bandwidth.....	8
7.3 99% Bandwidth.....	11
7.4 Maximum Peak Conducted Output Power	13
7.5 Operation with directional antenna gains greater than 6 dBi	16
7.6 Transmitter Spurious Radiated Emissions	16
7.7 Band Edge Measurements.....	21
7.8 Power Spectral Density	24
7.9 Public Exposure to Radio Frequency Energy Levels	26
8. Test Setup Photographs	27
9. Test Site Description.....	30

1. Scope

This test report certifies that the Philips Medical Telemetry System MX40 2.4 GHz Patient Worn Monitor (PWM) Short Range Radio (SRR), as tested, meets the FCC Part 15, Subpart C and Industry Canada RSS 210, Issue 8 requirements. The scope of this test report is limited to the test sample provided by the client, only in as much as that sample represents other production units. If any significant changes are made to the unit, the changes shall be evaluated and a retest may be required. Revision R3 documents the loop antenna used below 30 MHz on Page 6 and removes the receiver spurious data from this report. Revision R4 updates the referenced procedure in section 4.3.

2. Product Details

2.1. Manufacturer: Philips Medical Systems

2.2. Model Number: IntelliVue MX40

2.3. Serial Number: US11600752

2.4. Description: The Patient Worn Monitor is a body worn patient monitor for ECG and SpO2 measurements. The device has a touch screen display which can display patient waveforms and/or numeric values locally or transmitted via several possible radio links to the hospital wireless network, a wireless bedside monitor, or to a CTS network for display on the IntelliVue Information Center. The device is capable of transmitting in the 2.4GHz (ISM bands), 5.6GHz (ISM bands) and/or the WMTS bands, 1395 MHz to 1400 MHz and 1427 MHz to 1432 MHz. The PWM contains an 802.11 a/b/g WLAN radio to communicate with a WLAN, an 802.15.4 SRR radio to communicate with a SRR equipped bedside monitor, or an optional 1.4 GHz or 2.4 GHz CTS radio to communicate with a Philips CTS network. Performance evaluation during immunity testing shall be done on the PWM display, the WLAN display, the IntelliVue Information Center display and the MP5 bedside monitor. The PWM will be configured with a 2.4 GHz SRR radio for this test plan.

2.5. Power Source: DC 3 volts – Three 1.5 VDC Alkaline AA Batteries (Regulated)

2.6. EMC Modifications: None

3. Product Configuration

3.1. Operational Characteristics & Software

The Short Range Radio in the Patient Worn Monitor is a bi-directional radio link between the PWM and a IntelliVue Bedside Patient Monitor MPXX series. An MP5 monitor will be used during this test plan. Be sure there is no Telemetry device assigned to the MP5 by pressing on the front panel “Main Setup” which will bring up the “Main Setup” window. Then press “Telemetry Device” which will bring up the “Telemetry Device” window, which should be blank. If there is an equipment ID in the Telemetry Device window, press the “Unassign Telemetry Device”.

Turn on the MP5 monitor. Insert the battery/batteries into the MX40.

On the MP40 front panel, press the middle “Smart Key” which brings up the “SmartKeys” menu selections. Press the “Add/Remove” button. You should then see a small window appear at the bottom of the MP5 display, right of center, above the selection buttons with a white ECG symbol and Blue SpO2 symbol. Press that small, window button on the MP5 and the “Add Cableless”

3. Product Configuration (continued)

window should appear with the same small window inside containing the Equipment ID of the MX40, i.e. TANGO1. Press the “Equipment ID” button. You should see a message in the lower left “adding TANGO1” followed by another “Tele Device assigned: TANGO1”. Press the “X” in the “Add Cableless” window to close it. The patient waveforms and numeric values from the MX40 should appear on the MP5 shortly.

To unassign an MX40 from an MP5, on the front panel of the MP5, press “Main Setup” which will bring up the “Main Setup” window then press “Telemetry Device” which will bring up the “Telemetry Device” window containing the Equipmwn ID of the assigned MX40. On the bottom of the MP5 display, press the “Unassign Tele” button and this should cancel the connection between the MX40 and the MP5.

3.2. EUT Hardware

Blk Diag #	Manufactr	Model/Part # / Options	Serial Number	Input Voltage	Frq (Hz)	Description/Function
1	Philips	865351/MX40	US11600752	3 V	DC	Patient Worn Monitor w/2.4 GHz SRR radio, PP3 build units

3.3. EUT Hardware/Software/Firmware Revision Level

EUT Model#	PCA#	Description	HW	SW	FW
MX40		2.4 GHz SRR radio	Rev. 02	A.00.28	

3.4. EUT Cables/Transducers

Blk Diag Ltr	Manufacturer	Model/Part #	Length (m)	Shield Y/N	Description/Function
A	Philips	989803171871	0.8	Y	SpO2 connector/ECG leadset- 6 leads
B	Philips	M1191A	2	N	SpO2 patient transducer

3.5. Support Equipment

Diag Blk #	Manufacturer	Model/Part # Options	Serial Number	Input Voltage	Input Frq.	Description/Function
10	Philips	MP5	DE74808392	100-240	50-60	Bedside Monitor

3.6. Support Equipment Cables/Transducers

Blk Diag Ltr	Manufacturer	Model/Part #	Length (m)	Shield Y/N	Description/Function
---	---	---	---	---	There were no support equipment cables/transducers

3.7. Miscellaneous

Manufacturer	Model/Part #	Description/Function
Duracell	NA	AA batteries
Philips	453564128871	Li-ion rechargeable batteries

3 Product Configuration (continued)

3.8. Block Diagram

Fig.1 Tango EMC Testing

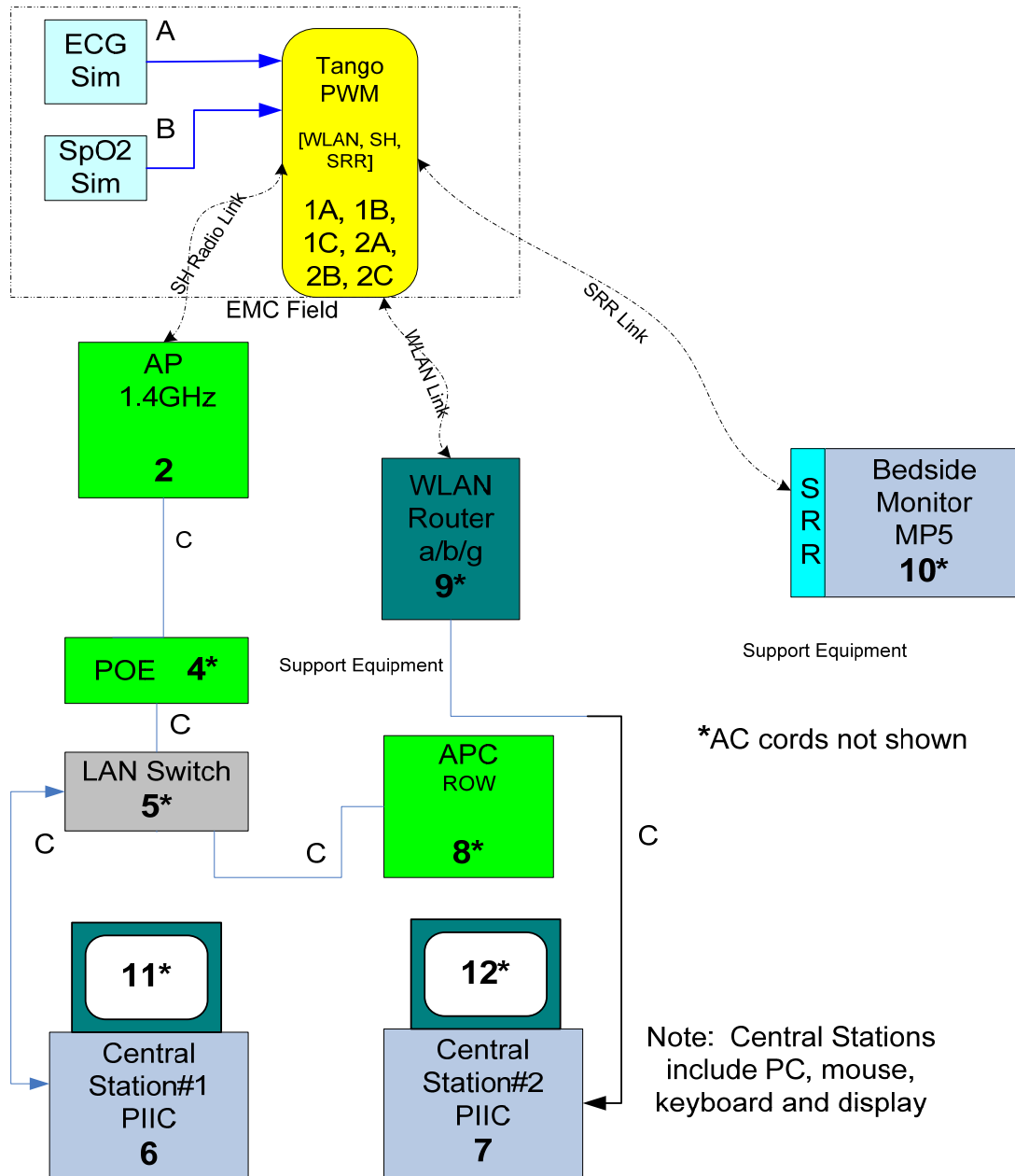

Note: Blk Diag # 10 was configured as support equipment for this test.

4. Measurements Parameters

4.1. Measurement Equipment Used to Perform Tests

Device	Manufacturer	Model No.	Serial No.	Cal Due
Spectrum Analyzer	Agilent	E4407B	MY45104493	12/22/2012
Microwave Preamp	Hewlett Packard	8449B	3008A01323	12/1/2012
Spectrum Analyzer	Agilent	E7405A	MY45115430	10/22/2011
Bilog Antenna	Com-Power	AC-220	25509	8/30/2011
Horn Antenna	Electro-Metrics	EM-6961	6337	10/19/2012
Horn Antenna	ComPower	AH-118	10078	7/23/2011
Horn Antenna	ComPower	AH-840	03075	7/20/2012
Loop Antenna	EMCO	6502	2197	7/21/2012
DMM / Temperature	Fluke	187	79690058	11/29/2011
RF Signal Generator	Hewlett Packard	8648C	3642U01557	7/16/2011
2.4 GHz BP Filter	Micro-Tronics	BRM50702	14	8/11/2011
Digital Barometer	Control Company	4195	ID236	11/9/2011
Thermal Chamber	Associated Testing Labs	SLHU-1-CRLC	N/A	Not Required

4.2. Measurement & Equipment Setup

Test Dates: June 6, 2011 to June 17, 2011
 Test Engineer: Brian Breault
 Normal Site Temperature (15 - 35°C): 21.7
 Relative Humidity (20 -75%RH): 33%
 Frequency Range: 30 MHz to 24.800 GHz
 Measurement Distance: 3 Meters
 EMI Receiver IF Bandwidth: 120 kHz - 30 MHz to 1 GHz
 1 MHz - Above 1 GHz
 EMI Receiver Avg Bandwidth: 300 kHz - 30 MHz to 1 GHz
 3 MHz - Above 1 GHz
 Detector Function: Peak, QP - 30 MHz to 1 GHz
 Peak, Avg - Above 1 GHz
 Unless otherwise specified.

4.3. Measurement Procedure

Test measurements were made in accordance FCC Part 15.247, IC RSS-210 Annex II: Operation within the bands 902 - 928 MHz, 2400 - 2483.5 MHz, 5725 - 5875 MHz, and 24.0 - 24.25 GHz.

The test procedures detailed in the Federal Communications Commission Office of Engineering and Technology Guidance for Performing Measurements on Digital Transmission Systems (DTS) Operating Under 15.247 (FCC OET Publication Number 558074), dated 1/18/2012, were used to generate the data in this test report.

The test methods used to generate the data in this test report are in accordance with ANSI C63.4: 2003, American National Standard for Methods of Measurement of Radio-Noise Emissions from Low-Voltage Electrical and Electronic Equipment in the Range of 9 kHz to 40 GHz

4. Measurements Parameters

4.3. Measurement Procedure (continued)

In accordance with ANSI C63.4-2003, section 13.1.4.1 c), the device under test was rotated through three orthogonal axes to determine which attitude produced the highest emission relative to the limit. The attitude that produced the highest emission relative to the limit was used for all radiated emission measurements and is detailed in this test report.

5. Choice of Equipment for Test Suits

5.1 Choice of Model

This test report is based on the test samples supplied by the manufacturer and are reported by the manufacturer to be equivalent to the production units.

5.2 Presentation

This test sample was tested complete with all required ancillary equipment. Refer to Section 3 of this report for product equipment configuration.

5.3 Choice of Operating Frequencies

The MX40 2.4 GHz Patient Worn Monitor SRR operates on a total of 16 channels, from channel 11 to channel 26.

In accordance with ANSI C63.4-2009, section 13.2.1, the choice of operating frequencies selected for the testing outlined in this report was based on the lowest, middle and highest operating frequencies. The frequencies selected were 2405 MHz (Channel 11), 2440 MHz (Channel 18) and 2480 MHz (Channel 26).

6. Measurement Summary

Test Requirement	FCC Rule Requirement	IC Rule Requirement	Report Section	Result
Antenna Requirement	15.203	RSS-GEN 7.1.2	7.1	Compliant
Minimum 6 dB bandwidth	15.247 (a) (2)	RSS-210 A8.2	7.2	Compliant
99% (occupied) bandwidth	N/A	RSS-GEN 4.6.1	7.3	Compliant
Maximum peak conducted output power	15.247 (b) (3)	RSS-210 A8.4 (4)	7.4	Compliant
Operation with directional antenna gains greater than 6 dBi	15.247 (b) (4)	RSS-GEN 7.1.2	7.5	Compliant
Spurious radiated emissions	15.209	RSS-GEN 4.9	7.6	Compliant
Spurious harmonic radiated emissions	ANSI C63.4 10.2.8.2	RSS-210 A8.9	7.6	Compliant
Receiver Spurious Radiated Emissions		RSS-GEN 4.10	7.7	Compliant
Band edge	15.247 (d)	RSS-210 A8.5	7.8	Compliant
Power Spectral Density	15.247 (e)		7.9	Compliant
Power line conducted emissions	15.207	RSS-GEN	N/A	N/A
Public exposure to radio frequency energy levels	15.247 (1) 1.1307 (b)(1)	RSS-GEN 5.5 RSS-102	7.10	Compliant

7. Measurement Data

7.1. Antenna Requirement (15.203)

Requirement: An intentional radiator shall be designed to ensure that no antenna other than that furnished by the responsible party shall be used with the device. The use of a permanently attached antenna or of an antenna that uses a unique coupling to the intentional radiator shall be considered sufficient to comply with the provisions of this Section.

Status: All antennas utilized by the MX40 are internal to the device and not user accessible.

7. Measurement Data (continued)

7.2. Minimum 6 dB Bandwidth (15.247 (a) (2), RSS 210 A8.2(a))

Requirement: Systems using digital modulation techniques may operate in the 902 - 928 MHz, 2400 - 2483.5 MHz, and 5725 - 5850 MHz bands. The minimum 6 dB bandwidth shall be at least 500 kHz.

Resolution Bandwidth : 100 kHz
 Video Bandwidth : 300 kHz

Measurement Results

Channel	Frequency (MHz)	6 dB Bandwidth (kHz)	Minimum 6 dB Bandwidth (kHz)	Result
Low	2405	1625	>500	Compliant
Middle	2440	1580	>500	Compliant
High	2480	1605	>500	Compliant

7.2.1. Low Channel – 11

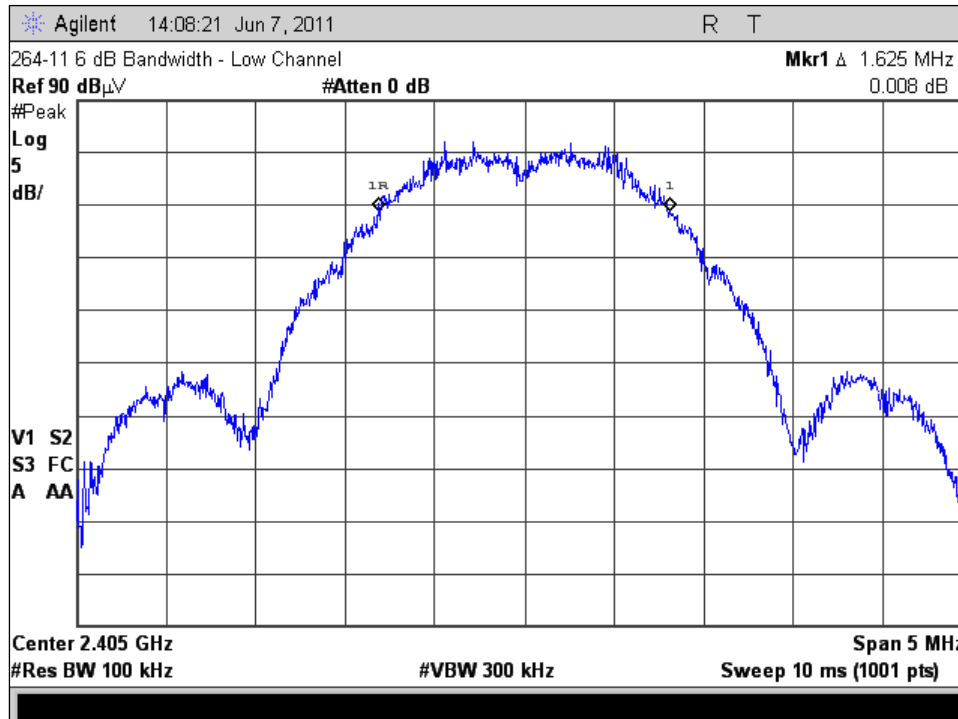

7. Measurement Data

7.2. Minimum 6 dB Bandwidth (15.247 (a) (2), RSS 210 A8.2(a))

7.2.2. Middle Channel - 18

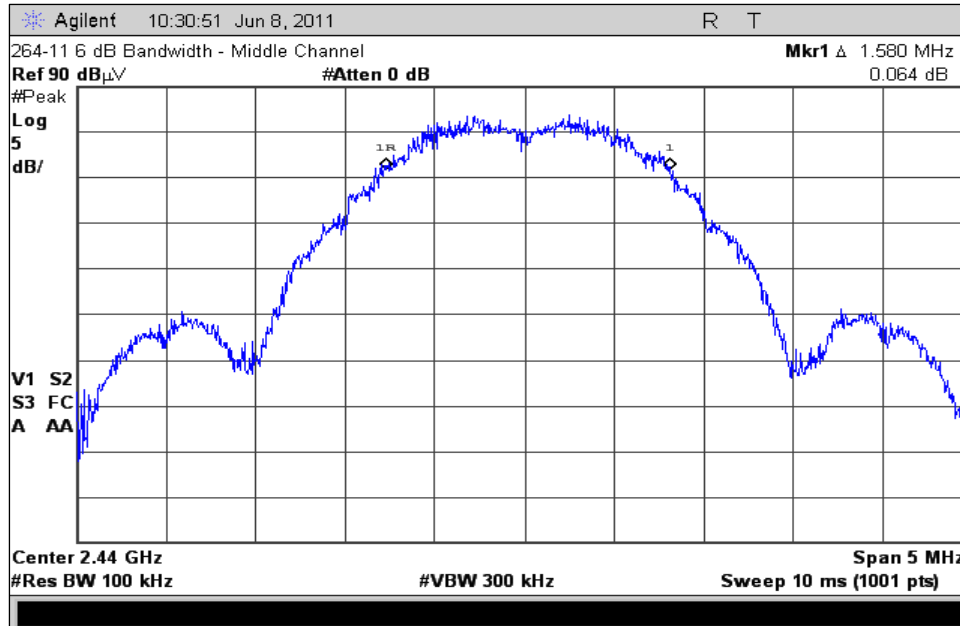

7.2.3. High Channel - 26

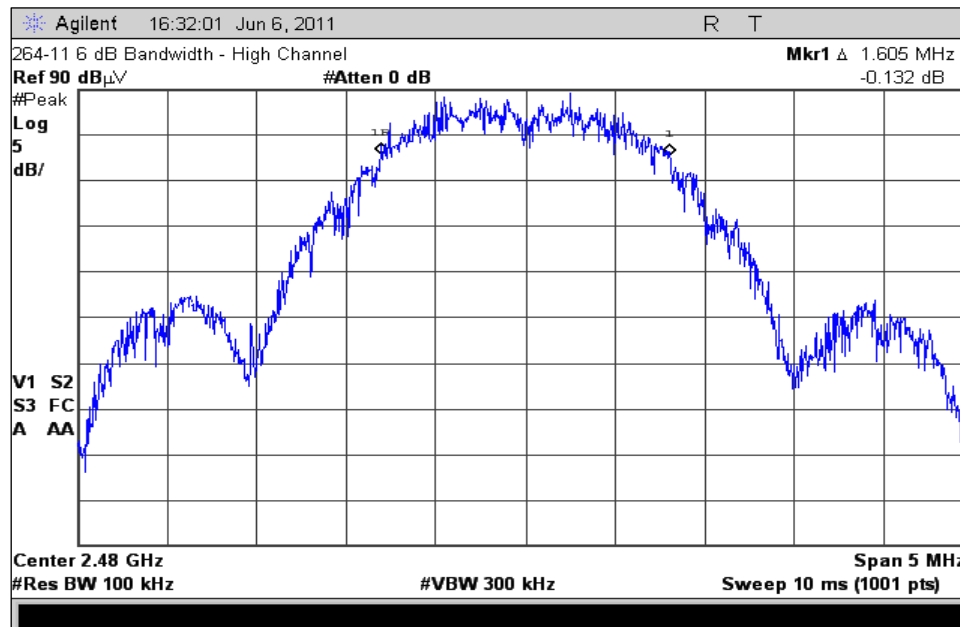

7. Measurement Data (continued)

7.3. 99% Bandwidth (RSS 210)

Requirement: For devices operating above 900 MHz, the 99% bandwidth shall be no wider than 0.5% of the center frequency.

The transmitter shall be operated at its maximum carrier power measured under normal test conditions. The span of the analyzer shall be set to capture all products of the modulation process, including the emission skirts. The resolution bandwidth shall be set to as close to 1% of the selected span as is possible without being below 1%. The video bandwidth shall be set to 3 times the resolution bandwidth.

Resolution Bandwidth : 100 kHz
Video Bandwidth : 300 kHz

Measurement Results

Channel	Channel Frequency (MHz)	99% Power Bandwidth (MHz)	Acceptable Bandwidth (MHz)	Result
Low	2405	2.6034	12.025	Compliant
Middle	2440	2.5161	12.200	Compliant
High	2480	2.5033	12.400	Compliant

7.3.1. Low Channel – 11

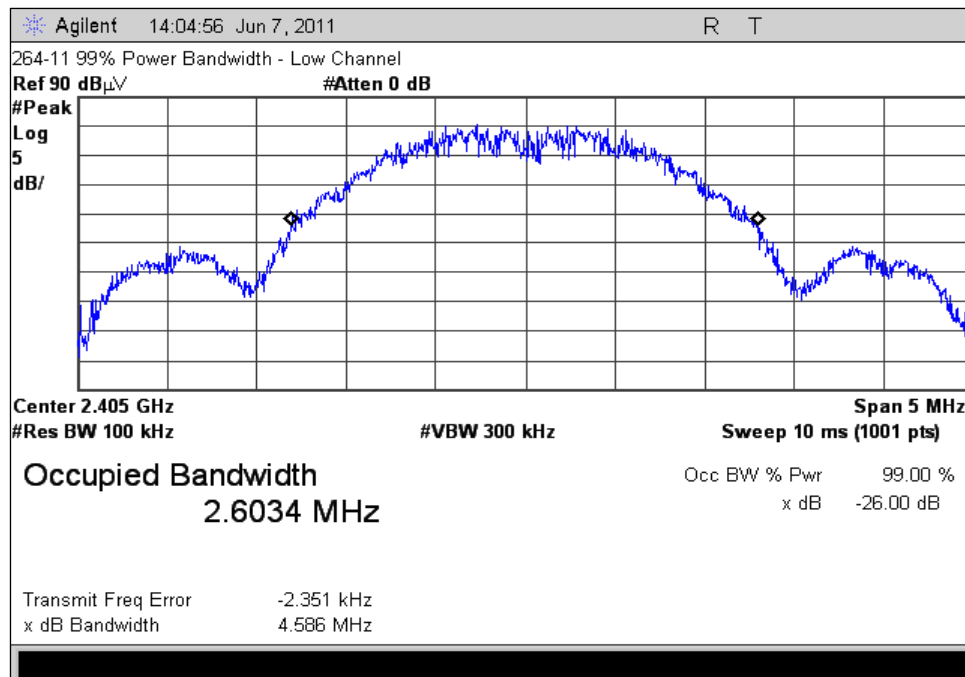

7. Measurement Data (continued)

7.3. 99% Bandwidth (RSS 210) (continued)

7.3.2. Middle Channel – 18

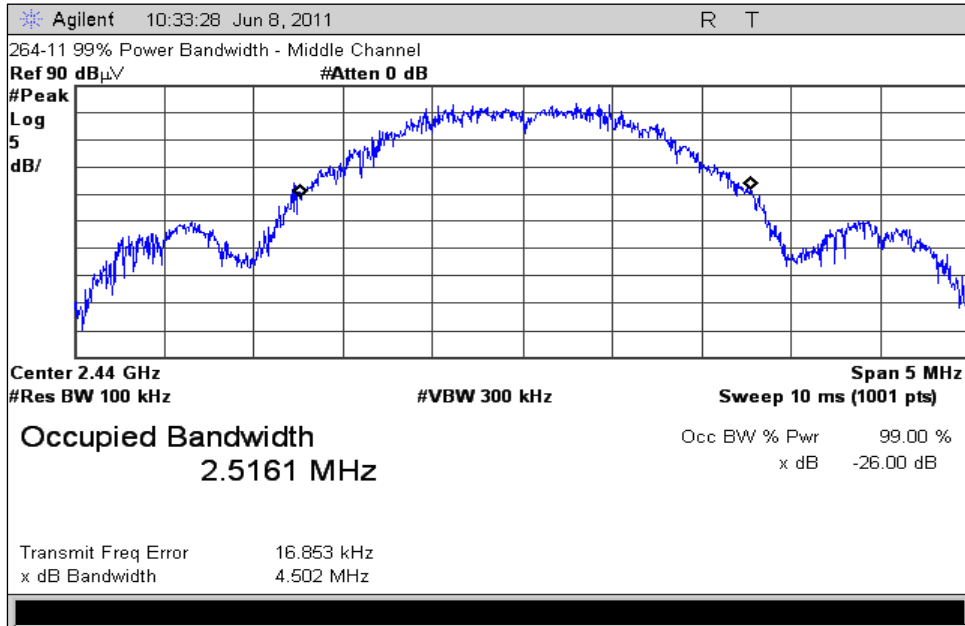

7.3.3. High Channel - 26

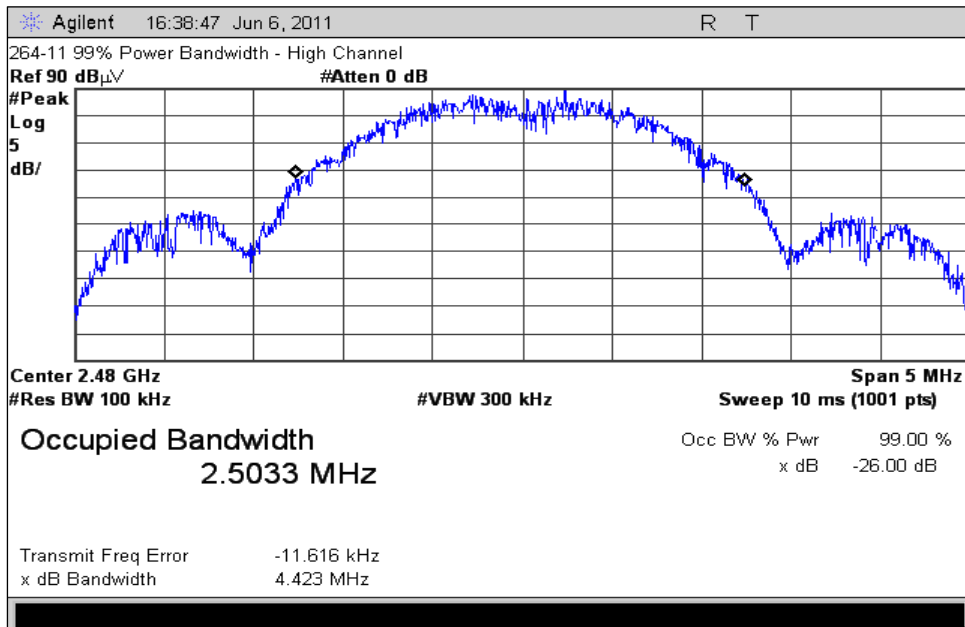

7. Measurement Data (continued)

7.4. Maximum Peak Conducted Output Power (15.247 (b)1(1))

Requirement: The maximum peak conducted output power of the intentional radiator shall not exceed the following: For systems using digital modulation in the 902–928 MHz, 2400–2483.5 MHz, and 5725–5850 MHz bands: 1 Watt.

Test Notes: The MX40 Short Range Radio Antenna is not removable; therefore the output power was determined from the measured field strength using the following equation:

$$P = \frac{(E \times d)^2}{(30 \times G)}$$

- P = the power in Watts (power has been converted to milliwatts in the table).
- E = the measured maximum field in V/m.
- G = the numeric gain of the transmitting antenna over an isotropic radiator.
- d = the distance in meters of the field strength measurement.

Resolution Bandwidth : 1 MHz
Video Bandwidth : 3 MHz

Measurement Results

Channel	Frequency	Peak Field Strength	Distance	Antenna Gain ¹	Output Power	Output Power Limit	Result
	(MHz)	(dBµV/m)	(m)	(dBi)	(mW)	(mW)	
Low	2405	89.70	3.0	0.3	0.26	1000	Compliant
Middle	2440	91.03	3.0	0.3	0.35	1000	Compliant
High	2480	93.30	3.0	0.3	0.60	1000	Compliant

¹ Taken from the antenna manufacture's data guide.

7. Measurement Data (continued)

7.4. Maximum Peak Conducted Output Power (15.247 (b) (1)) (continued)

7.4.1. Low Channel - 11

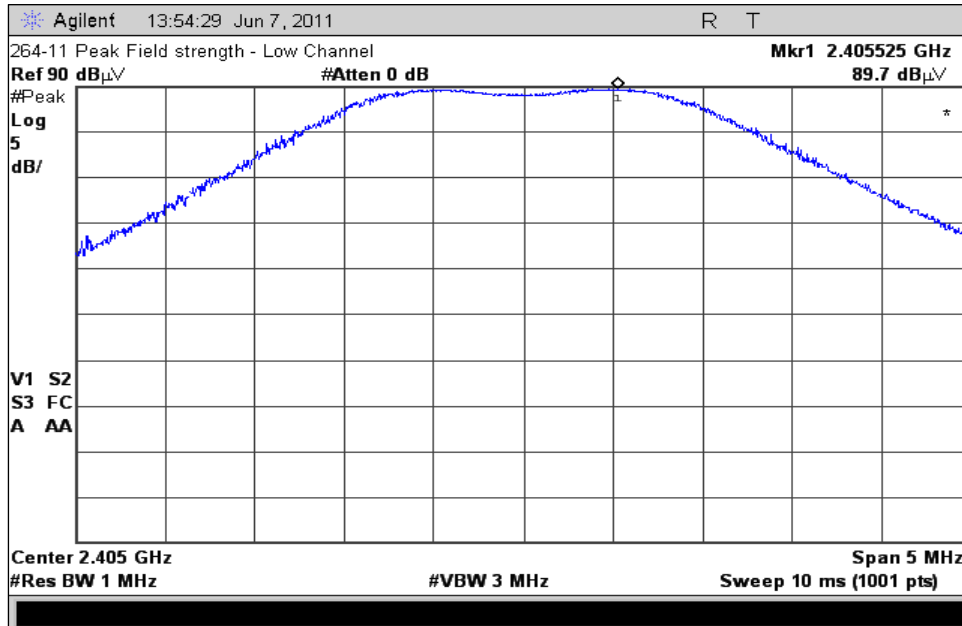

7.4.2. Middle Channel - 18

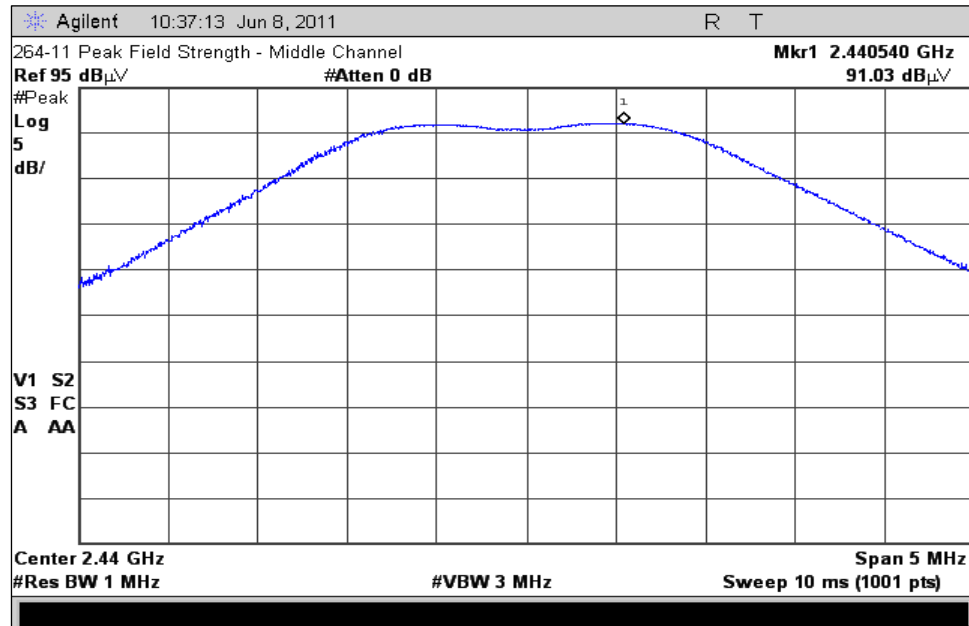

7. Measurement Data (continued)

7.4. Maximum Peak Conducted Output Power (15.247 (b) (1)) (continued)

7.4.3. High Channel – 26

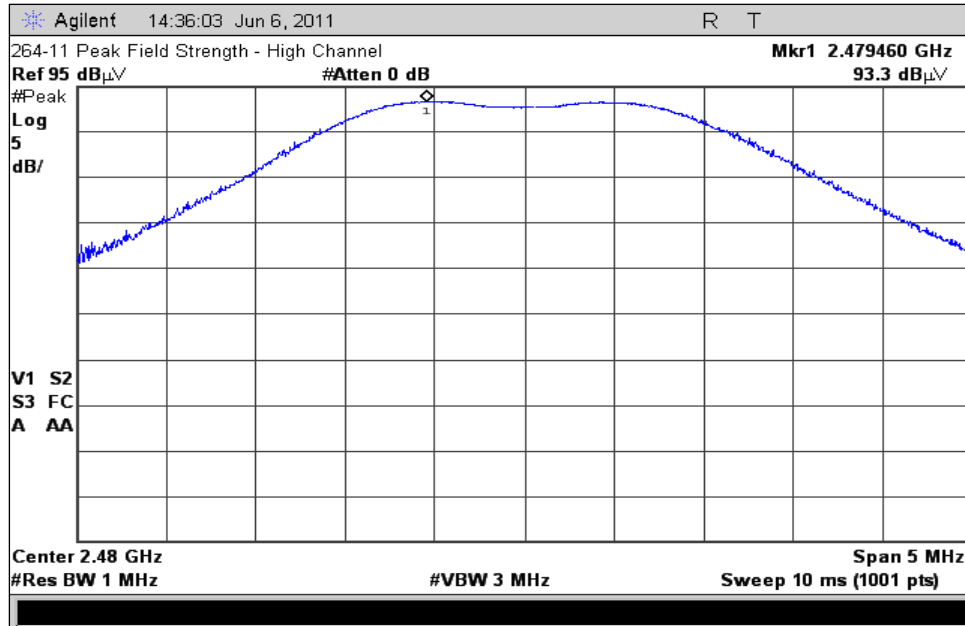

7. Measurement Data (continued)

7.5. Operation with directional antenna gains greater than 6 dBi (15.247 (b)(4))

Requirement: If transmitting antennas of directional gain greater than 6 dBi are used, the conducted output power from the intentional radiator shall be reduced below the stated values in paragraphs (b)(1), (b)(2), and (b)(3) of FCC Part 15.247, as appropriate, by the amount in dB that the directional gain of the antenna exceeds 6 dBi.

DUT Status: **The MX40 2.4 GHz Short Range Radio utilizes an antenna with 1.8 dBi peak and 0.3 dBi average antenna gain values and therefore is not affected by this clause.**

7.6. Transmitter Spurious Radiated Emissions (32 kHz to 40 GHz)

7.6.1. Regulatory Limit: FCC, Part 209, Quasi-Peak

Frequency Range (MHz)	Distance (Meters)	Limit (dBµV/m) ¹
0.009 to 0.490	3	128.5 to 93.8
0.490 to 1.705	3	73.8 to 63.0
1.705 to 30	3	69.5
30 to 88	3	40.0
88 to 216	3	43.5
216 to 960	3	46.0
>960	3	54.0

¹Measurements in the 9 to 90 kHz, 110 to 490 kHz and above 1000 MHz ranges employ an average detector. Otherwise a quasi-peak detector is used.

7.6.2. Measurement & Equipment Setup

Test Date:	6/17/2011, 01/25/2012
Test Engineer:	Brian Breault
Site Temperature (°C):	21.3
Relative Humidity (%RH):	31
Frequency Range:	30 MHz to 40 GHz
Measurement Distance:	3 Meters
EMI Receiver IF Bandwidth:	120 kHz (30 MHz – 1 GHz) 1 MHz (>1GHz)
EMI Receiver Avg Bandwidth:	300 kHz (30 MHz – 1 GHz) 3 MHz (>1GHz)
Detector Functions:	Peak, Quasi-Peak, Average
Antenna Height:	1 to 4 meters

7.6.3. Test Procedure

Test measurements were made in accordance with ANSI C63.4-2003, Standard Methods of Measurement of Radio Noise Emissions from Low-Voltage Electrical and Electronics Equipment in the Range of 9 kHz to 40 GHz.

7. Measurement Data (continued)

7.6. Transmitter Spurious Radiated Emissions (32 kHz to 40 GHz)

7.6.4. Spurious Radiated Emissions (32 kHz – 30 MHz) Test Results

7.6.4.1. Measurement Results – Parallel Antenna

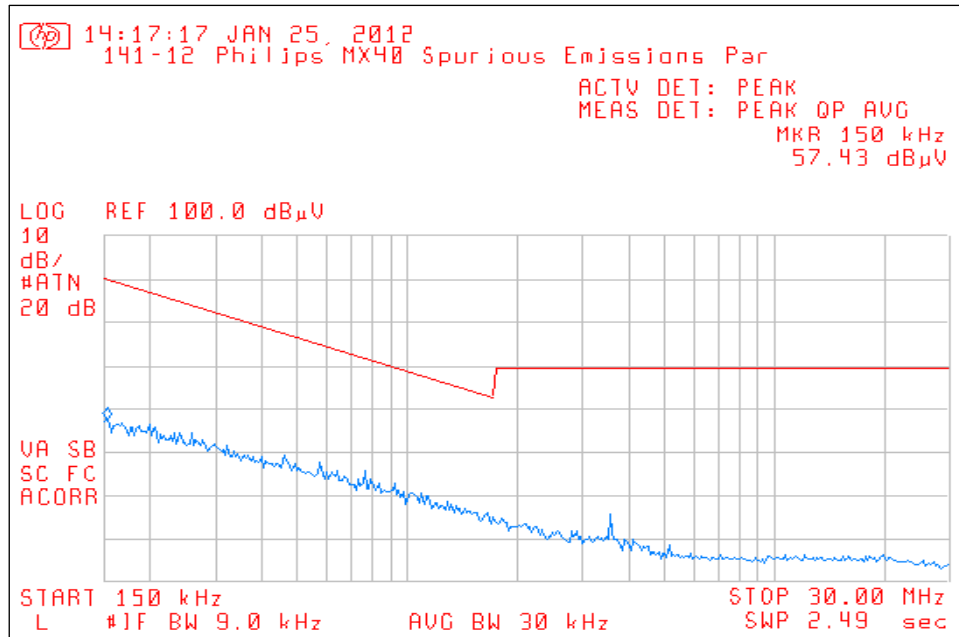
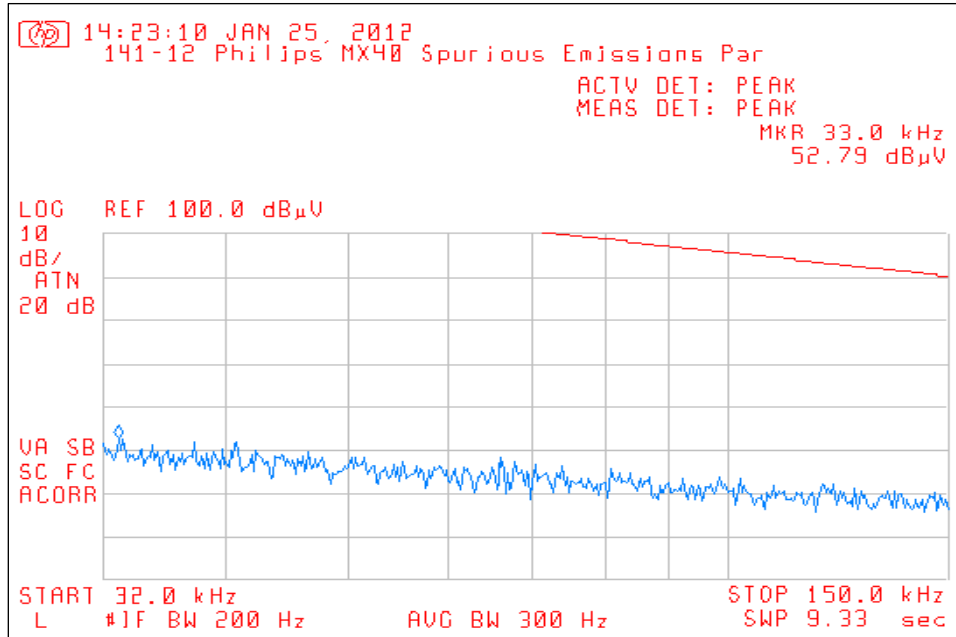

7. Measurement Data (continued)

7.6. Transmitter Spurious Radiated Emissions (32 kHz to 40 GHz)

7.6.4. Spurious Radiated Emissions (32 kHz – 30 MHz) Test Results

7.6.4.2. Measurement Results – Perpendicular Antenna

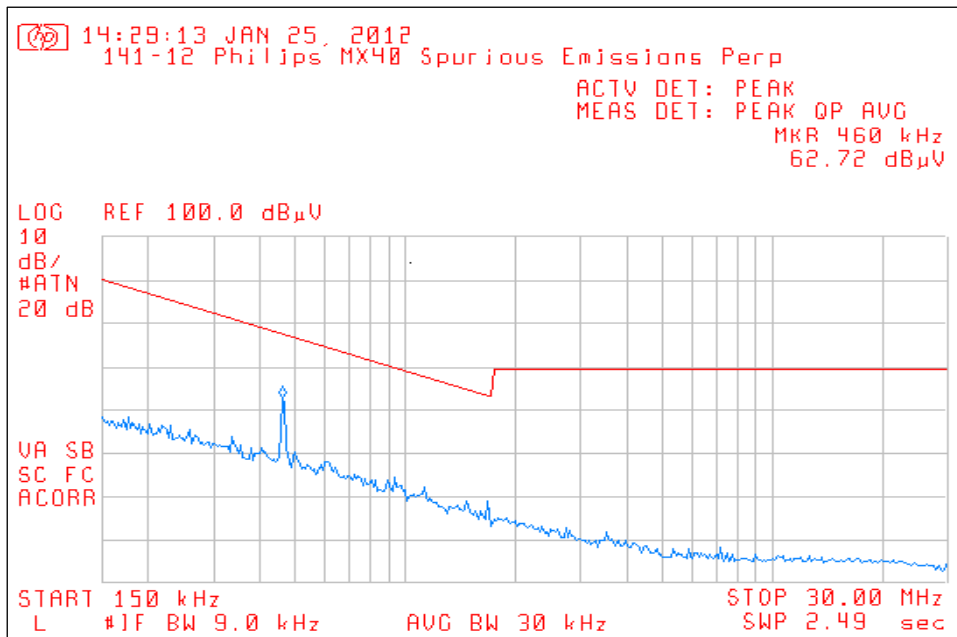
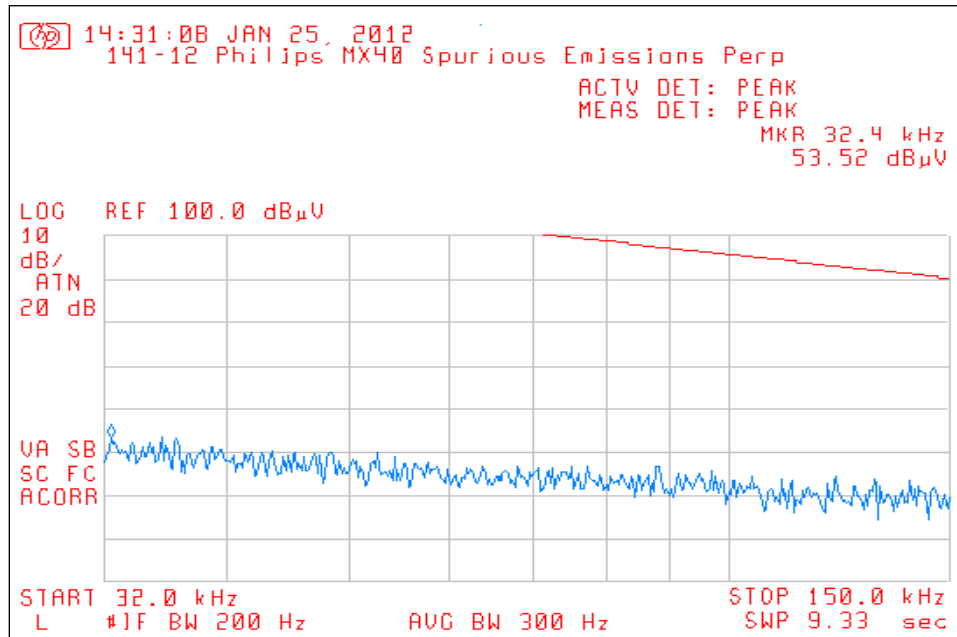

7. Measurement Data (continued)

7.6. Transmitter Spurious Radiated Emissions (32 kHz to 40 GHz)

7.6.4. Spurious Radiated Emissions (30 MHz – 1 GHz) Test Results

7.6.4.3. Measurement Results – Horizontal Polarity

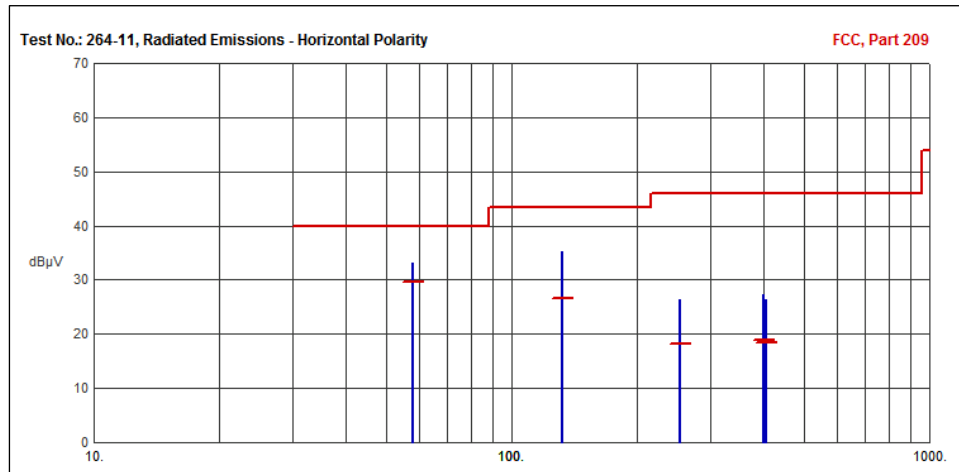

Frequency (MHz)	Pk Amp (dBµV/m)	QP Amp (dBµV/m)	QP Limit (dBµV/m)	Margin (dB)	Comments
58.1710	33.04	29.56	40.00	-10.44	Compliant
131.9846	35.20	26.62	43.50	-16.88	Compliant
252.3643	26.43	18.12	46.00	-27.88	Compliant
401.3869	27.40	18.90	46.00	-27.10	Compliant
406.4089	26.34	18.50	46.00	-27.50	Compliant

7.6.4.4. Measurement Results – Vertical Polarity

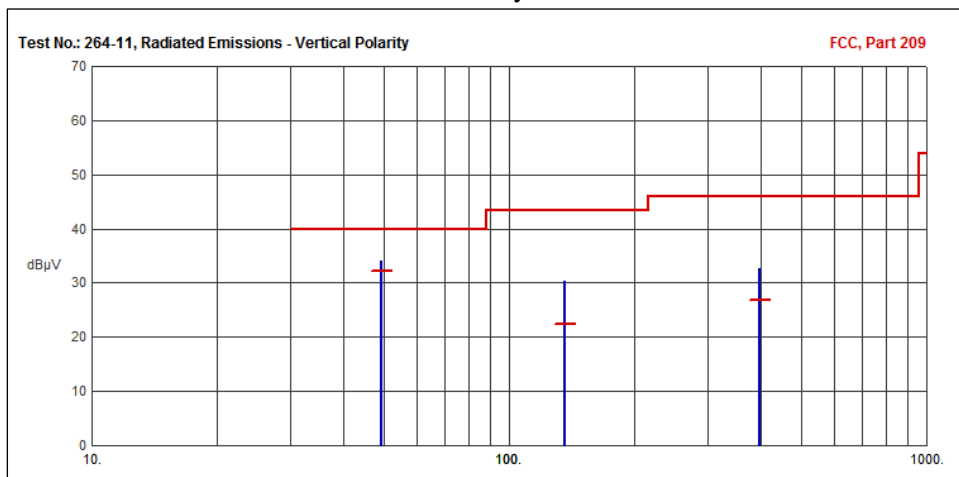

.Frequency (MHz)	Pk Amp (dBµV/m)	QP Amp (dBµV/m)	QP Limit (dBµV/m)	Margin (dB)	Comments
49.5090	33.98	32.10	40.00	-7.90	Compliant
136.1012	30.45	22.35	43.50	-21.15	Compliant
399.0156	32.57	26.87	46.00	-19.13	Compliant

7. Measurement Data (continued)

7.6. Transmitter Spurious Radiated Emissions (32 kHz to 40 GHz)

7.6.5. Spurious Radiated Emissions (Above 1 GHz) Test Results

There were measurable no transmitter spurious emissions other than the emissions tabled in section 7.6.6.

7.6.6. Transmitter Spurious Emissions - Combined Harmonic Emissions Test Results

Freq. (MHz)	Field Strength (dBµV/m)		Limit (dBµV/m)		Margin (dBµV/m)		Antenna Polarity (H/V)	Result
	Peak	Average	Peak	Average	Peak	Average		
4810.0	50.88	44.49	74.00	54.00	-23.12	-9.51	V	Compliant
4880.0	52.00	39.56	74.00	54.00	-22.00	-14.44	H	Compliant
4960.0	56.71	34.45	74.00	54.00	-17.29	-19.55	H	Compliant
7215.0	50.58	38.22	74.00	54.00	-23.42	-15.78	V	Compliant
7320.0	49.64	37.67	74.00	54.00	-24.36	-16.33	V	Compliant
7440.0	49.26	37.15	74.00	54.00	-24.74	-16.85	H	Compliant
9620.0	52.75	40.45	74.00	54.00	-21.25	-13.55	V	Compliant
9760.0	52.30	43.11	74.00	54.00	-21.70	-10.89	H	Compliant
9920.0	55.26	41.25	74.00	54.00	-18.74	-12.75	H	Compliant
12025.0	55.37	42.28	74.00	54.00	-18.63	-11.72	V	Compliant
12200.0	53.82	41.66	74.00	54.00	-20.18	-12.34	H	Compliant
12400.0	54.37	41.91	74.00	54.00	-19.63	-12.09	H	Compliant
14430.0	59.52	47.38	74.00	54.00	-14.48	-6.62	V	Compliant
14640.0	60.52	47.75	74.00	54.00	-13.48	-6.25	H	Compliant
14880.0	58.31	46.23	74.00	54.00	-15.69	-7.77	H	Compliant
16835.0	50.19	38.01	74.00	54.00	-23.81	-15.99	V	Compliant
17080.0	52.84	39.98	74.00	54.00	-21.16	-14.02	H	Compliant
17360.0	54.70	42.31	74.00	54.00	-19.30	-11.69	H	Compliant
19240.0	51.72	38.79	74.00	54.00	-22.28	-15.21	V	Compliant
19520.0	52.27	39.67	74.00	54.00	-21.73	-14.33	H	Compliant
19840.0	50.66	38.04	74.00	54.00	-23.34	-15.96	H	Compliant
21645.0	50.95	38.38	74.00	54.00	-23.05	-15.62	V	Compliant
21960.0	51.39	38.91	74.00	54.00	-22.61	-15.09	H	Compliant
22320.0	50.87	38.45	74.00	54.00	-23.13	-15.55	H	Compliant
24050.0	51.64	39.60	74.00	54.00	-22.36	-14.40	H	Compliant
24400.0	56.05	43.78	74.00	54.00	-17.95	-10.22	V	Compliant
24800.0	55.91	43.35	74.00	54.00	-18.09	-10.65	H	Compliant

7. Measurement Data (continued)

7.7. Band Edge Measurements

Requirement: In any 100 kHz bandwidth outside the frequency band in which the spread spectrum or digitally modulated intentional radiator is operating, the radio frequency power that is produced by the intentional radiator shall be at least 20 dB below that in the 100 kHz bandwidth within the band that contains the highest level of the desired power, based on either an RF conducted or a radiated measurement, provided the transmitter demonstrates compliance with the peak conducted power limits. If the transmitter complies with the conducted power limits based on the use of RMS averaging over a time interval, as permitted under paragraph (b)(3) of this section, the attenuation required under this paragraph shall be 30 dB instead of 20 dB. Attenuation below the general limits specified in Section 15.209(a) is not required. In addition, radiated emissions which fall in the restricted bands, as defined in Section 15.205(a), must also comply with the radiated emission limits specified in Section 15.209(a) (see Section 15.205(c)).

Test Note: For the upper band edge measurement, the procedure detailed in the FCC Office of Engineering and Technology (FCC OET) Publication Number 913591 was used in determining the measurement results.

7.7.1 Measurement Results – Lower Band Edge

Lowest Channel (MHz)	Field Strength (dBµV/m)		Band Edge Frequency (MHz)	Field Strength (dBµV/m)		Limit	Margin (dB)	Result
	Peak	Average		Peak	Average			
2405	86.17	---	2400	47.16	---	>20 dB	-39.01	Compliant

Measurement Plot – Lower Band Edge

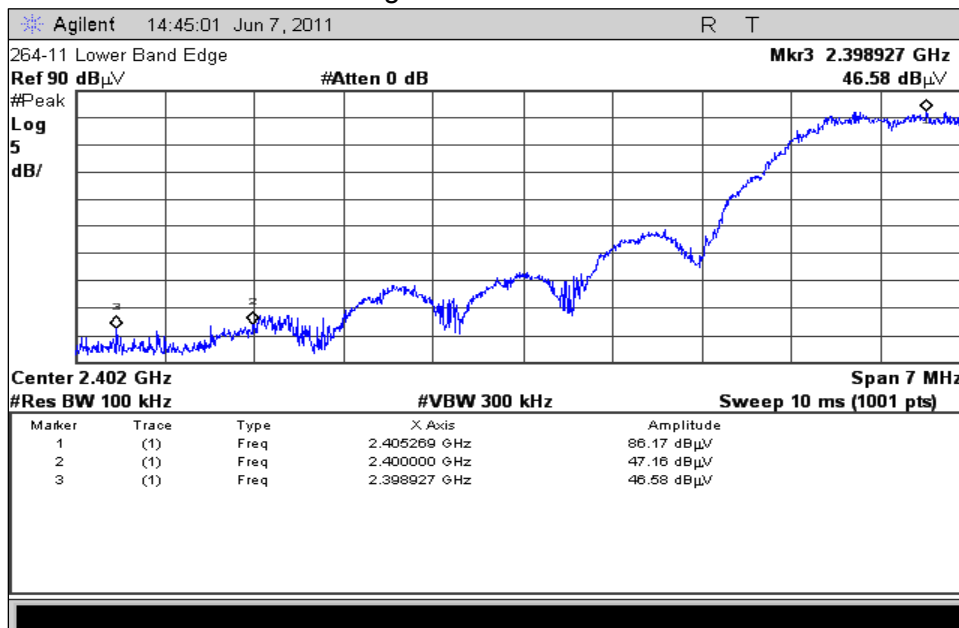

7. Measurement Data (continued)

7.7. Band Edge Measurements (continued)

7.7.2. Measurement Results – Upper Band Edge

	Freq. (MHz)	Field Strength (dB μ V/m)		Limit (dB μ V/m)		Margin (dB μ V/m)		Result
		Peak	Average ¹	Peak	Average	Peak	Average	
Band Edge	2483.500	56.16	19.64	74	54	-17.84	-34.36	Compliant
Worst Case Out of Band	2483.578	56.85	25.36	74	54	-17.15	-28.64	Compliant

¹ Average measurements were taken in real time and are not displayed on the measurement plot.

Measurement Plot – Upper Band Edge

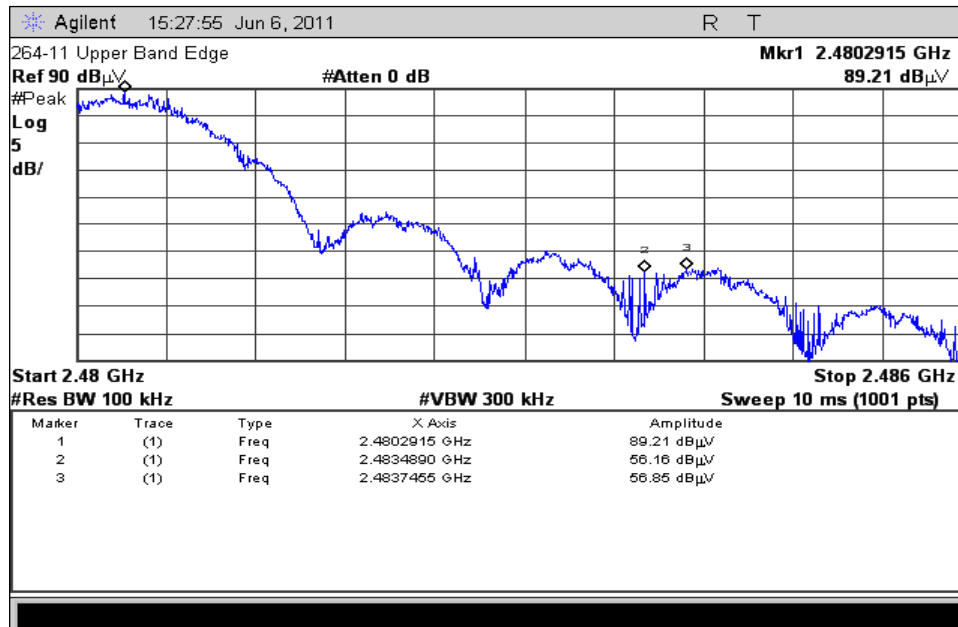

7. Measurement Data

7.7. Band Edge (15.247 (d), RSS-210 A8.5)

7.7.3. Lower Restricted Band (2310 MHz to 2390 MHz)

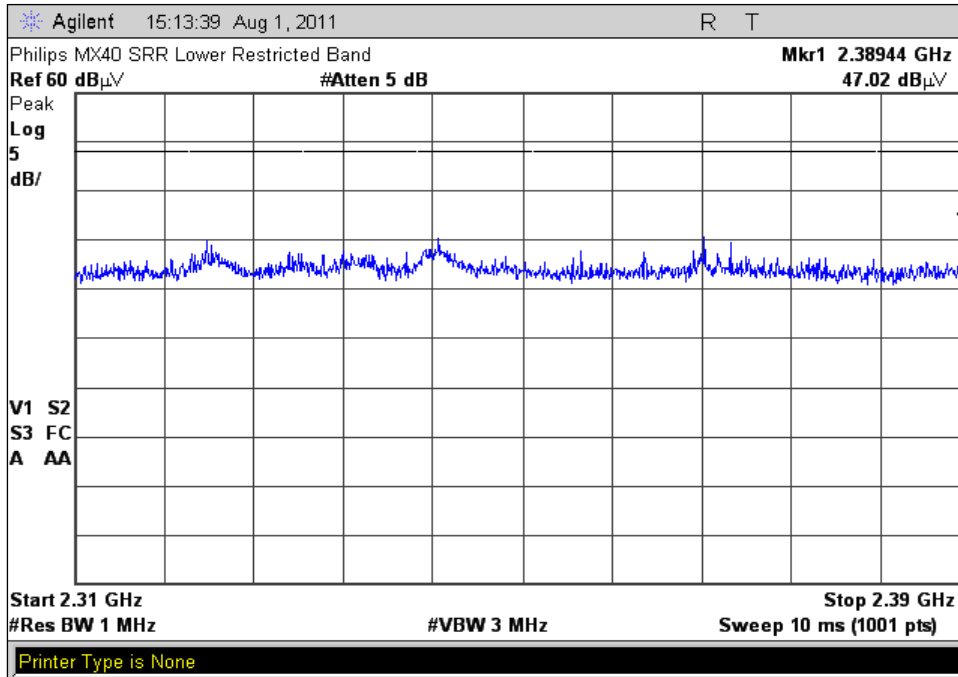

7. Measurement Data (continued)

7.8. Power Spectral Density (15.247(e))

Requirement: For digitally modulated systems, the power spectral density conducted from the intentional radiator to the antenna shall not be greater than 8 dBm in any 3 kHz band during any time interval of continuous transmission. This power spectral density shall be determined in accordance with the provisions of paragraph (b) of this section. The same method of determining the conducted output power shall be used to determine the power spectral density.

Test Note: Reference the equation used in Section 6.4 for determining the power spectral density (dBm) from the radiated field strength value.

Channel	Channel Frequency (GHz)	Measured Frequency (GHz)	PSD Value Radiated (dBμV/m)	Power Spectral Density (dBm)	Limit (dBm)	Result
Low	2405	2.4050600	74.39	-21.139	8	Compliant
Middle	2440	2.4406300	76.22	-19.309	8	Compliant
High	2480	2.4806200	79.35	-16.179	8	Compliant

7.8.1. Power Spectral Density Measurement Plot, Low Channel - 11

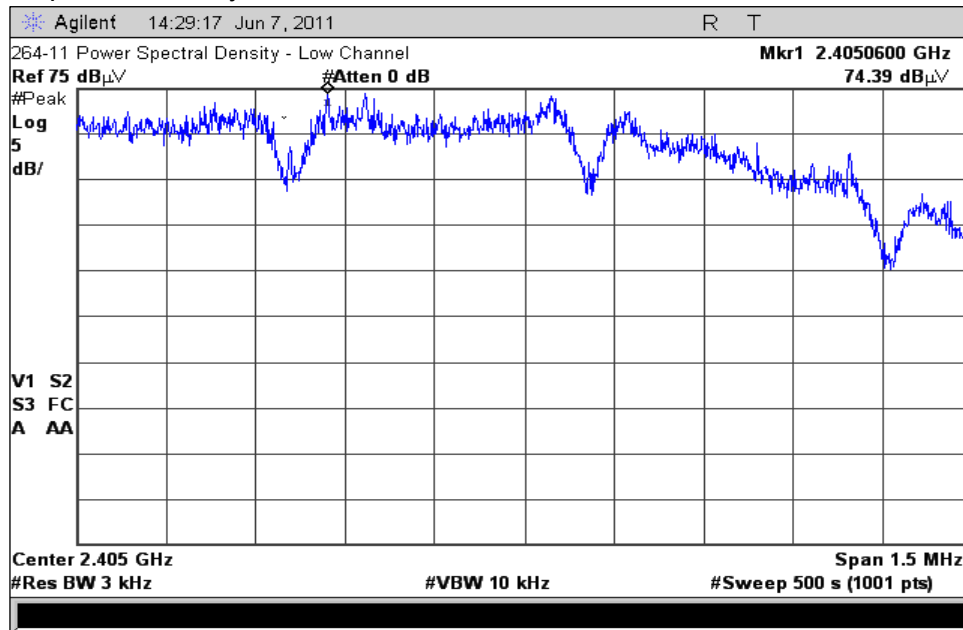

7. Measurement Data (continued)

7.8. Power Spectral Density (15.247(e))

7.8.2. Power Spectral Density Measurement Plot, Mid Channel – 18

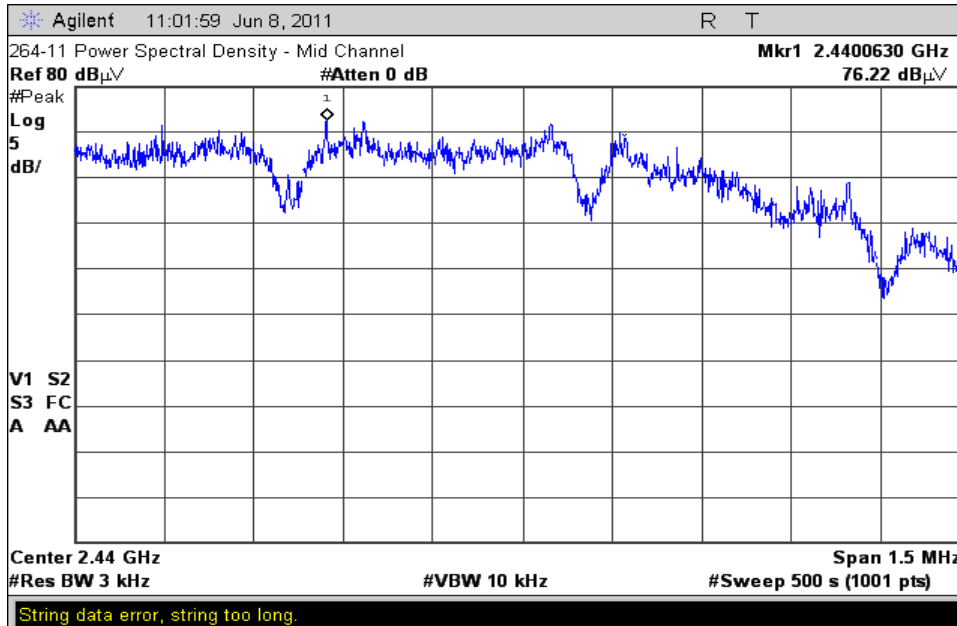

7.8.3. Power Spectral Density Measurement Plot, High Channel – 26



7. Measurement Data (continued)

**7.9. Public Exposure to Radio Frequency Energy Levels (15.247(i) (1.1307 (b)(1))
RSS-GEN 5.5, RSS 102**

Channel Frequency	MPE Distance (cm)	DUT Output Power (dBm)	DUT Antenna Gain (dBi)	Power Density		Limit (mW/cm ²)	Result
				(mW/cm ²)	(W/m ²)		
	(1)	(2)	(3)	(4)		(5)	
2405	2.5	-5.83	0.3	0.00356	0.03565	1	Compliant
2440	2.5	-4.50	0.3	0.00484	0.04842	1	Compliant
2480	2.5	-2.23	0.3	0.00817	0.08166	1	Compliant

$$PD = \frac{OP + AG}{(4 \times \pi \times d^2)}$$

- PD = Power Density (mW/cm²)
- OP = DUT Output Power (dBm)
- AG = DUT Antenna Gain (dBi)
- d = MPE Distance (cm)

1. Reference CFR 2.1093(b): For purposes of this section, a portable device is defined as a transmitting device designed to be used so that the radiating structure(s) of the device is/are within 2.5 centimeters of the body of the user.
2. Section 7.4 of this test report.
3. Data supplied by the client. Antenna specification data of worst case antenna used by the DUT.
4. Power density is calculated from field strength measurement and antenna gain.
5. Reference CFR 1.1310, Table 1: Limits for Maximum Permissible Exposure (MPE), Section (B): Limits for General Population/Uncontrolled Exposure.

RSS-102 Section 2.5, 2.5.1 & 2.5.2 Requirements:

- 2.5 - All transmitters are exempt from routine SAR and RF exposure evaluations provided that output power complies with the power levels of sections 2.5.1 or 2.5.2. If the equipment under test (EUT) meets the requirements of sections 2.5.1 or 2.5.2, applicants are only required to submit a properly signed declaration of compliance (see Annex C).
- 2.5.1 - SAR evaluation is required if the separation distance between the user and the radiating element of the device is less than or equal to 20 cm, except when the device operates as follows:
 - above 2.2 GHz and up to 3 GHz inclusively, and with output power (i.e. the higher of the conducted or radiated (e.i.r.p.) source-based, time-averaged output power) that is less than or equal to 20 mW for general public use and 100 mW for controlled use
- 2.5.2 - RF exposure evaluation is required if the separation distance between the user and the device's radiating element is greater than 20 cm, except when the device operates as follows:
 - at or above 1.5 GHz and the maximum EIRP of the device is equal to or less than 5 W.

8. Test Setup Photographs

8.1. Radiated Emissions Front:



8. Test Setup Photographs

8.2. Radiated Emissions Rear:



9. Test Site Description

Compliance Worldwide is located at 357 Main Street in Sandown, New Hampshire. The test sites at Compliance Worldwide are used for conducted and radiated emissions testing in accordance with Federal Communications Commission (FCC) and Industry Canada standards. A description of the test sites is on file with the FCC (registration number **96392**) and Industry Canada (file number **IC 3023A-1**).

The radiated emissions test site is a 3 and 10 meter enclosed open area test site (OATS). Personnel, support equipment and test equipment are located in the basement beneath the OATS ground plane.

The conducted emissions site is part of a 16' x 20' x 12' ferrite tile chamber and uses one of the walls for the vertical ground plane required by EN 55022.

Both sites are designed to test products or systems 1.5 meter W x 1.5 meter L x 2.0 meter H, floor standing or table top.