

**COMPLIANCE WORLDWIDE INC.
TEST REPORT 304-11R2**

In Accordance with the Requirements of
**FCC PART 15.247, SUBPART C
INDUSTRY CANADA RSS 210, ISSUE 8**

Low Power License-Exempt Radio Communication Devices
Intentional Radiators

Issued to

**Philips Medical Systems
3000 Minuteman Drive
Andover, MA 01810
978-659-2800**

for the

**Philips Telemetry System
MX40 Patient Worn Monitor
2.4 GHz 802.11b/g WLAN**

**FCC ID: PQC-MX40SH24
IC: 3549B-MX40SH24**

Report Issued on August 5, 2011

Tested by



Brian F. Breault

Reviewed by



Larry K. Stillings

This test report shall not be reproduced, except in full, without written permission from Compliance Worldwide, Inc.

Table of Contents

1. Scope	3
2 .Product Details	3
2.1 Manufacturer	3
2.3 Serial Number.....	3
2.4 Description.....	3
2.5 Power Source	3
2.6 EMC Modifications.....	3
3. Product Configuration	3
3.1 Operational Characteristics & Software	3
3.2 EUT Hardware.....	4
3.3 . EUT Hardware/Software/Firmware Revision Level.....	4
3.4 EUT Cables/Transducers	4
3.5 Support Equipment.....	4
3.6 Support Equipment Cables/Transducers	4
3.7 Miscellaneous.....	5
3.8 Block Diagram	5
4. Measurements Parameters	6
4.1 Measurement Equipment Used to Perform Test.....	6
4.2 Measurement & Equipment Setup	6
4.3 Measurement Procedure.....	6
5. Choice of Equipment for Test Suits.....	7
5.1 Choice of Model.....	7
5.2 Presentation	7
5.3 Choice of Operating Frequencies.....	7
6. Measurement Summary.....	8
7. Measurement Data.....	8
7.1 Antenna Requirement	8
7.2 Minimum 6 dB Bandwidth.....	9
7.3 99% Bandwidth.....	13
7.4 Maximum Peak Conducted Output Power	17
7.5 Operation with directional antenna gains greater than 6 dBi	22
7.6 Transmitter Spurious Radiated Emissions	22
7.7 Receiver Spurious Radiated Emissions	25
7.8 Band Edge Measurements.....	28
7.9 Power Spectral Density.....	33
7.10 Public Exposure to Radio Frequency Energy Levels.....	37
8. Test Setup Photographs	40
9. Test Site Description.....	41

1. Scope

This test report certifies that the Philips Medical Telemetry System MX40 2.4 GHz Patient Worn Monitor (PWM) 802.11b/g WLAN, as tested, meets the FCC Part 15.247, Subpart C and Industry Canada RSS 210, Issue 8 requirements. The scope of this test report is limited to the test sample provided by the client, only in as much as that sample represents other production units. If any significant changes are made to the unit, the changes shall be evaluated and a retest may be required. Revision R1 added lower restricted band measurement plot to Section 7.8: Band Edge Measurements. Revision R2 Updated MPE.

2. Product Details

2.1. Manufacturer: Philips Medical Systems

2.2. Model Number: IntelliVue MX40

2.3. Serial Number: US11600746

2.4. Description: The Patient Worn Monitor is a body worn patient monitor for ECG and SpO2 measurements. The device has a touch screen display which can display patient waveforms and/or numeric values locally or transmitted via several possible radio links to the hospital wireless network, a wireless bedside monitor, or to a CTS network for display on the IntelliVue Information Center. The device is capable of transmitting in the 2.4GHz (ISM bands), 5.6GHz (ISM bands) and/or the WMTS bands, 1395 MHz to 1400 MHz and 1427 MHz to 1432 MHz. The PWM contains an 802.11 a/b/g WLAN radio to communicate with a WLAN, an 802.15.4 SRR radio to communicate with a SRR equipped bedside monitor, or an optional 1.4 GHz or 2.4 GHz CTS radio to communicate with a Philips CTS network. Performance evaluation during immunity testing shall be done on the PWM display, the WLAN display, the IntelliVue Information Center display and the MP5 bedside monitor. The PWM will be configured with a 2.4 GHz WLAN radio for this test plan.

2.5. Power Source: DC 3 volts – Three 1.5 VDC Alkaline AA Batteries (Regulated)

2.6. EMC Modifications: None

3. Product Configuration

3.1. Operational Characteristics & Software

Insert battery/batteries in the PWM battery compartment and allow the device to boot up to display ESC and SpO2 measurement parameters on the local display as well as the ROW and Wi-Fi PIC systems.

The PWM will need to be put into “TELEMETRY” mode during all testing to allow onboard display to be viewed. To do this, with the PWM running, press the middle “SMART KEY” button on the PWM front panel. When the “SMART KEY” menu comes up, press the “Mode: Telemetry” button. The state should change to “Mode: Monitor”.

Next, the WLAN radio needs to be enabled. While in the “SMART KEY” menu screen, press the double down arrow in the lower right of the Touch screen display to display the next menu screen. Now press the “Op Mode” button which will bring up the “Op Mode” selection screen. Now press the “Service” button which will bring up an “Op Mode” window where the password needs to be entered to change mode. The password, 4 6 3 0, shall be entered and then press the “Enter” button which will put the device into “Service” mode. Now press the “Wireless Setup”

3. Product Configuration

3.1. Operational Characteristics & Software (continued)

button, then press the “WLAN” button, then press the “WLAN Off” button, which will then change to read “WLAN On”.

Now, the device is ready to be placed back into monitoring mode. To accomplish this, press the “X” in the “Service” screen, then press “X” in the Service screen again, then press “X” in the Service screen again. Now the “SMART KEY” window should be displayed. Press the “Op Mode” button which will bring up the “Op Mode” menu screen. Press the “Monitoring” button and the Patient Window should be displayed.

If it is not possible to enact change via the smart keys, press the middle “SMART KEY” button and then using the arrow on the right side of the “SMART KEY” screen scroll down and read the buttons to make sure the device is unlocked. If “Unlock” is displayed next to the “Op Mode” button, the device is locked. Press the “Unlock” button and it should now read “Lock”. The menu keys should now work.

3.2. EUT Hardware

Blk Diag #	Manufactr	Model/Part # / Options	Serial Number	Input Voltage	Frq (Hz)	Description/Function
1	Philips	865350/MX40	US11600746	3 V	DC	Patient Worn Monitor w/2.4 GHz SRR radio, PP3 build units

3.3. EUT Hardware/Software/Firmware Revision Level

EUT Model#	PCA#	Description	HW	SW	FW
MX40		2.4 GHz WLAN radio	Rev. 02	A.00.28	

3.4. EUT Cables/Transducers

Blk Diag Ltr	Manufacturer	Model/Part #	Length (m)	Shield Y/N	Description/Function
A	Philips	989803171871	0.8	Y	SpO2 connector/ECG leadset- 6 leads
B	Philips	M1191A	2	N	SpO2 patient transducer

3.5. Support Equipment

Diag Blk #	Manufacturer	Model/Part # Options	Serial Number	Input Voltage	Input Frq.	Description/Function
7	Philips	M3154B	2UA610JXJK	100-240	50-60	InbteilliVue Information Center
9	Linksys	WRT320N	CUH017J726025	12	DC	WLAN router
12	Philips	190P6EB/27	BZ000534113115	100-240	50-60	Display

3.6. Support Equipment Cables/Transducers

Blk Diag Ltr	Manufacturer	Model/Part #	Length (m)	Shield Y/N	Description/Function
C	NA	NA	Various	N	Cat 5 LAN cables

3. Product Configuration (continued)

3.7. Miscellaneous

Manufacturer	Model/Part #	Description/Function
Duracell	NA	AA batteries
Philips	453564128871	Li-ion rechargeable batteries

3.8. Block Diagram

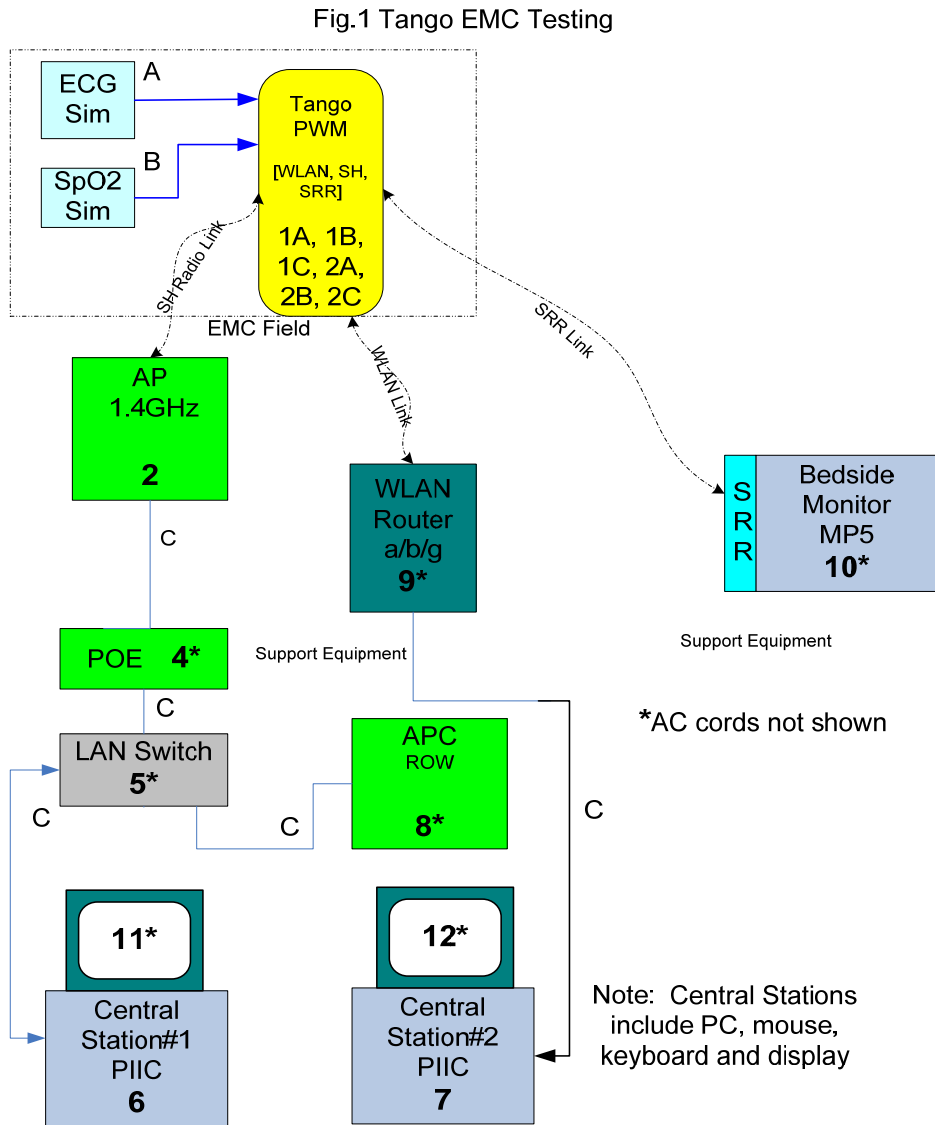

Note: Blk Diag #s 7, 9 and 12 were configured as support equipment for this test.

4. Measurements Parameters

4.1. Measurement Equipment Used to Perform Tests

Device	Manufacturer	Model No.	Serial No.	Cal Due
Spectrum Analyzer	Agilent	E4407B	MY45104493	12/22/2012
Spectrum Analyzer	Agilent	E7405A	MY45115430	10/22/2011
Spectrum Analyzer	Rhode & Schwarz	FSV40	1307.9002K40-100899-ka	5/26/2013
Microwave Preamp	Hewlett Packard	8449B	3008A01323	12/1/2012
Bilog Antenna	Com-Power	AC-220	25509	8/30/2011
Horn Antenna	Electro-Metrics	EM-6961	6337	10/19/2012
Horn Antenna	ComPower	AH-118	10078	7/23/2011
Horn Antenna	ComPower	AH-840	03075	7/20/2012
DMM / Temperature	Fluke	187	79690058	11/29/2011
RF Signal Generator	Hewlett Packard	8648C	3642U01557	7/16/2011
2.4 GHz BP Filter	Micro-Tronics	BRM50702	14	8/11/2011
Digital Barometer	Control Company	4195	ID236	11/9/2011
Thermal Chamber	Associated Testing Labs	SLHU-1-CRLC	N/A	Not Required

4.2. Measurement & Equipment Setup

Test Dates: July 9, 2011 to July 20, 2011

Test Engineers: Larry Stillings
Brian Breault

Normal Site Temperature (15 - 35°C): 21.7

Relative Humidity (20 -75%RH): 33%

Frequency Range: 30 MHz to 24.800 GHz

Measurement Distance: 3 Meters

EMI Receiver IF Bandwidth: 120 kHz - 30 MHz to 1 GHz
1 MHz - Above 1 GHz

EMI Receiver Avg Bandwidth: 300 kHz - 30 MHz to 1 GHz
3 MHz - Above 1 GHz

Detector Function: Peak, QP - 30 MHz to 1 GHz
Peak, Avg - Above 1 GHz
Unless otherwise specified.

4.3. Measurement Procedure

Test measurements were made in accordance FCC Part 15.247, IC RSS-210 Annex II: Operation within the bands 902 - 928 MHz, 2400 - 2483.5 MHz, 5725 - 5875 MHz, and 24.0 - 24.25 GHz.

The test methods used to generate the data in this test report are in accordance with ANSI C63.4: 2003, American National Standard for Methods of Measurement of Radio-Noise Emissions from Low-Voltage Electrical and Electronic Equipment in the Range of 9 kHz to 40 GHz

In accordance with ANSI C63.4-2003, section 13.4.1, c), the device under test was rotated through three orthogonal axes to determine which attitude produced the highest emission relative to the limit. The attitude that produced the highest emission relative to the limit was used for all radiated emission measurements.

5. Choice of Equipment for Test Suits

5.1 Choice of Model

This test report is based on the test samples supplied by the manufacturer and are reported by the manufacturer to be equivalent to the production units.

5.2 Presentation

This test sample was tested complete with all required ancillary equipment. Refer to Section 3 of this report for product equipment configuration.

5.3 Choice of Operating Frequencies

The MX40 2.4 GHz Patient Worn Monitor 802.11b/g operates on a total of 11 channels, from channel 1 to channel 11.

In accordance with ANSI C63.4-2009, section 13.2.1, the choice of operating frequencies selected for the testing outlined in this report was based on the lowest, middle and highest operating frequencies. The frequencies selected were 2412 MHz (Channel 1), 2437 MHz (Channel 6) and 2462 MHz (Channel 11).

6. Measurement Summary

Test Requirement	FCC Rule Requirement	IC Rule Requirement	Report Section	Result
Antenna Requirement	15.203	RSS-GEN 7.1.2	7.1	Compliant
Minimum 6 dB bandwidth	15.247 (a) (2)	RSS-210 A8.2	7.2	Compliant
99% (occupied) bandwidth	N/A	RSS-GEN 4.6.1	7.3	Compliant
Maximum peak conducted output power	15.247 (b) (3)	RSS-210 A8.4 (4)	7.4	Compliant
Operation with directional antenna gains greater than 6 dBi	15.247 (b) (4)	RSS-GEN 7.1.2	7.5	Compliant
Spurious radiated emissions	15.209	RSS-GEN 4.9	7.6	Compliant
Spurious harmonic radiated emissions	ANSI C63.4 10.2.8.2	RSS-210 A8.9	7.6	Compliant
Receiver Spurious Radiated Emissions		RSS-GEN 4.10	7.7	Compliant
Band edge	15.247 (d)	RSS-210 A8.5	7.8	Compliant
Power Spectral Density	15.247 (e)		7.9	Compliant
Power line conducted emissions	15.207	RSS-GEN	N/A	N/A
Public exposure to radio frequency energy levels	15.247 (1) 1.1307 (b)(1)	RSS-GEN 5.5 RSS-102	7.10	Compliant

7. Measurement Data

7.1. Antenna Requirement (15.203)

Requirement: An intentional radiator shall be designed to ensure that no antenna other than that furnished by the responsible party shall be used with the device. The use of a permanently attached antenna or of an antenna that uses a unique coupling to the intentional radiator shall be considered sufficient to comply with the provisions of this Section.

Status: All antennas utilized by the MX40 are internal to the device and not user accessible.

7. Measurement Data (continued)

7.2. Minimum 6 dB Bandwidth (15.247 (a) (2), RSS 210 A8.2(a))

Requirement: Systems using digital modulation techniques may operate in the 902 - 928 MHz, 2400 - 2483.5 MHz, and 5725 - 5850 MHz bands. The minimum 6 dB bandwidth shall be at least 500 kHz.

Resolution Bandwidth : 100 kHz
 Video Bandwidth : 300 kHz

7.2.1. Measurement Results: 802.11b

Channel	Frequency (MHz)	6 dB Bandwidth (kHz)	Minimum 6 dB Bandwidth (kHz)	Result
Low	2412	10000	>500	Compliant
Middle	2437	9000	>500	Compliant
High	2462	10160	>500	Compliant

7.2.1.1. 802.11b, Low Channel – 1

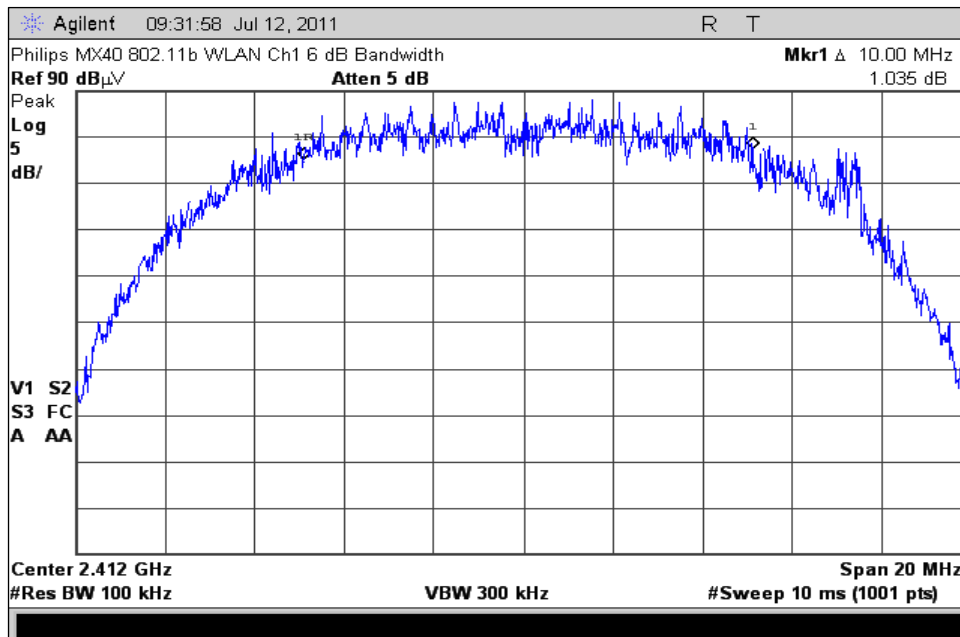

7. Measurement Data

7.2. Minimum 6 dB Bandwidth (15.247 (a) (2), RSS 210 A8.2(a))

7.2.1.2. 802.11b, Middle Channel - 6

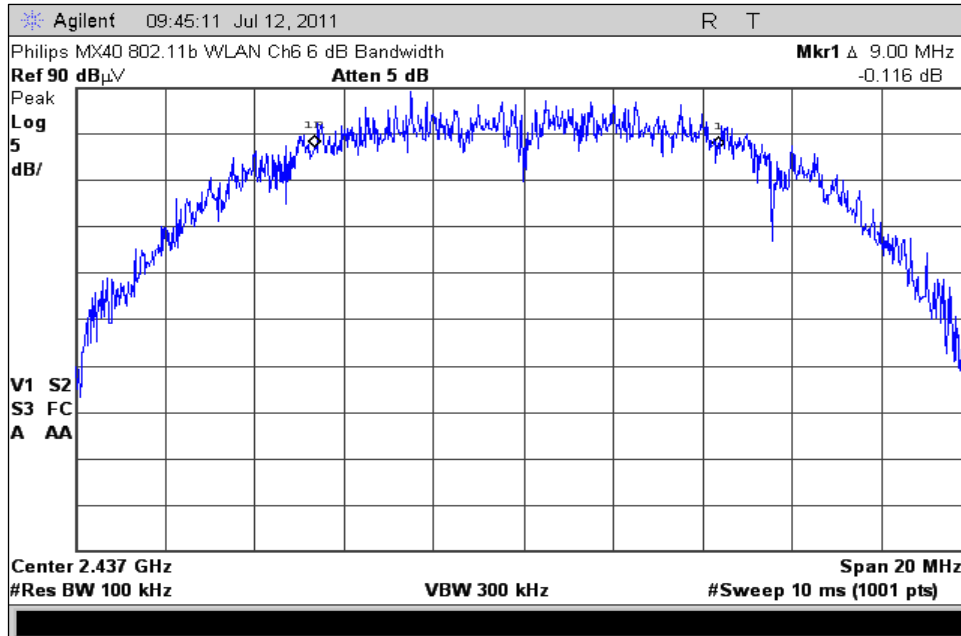

7.2.1.3. 802.11b, High Channel - 11

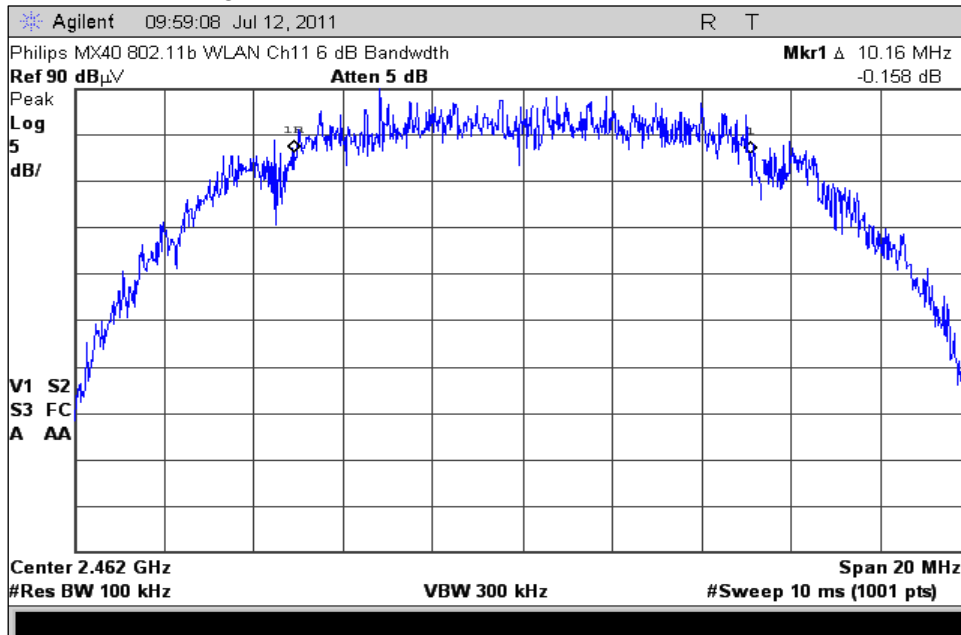

7. Measurement Data (continued)

7.2. Minimum 6 dB Bandwidth (15.247 (a) (2), RSS 210 A8.2(a)) (continued)

7.2.2. Measurement Results: 802.11g

Channel	Frequency (MHz)	6 dB Bandwidth (kHz)	Minimum 6 dB Bandwidth (kHz)	Result
Low	2412	16200	>500	Compliant
Middle	2437	16050	>500	Compliant
High	2462	16350	>500	Compliant

7.2.2.1. 802.11g, Low Channel – 1

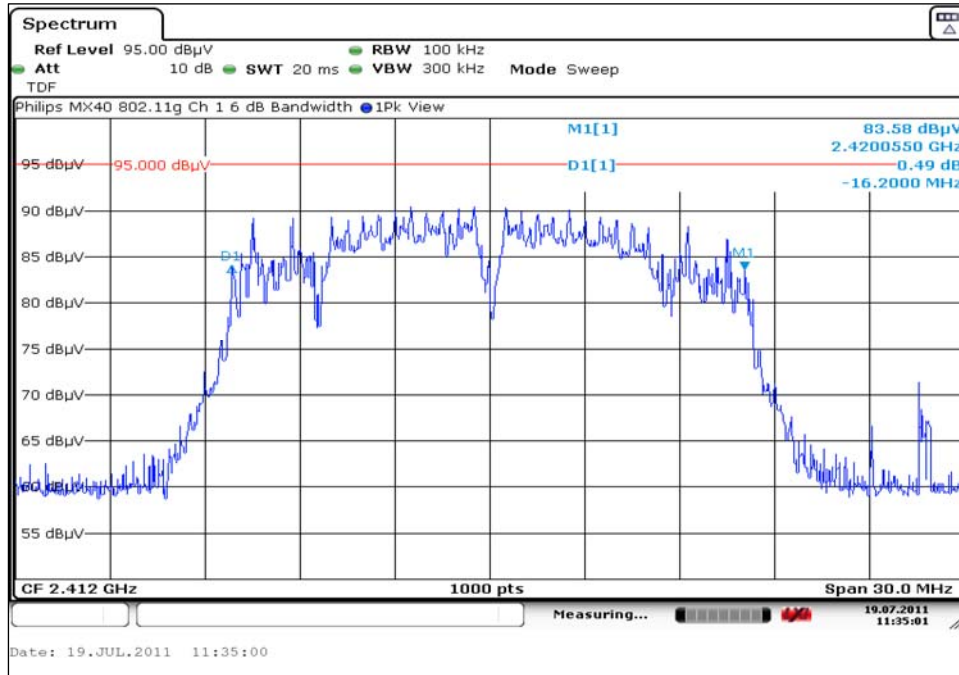

7. Measurement Data

7.2. Minimum 6 dB Bandwidth (15.247 (a) (2), RSS 210 A8.2(a)) (continued)

7.2.2.2. 802.11g, Middle Channel – 6

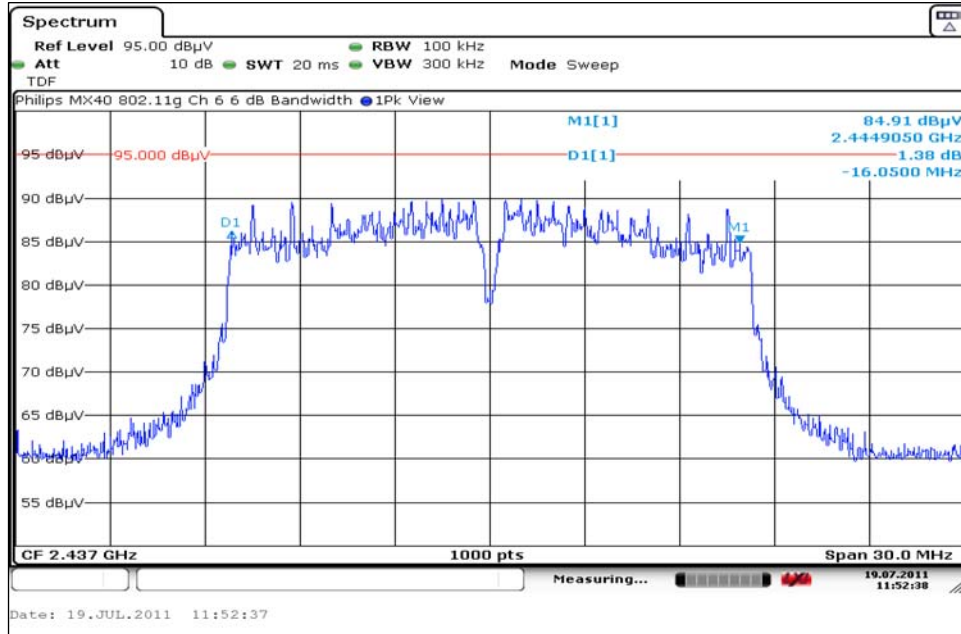

7.2.2.3. 802.11g, High Channel – 11

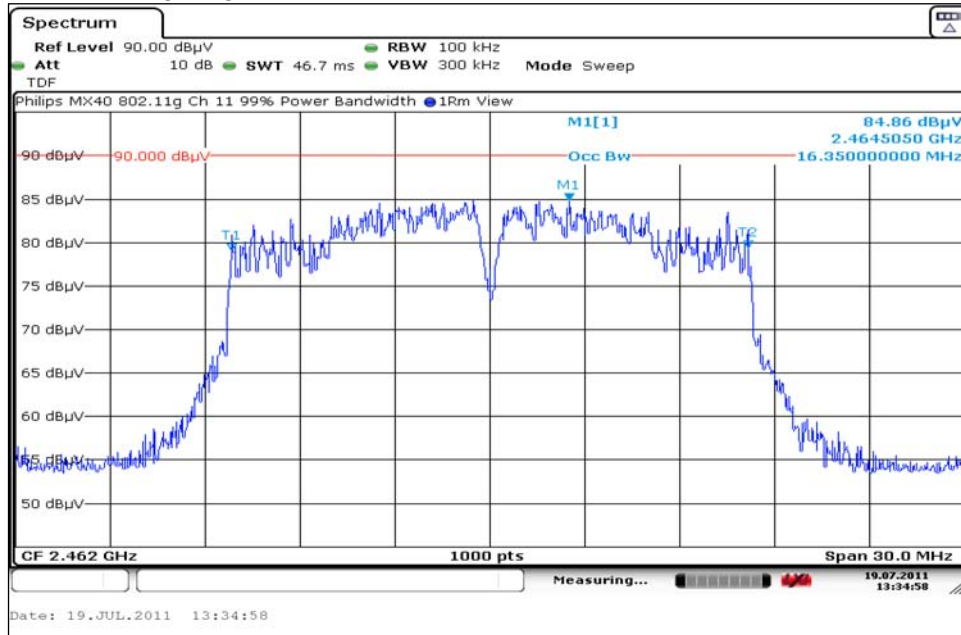

7. Measurement Data (continued)

7.3. 99% Bandwidth (RSS 210)

Requirement: When an occupied bandwidth value is not specified in the applicable RSS, the transmitted signal bandwidth to be reported is to be its 99% emission bandwidth, as calculated or measured.

The transmitter shall be operated at its maximum carrier power measured under normal test conditions. The span of the analyzer shall be set to capture all products of the modulation process, including the emission skirts. The resolution bandwidth shall be set to as close to 1% of the selected span as is possible without being below 1%. The video bandwidth shall be set to 3 times the resolution bandwidth.

Resolution Bandwidth : 100 kHz
 Video Bandwidth : 300 kHz

7.3.1. Measurement Results: 802.11b

Channel	Channel Frequency (MHz)	99% Power Bandwidth (MHz)
Low	2412	16.320
Middle	2437	15.930
High	2462	15.900

7.3.1.1. 802.11b, Low Channel – 1

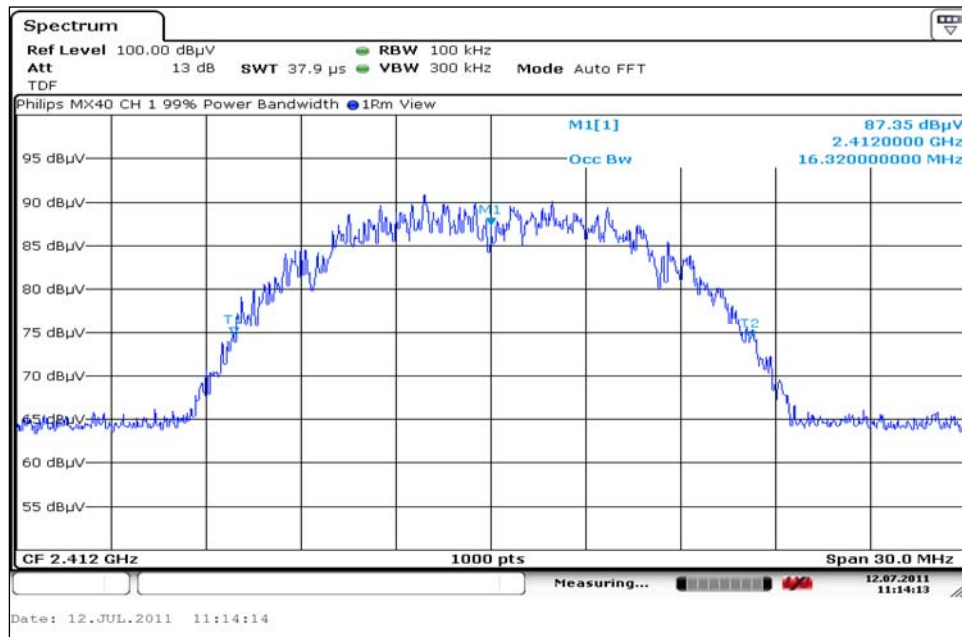

7. Measurement Data (continued)

7.3. 99% Bandwidth (RSS 210) (continued)

7.3.1.2. 802.11b, Middle Channel – 6

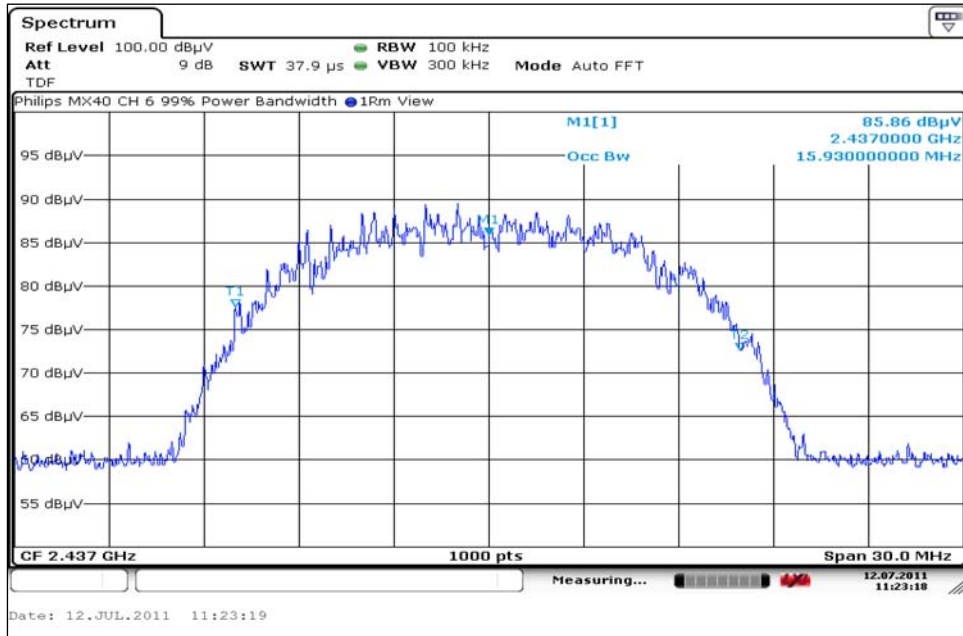

7.3.1.3. 802.11b, High Channel - 26

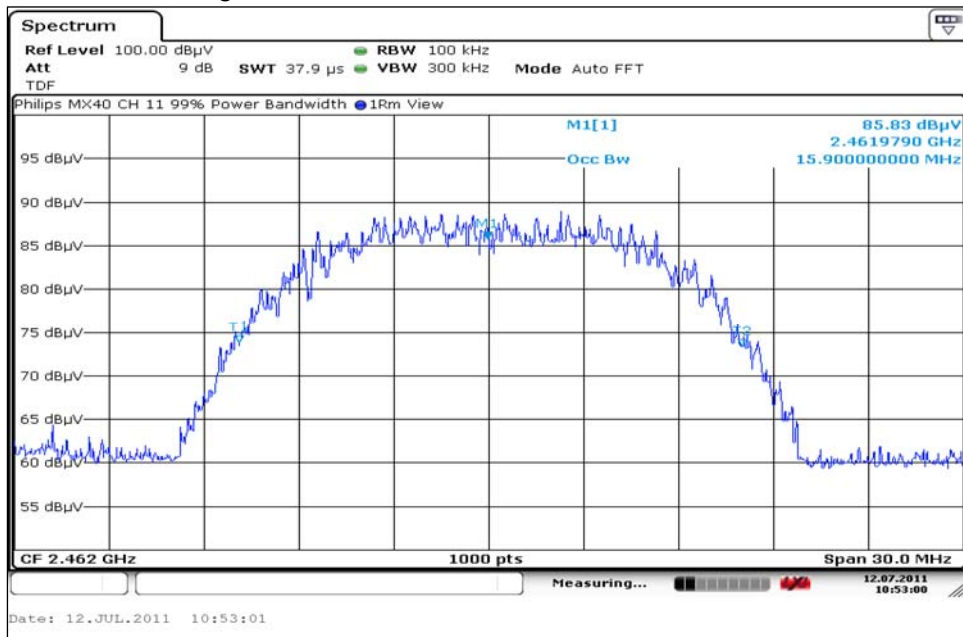

7. Measurement Data (continued)

7.3. 99% Bandwidth (RSS 210)

7.3.2. Measurement Results: 802.11g

Channel	Channel Frequency (MHz)	99% Power Bandwidth (MHz)
Low	2412	16.380
Middle	2437	16.410
High	2462	16.350

7.3.2.1. 802.11g, Low Channel – 1

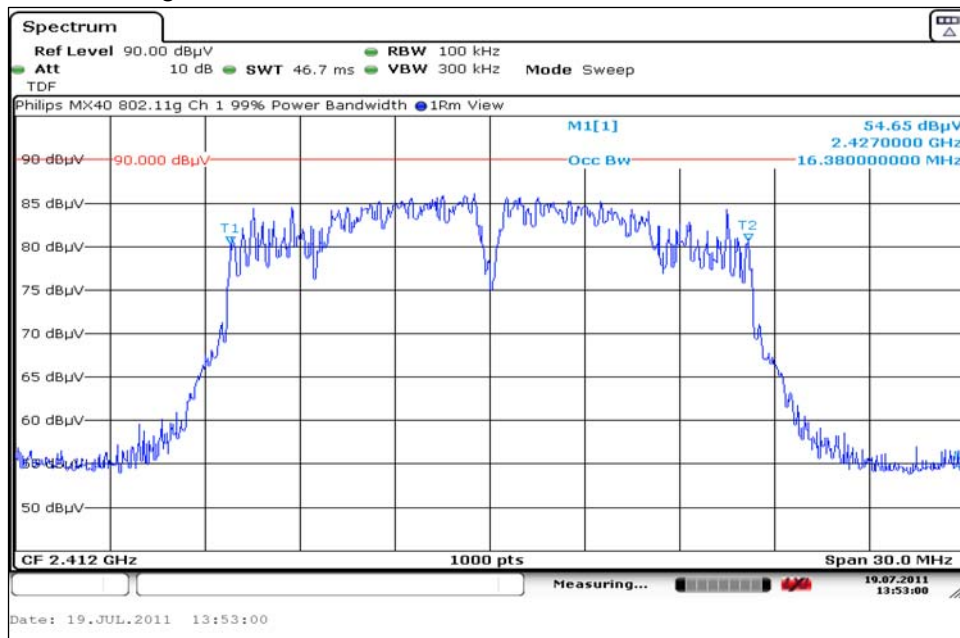

7. Measurement Data (continued)

7.3. 99% Bandwidth (RSS 210) (continued)

7.3.2.2. 802.11g, Middle Channel – 6

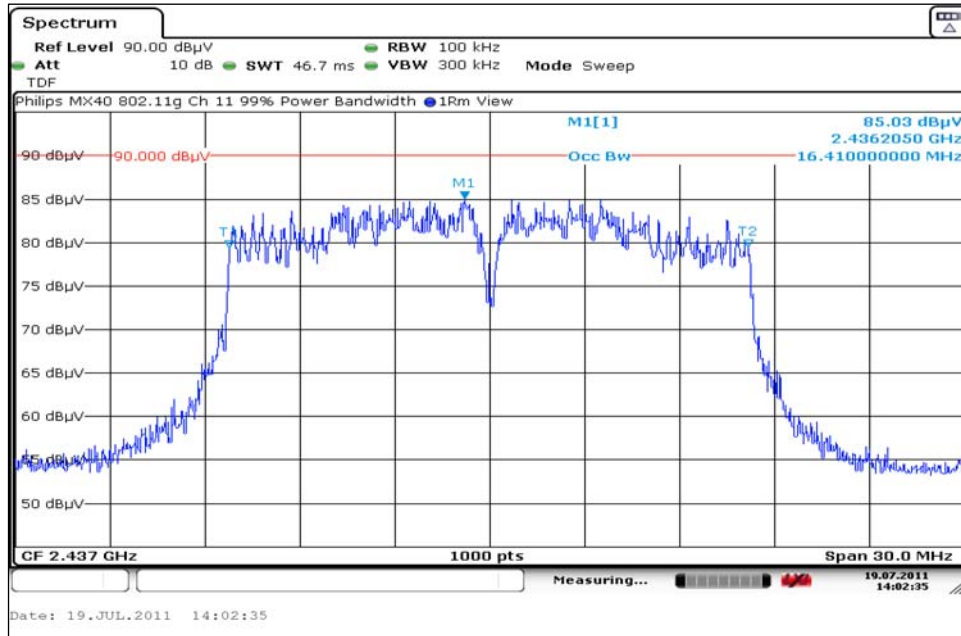

7.3.2.3. 802.11g, High Channel - 26

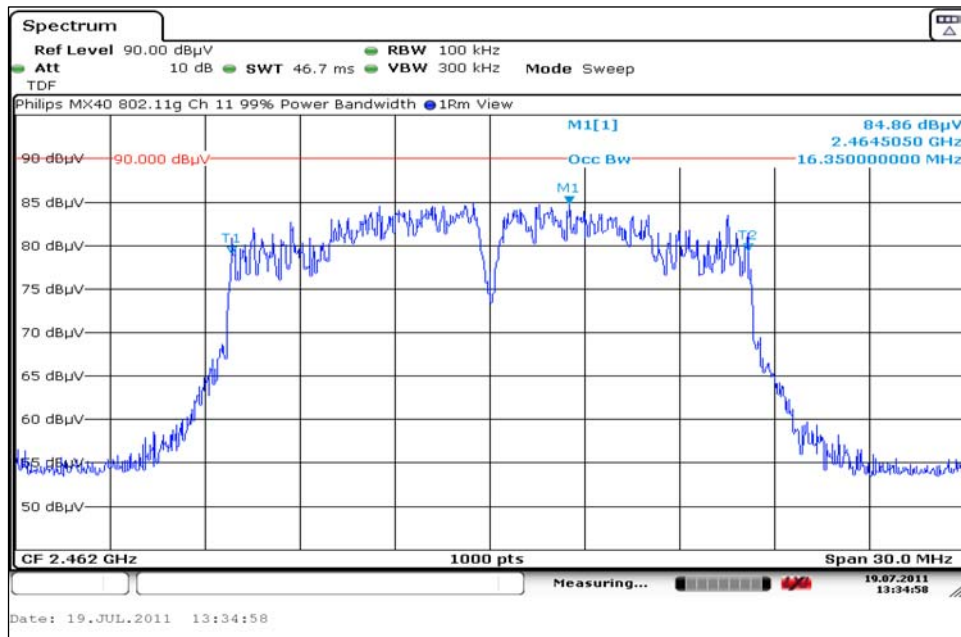

7. Measurement Data (continued)

7.4. Maximum Peak Conducted Output Power (15.247 (b)1(1))

Requirement: The maximum peak conducted output power of the intentional radiator shall not exceed the following: For systems using digital modulation in the 902–928 MHz, 2400–2483.5 MHz, and 5725–5850 MHz bands: 1 Watt.

Test Notes: The MX40 Short Range Radio Antenna is not removable; therefore the output power was determined from the measured field strength using the following equation:

$$P = \frac{(E \times d)^2}{(30 \times G)}$$

- P = the power in Watts (power has been converted to milliwatts in the table).
- E = the measured maximum field in V/m.
- G = the numeric gain of the transmitting antenna over an isotropic radiator.
- d = the distance in meters of the field strength measurement.

Resolution Bandwidth : 1 MHz

Video Bandwidth : 3 MHz

7.4.1. Measurement Results: 802.11b

Channel	Frequency	Peak Field Strength	Distance	Antenna Gain ¹	Output Power	Output Power Limit	Result
	(MHz)	(dBµV/m)	(m)	(dBi)	(mW)	(mW)	
Low	2405	96.87	3.0	1.0	1.16	1000	Compliant
Middle	2440	97.17	3.0	1.0	1.24	1000	Compliant
High	2480	96.71	3.0	1.0	1.12	1000	Compliant

¹ Taken from the antenna manufacturer's data guide.

Integrated power over the 26 dB BW of the Signal

Channel	Frequency	Integrated Band Power	Peak Field Strength	Distance	Antenna Gain ¹		Measured Output Power	Output Power Limit	Result
	(MHz)	dBm	(dBµV/m)	(m)	(dBi)	(numeric)	(mW)	(mW)	
Low	2412	1.60	108.60	3.0	1.0	1.259	17.26	1000	Compliant
Middle	2437	1.60	108.60	3.0	1.0	1.259	17.26	1000	Compliant
High	2462	1.28	108.28	3.0	1.0	1.259	16.04	1000	Compliant

¹ Taken from the antenna manufacturer's data guide.

7. Measurement Data (continued)

7.4. Maximum Peak Conducted Output Power (15.247 (b) (1)) (continued)

7.4.1.1. 802.11b, Low Channel - 1

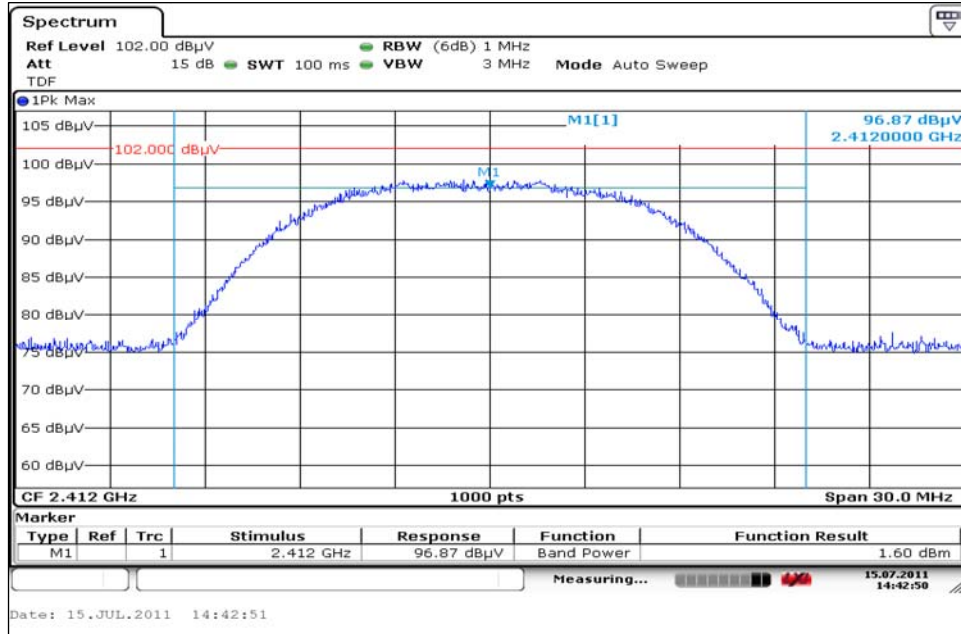

7.4.1.2. 802.11b, Middle Channel - 6

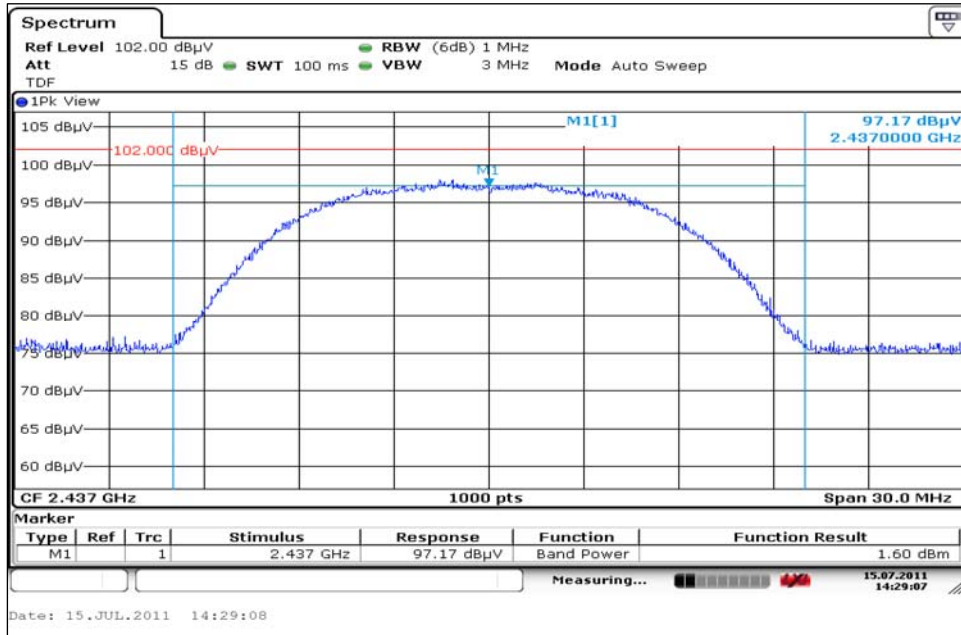

7. Measurement Data (continued)

7.4. Maximum Peak Conducted Output Power (15.247 (b) (1)) (continued)

7.4.1.3. 802.11b, High Channel – 11

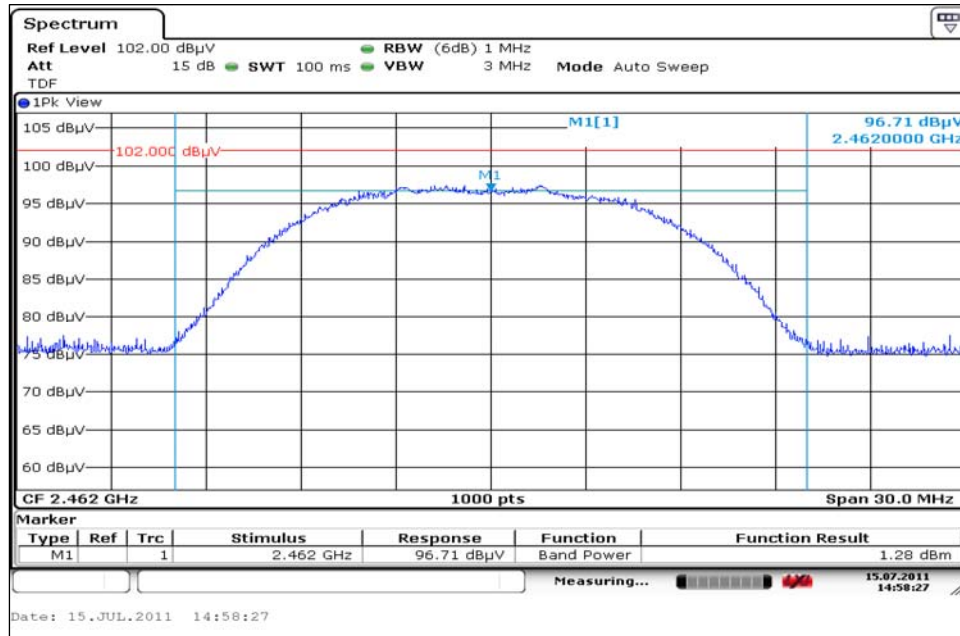

7.4.2. Measurement Results: 802.11g

Channel	Frequency (MHz)	Peak Field Strength (dBµV/m)	Distance (m)	Antenna Gain ¹ (dBi)	Output Power (mW)	Output Power Limit (mW)	Result
Low	2405	95.36	3.0	1.0	0.82	1000	Compliant
Middle	2440	95.03	3.0	1.0	0.76	1000	Compliant
High	2480	95.03	3.0	1.0	0.76	1000	Compliant

¹ Taken from the antenna manufacturer's data guide.

Integrated power over the 26 dB BW of the Signal

Channel	Frequency	Integrated Band Power	Peak Field Strength	Distance	Antenna Gain ¹		Measured Output Power	Output Power Limit	Result
	(MHz)	dBm	(dBµV/m)		(dBi)	(numeric)			
Low	2412	2.30	109.30	3.0	1.0	1.259	20.28	1000	Compliant
Middle	2437	2.38	109.38	3.0	1.0	1.259	20.66	1000	Compliant
High	2462	2.87	109.87	3.0	1.0	1.259	23.13	1000	Compliant

¹ Taken from the antenna manufacturer's data guide.

7. Measurement Data (continued)

7.4. Maximum Peak Conducted Output Power (15.247 (b) (1)) (continued)

7.4.2.1. 802.11g, Low Channel - 1

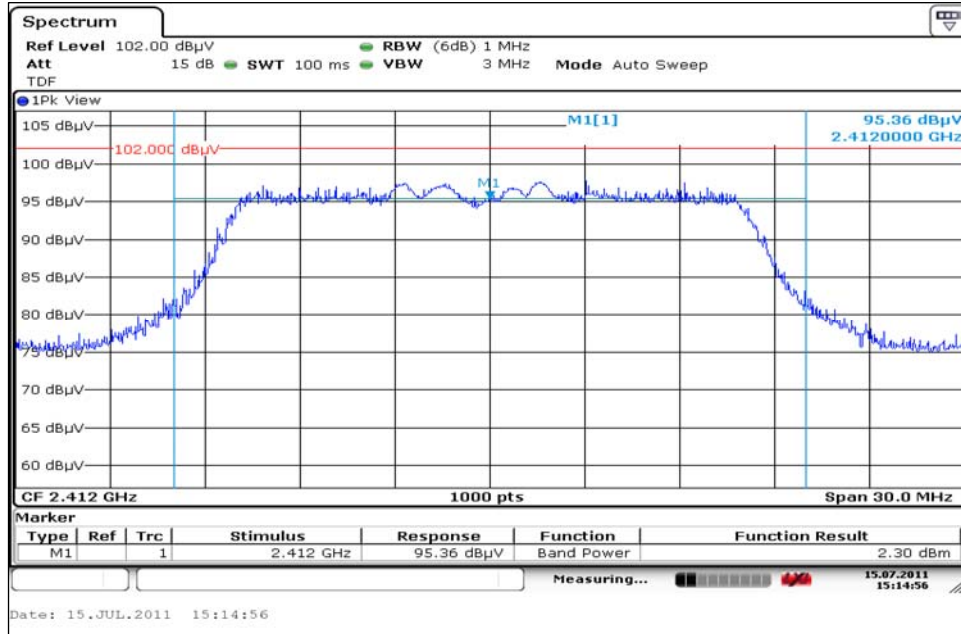

7.4.2.2. 802.11g, Middle Channel - 6

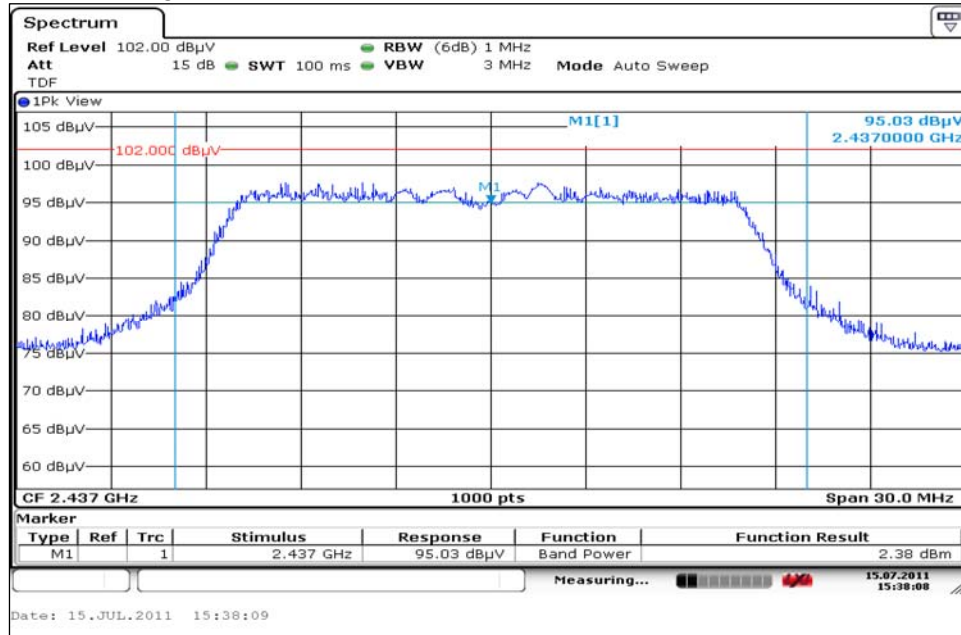

7. Measurement Data (continued)

7.4. Maximum Peak Conducted Output Power (15.247 (b) (1)) (continued)

7.4.2.3. 802.11g, High Channel - 11

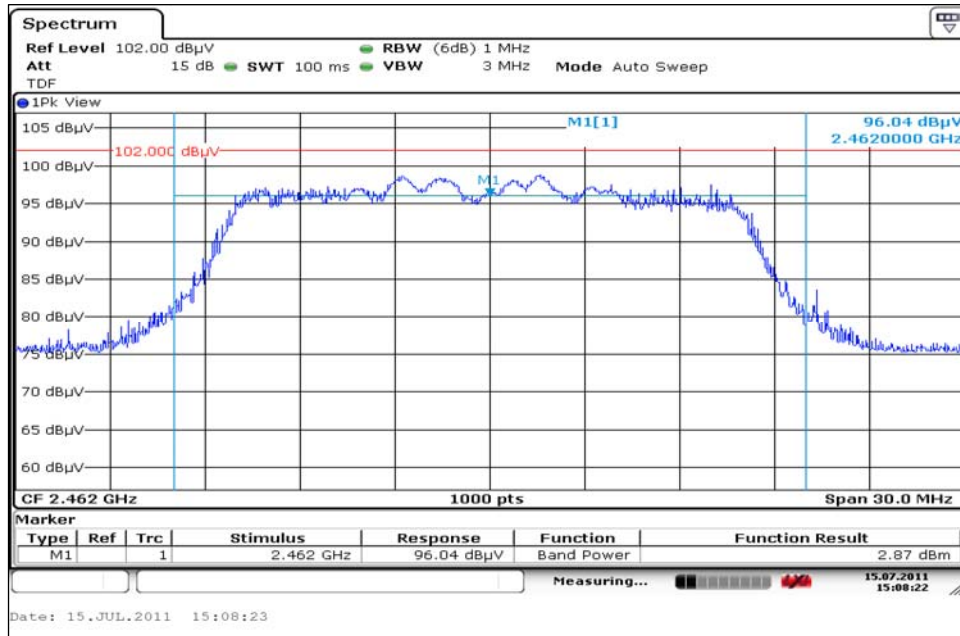

7. Measurement Data (continued)

7.5. Operation with directional antenna gains greater than 6 dBi (15.247 (b)(4))

Requirement: If transmitting antennas of directional gain greater than 6 dBi are used, the conducted output power from the intentional radiator shall be reduced below the stated values in paragraphs (b)(1), (b)(2), and (b)(3) of FCC Part 15.247, as appropriate, by the amount in dB that the directional gain of the antenna exceeds 6 dBi.

DUT Status: **The MX40 2.4 GHz WLAN Radio utilizes an antenna with 1 dBi peak antenna gain values and therefore is not affected by this clause.**

7.6. Transmitter Spurious Radiated Emissions (30 MHz to 40 GHz)

7.6.1. Regulatory Limit: FCC, Part 209, Quasi-Peak

Frequency Range (MHz)	Distance (Meters)	Limit (dBµV/m)
30 to 88	3	40.0
88 to 216	3	43.5
216 to 960	3	46.0
>960	3	54.0

7.6.2. Measurement & Equipment Setup

Test Date: 7/14/2011
 Test Engineer: Brian Breault
 Site Temperature (°C): 21.3
 Relative Humidity (%RH): 31
 Frequency Range: 30 MHz to 40 GHz
 Measurement Distance: 3 Meters
 EMI Receiver IF Bandwidth: 120 kHz (30 MHz – 1 GHz)
 1 MHz (>1GHz)
 EMI Receiver Avg Bandwidth: 300 kHz (30 MHz – 1 GHz)
 3 MHz (>1GHz)
 Detector Functions: Peak, Quasi-Peak, Average
 Antenna Height: 1 to 4 meters

7.6.3. Test Procedure

Test measurements were made in accordance with ANSI C63.4-2003, Standard Methods of Measurement of Radio Noise Emissions from Low-Voltage Electrical and Electronics Equipment in the Range of 9 kHz to 40 GHz.

7. Measurement Data (continued)

7.6. Transmitter Spurious Radiated Emissions (30 MHz to 40 GHz)

7.6.4. Spurious Radiated Emissions (30 MHz – 1 GHz) Test Results

7.6.4.1. Measurement Results – Horizontal Polarity

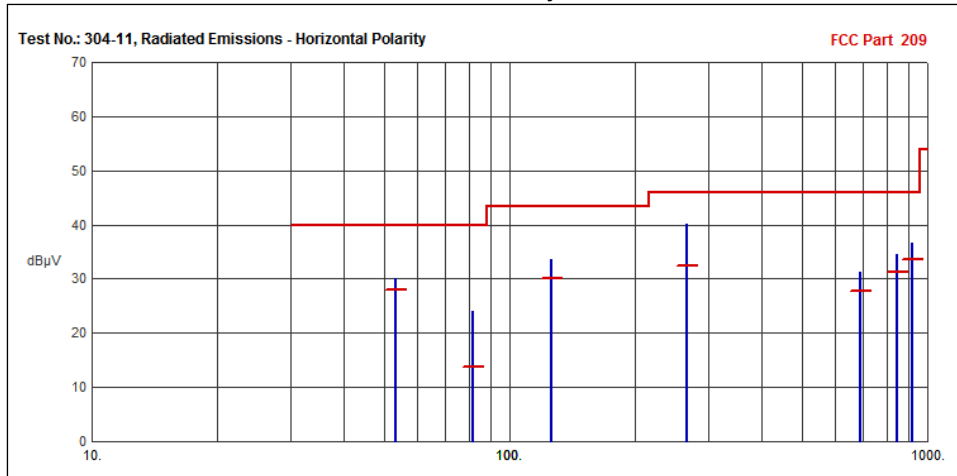

Frequency (MHz)	Pk Amp (dBµV/m)	QP Amp (dBµV/m)	QP Limit (dBµV/m)	Margin (dB)	Comments
53.4284	29.99	28.02	40.00	-11.98	Compliant
81.5222	24.04	13.73	40.00	-26.27	Compliant
126.1769	33.58	30.06	43.50	-13.44	Compliant
265.9254	40.22	32.45	46.00	-13.55	Compliant
691.2044	31.28	27.75	46.00	-18.25	Compliant
844.7939	34.63	31.21	46.00	-14.79	Compliant
921.5983	36.69	33.70	46.00	-12.30	Compliant

7.6.4.2. Measurement Results – Vertical Polarity

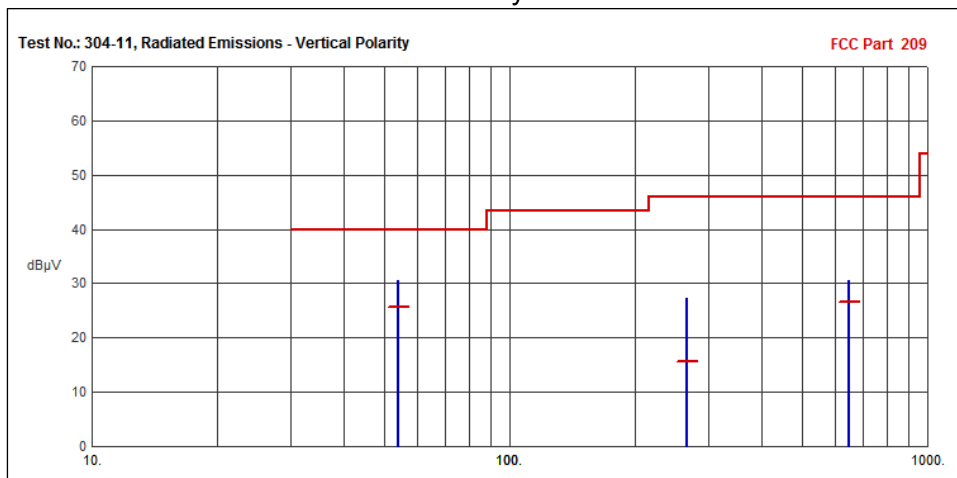

Frequency (MHz)	Pk Amp (dBµV/m)	QP Amp (dBµV/m)	QP Limit (dBµV/m)	Margin (dB)	Comments
54.1047	30.64	25.76	40.00	-14.24	Compliant
265.9592	27.40	15.65	46.00	-30.35	Compliant
647.9681	30.48	26.69	46.00	-19.31	Compliant

7. Measurement Data (continued)

7.6. Transmitter Spurious Radiated Emissions (30 MHz to 40 GHz)

7.6.5. Spurious Radiated Emissions (Above 1 GHz) Test Results

There were measurable no transmitter spurious emissions other than the emissions tabled in section 7.6.6.

7.6.6. Transmitter Spurious Emissions – 802.11b & 802.11g

7.6.6.1. 802.11b, Combined Harmonic Emissions Test Results

Freq. (MHz)	Field Strength (dBµV/m)		Limit (dBµV/m)		Margin (dBµV/m)		Antenna Polarity (H/V)	Result
	Peak	Average	Peak	Average	Peak	Average		
4824.000	54.21	37.25	74.00	54.00	-19.79	-16.75	H	Compliant
4874.000	49.07	35.78	74.00	54.00	-24.93	-18.22	V	Compliant
4924.000	53.90	37.92	74.00	54.00	-20.10	-16.08	H	Compliant
7311.000	47.07	34.14	74.00	54.00	-26.93	-19.86	V	Compliant
7386.000	53.30	40.12	74.00	54.00	-20.70	-13.88	V	Compliant
12060.000	58.62	45.40	74.00	54.00	-15.38	-8.60	H	Compliant
12310.000	48.92	35.19	74.00	54.00	-25.08	-18.81	H	Compliant
14472.000	64.55	51.31	74.00	54.00	-9.45	-2.69	H	Compliant
19296.000	49.54	36.35	74.00	54.00	-24.46	-17.65	H	Compliant
19496.000	58.78	45.48	74.00	54.00	-15.22	-8.52	H	Compliant
19696.000	45.14	43.53	74.00	54.00	-28.86	-10.47	V	Compliant
22158.000	57.17	44.20	74.00	54.00	-16.83	-9.80	H	Compliant

7.6.6.2. 802.11g, Combined Harmonic Emissions Test Results

Freq. (MHz)	Field Strength (dBµV/m)		Limit (dBµV/m)		Margin (dBµV/m)		Antenna Polarity (H/V)	Result
	Peak	Average	Peak	Average	Peak	Average		
4824.000	55.14	36.45	74.00	54.00	-18.86	-17.55	H	Compliant
4874.000	49.90	35.88	74.00	54.00	-24.10	-18.12	V	Compliant
4924.000	53.65	36.78	74.00	54.00	-20.35	-17.22	H	Compliant
7236.000	0.00	0.00	74.00	54.00	-74.00	-54.00	H	Compliant
7311.000	52.93	39.24	74.00	54.00	-21.07	-14.76	V	Compliant
12060.000	58.21	45.33	74.00	54.00	-15.79	-8.67	H	Compliant
14472.000	64.12	51.45	74.00	54.00	-9.88	-2.55	H	Compliant
19296.000	48.29	35.80	74.00	54.00	-25.71	-18.20	H	Compliant
19496.000	50.72	38.68	74.00	54.00	-23.28	-15.32	H	Compliant
19696.000	47.88	35.29	74.00	54.00	-26.12	-18.71	V	Compliant
22158.000	56.52	44.23	74.00	54.00	-17.48	-9.77	H	Compliant
24620.000	0.00	0.00	74.00	54.00	-74.00	-54.00	V	Compliant

7. Measurement Data (continued)

7.7. Receiver Spurious Emissions (RSS 213 6.8, RSS-Gen 4.10 & 7.2.3.1)

Requirement: RSS 213 6.8 - Receiver spurious emissions shall comply with the limits specified in RSS-Gen.

RSS-Gen 4.10 – Radiated emission measurements are to be performed using a calibrated open-area test site. As an alternative, the conducted measurement method may be used when the antenna is detachable. In such a case, the receiver spurious signal may be measured at the antenna port. The limits for this measurement were taken from section 6.1:

Freq. (MHz)	Field Strength	
	(μ V/m)	(dB μ V/m)
30-88	100	40
88-216	150	44
216-960	200	46
Above 960	500	54

7.7.1. Receiver Spurious Emissions below 1 GHz, Horizontal

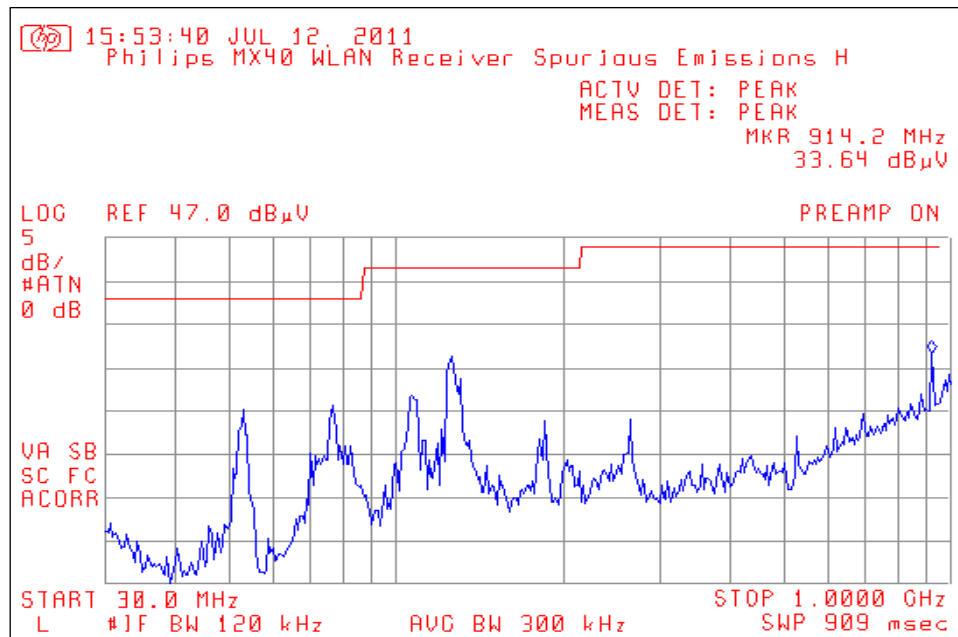

7. Measurement Data (continued)

7.7. Receiver Spurious Emissions (RSS 213 6.8, RSS-Gen 4.10 & 7.2.3.1) (continued)

7.7.2. Receiver Spurious Emissions above 1 GHz, Horizontal

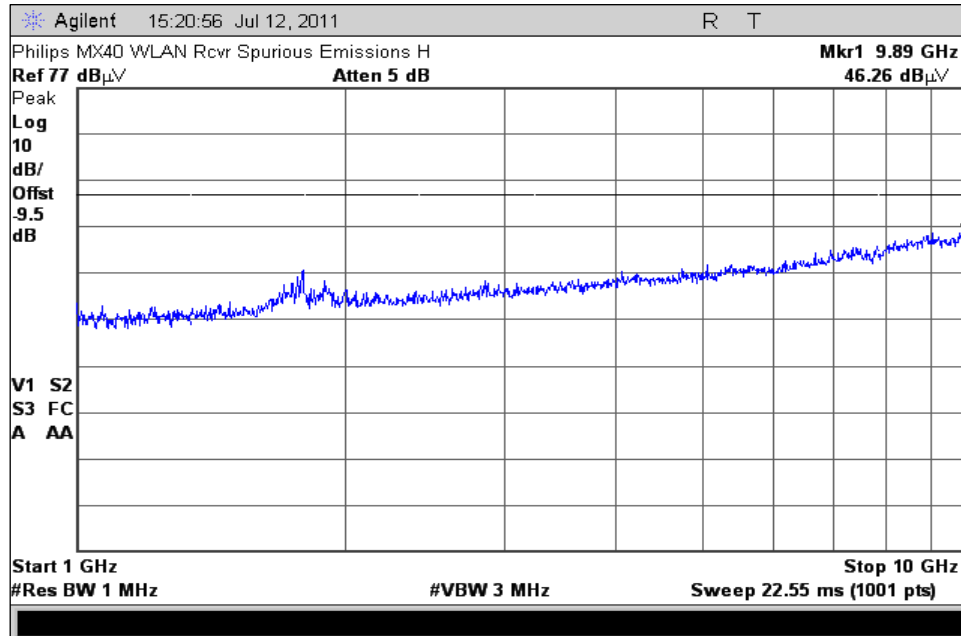

7.7.3. Receiver Spurious Emissions below 1 GHz, Vertical

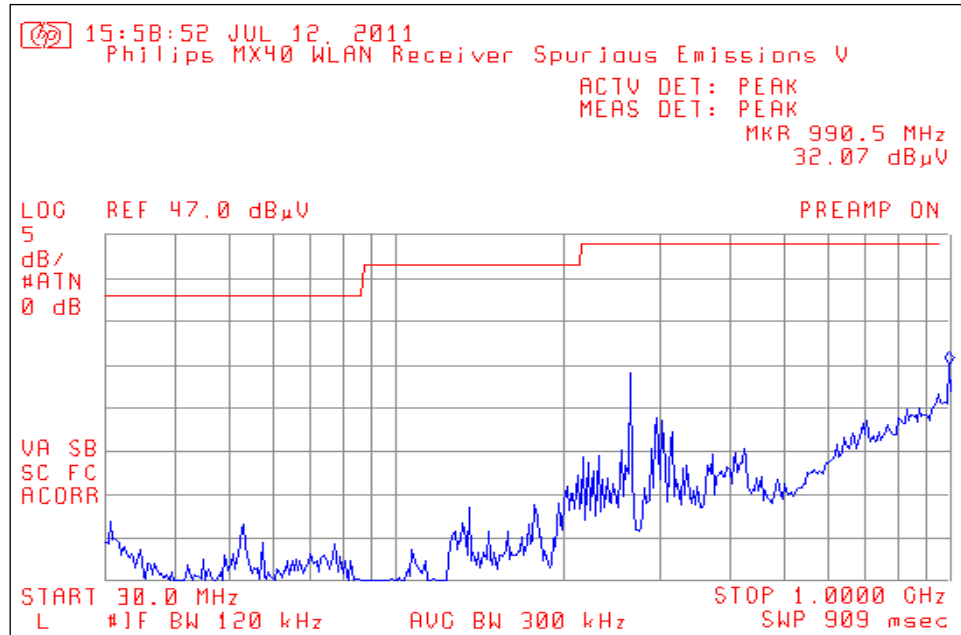

7. Measurement Data (continued)

7.7. Receiver Spurious Emissions (RSS 213 6.8, RSS-Gen 4.10 & 7.2.3.1) (continued)

7.7.4. Receiver Spurious Emissions above 1 GHz, Vertical

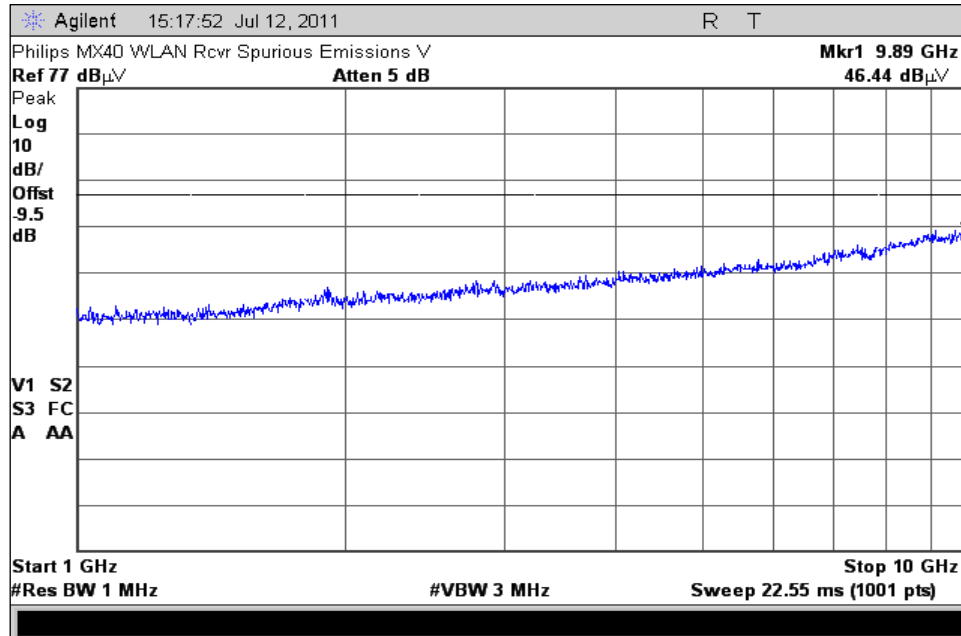

7. Measurement Data (continued)

7.8. Band Edge Measurements

Requirement: In any 100 kHz bandwidth outside the frequency band in which the spread spectrum or digitally modulated intentional radiator is operating, the radio frequency power that is produced by the intentional radiator shall be at least 20 dB below that in the 100 kHz bandwidth within the band that contains the highest level of the desired power, based on either an RF conducted or a radiated measurement, provided the transmitter demonstrates compliance with the peak conducted power limits. If the transmitter complies with the conducted power limits based on the use of RMS averaging over a time interval, as permitted under paragraph (b)(3) of this section, the attenuation required under this paragraph shall be 30 dB instead of 20 dB. Attenuation below the general limits specified in Section 15.209(a) is not required. In addition, radiated emissions which fall in the restricted bands, as defined in Section 15.205(a), must also comply with the radiated emission limits specified in Section 15.209(a) (see Section 15.205(c)).

7.8.1. Lower Band Edge: 802.11b

Lowest Channel (MHz)	Field Strength (dB μ V/m)		Band Edge Frequency (MHz)	Field Strength (dB μ V/m)		Limit	Margin (dB)	Result
	Peak	Average		Peak	Average			
2405	95.79	---	2400	56.37	---	>20 dB	-39.42	Compliant

7.8.1.1. Lower Band Edge: 802.11b

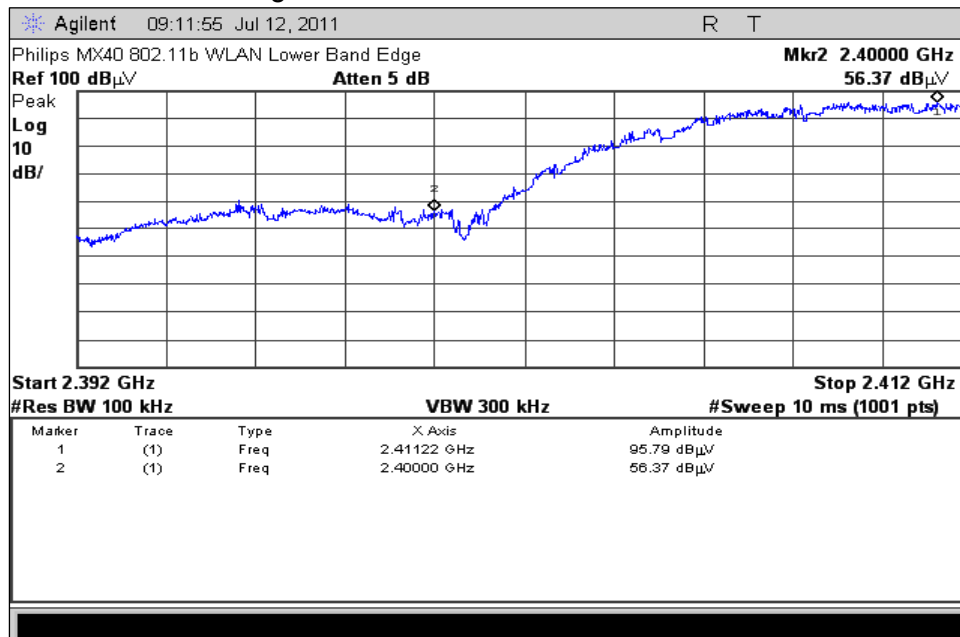

7. Measurement Data (continued)

7.8. Band Edge Measurements (continued)

7.8.2. Upper Band Edge: 802.11b vs 15.209 Limit

	Freq. (MHz)	Field Strength (dBµV/m)		Limit (dBµV/m)		Margin (dBµV/m)		Result
		Peak	Average	Peak	Average	Peak	Average	
Band Edge	2483.500	44.88	27.78	74	54	-29.12	-26.22	Compliant
Worst Case Out of Band	2488.025	48.64	29.59	74	54	-25.36	-24.41	Compliant

7.8.2.1. Upper Band Edge: 802.11b

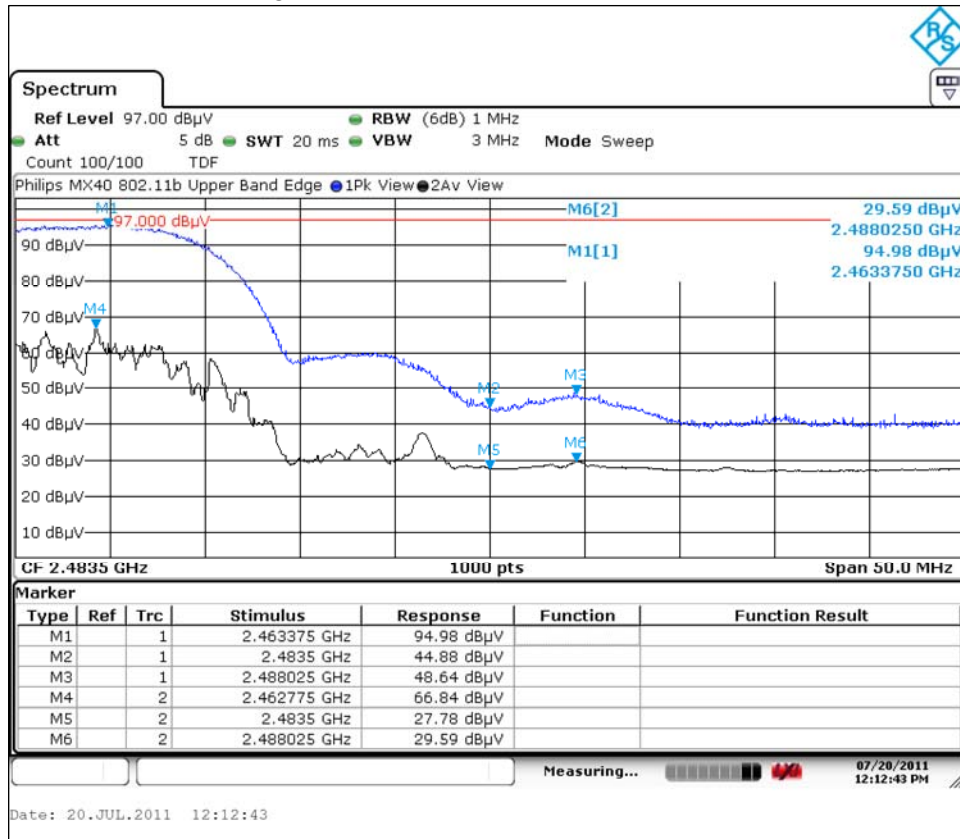

7. Measurement Data (continued)

7.8. Band Edge Measurements (continued)

7.8.3. Lower Band Edge: 802.11g

Lowest Channel (MHz)	Field Strength (dBμV/m)		Band Edge Frequency (MHz)	Field Strength (dBμV/m)		Limit	Margin (dB)	Result
	Peak	Average		Peak	Average			
2405	91.98	---	2400	61.48	---	>20 dB	-30.50	Compliant

7.8.3.1. Lower Band Edge: 802.11g

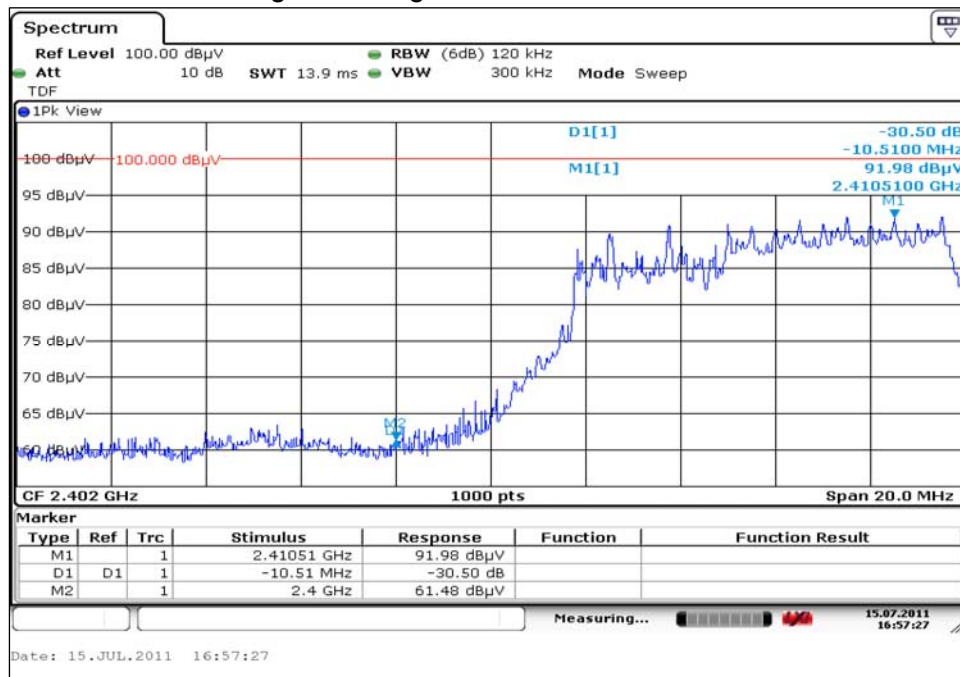

7. Measurement Data (continued)

7.8. Band Edge Measurements (continued)

7.8.2. Upper Band Edge: 802.11g vs 15.209 Limit.

	Freq. (MHz)	Field Strength (dBµV/m)		Limit (dBµV/m)		Margin (dBµV/m)		Result
		Peak	Average	Peak	Average	Peak	Average	
Band Edge	2483.500	51.99	28.02	74	54	-22.01	-25.98	Compliant
Worst Case Out of Band	2488.325	50.18	28.51	74	54	-23.82	-25.49	Compliant

7.8.2.1. Upper Band Edge: 802.11g

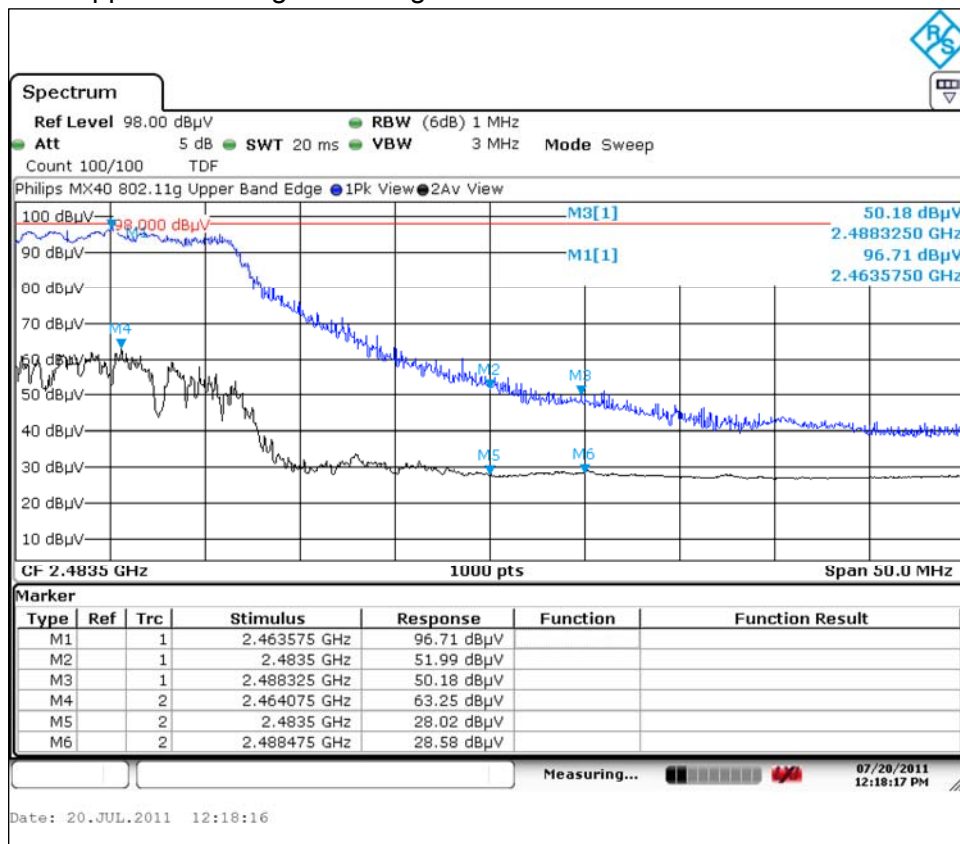

7. Measurement Data

7.8. Band Edge (15.247 (d), RSS-210 A8.5)

7.8.3. Lower Restricted Band (2310 MHz to 2390 MHz)

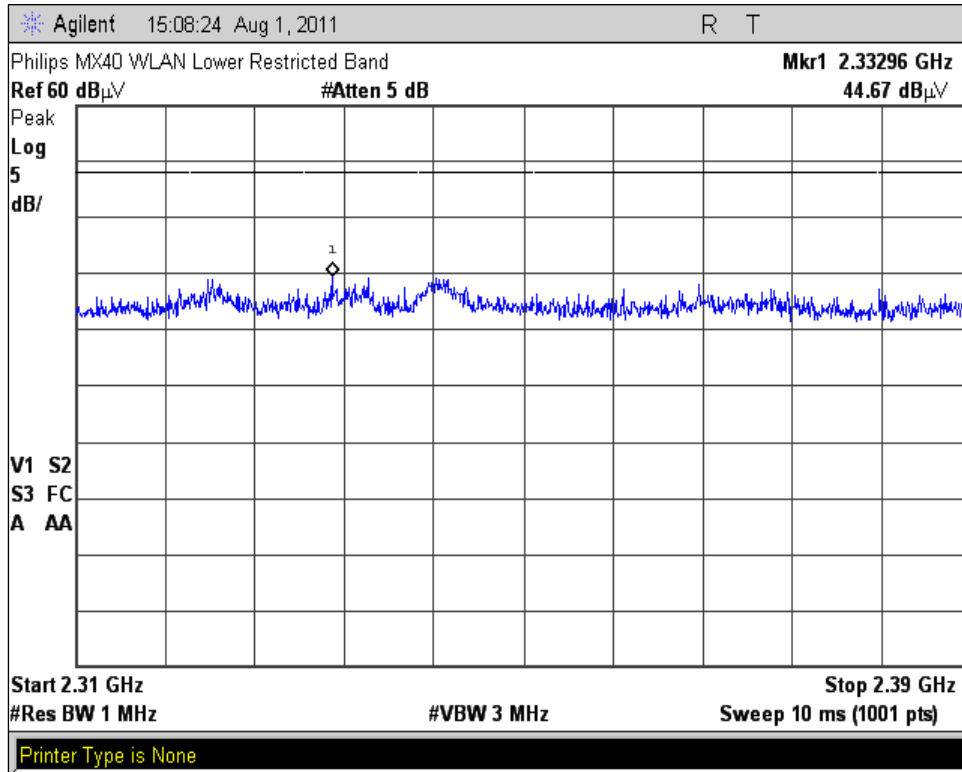

7. Measurement Data (continued)

7.9. Power Spectral Density (15.247(e))

Requirement: For digitally modulated systems, the power spectral density conducted from the intentional radiator to the antenna shall not be greater than 8 dBm in any 3 kHz band during any time interval of continuous transmission. This power spectral density shall be determined in accordance with the provisions of paragraph (b) of this section. The same method of determining the conducted output power shall be used to determine the power spectral density.

Test Note: Reference the equation used in Section 6.4 for determining the power spectral density (dBm) from the radiated field strength value.

7.9.1. Power Spectral Density: 802.11b

Channel	Channel Frequency (GHz)	Measured Frequency (GHz)	PSD Value Radiated (dBμV/m)	Power Spectral Density (dBm)	Limit (dBm)	Result
Low	2412	2.4100155	76.42	-19.809	8	Compliant
Middle	2437	2.4394750	77.94	-18.289	8	Compliant
High	2462	2.4612575	73.09	-23.139	8	Compliant

7.9.1.1. 802.11b, Low Channel - 1

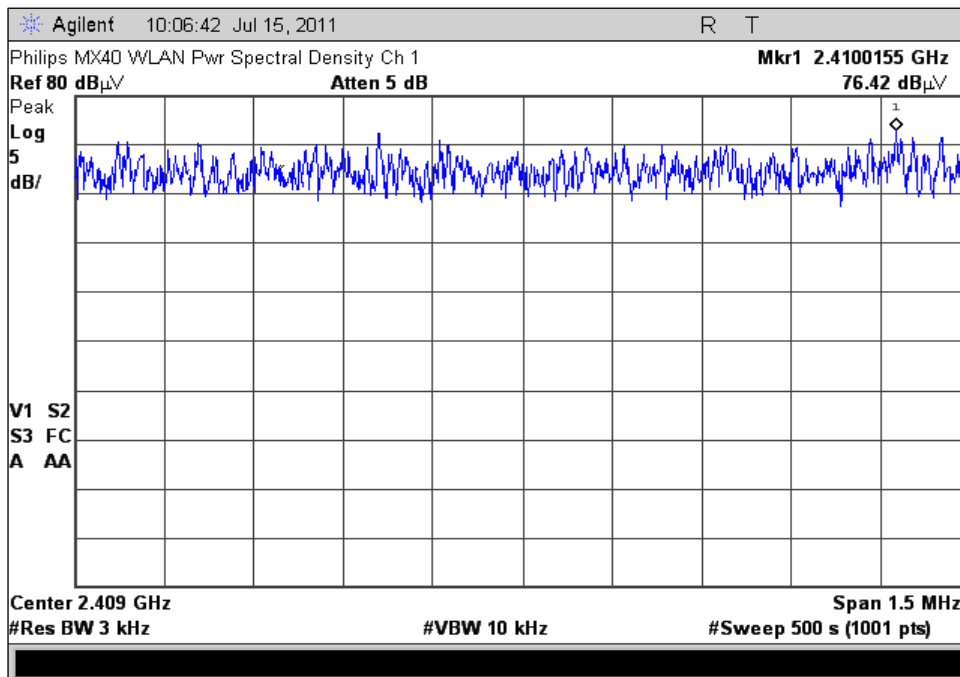

7. Measurement Data (continued)

7.9. Power Spectral Density (15.247(e))

7.9.1.2. 802.11b, Middle Channel - 6

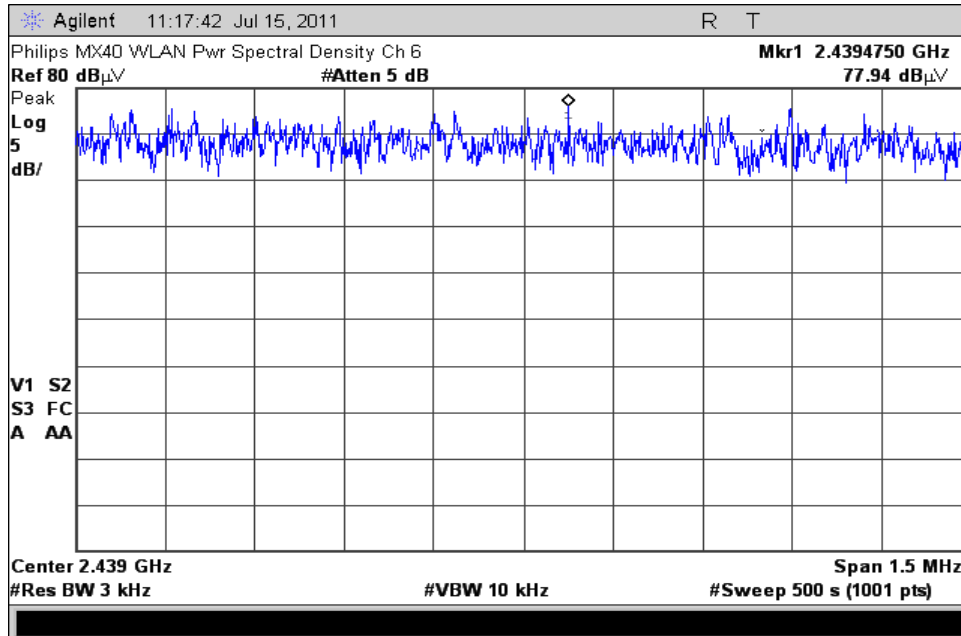

7.9.1.3. 802.11b, High Channel - 11

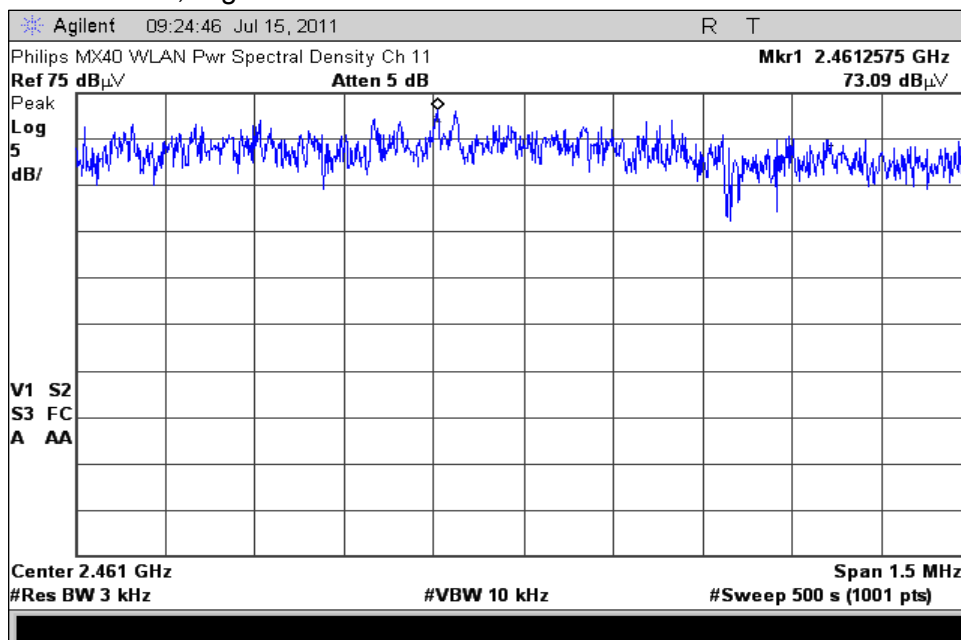

7. Measurement Data (continued)

7.9. Power Spectral Density (15.247(e))

7.9.2. Power Spectral Density: 802.11g

Channel	Channel Frequency (GHz)	Measured Frequency (GHz)	PSD Value Radiated (dBμV/m)	Power Spectral Density (dBm)	Limit (dBm)	Result
Low	2412	2.4045263	72.36	-23.869	8	Compliant
Middle	2437	2.4324603	73.93	-22.299	8	Compliant
High	2462	2.4637158	74.74	-21.489	8	Compliant

7.9.2.1. 802.11g, Low Channel - 1

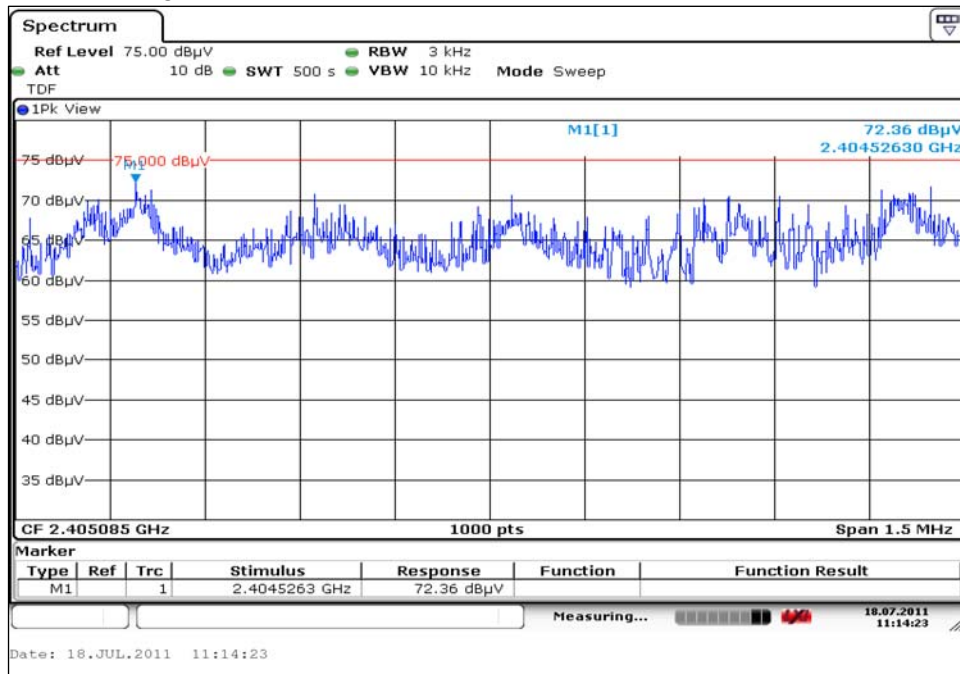

7. Measurement Data (continued)

7.9. Power Spectral Density (15.247(e))

7.9.2.2. 802.11g, Middle Channel - 6

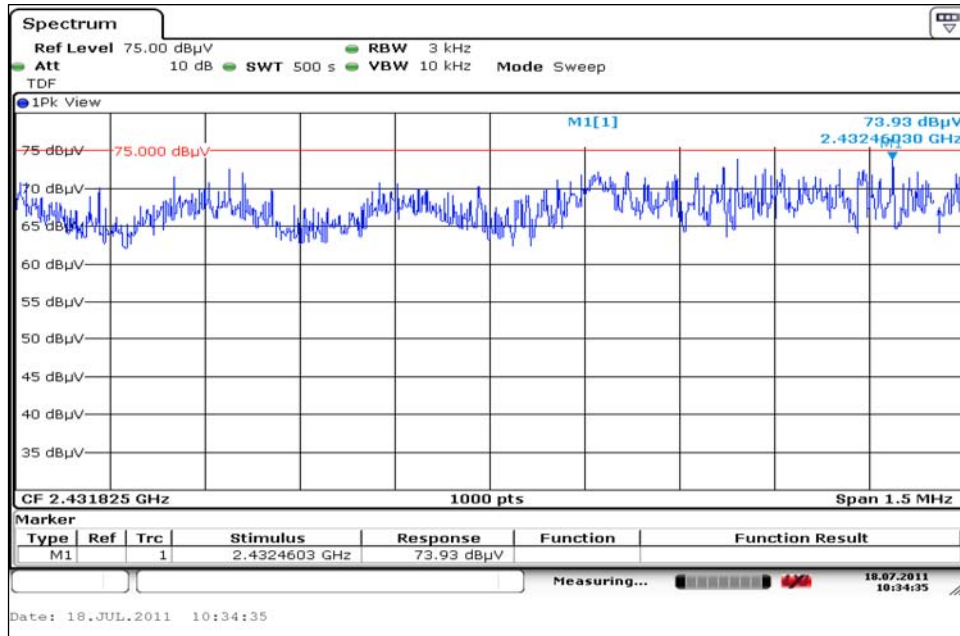

7.9.2.3. 802.11g, High Channel - 11

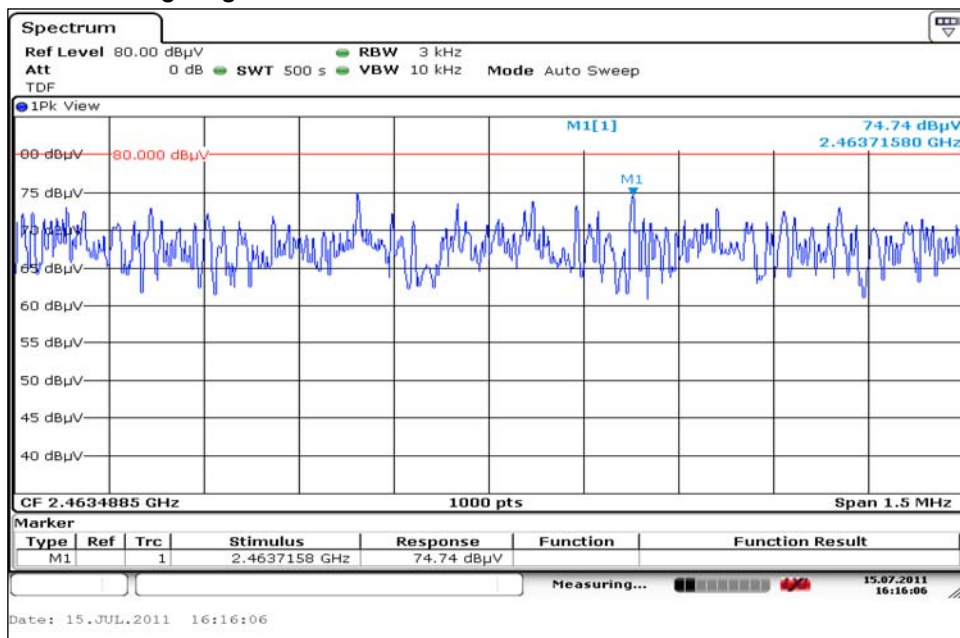

7. Measurement Data (continued)

7.10. Public Exposure to Radio Frequency Energy Levels (15.247(i) (1.1307 (b)(1))
RSS-GEN 5.5, RSS 102

Channel Frequency	MPE Distance (cm)	DUT Output Power (dBm)	DUT Antenna Gain (dBi)	Power Density		Limit (mW/cm ²)	Result
				(mW/cm ²)	(W/m ²)		
				(4)			
2412	2.5	0.64	1.0	0.01858	0.18579	1	Compliant
2437	2.5	0.94	1.0	0.01991	0.19908	1	Compliant
2462	2.5	0.48	1.0	0.01791	0.17907	1	Compliant
2412	2.5	12.37	1.0	0.27671	2.76714	1	Compliant
2437	2.5	12.37	1.0	0.27671	2.76714	1	Compliant
2462	2.5	12.05	1.0	0.25706	2.57058	1	Compliant
2412	2.5	-0.87	1.0	0.01312	0.13123	1	Compliant
2437	2.5	-1.20	1.0	0.01216	0.12163	1	Compliant
2462	2.5	-1.20	1.0	0.01216	0.12163	1	Compliant
2412	2.5	13.07	1.0	0.32511	3.25111	1	Compliant
2437	2.5	13.15	1.0	0.33116	3.31155	1	Compliant
2462	2.5	13.64	1.0	0.37071	3.70708	1	Compliant

Note: 802.11b and 802.11g analyzed with both energy in a 1 MHz RBW and integrated 26 dB BW power.

$$PD = \frac{OP + AG}{(4 \times \pi \times d^2)}$$

- PD = Power Density (mW/cm²)
- OP = DUT Output Power (dBm)
- AG = DUT Antenna Gain (dBi)
- d = MPE Distance (cm)

1. Reference CFR 2.1093(b): For purposes of this section, a portable device is defined as a transmitting device designed to be used so that the radiating structure(s) of the device is/are within 2.5 centimeters of the body of the user.
2. Section 7.4 of this test report.
3. Data supplied by the client. Antenna specification data of worst case antenna used by the DUT.
4. Power density is calculated from field strength measurement and antenna gain.
5. Reference CFR 1.1310, Table 1: Limits for Maximum Permissible Exposure (MPE), Section (B): Limits for General Population/Uncontrolled Exposure.

7. Measurement Data (continued)

**7.10. Public Exposure to Radio Frequency Energy Levels (15.247(i) (1.1307 (b)(1))
RSS-GEN 5.5, RSS 102 (cont.)**

The calculated output power can be referenced in column 6 of the table below. The calculated peak output power is lower than the 24.37 mW requirement for performing SAR testing using the formula: $60 / F$ (GHz).

Channel	Frequency	Peak Field Strength	Distance	Antenna Gain ¹	Measured Output Power	Time Averaged Power
	(MHz)	(dB μ V/m)	(m)	(dBi)	(mW)	(mW)
Low	2412.0	96.87	3.0	1.0	1.16	0.0000059
Mid	2437.0	97.17	3.0	1.0	1.24	0.0000063
High	2462.0	96.71	3.0	1.0	1.12	0.0000057
Low	2412.0	108.60	3.0	1.0	17.26	0.0000873
Mid	2437.0	108.60	3.0	1.0	17.26	0.0000873
High	2462.0	108.28	3.0	1.0	16.04	0.0000811
Low	2412.0	95.36	3.0	1.0	0.82	0.0000041
Mid	2437.0	95.03	3.0	1.0	0.76	0.0000038
High	2462.0	95.03	3.0	1.0	0.76	0.0000038
Low	2412.0	109.30	3.0	1.0	20.28	0.0001026
Mid	2437.0	109.38	3.0	1.0	20.66	0.0001045
High	2462.0	109.87	3.0	1.0	23.13	0.0001170

¹ Taken from the antenna manufacturer's data guide.

RSS-102 Section 2.5, 2.5.1 & 2.5.2 Requirements:

- 2.5 - All transmitters are exempt from routine SAR and RF exposure evaluations provided that output power complies with the power levels of sections 2.5.1 or 2.5.2. If the equipment under test (EUT) meets the requirements of sections 2.5.1 or 2.5.2, applicants are only required to submit a properly signed declaration of compliance (see Annex C).
- 2.5.1 - SAR evaluation is required if the separation distance between the user and the radiating element of the device is less than or equal to 20 cm, except when the device operates as follows:
 - above 2.2 GHz and up to 3 GHz inclusively, and with output power (i.e. the higher of the conducted or radiated (e.i.r.p.) source-based, time-averaged output power) that is less than or equal to 20 mW for general public use and 100 mW for controlled use
- 2.5.2 - RF exposure evaluation is required if the separation distance between the user and the device's radiating element is greater than 20 cm, except when the device operates as follows:
 - at or above 1.5 GHz and the maximum EIRP of the device is equal to or less than 5 W.

7. Measurement Data (continued)

7.10. Public Exposure to Radio Frequency Energy Levels (15.247(i) (1.1307 (b)(1))
RSS-GEN 5.5, RSS 102 (continued)

Time Average Reduction = $20 \log_{10} (.225 \text{ ms} / 100 \text{ ms}) = -52.96 \text{ dB}$.

7.10.1 Determination of time averaged output power – 1 Pulse per 100 ms period.

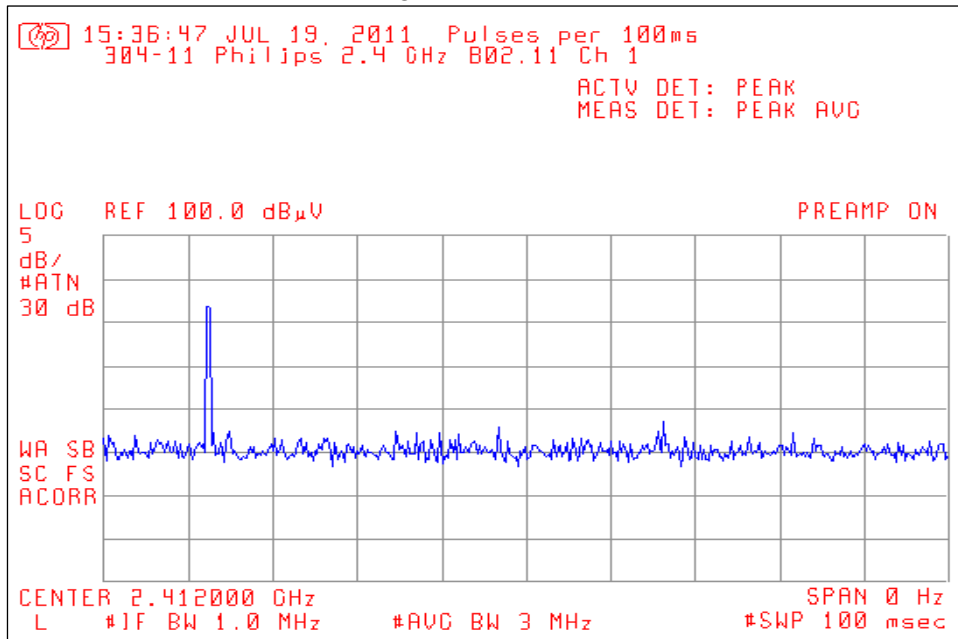

7.10.2 Determination of time averaged output power – Pulse width = 225 µs.

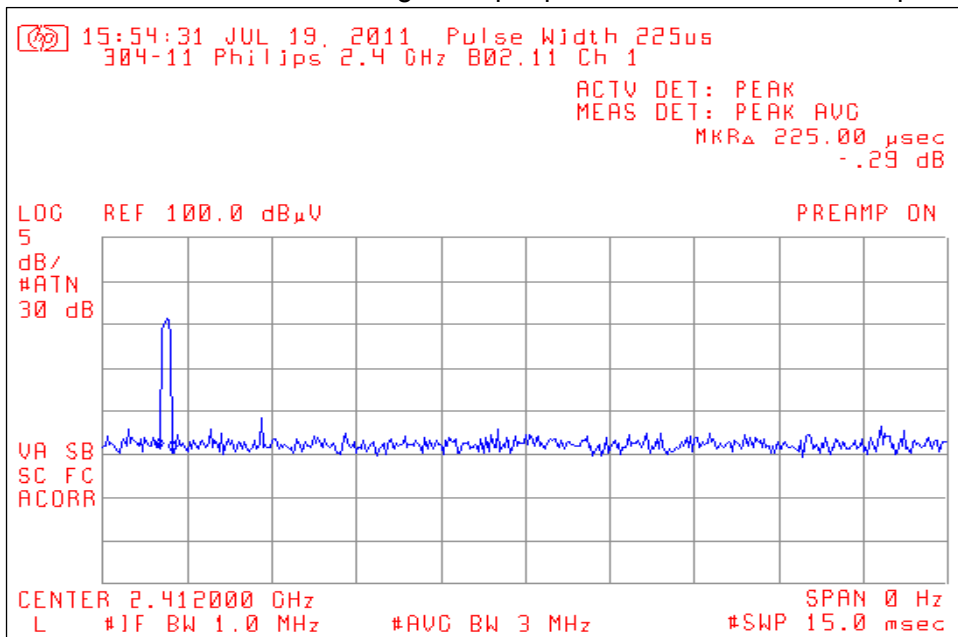

8. Test Setup Photographs

8.1. Radiated Emissions Front:



8. Test Setup Photographs

8.2. Radiated Emissions Rear:



9. Test Site Description

Compliance Worldwide is located at 357 Main Street in Sandown, New Hampshire. The test sites at Compliance Worldwide are used for conducted and radiated emissions testing in accordance with Federal Communications Commission (FCC) and Industry Canada standards. A description of the test sites is on file with the FCC (registration number **96392**) and Industry Canada (file number **IC 3023A-1**).

The radiated emissions test site is a 3 and 10 meter enclosed open area test site (OATS). Personnel, support equipment and test equipment are located in the basement beneath the OATS ground plane.

The conducted emissions site is part of a 16' x 20' x 12' ferrite tile chamber and uses one of the walls for the vertical ground plane required by EN 55022.

Both sites are designed to test products or systems 1.5 meter W x 1.5 meter L x 2.0 meter H, floor standing or table top.