

---

**COMPLIANCE WORLDWIDE INC.  
TEST REPORT 141-12R2**

**In Accordance with the Requirements of  
FCC PART 15.247, SUBPART C  
INDUSTRY CANADA RSS 210, ISSUE 8**

**Low Power License-Exempt Radio Communication Devices  
Intentional Radiators**

**Issued to**

**Philips Medical Systems  
3000 Minuteman Drive  
Andover, MA 01810  
978-659-2800**

**for the**

**Philips Telemetry System  
MX40 Patient Worn Monitor  
WLAN Radio**

**FCC ID: PQC-MX40SH1B4**

**Original Report Issued on April 23, 2012  
Revision R2 Issued on May 8, 2012**

**Tested by**

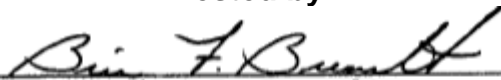
  
\_\_\_\_\_  
Brian F. Breault

**Reviewed by**

  
\_\_\_\_\_  
Larry K. Stillings

This test report shall not be reproduced, except in full, without written permission from Compliance Worldwide, Inc.

## Table of Contents

1. Scope .....	3
2 .Product Details.....	3
2.1 Manufacturer .....	3
2.3 Serial Number.....	3
2.4 Description.....	3
2.5 Power Source .....	3
2.6 EMC Modifications.....	3
3. Product Configuration .....	4
3.1 Operational Characteristics & Software .....	4
3.2 EUT Hardware.....	4
3.3 EUT Hardware/Software/Firmware Revision Level.....	4
3.4 EUT Cables/Transducers .....	4
3.5 Support Equipment.....	4
3.6 Support Equipment Cables/Transducers .....	5
3.7 Miscellaneous.....	5
3.8 Block Diagram .....	5
4. Measurements Parameters .....	6
4.1 Measurement Equipment Used to Perform Test.....	6
4.2 Measurement & Equipment Setup .....	6
4.3 Measurement Procedure.....	6
4.4 Measurement Uncertainty .....	7
5. Choice of Equipment for Test Suits.....	7
5.1 Choice of Model.....	7
5.2 Presentation .....	7
5.3 Choice of Operating Frequencies.....	7
6. Measurement Summary.....	8
7. Measurement Data.....	9
7.1 Antenna Requirement .....	9
7.2 Minimum 6 dB Bandwidth.....	9
7.3 99% Bandwidth.....	11
7.4 Maximum Peak Conducted Output Power .....	14
7.5 Operation with directional antenna gains greater than 6 dBi .....	16
7.6 Transmitter Spurious Radiated Emissions .....	17
7.7 Band Edge Measurements .....	22
7.8 Power Spectral Density .....	25
7.9 Public Exposure to Radio Frequency Energy Levels .....	28
8. Test Setup Photographs .....	31
9. Test Site Description.....	33

## 1. Scope

This test report certifies that the Philips Medical Telemetry System MX40 2.4 GHz Patient Worn Monitor (PWM) 802.11g Radio, as tested, meets the FCC Part 15, Subpart C and Industry Canada RSS 210, Issue 8 requirements. The scope of this test report is limited to the test sample provided by the client, only in as much as that sample represents other production units. If any significant changes are made to the unit, the changes shall be evaluated and a retest may be required. Revision R2 documents the loop antenna used below 30 MHz on Page 6 and removes the receiver spurious data from this report.

## 2. Product Details

**2.1. Manufacturer:** Philips Medical Systems

**2.2. Model Number:** IntelliVue MX40 2.4 GHz (MX40-1B4)

**2.3. Serial Number:** US11400397

**2.4. Description:** The Patient Worn Monitor is a body worn patient monitor for ECG and SpO2 measurements. The device has a touch screen display which can display patient waveforms and/or numeric values locally or transmitted via several possible radio links to the hospital wireless network, a wireless bedside monitor, or to a CTS network for display on the IntelliVue Information Center. The device is capable of transmitting in the 2.4 GHz (ISM bands), 5 GHz (UNII & ISM bands) and/or the WMTS bands, 1395 MHz to 1400 MHz and 1427 MHz to 1432 MHz. The PWM contains an 802.11 a/b/g WLAN radio to communicate with a WLAN, an 802.15.4 SRR radio to communicate with a SRR equipped bedside monitor, or an optional 1.4 GHz or 2.4 GHz CTS radio to communicate with a Philips CTS network. Performance evaluation during immunity testing shall be done on the PWM display, the WLAN display, the IntelliVue Information Center display and the MP5 bedside monitor. The PWM will be configured with a 2.4 GHz 802.11 radio for this test plan.

**2.5. Power Source:** DC 3 volts – Three 1.5 VDC Alkaline AA Batteries (Voltage is regulated)

**2.6. EMC Modifications:** None

## 3. Product Configuration

### 3.1. Operational Characteristics & Software

#### Operating Instructions for Test

Insert the batteries into the PWM battery compartment and allow the device to boot up to display ESC and SpO2 measurement parameters on the local display as well as the ROW and Wi-Fi PIC systems.

The PWM will need to be put into “TELEMETRY” mode during all testing to allow onboard display to be viewed. To do this, with the PWM running, press the middle “SMART KEY” button on the PWM front panel. When the “SMART KEY” menu comes up, press the “Mode: Telemetry” button. The state should change to “Mode: Monitor”.

Next, the WLAN radio needs to be enabled. While in the “SMART KEY” menu screen, press the double down arrow in the lower right of the Touch screen display to display the next menu screen. Now press the “Op Mode” button which will bring up the “Op Mode” selection screen. Now press the “Service” button which will bring up an “Op Mode” window where the password needs to be entered to change mode.

### 3. Product Configuration

#### 3.1. Operational Characteristics & Software (continued)

The password, 4 6 3 0, shall be entered and then press the “Enter” button which will put the device into “Service” mode. then press the “WLAN” button, then press the “WLAN Off” button, which will then change to read “WLAN On”.

Now, the device is ready to be placed back into monitoring mode. To accomplish this, press the “X” in the “Service” screen, then press “X” in the Service screen again, then press “X” in the Service screen again. Now the “SMART KEY” window should be displayed. Press the “Op Mode” button which will bring up the “Op Mode” menu screen. Press the “Monitoring” button and the Patient Window should be displayed.

If it is not possible to enact change via the smart keys, press the middle “SMART KEY” button and then using the arrow on the right side of the “SMART KEY” screen scroll down and read the buttons to make sure the device is unlocked. If “Unlock” is displayed next to the “Op Mode” button, the device is locked. Press the “Unlock” button and it should now read “Lock”. The menu keys should now work.

**Simulator Setup:**

Connect the MX40 PWM leadset to the Lionheart 2 according to color coding. Power on the Lionheart 2 simulator and press the “Execute” button. The Lionheart 2 comes up in ECG simulation at 80 bpm by default- it is also menu item “34”. Connect the CTS network infrastructure and Philips Information Center hardware together as shown:

**Central Station Setup:**

Power on the CTS network infrastructure components. The Central station & Infrastructure will be pre-configured by R&D, such that on Power-up of the system the desired operation mode will be active displaying 3 ECG waveforms and an SpO2 waveform. Power on the M3150A PIC components. The Philips Information Center Central station software should load automatically within about 5 minutes. 3 patient windows should now have an ECG trace with a cardiotech reading of 80 bpm. SpO2 should also be displayed at 93% ±2%.

#### 3.2. EUT Hardware

Blk Diag #	Manufactr	Model/Part # / Options	Serial Number	Input Voltage	Frq (Hz)	Description/Function
1	Philips	865351/MX40	US11400397	3 V	DC	Patient Worn Monitor w/2.4 GHz CTS radio, PP3 build units

#### 3.3. EUT Hardware/Software/Firmware Revision Level

EUT Model#	PCA#	Description	HW	SW	FW
MX40		PWM Main board	Rev. 02		A.00.33

#### 3.4. EUT Cables/Transducers

Blk Diag Ltr	Manufacturer	Model/Part #	Length (m)	Shield Y/N	Description/Function
A	Philips	989803171871	0.8	Y	SpO2 connector/ECG leadset- 6 leads
B	Philips	M1191A	2	N	SpO2 patient transducer

### 3. Product Configuration (continued)

#### 3.5. Support Equipment

Diag Blk #	Manufacturer	Model/Part # Options	Serial Number	Input Voltage	Input Frq.	Description/Function
2	Cisco	AIR AP1242AG-A-K9	FTX1050B5RU	48	DC	WLAN Access Point
		EADP-18FB B	DTH1213VF5E	100-240	50-60	AC Adapter for Access Point
3	Philips	M3154B	2UA610JXJK	100-240	50-60	InbteilliVue Information Center
4	Philips	LE1708	14AP1727A00	100-240	50-60	Display
5	Philips	865024/M8105A	DE74808392	100-240	50-60	MP5 Patient Bedside Monitor

#### 3.6. Support Equipment Cables/Transducers

Blk Diag Ltr	Manufacturer	Model/Part #	Length (m)	Shield Y/N	Description/Function
C	NA	NA	Various	N	Cat 5 LAN cable

#### 3.7. Miscellaneous

Manufacturer	Model/Part #	Description/Function
Duracell	NA	AA batteries

#### 3.8. Block Diagram

Fig.1 Tango EMC Testing

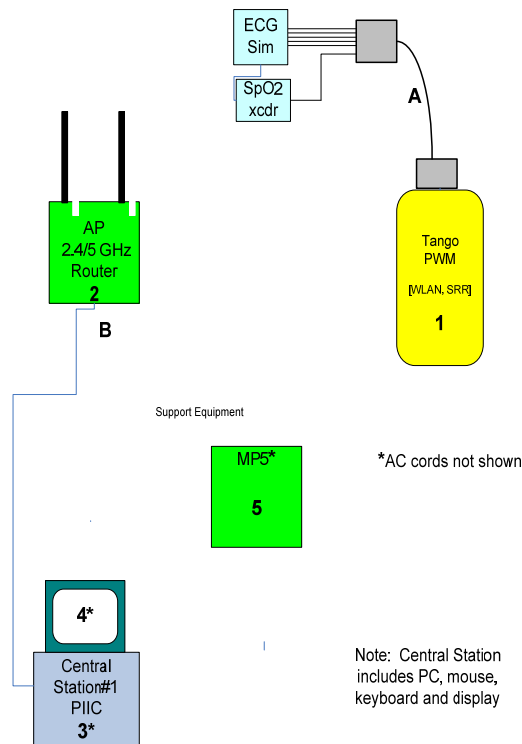

#### 4. Measurements Parameters

##### 4.1. Measurement Equipment Used to Perform Tests

Device	Manufacturer	Model No.	Serial No.	Cal Due
Spectrum Analyzer	Agilent	E4407B	MY45104493	12/22/2012
Spectrum Analyzer	Rohde & Schwarz	FSV40	100899	5/26/2012
Microwave Preamp	Hewlett Packard	8449B	3008A01323	12/1/2012
Bilog Antenna	Com-Power	AC-220	25509	8/30/2012
Horn Antenna	Electro-Metrics	EM-6961	6337	10/19/2012
Horn Antenna	Com-Power	AH-826	081051	6/30/2012
Horn Antenna	ComPower	AH-840	03075	7/20/2012
Loop Antenna	EMCO	6502	2197	7/21/2012
DMM / Temperature	Fluke	187	79690058	1/5/2013
2.4 GHz BP Filter	Micro-Tronics	BRM50702	14	8/11/2012
Digital Barometer	Control Company	4195	ID236	1/4/2013

##### 4.2. Measurement & Equipment Setup

Test Dates: Jan. 16, 2012 to Feb. 10, 2012

Test Engineer: Brian Breault

Normal Site Temperature (15 - 35°C): 21.7

Relative Humidity (20 -75%RH): 33%

Frequency Range: 30 MHz to 25 GHz

Measurement Distance: 3 Meters

EMI Receiver IF Bandwidth: 120 kHz - 30 MHz to 1 GHz  
1 MHz - Above 1 GHz

EMI Receiver Avg Bandwidth: 300 kHz - 30 MHz to 1 GHz  
3 MHz - Above 1 GHz

Detector Function: Peak, QP - 30 MHz to 1 GHz  
Peak, Avg - Above 1 GHz  
Unless otherwise specified.

##### 4.3. Measurement Procedures

Test measurements were made in accordance FCC Part 15.247, IC RSS-210 Annex II: Operation within the bands 902 - 928 MHz, 2400 - 2483.5 MHz, 5725 - 5875 MHz, and 24.0 - 24.25 GHz.

The test procedures detailed in the Federal Communications Commission Office of Engineering and Technology Guidance for Performing Measurements on Digital Transmission Systems (DTS) Operating Under 15.247 (FCC OET Publication Number 558074), dated 1/18/2012, were used to generate the data in this test report.

The test methods used to generate the data in this test report is in accordance with ANSI C63.4: 2003, American National Standard for Methods of Measurement of Radio-Noise Emissions from Low-Voltage Electrical and Electronic Equipment in the Range of 9 kHz to 40 GHz.

**4. Measurements Parameters**

**4.3. Measurement Procedure (continued)**

In accordance with ANSI C63.4-2003, section 13.1.4.1 c), the device under test was rotated through three orthogonal axes to determine which attitude produced the highest emission relative to the limit. The attitude that produced the highest emission relative to the limit was used for all radiated emission measurements and is detailed in this test report.

**4.4. Measurement Uncertainty**

The following uncertainties are expressed for an expansion/coverage factor of K=2.

RF Frequency	$\pm 1 \times 10^{-8}$
Radiated Emission of Transmitter	$\pm 4.55$ dB
Radiated Emission of Receiver	$\pm 4.55$ dB
Temperature	$\pm 0.91^{\circ}$ C
Humidity	$\pm 5\%$

**5. Choice of Equipment for Test Suits**

**5.1 Choice of Model**

This test report is based on the test samples supplied by the manufacturer and are reported by the manufacturer to be equivalent to the production units.

**5.2 Presentation**

This test sample was tested complete with all required ancillary equipment. Refer to Section 3 of this report for product equipment configuration.

**5.3 Choice of Operating Frequencies**

The MX40 Patient Worn Monitor 802.11g transmitter, as tested, operates on 11 channels, from channel 1 to channel 11.

In accordance with ANSI C63.4-2009, section 13.2.1, the choice of operating frequencies selected for the testing detailed in this report are outlined in the following table:

802.11g

Channel	Frequency (MHz)	Status
<b>1</b>	<b>2412</b>	<b>Tested</b>
2	2417	Not Tested
3	2422	Not Tested
4	2427	Not Tested
5	2432	Not Tested
<b>6</b>	<b>2437</b>	<b>Tested</b>
7	2442	Not Tested
8	2447	Not Tested
9	2452	Not Tested
10	2457	Not Tested
<b>11</b>	<b>2462</b>	<b>Tested</b>

**6. Measurement Summary**

Test Requirement	FCC Rule Reference	IC Rule Reference	Test Report Section	Result
Antenna Requirement	15.203	RSS-GEN 7.1.2	7.1	Compliant
Minimum 6 dB Bandwidth	(a) (2)	RSS-210 A8.2	7.2	Compliant
99% Bandwidth	N/A	RSS-GEN 4.6.1	7.3	Compliant
Maximum Peak Conducted Output Power	(b) (1)	RSS-210 A8.4 (4)	7.4	Compliant
Operation with directional antenna gains greater than 6 dBi	(b) (4)	RSS-GEN 7.1.2	7.5	Compliant
Spurious Radiated Emissions	15.247 (d)	RSS-GEN 4.9	7.6	Compliant
Spurious Radiated Emissions (> GHz) - Harmonic Measurements	15.247 (d)	RSS-210 A8.9	7.6	Compliant
Receiver Spurious Radiated Emissions	15.247 (d)	RSS-GEN 4.10	7.7	Compliant
Lower and Upper Band Edge	15.247 (d)	RSS-210 A8.5	7.8	Compliant
Power Spectral Density	15.247(e)		7.9	Compliant
Conducted Emissions	FCC Part 15	RSS-GEN	N/A	Compliant
Public Exposure to Radio Frequency Energy Levels	1.1307 (b) (1)	RSS-GEN 5.5 RSS-102	7.10	Compliant



**7. Measurement Data**

**7.1. Antenna Requirement (15.203, RSS GEN 7.1.2)**

Requirement: An intentional radiator shall be designed to ensure that no antenna other than that furnished by the responsible party shall be used with the device. The use of a permanently attached antenna or of an antenna that uses a unique coupling to the intentional radiator shall be considered sufficient to comply with the provisions of this Section.

Conclusion: The 802.11g radio antenna is internal to the unit and not user accessible.

**7.2. Minimum 6 dB Bandwidth**

Requirement: (15.247 (a) (2), RSS 210 A8.2(a))  
 Systems using digital modulation techniques may operate in the 902 - 928 MHz, 2400 - 2483.5 MHz, and 5725 - 5850 MHz bands. The minimum 6 dB bandwidth shall be at least 500 kHz.

Procedure: This test was performed in accordance with the procedure detailed in FCC OET publication number 558074, Section 5.1, clause 5.1.1: Alternate EBW Measurement Procedure.

Conditions: Temperature: 21°C Relative Humidity: 31%

Conclusion: The device under test meets the minimum 500 kHz 6 dB bandwidth requirement.

Measurement Results

Channel	Frequency (MHz)	6 dB Bandwidth (kHz)	Minimum 6 dB Bandwidth (kHz)	Result
Low	2412	16504	>500	Compliant
Middle	2437	16636	>500	Compliant
High	2462	16616	>500	Compliant

7. Measurement Data

7.2. Minimum 6 dB Bandwidth (15.247 (a) (2)) (continued)

6.2.1. Low Channel – 1

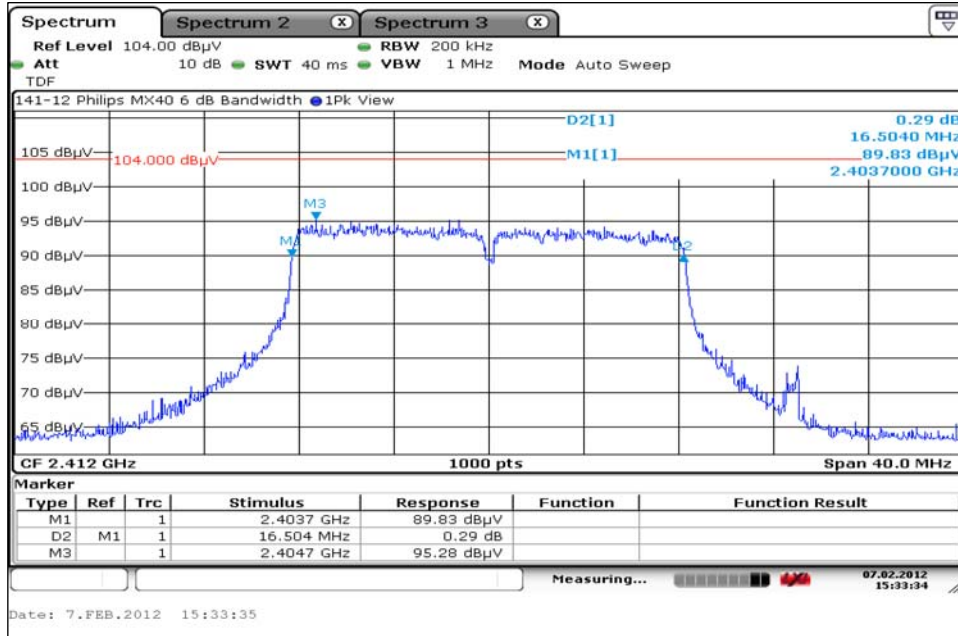

6.2.2. Mid Channel - 6

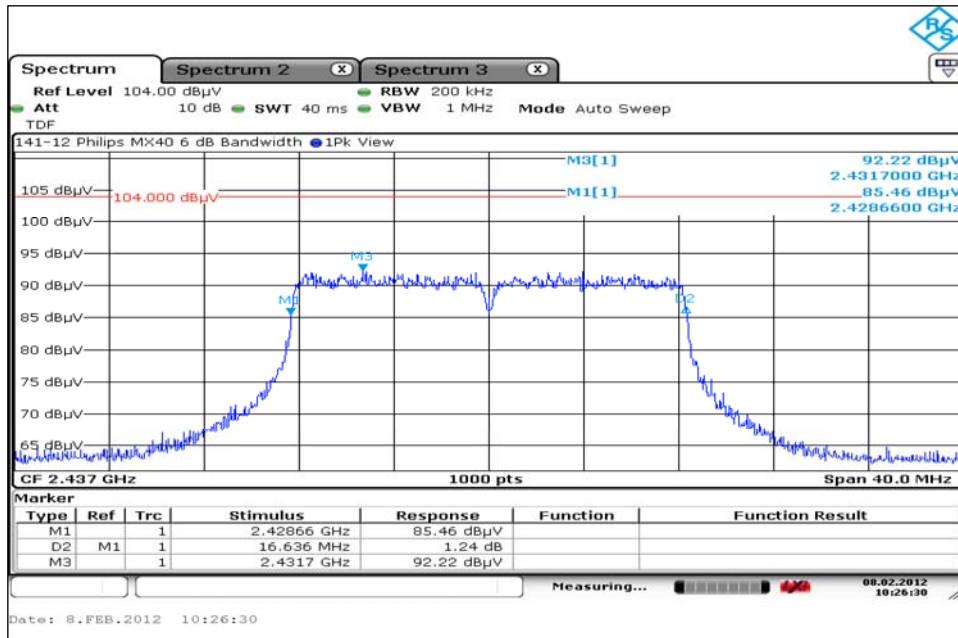

7. Measurement Data (continued)

7.2. Minimum 6 dB Bandwidth (15.247 (a) (2)) (continued)

6.2.3. High Channel - 11

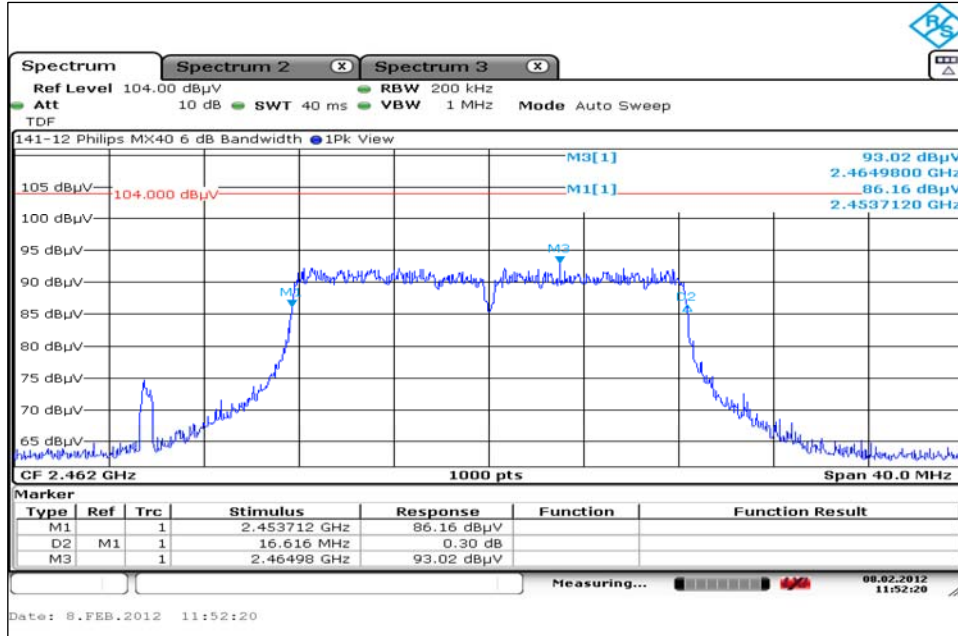

7.3. 99% Bandwidth (RSS 210)

Requirement: When an occupied bandwidth value is not specified in the applicable RSS, the transmitted signal bandwidth to be reported is to be its 99% emission bandwidth, as calculated or measured. The resolution bandwidth shall be set to as close to 1% of the selected span as is possible without being below 1%. The video bandwidth shall be set to 3 times the resolution bandwidth.

Procedure: This test was performed utilizing the automated 99% bandwidth function of the spectrum analyzer.

Conditions: Temperature: 21°C Relative Humidity: 31%

Conclusion: The device under test meets the required 99% bandwidth.

7. Measurement Data (continued)

7.3. 99% Bandwidth (RSS 210) (continued)

Measurement Results

Channel	Channel Frequency (MHz)	99% Power Bandwidth (MHz)	Result
Low	2412	16.560	Compliant
Middle	2437	16.540	Compliant
High	2462	16.620	Compliant

7.3.1. Low Channel – 1

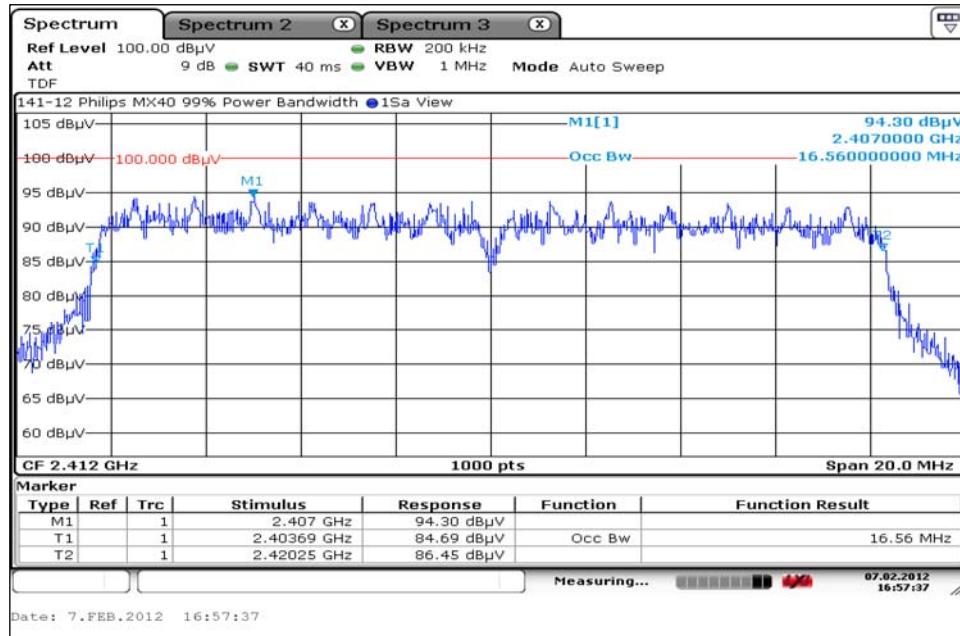

7. Measurement Data (continued)

7.3. 99% Bandwidth (RSS 210) (continued)

7.3.2. Mid Channel - 6

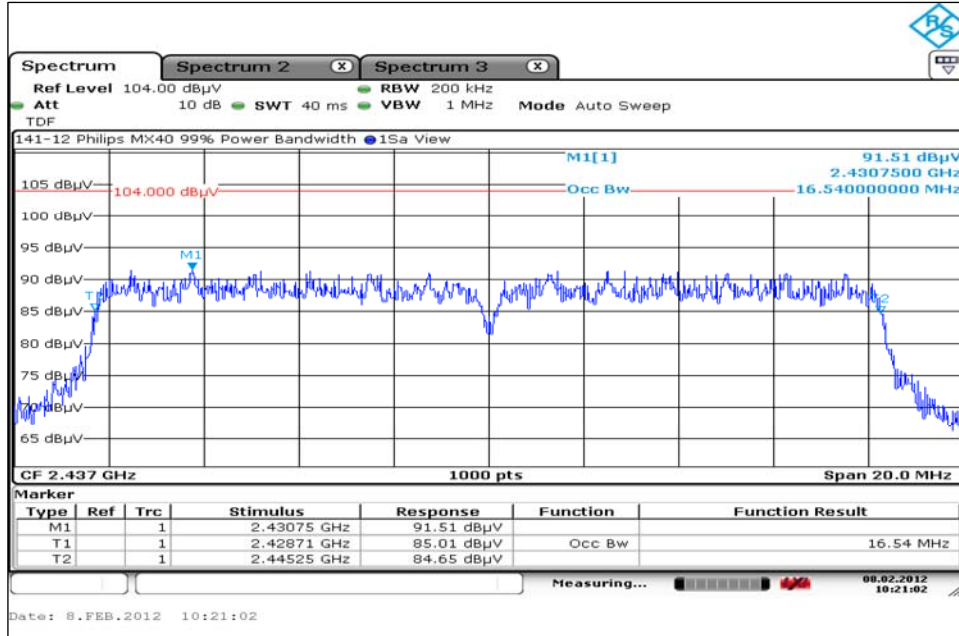

7.3.3. High Channel - 11

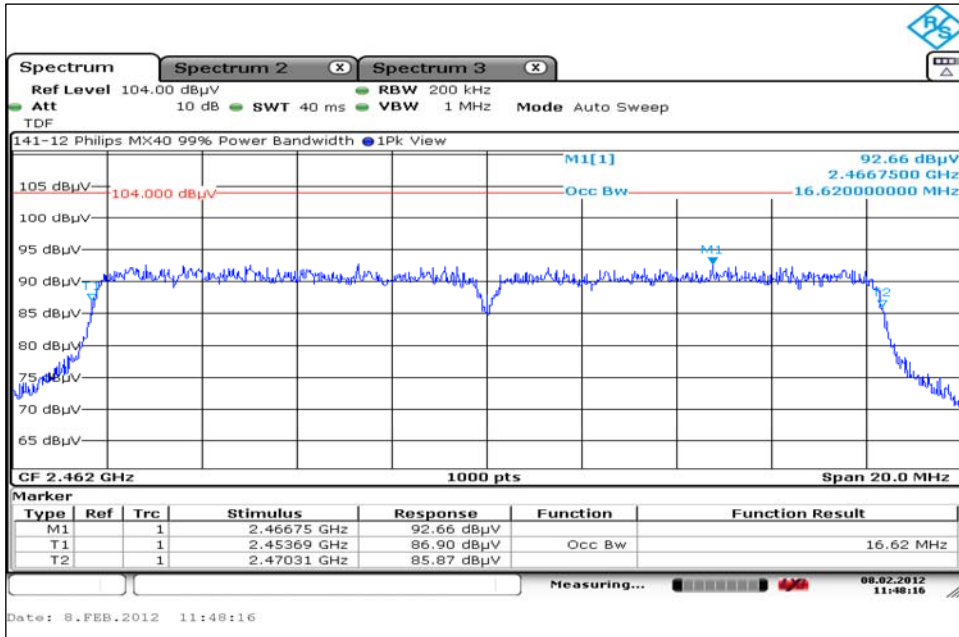

## 7. Measurement Data (continued)

### 7.4. Maximum Peak Conducted Output Power

Requirement: (15.247 (b) (3))

The maximum peak conducted output power of the intentional radiator shall not exceed the following: For systems using digital modulation in the 902–928 MHz, 2400–2483.5 MHz, and 5725–5850 MHz bands: 1 Watt.

Procedure: This test was performed in accordance with the procedure detailed in FCC OET publication number 558074, Section 5.2, clause 5.2.1.1: Measurement Procedure PK1.

Conditions: Temperature: 21°C      Relative Humidity: 31%

Test Notes: The MX40 Short Range Radio Antenna is not removable; therefore the output power was determined from the measured field strength using the following equation:

$$P = \frac{(E \times d)^2}{(30 \times G)}$$

- P = the power in Watts (power has been converted to milliwatts in the table).
- E = the measured maximum field in V/m.
- G = the numeric gain of the transmitting antenna over an isotropic radiator.
- d = the distance in meters of the field strength measurement.

Conclusion: The device under test meets the required maximum peak conducted output power level of 1 Watt.

### Measurement Results

Channel	Freq.	Integrated Peak Field Strength <sup>1</sup>	Distance	Antenna Gain <sup>1</sup>		Meas. Peak Output Power	Output Power Limit <sup>2</sup>	Result
	(MHz)			(dBμV/m)	(d)			
Low	2412	111.43	3.0	-3.00	0.501	83.20	1000	Compliant
Middle	2437	110.45	3.0	-3.00	0.501	66.39	1000	Compliant
High	2462	111.08	3.0	-3.00	0.501	76.76	1000	Compliant

<sup>1</sup> The Integrated Peak field strength was derived from the spectrum analyzer measurement function result and converted to dBμV/m by adding 107. Reference the following screen captures.

<sup>2</sup> Reference section 7.2 for the 6 dB emissions bandwidth.

7. Measurement Data (continued)

7.4. Maximum Peak Conducted Output Power (15.247 (b) (1)) (continued)

7.4.1. Low Channel - 1

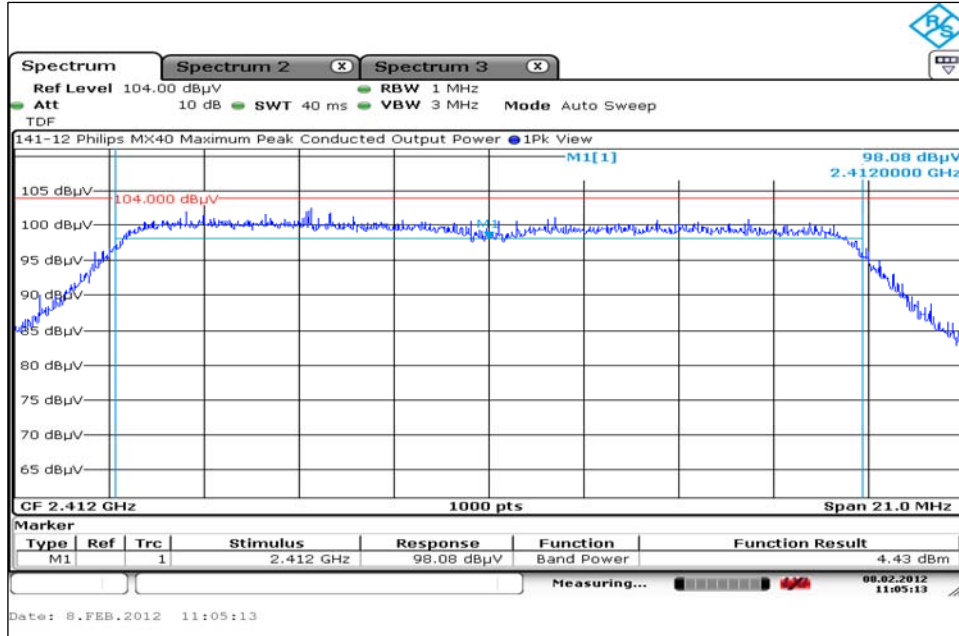

7.4.2. Middle Channel - 6

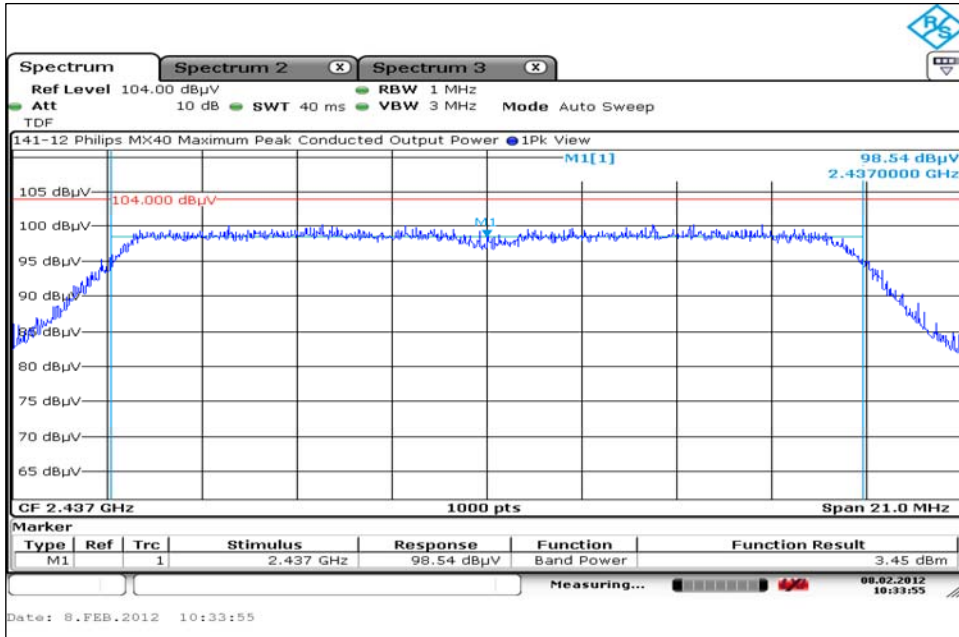

7. Measurement Data (continued)

7.4. Maximum Peak Conducted Output Power (15.247 (b) (1))

7.4.3. High Channel - 11

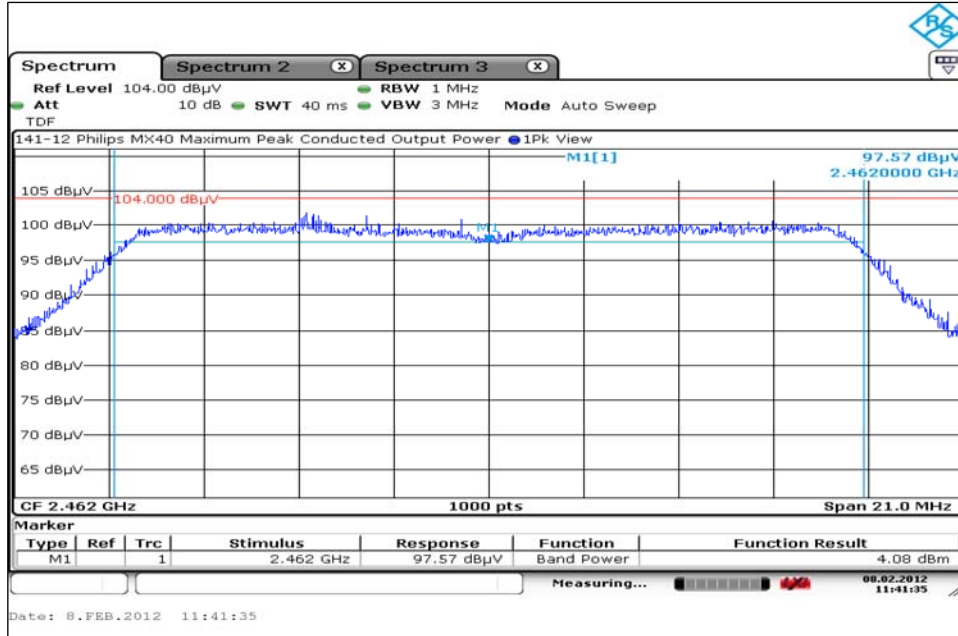

7.5. Operation with directional antenna gains greater than 6 dBi (15.247 (b)(4))

Requirement: If transmitting antennas of directional gain greater than 6 dBi are used, the conducted output power from the intentional radiator shall be reduced below the stated values in paragraphs (b)(1), (b)(2), and (b)(3) of FCC Part 15.247, as appropriate, by the amount in dB that the directional gain of the antenna exceeds 6 dBi.

DUT Status: The MX40 2.4 GHz 802.11g Radio utilizes an antenna with -3.0 dBi antenna gain value and therefore is not affected by this clause.



**7. Measurement Data (continued)**

**7.6. Transmitter Spurious Radiated Emissions (32 kHz to 40 GHz)**

Requirement: (15.209) The Emissions from an intentional radiator shall not exceed the field strength levels specified in the following table:

Frequency Range (MHz)	Distance (Meters)	Limit (dBµV/m) <sup>1</sup>
0.009 to 0.490	3	128.5 to 93.8
0.490 to 1.705	3	73.8 to 63.0
1.705 to 30	3	69.5
30 to 88	3	40.0
88 to 216	3	43.5
216 to 960	3	46.0
>960	3	54.0

<sup>1</sup>Measurements in the 9 to 90 kHz, 110 to 490 kHz and above 1000 MHz ranges employ an average detector. Otherwise a quasi-peak detector is used.

Procedure: This test was performed in accordance with the procedure detailed in FCC OET publication number 558074, Section 5.4: Maximum Unwanted Emissions Levels and FCC 47CFR Part 15.209: Radiated Emission Limits; General Requirements.

In accordance with ANSI C63.4-2003, section 13.4.1, c), the device under test was rotated through three orthogonal axes to determine which attitude produced the highest emission relative to the limit. The attitude that produced the highest emission relative to the limit was used for all radiated emission measurements and is detailed in this test report.

Test measurements were made in accordance with ANSI C63.4-2003, Standard Methods of Measurement of Radio Noise Emissions from Low-Voltage Electrical and Electronics Equipment in the Range of 9 kHz to 40 GHz.

Conditions: Temperature: 21°C      Relative Humidity: 31%

Conclusion: The Emissions from the DUT did not exceed the field strength levels specified in the above table.

7. Measurement Data (continued)

7.6. Transmitter Spurious Radiated Emissions (30 MHz to 40 GHz)

7.6.1. Spurious Radiated Emissions (32 kHz – 30 MHz) Test Results

7.6.1.1. Measurement Results – Parallel Antenna

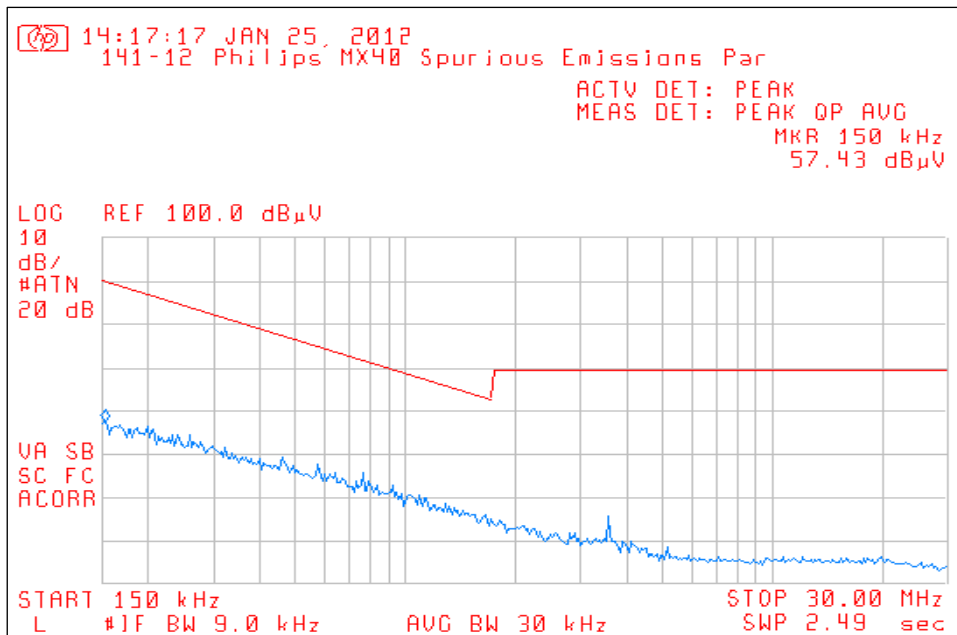
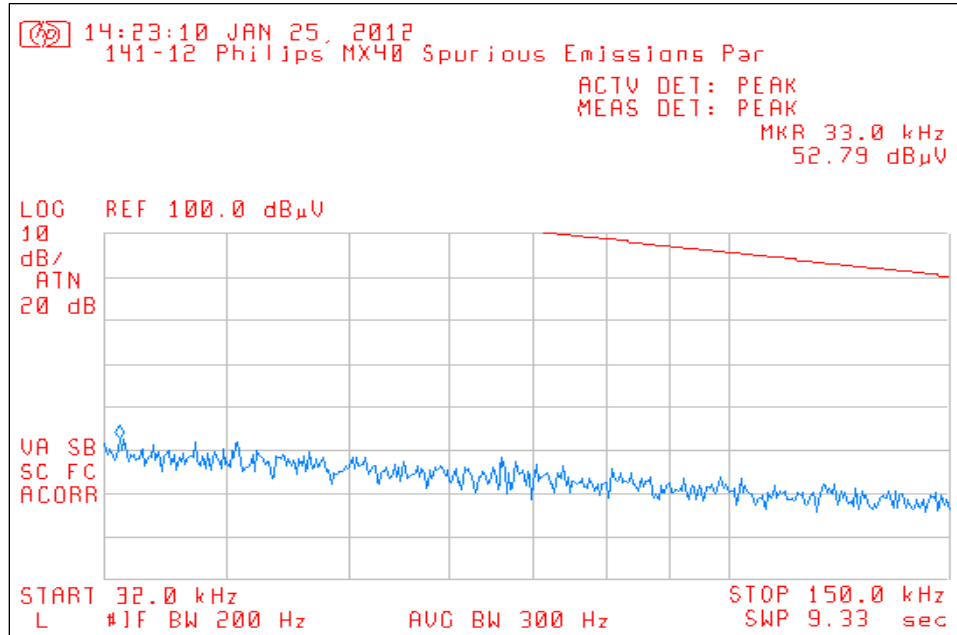

7. Measurement Data (continued)

7.6. Transmitter Spurious Radiated Emissions (30 MHz to 40 GHz)

7.6.1. Spurious Radiated Emissions (32 kHz – 30 MHz) Test Results

7.6.1.2. Measurement Results – Perpendicular Antenna

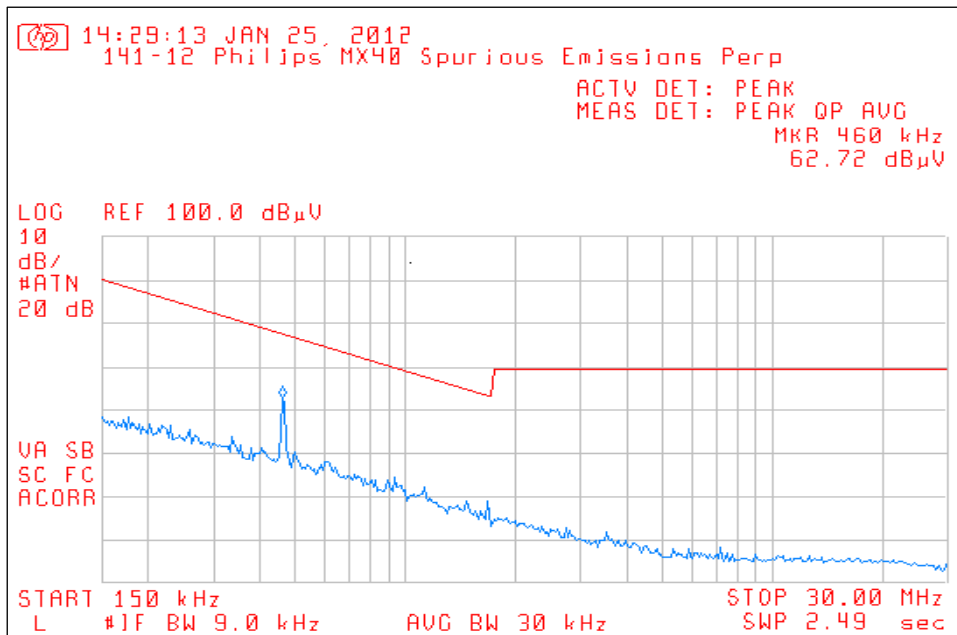
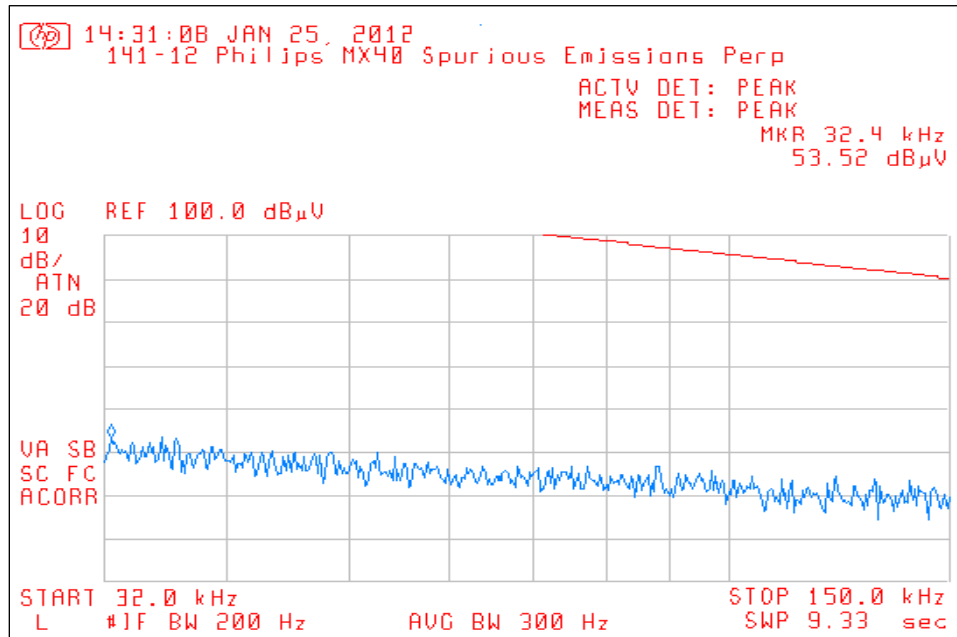

**7. Measurement Data (continued)**

**7.6. Transmitter Spurious Radiated Emissions (30 MHz to 40 GHz)**

7.6.2. Spurious Radiated Emissions (30 MHz – 1 GHz) Test Results

Note: This table represents a composite list of the worst case of all orthogonal positions of the device under test.

Freq. (MHz)	Field Strength (dBµV/m)		Limit (dBµV/m)	Margin (dB)	Antenna Polarity (H/V)	Result
	Peak	Quasi-Peak	Quasi-Peak			
133.0900	46.80	32.70	43.50	-10.80	H	Compliant
347.1616	51.20	35.70	46.00	-10.30	H	Compliant
348.5643	51.50	39.80	46.00	-6.20	H	Compliant
348.9729	56.10	40.50	46.00	-5.50	H	Compliant
349.5966	51.50	37.00	46.00	-9.00	H	Compliant
349.6158	51.50	36.80	46.00	-9.20	V	Compliant
350.0345	54.00	38.60	46.00	-7.40	H	Compliant

7.6.3. Spurious Radiated Emissions (Above 1 GHz) Test Results

There were measurable no transmitter spurious emissions other than the emissions tabled in sections 7.6.4.

**7. Measurement Data (continued)**

**7.6. Transmitter Spurious Radiated Emissions (30 MHz to 40 GHz)**

7.6.4. Transmitter Spurious Radiated Emissions (Harmonic Meas.) Test Results

Note: This table represents a composite list of the worst case of all orthogonal positions of the device under test.

Freq. (MHz)	Field Strength (dBµV/m) <sup>1</sup>		Limit (dBµV/m)		Margin (dBµV/m)		Antenna Polarity (H/V)	Result
	Peak	Average	Peak	Average	Peak	Average		
4824.000	56.45	41.74	74.00	54.00	-17.55	-12.26	H	Compliant
4874.000	51.97	40.41	74.00	54.00	-22.03	-13.59	V	Compliant
4924.000	49.86	46.54	74.00	54.00	-24.14	-7.46	V	Compliant
7236.000	53.12	41.68	74.00	54.00	-20.88	-12.32	V	Compliant
7311.000	52.00	40.45	74.00	54.00	-22.00	-13.55	H	Compliant
7386.000	51.12	40.34	74.00	54.00	-22.88	-13.66	H	Compliant
9648.000	53.66	42.82	74.00	54.00	-20.34	-11.18	V	Compliant
9748.000	53.88	43.21	74.00	54.00	-20.12	-10.79	H	Compliant
9848.000	54.57	43.19	74.00	54.00	-19.43	-10.81	H	Compliant
12060.000	56.10	46.23	74.00	54.00	-17.90	-7.77	V	Compliant
12185.000	55.15	45.16	74.00	54.00	-18.85	-8.84	H	Compliant
12310.000	55.15	45.16	74.00	54.00	-18.85	-8.84	H	Compliant
14472.000	60.61	50.24	74.00	54.00	-13.39	-3.76	V	Compliant
14622.000	61.42	48.64	74.00	54.00	-12.58	-5.36	H	Compliant
14772.000	57.35	48.04	74.00	54.00	-16.65	-5.96	H	Compliant
16884.000	54.34	43.37	74.00	54.00	-19.66	-10.63	V	Compliant
17059.000	53.72	43.24	74.00	54.00	-20.28	-10.76	V	Compliant
17234.000	56.00	44.78	74.00	54.00	-18.00	-9.22	H	Compliant
19296.000	53.45	42.68	74.00	54.00	-20.55	-11.32	H	Compliant
19496.000	54.22	43.28	74.00	54.00	-19.78	-10.72	V	Compliant
19696.000	52.73	42.39	74.00	54.00	-21.27	-11.61	V	Compliant
21708.000	51.95	41.53	74.00	54.00	-22.05	-12.47	H	Compliant
21933.000	52.75	42.64	74.00	54.00	-21.25	-11.36	V	Compliant
22158.000	52.81	41.58	74.00	54.00	-21.19	-12.42	V	Compliant
24120.000	50.45	40.32	74.00	54.00	-23.55	-13.68	H	Compliant
24370.000	54.70	43.87	74.00	54.00	-19.30	-10.13	H	Compliant
24620.000	55.68	44.68	74.00	54.00	-18.32	-9.32	H	Compliant

<sup>1</sup> All correction factors are stored in the spectrum analyzer and applied to this column entry. Measurements at 16.884 GHz, 17.059 GHz and 17.234 GHz were made at 1 meter. All other measurements were made at 3 meters.

## 7. Measurement Data (continued)

### 7.7. Band Edge Measurements

**Requirement:** In any 100 kHz bandwidth outside the frequency band in which the spread spectrum or digitally modulated intentional radiator is operating, the radio frequency power that is produced by the intentional radiator shall be at least 20 dB below that in the 100 kHz bandwidth within the band that contains the highest level of the desired power, based on either an RF conducted or a radiated measurement, provided the transmitter demonstrates compliance with the peak conducted power limits. If the transmitter complies with the conducted power limits based on the use of RMS averaging over a time interval, as permitted under paragraph (b)(3) of this section, the attenuation required under this paragraph shall be 30 dB instead of 20 dB. Attenuation below the general limits specified in Section 15.209(a) is not required. In addition, radiated emissions which fall in the restricted bands, as defined in Section 15.205(a), must also comply with the radiated emission limits specified in Section 15.209(a) (see Section 15.205(c)).

**Procedure:** For the lower band edge, this test was performed in accordance with the procedure detailed in FCC OET publication number 558074, Section 5.4: Maximum Unwanted Emissions Levels. and FCC 47CFR Part 15.209: Radiated Emission Limits; General Requirements.

For the upper band edge, this test was performed in accordance with the procedure detailed in FCC OET publication number 558074, Section 5.4.2.2.2: Unwanted Emissions in Restricted Bands for Frequencies > 1000 MHz. and FCC 47CFR Part 15.209: Radiated Emission Limits; General Requirements.

In accordance with ANSI C63.4-2003, section 13.4.1, c), the device under test was rotated through three orthogonal axes to determine which attitude produced the highest emission relative to the limit. The attitude that produced the highest emission relative to the limit was used for all radiated emission measurements and is detailed in this test report.

Test measurements were made in accordance with ANSI C63.4-2003, Standard Methods of Measurement of Radio Noise Emissions from Low-Voltage Electrical and Electronics Equipment in the Range of 9 kHz to 40 GHz.

**Conditions:** Temperature: 21°C      Relative Humidity: 31%

**Conclusion:** The Emissions from the DUT did not exceed the field strength levels specified in the above table.

7. Measurement Data (continued)

7.7. Band Edge Measurements (continued)

7.7.1. Measurement Results – Lower Band Edge

Lowest Channel	Reference Level (PSD) <sup>1</sup> (dBµV/m)		Band Edge Frequency (MHz)	Unwanted Emission (dBµV/m)		Required Attenuation	Actual Attenuation	Result
	(MHz)	Freq.		Level	Freq.			
2412	2405.753	92.28	2400	2399.795	66.06	≥20 dB	26.22 dB	Compliant

<sup>1</sup> Refer to Section 7.9, measurement plot 7.9.1, for the power spectral density value used in this table.

Measurement Plot – Lower Band Edge – Unwanted Emissions

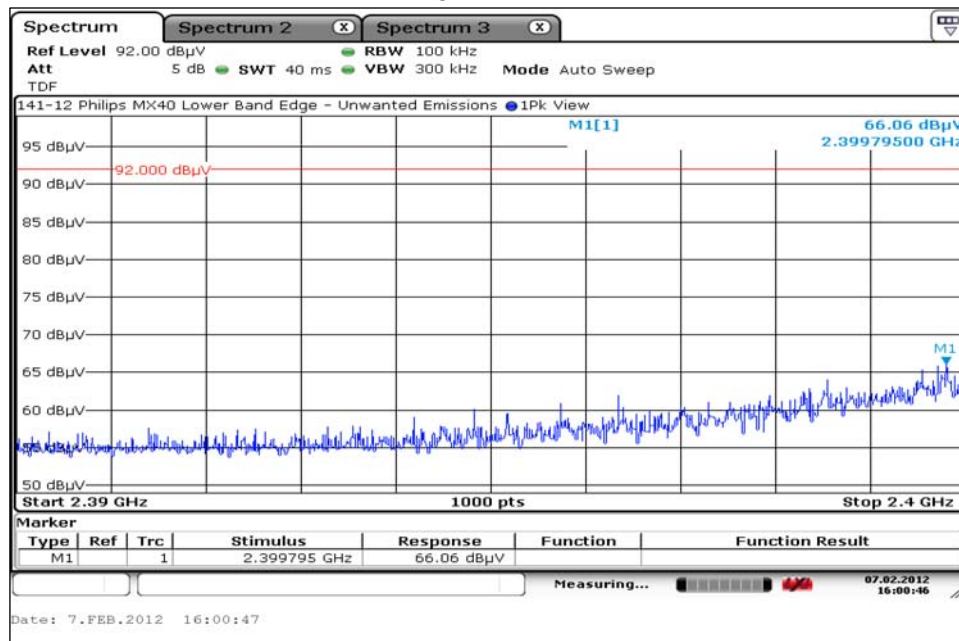

7. Measurement Data (continued)

7.7. Band Edge Measurements (continued)

7.7.2. Measurement Results – Upper Band Edge

	Freq. (MHz)	Field Strength (dBµV/m)		Limit (dBµV/m)		Margin (dBµV/m)		Result
		Peak	Average	Peak	Average	Peak	Average	
Band Edge	2483.500	57.93	47.98	74	54	-16.07	-6.02	Compliant
Worst Case Out of Band	2484.540	59.88	48.56	74	54	-14.12	-5.44	Compliant

Measurement Plot – Upper Band Edge

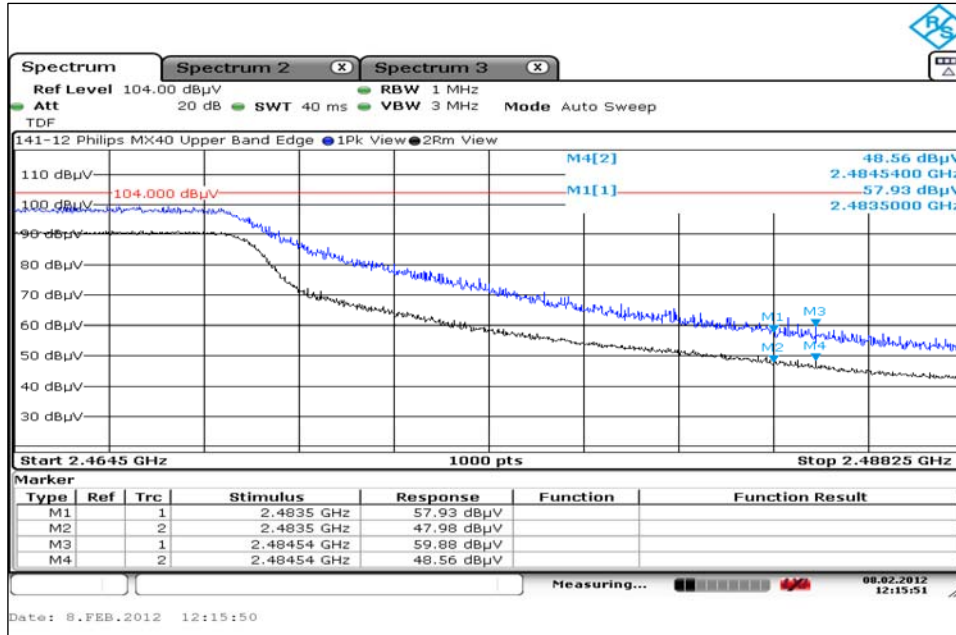



**7. Measurement Data (continued)**

**7.8. Power Spectral Density (15.247(e))**

Requirement: For digitally modulated systems, the power spectral density conducted from the intentional radiator to the antenna shall not be greater than 8 dBm in any 3 kHz band during any time interval of continuous transmission. This power spectral density shall be determined in accordance with the provisions of paragraph (b) of this section. The same method of determining the conducted output power shall be used to determine the power spectral density.

Procedure: FCC OET publication number 558074, Section 5.3: Maximum Power Spectral Density Level in the Fundamental Emission, clause 5.3.1: Measurement Procedure PKPSD.

Conditions: Temperature: 21°C Relative Humidity: 31%

Conclusion: The DUT passed the required power spectral density limit at the tested frequencies.

Measurement Results

Channel	Channel Frequency (GHz)	Measured Frequency (GHz)	PSD Value Radiated (dBμV/m)	Power Spectral Density (dBm)	Add RBW Correction Factor <sup>1</sup> (-15.2 dB)	Limit (dBm)	Result
Low	2412	2.4045753	92.28	0.051	-15.149	8	Compliant
Middle	2437	2.4320130	90.70	-1.529	-16.729	8	Compliant
High	2462	2.4557530	91.07	-1.159	-16.359	8	Compliant

<sup>1</sup> RBW Correction factor = 10log (3 kHz/100 kHz) = -15.2 dB

7. Measurement Data (continued)

7.8. Power Spectral Density (15.247(e))

7.8.1. Low Channel - 1

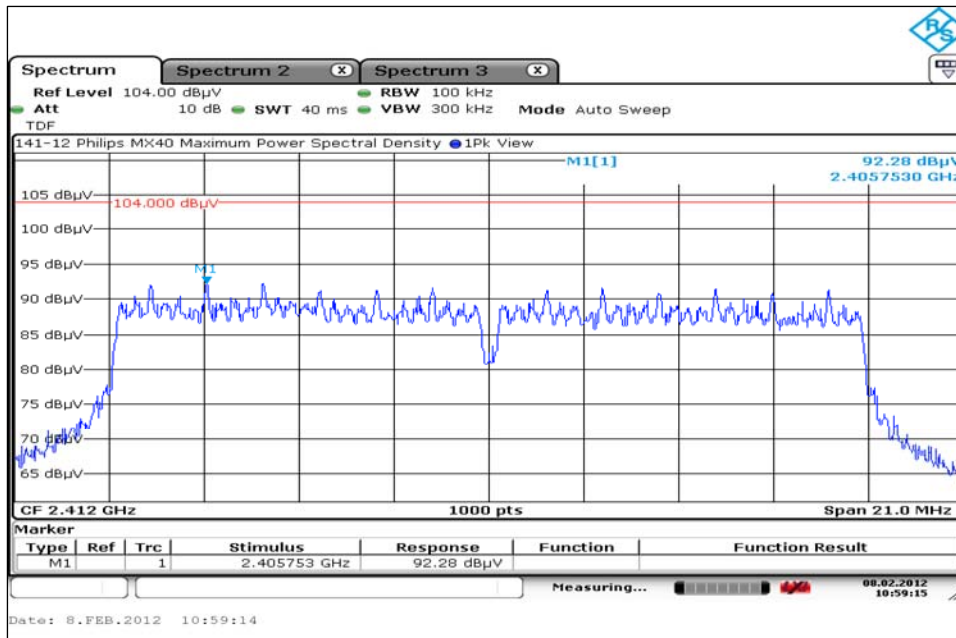

7.8.2. Middle Channel - 6

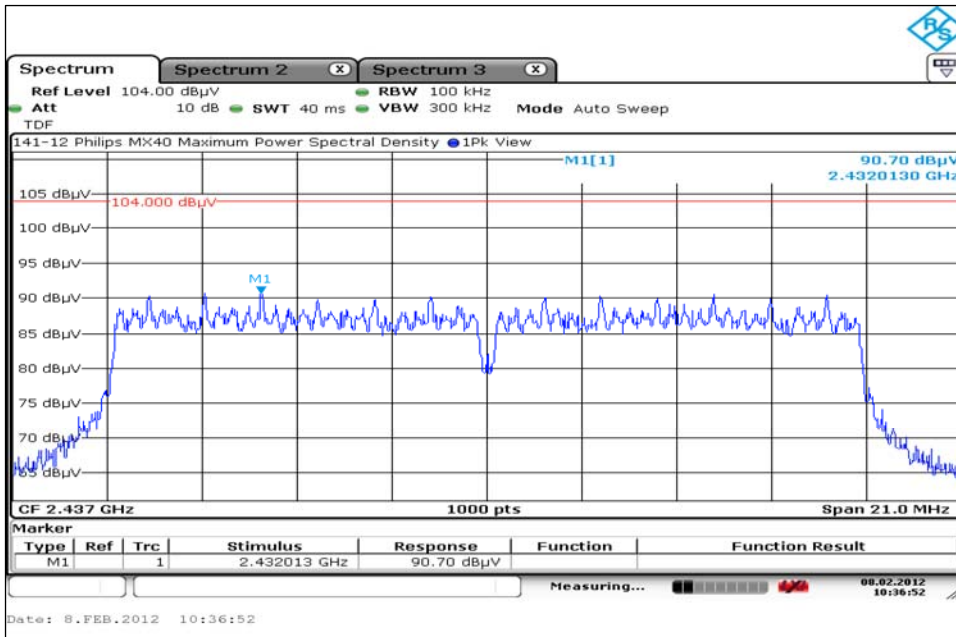

7. Measurement Data (continued)

7.8. Power Spectral Density (15.247(e)) (continued)

7.8.3. High Channel - 11

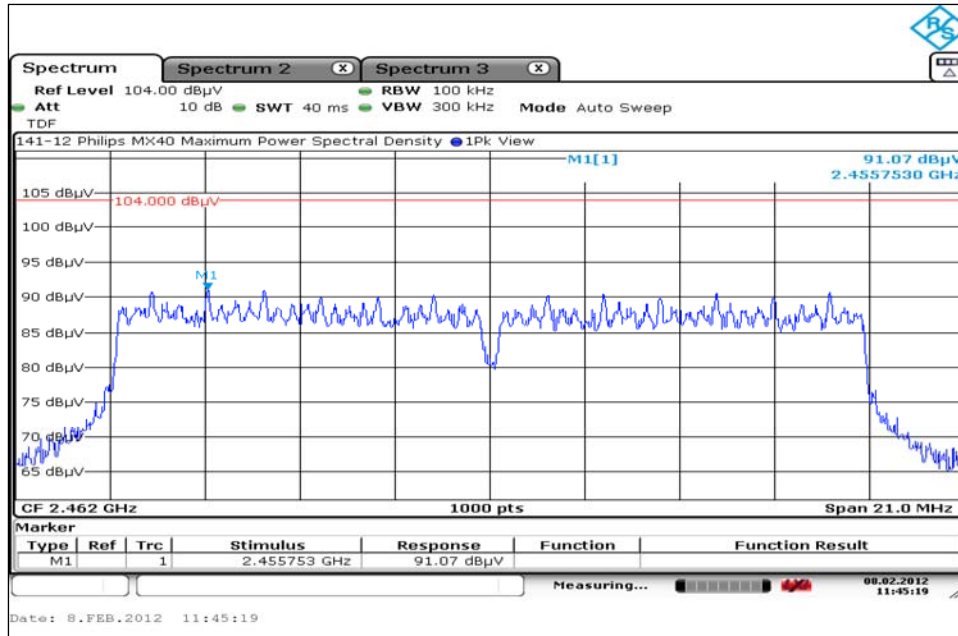

**7. Measurement Data (continued)**

**7.9. Public Exposure to Radio Frequency Energy Levels (15.247(i) (1.1307 (b)(1))  
RSS-GEN 5.5, RSS 102**

Requirement: (15.247(i))

Systems operating under the provisions of this section shall be operated in a manner that ensures that the public is not exposed to radio frequency energy levels in excess of the Commission’s guidelines. Devices are subject to the radio frequency radiation exposure requirements specified in 47CFR 1.1307(b), FCC 47 CFR 2.1091 and 47 CFR 2.1093, as appropriate. All equipment shall be considered to operate in a “general population/uncontrolled” environment.

Procedure: The power density is calculated from the peak field strength and device antenna gain:

$$PD = \frac{OP + AG}{(4 \times \pi \times d^2)}$$

PD Power Density	mW/cm <sup>2</sup>
OP DUT Output Power	dBm
AG DUT Antenna Gain	dBi
d MPE Distance	cm

Conditions: Temperature: 21°C      Relative Humidity: 31% (Nominal)

Conclusion: The device under test is meets radio frequency radiation exposure requirements specified in 47CFR 1.1307(b), § 2.1091 and § 2.1093.

Power Calculated from Peak Field Strength

Channel	Frequency	Peak Field Strength	Distance	Antenna Gain <sup>1</sup>	Measured Output Power	Time Averaged Power
	(MHz)	(dBµV/m)	(m)	(dBi)	(mW)	(mW)
Low	2412	111.43	3.0	-3.0	83.20	0.0004212
Mid	2437	110.45	3.0	-3.0	66.39	0.0003361
High	2462	111.08	3.0	-3.0	76.76	0.0003886

<sup>1</sup> Antenna gain value provided by the manufacturer.

<sup>2</sup> Reference Section 7.4 of this test report for the formula used to convert field strength to power.

**7. Measurement Data (continued)**

**7.9. Public Exposure to Radio Frequency Energy Levels (15.247(i) (1.1307 (b)(1))  
RSS-GEN 5.5, RSS 102 (continued)**

Power Density

Channel Frequency	MPE Distance (cm)	DUT Output Power (dBm)	Time Averaged Power (dBm)	DUT Antenna Gain (dBi)	Power Density		Limit (mW/cm2)	Result
					(mW/cm2)	(W/m2)		
					(4)			
2412	2.5	19.20	-33.76	-3.0	0.0000027	0.0000269	1	Compliant
2437	2.5	18.22	-34.74	-3.0	0.0000021	0.0000214	1	Compliant
2462	2.5	18.85	-34.11	-3.0	0.0000025	0.0000248	1	Compliant

- Reference CFR 2.1093(b): For purposes of this section, a portable device is defined as a transmitting device designed to be used so that the radiating structure(s) of the device is/are within 2.5 centimeters of the body of the user.
- Section 7.4 of this test report.
- Data supplied by the client. Antenna specification data of worst case antenna used by the DUT.
- Power density is calculated from field strength measurement and antenna gain.
- Reference CFR 1.1310, Table 1: Limits for Maximum Permissible Exposure (MPE), Section (B): Limits for General Population/Uncontrolled Exposure.

**The transmitter covered in this test report can be operated with other transmitters within the device. A separate Public Exposure Exhibit will be generated for its co-location.**

7. Measurement Data (continued)

7.9. Public Exposure to Radio Frequency Energy Levels (15.247(i) (1.1307 (b)(1))  
RSS-GEN 5.5, RSS 102 (continued)

Time Average Reduction =  $20 \log_{10} (.225 \text{ ms} / 100 \text{ ms}) = -52.96 \text{ dB}$ .

7.9.1 Determination of time averaged output power – 1 Pulse per 100 ms period.

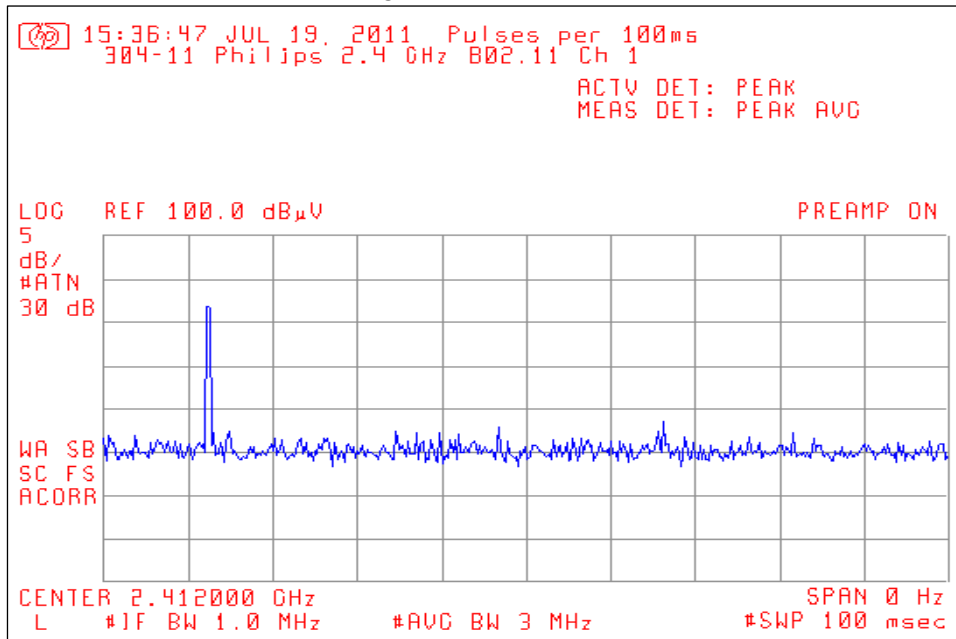

7.9.2 Determination of time averaged output power – Pulse width = 225 µs.

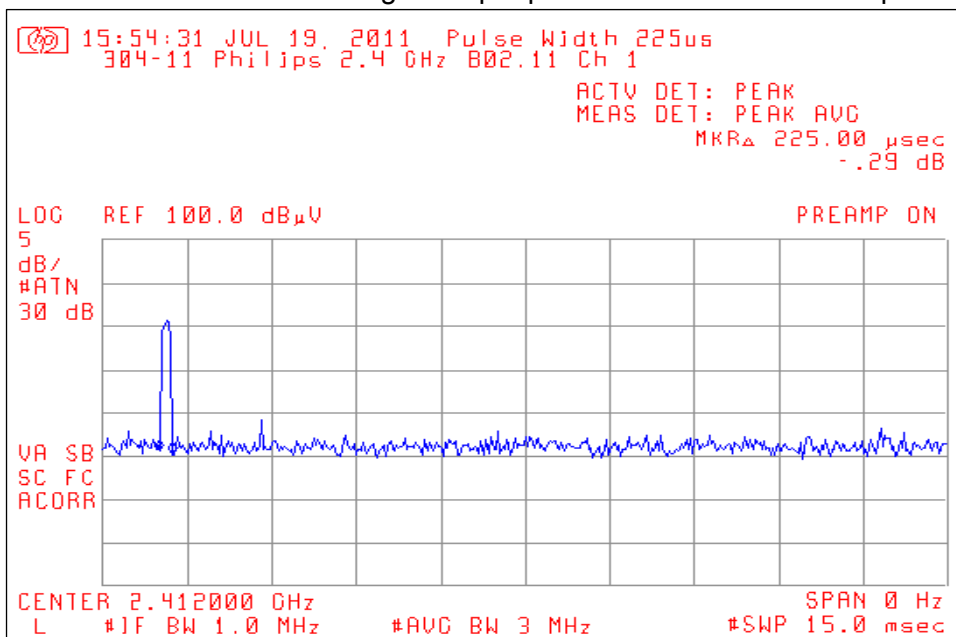

## 8. Test Setup Photographs

### 8.1. Radiated Emissions Front:



## 8. Test Setup Photographs

### 8.2. Radiated Emissions Rear:





## **9. Test Site Description**

Compliance Worldwide is located at 357 Main Street in Sandown, New Hampshire. The test sites at Compliance Worldwide are used for conducted and radiated emissions testing in accordance with Federal Communications Commission (FCC) and Industry Canada standards. A description of the test sites is on file with the FCC (registration number **96392**) and Industry Canada (file number **IC 3023A-1**).

The radiated emissions test site is a 3 and 10 meter enclosed open area test site (OATS). Personnel, support equipment and test equipment are located in the basement beneath the OATS ground plane.

The conducted emissions site is part of a 16' x 20' x 12' ferrite tile chamber and uses one of the walls for the vertical ground plane required by EN 55022.

Both sites are designed to test products or systems 1.5 meter W x 1.5 meter L x 2.0 meter H, floor standing or table top.