IntelliVue TRx/TRx⁺ Transceivers

for the ITS4840A/ITS4850A IntelliVue Telemetry System

Notice (ITS4842A, TRx4841A)

These devices comply with part 15 of the FCC Rules. Operation is subject to the following two conditions: (1) these devices may not cause harmful interference, and (2) these devices must accept any interference received, including interference that may cause undesired operation.

Notice (ITS4852A, TRx4851A)

These devices comply with part 15 of the FCC Rules, ETSI, RSS-210, and other international radio standards that govern operation in the ISM band. Operation is not subject to WMTS rules.

Instructions for Use

Part Number: 4535 640 87761
Printed in the U.S.A. September 2008
First Edition

PHILIPS

Notice

Document number: 453564087761, First Edition

Printed in the USA.

© Copyright 2008 Koninklijke Philips Electronics N.V. All Rights Reserved. Reproduction in whole or in part is prohibited without the prior written consent of the copyright holder.

Philips Medical Systems Nederland B.V. reserves the right to make changes in specifications and/or to discontinue any product at any time without notice or obligation and will not be liable for any consequences resulting from the use of this publication.

Equipment specifications are subject to alteration without notice. All changes will be in compliance with regulations governing manufacture of medical equipment.

OxiCliq[®] and OxiMax[®] are registered trademarks of Nellcor Incorporated.

Duracell[®] is a registered trademark of Duracell International Incorporated.

Manufacturer

Philips Medical Systems
3000 Minuteman Road
Andover, MA 01810-1099
(978) 687-1501

Printing History

New editions of this document will incorporate all material updated since the previous edition. Update packages can be issued between editions and contain replacement and additional pages to be merged by a revision date at the bottom of the page. Note that pages which are rearranged due to changes on a previous page are not considered revised.

The documentation printing date and part number indicate its current edition. The printing date changes when a new edition is printed. (Minor corrections and updates which are incorporated at reprint do not cause the date to change.) The document part number changes when extensive technical changes are incorporated.

First Edition.....September 2008

IntelliVue TRx4841A C.00 Transceivers are compatible with:

- IntelliVue Telemetry System, Revision A.00 and B.00
- IntelliVue Information Center, Software Revision L.00
- M2636C TeleMon Companion Monitor, Revision C.00
- IntelliVue MP5 Patient Monitor, Revision G.00

IntelliVue TRx4851A C.00 Transceivers are compatible with:

- IntelliVue Telemetry System, Revision B.00
- IntelliVue Information Center, Software Revision L.00
- M2636C TeleMon Companion Monitor, Revision C.00
- IntelliVue MP5 Patient Monitor, Revision G.00

About this Book

This book contains operating instructions for use of the IntelliVue TRx and TRx⁺ Transceivers as used with the IntelliVue Telemetry System with Smart-Hopping Technology. It also includes operational information for the telemetry functions of the IntelliVue Information Center. The intended audience is the clinician who uses and/or teaches others to use this equipment in a healthcare environment.

Additional resources for Philips products used in conjunction with the IntelliVue TRx and TRx⁺ Transceivers include:

- *IntelliVue Information Center Instructions for Use*
- *IntelliVue Information Center Online Help*
- *M2636C TeleMon Companion Monitor Instructions for Use*
- *IntelliVue Telemetry System Training Program*
- *IntelliVue MP5 Patient Monitor Instructions for Use*
- *IntelliVue MP2 Patient Monitor Instructions for Use*
- *IntelliVue X2 Patient Monitor Instructions for Use*

For preventive maintenance, repair, and test methods for verification of device performance, refer to the *IntelliVue Telemetry System Service Kit*.

Document Conventions

The following document conventions are used throughout this manual to identify specific safety and operational information.

Warnings

Warning

Warnings are information you must know to avoid injuring patients and personnel.

Cautions

Caution

Cautions are information you must know to avoid damaging your equipment and software.

Notes

Note—Notes contain additional information on use of the IntelliVue Telemetry System.

Procedures

Procedures are indicated in the following table:

Step	Action
1	
2	
3	

About this Book

Contents

1. Introducing IntelliVue Telemetry	1-1
The IntelliVue Transceiver	1-2
Transceiver Features	1-2
Transceiver Models	1-2
IntelliVue Telemetry System	1-4
Bi-directional Capability	1-4
Smart-hopping Technology	1-5
Spectrum Sharing	1-8
IntelliVue Clinical Network	1-8
Transceiver Use with Other Equipment	1-9
2. Product Safety	2-1
General Safety	2-2
3. Transceiver Controls	3-1
Transceiver Controls - Front	3-2
Buttons	3-3
Power On/Off	3-4
Indicators	3-5
Labels	3-6
Ports	3-7
Transceiver Controls - Back	3-8
Labels	3-9
Safety Symbols & Other Marks	3-9
Audible Tones	3-12
Clinical Use	3-12
Adjustable Sounds	3-13
Service Sounds	3-14
4. Basic Operation	4-1
Transceiver Safety Information	4-2
Turning the Transceiver On/Off	4-2
Turning On	4-3
Turning Off	4-3
Standby Mode	4-4
Briefing the Patient	4-6

Pouch Use	4-7
Securing the Pouch.	4-7
Showering	4-10
Testing Transceiver Functionality.	4-11
Self Test	4-11
Status Check.	4-12
Battery Information.	4-13
Battery Safety Information.	4-13
Inserting/Removing Batteries	4-14
Checking the Battery Power Level	4-17

5. Alarms 5-1

Alarm Indicators	5-2
Testing Alarm Indicators	5-2
Suspending/Pausing Alarms	5-2
Unsuspending& Resuming Alarms	5-4
Physiologic Alarms	5-4
Technical Alarms (INOPs)	5-10

6. ECG Monitoring 6-1

ECG Safety Information	6-2
For Paced Patients	6-3
Measuring ECG.	6-4
ECG Configuration	6-4
ECG Leads Monitored	6-6
Positioning ECG Electrodes.	6-10
Locating the Fourth Intercostal Space	6-12
3-Wire Placement.	6-13
5-Wire Placement (Standard Mode)	6-14
5-Wire Placement (EASI Mode)	6-16
6-Wire Placement.	6-17
Connecting the ECG Cable	6-21
Cable Disconnection	6-24
Verifying Electrode Connections	6-25
Monitoring during Leads Off	6-27
ECG Fallback.	6-27
Relearning	6-28
Using EASI Leads to Troubleshoot	6-28
Optimizing ECG Measurement Performance	6-29
Muscle and Movement Artifact	6-32

7. ST/AR Arrhythmia

Monitoring	7-1
ST/AR Arrhythmia Algorithm	7-2
Indications for Use	7-2
Safety Information	7-2
For Paced Patients	7-3
Intended Use	7-4
ST/AR Arrhythmia Analysis	7-5
ST/AR ST Segment Algorithm	7-7
Intended Use	7-7
The Measurement	7-8
Algorithm Processing	7-8
Displayed ST Data	7-9
EASI ST Analysis	7-9
ST Operation	7-9
ST Alarm Settings	7-12
ST/AR QT Interval Algorithm	7-14
Intended Use	7-14
What is QT Interval Monitoring	7-15
QT Definitions	7-16
QT Alarms	7-17
How the QT Analysis Algorithm Works	7-18
Adjusting QT Settings	7-18
Limitations for QT Monitoring	7-23

8. SpO₂ Monitoring

8-1	8-1
SpO ₂ Safety Information	8-2
SpO ₂ Information for the User	8-3
Pulse Oximetry Measurement	8-5
Pulse Tone Indication	8-6
Selecting a SpO ₂ Sensor	8-7
Applying the Sensor	8-11
Sensor Application Safety Information	8-11
Site Selection	8-12
Sensor Application	8-12
Connecting the SpO ₂ Cable	8-15
Measuring SpO ₂	8-16
Spot Check Measurement	8-17
Continuous Measurement	8-18
When Connected to TeleMon	8-19

Turning SpO ₂ Monitoring Off	8-19
SpO ₂ Enable/Disable at Information Center	8-20
SpO ₂ Auto ON at Information Center	8-20
Understanding SpO ₂ Alarms	8-21
Optimizing SpO ₂ Measurement Performance	8-22
9. Telemetry Functions at the Information Center & TeleMon	9-1
Telemetry Functions at the Information Center	9-2
Telemetry Controls in the Patient Window	9-2
Locating the Transceiver (Find Device)	9-3
Viewing Device Location in the Patient Window (optional)	9-4
Viewing Device Location History (optional)	9-4
Using the Device Location Client (optional)	9-5
Patient Configurable Settings in Telemetry Setup	9-6
Unit-Configurable Settings	9-9
RF Auto Shutoff	9-18
Transceiver Operation when Connected to TeleMon	9-19
10. Pairing Monitoring Devices	10-1
Device Revision Pairing Functionality	10-3
Networked Devices	10-4
Basic Pairing	10-4
Pairing via Direct Connection to the MP5	10-5
Pairing via Short-Range Radio Connection	10-6
Alarm Behavior (Networked)	10-9
Alarm Behavior (Networked with Cable or Short-Range Radio Connection)	10-13
Paired Device Synchronized Alarm Settings (Networked)	10-15
Non-networked Devices	10-17
Pairing via Direct Connection to the MP5/MP5T	10-18
Pairing via Short- Range Radio Connection	10-18
Unassigning Transceiver at the Monitor	10-20
Alarm Behavior (Non-networked)	10-20
More Bed Alarms	10-21
Short-Range Radio Monitoring Considerations	10-22
Short- Range Radio Error Conditions	10-23
11. Maintenance, Cleaning & Troubleshooting	11-1
Maintenance	11-2
Basic Monitoring	11-2
Testing Alarms	11-2

Label Assignment for Replacement Transceiver	11-2
Cleaning and Sterilization	11-4
Cleaning the Transceiver	11-5
EO Sterilization	11-7
Troubleshooting	11-14
Basic Troubleshooting	11-14
Information Signals	11-15

12. Safety Standards & Specifications 12-1

Regulatory Information	12-2
Intended Use	12-2
Indications for Use	12-2
Rx	12-2
Patient Population	12-2
Authorized EU Representative	12-2
Safety Standards	12-3
Essential Performance	12-3
System Classification	12-4
FCC Compliance (M4840A/USA only)	12-4
Industrie Canada Compliance (Canada)	12-5
AC Power Source	12-5
Software Hazard Prevention	12-5
Electromagnetic Compatibility	12-5
Reducing Electromagnetic Interference	12-7
Restrictions for Use	12-7
Battery Specifications	12-8
Radio Specifications	12-9
TRx4841A	12-9
TRx4851A	12-10
SRRA	12-12
Physical Specifications	12-13
ECG-only Transceiver	12-13
ECG/SpO ₂ Transceiver	12-13
SRRA	12-14
Environmental Specifications	12-15
Measurement Specifications	12-16
ECG	12-16
SpO ₂	12-18
SpO ₂ Sensor Accuracy	12-20

A. Accessories	A-1
Accessory Safety	A-1
Transceiver Accessories	A-2
Pouches	A-2
Protective Covers	A-2
Monitor Interface Cable	A-2
Short Range-Radio Adapter	A-3
ECG Accessories	A-3
Electrodes	A-3
Skin Prep Paper	A-3
Leadsets	A-4
Alignment Guides	A-5
Detachable Shields	A-5
SpO ₂ Accessories	A-6
Reusable Sensors	A-6
Disposable Sensors - Single Use	A-7
Adapter Cables	A-9
Wristband	A-9
B. Sales and Support Offices	B-1

Introducing IntelliVue Telemetry

This chapter introduces the IntelliVue TRx and TRx⁺ Transceivers, the patient-worn device of the IntelliVue Telemetry System with Smart-Hopping Technology. It includes the following sections:

- The IntelliVue Transceiver 1-2
- IntelliVue Telemetry System 1-4
- IntelliVue Clinical Network 1-8
- Transceiver Use with Other Equipment 1-9

The IntelliVue Transceiver

The IntelliVue Transceiver is a patient-worn device for monitoring ECG and SpO₂ on adult and pediatric patients within the IntelliVue Telemetry System. The transceiver combines traditional transmitter features with communication to and from the IntelliVue Information Center.

Transceiver Features

- EASI/Standard and Standard only (No EASI) selectable in one device.
- 6-lead with two V-leads for diagnosing multiple cardiac abnormalities, including wide-QRS complex tachycardias and acute myocardial ischemia/infarction.
- Small, lightweight ECG-only device.
- Audio feedback for out-of-range and lost device.
- Battery gauge on device and at Information Center.
- Powered by 2 AA batteries.
- Alarm suspend and resume from standby at device and Information Center.
- SpO₂ Spot Check measurement without using any controls.
- Easy for clinicians to use and comfortable for patients to wear.
- Protective covers preventing debris from accessing unused ports.
- Pouch with clear front that closes securely.
- Simultaneous operation in network with M2601B Transmitter.
- Communication with IntelliVue Patient Monitors via Short-Range Radio connection (MP5/MP5T, MP2 and X2 monitors only)

Transceiver Models

The transceiver is available in two models for each radio frequency spectrum in which they operate (TRx4841A - 1.4 GHz; TRx4851A - 2.4 GHz):

- TRx - ECG Only
- TRx⁺ - ECG and SpO₂

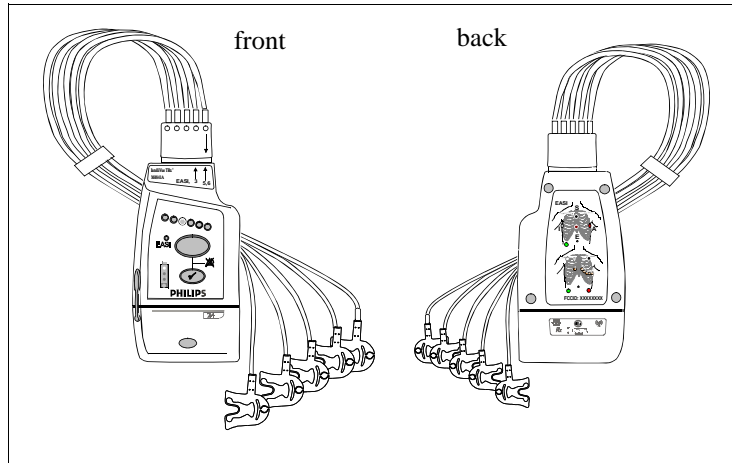

IntelliVue TRx Transceiver - ECG Only

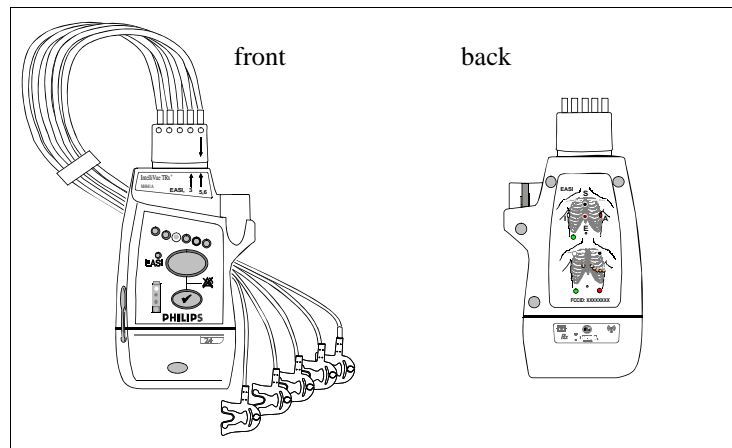

IntelliVue TRx⁺ Transceiver - ECG/SpO₂

IntelliVue Telemetry System

The IntelliVue Telemetry System with Smart-Hopping Technology uses cellular architecture to provide two-way communication between transceivers and the IntelliVue Information Center. Smart-hopping technology dodges interference and seeks out the strongest available signal to achieve seamless connections wherever patients roam on the clinical network. The system connects a number of individual devices to form a complete method of transporting patient data to a central repository for subsequent distribution to clinical staff. Full patient mobility is available within the areas defined by the wireless coverage of the multiple Access Points.

Bi-directional Capability

Telemetry transmits the patient's measurements using radio waves. The signals obtained from the patient travel from the transceiver to an access point in the ceiling or wall and then to the Information Center. Bi-directional capability enables you to remotely control certain transceiver functions from the Information Center. Physiological data is transported from the transceiver, and a reverse data channel enables data to be transported to the transceiver. Bi-directional operations include the following:

- Change SpO₂ measurement mode, or turn SpO₂ measurement off.
- Enable or disable display of the pleth wave.
- Adjust the transceiver volume, or turn it off.
- Find Device feature for locating a lost transceiver within the coverage area.
- Suppress SpO₂ technical alarms (INOPS) during NBP measurement.
- Return from Standby mode after a patient is away from the unit and not being monitored by the IntelliVue Telemetry System.
- Configurable Alarm Pause/Suspend time initiated at the transceiver as well as the Information Center.
- Transceiver location information displayed at the Information Center.
- Transceiver out of area notification at the Information Center.

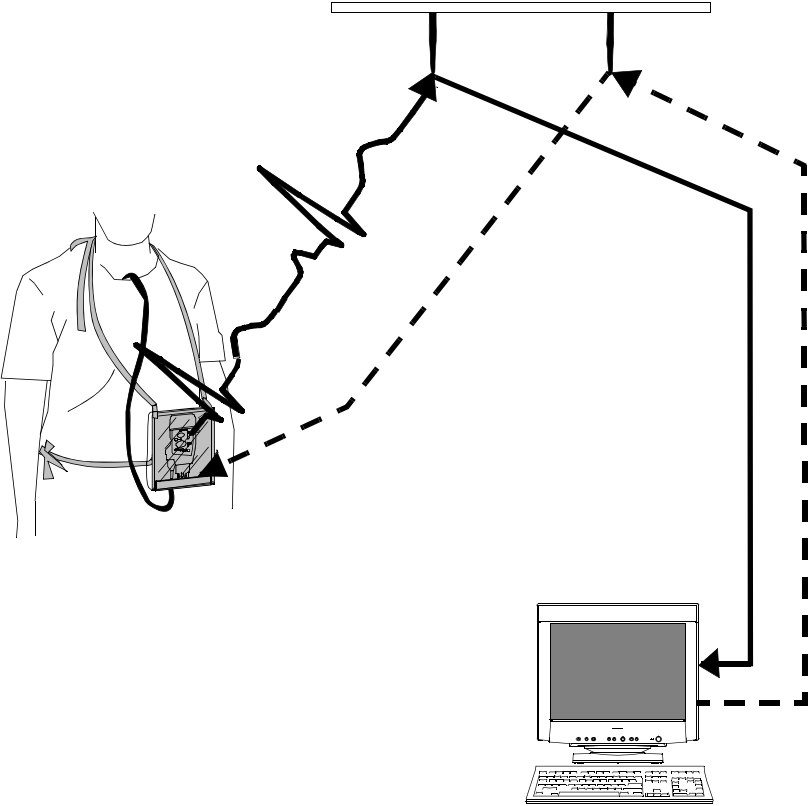

Bi-directional Signal Flow in the IntelliVue Telemetry System

Smart-hopping Technology

Smart-hopping™ technology provides dynamic management of the RF spectrum used by each transceiver. This technology allows a virtually unlimited number of transceivers to operate simultaneously within the IntelliVue Telemetry System by creating a frequency-agile system that changes frequency without user involvement or awareness whenever interference occurs.

Smart-hopping enables the signal to avoid wireless interference. When baseline noise is low (see illustrations following), telemetry signals reside in their frequency/time slot locations. If excessive interference occurs, degrading the signal, the telemetry signal then “hops” over the interference to a location that provides optimal signal-to-noise performance.

In cases of excessive intermittent wireless interference, such as machinery operation or construction activity, you should identify patterns of interference. This information may assist your service provider in helping you resolve a problem with interference.

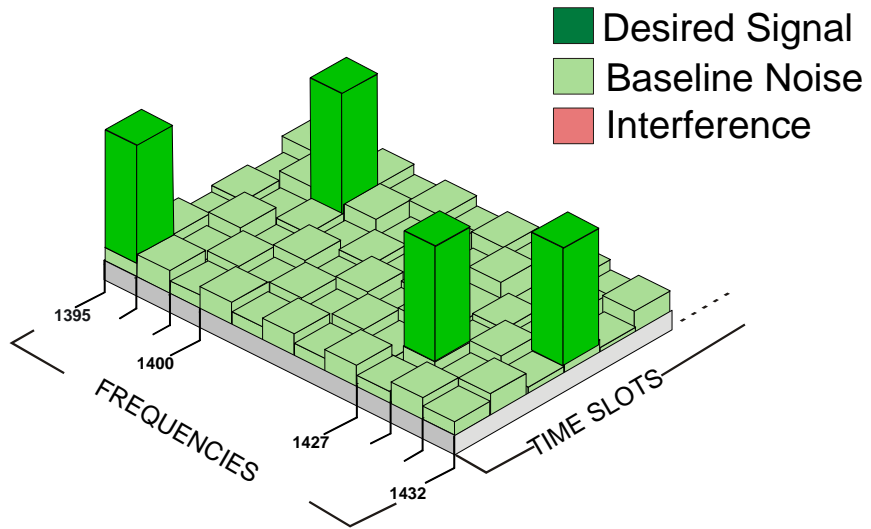

Normal Operation

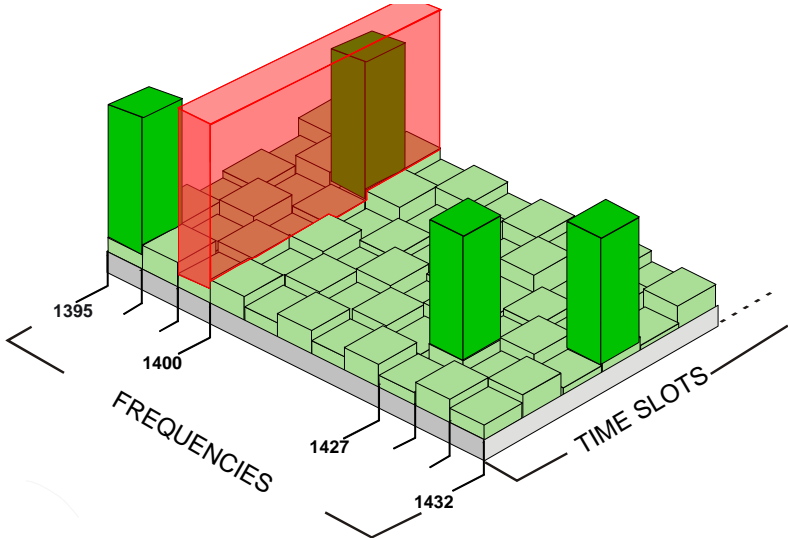

Excessive Interference

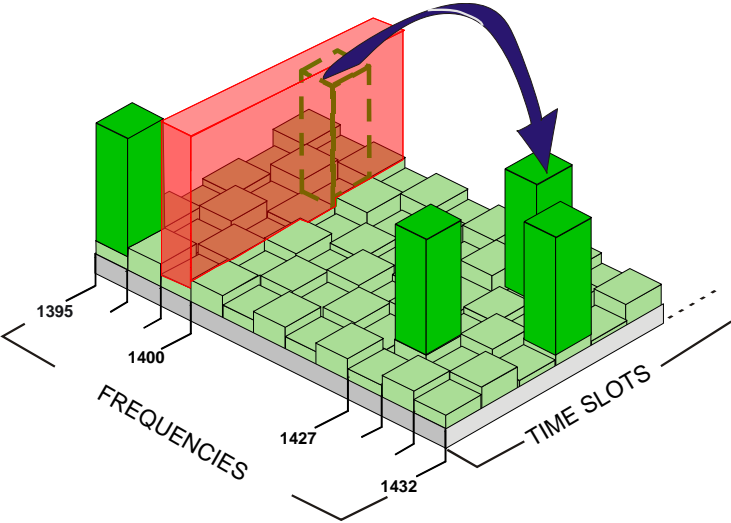

'Hop' to New Frequency/Time Slot

Spectrum Sharing

The ITS4840A IntelliVue Telemetry System operates in the Wireless Medical Telemetry Service bands (WMTS - USA only). WMTS uses radio frequency spectrum which was allocated by the FCC for medical telemetry applications, with a reduced potential for harmful interference. Although WMTS is managed by a frequency coordination process, this coordination and licensing does not grant the user an exclusive right to the spectrum on which their system operates, and is subject to the terms and conditions of the FCC license. Other WMTS and non-medical FCC licensees, as well as government agencies, may be legally authorized to use this licensed spectrum.

The ITS4850A IntelliVue Telemetry System operates in the 2.4 GHz ISM band, with up to six RF channels using a similar Smart-hopping technology as described on page 1-5. The system also scans the selected six RF channels to determine whether the spectrum is sufficiently clear. If the system is too congested, a system level alert is provided.

IntelliVue Clinical Network

The IntelliVue Clinical Network (ICN) is the communication infrastructure necessary to tie together all the patient monitoring systems within an organization. This includes getting information to and from the IntelliVue Information Center(s).

Patients can be monitored within the defined coverage areas. When a patient goes out of range, an auditory out-of-range indicator sounds at the transceiver, and a "No Signal" technical alarm at the Information Center notifies the clinical staff.

The Network can include both wired and wireless devices. An installation typically includes the following components:

- IntelliVue Clinical Network infrastructure.
- TRx4841A/TRx4851A Transceivers, bi-directional patient-worn devices.

- ITS4842A/ITS4852A/ITS4853A Access Points (AP), placed within the areas with defined coverage. APs are centers for bidirectional communication between the transceivers and the Information Center.
- M3150B IntelliVue Information Center for centralized monitoring.
- M3154A IntelliVue Database Server (optional) for centralized data management.
- M2636C TeleMon Companion Monitor (optional) for local alarms, NBP measurement, and bedside display of patient data.
- M8105A MP5, M8102A MP2, and M3002A X2 IntelliVue Patient Monitors (optional) for bedside display of patient data being sourced from the transceiver.

Transceiver Use with Other Equipment

IntelliVue Information Center

The transceiver's bi-directional capability enables remote control from the Information Center for alarm, setup, and general monitoring functions. In addition, the system supports Telemetry Overview, the pairing of a telemetry bed with an IntelliVue Patient Monitor for bedside ECG viewing of a single patient. Telemetry Overview provides the telemetry-monitored waveforms, numerics, and alarms in an integrated form both on the bedside monitor and at the IntelliVue Information Center. See "Chapter 10. Pairing Monitoring Devices" for operating and configuration information.

TeleMon

The transceiver can employ the full functionality of the M2636C TeleMon Companion Monitor, including NBP measurement and local display of alarms. Connection is made through an interface cable at the Monitor/Service port on the transceiver. Please refer to "Transceiver Operation when Connected to TeleMon" on page 9-19 for an operational summary, and the *M2636C TeleMon Instructions for Use* for general operating instructions.

Transceiver Use with Other Equipment

Patient Bedside Monitors

Remote control of monitoring parameters such as NBP, SpO₂, Alarm Suspend, and Relearn, as well as limited overview of waves and data are supported through Patient Bedside Monitors equipped with IntelliVue Instrument Telemetry. Please refer to the *Instructions for Use* for the specific Patient Monitor for operating information.

Patient Data can be sourced directly from the transceiver to MP5/MP5T, MP2 or X2 Patient Monitors. The connection is made through a monitor interface cable (MP5/MP5T only) or short range radio adapter (SRRRA) inserted in the transceiver's Monitor/Service port and connected to the monitor. Non-networked IntelliVue patient monitors equipped with short-range radio capability can source patient data that includes SpO₂, NBP and predictive temperature measurements to the Information Center. Please refer to the *IntelliVue Patient Monitor Instructions for Use* for additional information.

M2601B Transmitters

If your hospital uses TRx and/or TRx⁺ Transceivers and M2601B Transmitters, you can distinguish between them by:

- Name on the front of the device (TRx or M2601B)
- Label color (light gray for transceivers, dark gray for transmitters)

Product Safety

This chapter consolidates the safety warnings that apply to use of the IntelliVue Transceivers in a IntelliVue Clinical Network. These warnings are repeated throughout the book in context where relevant. The chapter includes the following section:

- General Safety 2-2

General Safety

Warning

The IntelliVue Telemetry System should not be used for primary monitoring in applications where the momentary loss of the ECG is unacceptable.

Warning

For continued safe use of this equipment, it is necessary that the listed instructions are followed. Instructions in this manual in no way supersede established medical procedures.

Warning

Do not touch the patient, or table, or instruments, during defibrillation. The battery door must be closed during defibrillation. These steps protect the clinician from high defibrillator voltage.

Warning

This device is not to be used in the vicinity of electrosurgical units because such use may interrupt or interfere with the transmission of signals from the transceiver.

Warning

This equipment is not suitable for use in the presence of a flammable anesthetic mixture with air, or with oxygen or nitrous oxide

Warning

Do not use patient cables with detachable lead wires that have exposed male pins. Electrocution could result if these pins are plugged into AC power.

Warning

The system is not completely immune from radio interference although it is designed to minimize interference through smart hopping. Sources of interference that may be a problem include failing fluorescent lights and construction equipment. See “Electromagnetic Compatibility” on page 12-5.

Warning

The product should not be used next to or stacked with other equipment. If you must stack the product, you must check that normal operation is possible in the necessary configuration before the product is used on patients.

Warning

Do not rely exclusively on the audible alarm system for patient monitoring. Adjustment of alarm volume to a low level during patient monitoring may result in patient danger. Remember that the most reliable method of patient monitoring combines close personal surveillance with correct operation of monitoring equipment.

Warning

If the Alarms Suspend indicator on the transceiver remains illuminated after the button combination to unsuspend alarms is pressed, a transceiver malfunction may have occurred. (Alarms resume automatically after the configured alarm suspend duration, or you can resume them manually at the Information Center.) The transceiver should be replaced, and the malfunctioning unit should be sent to your service provider.

Warning

Place the transceiver in a pouch or over clothing, or both, during patient use. The transceiver should not touch the patient's skin during use.

Warning

To avoid the risk of strangulation, do not tie a pouch solely around the patient's neck.

Warning

Patients should be instructed not to open the battery compartment while the transceiver is in use.

Warning

Failure on the part of the responsible individual hospital or institution employing the use of this equipment to implement satisfactory maintenance as needed may cause undue equipment failure and possible health hazards.

Warning

Because the coverage range of Access Points can sometimes overlap, including different floor levels, the IntelliVue Device Location feature is not intended for use when attempting to locate a patient.

Warning

Short-range radio connections are subject to interruption due to interference from other radio sources in the vicinity, including microwaves, bluetooth devices, and DECT phones. Outside the frequency band and 5% above and below, i.e. the exclusion band according to IEC 60601-1-2, the short-range radio connection is immune up to 3V/m in the frequency range from 80MHz to 2.0 GHz and up to 1V/m in the frequency range from 2.0 to 2.3 GHz. Depending on the strength and duration of the interference, the interruption may occur for an extended period. Any interruption of the signal due to interference, moving out of range, or for other reasons is indicated with a Tele Disconnected INOP message.

Transceiver Controls

This chapter describes the clinical controls of the transceiver. These controls include buttons, visual and auditory indicators, ports, and safety labelling located on the front and back of the device. The chapter includes the following sections:

- Transceiver Controls - Front 3-2
 - Buttons 3-3
 - Power On/Off 3-4
 - Indicators 3-5
 - Labels 3-6
 - Ports 3-7
- Transceiver Controls - Back 3-8
 - Labels 3-9
 - Safety Symbols & Other Marks 3-9
- Audible Tones 3-12
 - Clinical Use 3-12
 - Adjustable Sounds 3-13
 - Service Sounds 3-14

Note—For the purpose of the following diagrams, the transceiver model shown is the TRx4851A with SpO₂.

Transceiver Controls - Front

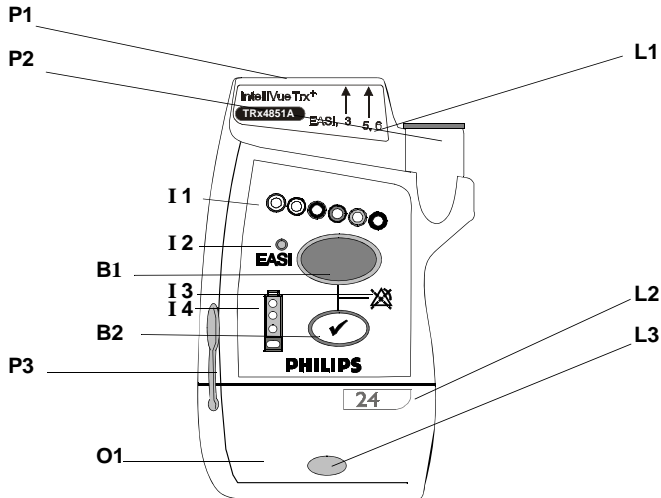



The labeled items in the diagram include:

- Buttons (B1-B2)
- Power On/Off (O1)
- Indicators (I1-I4)
- Labels (L1-L3)
- Ports (P1-P3)

IntelliVue TRx⁺ Transceiver - Front View

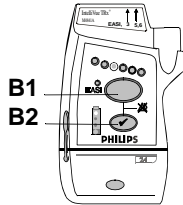
Buttons



Callout	Button	Definition
<p>B1</p>		<p>Telemetry Button</p> <ul style="list-style-type: none"> Depending on configuration, directs the Information Center to generate a Nurse Call alarm, remote recording, both Nurse Call alarm and recording, or none. See “Telemetry Functions at the Information Center” on page 9-2. <p><i>Note</i>—Delayed recordings generated by the Telemetry button are stored in Alarm Review at the Information Center.</p> <ul style="list-style-type: none"> When pressed simultaneously with the Check button, turns Alarm Suspend/Pause on/off (not when connected to TeleMon or networked IntelliVue MP5 Patient Monitor). See “Suspending/Pausing Alarms” on page 5-2.

Callout	Button	Definition
B2		<p>Check Button</p> <ul style="list-style-type: none"> • Initiates a Status Check of the transceiver. See “Status Check” on page 4-12. • Resumes monitoring after Standby. See “Standby Mode” on page 4-4 • Indicates association with the Information Center (single beep). See “Audible Tones” on page 3-12. • When pressed simultaneously with the Telemetry button, turns Alarm Suspend/ Pause on/off (if configured and not when connected to TeleMon or networked IntelliVue MP5 Patient Monitor). See “Suspending/Pausing Alarms” on page 5-2. • Silences the Find Device tone. See “Locating the Transceiver (Find Device)” on page 9-3. • Initiates the Short-Range Radio assignment. See “Chapter 10. Pairing Monitoring Devices” on page 10-1.

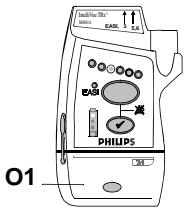

Power On/ Off

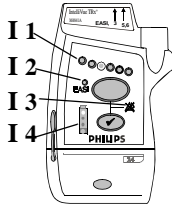

Callout	Battery Door to Access	Definition
O1	Power On/Off	<p>Power On/Off</p> <p>Insertion of batteries turns transceiver power on; removal of batteries turns power off. See “Turning the Transceiver On/Off” on page 4-2.</p>

Indicators



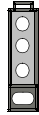

Callout	Indicator	Definition
I 1		<p>Lead Indicator</p> <ul style="list-style-type: none"> • Illuminates momentarily during leadset insertion to indicate attached leads. • Illuminates when Check button is pressed to indicate attached leads. • During a Leads Off condition, illuminates to indicate the lead(s) that need to be reapplied. Reference lead indicator only on indicates all leads are off. • Momentarily illuminates all lead indicator lights, indicating the transceiver has no Equipment Label assigned. Accompanied by “Unlabeled Device” tone. See “Label Assignment for Replacement Transceiver” on page 11-2. • Illuminates after successful Short-Range Radio assignment.
I 2		<p>EASI Indicator</p> <ul style="list-style-type: none"> • Illuminates momentarily upon insertion of leadset in EASI position. • Illuminates when Check button is pressed if EASI is in use.
I 3		<p>Alarms Suspend/Pause Indicator</p> <p>Illuminates during alarm pause period initiated at transceiver, Information Center, or TeleMon.</p>

Callout	Indicator	Definition
I 4		<p>Battery Gauge Illuminates when the Check button is pressed, indicating the amount of power remaining in the batteries. <i>Note</i>—Valid only for recommended battery type. See “Checking the Battery Power Level” on page 4-17.</p>

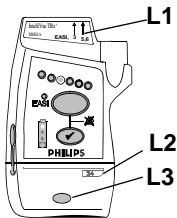
Labels

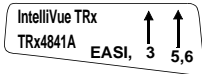

Callout	Label	Definition
L1		<p>Leadset Insertion Guide Assists in aligning the ECG cable for different leadsets. See “Connecting the ECG Cable” on page 6-21. <i>Note</i>—If your unit uses only one monitoring configuration, the transceiver may have special alignment guides that allow only one leadset insertion position. Warning—Alignment guides may present a choking hazard. Handle with appropriate care.</p>
L2		<p>Device Identification Label Identifies the device to the IntelliVue Clinical Network.</p>
L3		<p>Unit Identification Label Uses one of seven color-coded labels for visual identification of a clinical unit.</p>

Ports

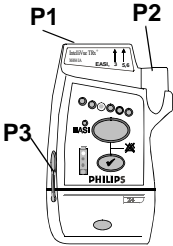

Callout	Definition
P1	ECG Leadset Port Connection for 3-, 5-, or 6-wire leadset.
P2	SpO₂ Sensor Port (IntelliVue TRx ⁺ only) Connection for SpO ₂ sensor. See Note.
P3	Monitor/Service Port Connection for the Short-Range Radio Adapter, the cable to the TeleMon Companion Monitor and MP5 IntelliVue Patient Monitor, or to the Service Tool. See Note.
<p><i>Note</i>—The SpO₂ and Monitor/Service ports can be covered with protective covers when not in use. These are listed in “Appendix A. Accessories”.</p> <p>Warning—The SpO₂ and Monitor/Service port protective covers may present a choking hazard. Handle with appropriate care.</p>	

Transceiver Controls - Back

S8-S14 not shown
(inside battery compartment)

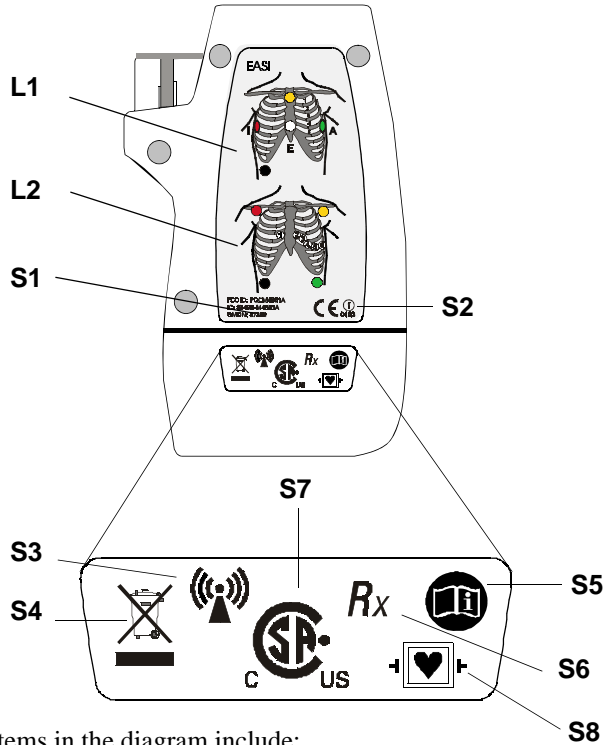

The labeled items in the diagram include:

- Labels (L1-L2)
- Safety symbols and other marks (S1-S14)

IntelliVue TRx+ Transceiver - Back View

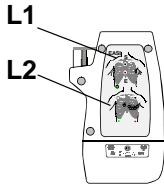

Labels





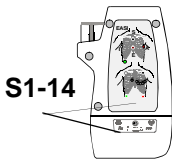



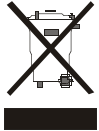



Callout	Definition
L1	Electrode Placement Diagram for EASI See “5-Wire Placement (EASI Mode)” on page 6-16.
L2	Electrode Placement Diagram for Standard ECG See “5-Wire Placement (Standard Mode)” on page 6-14.

Safety Symbols & Other Marks



Callout	Label	Definition
S1	FCC ID: PQCXXXXX IC: 3549B-XXXX	Federal Communications Commission (FCC) ID Canadian ID
S2		CE Mark Compliance to Council Directive 93/42/EEC (Medical Device Directive) Class 2 Radio Equipment Identifier (1999/5/EC)
S3		Non-Ionizing Radiation Interference to electronic equipment may occur in the vicinity of devices marked with this symbol.
S4		Disposal Dispose of in accordance with the local country’s requirements.

Callout	Label	Definition
S5		Follow operating instructions.
S6	Rx	Prescription Device
S7		Canadian and American standards compliance Complies with applicable Canadian and American standards.
S8		Defibrillation Proof Patient connections are protected against defibrillation (DEFIBRILLATION-PROOF) and are a TYPE CF APPLIED PART.
Labels on Inside of Battery Compartment		
S9		Catalog Number Use to identify the equipment during a call to the Philips Response Center.
S10		Serial Number Use to identify the equipment during a call to the Philips Response Center.

Callout	Label	Definition
S11		MAC Address of device
S12		Date of manufacture
S13		Battery Polarity
S14		Attention! See <i>Instructions for Use</i> .
Additional Labels on SRRA (optional)		
		CE Mark Compliance to Council Directive 1999/5/EC (Radio Equipment and Telecommunications Terminal Equipment Directive)
		Service Tag ID

Audible Tones

The transceiver produces seven different auditory information signals to inform you of measurement and transceiver conditions during normal use. Most are generated automatically.

Clinical Use

Auditory Information Signal	Sound	How Used
Sound 1	beep	<ul style="list-style-type: none"> • Indicates successful Self-Test at power on. • Indicates successful SpO₂ Spot Check measurement when measurement is initiated at the transceiver. • If the Check button is pressed, confirms that the transceiver is in contact with the Information Center (e.g., when transceiver is brought back into range).
Sound 2	low-pitch tone	<p>Indicates pulse detected during Spot Check SpO₂ measurement.</p> <p><i>Note</i>—The pulse tone can be muted from the Information Center. See “Patient Configurable Settings in Telemetry Setup” on page 9-6.</p>
Sound 3	alternating pitch repeated tone	<p>Continuous tone to help you locate a missing transceiver. Initiated by clicking Find Device in the Telemetry Setup window. Tone continues until Check button is pressed, batteries are removed, or batteries completely discharge.</p>

Auditory Information Signal	Sound	How Used
Sound 4	beep beep	<ul style="list-style-type: none"> • Indicates failed Self-Test at power on. • Indicates failed SpO₂ Spot Check measurement when measurement is initiated at the transceiver. • If it sounds when the Check button is pressed, it indicates that the transceiver is not in contact with the Information Center.
Sound 5	beep beep every 5 seconds	Indicates transceiver is out of range or not associated with a sector. Sound stops when contact is re-established with the Information Center, or it can be silenced by pressing the Check button for six seconds. Or in cases where the transceiver is not assigned to a sector at the Information Center but is assigned to a monitor via short-range radio or monitor interface cable, the transceiver is not in contact with the monitor.
Sound 6	beep every 2 seconds	Indicates that the leadset is not inserted correctly. Accompanied by Invalid Leadset INOP.
Sound 7	Fast beep beep and all Leads Off indicators briefly flashing at the same time	A new assignment has been established between the transceiver and monitor via short-range radio connection.

Adjustable Sounds

Some transceiver sounds can be set to 5 different volume levels (see “Patient Configurable Settings in Telemetry Setup” on page 9-6). The adjustable sounds include SpO₂ Spot Check measurement complete/fail, Check/Standby functions,

and pulse detection tone. The sounds can be turned off (muted) on a per patient basis in the Telemetry Setup window.

Auditory Signal (sound)	Function	How Used
Sound 1 (beep)	Spot Check	Announces a successful SpO ₂ Spot Check measurement.
Sound 1 (beep)	Check Button	Confirms contact with the Information Center.
Sound 2 (low pitch tone)	Pulse Detection Tone	Indicates pulse during SpO ₂ Spot Check measurement.

Service Sounds

Two additional sounds that you may hear occur during the labelling of transceiver devices within the IntelliVue Clinical Network. The volume of these sounds is not adjustable, and cannot be turned off. See “Label Assignment for Replacement Transceiver” on page 11-2.

Service Sound	Description
beep beep repeated every 3 seconds, and all visual indicators flashing	Unlabeled Device. Equipment Label needs to be assigned at Information Center. No monitoring.
Fast beep beep and alternate Leads Off indicators flashing	Unacknowledged Labeled Device. Equipment label has been assigned at Information Center; press the Check button to complete label assignment. No monitoring.

Basic Operation

This chapter describes the basic operation of the transceiver. It includes the following sections:

- Transceiver Safety Information 4-2
- Turning the Transceiver On/Off 4-2
- Briefing the Patient 4-6
- Testing Transceiver Functionality 4-11
- Battery Information 4-13

Transceiver Safety Information

Warning

The system is not completely immune from radio interference although it is designed to minimize interference through smart hopping. Sources of interference that may be a problem include failing fluorescent lights and construction equipment. See “Electromagnetic Compatibility” on page 12-5.

Warning

Place the transceiver in a pouch or over clothing, or both, during patient use. The transceiver should not touch the patient’s skin during use.

Turning the Transceiver On/Off

Warning

Arrhythmia relearning is initiated whenever the transceiver is powered down for one minute or longer. Be sure to check your patient’s arrhythmia annotation for accuracy whenever relearn has occurred.

Turning On

The transceiver is powered by two AA alkaline batteries. To turn the transceiver on, insert both batteries. When batteries are inserted:

1. All indicators illuminate briefly.
2. A sequence of sounds indicates the instrument is ready for use.
 - a. a single beep, indicating that the self test was passed.
 - b. a series of double beeps, indicating the transceiver is attempting to establish contact with the Information Center.
 - c. cessation of sounds, indicating a successful association with the Information Center.

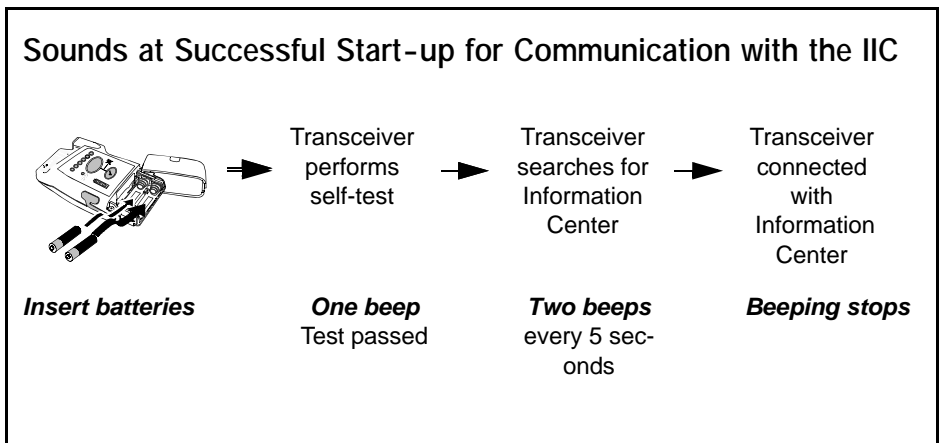

- d. If you hear any other sound sequence, either the device has failed the automatic Self-Test (in which case you should use a replacement device), or the device cannot establish contact with the Information Center (check that a sector has been assigned to the device, and that the device is within the coverage area).

Note—For sounds associated with the use of the Short-Range Radio Adapter, see “Service Sounds” on page 3-14.

Turning Off

Turn off the transceiver by removing the batteries. A "No Signal" technical alarm will be in effect at the Information Center until the device is reactivated or until Standby is initiated.

Turning the Transceiver On/Off

The configuration data set by the service provider prior to transceiver use is retained after battery removal.

RF Auto Shutoff

When RF Auto Shutoff is enabled (default), the transceiver stops broadcasting a radio signal in order to prevent interference with other transceivers in use. This condition occurs if there is no ECG signal for 10 minutes and the SpO₂ sensor cable is *not* inserted in the SpO₂ sensor port. The technical alarm, "No Signal", followed by the "Transmitter Off" INOP will be displayed at the Information Center. Remove the batteries to conserve battery charge. However, if there is no ECG signal for 10 minutes but the SpO₂ cable *is* inserted, the transceiver does not stop broadcasting the signal.

To restart monitoring, insert batteries (if needed), attach leads to the patient, insert the SpO₂ sensor cable in the SpO₂ sensor port and press the Check button to verify association with the Information Center.

Standby Mode

Standby mode is used to temporarily suspend monitoring at the Information Center, for example, when a patient goes out of access point range or is discharged.

Standby does not power down the transceiver, so if the standby period is prolonged, you should remove the batteries.

Initiating Standby

Step	Action
1	Do not remove the leads until after the patient is in Standby. This will avoid an "ECG Leads Off" technical alarm, as well as reminders, if configured.
2	In the Patient Window, select the Standby button.

Step	Action
3	<p>Select the duration of the standby period (depending on your system's configuration: Infinite, 4 Hours, 3 Hours, 2 Hours, 1 Hour, 30 Minutes, 20 Minutes, or 10 Minutes).</p> <p><i>Note</i>—If the patient will be discharged, select “Infinite” as the standby duration.</p>
4	<p>Select the appropriate location, then select Suspend Monitoring. The message “Telemetry Standby” and location, if selected, are displayed in the sector.</p> <p><i>Note</i>—If the transceiver is paired with an IntelliVue Patient Monitor, monitoring will be suspended at both the transceiver and the IntelliVue Patient Monitor as well as at the Information Center. The messages "Monitor Standby" and "Telemetry Standby" will be displayed in the patient sector. If paired directly with an IntelliVue MP5 Patient Monitor, the message "Monitor Standby" only will be displayed.</p>

Resuming Monitoring

Step	Action
1	<p>If the standby period has not expired:</p> <ul style="list-style-type: none">• Press the Check button to re-establish contact with the Information Center. The single beep at the transceiver verifies that monitoring has resumed.• If you hear a double beep, click Resume Monitoring at the Information Center. If there's still no association, contact the service provider. <p>If the standby period has expired:</p> <ul style="list-style-type: none">• Monitoring resumes automatically if the patient is in the coverage area. Press the Check button to verify the resumption of monitoring. You should hear a single beep. <p>If a new patient is connected:</p> <ul style="list-style-type: none">• Press the Check button, or select the Resume Monitoring in the appropriate patient sector. <p><i>Important</i>—When an EASI patient comes out of Standby, the lead settings are reset to the default EASI leads.</p>

Briefing the Patient

Warning

Patients should be instructed not to open the battery compartment while the transceiver is in use.

If the Telemetry button has been configured to generate a Nurse Call, recording at the Information Center, or both, instruct the patient to use the button when needed.

If desired, you can turn off patient use of the button at the Information Center. See “Patient Configurable Settings in Telemetry Setup” on page 9-6.

Pouch Use

The transceiver is not intended for direct contact with the patient’s skin. During normal use, the transceiver should be worn over clothing, in a pocket or, preferably, in a pouch. The carrying pouch with clear front is an appropriate means for holding the transceiver. See Appendix A, “Accessories” for ordering information.

Securing the Pouch

Step	Action
1	<p>Insert the transceiver into the pouch with lead wires and SpO₂ sensor cable, if used, exiting from the top opening of the pouch. Pinch the velcro enclosures together to close the pouch around the cables.</p> <div data-bbox="736 748 982 1117" data-label="Image"> <p>The illustration shows a hand pinching the top edge of a rectangular carrying pouch. The pouch has a clear front panel and a top opening. Inside the pouch, a transceiver device is visible. Several cables, including lead wires and an SpO₂ sensor cable, are shown exiting from the top opening of the pouch. The hand is shown from the side, with the thumb and index finger pinching the top edge of the pouch.</p> </div> <p><i>Important</i>—Do not coil the cables inside the pouch. They are part of the wireless system, and need to be freely exposed.</p>

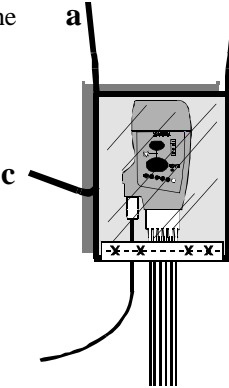
Step	Action
2	<p>Turn the pouch so that the opening is facing downward. This protects the transceiver from fluid and debris. Secure the pouch on the patient with the upper ties around the patient's head and arm and the lower ties around the patient's torso.</p> <hr/> <p>Warning</p> <hr/> <p>To avoid the risk of strangulation, do not tie a pouch solely around the patient's neck.</p> <hr/> <p>Place Tie a under the arm.</p>  <p>Place Tie b around the neck. Tie a and b together around the neck.</p> <p>Tie c and d together around the torso.</p>

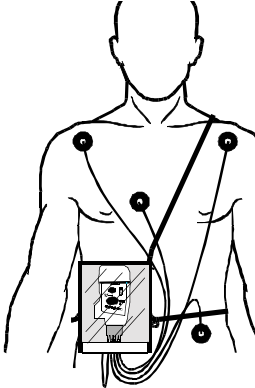
Step	Action
3	<p data-bbox="494 248 1150 305">Check that the patient is comfortable wearing the pouch with transceiver.</p>  <p data-bbox="740 310 995 695">A line drawing of a human torso from the neck to the waist. A rectangular pouch is worn around the waist. Several leads are connected to the pouch: one lead goes diagonally across the chest to the right shoulder, another goes diagonally across the chest to the left shoulder, a third goes vertically down the center of the chest, and a fourth goes horizontally across the lower chest. Each lead ends in a circular electrode. The pouch has a small window showing internal components.</p>

Showering

Warning

When the patient is showering, signal quality and leads off detection may be compromised due to significant movement. Appropriate clinical precautions must be taken.

The transceiver can be used to monitor a patient in the shower, but only when placed inside a Philips carrying pouch and secured on the patient as described above. The combination of the transceiver and pouch will withstand showering for up to 10 minutes.

Drying the Transceiver after Showering

After showering, perform the following steps to continue monitoring:

1. Pat dry the leadset connections at the electrodes.
2. Wipe the lead wires with care.
3. If wet, dry the outside of the transceiver with a non-lint producing cloth.
4. If wet, wipe dry the inside of the battery compartment. Dry the batteries.
5. If wet, disconnect the ECG leadset and shake out any water. Dry the connector pin area with a cotton swab.

6. If wet, allow the SpO₂ and Monitor/Service ports to air dry.

Note—The transceiver should not be used for monitoring if the battery compartment is wet. Remove the batteries and wipe the compartment dry before continued monitoring use.

Accidental Wetting

If the transceiver is accidentally immersed in liquid for up to 5 minutes, no damage to the device and no electrical safety issues for the patient will result. Remove the device, dry it off, and follow the procedure for cleaning/sterilization under “Cleaning and Sterilization” on page 11-4 as needed.

Testing Transceiver Functionality

There are two tests of IntelliVue Transceiver functionality:

- **Self Test** - performed automatically each time the transceiver is turned on.
- **Status Check** - initiated manually by the clinician.

Self Test

Warning

Do not use the transceiver for patient monitoring if it fails the Power On Self Test.

Caution

Do not insert a leadset during a self-test. The leadset can be inserted after the self-test.

A self test of the transceiver functions is automatically performed each time that the transceiver is turned on (that is, when batteries are inserted). This test should be performed before ECG leads and/or an SpO₂ sensor is attached.

Self Test Status	Auditory Signal	Visual Indicators
Passed	beep	All indicators illuminate for 3 seconds.
Failed	beep beep	One or more indicators do not light up.

In Case of Failure

If any portion of the self test fails, the transceiver will attempt to report the failure to the monitoring system. In case of failure, use another transceiver, and contact your service provider.

Status Check

You can check the status of the transceiver indicators at any time.

Initiating a Status Check

Step	Action
1	<p>Press the Check button.</p> <p>The following indicators should illuminate for as long as the Check button is depressed.</p> <ul style="list-style-type: none"> • Battery gauge • Leads Off indicators • EASI (if in use)
2	<p>If one or more of the expected indicators do not light up, check the following:</p> <ul style="list-style-type: none"> • Power and position of batteries (see “Checking the Battery Power Level” on page 4-17). • Leadset insertion. Make sure the leadset is correctly inserted in the transceiver and the colored line at the base of the cable is not visible (see “Connecting the ECG Cable” on page 6-21). • Lead positions and connections (see “Verifying Electrode Connections” on page 6-25). <p>If there is still a problem, contact your service provider for assistance.</p>

Battery Information

Battery Safety Information

Warning

The battery door must be closed during defibrillation.

Warning

Use Duracell Alkaline batteries, size AA, MN 1500, 1.5V, to ensure specified performance. Outdated, mismatched, or poor-quality batteries can give unacceptable performance (e.g., insufficient Battery-Low warning time). The use of fresh high-quality alkaline batteries is strongly recommended.

Warning

Certain failure conditions, such as short circuits, can cause a battery to overheat during use. High temperatures can cause burns to the patient and/or user. If the transceiver becomes hot to the touch, place it aside until it cools. Then remove the batteries and discard them. Have the transceiver operation checked by your service provider to identify the cause of overheating.

Warning

If you receive a BATTERY LOW alarm, the batteries must be promptly replaced. A “Battery Low” condition that is not corrected will result in a transceiver shutdown and cessation of monitoring.

Warning

Batteries should be removed from the transceiver at the end of the battery's useful life to prevent leakage.

If battery leakage should occur, use caution in removing the battery. The leaked substance may cause eye or skin irritation. Avoid contact with skin. Clean the battery compartment according to instructions in "Chapter 11. Maintenance, Cleaning & Troubleshooting". Wash hands.

Inserting/ Removing Batteries

Warning

Arrhythmia relearning is initiated whenever the transceiver is powered down for one minute or longer. Be sure to check your patient's arrhythmia annotation for accuracy whenever relearn has occurred.

Caution

Remove the batteries before storing a transceiver for an extended period of time.

The battery compartment is located at the bottom of the transceiver behind a swinging door. It accommodates a pair of AA 1.5V Alkaline batteries. Only this type of disposable battery should be used.

Important—Do not use rechargeable batteries. Use of this type of battery will adversely affect:

- Battery gauge performance
- Battery low warnings
- Battery life performance

Inserting the Batteries

Insert batteries into the transceiver using the following procedure.

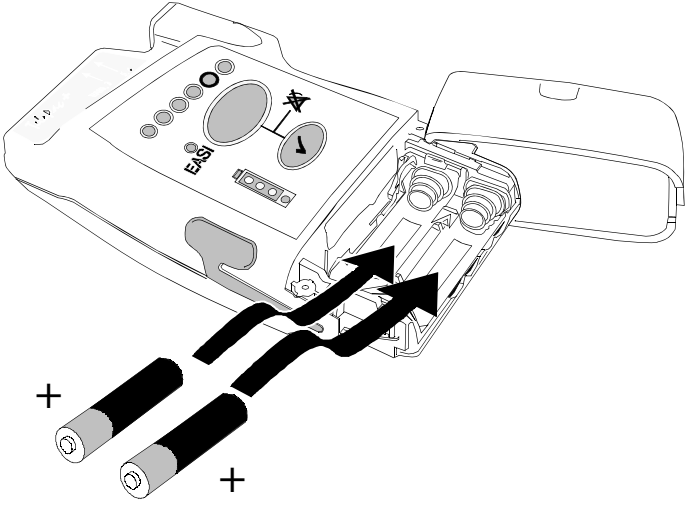
Step	Action
1	Open the battery compartment by swinging the compartment door 90° counterclockwise into an open hinged position.
2	<p>Insert two AA 1.5V Alkaline batteries, matching the polarity with the +/- indications inside the compartment.</p>  <p><i>Note</i>— Both batteries are inserted with the + polarity in the same direction.</p>
3	Close the battery compartment door.
4	<p>Listen for the start-up sounds. (See “Turning On” on page 4-3).</p> <p>Watch for the indicators on the front of the transceiver to illuminate briefly.</p>
5	Connect the patient cables to the transceiver.

Removing the Batteries

To remove the batteries, open the battery compartment door and push from the opening at the back of the compartment to pop the batteries out. Transceiver settings (ECG leadset type, SpO₂ mode, volume, etc.) are retained indefinitely when the batteries are removed.

If you remove good batteries to turn off the transceiver, keep them together as a set for later re-use so that both batteries will have the same level of power remaining.

Batteries should be removed when the transceiver is not in use or is being stored.

Important—DO NOT “STORE” BATTERIES BY LEAVING THEM IN THE INCORRECT POLARITY POSITION IN THE TRANSCEIVER.

Be careful not to short circuit the batteries. Batteries can get hot when shorted. Short circuits are caused when a piece of metal touches both the positive and negative terminals simultaneously. More than a momentary short circuit will generally reduce the battery life. In case of a short circuit, discard both batteries in a pair, or just the shorted one if the batteries are new.

Disposal of Batteries

When disposing of batteries, follow local laws for proper disposal. Dispose of batteries in approved containers. If local regulations require you to recycle batteries, recycle batteries in accordance with those regulations.

Checking the Battery Power Level

When the Check button is pressed, the battery gauge on the transceiver indicates the battery power level. It is reliable only when specified batteries (i.e., AA 1.5V Alkaline) are used. The battery gauge is also displayed in the Patient Sector at the Information Center (if configured) to enable you to closely monitor battery status, for example, after a change of shift.

To check the power level of the transceiver:

Step	Action
1	If connected, disconnect the transceiver from Telemon or MP5.
1	Press the Check button to determine the level (see Battery Levels following).
2	<p>If no indicators flash:</p> <ol style="list-style-type: none"> 1. Check that the batteries are inserted properly. 2. Replace both batteries. 3. If there are still no indicators on the battery gauge, contact your service provider. <p>If the indicators illuminate but do not behave as described above, the transceiver has malfunctioned. Contact your service provider.</p>

Battery Levels

Battery Gauge	Approximate Battery Life* Remaining	Approximate Operating Time* Remaining	Functionality
4 green indicators	> 75%	> 34.7 hours	Normal operation
3 green indicators	> 50%	> 23.1 hours	Normal operation
2 green indicators	> 25%	> 11.6 hours	Normal operation
1 green indicator	25% to Battery Low level	> 15 minutes	Normal operation
1 red indicator	Battery Low level to Replace Battery level	< 15 minutes	Normal operation (see note)
no indicator	Replace Battery level (Check batteries for correct polarity)	none	Transceiver shutdown/RF shutoff
<p>* Battery life times are based on use of Duracell MN 1500 batteries in a TRx transceiver not equipped with a Short-Range Radio Adapter. Times for TRx⁺ are somewhat lower. Life times when other battery brands are used may be different.</p> <p><i>Note</i>—For the TRx⁺ transceiver, SpO₂ functionality is disabled when the red light (Battery Low) is lit.</p>			

Battery Life Battery life is dependent upon:

- Condition of the batteries.
- Parameters being monitored - ECG only, ECG and Spot Check SpO₂, or ECG and Continuous SpO₂.
- Use of the Short Range Radio Adapter (SRRA). The transceiver's batteries power the SRRA, and under normal operating conditions, battery life may be reduced by up to 25%. See "Battery Specifications" on page 12-8

You can optimize battery life by:

- Removing the batteries when the transceiver is not in use. Keep them paired for future use.
- Disconnecting the SpO₂ adapter cable, if used. When the SpO₂ sensor is disconnected, the SpO₂ functionality is automatically powered down, but if an adapter cable is still connected, it will continue to drain power from the SpO₂ electronics.

Battery Information

5 Alarms

This chapter lists Physiologic (Patient) Alarms and Technical (Inoperative Condition) Alarms. It also describes how to pause/suspend alarms temporarily. It includes the following sections:

- Alarm Indicators 5-2
- Suspending/Pausing Alarms 5-2
- Physiologic Alarms. 5-4
- Technical Alarms (INOPs) 5-10

Alarm Indicators

A description of visual and auditory information signals for patient and technical alarms on the Information Center is located in the *IntelliVue Information Center Instructions for Use* and the *Information Center Online Help*. The Information Center documentation also includes the default alarm settings and physiological alarm limit ranges. Alarm behavior specific to the use of the transceiver paired with an IntelliVue Patient Monitor is described in “Chapter 10. Pairing Monitoring Devices”.

Testing Alarm Indicators

The visual alarm information signal on the transceiver is the Alarms Suspend icon. During self test, the Alarm Suspend indicator illuminates briefly, and a single tone indicates association with the Information Center. These positive test results indicate that the Alarm Suspend icon on the transceiver is functioning correctly (see “Self Test” on page 4-11).

Suspending/Pausing Alarms

Warning

If the Alarms Suspend indicator on the transceiver remains illuminated after the button combination to unsuspend alarms is pressed, a transceiver malfunction may have occurred. (Alarms resume automatically after the configured suspend duration time, or you can resume them manually at the Information Center.) The transceiver should be replaced, and the malfunctioning unit should be sent to your service provider.

All alarms for a patient can be suspended/paused from the Information Center, from the TeleMon Companion Monitor, or, depending on transceiver configuration, from the transceiver itself. The Alarm Suspend/Pause duration is configurable with a default of two minutes. Alarms automatically resume after the configured suspend duration time, or can be reactivated manually earlier.

If the transceiver is connected to TeleMon or the MP5 IntelliVue Patient Monitor, alarms can be suspended only from TeleMon or the IntelliVue Patient Monitor, and not from the Information Center. The Alarms Suspend icon on the transceiver is lit (see “Transceiver Controls - Front” on page 3-2), and an "Alarms Suspended" message appears at TeleMon, the patient monitor and the Information Center. Patient monitoring (display of patient waveforms and numerics) continues for the duration of Alarm Suspend/Pause.

Step	Action
1	<p>Press the Telemetry and Check buttons simultaneously to activate Alarm Suspend/Pause.</p> <p>While alarms are suspended:</p> <ul style="list-style-type: none"> • The transceiver illuminates the Alarms Suspend icon. <div style="text-align: center;">  </div> <ul style="list-style-type: none"> • The message "Alarms Suspended" (or "Alarms Paused") is displayed in the Patient Sector at the Information Center. <i>Note</i>—For paired bedsides in Telemetry Overview, the message is "Tele Alarms Suspend".
2	<p>For instructions on how to suspend/pause alarms from the Information Center, see the <i>IntelliVue Information Center Instructions for Use</i> and the <i>Information Center Online Help</i>.</p> <p>For instructions on how to suspend/pause alarms from TeleMon or the MP5, see their respective <i>Instructions for Use</i>.</p>

Unsuspending & Resuming Alarms

Alarms will be resumed automatically after the configured suspend duration time. You can cancel alarm suspend manually before the configured suspend duration time has expired from the transceiver (see following directions) or from the Information Center.

Step	Action
1	<p>Press the Telemetry and Check buttons simultaneously until the indicator turns off.</p> <ul style="list-style-type: none">• The Alarm Suspend icon is turned off.• The message "Alarms Suspended" (or "Alarms Paused") is removed from the Information Center display.
2	<p>Alternately, you can unsuspend alarms at the Information Center. See <i>IntelliVue Information Center Instructions for Use</i> or <i>Online Help</i> for directions.</p> <p>For instructions on how to resume alarms from TeleMon, see the <i>TeleMon Instructions for Use</i>.</p>

Physiologic Alarms

Physiologic alarms indicate a life-threatening situation or a less urgent situation such as heart rate beyond limits. There are no physiologic alarm signals generated by the transceiver.

All physiologic alarms are generated at the IntelliVue Information Center, and all alarm signals must be acknowledged at the Information Center or an assigned IntelliVue Patient Monitor.

Warning

Do not rely exclusively on the audible alarm system for patient monitoring. Adjustment of alarm volume to a low level during patient monitoring may result in patient danger. Remember that the most reliable method of monitoring combines close personal surveillance with correct operation of monitoring equipment.

Arrhythmia alarm chaining and other aspects of alarm behavior, such as alarm levels, setting alarm limits, customizing arrhythmia alarm settings on a per patient basis, switching individual measurement alarms on/off, and reviewing alarm messages, are described in *IntelliVue Information Center Instructions for Use*.

There are two levels of arrhythmia analysis available at the Information Center: Basic and Enhanced. Enhanced analysis includes Basic alarms.

NBP alarms are listed in the *TeleMon Instructions for Use*, *IntelliVue Patient Monitor Instructions for Use*, and the *Information Center Online Help*.

In the following table, Red (***) alarms are listed alphabetically, followed by the Yellow (***) alarms, and the Yellow (*) arrhythmia alarms.

Physiologic (Patient) Alarms

Alarm Text	Priority	Condition	Source
*/** AFIB	Yellow	Atrial fibrillation waveform detected	ST/AR Enhanced Arrhythmia
***ASYSTOLE	Red	Asystole. No QRS for 4 consecutive seconds	ST/AR Basic & Enhanced Arrhythmia
*** BRADY yyy < xxx	Red	Extreme Bradycardia. Heart Rate (yyy) less than Extreme Brady limit (xxx)	ST/AR Basic & Enhanced Arrhythmia

Physiologic (Patient) Alarms

Alarm Text	Priority	Condition	Source
*** DESAT	Red	Very Low SpO ₂ Saturation. SpO ₂ value below Desaturation limit <i>Note</i> —Desat limit is set 10 points below low limit.	SpO ₂
*** TACHY yyy > xxx	Red	Extreme Tachycardia. Heart Rate (yyy) greater than Extreme Tachy limit	ST/AR Basic & Enhanced Arrhythmia
*** V-FIB/TACH	Red	Ventricular Fibrillation. Fibrillatory wave (sinusoidal wave between 2-10 Hz) for 4 consecutive seconds	ST/AR Basic & Enhanced Arrhythmia
*** V-TACH	Red	Ventricular Tachycardia. Consecutive PVCs greater than or equal to V-Tach Run limit <u>and</u> Heart Rate greater than V-Tach limit (xxx)	ST/AR Basic & Enhanced Arrhythmia
** MULTI ST Lx, Ly	Yellow	Two ST leads (Lx and Ly) exceed alarm limit elevation or depression for > 60 seconds (EASI mode or when selected).	ST/AR ST
* NURSE CALL	Yellow	The Telemetry button on the transceiver has been pressed (and the system is configured to alarm and the Telemetry button is on). Also initiated if the installation includes a paging system and the Information Center is configured for paging upon receipt of Nurse Call signal. <i>Note</i> —For IntelliVue Information Centers Release J and later, Nurse Call is a yellow, one star (*) alarm.	Initiated at transceiver or by paging subsystem

Physiologic (Patient) Alarms

Alarm Text	Priority	Condition	Source
** SpO ₂ T yyy > xxx	Yellow	High SpO ₂ . SpO ₂ value (yyy) greater than high SpO ₂ limit (xxx).	SpO ₂
** SpO ₂ T yyy < xxx	Yellow	Low SpO ₂ . SpO ₂ value (yyy) less than low SpO ₂ limit (xxx).	SpO ₂
** ST lead > xxx	Yellow	STlead is greater than the Elevation limit.	ST/AR
** ST lead < xxx	Yellow	STlead is less than the Depression limit.	ST/AR
* HR yyy > xxx	Yellow	Heart Rate (yyy) greater than the upper Heart rate limit (xxx).	ST/AR Basic & Enhanced Arrhythmia
* HR yyy < xxx	Yellow	Heart Rate (yyy) lower than the lower Heart Rate limit (xxx).	ST/AR Basic & Enhanced Arrhythmia
* IRREGULAR HR	Yellow	Consistently irregular rhythm (irregular R-R intervals).	ST/AR Enhanced Arrhythmia
* MISSED BEAT	Yellow	No beat detected for 1.75 x average R-R interval for Heart Rate greater than 120, or no beat for 1 second with Heart Rate greater than 120 (non-paced patient only).	ST/AR Enhanced Arrhythmia
* MULTIFORM PVCs	Yellow	The occurrence of two differently shaped Vs, each occurring at least twice within the last 300 beats as well as each occurring at least once within the last 60 beats.	ST/AR Enhanced Arrhythmia

Physiologic (Patient) Alarms

Alarm Text	Priority	Condition	Source
* NON-SUSTAIN VT	Yellow	A run of Vs having a ventricular Heart Rate greater than V-Tach limit but lasting for less than the V-Tach Run limit.	ST/AR Enhanced Arrhythmia
* PACER NOT CAPT	Yellow	No QRS for 1.75 x the average R-R interval with Pace Pulse (paced patient only).	ST/AR Basic & Enhanced Arrhythmia
* PACER NOT PACE	Yellow	No QRS and Pace Pulse for 1.75 x the average R-R interval (paced patient only).	ST/AR Basic & Enhanced Arrhythmia
* PAIR PVCs	Yellow	Two consecutive PVCs between non-PVCs.	ST/AR Enhanced Arrhythmia
* PAUSE	Yellow	No QRS detected for x seconds. Choices of >1.5 to 2.5 seconds.	ST/AR Enhanced Arrhythmia
* PVCs >xxx/MIN	Yellow	PVCs within one minute exceed by the PVCs/min limit (xxx).	ST/AR Basic & Enhanced Arrhythmia
** QTc High	Yellow	QTc value has exceeded the QTc High limit for more than 10 minutes	ST/AR Arrhythmia
**dQTc High	Yellow	dQTc High value has exceeded the dQTc High Limit for more than 10 minutes.	ST/AR Arrhythmia

Physiologic (Patient) Alarms

Alarm Text	Priority	Condition	Source
* R-ON-T PVCs	Yellow	For Heart Rate less than 100, a PVC with R-R interval less than 1/3 the average interval followed by a compensatory pause of 1.25 x average R-R interval, or 2 such Vs without a compensatory pause occurring within 5 minutes of each other. (When Heart Rate is greater than 100, 1/3 R-R interval is too short for detection.)	ST/AR Enhanced Arrhythmia
* RUN PVCs	Yellow	Run of PVCs greater than or equal to 2.	ST/AR Enhanced Arrhythmia
* SVT	Yellow	Run of SVPBs greater than or equal to SVT Run limit and with SVT Heart Rate greater than the SVT Heart Rate limit.	ST/AR Enhanced Arrhythmia
* VENT BIGEMINY	Yellow	A dominant rhythm of N, V, N, V (where N= supraventricular beat, V=ventricular beat).	ST/AR Enhanced Arrhythmia
* VENT RHYTHM	Yellow	A dominant rhythm of adjacent Vs greater than Vent Rhythm limit and ventricular Heart Rate less than V-Tach limit.	ST/AR Enhanced Arrhythmia
* VENT TRIGEMINY	Yellow	A dominant rhythm of N, N, V, N, N, V (where N=supraventricular beat, V=ventricular beat).	ST/AR Enhanced Arrhythmia

Technical Alarms (INOPs)

Technical Alarms, or INOPs (inoperative conditions), are sourced at the transceiver, the ST/AR algorithm running at the Information Center, the TeleMon Companion Monitor, or the IntelliVue Patient Monitor. They identify inoperative conditions (that is conditions where the system is not operating properly and therefore cannot measure or detect alarm conditions reliably). There are four levels of Technical Alarms:

- **Severe** - Monitoring and alarms disabled. Audible tone at the Information Center. Must be acknowledged by a clinician.
- **Hard** - Monitoring and alarms are disabled. Audible tone at the Information Center.
If the hard INOP is "latched", the sound will be silenced, but the message will remain on the display until resolution of the offending condition.
- **Soft** - Monitoring and alarms remain active. No audible tones are generated.
- **Red/Yellow** - Replace Battery and ECG Leads Off INOPs may be configured to display as either Red or Yellow Technical Alarms.

In the following table, technical alarms are listed alphabetically.

Technical Alarms (Inoperative Conditions)

Alarm Text	Priority	Condition	What to do
BATTERY LOW BATTERY LOW T Source - Telemetry	Soft	When operating wirelessly, the patient monitor is no longer providing power to the transceiver, and battery capacity is diminished.	There is less than 15 minutes of monitoring time remaining. Replace batteries promptly to avoid transceiver shutdown and cessation of monitoring.
CANNOT ANALYZE ECG Source - Information Center	Hard	Arrhythmia algorithm cannot reliably analyze the ECG data on any monitored leads.	Assess the lead selections, initiate relearn, and validate analyzed rhythm. Check other INOPs for possible source of problem.
CANNOT ANALYZE QT Source - Information Center	Soft	There have been two consecutive invalid 5 minute values.	See “Limitations for QT Monitoring” on page 7-23.
CANNOT ANALYZE ST Source - Information Center	Soft	ST algorithm cannot reliably generate any valid ST values on any monitored lead.	Review the ECG signal quality and correct if necessary. Reposition the ISO and J points. <i>Note</i> —If the patient has a ventricular pacemaker, ST analysis is not possible.

Technical Alarms (Inoperative Conditions)

Alarm Text	Priority	Condition	What to do
<p>CENTRAL: TELE ONLY</p> <p>Source - Patient Monitor</p>	Hard	System connectivity via the transceiver is limited (no alarms, only local numerics) when in companion mode and host monitor does not have system connectivity. Only the transceiver’s measurements and alarms can be displayed at the Information Center.	If the disconnection of the host monitor is not intentional, re-connect the monitor to the network.
<p>CHECK ECG SETTINGS</p> <p>Source - Telemetry</p>	Hard	Synchronization of ECG settings between the monitor and the Information Center has failed.	<p>Check that the ECG settings from the ECG source are appropriate.</p> <p><i>Note</i>—When transitioning between networked and non-networked monitoring, this INOP will display. Pressing the Silence button will dismiss the INOP.</p>
<p>CHECK ECG SOURCE</p> <p>Source - Patient Monitor</p>	Yellow Technical Alarm	The transceiver and the monitor both have valid ECG signals.	Unpair the transceiver and monitor or remove the leadset from the device that is no longer the ECG source.

Technical Alarms (Inoperative Conditions)

Alarm Text	Priority	Condition	What to do
<p>CHECK PAIRING</p> <p>Source - Telemetry</p>	<p>Yellow Technical Alarm</p>	<ul style="list-style-type: none"> • There is a problem with device pairing. • When the transceiver is wirelessly paired with an X2 patient monitor (no label) docked with a larger networked MP series monitor, and the network connection is lost. 	<ul style="list-style-type: none"> • Check that the bedside monitor and telemetry device are correctly paired. • Select the correct device to be paired.
<p>CHECK SpO₂T Settings</p> <p>Source - Telemetry</p>	<p>Hard</p>	<p>Synchronization of SpO₂T settings between the monitor and the Information Center has failed.</p>	<p>Check that the SpO₂T settings in use at the Information Center are appropriate.</p>
<p>ECG EQUIP MALF ECG EQUIP MALF T</p> <p>Source - Telemetry</p>	<p>Hard</p>	<p>Failure of the ECG equipment or failure to calibrate ECG.</p>	<ul style="list-style-type: none"> • Remove leadset. Remove and re-insert batteries. Let Self-Test complete before reinserting leadset. • Replace the transceiver. • Contact Service.

Technical Alarms (Inoperative Conditions)

Alarm Text	Priority	Condition	What to do
<p>ECG LEADS OFF</p> <p><i>Note</i>—This INOP may also be configured to display as a Red or Yellow Technical Alarm.</p> <p>Source - Telemetry</p>	<p>Red or Yellow or Hard Technical Alarm</p>	<ul style="list-style-type: none"> • Multiple leads are off. • The short-range radio connection between the transceiver and the MP5, MP2, or X2 Patient Monitor has failed. 	<ul style="list-style-type: none"> • Re-attach ECG leads to patient. • Identify and remove the interference source. • Reduce the number of devices equipped with short-range radio capability. • Contact Service.
<p><electrode> LEAD OFF</p> <p>Source - Telemetry</p>	<p>Hard</p>	<p>Single lead is off.</p> <p><i>Note</i>—If primary lead is MCL, lead will be identified as V/C in INOP text.</p>	<p>Re-attach ECG lead to patient.</p>
<p>INVALID LEADSET</p> <p>Source - Telemetry</p>	<p>Hard</p>	<ul style="list-style-type: none"> • Wrong leadset. • Leadset inserted incorrectly. • Bad lead selection switches in the transceiver. 	<ul style="list-style-type: none"> • Check for appropriate leadset. • Check for correct insertion. • Contact Service.
<p>LEADSET UNPLUGGED</p> <p>Source - Telemetry</p>	<p>Hard</p>	<p>Leadset has been unplugged from the transceiver.</p>	<p>Re-insert the leadset.</p>

Technical Alarms (Inoperative Conditions)

Alarm Text	Priority	Condition	What to do
<p>MORE BED ALARMS <i>Note</i>—Appears at Information Center only. Source - Patient Monitor</p>	<p>Red or Yellow or Hard Technical Alarm</p>	<p>The monitor is associated with a transceiver and is sending data to the Information Center via the transceiver. There are currently more alarms at the bedside than can be transmitted to the Information Center.</p>	<ul style="list-style-type: none"> • For more information only. • Check for additional alarm conditions at the patient monitor.
<p>NO ARRHYTHMIA <i>Note</i>—This condition displays as All ARRH ALRMS OFF at the IIC. Source - Information Center</p>	<p>Soft</p>	<p>All basic ST/AR ECG alarms have been turned off.</p>	<p>Turn arrhythmia alarms on.</p>
<p>NO ECG AT CENTRAL Source - Patient Monitor</p>	<p>Hard</p>	<p>The ECG measured with the monitor is not being sent to the Information Center via the transceiver.</p>	<p>If not intended, insert the leadset in the transceiver. Check equipment connections and configuration settings.</p>
<p>NO ECG SOURCE Source - Telemetry</p>	<p>Hard</p>	<p>The transceiver is paired with a monitor but the Information Center is not detecting a valid ECG signal from either of them.</p>	<p>Attach leadset to patient. Check equipment connections and configuration settings.</p>

Technical Alarms (Inoperative Conditions)

Alarm Text	Priority	Condition	What to do
<p>NO SIGNAL</p> <p>Source - Information Center</p>	Hard	<ul style="list-style-type: none"> • Transceiver is outside the coverage area, or • No batteries in transceiver, or • Transceiver has failed, or • Short-range radio connection has failed. 	<ul style="list-style-type: none"> • Make sure that the transceiver is within the coverage area and has good batteries. • Replace the transceiver if Power On Self Test fails. • Put bed in Standby. • Identify and remove interference source. • Contact Service.
<p>OUT OF AREA</p> <p>Source - Information Center</p>	Hard	The transceiver is communicating with an access point designated as a boundary limit.	For more information only. If not intended, return the transceiver to the designated coverage area.
<p>REPLACE BATTERY REPLACE BATTERY T</p> <p><i>Note</i>—This INOP may also be configured to display as a Red or Yellow Technical Alarm.</p> <p>Source - Telemetry</p>	Red or Yellow or Hard Technical Alarm, Latched	<ul style="list-style-type: none"> • Dead battery. No monitoring is occurring. • When operating wirelessly, the patient monitor is no longer providing power to the transceiver, and battery capacity is now depleted. 	Replace batteries.
<p>SOME ECG ALRMS OFF</p> <p>Source - Information Center</p>	Soft	Some yellow arrhythmia alarms have been turned off for this patient.	For information only.

Technical Alarms (Inoperative Conditions)

Alarm Text	Priority	Condition	What to do
SpO ₂ T EQUIP MALF Source - Telemetry	Hard	Malfunction in the SpO ₂ equipment	Contact Service.
SpO ₂ T ERRATIC Source - Telemetry	Hard	Erratic SpO ₂ measurements, often due to a faulty sensor or invalid SpO ₂ measurements, or incorrect transducer position	Repeat measurement, reposition sensor on patient, or finally, replace sensor.
SpO ₂ T EXTD UPDATE Numeric is replaced by a -?-. Source - Telemetry	Soft	The update period of displayed values is extended due to an NBP measurement on the same limb or an excessively noisy signal.	If NBP is not active, check the sensor placement. Reposition the sensor on patient, or replace sensor.
SpO ₂ T INTERFERENCE Source - Telemetry	Hard	Level of ambient light or level of electrical interference are so high that the SpO ₂ sensor cannot measure SpO ₂ and pulse rate.	Reduce ambient light to sensor or electrical noise sources.
SpO ₂ T LOW PERFUSION Source - Telemetry	Soft	Accuracy may be reduced due to low perfusion. Data displayed with ?.	Increase perfusion. Change sensor site. Avoid site distal to BP cuff or intra-arterial line. Warm the site.
SpO ₂ T NO SENSOR <i>Note</i> —Silencing this technical alarm turns off the SpO ₂ measurement. Source - Telemetry	Hard	No sensor attached to SpO ₂ device	Attach SpO ₂ sensor.

Technical Alarms (Inoperative Conditions)

Alarm Text	Priority	Condition	What to do
<p>SpO₂T NOISY SIGNAL</p> <p>Source - Telemetry</p>	Hard	Excessive patient movements or electrical interference are causing irregular pulse patterns	Reduce movement or electrical noise sources.
<p>SpO₂T NON-PULSATILE</p> <p><i>Note</i>—When paired directly with an IntelliVue MP5 Patient Monitor, the INOP will display as SpO₂T SENSOR OFF.</p> <p>Source - Telemetry</p>	Hard	Pulse is too weak or not detectable	Check connection to patient. Change sensor site. Avoid site distal to BP cuff or intra-arterial line.
<p>SpO₂T SENSOR MALF</p> <p>Source - Telemetry</p>	Hard	Malfunction of the SpO ₂ sensor/adapter cable	Replace sensor.
<p>TAAP DISABLED</p> <p>Source - Patient Monitor</p>	Hard	The monitor’s telemetry configuration does not allow connection of the transceiver to the monitor.	Check configuration settings at the monitor. Contact Service.
<p>TELE CONFIG UNSUPPORTED</p> <p>Source - Patient Monitor</p>	Hard	Transceiver not supported (companion mode).	Make sure the transceiver is the correct revision. Contact Service.

Technical Alarms (Inoperative Conditions)

Alarm Text	Priority	Condition	What to do
<p>TELE DISCONNECTED</p> <p>Source - Telemetry</p>	<p>Red, Yellow or Hard Technical Alarm</p>	<ul style="list-style-type: none"> • The interface cable is not connected. • Short-range radio connection between the transceiver and the patient monitor has been lost. • There are too many short-range radios operating in the same vicinity (maximum of 4 per radio channel). 	<p>If the disconnection is not intentional:</p> <ul style="list-style-type: none"> • Re-connect the interface cable. • Identify and remove interference sources such as bluetooth devices, DECT phones, microwaves, etc. • Reduce the number of devices equipped with short-range radio capability.
<p>TELE INCOMPATIBLE</p> <p>Source - Patient Monitor</p>	<p>Hard</p>	<p>Transceivers and patient monitors equipped with short-range radio capability are not supported with this revision of the Information Center.</p>	<p>Contact Service. The Information Center needs to be upgraded to support this functionality. In the interim, disconnect the SRRA from the transceiver.</p>
<p>TELEMETRY STANDBY</p>	<p>Soft</p>	<p>Information Center standby mode timer is active, or patient was not returned to telemetry coverage area. There is no data from bed.</p>	<p>Cancelled when patient is removed from Standby.</p>
<p>TELE SYNC UNSUPP</p> <p>Source - Patient Monitor</p>	<p>Hard</p>	<p>Incompatible MMS</p>	<p>Contact Service. The MMS in use does not support synchronization of ECG and SpO₂ settings between the monitor and Information Center after a transceiver has been paired. The MMS must be revision E.00 or above.</p>

Technical Alarms (Inoperative Conditions)

Alarm Text	Priority	Condition	What to do
<p>TELE UNSUPPORTED</p> <p>Source - Patient Monitor</p>	Hard	The transceiver is not supported for direct connection to the monitor.	Contact Service. Make sure the transceiver is the correct revision.
<p>TELE WEAK SIGNAL</p> <p>Source - Telemetry</p>	Soft	<ul style="list-style-type: none"> • Patient is at outer range of the radio coverage area. • Telemetry pack is receiving a weak signal with high data loss from the AP. • Condition exists for multiple devices in a specific area 	<ul style="list-style-type: none"> • Return patient to the coverage area. • If patient is in close proximity to AP, replace telemetry pack. Contact service. • The AP covering the specific area is suspect. Contact Service.
<p>TRANSMITTER MALF</p> <p>Source - Telemetry</p>	Hard	Transceiver malfunction	Contact Service to replace the transceiver.
<p>TRANSMITTER OFF</p> <p>Source - Telemetry</p>	Hard	RF Auto Shutoff after 10 minutes of all leads off and no SpO ₂ sensor connected.	<ul style="list-style-type: none"> • Reattach ECG leads to patient. • Reattach SpO₂ sensor. • Press the Check button.

ECG Monitoring

This chapter covers the specifics of ECG measurement. It includes the following sections:

- ECG Safety Information 6-2
- Measuring ECG 6-4
- Positioning ECG Electrodes 6-10
- Connecting the ECG Cable. 6-21
- Verifying Electrode Connections 6-25
- Monitoring during Leads Off 6-27
- Optimizing ECG Measurement Performance. 6-29

ECG Safety Information

Warning

Always confirm Information Center observations with clinical observation of the patient before administering interventions.

Warning

Every lead must be secured to an electrode on the patient. Conductive parts of electrodes must not contact earth or other conductive parts.

Philips recommends that you change the lead label only to reflect the physical placement of electrodes. This will ensure a match between the monitored lead and the label, and prevent any possible confusion.

Warning

When switching from EASI to standard monitoring, there is a loss of data for 30 seconds.

Warning

EASI derived 12-lead ECGs and their measurements are approximations to conventional 12-lead ECGs. As the 12-lead ECG derived with EASI is not exactly identical to the 12-lead conventional ECG obtained from an electrocardiograph, it should not be used for diagnostic interpretations.

EASI lead placement is supported for adult patients only

For Paced Patients

Warning

The output power of the transceiver and other sources of radio frequency energy, when used in the proximity of a pacemaker, can be sufficient to interfere with pacemaker performance. Due to the shielding effects of the body, internal pacemakers are somewhat less vulnerable than external pacemakers. However, caution should be exercised when monitoring any paced patient.

In order to minimize the possibility of interference, position electrodes, electrode wires, and the transceiver as far away from the pacemaker as possible.

Consult the pacemaker manufacturer for information on the RF susceptibility of their products and the use of their products with the IntelliVue Telemetry System. See the *IntelliVue Information Center Instructions for Use* for additional information on monitoring paced patients.

Note—During defibrillation, monitoring may be temporarily interrupted or distorted. It may take several seconds for the ECG trace to reappear on the screen. After defibrillation, the device will continue to monitor as before; the device settings will not be affected.

Measuring ECG

The electrocardiogram (ECG) measures the electrical activity of the heart and displays it on the Information Center as a waveform and a numeric.

In order to compare measured ECG signals, the electrodes (or leadsets) are placed in standardized positions, forming so-called “leads”. To obtain ECG signals optimized for use in diagnosis and patient management in different care environments, different leadsets in varying lead placements are used. Both standard lead and EASI lead placements can be used with the transceiver.

ECG Configuration

The IntelliVue Transceiver supports 3-, 5-, and 6-wire leadsets. The 5-wire leadset can be used for either standard or EASI electrode configurations.

The transceiver leadset configuration choices are as follows:

- Leadset Mode = ALL (default)

This configuration allows you to switch the leadset type and position during use. The transceiver will automatically reconfigure itself accordingly.

- Leadset Mode = EASI ONLY

In this configuration only the use of the 5-wire leadset in the EASI position is allowed.

- Leadset Mode = NO EASI

In this configuration the use of 3- and 6-wire leadsets is allowed along with the use of the 5-wire leadset in the standard position only.

- Leadset Mode = 3 WIRE ONLY

In this configuration, only the use of the 3-wire leadset is allowed.

The transceiver detects the inserted leadset type and automatically determines the ECG measurement and transmitted leads. The Leadset Insertion Guide on the device will assist you in ensuring the correct measurement during transceiver usage. If the transceiver senses the insertion of a leadset not matching the current configuration, the transceiver will source the ECG per the leadset detected and issue an auditory signal to indicate the condition. An INVALID LEADSET INOP is generated at the Information Center.

Note—The labels and colors of the ECG electrodes differ according to the standards that apply for your hospital. The electrode placement references and illustrations in this chapter use the AAMI labels and colors. See the table below for additional label and color information.

Electrode Labels			Electrode Colors	
AAMI	EASI	IEC	AAMI	IEC
RA	I	R	White	Red
LA	S	L	Black	Yellow
LL	A	F	Red	Green
RL	N	N	Green	Black
V/Va	E	C/Ca	Brown	White
Vb		Cb	Brown/White	White/Red

There is no cardiotech within the transceiver; cardiotech analysis resides in the arrhythmia algorithm at the Information Center. Therefore, arrhythmia analysis is always turned on for telemetry patients. Arrhythmia analysis is either Basic or Enhanced, depending on the product configuration.

ECG Leads Monitored

Depending on the leadset connected to the transceiver, a different set of viewable leads are available at the Information Center. The transceiver can source up to four raw ECG waves.

If you are using ...	these leads can be selected at the Information Center
3-wire	I, II, III Sourced (raw) waves are received as: <ul style="list-style-type: none"> • Channel 1 = I, II, or III Default is II.
5-wire (Standard mode)	I, II, III, aVR, aVL, aVF, MCL and V Sourced (raw) waves are received as: <ul style="list-style-type: none"> • Channel 1 = II • Channel 2 = III • Channel 3 = MCL Defaults are II, V, III.

If you are using ...	these leads can be selected at the Information Center
5-wire (EASI mode)	<p>I, II, III, aVR, aVL, aVF, V1, V2, V3, V4, V5, V6</p> <p>In EASI mode, the sourced (raw) waves are received as:</p> <ul style="list-style-type: none"> • Channel 1 = Vector 1 (A-I) • Channel 2 = Vector 2 (A-S) • Channel 3 = Vector 3 (E-S) <p>Defaults are II, V2, III, V5.</p> <p><i>Note</i>—Arrhythmia monitoring is performed only on the primary and secondary leads selected at the Information Center, although you can view and perform ST analysis on all 12 EASI derived leads.</p>

If you are using ...	these leads can be selected at the Information Center
<p>6-wire (Vb is not supported on TeleMon.)</p>	<p>I, II, III, aVR, aVL, aVF, V1, V2, V3, V4, V5, V6, V7, V8, V9, V_{3R}, V_{4R}, V_{5R}.</p> <p>Sourced (raw) waves are received as:</p> <ul style="list-style-type: none"> • Channel 1 = II • Channel 2 = III • Channel 3 = Va • Channel 4 = Vb <p>Defaults are II, Va = V2, III, Vb = V5.</p> <p>The two chest leads, Va and Vb, can be placed on the patient in any of the V lead positions (V1 through V9, V3R, V4R, V5R). Lead assignment is available at the Information Center. When unassigned, the chest leads use the defaults.</p> <p><i>Note</i>—The lead label assigned to Vb cannot be selected for Va even though Vb does not appear to be used.</p> <p><i>Note</i>—When display of the pleth wave is enabled at the Information Center, the second chest lead (Vb) is not available for monitoring.</p>

Reconstructed Leads

Reconstruction of leads from the sourced wave is defined by the calculations in the following table. EASI reconstructed leads are a linear combination of all three raw EASI leads.

ECG Lead			Clinical Calculations in terms of electrodes
3-Wire	5-Wire Standard	6-Wire	
I	I	I	LA-RA
II (default)	II (default)	II (default)	LL-RA
III	III (default)	III (default)	LL-LA
-	MCL		V-LA, where V=C
-	aVR	aVR	RA-(LA+LL)/2
-	aVL	aVL	LA-(RA+LL)/2
-	aVF	aVF	LL-(LA+RA)/2
-	V (default)		V-(RA+LA+LL)/3, where V=C
		Va	Va-(RA+LA+LL)/3, where Va=V2 (default) position
		Vb	Vb-(RA+LA+LL)/3, where Vb =V5 (default) position

Positioning ECG Electrodes

Warning

Do not mix and match electrodes of different types. In particular, do not use electrodes of dissimilar metals. This helps ensure optimal signal quality.

Warning

Non-manufacturer supplied accessories and supplies can corrupt the performance of the equipment. Use only AAMI EC-12 compliant electrodes with this device. Use of electrodes that are non-compliant may provide erroneous results.

Caution

To protect the transceiver from damage during defibrillation, to ensure accurate ECG information, and to provide protection against signal noise and other interference, use only ECG electrodes and cables specified by Philips.

Correct lead placement is always important for accurate diagnosis. Especially in the precordial leads, which are close the heart, QRS morphology can be greatly altered if an electrode is moved away from its correct location. Each electrode is color-coded. Use the diagrams for 5-lead standard and EASI placement on the back of the transceiver and in this section for guidance. Additional lead placement information is available in the *Online Help* at the IntelliVue Information Center.

When placing electrodes on the patient, choose a flat, non-muscular site where the signal will not be impacted by either movement or bones.

Philips recommends that electrodes be changed every 24 hours.

In addition to correct positioning of the electrodes, optimal skin preparation prior to electrode placement will help ensure a clear signal for diagnosis.

Step	Action
1	<p>Prepare the patient's skin. Good electrode-to-skin contact is important for a good ECG signal, as the skin is a poor conductor of electricity.</p> <ul style="list-style-type: none"> • Select sites with intact skin, without impairment of any kind. • Clip or shave hair from the site as necessary. • Wash site with soap and water, leaving no soap residue. <i>Note--Philips does not recommend using ether or pure alcohol, because they dry the skin and increase the resistance.</i> • Dry thoroughly. • Use ECG skin preparation paper (abrasive) to remove dead skin cells and to improve the conductivity of the electrode site.
2	<p>Check electrodes for moist gel, and attach to the clips. If you are not using pre-gelled electrodes, apply electrode gel to the electrodes before placement.</p> <p><i>Note—Gel must be moist to provide a good signal.</i></p>
3	<p>Place the electrodes on the patient according to the lead placement you have chosen (see the electrode placement diagrams following). Place the edge down, then “roll down” the rest of the pad. Press firmly around the adhesive edge toward the center.</p>

Locating the Fourth Intercostal Space

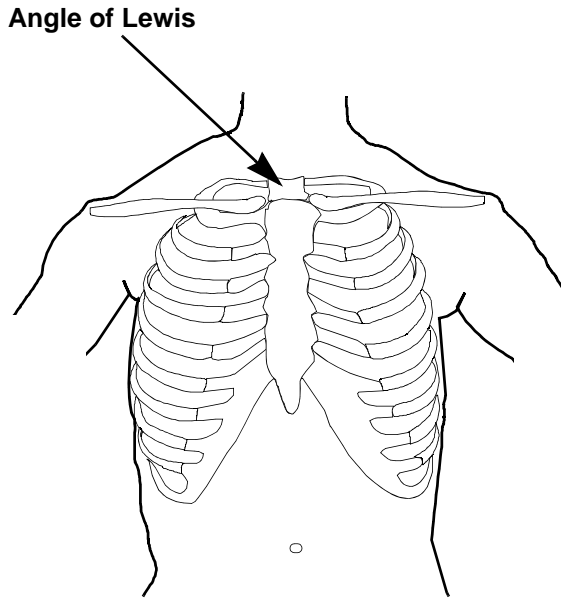

For accurate chest electrode placement and measurement, it is important to locate the fourth intercostal space. This can be done using the Angle of Lewis.

1. Locate the second intercostal space by first palpating the Angle of Lewis (the bony protuberance where the body of the sternum joins the manubrium). This rise in the sternum is where the second rib is attached, and the space just below this is the second intercostal space.
2. Palpate and count down the chest until you locate the fourth intercostal space.

3-Wire Placement

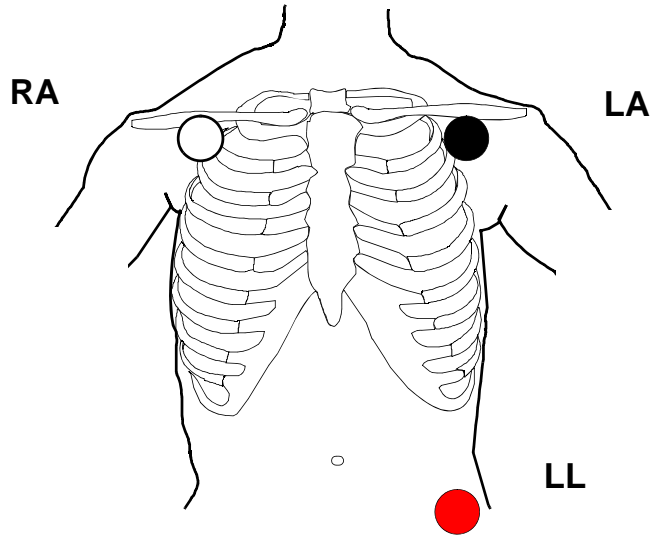

Lead	Placement
RA	directly below the clavicle and near the right shoulder
LA	directly below the clavicle and near the left shoulder
LL	on the left lower abdomen

5-Wire Placement (Standard Mode)

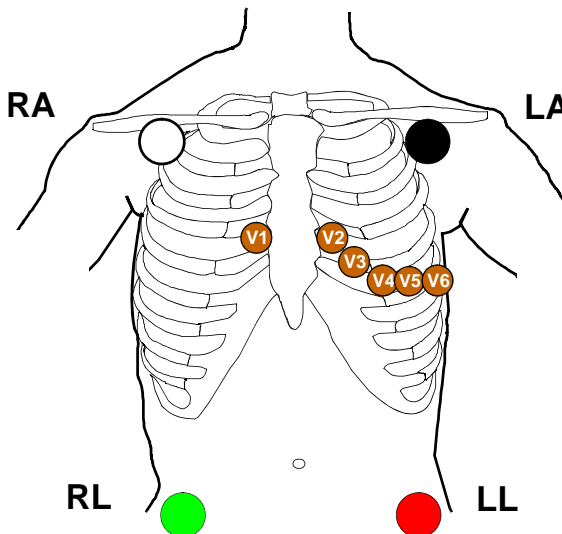

Lead	Placement
RA	directly below the clavicle and near the right shoulder
LA	directly below the clavicle and near the left shoulder
LL	on the left lower abdomen
RL	on the right lower abdomen
V	on the chest, the position depends on your required lead selection. The typical position is V1, although this may vary according based on your hospital's protocol.

Lead	Placement
V1	on the fourth intercostal space at the right sternal border
V2	on the fourth intercostal space at the left sternal border
V3	midway between the V2 and V4 electrode positions
V4	on the fifth intercostal space at the left midclavicular line
V5	on the left anterior axillary line, horizontal with the V4 electrode position
V6	on the left midaxillary line, horizontal with the V4 electrode position

5-Wire Placement (EASI Mode)

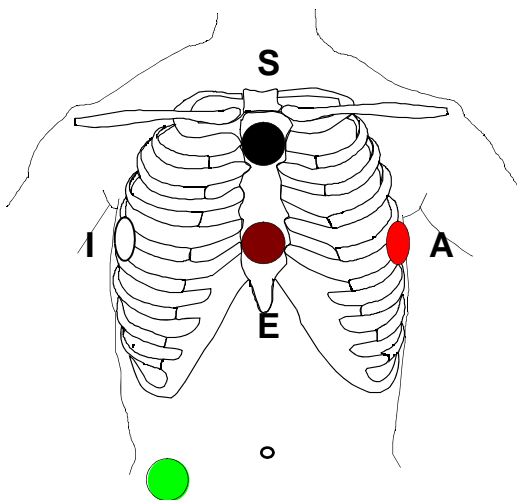

Lead	Corresponds to Standard Lead	Placement
E	V	on the lower sternum at the level of the fifth intercostal space
A	LL	on the left midaxillary line at the same level as the E electrode
S	LA	on the upper sternum
I	RA	on the right midaxillary line at the same level as the E electrode
N	Reference	can be anywhere, usually below the sixth rib on the right hip
<p><i>Note</i>—Make sure that the S and E electrodes line up vertically on the sternum, and that the I, E and A electrodes align horizontally.</p>		

6-Wire Placement

6-lead placement uses the same four limb leads as 5-lead standard placement, and two precordial leads - referred to at the Information Center as Va and Vb.

The default position of Va - the brown lead - is at the V2 position.

The default position for Vb - the brown/white lead - is at the V5 position.

The lead placement for the Va and Vb lead labels must be appropriate. If your unit uses other precordial leads for Va and Vb, they may be assigned in Unit Settings as defaults for your whole unit, or you may need to assign the new positions on a per-patient basis in the Patient Window at the Information Center (see “Telemetry Controls in the Patient Window” on page 9-2).

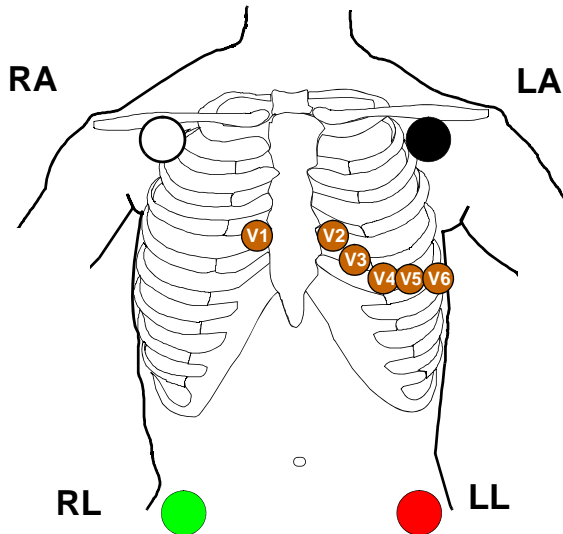

Lead	Placement
RA	directly below the clavicle and near the right shoulder

Positioning ECG Electrodes

Lead	Placement
LA	directly below the clavicle and near the left shoulder
RL	on the right lower abdomen
LL	on the left lower abdomen
Va	on the chest, the position depends on your required lead selection (see below). The default position is V2. For other positions, relabel the lead at the Information Center.
Vb	on the chest, the position depends on your required lead selection (see below). The default position is V5. For other positions, relabel the lead at the Information Center.

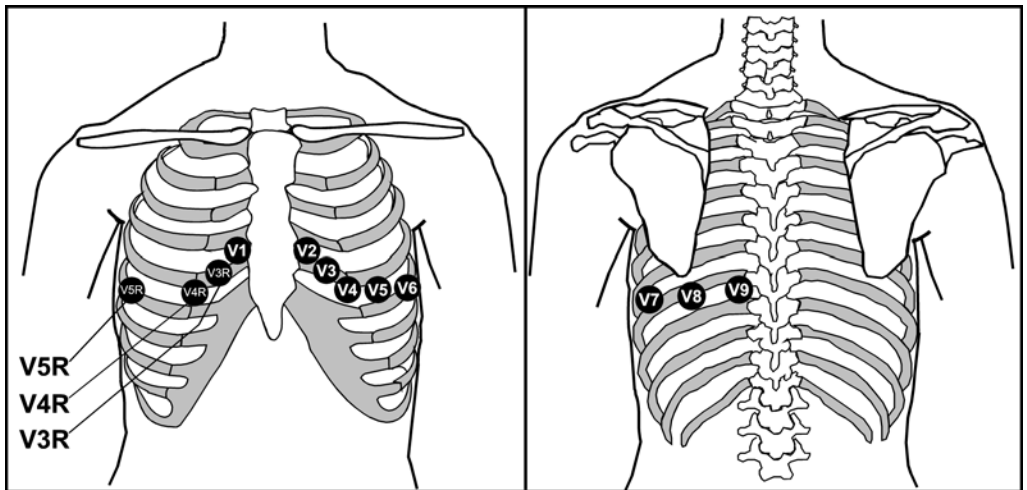

Lead	Placement
V1	on the fourth intercostal space at the right sternal border
V2	on the fourth intercostal space at the left sternal border
V3	midway between the V2 and V4 electrode positions
V4	on the fifth intercostal space at the left midclavicular line
V5	on the left anterior axillary line, horizontal with the V4 electrode position
V6	on the left anterior axillary line, horizontal with the V4 electrode position

Positioning ECG Electrodes

V7	on the left posterior axillary line, straight line from V6
V8	on the left midscapular line, straight line from V7
V9	on the left paraspinal line, straight line from V8
V3R	midway between the V1 and V4R electrode positions
V4R	on the fifth intercostal space at the right midclavicular line
V5R	on the right anterior axillary line, straight line from V4R

Connecting the ECG Cable

Caution

Do not insert a leadset in the transceiver during a self-test. The leadset should be inserted either before the transceiver is powered up, or after the device has established connection with the Information Center.

Note—When using 3- or 5-wire leadsets, alignment guides should be used to prevent the build up of debris in open lead ports.

Connecting the ECG Cable

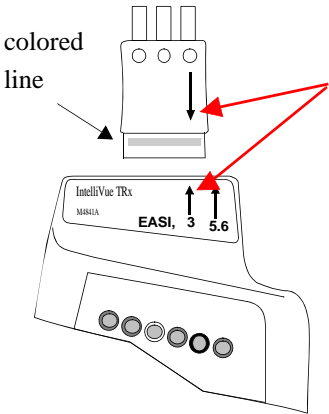
Step	Action
1	<p>Match the arrow on the ECG cable with the arrow on the Lead Insertion Guide according to the lead type you have chosen, and insert the ECG cable into the transceiver.</p> <p><i>Important—Make sure that the cable is pushed completely into the transceiver, otherwise the device may not detect the proper leadset type. When correctly inserted, the colored line at the base of the cable is not visible.</i></p>
2	<p>3-wire</p>  <p>Match the arrow on the cable with the left arrow (labeled EASI, 3) on the Leadset Insertion Guide.</p> <p><i>Note—Leadset is keyed for only one insertion position.</i></p>

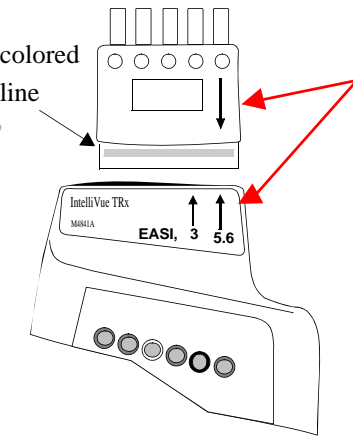
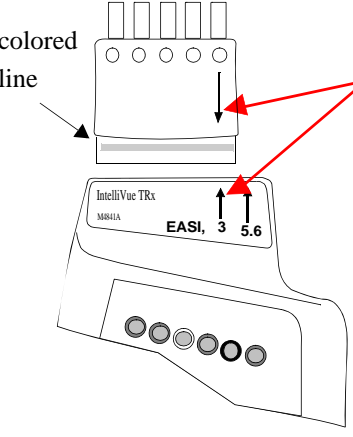
Step	Action
3	<p data-bbox="494 245 696 272">5-wire Standard</p>  <p data-bbox="866 293 1231 415">Match the arrow on the cable with the right arrow (labeled 5, 6) on the Leadset Insertion Guide.</p> <p data-bbox="494 756 645 784">5-wire EASI</p>  <p data-bbox="866 813 1231 935">Match the arrow on the cable with the left arrow (labeled EASI, 3) on the Leadset Insertion Guide.</p> <p data-bbox="494 1292 1231 1414"><i>Note</i>—If you are using a 5-wire leadset in both Standard and EASI modes, insert the alignment guide into the open lead port with the wide lip facing the leads. Then, press down firmly so that the guide is securely under the leadset and the colored line is not visible.</p>

Connecting the ECG Cable

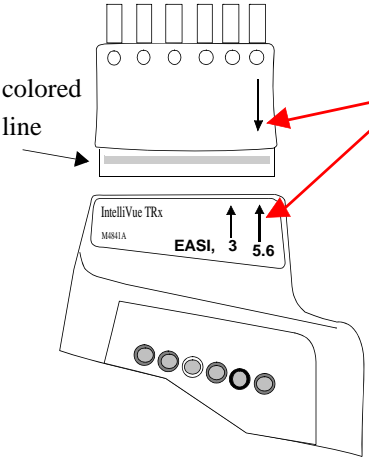
Step	Action
	<p>6-wire</p>  <p>Match the arrow on the cable with the right arrow (labeled 5,6) on the Leadset Insertion Guide.</p>
4	For 6-lead, select the lead label(s) at the Patient Window.
5	<p>Check that the correct Electrode Indicators are lit for the leadset you are using, and that the EASI indicator light is illuminated appropriately. See “Verifying Electrode Connections” on page 6-25.</p> <ul style="list-style-type: none"> When using 5-lead standard, the EASI indicator does not illuminate. <p>When using EASI, the EASI indicator illuminates momentarily.</p>

Cable Disconnection

When disconnecting the leadset from the transceiver, grasp the leadset block firmly and pull free. Do not pull on the lead wires.

Verifying Electrode Connections

The electrode indicators enable you to verify that the leads are available for the desired monitoring. Pressing and holding the Check button enables you to view the leadset status. During routine use of the transceiver for monitoring, all lead indicators are off.

To verify electrode connections, use the following procedure:

Step	Action
1	Press and hold the Check button for 2 seconds

Verifying Electrode Connections

Step	Action
2	<p>Expected Response:</p> <ul style="list-style-type: none"> • If 3-wire cable is attached: Red, White and Black indicators illuminate, then all turn off. • If 5-wire cable in Standard mode is attached: Red, White, Black, Green & Brown indicators illuminate, then all turn off. • If 5-wire cable in EASI mode is attached: Red, White, Black, Green & Brown indicators illuminate, then all turn off. The EASI indicator also illuminates briefly. • If 6-wire cable is attached: Red, White, Black, Green, Solid Brown and Brown/White indicators illuminate, then all turn off. • If all leads are off, the green indicator will be lit.
3	<p>Unexpected Response:</p> <p>Any other response indicates a problem with the transceiver or lead set.</p> <ul style="list-style-type: none"> • Check the leadset connection. The colored line should not be visible; otherwise the wrong leadset type may be detected. • If the INOP, INVALID LEADSET, and the corresponding audible tone occur, the leadset inserted does not match the transceiver's configuration. Insert the correct leadset per the configuration. • Use a new leadset. <p>If the problem is not corrected, contact your service provider.</p>

During routine monitoring, the electrode indicators also notify you if one or more leads are not functioning. When a "Leads Off" condition occurs, the transceiver automatically illuminates the indicator corresponding to the missing lead.

Note—Should the lead in the reference lead placement position (standard mode - RL; EASI mode - green) become disconnected, the ECG signal is lost entirely. After 10 minutes of this leads off condition, without the SpO₂ sensor connected, the transceiver will enter an RF Auto Shutoff state (if enabled). To correct the condition, re-attach the lead to the electrode.

Monitoring during Leads Off

ECG Fallback and Extended monitoring states are supported for the transceiver when the primary and/or secondary leads are in a "Leads Off" INOP condition. Both of these states are entered into after 10 seconds of "Leads Off" in an attempt to maintain monitoring and arrhythmia analysis.

ECG Fallback

ECG Fallback occurs when the primary lead is in "Leads Off" for 10 seconds and a secondary lead is available.

Multilead Analysis

If there is a "Leads Off" technical alarm in the primary lead for > 10 seconds, the active secondary lead becomes the primary lead. The arrhythmia algorithm switches the leads on the display, but relearn does not occur. When the "Leads Off" condition is corrected, the leads are switched back to their original state.

Single Lead Analysis

For single lead analysis, if there are two leads available, the secondary lead is made the primary lead until the "Leads Off" condition is corrected. The arrhythmia algorithm performs a relearn using the available lead.

Fallback for EASI

If one of the derived EASI leads is in a technical alarm condition, a flat line is displayed. After 10 seconds, the directly acquired EASI AI, AS, or ES lead, depending on which is available, is displayed with the label "ECG". Arrhythmia relearn is performed with transition to or from EASI Fallback monitoring using the available lead(s).

Relearning

Whenever there is a "Leads Off" condition, the arrhythmia algorithm performs a Relearn using the available leads.

Warning

Since Relearn happens automatically, if learning takes place during ventricular rhythm, the ectopics can be incorrectly learned as the normal QRS complex. This can result in missed detection of subsequent events of V-Tach and V-Fib. For this reason, you should:

- 1. Respond promptly to any technical alarm.**
 - 2. Ensure that the arrhythmia algorithm is labeling beats correctly.**
-
-

Using EASI Leads to Troubleshoot

If there is artifact in the ECG waves or a "Cannot Analyze ECG" technical alarm condition is in effect, you can use the three EASI leads to troubleshoot at the Information Center:

1. Click **12-Lead ECG** on the Patient Window, then on **3 EASI Leads**.
2. The three directly acquired EASI leads will be displayed so that you can determine which electrodes are causing the problem and need to be replaced.

Optimizing ECG Measurement Performance

Warning

Telemetry should not be used for primary monitoring in applications where the momentary loss of the ECG is unacceptable.

No matter how good a wireless network design is, a telemetry system will always experience occasional loss of radio communications, resulting in ECG waveform dropouts. A telemetry system will never be as reliable as a hardwired bedside monitor that transmits its signal through a wire. If occasional loss of ECG monitoring is not acceptable for certain patients, they should be connected to a hardwired bedside monitor.

Smart Hopping technology alleviates most of the problems associated with legacy telemetry technologies. Reception problems are less frequent, because Smart Hopping avoids interference and moves to a different access point if the signal strength is too low. The level of radio frequency activity is always fluctuating in the environment. If the level becomes high enough to significantly interfere with transceiver operation, the system responds by moving to another “cleaner” area where there is less activity.

The effect of interference on the IntelliVue Telemetry System ranges from a momentary loss of ECG to complete inoperability, and can be caused by many sources. The strength, frequency, and proximity of the source of interference to the transceiver or the access point are factors that determine the degree of severity. In cases where the source of interference can be identified, corrective action can be taken. For example, removing or moving away from the source of interference will increase the equipment's dependability.

Clinicians will tend to see more motion related artifact on the ECG of ambulatory patients than on patients that are restricted to a bed. Proper skin preparation and electrode application are very important in reducing this problem.

Problems with the ECG signal stem from two main sources:

1. Frequency-related sources resulting in dropouts from signal disturbances and loss of signal.
2. Patient-related sources with noise on the waveform caused by clinical considerations such as poor skin prep, dry electrodes, and poor electrode adhesion, as well as by patient motion and muscle artifact.

Even in complex situations where problems overlap, most of the time you'll be able to greatly enhance performance by taking corrective action.

Monitoring Considerations

- Patient should be restricted to the designated coverage area. Monitoring performance will degrade if patients go outside the radius of coverage of the receiving wireless network.
- A patient location strategy is critical to a telemetry system. If a life-threatening event occurs, the clinician must be able to locate the patient quickly. The importance of this increases as the coverage area increases.
- Frequency management is the responsibility of the hospital. Philips Medical System has no control over the RF environment in the hospital. If interference exists at the operating frequencies of the telemetry equipment, telemetry performance will be affected. Careful selection of frequencies for all wireless devices used within a facility (transceivers, other wireless medical devices, etc.) is important to prevent interference between them.

Dropouts

Because the IntelliVue Telemetry System is a wireless system, under certain frequency conditions dropouts can occur. Dropouts result from a weak signal or RF interference, and appear on the waveform when the signal "drops" to the bottom of the channel for a minimum of 200 ms. If dropouts are frequent enough to affect the heart rate count, the "Cannot Analyze ECG" or "Cannot Analyze ST" technical alarm occurs. If there are enough dropouts to cause

disassociation/reassociation with the Information Center, events in the Clinical Review application can reflect loss of data for up to 1 minute in the worst case.

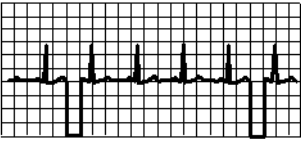
Problem	Cause	Remedy
<p>Dropouts</p> 	<p>Low signal strength RF interference</p>	<p>See “Signal Strength” below. See “Radio Frequency Interference” below.</p>

Signal Strength

The IntelliVue Telemetry System is custom designed for your site, so reliable signal reception is only possible where there are receiving access points. When the signal is too low, the following technical alarms can occur:

- "Cannot analyze ECG"
- "Cannot analyze ST"
- "Tele Weak signal"
- "No signal"

Corrective Action

1. Check the location of the patient. If the patient is out of range, return the patient to the specified coverage area.
2. If the patient is intentionally out of the coverage area, put telemetry in Standby Mode. See “Standby Mode” on page 4-4.
3. If the patient is in the coverage area and is stationary, try moving the transceiver about 15 cm (6 inches).
4. Check for INOP and information signals at the Information Center.
5. Check for interference activity in other sectors at the Information Center to see if the problem is occurring with other transceivers.
6. If the problem is persistent, call service.

Radio Frequency Interference

Radio frequency (RF) interference is caused by other devices that intrude into the transmitted electrical signal. You are probably familiar with electrical interference in our homes and cars when it causes signal loss or static with cell phones. This same type of interference can occur with the transmitted telemetry signal even though the IntelliVue Telemetry System is designed to resist these

effects and Smart-hopping enables the system to avoid most instances of interference.

The 2.4 GHz ISM band used by the ITS4850A IntelliVue Telemetry System is used by many different radio technologies, (e.g. microwave ovens, wireless phones, Bluetooth devices). Therefore, there is increased potential for interference. The system has the ability to detect whether the spectrum is too congested. When detected, a "Wireless Monitoring Loss - Call Service" system message is issued at the Information Center.

Corrective Action

1. To improve performance, the source of the interference must be identified and eliminated. Try moving or removing other wireless devices transmitting in your frequency band. Such devices can be identified by the presence of an antenna and/or the following symbol:

:





Important—The IntelliVue Telemetry System emits radio frequencies that can affect the operation of other devices. Contact the manufacturer of other equipment for possible susceptibility to these frequencies.

Muscle and Movement Artifact



Muscle and movement artifact, respiratory variation, as well as poor electrode contact, inadequate skin preparation, and other patient-related factors can also affect interference with the ECG signal. Good clinical practice can have a significant effect on the quality of ECG monitoring.

Corrective Action

Use the following table to help you troubleshoot the most common sources of physiologically-caused ECG noise.

Problem	Cause	Remedy
<p>60-Cycle (AC) Interference</p> 	<p>Poor electrode placement. Possible non-grounded instrument near patient.</p>	<p>Re-apply electrodes, using good skin preparation (see “Positioning ECG Electrodes” on page 6-10). Disconnect electrical appliances near patient (one at a time) by pulling wall plugs, to determine faulty grounding. Have engineering check grounding.</p>
<p>Muscle Artifact</p> 	<p>Tense, uncomfortable patient. Poor electrode placement. Tremors. Diaphoresis.</p>	<p>Make sure patient is comfortable. Check that electrodes are applied on flat non-muscular areas of the torso; apply fresh electrodes if necessary, using good skin preparation (see “Positioning ECG Electrodes” on page 6-10).</p>
<p>Irregular Baseline</p> 	<p>Poor electrical contact. Respiratory interference. Faulty electrodes. Dry electrodes.</p>	<p>Re-apply electrodes, using good skin preparation (see “Positioning ECG Electrodes” on page 6-10). Move electrodes away from areas with greatest movement during respiration.</p>

Optimizing ECG Measurement Performance

Problem	Cause	Remedy
<p>Baseline Wander</p> 	<p>Movement of patient.</p> <p>Improperly applied electrodes.</p> <p>Respiratory interference.</p>	<p>Make sure patient is comfortable.</p> <p>Re-apply electrodes, using good skin preparation (see “Positioning ECG Electrodes” on page 6-10). Check that patient cable is not pulling electrodes.</p> <p>Move electrodes away from areas with greatest movement during respiration.</p>
<p>Poor Electrode Contact</p> 	<p>Loose electrodes.</p> <p>Defective cables.</p> <p>Leadset not firmly connected.</p>	<p>Change electrodes, using good skin preparation (see “Positioning ECG Electrodes” on page 6-10).</p> <p>Replace cables.</p>

ST/AR Arrhythmia Monitoring

This chapter describes the ST/AR algorithms used for telemetry at the IntelliVue Information Center. It includes the following sections:

- ST/AR Arrhythmia Algorithm 7-2
- ST/AR ST Segment Algorithm 7-7
- ST/AR QT Interval Algorithm 7-14

ST/AR Arrhythmia Algorithm

Indications for Use

The ST/AR Arrhythmia Algorithm is indicated for use in instances where the clinician decides to monitor cardiac arrhythmias of adult and pediatric patients and/or the ST segment of adult patients to gain information for treatment, monitor the adequacy of treatment, or to exclude causes of symptoms.

Safety Information

Warning

During complete heart block or pacemaker failure (to pace or capture), tall P-waves (greater than 1/5 of the average R-wave height) can be erroneously counted by the arrhythmia algorithm, resulting in missed detection of cardiac arrest.

Warning

Learning

If you initiate learning during ventricular rhythm, the ectopics can be incorrectly learned as the normal QRS complex. This can result in missed detection of subsequent events of V-Tach and V-Fib.

Warning

Relearning

Arrhythmia relearning is initiated whenever the transceiver is powered down for one minute or longer or whenever it is directly connected/disconnected to an IntelliVue MP5 Patient Monitor. Be sure to check your patient's arrhythmia annotation for accuracy whenever relearn has occurred.

Since Relearn happens automatically, if learning takes place during ventricular rhythm, the ectopics can be incorrectly learned as the normal QRS complex. This can result in missed detection of subsequent events of V-Tach and V-Fib. For this reason, you should:

1. Respond promptly to any technical alarm.
2. Ensure that the arrhythmia algorithm is labeling beats correctly.

When using EASI ECG monitoring, Relearn happens automatically when there is a LEADS OFF technical alarm. If learning takes place during ventricular rhythm, the ectopics can be incorrectly learned as the normal QRS complex. This can result in missed detection of subsequent events of V-Tach and V-Fib. Be sure to check the beat labels and initiate a relearn to correct.

1. Respond to the technical alarm [for example, reconnect the electrode(s)].
 2. Ensure that the arrhythmia algorithm is labeling beats correctly.
-
-

For Paced Patients

Warning

Some pace pulses can be difficult to reject. When this happens, the pulses are counted as a QRS complex, and could result in an incorrect HR and failure to detect cardiac arrest or some arrhythmias. Keep pacemaker patients under close observation.

Warning

For paced patients who exhibit only intrinsic rhythm, the monitor can erroneously count pace pulses as QRS complexes when the algorithm first encounters them, resulting in missed detection of cardiac arrest. The risk of missing cardiac arrest can be reduced by monitoring these patients with the low heart rate limit at or slightly above the basic/demand pacemaker rate. A low heart rate alarm alarms you when the patient begins pacing. Proper detection and classification of the paced rhythm can then be determined.

Warning

When an external pacemaker is being used on a patient, arrhythmia monitoring is severely compromised due to the high energy level in the pacer pulse. This can result in the arrhythmia algorithm's failure to detect pacemaker non-capture or asystole.

Warning

It is possible that pacemaker pulses will not be detected when the ECG analog output of a defibrillator is plugged into a bedside monitor. This can result in the arrhythmia algorithm's failure to detect pacemaker non-capture or asystole.

Warning

Always verify that your patient's paced setting at the Information Center accurately reflects the patient's status.

Intended Use

The intended use of the ST/AR basic arrhythmia analysis algorithm is to monitor the patient's ECG for heart rate and ventricular arrhythmias and to produce events/alarms simultaneously for one or more ECG leads. The arrhythmia algorithm is effective when monitoring both paced and non-paced patients in a clinical environment.

ST/AR Arrhythmia Analysis

For information on arrhythmia detection, refer to the following documentation:

- *ST/AR Algorithm - Arrhythmia Monitoring Application Note*, #453564115631.
- *IntelliVue Information Center Instructions for Use and Online Help*

IntelliVue Telemetry does not have a dedicated cardioteach. Instead, the arrhythmia cardioteach at the Information Center is used. Therefore, the ST/AR Arrhythmia algorithm is always on for all IntelliVue Telemetry patients, and cannot be turned off.

ST/AR provides Heart Rate and PVC Rate numerics and alarm detection for the conditions listed in the following table. There are two detection levels: Basic and Enhanced. Enhanced includes the Basic alarms.

Basic & Enhanced Arrhythmia Detection

Basic Arrhythmia Detection	Enhanced Arrhythmia Detection
Asystole	Non-Sustain VT
V-Fib/Tach	Vent Rhythm
V-Tach	Run PVCs
Brady yyy < xxx	Pair PVCs
Tachy yyy > xxx	Pause
HR yyy > xxx	Missed Beat
HR yyy < xxx	SVT
PVCs > xxx/min	R-on-T PVCs
Pacer Not Capturing	Vent Bigeminy
Pacer Not Pacing	Vent Trigeminy
	Multiform PVCs
	Afib
	Irregular HR

ST/AR Arrhythmia Algorithm

Beat classification determined by the ST/AR algorithm is shown on the primary delayed wave in the Arrhythmia Analysis window at the Information Center. To access this window, select Arrhythmia Analysis from the Patient Window.

The annotation requires clinical validation of the analyzed heart rhythm. If the analysis is inaccurate, perform a relearn of the rhythm.

Annotation	Beat Classification	Display Color
A	Artifact	Blue
I	Inoperative	Red
L	Learning	Red
M	Missed Beat	Red
N	Normal	Blue
P	Paced	Blue
S	Supraventricular Premature	Blue
V	Ventricular Premature	Red
?	Questionable	Red
'	Pacer Spike	Blue
"	Biventricular Pacer Spike	Blue

When monitoring is initiated, when the Primary Wave is changed, or if Relearn is selected, a question mark (?) is displayed next to HR and the annotation "L" appears on the annotated wave until the HR is calculated and the rhythm is learned.

ST/AR ST Segment Algorithm

Intended Use

The intended use of the ST/AR ST Analysis algorithm is to monitor an adult patient's ECG for ST segment elevation or depression and produce events/alarms for all possible ECG leads. The ST Analysis algorithm is capable of monitoring paced and non-paced adult patients.

Note—The ST Analysis algorithm does not analyze ventricularly paced or ventricular ectopic beats.

Warning

This device provides ST level change information; the clinical significance of the ST level change information needs to be determined by a physician.

The ST/AR ST algorithm at the Information Center monitors ST segment elevation or depression for each available telemetry ECG lead and produces events/alarms simultaneously. ST values update with every measurement period and enunciate, depending upon the severity of the change, events and alarms as they are detected.

The ST/AR ST algorithm is approved for use only with non-paced and atrially-paced adult telemetry-monitored patients. With EASI monitoring, ST analysis is performed on up to 12 leads, and an additional value of ST index is calculated and displayed (see “EASI ST Analysis” on page 7-9). Assessment of EASI-derived 12-lead ST measurement is recommended for adult patients that meet the following parameters:

- Ages: 33-82 years
- Heights: 147 to 185 cm (58 to 73 in)
- Weights: 53 to 118 kg (117 to 261 lbs)
- Height to Weight Ratios: 1.41 to 2.99 cm/kg (0.25 to 0.54 in/lb)

All ST analysis and ST alarms for telemetry patients are performed by the Information Center.

For additional information on ST monitoring, refer to the following documentation:

- *ST/AR Algorithm - ST Segment Monitoring Application Note, #452298192851*
- *IntelliVue Information Center Instructions for Use and Online Help*

The Measurement

The ST measurement for each beat complex is the vertical *difference* between two measurement points. The **isoelectric point** provides the baseline for the measurement and the **ST point** provides the other measurement point. It is positioned with reference to the J-point.

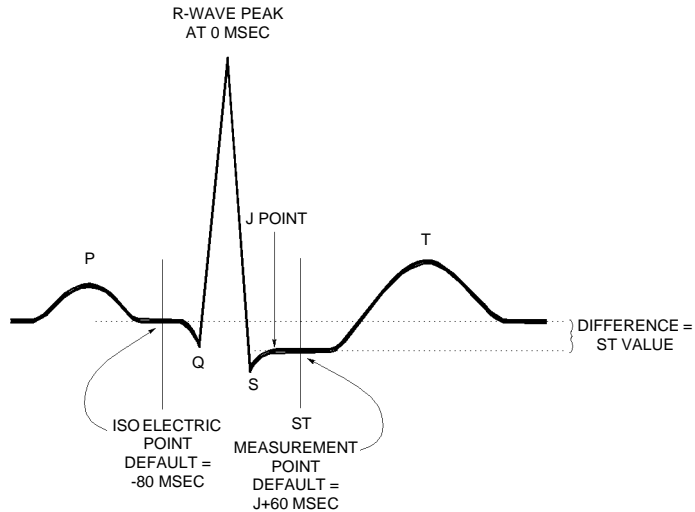

Algorithm Processing

ST analysis analyzes ECG signals to classify the heart beats. Only beats classified as normal or Supraventricular (atrially paced) are used to calculate ST elevations and depressions.

The ST/AR ST algorithm processing includes special ST filtering, beat selection and statistical analysis, calculation of ST segment elevations and depressions, and lead reconstruction and wave generation.

When ST analysis is being performed on two leads, the averaged derived and reconstructed ST waves and associated ST segment values are given for up to six leads, depending on the type of patient cable:

- 3-wire: one lead

- 5-wire: up to two leads if monitoring a chest and a limb lead
- 5-wire: up to six leads if monitoring two limb leads
- 5-wire: up to 12 leads if monitoring using EASI
- 6-wire: up to 8 leads if monitoring two limb leads and two chest leads

Note—No ST analysis is done on a patient if an electrode falls off.

Displayed ST Data

ST data displays as values in the Patient Sector and Patient Window. A positive value indicates ST segment elevation; a negative value indicates ST segment depression. You can view ST data in ST Review, Trend Review, and Event Review windows.

EASI ST Analysis

The Information Center generated ST values presented in the patient sector and Patient Window for EASI derived leads is STindx (ST Index). STindx is a summation of three ST segment measurements, using the leads that can indicate ST segment changes in the different locations of the heart:

- anterior lead V2
- lateral lead V5
- inferior lead aVF

ST Operation

Turning ST Monitoring On/Off

The ST Setup Window allows you to turn ST monitoring on or off for all available ECG leads.

To turn ST monitoring on at the Information Center, perform the following steps:

Step	Action
1	From the Patient Window, click the All Controls button.
2	From the All Controls Window, click the ST Setup button.
3	From the ST Setup Window, click ST On .

You would turn ST monitoring off if:

- You are unable to get any lead that is not noisy.
- Arrhythmias such as atrial fib/flutter cause irregular baseline.
- The patient is continuously ventricularly paced.
- The patient has left bundle branch block.

Adjusting ST Measurement Points

The ST Setup Window enables you to adjust the ST measurement points to ensure accurate data.

There are three measurement cursors:

- The ISO measurement cursor positions the isoelectric point in relation to the R-wave peak.
- The J-point cursor positions the J-point in relation to the R-wave peak. The purpose of the J-point is to correctly position the ST measurement point.
- The ST measurement cursor positions the ST point a fixed distance from the J point.

Note—The ST measurement points may need to be re-adjusted if the patient's heart rate or ECG morphology changes significantly.

Perform the following steps at the Information Center to adjust the ST measurement points:

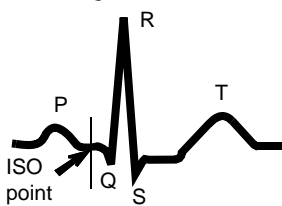
Step	Action
1	Access the ST Setup window by clicking on the All Controls button in the Patient Window, then clicking on the ST Setup button.
2	<p>If you need to adjust the ISO (isoelectric) point, place the cursor over the ISO button to access the adjustment arrows. Then use the arrows to position the bar in the middle of the flattest part of the baseline (between the P and Q waves or in front of the P wave).</p> 

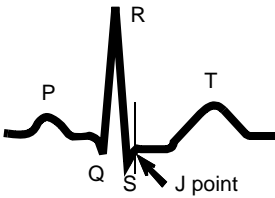
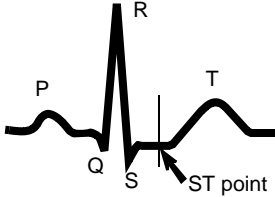
Step	Action
3	<p>Adjust the J point, if necessary, by placing the cursor over the J-point button to access the adjustment arrows. Then use the arrows to position the bar at the end of the QRS complex and the beginning of the ST segment.</p> 
4	<p>Adjust the ST point, if necessary, by using the J point as an “anchor” and placing the bar at the midpoint of the ST segment. Choices are J+0, J+20, J+40, J+60, or J+80.</p> 

Establishing ST Reference Beats (Baseline)

After adjusting the measurement points, you can establish baseline reference beats for all available leads in the ST Review window at the IntelliVue Information Center. Reference beats enable you to compare waveform changes, for example from admission, or prior to or after treatment. The reference continues to be saved beyond the 24 hour review window, but you can update it to any beat within the last 24 hours. Please refer to the *IntelliVue Information Center Instructions for Use or Online Help* for directions.

ST Alarm Settings

All IntelliVue Information Center alarm settings (limits and on/off status) have unit default settings. The IntelliVue Information Center however, lets you set the high and low ST alarm limits for individual patients based on:

- Your assessment of the patient's clinical condition.
- Unit protocols.
- Physician orders or medication specified limits.

You can make the following adjustments to ST alarm limits to accommodate the clinical condition of individual patients:

- Turn all alarms off/on.
- Adjust the alarm limits:
 - to specific high and low limits
 - to Smart Limits (see the *IntelliVue Information Center Instructions for Use* for information on Smart Limits)
 - back to unit default settings.

You adjust the ST alarm limits in the ST Alarms Window. Each ST parameter has its own alarm limit. The alarm is triggered when the ST value exceeds its alarm limit for more than 1 minute. The alarm will be a yellow alarm.

When more than one ST parameter is in alarm, only one alarm message displays. For multilead alarms when using an EASI transceiver, an alarm is generated if two or more ST leads exceed the alarm limits. The default setting is +/-1.0. The alarm message indicates the two leads that are in greatest violation of the limits, for example, “**MULTI ST AVR, V6”. If another lead becomes deviant, the message changes but it is considered the same alarm (no new alarm sounds and it is not listed as a new event).

See “Physiologic Alarms” on page 5-4 for a list of all ST alarms.

See the *IntelliVue Information Center Instructions for Use* for specifics on alarm management and behavior.

Adjusting ST Alarms

Make adjustments to ST alarms on the ST Alarms window at the Information Center.

Step	Action
1	From the Patient Window, select the All Controls button.
2	From the All Controls window, select the ST Alarms button under Alarm Management and Setup.
3	<p>In the ST Alarms window, adjust alarms as needed. Choices for setting the ST alarm limits are:</p> <p>Unit Settings—Click on this button if want to have the specific limits that are pre-set for your unit.</p> <p>Smart Limits—Click on this button to set high and low limits around your patient's current ST value. The difference above and below the patient's ST value are pre-set for your unit.</p> <p><i>Note</i>—Smart Limits can be configured to automatically be activated when the patient is connected. See the <i>IntelliVue Information Center Instructions for Use</i> for additional information on using smart limits.</p> <p>Set the high and low alarm limits based on your assessment of the patient's clinical condition, unit protocols, or physician orders or medication specified limits. A good guideline is + 1.0 mm or - 1.0 mm from the patient's ST, or follow your unit protocol.</p>

ST/AR QT Interval Algorithm

Intended Use

The intended use of the ST/AR QT/QTc analysis is for use by the physician in the risk assessment process indicated for pediatric and adult patients with and without symptoms of arrhythmia. QT measurement is intended to be used by qualified health professionals in hospital or clinical environments. Composite QT (single or multi-lead derived) measures the interval only and is not intended to produce any interpretation or diagnosis of those measurements. Additional information regarding QT monitoring can be found in the *QT/QTc Interval Monitoring Application Note, #453564115621*

Warning

The device provides QT and QTc interval change information; the clinical significance of the QT and QTc interval change information should be determined by a clinician.

What is QT Interval Monitoring

Of special concern for QT monitoring is the administration of QT prolonging drugs to patients identified with risk factors for Torsade de Pointe. Females, older patients and patients with bradycardia, impaired left ventricular function (ischemia, left ventricular hypertrophy), hypokalemia and hypomagnesemia are in this increased risk category.

QT interval monitoring can assist in the detection of prolonged QT interval syndrome. The QT interval in an ECG lead is the time interval from the onset of the earliest deflection in the QRS complex to the end of the T wave. For patients being monitored by an IntelliVue Telemetry System device, the Information Center measures the QT values once every minute during startup, during the learning phase and on lead mode change. After that the Information Center updates the QT values every five minutes.

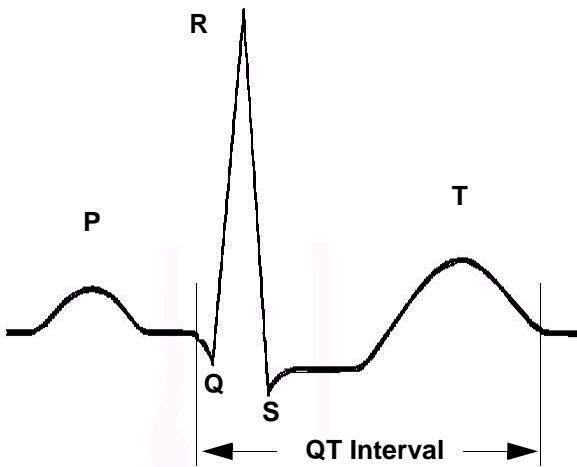

The QT interval has an inverse relationship to heart rate. Faster heart rates shorten the QT interval and slower heart rates prolong the QT interval. To correct the QT interval for heart rate the Information Center uses the Bazett correction formula by default. Your system, however, may be set up to use the Fridericia correction formula as an alternative. The heart rate corrected QT interval is abbreviated as QTc.

QT Definitions

Measurement	Definition
QT	QT interval in milliseconds. The QT interval is the time between the beginning of the Q wave and the end of the Twave.
QTc	QTc represents the heart rate corrected QT interval. By default, the Information Center uses the Bazett correction formula to correct the QT interval for heart rate. Your system, however, may be set up to use the Fridericia correction formula.
dQTc	The difference between the current QTc value and the QTc baseline value.
QT-HR	The heart rate used to calculate QTc

QT Alarms

Alarm	Definition
**QTc High	The QTc high limit alarm is a long yellow alarm that occurs when there are two consecutive 5 minute QTc values above the set alarm limit.
**dQTc High	The dQTc alarm is a long yellow alarm that occurs when the difference between the current value and the baseline value exceeds the set limit for two consecutive 5 minute dQTc values. The dQTc alarm has a lower priority than the QTc High alarm.
Cannot Analyze QT	When there are two consecutive invalid 5 minute values the Information Center generates a Cannot Analyze QT soft INOP and displays a question mark (?) for the QT parameter value. The Information Center displays the Cannot Analyze QT INOP without the question mark during initial startup and during the learning phase.

How the QT Analysis Algorithm Works

The Information Center measures the QT values once every minute during startup. Subsequently, the Information Center updates the QT values every five minutes. Normal or atrial paced beats and beats with a similar morphology are averaged to form a representative waveform for further processing. Normal beats followed by a premature QRS will be excluded from the measurements to prevent the premature beat from obscuring the end of the T-wave. If the algorithm cannot form a representative waveform, for example because the morphology of the beats is too varied, the Information Center generates a Cannot Analyze QT INOP when it detects two consecutive invalid 5 minute values. This is also the case if normal beats have been falsely labelled so that the algorithm does not have enough valid beats to make QT measurements. No QT value is calculated if the QT-HR is >150 bpm (Adult) or >180 bpm (Pedi/Neo).

Because of the different algorithm approaches, a QT/QTc measurement from a diagnostic 12-lead program may differ from the realtime measurement.

For QT interval monitoring to be effective, basic or enhanced arrhythmia monitoring must be on.

Adjusting QT Settings

For patients being monitored by an IntelliVue Telemetry System device you can adjust QT settings in the QT Setup window at the Information Center. If the patient is monitored by an IntelliVue Patient Monitor, QT/QTc analysis is provided by the IntelliVue Patient Monitor. Adjust QT settings at the bedside.

To adjust the settings at the Information Center:

Step	Action
1	Access the QT Setup window by selecting the QT Setup button in the All Controls window.
2	Make the adjustments on the QT Setup window. The table below describes each of the available adjustments.

Adjustment	Description
Turn QT Analysis On/Off	<p>Turn QT analysis on by clicking in the QT Analysis On check box. QT analysis is on when a checkmark displays in the check box. When the QT measurement is on, a QT status message is displayed in the QT Setup window, along with the current values for QT, QTc, dQTc and QT-HR. The lead labels indicating the leads used to calculate the baseline and current values also appear.</p> <p><i>Note</i>—Turning QT analysis off does not clear the baseline value. This allows you to turn QT analysis off during prolonged arrhythmias, such as bigeminy, without losing the baseline.</p>

Adjustment	Description
<p>Select the QT Lead</p>	<p>The QT Lead field allows you to select which leads to analyze when calculating the QT parameters. To select the desired lead by clicking on the QT Lead drop down arrow then highlighting the lead from the list that displays.</p> <p>Choose:</p> <ul style="list-style-type: none"> • All if you want a global QT measurement based on all available leads. For standard placement leads I, II, III, V and V1 through V6 are used. For EASI placement directly acquired AI, AS, and ES leads are used. <p><i>Note</i>—This may include leads that are not being stored.</p> <ul style="list-style-type: none"> • Primary if you want to use the primary lead for the QT measurement. If the primary lead becomes unavailable or is changed the QT measurement continues with the new primary lead. • A single lead from the list to use that lead for QT measurement. If the lead you select becomes unavailable QT monitoring stops. <p><i>Note</i>—The V7, V8, V9, V3R, V4R or V5R leads are not available for single lead selection. These leads are processed, however, when you select Primary in the QT Lead field.</p>

Adjustment	Description
<p>Set the QT Baseline</p>	<p>To quantify changes in the QTc value you can set a QTc baseline. Select the Set QT Baseline button to replace the baseline QTc value with the current QTc value. If a baseline has not been set the Information Center sets the baseline to the first valid value after measuring QT for five minutes. Setting a new baseline discards the previous baseline.</p> <p><i>Notes—</i></p> <ul style="list-style-type: none"> • Since the dQTc alarm is based on the difference between the baseline and the current value, setting an inappropriate new baseline may prevent a dQTc alarm from being generated. • Turning QT analysis off does not clear the baseline value. This allows you to turn QT analysis off during prolonged arrhythmias, such as bigeminy, without losing the baseline. • Discharging a patient clears the baseline.

Adjustment	Description
Turning QT Alarm On/Off	<p>There are two QT long yellow alarms (**); QTc High and dQTc High. The QTc High alarm occurs when two consecutive 5 minute QTc values are above the set alarm limit. The dQTc alarm occurs when the difference between the current value and the baseline value exceeds the set limit for two consecutive 5 minute dQTc values.</p> <p>Turn the QTc or dQTc alarm on by placing a checkmark in the checkbox next to the QTc High or dQTc High field. The Alarm is off when no checkmark displays in the checkbox.</p>
Adjusting QT Alarm Limits	<p>Set the high alarm limits based on your assessment of the patient's clinical condition, unit protocols, physician orders or medication specified limits.</p> <p>Normal Values for Adults:</p> <ul style="list-style-type: none"> • Men: QTc <420 milliseconds. • Women: QTc <430 milliseconds. <p>To set the QTc or dQTc alarm limits:</p> <ol style="list-style-type: none"> 1. Turn the QTc or dQTc alarm on by placing a checkmark in the checkbox next to the QTc High or dQTc High field. 2. Use the appropriate up and down arrow to obtain the desired limit.

Limitations for QT Monitoring

Some conditions may make it difficult to achieve reliable QT monitoring. When this occurs the CANNOT ANALYZE QT INOP message displays at the Information Center, along with a QT STATUS message. Some conditions that may make reliable QT monitoring difficult include:

- **T-Wave Detection Limitations.**

Flat T-wave, atrial Fibrillation or atrial Flutter and prominent U-waves can make QT monitoring difficult. For these cases you should select **All** as the QT Lead on the QT window. The Information Center will use the lead or leads that have a T-wave with sufficient amplitude and can be detected. Alternatively select a single lead with a good T- wave amplitude and no visible flutter activity and without a predominant U-wave or P-wave.

- **QRS Changes**

QRS changes such as widened QRS can affect QT monitoring. If a long QTc is observed verify that is not caused by QRS widening.

- **Rhythm and Rate Limitations**

Rhythm and rate limitations such as high heart rate (> 150 beats/min for adults patients or > 180 beats/min for pediatric or neonatal patients), paced rhythm and bigeminy rhythm can make reliable QT monitoring difficult. If rhythm is sustained you may want to consider turning QT interval monitoring off.

How the QT Analysis Algorithm Works

8 SpO₂ Monitoring

This chapter provides an introduction to the SpO₂ measurement and its application. It includes the following sections:

- SpO₂ Safety Information 8-2
- Pulse Oximetry Measurement. 8-5
- Selecting a SpO₂ Sensor 8-7
- Applying the Sensor 8-11
- Connecting the SpO₂ Cable 8-15
- Measuring SpO₂ 8-16
- Understanding SpO₂ Alarms 8-21
- Optimizing SpO₂ Measurement Performance 8-22

SpO₂ Safety Information

Warning

Always confirm Information Center observations with clinical observation of the patient before administering interventions.

Warning

Using a sensor during MR imaging can cause severe burns. To minimize this risk, ensure that the cable is positioned so that no inductive loops are formed. If the sensor does not appear to be operating properly, remove it immediately from the patient.

Warning

Prolonged, continuous monitoring can increase the risk of changes in skin characteristics, such as irritation, reddening, blistering or pressure necrosis, particularly on patients with impaired perfusion and varying or immature skin morphology. Specific attention must be given to sensor site inspection for changes in skin quality, proper optical path alignment and attachment. Check the application site at regular intervals and change the site if any compromise in skin quality should occur. More frequent checking can be required due to an individual patient's condition.

Warning

Injected dyes such as methylene blue or intravascular dyshemoglobins such as methemoglobin and carboxyhemoglobin can lead to inaccurate (over-estimated) measurements.

Warning

Interference leading to inaccurate measurements can be caused by:

- **High levels of ambient light (Hint: cover application site with opaque material)**
 - **Electromagnetic interference**
 - **Excessive patient movement and vibration.**
-
-

Warning

This equipment is not suitable for use in the presence of a flammable anesthetic mixture or oxygen concentrations greater than 25% (or partial pressures greater than 27,5 kPa /206.27 mmHg).

Warning

Disposable SpO₂ sensors can be damaged and lead to patient harm if they become wet. Wet sensors must be replaced immediately.

SpO₂ Information for the User

The pulse oximeter is calibrated to indicate functional oxygen saturation (fractional oxyhemoglobin), and displayed results can range from 0 to 100%.

A 10 second averaging filter is used in the calculation of the result. Displayed results are typically updated every second, but the update period can be automatically delayed by up to 30 seconds in the presence of noise.

SpO₂ Safety Information

Physiological SpO₂ alarm signals will be generated at the Information Center. The SpO₂ low limit can be set between 50 and 99% inclusive, in 1% increments. The SpO₂ high alarm limit can be set between 51 and 100% inclusive, in 1% increments. The maximum delay between the physiological alarm condition and alarm signal generation at the central station is 10 seconds.

Pulse rate is also derived from the pulsatile SpO₂ measurement, and displayed results can range from 30 to 300 bpm. There is no alarm function for pulse rate.

The pleth wave is auto-scaled to maximum display size. It decreases only when the signal quality becomes marginal. Pleth wave size is NOT directly proportional to the pulse volume.

Pulse Oximetry Measurement

The ECG-SpO₂ TRx⁺ Transceiver supports an SpO₂ sensor connection using Fourier Artifact Suppression Technology (FAST). The FAST algorithm overcomes many of the issues associated with traditional pulse oximetry such as sensitivity to patient movement and intense ambient light. The algorithm offers improved motion artifact rejection as well as performance improvements for patients with low perfusion. SpO₂ can be measured continuously, where a value is sent to the Information Center every second, or as a single, individual measurement (Spot Check). The Spot Check measurement will be removed from the Information Center display after 1 hour. If 1-minute or 5-minute sampling rate is selected at TeleMon, the transceiver will provide Continuous SpO₂ measurement after disconnection (see “Transceiver Operation when Connected to TeleMon” on page 9-19).

The SpO₂ parameter measures the arterial oxygen saturation, that is, the percentage of oxygenated hemoglobin in relation to the total hemoglobin.

If, for example, a total of 97% of the hemoglobin molecules in the red blood cells of the arterial blood combine with oxygen, then the blood has an oxygen saturation of 97%. The SpO₂ numeric that appears on the monitor will read 97%. The SpO₂ numeric indicates the percentage of hemoglobin molecules which have combined with oxygen molecules to form oxyhemoglobin.

- The oxygen saturation is measured using the pulse oximetry method. This is a noninvasive method of measuring the arterial hemoglobin oxygen saturation. It measures how much light, sent from light sources on one side of the sensor, travels through patient tissue (such as a finger or an ear), to a receiver on the other side of the sensor.

Pulse Oximetry Measurement

- The amount of light passing through depends on many factors, most of which are constant, such as tissue or venous blood. However one of the factors, the blood flow in the arterioles, varies with time - because it is pulsatile.

This measurement principle is used to derive the SpO₂ measurement. The numeric that is displayed at the Information Center is the oxygen saturation of the arterial blood - the measurement of light absorption during a pulsation. Correct placement of the sensor is essential for accurate measurements (see “Applying the Sensor” on page 8-11).

Note—Because pulse oximeter equipment measurements are statistically distributed, only about two-thirds of pulse oximeter equipment measurements can be expected to fall within ± 1 Arms of the value measured by a CO-oximeter.

Pulse Tone Indication

During Spot Check measurement initiated at the transceiver, the pulse signal is detected and communicated to you via an auditory signal at the transceiver. The indicator is a single low-pitched tone for each pulse detected; it ceases when a measurement is complete. The tone is controlled by the Volume and Mute controls at the Information Center.

Since it is possible to have a strong pulse but fail an SpO₂ measurement, you should listen for the successful completion of a measurement (single beep), or a double beep if the measurement fails.

The pulse indicator is for information only, and should not be used as an indication for treatment. The indicator is not functional in Continuous measurement mode, and no tones, for pulse indication or successful/failed measurement, are generated when Spot Check is initiated remotely from the Information Center.

Clinical Note: If the transceiver is in Spot Check mode, and the sensor light is illuminated but you do not hear a low-pitch sound synchronized with the pulse, readjust the sensor, or move the sensor to another site to provide better detection. (Adjustable sounds must be on.)

Selecting a SpO₂ Sensor

Warning

Use only Philips-approved accessories. Use of product accessories (ECG leadsets, SpO₂ sensors, etc.) other than those specified in this manual may:

- lead to patient injury
- result in increased electromagnetic emissions or decreased immunity of the product

Warning

Reuse: Never reuse disposable sensors, accessories and so forth that are intended for single use, or single patient use only.

Packaging: Do not use a sterilized accessory if the packaging is damaged.

Warning

Do not use disposable sensors on patients who exhibit allergic reactions to the adhesive.

Warning

When the specified Nellcor® sensors are used, the application must be consistent with the sensor manufacturer's own guidelines.

Selecting a SpO₂ Sensor

Philips reusable sensors in adult, pediatric and infant models can be used, as well as Philips and Nellcor® disposable sensors. If you are using Nellcor® sensors, see the Directions for Use supplied with these sensors.

Caution

Do not use OxiCliq disposable sensors in a high humidity environment, or in the presence of fluids. These can contaminate sensor and electrical connections, and thereby cause unreliable or intermittent measurements.

The following table and chart will help you in selecting the correct sensor type.

Sensor Type	When to Use
Reusable	<p>You can use reusable sensors on different patients after cleaning and disinfecting them. For care and cleaning instructions, see the instructions accompanying the sensors. Reusable sensors should be changed to another site every 2-3 hours or in accordance with your clinical practice guidelines.</p> <p>See the Directions for Use supplied by Nellcor® Incorporated for instructions on preparation and application of reusable sensors.</p>
Disposable	<p>Use disposable sensors only once and then discard. However, you can relocate them to a different patient-site if the first location does not give the desired results. Do not reuse disposable sensors on different patients.</p> <p>See the Directions for Use supplied by Nellcor® Incorporated for instructions on preparation and application of disposable sensors.</p>

Selecting a SpO₂ Sensor

To use the chart:

Find the patient's weight on the vertical axes. On the horizontal axis at this weight, the shaded areas indicate that the sensor is a "best choice" for the patient. Unshaded areas indicate a "good choice." For example, the best reusable sensor for a 50 kg patient is the M1191A, applied to the finger or toe. Alternatively, you could use M1194A applied to the ear. Alternatively, you could use M1194A applied to the ear. For a complete listing of available sensors, see "SpO₂ Accessories" on page A-6.

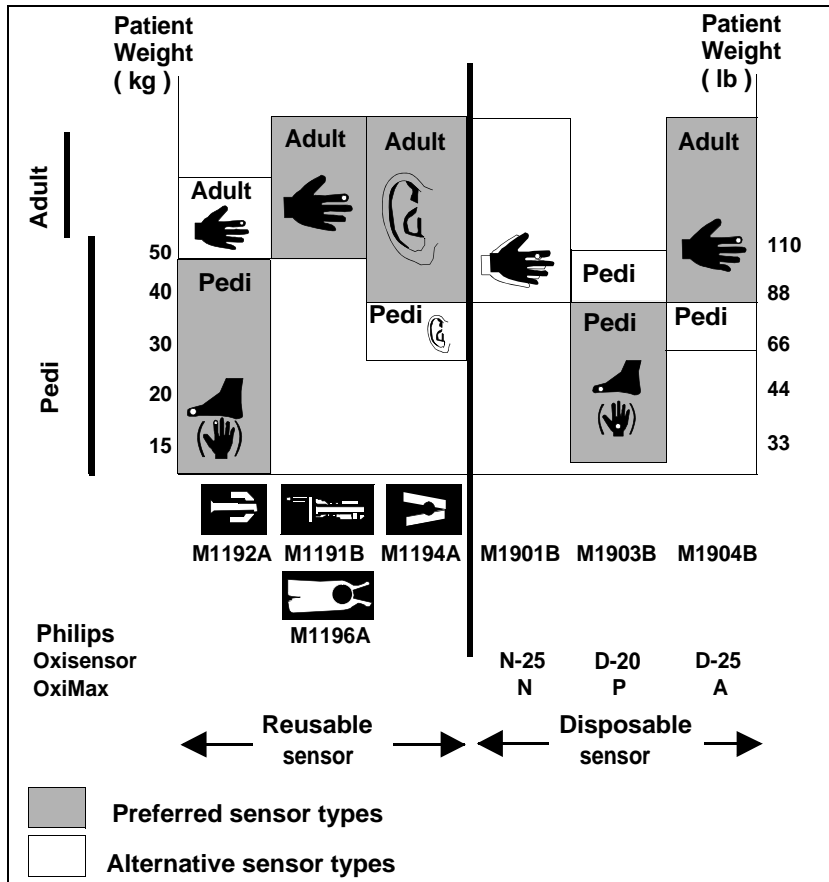

Selecting an SpO₂ Sensor

Applying the Sensor

Sensor Application Safety Information

Warning

Failure to apply a sensor properly can reduce the accuracy of the SpO₂ measurement.

Loose/Tight sensor: If a sensor is too loose, it can compromise the optical alignment or fall off. If it is too tight, for example because the application site is too large or becomes too large due to edema, excessive pressure can be applied. This can result in venous congestion distal from the application site, leading to interstitial edema, hypoxia and tissue malnutrition. Skin irritations or ulcerations can occur as a result of the sensor being attached to one location for too long.

To avoid skin irritations and ulcerations, inspect the sensor application site every 2-3 hours, and change the application site at least every 4 hours or according to clinical practice guidelines.

Venous Pulsation: Do not apply sensor too tightly as this results in venous pulsation, which can severely obstruct circulation and lead to inaccurate measurements.

Ambient Temperature: Never apply an SpO₂ sensor at ambient temperatures above 37 °C (99 °F) because this can cause severe burns after prolonged application.

Extremities to Avoid: Avoid sites distal to BP cuff, intra-arterial line, or intravascular venous infusion line.

Applying the Sensor

Site Selection

- Avoid sites with impaired perfusion, skin discoloration, excessive motion or nail polish.
- Avoid placing the sensor in an environment with bright lights (if necessary, cover the sensor with opaque material).
- Avoid use of excessive pressure at the application site (e.g., sensor applied too tightly, excessive adhesive tape to secure the sensor, clothing or restraints that are too tight). These result in venous pulsations and inaccurate measurement, and may severely obstruct circulation.

Sensor Application

A minimum pulsatile flow must be present at the application site of your patient to obtain measurements.

Select an appropriate sensor and apply the sensor properly to avoid incorrect measurements. Applying a small amount of pressure at the application site can improve the measurement. Use one of the preferred application sites for your sensor. Selecting the most suitable sensor and application site will help you to ensure that:

- The light emitter and the photo detector are directly opposite each other and that all the light from the emitter passes through the patient's tissues,
- The application site is of the correct thickness for light to pass through. If the application site is too thick or too thin, an SpO₂ NON-PULSATILE technical alarm will occur. You should then select another site as appropriate.

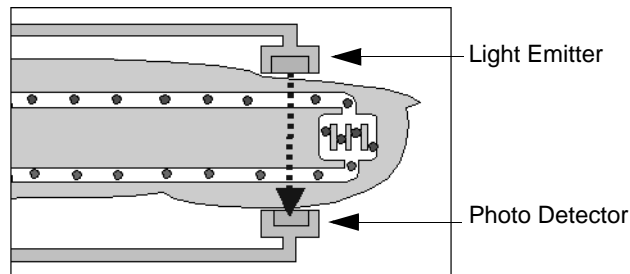

Positioning of the Light Emitter and Photo Detector

Inspect the application site every 2 to 3 hours or according to clinical practice guidelines to ensure skin integrity and correct optical alignment. If skin integrity changes, move the sensor to another site.

Follow the sensor's instructions for use, adhering to all warnings and cautions.

To apply the sensor, use the following directions.

Step	Action
1	Select the site and appropriate sensor (see "Selecting a SpO ₂ Sensor" on page 8-7).
2	Apply the sensor to the appropriate part of the patient's body. <i>Note</i> —The application site should match the sensor size so that the sensor can neither fall off nor apply excessive pressure.
3	Check that the light emitter and the photo detector are directly opposite each other. All light from the emitter must pass through the patient's tissue.

Adult Finger sensor (M1191A/B)

Push the sensor over the fingertip in such a way that the fingertip touches but does not protrude from the end of the sensor. The fingertip must be uppermost and the cable must lie on the back of the hand. This ensures that the light source cover the base of the fingertip giving the best measurement results. The cable can be held in place by the accompanying wristband.

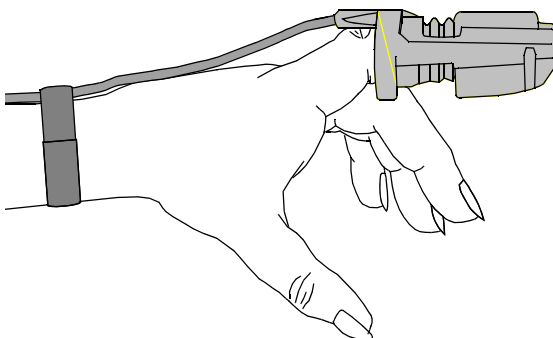

Applying the Sensor

Small Adult/ Pediatric Finger sensor (M1192A)

Push the sensor over the fingertip in such a way that the fingertip touches but does not protrude from the end of the sensor.

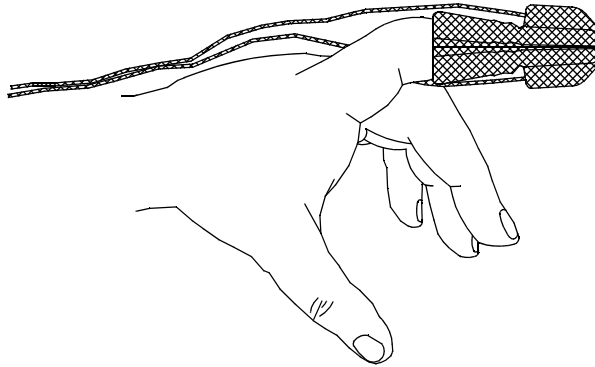

Ear Clip sensor (M1194A)

Clip the probe onto the fleshy part of the ear lobe as shown in the diagram below. The plastic fixing mechanism helps to minimize artifact generated by patient motion. Do not position the probe on cartilage or where it presses against the head.

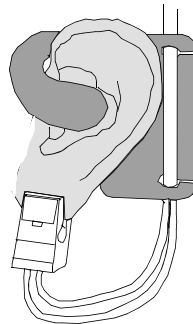

The clip sensor can be used as an alternative if the adult finger sensor does not provide satisfactory results. The preferred application site is the ear lobe, although other application sites with higher perfusion (such as the nostril) can be used. Due to the physiologically lower perfusion in the ear lobe, you should be aware of the reduced accuracy of the measurement and more frequent technical alarms.

Connecting the SpO₂ Cable

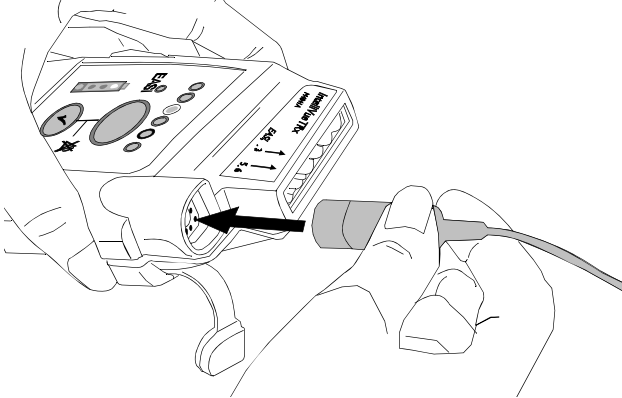
Step	Action
1	<p>Connect the sensor cable to IntelliVue TRx⁺.</p> <ul style="list-style-type: none"> • Connect <i>reusable</i> sensors directly into the transceiver. • Connect <i>disposable</i> sensors into the adapter cable, then connect the adapter cable to the transceiver. Remove the protective backing. 
2	Adjust SpO ₂ alarms in the Patient Window (see “Telemetry Controls in the Patient Window” on page 9-2).
3	Make other adjustments in the Telemetry Setup Window (see “Patient Configurable Settings in Telemetry Setup” on page 9-6).

Caution

Extension cables: The use of extension cables presents a tripping hazard. Use appropriate care when they are in use.

Electrical Interference: Position the sensor cable and connector away from power cables, to avoid electrical interference.

Measuring SpO₂

Warning

Removal of the SpO₂ sensor during Continuous SpO₂ monitoring results in a "No Sensor" technical alarm. There is no technical alarm for a "No Sensor" condition in Spot Check mode.

Warning

If you measure SpO₂ on a limb that has an inflated NBP cuff, a non-pulsatile SpO₂ technical alarm can occur. If the monitor is configured to suppress this alarm, there can be a delay of up to 60 seconds in indicating critical patient status, such as sudden pulse loss or hypoxia.

SpO₂ measurements can be made manually on an as-needed basis in Spot Check mode, or continuously in Continuous mode, depending on the transceiver configuration. While operating in Continuous mode, you can also measure pulse, and display the pleth wave at the Information Center. The SpO₂ parameter is turned on by inserting/removing the sensor cable into the transceiver, or by control from the Information Center. SpO₂ monitoring consumes considerable electrical energy. The battery power must be at least 25% full in order to make SpO₂ measurements.

Setting the mode to Spot Check or Continuous is done at the Information Center (see "Patient Configurable Settings in Telemetry Setup" on page 9-6) or at the monitor.

Spot Check Measurement

When the transceiver is configured for Spot Check measurement, use the following instructions to take an individual, manual SpO₂ reading from the transceiver.

Note—You can also initiate a Spot Check measurement in the Patient Window at the Information Center by selecting the **Spot Check SpO₂** icon (see “Patient Configurable Settings in Telemetry Setup” on page 9-6).

Note—Spot Check measurements cannot be made when the transceiver is connected to TeleMon because only Continuous measurement is available with this device.

Step	Action
1	Attach the sensor to the patient.
2	Connect the SpO ₂ cable to IntelliVue TRx ⁺ , and check that: <ul style="list-style-type: none"> • The SpO₂ sensor light turns on. • A low-pitch tone detecting each pulse is audible (unless sounds are muted).
3	After approximately 30 seconds, if the measurement was successful, you’ll hear a single beep from the transceiver. The value, with the measurement time, will be displayed at the Information Center. The sensor light will extinguish. If the measurement was unsuccessful, you’ll hear a double beep. Remove the sensor cable and reinsert it to retake the measurement. <i>Note</i> —The SpO ₂ value and time stamp remain on the Information Center for 1 hour or until another measurement is taken, with one exception: If the batteries are removed from the transceiver, the Spot Check measurement will be erased from the display; however, the SpO ₂ measurements will be available in Trend Review.
4	To repeat a Spot Check measurement at the bedside, disconnect then reconnect the SpO ₂ cable to the transceiver.

Continuous Measurement

When the transceiver is configured for Continuous SpO₂ measurement (see “Patient Configurable Settings in Telemetry Setup” on page 9-6), use the following directions to initiate Continuous SpO₂ monitoring.

Step	Action
1	Insert the SpO ₂ cable into the IntelliVue TRx ⁺ , and check that the sensor light turns on.
2	Attach the sensor to the patient.
3	<p>After approximately 15 seconds, the value, with the measurement time, is displayed at the Information Center.</p> <p><i>Note</i>—There are no sounds associated with continuous SpO₂ measurement.</p>
4	<p>To discontinue SpO₂ monitoring, uncheck the Enable SpO₂ box at the Information Center.</p> <p><i>Note</i>— If the sensor is removed without discontinuing SpO₂ monitoring in the Telemetry Setup Window at the Information Center, an SpO₂T NO SENSOR technical alarm will result. Silencing this technical alarm will turn the SpO₂ measurement off.</p>

Displaying Pulse Rate

When operating in Continuous mode, you can view the Pulse rate at the Information Center. See “Patient Configurable Settings in Telemetry Setup” on page 9-6.

Note—If Pulse rate is turned on, the Patient Sector and Patient Window of the Information Center display the parameter label with “T” (for example, “PulseT”) to indicate that the measurement was made via telemetry.

Displaying Pleth Wave

The transceiver can be configured to transmit the Pleth wave for display at the Information Center. See “Patient Configurable Settings in Telemetry Setup” on page 9-6.

When Connected to TeleMon

When the transceiver is connected to TeleMon:

- The SpO₂ measurement mode is *always* Continuous.
- You can change the mode. Changes to the mode take effect when the transceiver is disconnected from TeleMon. The following settings will be used:

Mode Set at TeleMon	Mode when Transceiver is Disconnected
Continuous	Continuous
5-minute	Continuous
1-minute	Continuous
Manual	Spot Check

Turning SpO₂ Monitoring Off

To turn SpO₂ monitoring off, disconnect the sensor cable from the transceiver. SpO₂ enters a power-down mode after the cable is disconnected from the transceiver, thereby conserving battery life.

It is important to disconnect the sensor from the transceiver in order to conserve battery life. Unplugging the sensor from an adapter cable that is connected to the transceiver does NOT provide SpO₂ power-down mode.

SpO₂ should also be turned off at the Information Center. If the transceiver is configured for Continuous SpO₂ measurement and the sensor is removed without turning SpO₂ off, a SpO₂T NO SENSOR technical alarm will result. Silencing this technical alarm will turn the SpO₂ measurement off.

SpO₂ Enable/ Disable at Information Center

You can enable/disable SpO₂ monitoring at the Information Center. See “Patient Configurable Settings in Telemetry Setup” on page 9-6.

When SpO₂ is enabled, the Patient Sector and Patient Window of the Information Center display a “T” next to the SpO₂ numeric (for example, “SpO₂T 90%”) to indicate that the measurement was made via telemetry.

SpO₂ Auto ON at Information Center

The SpO₂ parameter is automatically enabled at the IntelliVue Information Center if a manual SpO₂ measurement is initiated at the transceiver while in Spot Check mode or if the SpO₂ sensor is inserted into the transceiver while the transceiver is in Continuous SpO₂ mode.

When a patient is discharged and the transceiver is in Continuous mode, the SpO₂ parameter is disabled. To reactivate the SpO₂ parameter Auto ON feature from the transceiver, remember to do one of the following when a patient is discharged:

- remove the SpO₂ cable from the transceiver, wait 15 seconds, then reinsert the cable

or

- if using TeleMon, reset the transceiver to Manual mode.

Note—The SpO₂ parameter Auto ON feature only needs to be reactivated when the transceiver is in Continuous mode at discharge.

Note—SpO₂ can always be enabled/disabled at the IntelliVue Information Center.

Understanding SpO₂ Alarms

Physiologic SpO₂ alarms are generated and displayed at the Information Center. SpO₂ offers high and low limit alarms, and a high priority (red level) oxygen desaturation alarm. The SpO₂ low limit can be set between 50 and 99% inclusive, in 1% increments. The desaturation limit is set automatically at 10 below the Low Limit. The SpO₂ high alarm limit can be set between 51 and 100% inclusive, in 1% increments.

The delay between the physiologic alarm condition and alarm annunciation at the Information Center is ≤ 16 seconds. This means that the Information Center will generate an alarm if the averaged numeric value on the display exists beyond the alarm limit for more than a maximum of 16 seconds.

Setting the high SpO₂ alarm limit to 100% is equivalent to switching off the high alarm. Therefore the upper alarm limit for oxygen saturation must be carefully selected in accordance with accepted clinical practices.

The default setting for SpO₂ yellow alarms is latched. That is, when an SpO₂ limit is exceeded, you will need to acknowledge it at the Information Center. The sound will be silenced but the message will remain on the display until the condition is resolved.

See Chapter 5, “Alarms” for a list of the SpO₂ alarms.

Optimizing SpO₂ Measurement Performance

Refer to this section on problem situations if you have difficulty getting a signal or obtaining accurate measurements.

Distortion

Ambient light, motion, perfusion or incorrect sensor placement can affect the accuracy of the derived measurements.

Arterial Blood Flow

The measurement depends on the pulsatile nature of blood flow in the arteries and arterioles; with the following conditions arterial blood flow can be reduced to a level at which accurate measurements cannot be made:

- shock
- hypothermia
- use of vasoconstrictive drugs
- anemia

Wavelength Absorption

The measurement also depends on the absorption of particular light wavelengths by the oxyhemoglobin and reduced hemoglobin. If other substances are present which absorb the same wavelengths, they will cause a falsely high, or falsely low SpO₂ value to be measured. For example:

- carboxyhemoglobin
- methemoglobin
- methylene blue
- indocyanine green*
- indiocarmine*

*These chemicals are used in dye dilution cardiac output calculations.

Ambient Light

Very high levels of ambient light can also affect the measurement; an "SpO₂ Interference" message will appear on the display. The measurement quality can be improved by covering the sensor with suitable opaque material.

Care and Cleaning

For care and cleaning instructions, see the instructions accompanying the sensors.

Sensor Wear

Normal wear and tear associated with patient movement and regular sensor cleaning typically mean that the sensor will have a limited lifetime. However, provided you handle the sensor and its cable with care, you can expect useful service from it for up to two years. Harsh treatment will drastically reduce the lifetime of the sensor. Moreover, Philips Medical Systems' warranty agreement shall not apply to defects arising from improper use.

To get the best results from your SpO₂ reusable sensor:

- Always handle the sensor and cable with care. The soft finger sleeve houses a sensitive electronic device that can be damaged by harsh treatment. Always protect the cable from sharp-edged objects.
- Use the wristband that is supplied with your M1191A sensor. By keeping the cable between the finger sensor and the wristband fairly loose, you will maintain good monitoring conditions.

Telemetry Functions at the Information Center & TeleMon

This chapter describes the telemetry functions at the Information Center, as well as the differences in transceiver operation when connected to TeleMon. It includes the sections listed below. For additional information, consult the *IntelliVue Information Center Instructions for Use* and *TeleMon Instructions for Use*.

- Telemetry Functions at the Information Center 9-2
 - Telemetry Controls in the Patient Window 9-2
 - Locating the Transceiver (Find Device). 9-3
 - Patient Configurable Settings in Telemetry Setup 9-6
 - Unit-Configurable Settings 9-9
- Transceiver Operation when Connected to TeleMon. 9-19

Telemetry Functions at the Information Center¹

Telemetry Controls in the Patient Window

The Patient Window at the Information Center (accessed from the Patient Window control in the Patient Sector) includes controls for a number of telemetry operations. For detailed instructions on these operations, see the *IntelliVue Information Center Instructions for Use* or the *Online Help*.

To View ECG or SpO₂ Alarm Limits

Move the cursor over the HR or SpO₂ label to display the current high and low alarm limits.

To Change ECG or SpO₂ Alarm Limits

Move the cursor over the High or Low numeric to display up/down arrow controls for adjusting the limit. After adjusting the limit, move the cursor away from the area to dismiss the limit controls.

To Change ECG Waveform Size

Move the cursor over the ECG waveform to display the ECG Waveform Size control. Select the desired size from the list.

To Select Lead

Move the cursor over the ECG waveform to display the Lead Selection control. Select the desired lead from the list.

Important—Do not set the primary and secondary channels to the same lead.

To Change Va and Vb Default Lead Settings (6-lead only)

Move the cursor over the ECG waveform to display the Lead Selection popup. Select the label from the label list. For Va or Vb, select Va or Vb, then select the lead to be assigned. Assignment of the same V lead to both Va and Vb is not allowed.

Important—Do not set the primary and secondary channels to the same lead.

1. For information on ST functions performed at the Information Center, see “ST/AR ST Segment Algorithm” on page 7-7.

To Initiate a Spot Check Measurement

Move the cursor over the SpO₂ label. Then click on the Spot Check icon.

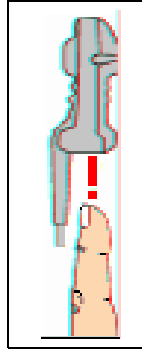

Note—There is no audio feedback at the transceiver (pulse tone or successful/failed measurement) when Spot Check is initiated at the Information Center.

To Initiate Standby

See instructions under “Standby Mode” on page 4-4.

Locating the Transceiver (Find Device)

The Find Device feature enables you to generate an alternating pitch repeated tone at the transceiver to assist in locating a missing device. This function is initiated in the Telemetry Setup Window. Find Device requires that the transceiver has good working batteries and is within the coverage area. The device will not return from out-of-range until association with the Information Center is re-established.

To locate a transceiver

Step	Action
1	From the Patient Window, select Telemetry Setup .
2	Select Find Device to generate a repeated tone at the transceiver.

To silence the sound

Step	Action
1	Press and hold the Check button to turn off the sound. OR Remove the batteries.

Viewing Device Location in the Patient Window (optional)

You can see the location of a transceiver in the Patient Window. The Device Location information is identified in the Patient Window by a compass icon followed by the location name configured by your hospital for your system. If the location of the transceiver changes, the Patient Window is updated within 5 seconds of the location change.

Viewing Device Location History (optional)

You can view the location history for a particular transceiver in the Device Location History field in the Telemetry Setup window. The field displays the five most recent Device Location descriptions in ascending order and updates every time there is a change in location for the device. The total timespan of the log is 60 minutes.

Note—If there is a change in location while viewing the Telemetry Setup window, you must re-enter Telemetry Setup to see the change, as it does not update automatically.

Using the Device Location Client (optional)

The Device Location Client application is an optional software application that allows you to display and locate devices visually, using Floor Plans associated with your hospital's layout. Device location history is also available. The application is accessible using a separate PC's web browser. For additional installation information, see the *IntelliVue Device Location Installation Guide*.

Warning

Because the coverage range of Access Points can sometimes overlap, including different floor levels, the IntelliVue Device Location feature is not intended for use when attempting to locate a patient.

Displaying and Locating Devices

The left side of the Client display screen contains a list of clinical units associated with the current Floor Plan. Each unit contains a list of bed labels. You view the beds listed within a unit by clicking on the plus sign next to the unit name.

Note—The beds listed are only those equipped with IntelliVue telemetry devices.

To identify and locate the telemetry device associated with the bed, simply click on the desired bed label. The floor plan and the status bar above the floor plan image now display the location of the device. Additionally, the status bar lists the Access Point the device is currently associated with.

Viewing Device Location History

The location history of a particular telemetry device is also available. Select a device from the Device List box and then click on the down arrow in the status bar. The last five known locations of the device are displayed.

Patient Configurable Settings in Telemetry Setup

The Telemetry Setup window enables you to configure the transceiver for patient-specific settings. All patient-specific settings will be reset to the unit defaults upon patient discharge. To access the window, from the Patient Window click Telemetry Setup.

The following settings can be adjusted in this window.

Patient-Configurable Settings in Telemetry Setup			
Control	Function	Setting Choices	Factory Default
Telemetry Button	Determine the Information Center response when Telemetry Button is pressed.	<i>Nurse Call</i> - generate nurse call alarm <i>Record</i> - generate a recording strip <i>Nurse Call and Record</i> - generate nurse call alarm and recording strip <i>None</i>	Nurse Call
Telemetry Device: Volume	Set the volume level for all adjustable sounds on the transceiver.	1 (low), 2, 3, 4, 5 (high)	3
Telemetry Device: Mute	Enable the ability to mute the Spot Check and pulse detection tones on the transceiver.	<i>enable</i> (mute) <i>disable</i>	enable
Fixed Pacer Amplitude	Sets the appearance of the pacer spikes to a fixed size as they appear in the patient window.	<i>enable</i> <i>disable</i>	disable

Patient-Configurable Settings in Telemetry Setup			
Control	Function	Setting Choices	Factory Default
SpO₂ Enabled	Enable/disable the SpO ₂ measurement at the Information Center or Telemon.	<i>enable</i> <i>disable</i>	enable
SpO₂ Mode	Determine the transceiver SpO ₂ behavior. <i>Note</i> —Pulse Rate and Pleth Wave are not available in <i>Spot Check</i> .	<i>Spot Check</i> - Provides manual measurements so the clinician can check as needed. Measurement initiated by plugging the SpO ₂ cable into the transceiver or by selecting the Spot Check SpO ₂ icon in the Patient Window. No pulse or successful/failed measurement tones are generated when measurement is initiated at Information Center. <i>Continuous</i> - Sends an SpO ₂ parameter value to the Information Center every second. If selected, Pulse Rate and Pleth Wave may also be sent.	Spot Check

Patient-Configurable Settings in Telemetry Setup			
Control	Function	Setting Choices	Factory Default
Suppress SpO₂ INOPs with NBP	<p>Enable/disable the SpO₂ algorithm to suppress sending technical alarms from the transceiver during an NBP measurement for 60 seconds.</p> <hr/> <p>Warning</p> <p>If you measure SpO₂ on a limb that has an inflated NBP cuff, a non-pulsatile SpO₂ technical alarm can occur. If the monitor is configured to suppress this alarm, there can be a delay of up to 60 seconds in indicating critical patient status, such as sudden pulse loss or hypoxia.</p> <hr/>	<p><i>enable</i></p> <p><i>disable</i></p>	enable
Pleth Wave	<p>Enable/disable the transmission of the Pleth wave (and its subsequent display) to the Information Center. For Continuous SpO₂ mode only.</p> <p><i>Note</i>—When enabled, the Pleth wave replaces the Vb wave in the Patient Window during 6-lead monitoring.</p>	<p><i>enable</i></p> <p><i>disable</i></p>	disable (Pleth is not displayed.)
Pulse	<p>Enable/disable display of the Pulse rate at the Information Center. For Continuous SpO₂ mode only.</p>	<p><i>enable</i></p> <p><i>disable</i></p>	disable (Pulse rate is not displayed.)

Patient-Configurable Settings in Telemetry Setup			
Control	Function	Setting Choices	Factory Default
SpO₂ Alarm	Turn SpO ₂ alarms on/off at the Information Center.	<i>enable</i> (on) <i>disable</i> (off)	enable
Unit Settings	Change current settings back to last saved clinical unit settings.	(none)	

Unit-Configurable Settings

Unit Settings provide access to clinical configuration items that affect all patients on an Information Center. Changes in unit settings take effect upon discharge, except for Standby duration and SpO₂ mode, which take effect immediately.

Access to unit settings requires a password, and the displays are in English. Telemetry specific settings are accessed through All Controls -> Unit Settings -> Telemetry Setup. The setting for telemetry non-arrhythmia yellow alarms is located in All Controls -> Unit Settings -> Alarms Unit Settings. For all other information on unit settings, see *IntelliVue Information Center Instructions for Use*.

Unit Settings - Telemetry Setup			
Control	Function	Settings	Factory Default
Patient Type	Set patient type used for SpO ₂ and NBP alarm limits.	<i>Adult</i> <i>Pediatric</i>	Adult

Telemetry Functions at the Information Center

Unit Settings - Telemetry Setup			
Control	Function	Settings	Factory Default
Telemetry Button	Determine the Information Center response when Telemetry Button is pressed.	<i>Nurse Call</i> - generate nurse call alarm <i>Record</i> - generate a recording strip <i>Both</i> - generate nurse call alarm and recording strip <i>None</i>	Nurse Call
Telemetry Device: Volume	Set the volume level for all adjustable sounds on the transceiver.	1 (low) to 5 (high)	3
Telemetry Device: Mute	Enable/disable all adjustable sounds on the transceiver.	<i>enable</i> (unchecked) = sound <i>disable</i> (checked) = mute	mute
Standby Duration	Sets the standby duration on the device.	<i>Infinite</i> <i>10 minutes</i> <i>20 minutes</i> <i>30 minutes</i> <i>1 hour</i> <i>2 hours</i> <i>3 hours</i> <i>4 hours</i>	Infinite
Enable Remote Suspend	Enable/disable alarm pause/suspend at the transceiver.	<i>enable</i> <i>disable</i>	disable

Unit Settings - Telemetry Setup			
Control	Function	Settings	Factory Default
Suspend Duration	Sets the alarm suspend duration time for each assigned device on the Information Center.	<i>1, 2, or 3 minutes</i>	2 minutes
Battery Gauge on Information Center	Display/disable a battery gauge for each assigned device on the Information Center. <i>Note</i> —Set to <i>disable</i> if rechargeable batteries are being used.	<i>enable</i> <i>disable</i>	enable (battery gauge is displayed)
RF Auto Shutoff	Enable/disable RF operation during an extended situation of all leads off for more than 10 minutes and the SpO ₂ sensor is not connected.	<i>enable</i> <i>disable</i>	enable
Fixed Pacer Amplitude	Sets the appearance of the pacer spikes to a fixed size as they appear in the patient window.	<i>enable</i> <i>disable</i>	disable
Autopair	Enable/disable the autopairing of the transceiver and the IntelliVue Patient Monitor at the Information Center.	<i>enable</i> <i>disable</i>	enable
Enable SpO₂	Enable/disable the SpO ₂ measurement at the Information Center or Telemon.	<i>enable</i> <i>disable</i>	enable

Telemetry Functions at the Information Center

Unit Settings - Telemetry Setup			
Control	Function	Settings	Factory Default
SpO₂ Mode	<p>Determine the transceiver SpO₂ behavior.</p> <p><i>Note</i>—Pulse Rate and Pleth Wave are not available in <i>Spot Check</i>.</p>	<p><i>Spot Check</i> - Provides manual measurements so the clinician can check as needed. Measurement initiated by plugging the SpO₂ cable into the transceiver or by selecting Spot Check SpO₂ icon in the Patient Window. No pulse or successful/failed measurement tones are generated when measurement is initiated at Information Center.</p> <p><i>Continuous</i> - Sends an SpO₂ parameter value to the Information Center every second. If selected, Pulse Rate and Pleth Wave may also be sent.</p>	Spot Check

Unit Settings - Telemetry Setup			
Control	Function	Settings	Factory Default
Suppress SpO₂ Inops with NBP	<p>Enable/disable the SpO₂ algorithm to detect NBP running and suppress sending technical alarms from the transceiver for 60 seconds.</p> <hr/> <p>Warning</p> <p>If you measure SpO₂ on a limb that has an inflated NBP cuff, a non-pulsatile SpO₂ technical alarm can occur. If the monitor is configured to suppress this alarm, there can be a delay of up to 60 seconds in indicating critical patient status, such as sudden pulse loss or hypoxia.</p> <hr/>	<p><i>enable</i></p> <p><i>disable</i></p>	enable
Pleth Wave	<p>Enable/disable the transmission of the Pleth wave and its subsequent display to the Information Center. For Continuous mode only.</p>	<p><i>enable</i></p> <p><i>disable</i></p> <p><i>Note</i>—When enabled, during 6-lead monitoring, the Pleth wave will replace the Vb wave in the Patient Window.</p>	<p>disable (Pleth wave is not displayed.)</p>
Pulse	<p>Enable/disable the transmission of the Pulse rate and its subsequent display to the Information Center. For Continuous mode only.</p>	<p><i>enable</i></p> <p><i>disable</i></p>	<p>disable (Pulse rate is not displayed.)</p>

Telemetry Functions at the Information Center

Unit Settings - Telemetry Setup			
Control	Function	Settings	Factory Default
SpO₂ Alarm	Turn SpO ₂ alarms on/off at the Information Center.	<i>enable</i> (on) <i>disable</i> (off)	enable
SpO₂ Limits High	Increment/decrement SpO ₂ high alarm limit by 1 (in %).	Limit maximum is 100. Limit minimum is 51 (adult) or 31 (pediatric). High and low limit must be at least 1% apart.	100 (adult, pediatric)
SpO₂ Limits Low	Increment/decrement SpO ₂ low alarm limit by 1 (in %).	Limit maximum is 99. Limit minimum is 50 (adult) or 30 (pediatric). High and low limit must be at least 1% apart.	90 (adult, pediatric)

Unit Settings - Default Leads			
Control	Function	Settings	Factory Default
Leadset Allowed	Set the unit default leadset type.	All, EASI, No EASI, 3 wire	All
3-wire	Set the unit default lead.	<i>I, II, III</i>	II
5-wire, ECG1	Set the unit default lead.	<i>I, II, III, MCL, AVR, AVL, AVF, V</i>	II
5-wire, ECG2	Set the unit default lead.	<i>I, II, III, MCL, AVR, AVL, AVF, V</i>	V

Unit Settings - Default Leads			
Control	Function	Settings	Factory Default
5-wire, ECG3	Set the unit default lead.	<i>I, II, III, MCL, AVR, AVL, AVF, V</i>	III
5-wire EASI, ECG1	Set the unit default lead.	<i>I, II, III, AVR, AVL, AVF, V₁, V₂, V₃, V₄, V₅, V₆</i>	II
5-wire EASI, ECG2	Set the unit default lead.	<i>I, II, III, AVR, AVL, AVF, V₁, V₂, V₃, V₄, V₅, V₆</i>	V ₂
5-wire EASI, ECG3	Set the unit default lead.	<i>I, II, III, AVR, AVL, AVF, V₁, V₂, V₃, V₄, V₅, V₆</i>	III
5-wire EASI, ECG4	Set the unit default lead.	<i>I, II, III, AVR, AVL, AVF, V₁, V₂, V₃, V₄, V₅, V₆</i>	V ₅
6-wire, ECG1	Set the unit default lead.	<i>I, II, III, MCL, AVR, AVL, AVF, V₁, V₂, V₃, V₄, V₅, V₆, V₇, V₈, V₉, V_{3R}, V_{4R}, V_{5R}</i>	II
6-wire, ECG2	Set the unit default lead.	<i>I, II, III, MCL, AVR, AVL, AVF, V₁, V₂, V₃, V₄, V₅, V₆, V₇, V₈, V₉, V_{3R}, V_{4R}, V_{5R}</i>	V ₂ ; V lead choice is determined by Va and Vb settings
6-wire, ECG3	Set the unit default lead.	<i>I, II, III, MCL, AVR, AVL, AVF, V₁, V₂, V₃, V₄, V₅, V₆, V₇, V₈, V₉, V_{3R}, V_{4R}, V_{5R}</i>	III

Unit Settings - Default Leads			
Control	Function	Settings	Factory Default
6-wire, ECG4	Set the unit default lead.	<i>I, II, III, MCL, AVR, AVL, AVF, V₁, V₂, V₃, V₄, V₅, V₆, V₇, V₈, V₉, V_{3R}, V_{4R}, V_{5R}</i>	V ₅ ; V lead choice is determined by Va and Vb settings

Unit Settings - NBP Setup			
Control	Function	Settings	Factory Default
Patient Type	Set patient type used for NBP alarm limits.	<i>Adult</i> <i>Pediatric</i>	Adult
NBP Alarm	Set NBP alarm notification.	<i>Systolic or Diastolic</i> <i>Systolic</i> <i>Diastolic</i> <i>Mean</i> <i>Off</i>	Systolic or Diastolic
Systolic High	Increment/decrement NBP high alarm limit by 1.	<i>Limit Maximum is 260</i> <i>Limit Minimum is 160 (Adult)</i> <i>Limit Maximum is 260</i> <i>Limit Minimum is 75 (Ped.)</i>	160 Adult 120 Pediatric

Unit Settings - NBP Setup			
Control	Function	Settings	Factory Default
Systolic Low	Increment/decrement NBP low alarm limit by 1.	<i>Limit Maximum is 155</i> <i>Limit Minimum is 28 (Adult)</i> <i>Limit Maximum is 255</i> <i>Limit Minimum is 28 (Ped.)</i>	90 Adult 70 Pediatric
Diastolic High	Increment/decrement NBP high alarm limit by 1.	<i>Limit Maximum is 260</i> <i>Limit Minimum is 90 (Adult)</i> <i>Limit Maximum is 260</i> <i>Limit Minimum is 45 (Ped.)</i>	90 Adult 70 Pediatric
Diastolic Low	Increment/decrement NBP low alarm limit by 1.	<i>Limit Maximum is 85</i> <i>Limit Minimum is 28 (Adult)</i> <i>Limit Maximum is 40</i> <i>Limit Minimum is 28 (Ped.)</i>	50 Adult 40 Pediatric
Mean High	Increment/decrement NBP high alarm limit by 1.	<i>Limit Maximum is 260</i> <i>Limit Minimum is 65 (Adult)</i> <i>Limit Maximum is 260</i> <i>Limit Minimum is 55 (Ped.)</i>	110 Adult 90 Pediatric
Mean Low	Increment/decrement NBP low alarm limit by 1.	<i>Limit Maximum is 60</i> <i>Limit Minimum is 28 (Adult)</i> <i>Limit Maximum is 50</i> <i>Limit Minimum is 28 (Ped.)</i>	60 Adult 50 Pediatric

Unit Settings - Alarms			
Control	Function	Settings	Factory Default
Non-arrhythmia Yellow Alarms	Set latched/non-latched status for SpO ₂ , ST, and other non-arrhythmia yellow alarms.	<i>Latched</i> <i>Non-latched</i>	Latched
Leads Off	Adjust the severity level of this technical alarm (INOP).	<i>Cyan</i> <i>Yellow</i> <i>Red</i>	Cyan
Replace Battery	Adjust the severity level of this technical alarm (INOP).	<i>Cyan</i> <i>Yellow</i> <i>Red</i>	Cyan

RF Auto Shutoff

When RF Auto Shutoff is enabled (default), the transceiver stops broadcasting a radio signal in order to prevent interference with other transceivers in use. This condition occurs if there is no ECG signal for 10 minutes and the SpO₂ sensor cable is *not* inserted in the SpO₂ sensor port. The technical alarm, "No Signal", followed by the "Transmitter Off" INOP will be displayed at the Information Center. Remove the batteries to conserve battery charge. However, if there is no ECG signal for 10 minutes but the SpO₂ cable *is* inserted, the transceiver does not stop broadcasting the signal. This feature can be disabled in Telemetry Setup - Unit Settings.

Transceiver Operation when Connected to TeleMon

When connected to TeleMon, the following differences in transceiver operation will be in effect.

Important—The transceiver must have good batteries installed before being connected to TeleMon.

Alarms

- Alarm Suspend/Pause and Standby can be initiated only from TeleMon, not from the transceiver or the Information Center. The alarm suspend indicator on the transceiver will accurately reflect the current state of alarm pause.

Note—If the transceiver is connected to TeleMon, silencing an active alarm at TeleMon silences the alarm at TeleMon only. It has no effect on the alarms at the Information Center.

ECG Operation

- Vb, the second V-lead in 6-wire lead-set, is not supported.
- After a change in leadset, the TeleMon returns to the default ECG settings, and arrhythmia relearn occurs automatically. Be sure to check the monitoring leads after you switch leadsets. See “Relearning” on page 6-28.

SpO₂ Operation

- SpO₂ is always in continuous mode.
- Changes in SpO₂ mode do not take effect until after the transceiver is disconnected from TeleMon. Mode settings are defined in the following table:

Mode Selected at TeleMon	Mode at Disconnected Transceiver
Continuous	Continuous
5-min.	Continuous
1-min.	Continuous
Manual	Spot Check

- If the sensor is disconnected from the transceiver during SpO₂ monitoring at TeleMon, a No Sensor technical alarm will be displayed at the Information Center. Visual and auditory indicators for the No Sensor Alarm are not active at Telemon.

Battery

- The transceiver battery status is not available. When the Check button is pressed, the battery gauge on the transceiver and at the Information Center indicates full power, regardless of actual battery strength.

Defibrillation

- In the event of patient defibrillation, it may take several seconds for the ECG trace to reappear on the screen.

Pairing Monitoring Devices

You can display measurement data from IntelliVue TRx and TRx+ Transceivers on IntelliVue Patient Monitors. The transceiver and the monitor must be assigned to the same patient; this is called "pairing". Once paired, the ECG source is automatically detected at the Information Center. Should you subsequently switch the ECG source between the two devices, the change is also automatically detected at the Information Center.

Networked devices and non-networked devices can be paired, however, there are differences in device behavior based on network connection status. Devices can be connected and/or paired via the methods below:

- The transceiver is paired with the monitor at the Information Center (networked devices only).
- The transceiver is directly connected to the monitor using an interface cable (IntelliVue MP5/MP5T Patient Monitor only).
- The transceiver is directly connected to a non-networked monitor using an interface cable to transmit additional parameters (IntelliVue MP5/MP5T Patient Monitor only).
- The transceiver and monitor are connected wirelessly via short-range radio capability (IntelliVue MP5/MP5T, MP2 and X2 Patient Monitors only).
- The transceiver is connected wirelessly via short-range radio capability to an MP5 or X2 Patient Monitor which is connected to a larger host monitor.

This chapter describes how to pair the devices using a direct connection and a wireless, short-range radio connection, and how the devices operate in paired mode (networked and non-networked). It includes the sections listed below. For additional information on monitor operation, consult the *IntelliVue Patient Monitor Instructions for Use*. For additional information on pairing other IntelliVue Patient Monitors at the Information Center, consult the *IntelliVue Information Center Instructions for Use*.

- Networked Devices 10-4
- Alarm Behavior (Networked) 10-9
- Alarm Behavior (Networked with Cable or Short-Range Radio Connection) 10-13
- Paired Device Synchronized Alarm Settings (Networked) 10-15
- Non-networked Devices 10-17
- Alarm Behavior (Non-networked) 10-20
- More Bed Alarms 10-21

Warning

Pairing of TRx4841/51A IntelliVue Telemetry Transceivers with IntelliVue Patient Monitors operating via a short-range radio connection is only supported when both the transceiver and the patient monitor are equipped with short-range radio capability.

Note—Pairing of transceivers and IntelliVue Patient Monitors is not available with IntelliVue Patient Monitors connected to the M3140 Information Center.

Note—The MP5T IntelliVue Patient Monitor is a non-networked device as it does not support a connection to the Information Center.

Device Revision Pairing Functionality

The level of pairing functionality available is dependent on the software revision of the devices in use. Refer to the following table to identify available functionality.

Functionality	Transceiver Rev.	Patient Monitor Rev.	Information Center Rev.
Basic Pairing	A.00	B.1	F.00
Pairing via Direct Connection	B.00	E.00	J.00
Enhanced Pairing via Direct Connection	B.01	F.00	K.00
Pairing via Short-Range Radio Connection	C.00	G.00	L.00

Networked Devices

Basic Pairing

Pairing at the Information Center

You can pair an IntelliVue Patient Monitor with the transceiver at the Information Center. The telemetry data automatically displays as a permanent overview session in the Telemetry Data Window on the IntelliVue Patient Monitor. At the Information Center, the telemetry data and any patient monitor data (e.g. NBP) are integrated in the patient sector.

See your *IntelliVue Information Center Instructions for Use* or *IntelliVue Patient Monitor Instructions for Use* for information on how to pair/unpair devices.

Pairing at the IntelliVue Patient Monitor

At the bedside you can pair a transceiver with an IntelliVue Patient Monitor by pairing the devices through the Setup Telemetry menu on the patient monitor. For information on the Setup Telemetry menu, see your *IntelliVue Patient Monitor Instructions for Use*.

Pairing via Direct Connection to the MP5

When the transceiver, assigned to a patient sector at the Information Center, uses an interface cable to connect to an MP5 Patient Monitor, the Information Center automatically pairs (if configured to do so) the two devices. Pairing using this method provides up to 4 ECG waves at the MP5, along with SpO₂ measurements and a pleth wave. Lead selection and alarm limits may be changed either at the Information Center or the MP5 Patient Monitor.

To connect the transceiver to the monitor, perform the following steps:

Step	Action
1	Remove the protective cover from the transceiver's monitor/service port.
2	Insert the interface cable into the monitor/service port.
3	Attach the interface cable to the monitor using the port labeled with the  icon.

Warning

When the transceiver is directly connected to the monitor, arrhythmia relearning is initiated, and again when the transceiver is disconnected from the monitor. During relearn, a short dropout period may occur. Be sure to check your patient's arrhythmia annotation for accuracy whenever relearn has occurred.

Controls on the transceiver (e.g. nurse call) will be inactive when the device is directly connected to the monitor except in the case when the monitor has no network connection and data are transferred via the transceiver.

Important—When transceivers and MP5 Patient Monitors are paired directly via an interface cable, your ECG source must be connected before connecting or disconnecting the interface cable to maintain synchronized alarm settings. The interface cable must be disconnected prior to unpairing the devices at the Information Center or the monitor.

Pairing via Short-Range Radio Connection

When the transceiver and monitor (MP5, MP2 or X2 only) are both equipped with short-range radio capability, the transceiver can be paired with the monitor at the monitor. Monitors which have this capability have a short range radio symbol  on the model label.

If your transceiver is not already equipped with the Short-Range Radio Adapter (SRRRA), follow the instructions and figures below to install the adapter.

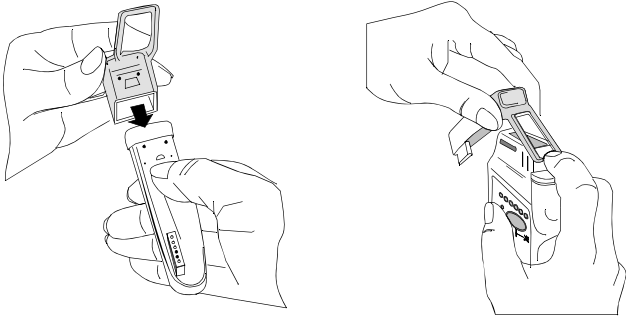
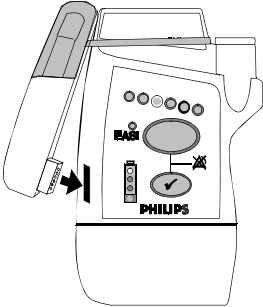
Step	Action
1	Remove the protective cover from the transceiver's monitor/service port.
2	<p>Position the rubber cover over the top of the SRRRA. Attach the connected strap around the transceiver above the Leadset Insertion Guide.</p> 
3	<p>Insert the SRRRA connector in the monitor/service port.</p> 

Note—The rubber cover/strap can be easily removed, e.g. for cleaning purposes, by dipping that end of the adapter in isopropyl alcohol and pushing up from the base of the cover. Do not pull on the strap.

To pair the transceiver to the monitor:

1. Press the Check Button on the transceiver. The measurement selection key on the monitor will change to show the "assign telemetry" icon .
2. Select the assign telemetry icon.
3. In the Assign Telemetry Device menu, select the correct equipment label for the device.

When connected, the  icon appears at the Information Center.

The transceiver is assigned to the monitor. A "Tele Device Assigned" message appears on the monitor, a tone sounds at the transceiver and its Leads Off indicators light to indicate the successful assignment. If the ECG wave now appears on the monitor, the signal from the transceiver is successfully transmitting to the monitor. To confirm that the correct transceiver has been assigned, open the ECG Setup menu by touching the ECG waveform or HR numeric. The title of the menu contains the equipment label of the transceiver. Check that this is the correct label.



If a monitor is already paired to another device, you cannot assign a transceiver to that monitor.

If the transceiver goes out-of-range or loses the short-range radio connection, it will switch over to standard telemetry transmission to the Information Center. In this case, the telemetry data is displayed in the Telemetry Data Window.

If the devices are unpaired, the short-range radio connection is ended.

Unpairing the Monitor and Transceiver

If the patient will no longer be monitored with the transceiver, or only with the transceiver and no longer with the monitor, you need to end the device pairing. After unpairing, the Information Center will receive data exclusively from the monitor or from the transceiver:

- select the **Unpair To Mon.**  SmartKey to end pairing and have the Information Center receive the measurement data from the monitor
- select the **Unpair To Tele**  SmartKey to end pairing and have the Information Center receive the measurement data from the transceiver or
- use the Unpair function in Sector Setup at the Information Center.

Note—The **Unpair** SmartKeys and pop-up keys appear only on the monitor which is directly involved in pairing.

Stopping Short-Range Radio Communication

To stop communication via the short-range radio connection and turn the transceiver's radio back on while maintaining device pairing, use the **Stop SRR** button in the Telemetry Device Window.

Alarm Behavior (Networked)

Both the IntelliVue Telemetry System and the IntelliVue Patient Monitor source alarms. The following table summarizes alarm behavior when a transceiver is paired with an IntelliVue bedside monitor without a direct cable or short-range radio connection. For detailed information, see the *IntelliVue Patient Monitor Instructions for Use* and the *IntelliVue Information Center Instructions for Use*.

Note—This table assumes the two devices are paired without a cable connection or short-range radio connection. When paired with a cable connection or short-range radio connection, controls work in the same manner as a single bedside monitor.

Warning

For MP5 monitors, all data presented in the telemetry data window is delayed for several seconds. If you need realtime data, for example, for defibrillation, always use the monitor ECG. As long as the ECG is being measured with the transceiver, there will be no ECG signal available at the ECG analog output or ECG Sync Pulse output.

Note: MP5T bedside monitors do not have an ECG connection.

Where Initiated	Effect at Bedside	Effect at Information Center
Silence		
Bedside	Silences bedside alarms. Silences telemetry alarms if Enable Global Silence for Paired Beds is on at the Information Center.	Silences bedside alarms. Silences telemetry alarms if Enable Global Silence for Paired Beds is on at the Information Center.
Bedside from Telemetry Data Window	Silences bedside and telemetry alarms. Silence Overview Alarms at Bedside must be enabled at the Information Center.	Silences bedside and telemetry alarms. Silence Overview Alarms at Bedside must be enabled at the Information Center.
Information Center	Silences bedside and telemetry alarms.	Silences bedside and telemetry alarms.

Where Initiated	Effect at Bedside	Effect at Information Center
Suspend/Pause		
Bedside	Suspends/Pauses bedside alarms.	Bed Alarms Suspend/Bed Alarms Paused INOP displayed.
Information Center	Suspends/Pauses bedside and telemetry alarms.	Suspends/Pauses bedside and telemetry alarms. Alarms Suspend/Alarms Paused INOP displayed. All Arrh Alrms OFF displayed. <i>Note</i> —Suspends bedside alarms for the minimum of the transceiver configuration and the bedside configuration.
Transceiver (Remote Suspend enabled at the Information Center.)	Suspends/Pauses bedside and telemetry alarms.	Suspends/Pauses bedside and telemetry alarms. Alarms Suspend/Alarms Paused INOP displayed. All Arrh Alrms OFF displayed. <i>Note</i> —Suspends bedside alarms for the minimum of the transceiver configuration and the bedside configuration.
Standby		
Bedside	Bedside put into standby state.	Monitor Standby INOP displayed.
Information Center	Bedside and telemetry put into standby.	Monitor and Telemetry Standby INOPs displayed. Standby location displayed.
Resume Monitoring		
Bedside	Bedside resumes monitoring.	Bedside resumes monitoring.
Information Center	Bedside and telemetry resumes monitoring.	Bedside and telemetry resumes monitoring.

Warning

If the remote Silence key in the Overview window is enabled for IntelliVue monitors connected to the Information Center, remote silencing for these beds will be enabled in other clinical units.

Alarm/INOPs at the Information Center

The alarms and INOPs that are displayed, recorded, and stored at the Information Center depend on the type of alarm.

Type of Alarm/INOP	Effect at Information Center
All ECG alarms and INOPs - based on ECG source	Displayed, recorded (if configured), and stored <i>Note</i> —INOPs are only displayed.
Bedside and telemetry non-ECG alarms and non-ECG INOPs	Displayed, recorded (if configured), and stored <i>Note</i> —INOPs are only displayed.

Alarm Behavior (Networked with Cable or Short-Range Radio Connection)

The following table summarizes alarm behavior when a transceiver is paired with an IntelliVue MP5, MP2, or X2 bedside monitor with a direct cable or short-range radio connection.

Warning

As long as the ECG is being measured with the transceiver, there will be no ECG signal available at the ECG analog output or ECG Sync Pulse output.

Where Initiated	Effect at Bedside	Effect at Information Center
Silence		
Bedside	Silences bedside and telemetry alarms.	Silences bedside and telemetry alarms.
Information Center	Silences bedside and telemetry alarms.	Silences bedside and telemetry alarms.

Networked Devices

Where Initiated	Effect at Bedside	Effect at Information Center
Suspend/Pause		
Bedside	Suspends/Pauses bedside and telemetry alarms.	Alarms Suspend/Alarms Paused INOP displayed.
Information Center	Suspends/Pauses bedside and telemetry alarms.	Alarms Suspend/Alarms Paused INOP displayed.
Standby		
Bedside	Bedside and telemetry put into standby.	Monitor Standby and Arrhythmia Off INOPs displayed. Standby location displayed.
Information Center	Bedside and telemetry put into standby.	Monitor Standby and Arrhythmia Off INOPs displayed. Standby location displayed.
Resume Monitoring		
Bedside	Bedside and telemetry resumes monitoring.	Bedside and telemetry resumes monitoring.
Information Center	Bedside and telemetry resumes monitoring.	Bedside and telemetry resumes monitoring.

Paired Device Synchronized Alarm Settings (Networked)

If the patient's ECG is initially being measured with a patient monitor, and then the patient is connected to the transceiver for monitoring, the Information Center will use the patient monitor settings for the transceiver. When the initial ECG source is the transceiver, and then the patient is connected to the monitor, the Information Center uses its Telemetry Setup settings. The following settings will be synchronized:

Heart Rate	HR/Pulse Alarm On/Off, Heart Rate High/Low Limit
ECG	Primary Lead, Secondary Lead, Va Lead, Vb Lead
Arrhythmia	Analysis Mode, Asystole Threshold, Pause Threshold, VTach HR, VTach Run, PVCs/min, Vent. Rhythm, SVT HR, SVT Run, PVCs/min On/Off, Pacer not Capture On/Off, Pacer not Pace On/Off, Non-sustain On/Off, Vent. Rhythm On/Off, Run PVCs On/Off, Pair PVCs On/Off, Missed Beat On/Off, Pause On/Off, R-on-T On/Off, Vent. Bigeminy On/Off, Vent. Trigeminy On/Off, Multiform PVCs On/Off, Irregular HR On/Off, SVT On/Off, Afib On/Off
ST	ST Analysis On/Off, ST Alarm On/Off, ISO point, J point, ST point, ST Priority List, Single ST Alarm Limit, Multi ST Alarm Limit
QT	QT Analysis On/Off, QTc High On/Off, QTc High Alarm Limit, dQTc High On/Off, dQTc High Alarm Limit, QT Lead, QTc Correction Formula, QT Baseline
SpO₂T	SpO ₂ Alarms On/Off, SpO ₂ Alarm Limits NBP Alarm Suppression On/Off, Pulse (SpO ₂) On/Off

Networked Devices

Important—When transceivers and MP5 Patient Monitors are paired directly via an interface cable or short-range radio connection, your ECG source must be connected before connecting or disconnecting the interface cable to maintain synchronized alarm settings. The interface cable must be disconnected prior to unpairing devices at the Information Center or the monitor.

Non-networked Devices

Using the monitor interface cable, you can directly connect the TRx /TRx+ Transceivers to an MP5/MP5T monitor that does not have a network connection in order to transmit additional measurement data to the IntelliVue Information Center using the transceiver's radio. You can also connect the monitor (MP5/MP5T, MP2 and X2) and transceiver if both are equipped with short-range radio capability. Along with ECG and SpO₂T transmitted by the transceiver, you can transmit and display NBP, Pulse from SpO₂, SpO₂ numeric and predictive temperature measurements in the Patient Sector at the Information Center. Associated INOPs and alarms are also generated.

Depending on the MP5/MP5T's configuration, disconnecting the monitor interface cable from the transceiver may discharge the MP5/MP5T. This discharge does not affect the Information Center. For more information, see the *IntelliVue Patient Monitor Instructions for Use*.

Note—When SpO₂ is measured at the bedside monitor only, the SpO₂ numeric is transmitted to the Information Center, however, the pleth wave is only visible at the bedside monitor.

Warning

If your MP5/MP5T monitor interface cable is accidentally disconnected or the short-range radio connection is terminated or interrupted, bedside measurements are no longer available at the Information Center.

Warning

As long as the ECG is being measured with the transceiver, there will be no ECG signal available at the ECG analog output or ECG Sync Pulse output.

Note: MP5T bedside monitors can measure ECG only when connected to the transceiver via the monitor interface cable or short-range radio connection.

Pairing via Direct Connection to the MP5/MP5T

To connect the transceiver to the monitor, perform the following steps:

Step	Action
1	Remove the protective cover from the transceiver's monitor/service port.
2	Insert the interface cable into the monitor/service port.
3	Attach the interface cable to the monitor using the port labeled with the  icon.

Pairing via Short-Range Radio Connection

When the transceiver and monitor (MP5/MP5T, MP2 or X2 only) are both equipped with short-range radio capability, the transceiver can be paired with the bedside monitor at the monitor. Monitors which have this capability have a short range radio symbol  on the model label.

If your transceiver is not already equipped with the Short-Range Radio Adapter (SRRRA), follow the instructions and figures below to install the adapter.

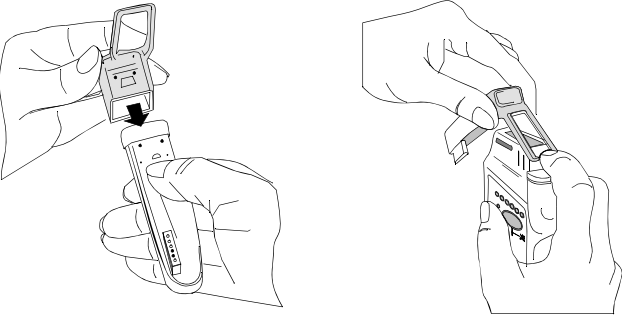
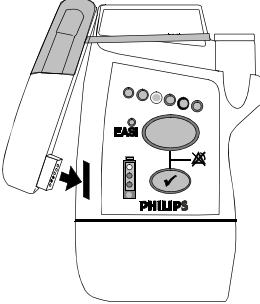
Step	Action
1	Remove the protective cover from the transceiver's monitor/service port.
2	<p>Position the rubber cover over the top of the SRRRA. Attach the connected strap around the transceiver above the Leadset Insertion Guide.</p> 
3	<p>Insert the SRRRA connector in the monitor/service port.</p> 

Note—The rubber cover/strap can be easily removed, e.g. for cleaning purposes, by dipping that end of the adapter in isopropyl alcohol and pushing up from the base of the cover. Do not pull on the strap.

To pair the transceiver to the monitor:

1. Press the Check Button on the transceiver. The measurement selection key on the monitor will change to show the "assign telemetry" icon  .
2. Select the assign telemetry icon.
3. In the Assign Telemetry Device menu, select the correct equipment label for the device.

When connected, the  icon appears at the Information Center.

The transceiver is assigned to the monitor. A "Tele Device Assigned" message appears on the monitor, a tone sounds at the transceiver and its Leads Off indicators light to indicate the successful assignment. If the ECG wave now appears on the monitor, the signal from the transceiver is successfully transmitting to the monitor. To confirm that the correct transceiver has been assigned, open the ECG Setup menu by touching the ECG waveform or HR numeric. The title of the menu contains the equipment label of the transceiver. Check that this is the correct label.

If the transceiver goes out-of-range or loses the short-range radio connection, monitoring at the Information Center remains, however monitoring at the patient monitor is no longer possible. ECG Leads Off and Tele Disconnected INOPs are displayed.

If the devices are unassigned, the short-range radio connection is ended.

Unassigning Transceiver at the Monitor

Because the monitor does not have a connection to the Information Center, you must manually end the assignment and the short-range radio connection.

1. Select the Measurement Selection key.
2. In the **Measurement Selection** window, select the **Tele** pop-up key.
3. In the Tele device window select **Unassign Tele**.

Alarm Behavior (Non-networked)

When the transceiver is paired to a non-networked monitor, alarms are generated independently at both the Information Center and the bedside monitor. Alarms are not synchronized. When you adjust alarm settings at the monitor, the changes do not take effect at the Information Center and vice versa.

Alarm Suspend/Pause and Standby can be initiated only from patient monitor, not from the transceiver or the Information Center. The alarm suspend indicator on the transceiver will accurately reflect the current state of alarm pause. Silencing an active alarm at the patient monitor has no effect on the alarms at the Information Center. For detailed information, see the *IntelliVue Patient Monitor Instructions for Use* and the *IntelliVue Information Center Instructions for Use*.

More Bed Alarms

The More Bed Alarms INOP is displayed at the Information Center when a physiological alarm or INOP is generated by the bedside that is not included in the group of alarms that is transmitted to the Information Center by the transceiver. The INOP will display using the corresponding severity color of the actual alarm. For example, should the bedside monitor generate a "***DESAT alarm", it will display at the Information Center as a red, !!!More Bed Alarms INOP.

Warning

*****DESAT and ***<Pressure> HIGH alarms from the bedside monitor will appear as red, !!!More Bed Alarms INOPs at the Information Center.**

Short-Range Radio Monitoring Considerations

When monitoring using the short-range radio connection, interference may cause transition between the short-range radio and the telemetry radio. To minimize this occurrence, consider the following:

- Monitoring performance will degrade if the patient moves outside the typical coverage area of 15 ft.
- Limit the number of short-range radio devices in the area (maximum of 3 per radio channel).
- Minimize the number of radio sources operating in the area, including those mentioned below.

For additional information, see “Optimizing ECG Measurement Performance” on page 6-29.

Warning

Short-range radio connections are subject to interruption due to interference from other radio sources in the vicinity, including microwaves, bluetooth devices, and DECT phones. Outside the frequency band and 5% above and below, i.e. the exclusion band according to IEC 60601-1-2, the short-range radio connection is immune up to 3V/m in the frequency range from 80MHz to 2.0 GHz and up to 1V/m in the frequency range from 2.0 to 2.3 GHz. Depending on the strength and duration of the interference, the interruption may occur for an extended period. Any interruption of the signal due to interference, moving out of range, or for other reasons is indicated with a Tele Disconnected INOP message.

Short-Range Radio Error Conditions

The following table describes error conditions that may occur when the transceiver is paired with the monitor (MP5, MP2 and X2 IntelliVue Patient Monitors only) via short-range radio capability.

Condition	Description	Action
TELE DISCONNECTED INOP displayed at the monitor and the Information Center.	<p>Short-range radio connection between the transceiver and MP5T has been lost due to a failure of the short-range radio connection.</p> <p>There are too many short-range radios operating in the same vicinity (maximum of 3 per radio channel).</p>	<p>If the disconnection is not intentional:</p> <p>Identify and remove the interference sources.</p> <p>Reduce the number of devices equipped with short-range radio capability.</p>
NO SIGNAL INOP displayed at the Information Center.	<p>The short-range radio is not installed correctly.</p> <p>There is interference from telemetry or ISM radio sources.</p> <p>The transceiver is outside the coverage area.</p> <p><i>Note</i>—The typical coverage area between the monitor and transceiver is 15 ft.</p>	<p>Contact service personnel.</p> <p>Identify and remove the interference source.</p> <p>Make sure the location of the transceiver is in the coverage area.</p>
BATTERY LOW T INOP displayed at the monitor and the Information Center.	<p>When operating wirelessly, the patient monitor is no longer providing power to the transceiver, and battery capacity is diminished. 15 minutes of monitoring time remain.</p>	<p>Insert new AA batteries in the transceiver.</p>

Non-networked Devices

Condition	Description	Action
REPLACE BATTERY T INOP displayed at the monitor and the Information Center.	When operating wirelessly, the patient monitor is no longer providing power to the transceiver, and battery capacity is now depleted. There is no monitoring occurring at either the monitor or the Information Center.	Insert new AA batteries in the transceiver.
Absence of successful association sound/visual indicator.	The bedside monitor and the transceiver are not communicating with each other. Monitoring at the Information Center only.	Repeat the device assignment procedure.
CENTRAL: TELE ONLY INOP	When the transceiver is wirelessly paired with an X2 patient monitor (no label) docked with a larger networked MP series monitor, and the network connection is lost.	Restore the monitor's network connection.
CHECK PAIRING INOP	An X2 patient monitor with a telemetry label is paired with a larger networked MP series monitor and subsequently the transceiver is paired with the same monitor. Only one transceiver can pair with the monitor.	Select the correct device to be paired.
???	The equipment label is invalid.	Contact service personnel.

Maintenance, Cleaning & Troubleshooting

All installation tasks are performed by Service personnel and are described in detail in the service documentation accompanying the system. This chapter provides procedures for maintaining the equipment after installation including assigning labels for replacement transceivers, keeping the transceiver clean, and troubleshooting common problems. It includes the following sections:

- Maintenance 11-2
- Cleaning and Sterilization. 11-4
- Troubleshooting 11-14

Maintenance

Basic Monitoring

Before beginning monitoring on a patient:

- Check for any mechanical damage.
- Check all the external leads, plug-ins and accessories.
- Check all the functions of the instrument which are needed to monitor the patient.
- Ensure that the instrument is in good, working order.

Do not use the IntelliVue transceiver for any monitoring procedure on a patient if you identify features which demonstrate impaired functioning of the instrument. Contact the service provider.

Warning

Failure on the part of the responsible individual hospital or institution employing the use of this equipment to implement satisfactory maintenance as needed may cause undue equipment failure and possible health hazards.

Testing Alarms

Visual and auditory alarms appear at the Information Center. One method of verifying visual and auditory alarms at the Information Center is to connect the transceiver to an ECG or ECG/SpO₂ simulator. By varying the ECG rate and SpO₂ value, alarms can be generated and confirmed for proper operation.

Label Assignment for Replacement Transceiver

During installation, an electronic equipment label is assigned to each transceiver in a clinical unit so that the device can be identified during operation within the wireless system. If a transceiver is lost, the Assign Label function at the Information Center enables you to unassign the label from a lost transceiver, and re-assign its label to a replacement transceiver. Labels are limited to those available in an individual clinical unit. The Label Assignment function requires a password for access, and its controls are available in English only.

Re-assigning an Equipment Label

The following instructions enable you to reassign an equipment label from a lost device to a replacement transceiver.

Note—If the leadset is attached during this procedure, the label assignment will fail.

Step	Action
1	At the Information Center, clear the sector that the original Equipment Label was assigned to. (Patient Window -> Sector Setup -> Clear Sector -> OK). <i>Note</i> — Ensure that no patient is being monitored by the original (lost) device before clearing the sector.
2	Select All Controls, then Label Assignment.
3	Enter password. <i>Note</i> —The remaining screens will be in English only.
4	Insert batteries into the replacement device, and remove the leadset, if present. All transceiver indicators should flash, and you should hear a double tone repeated every 3 seconds, indicating that the transceiver has no Equipment Label.
5	Select Refresh.
6	Select the MAC address of the replacement device from the “New Devices” list. If the MAC address does not appear, remove the batteries and reinsert them. Select Refresh again. <i>Note</i> —The transceiver MAC address is located inside the battery compartment.
7	Select the Equipment Label that was assigned to the unit’s previous device from “Equipment Labels” list.

Step	Action
8	<p>Select Assign Label to initiate programming of the Equipment Label into the replacement telemetry device - AND - within 10 seconds, press the Check button on the telemetry device. <i>Note</i>—If 10 seconds pass without a button push, then repeat starting with step 5.</p> <p>When the label assignment is complete, the assignment will be verified in the “Status” field.</p>
9	<p>Go back into Sector Setup, and select the Bed Label and Equipment Label, followed by OK.</p> <p>The transceiver goes through the normal startup sequence and starts monitoring. Verify the signal in the appropriate Patient Sector.</p>

Cleaning and Sterilization

The procedures in this section keep the transceiver clean and provide protection against infectious agents and bloodborne pathogens. Both the outside of the transceiver and the inside of the battery compartment must be kept free of dirt, dust, and debris. The procedures in this section cover the following activities:

- **Cleaning:** removing surface contaminants from the device.
- **EO Sterilization:** using EO gas treatment to decontaminate cleaned equipment.

Important—**After exposure, the transceiver must be cleaned or cleaned and EO sterilized as per the instructions contained herein.**

Cleaning the Transceiver

Caution

Use of abrasive cleaning materials, or disinfectants or cleaning agents not listed herein, on any part or component of the IntelliVue TRx or TRx⁺ transceiver may damage the components. See the list of unsupported cleaners in the table below.

Caution

When cleaning the Monitor/Service port, do not use any stiff, rigid instruments, tools, or other devices to clean debris in the port, as such actions will damage the connector pins. A forceful water stream may be used after soaking for 5 minutes to flush the port if necessary.

Approved Cleaners

Cleaner	Active Ingredient
Isopropyl Alcohol based	Isopropyl Alcohol ($\geq 70\%$)
Ethyl Alcohol based	Ethyl Alcohol ($\geq 70\%$)
Antibacterial Soap and Water*	Various
Hydrogen Peroxide	Hydrogen Peroxide (3%)
Chlorine Bleach	Sodium Hypochlorite (1:10 concentration, mixed < 24 hours)

Cleaning and Sterilization

Cleaner	Active Ingredient
Cidex*	Gluteraldehyde (2.4%)
WipesPlus Disinfecting Wipes	Phenylphenol (0.28%), Benzyl-p-chlorophenol (0.03%)
TechSpray General Purpose Cleaner	Isopropyl Alcohol

*To prevent damage, avoid the use of antibacterial soap and water and Cidex inside the battery compartment.

Note—The cleaners listed above are also suitable for the optional Short- Range Radio Adapter (SRRRA). Remove the rubber cover/strap by dipping that end of the adapter in isopropyl alcohol and pushing up from the base of the cover. Do not pull on the strap.

Unsupported Cleaners

Active Ingredient	Example
Quaternary Ammonium based	Virex Tb, SaniCloth HB, Purell Sanitizing Wipes, Clorox Disinfecting Wipes
Phenol based (≥1%)	3M Phenolic Disinfectant Cleaner
Ether based	Kleenaseptic

Caution

The use of unsupported cleaners will result in the degradation and eventual cracking of the transceiver's plastic casing.

Perform the following steps to clean the transceiver of visible surface contamination.

Step	Action
1	Remove the batteries and any cables or accessories.
2	Wipe the transceiver clean by using a cloth dampened modestly with one of the approved cleaning agents listed in the table above.
3	If any visible residue remains in the Monitor/Service port, flush the port with a forceful stream of water.
4	Rinse or wipe the transceiver with distilled water.
5	Allow to air-dry, or dry with a non-lint producing cloth.

EO Sterilization

The transceiver can be subjected to EO sterilization four times per year for 2 years.

Equipment must first be cleaned (see “Cleaning the Transceiver” on page 11-5) before this procedure is performed.

Note—If there is concern over cross-contamination due to leadsets or sensors, new leadsets or sensors should be used.

Caution

The Short Range Radio Adapter cannot be sterilized. Remove the adapter before sterilizing the transceiver.

**Equipment and
Materials**

Warning

EO is highly explosive, toxic, and a potential occupational carcinogenic and reproductive hazard. Handle it with extreme care, following U.S. Occupational Safety and Health Administration (OSHA) standards for EO (29 CFR 1910.1047)*. Personnel exposure and/or room air must be monitored per OSHA standards.

Vent sterilizer gas outdoors or to a suitable, evacuated container for reprocessing, depending upon state, provincial, or country environmental regulations. Do not vent sterilant indoors.

Vent aerator exhaust only to the outdoors.

* See “References” on page 11-11.

Use the following equipment and material to process the transceiver:

1. Ethylene Oxide gas (Allied Signal Oxyfume-2002™ or equivalent).
2. Gas sterilizer manufactured by American Sterilizer Company or other appropriate manufacturer.

**EO
Sterilization**

The following generic procedure can be used to supplement the sterilizer manufacturer’s instructions, although the processing times, temperatures, and EO concentrations must be equivalent to those given in this procedure in order to achieve a sterility level of 10E-6.

Step	Action
1	Remove any obvious contamination from the equipment to be processed using approved cleaners.
2	Individually package each transceiver in standard central supply room (CSR) wrapping material secured with EO color-change indicator tape.

Step	Action
3	Apply -26 inHg +/- 1 (-12.77 psig +/- .49) vacuum to the empty sterilizer chamber two times, to remove any residual EO or moisture. Vent the vacuum pump to the outdoors to avoid toxic hazards to personnel.
4	Insert the equipment to be processed into the gas sterilizer.
5	Heat the chamber and its contents to 54.4 +/- 2.8°C (130 +/- 5°F).
6	Apply -26 inHg +/- 1 (-12.77 psig +/- .49) vacuum to the sterilizer chamber.
7	Humidify the chamber at 50% +/- 10% relative humidity for 20 to 30 minutes.
8	<p>Taking a minimum of five minutes, slowly introduce EO sterilant until the sterilizer unit pressure gauge reaches 11 +/- 1 psig.</p> <p><i>Note</i>—At this pressure, the concentration of sterilant in the chamber will be 600 +/- 50 mg/liter, regardless of the chamber size.</p>
9	<p>Process the equipment to be processed as follows:</p> <p style="padding-left: 40px;">Pressure: 11 +/- 1 psig (established in the preceding step).</p> <p style="padding-left: 40px;">Time: 2-3 hours</p> <p style="padding-left: 40px;">Temperature: 54.4 +/- 2.8°C (130 +/- 5°F)</p>

Step	Action
10	<p data-bbox="447 248 1018 272">Extract the gas mixture from the sterilizer as follows:</p> <hr/> <p data-bbox="458 326 565 350">Warning</p> <p data-bbox="447 363 1180 518">Comply with OSHA standards* . Do not vent sterilizer gas to the room, but vent only outdoors or to a suitable, evacuated container, depending upon state, provincial, or country environmental regulations. (If the mixture is captured, it can be separated commercially and the component gases re-used.)</p> <p data-bbox="447 550 821 583">* See “References” on page 11-11.</p> <hr/> <ul style="list-style-type: none"> <li data-bbox="532 651 1170 737">a. Pump the gas mixture out of the chamber until you obtain a vacuum of -26 inHg +/- 1 (-12.77 psig +/- .49), returning the mixture to a suitable evacuated container. <li data-bbox="532 769 1170 826">b. Return the sterilizer chamber to ambient pressure by introducing air that has been bacterially filtered.
11	<p data-bbox="447 860 948 885">Air-wash the chamber and material as follows:</p> <ul style="list-style-type: none"> <li data-bbox="532 917 1180 1031">a. Apply -26 inHg +/- 1 (-12.77 psig +/- .49) vacuum to the chamber and processed material again, to remove residual EO. The vacuum pump must be vented to the outdoors. <li data-bbox="532 1063 1170 1120">b. Return the sterilized chamber to ambient pressure by introducing air that has been bacterially filtered.
12	<p data-bbox="447 1157 1013 1182">Continue with the “Aeration Procedure” (following).</p>

Aeration Procedure

Warning

To avoid chemical burns and toxic effects, the equipment must be aerated after sterilization,* as described. The aerator must have bacterial filters and outdoor venting.

See “References” on page 11-11.

Aerate the processed equipment by performing the following steps:

Step	Action
1	<p>To dissipate residual EO, aerate the processed equipment with air that has been bacterially filtered, using a mechanical aerator or combination sterilizer/aerator as follows:¹</p> <p>Time: 8-9 hours</p> <p>Temperature: 54.4 +/- 2.8°C (130 +/- 5°F)</p> <p>Ventilation Frequency: At least 30 air exchanges per hour.</p>
2	Continue with the “Test Procedure” (following).

¹ These values will produce EO and Ethylene Chlorohydrin residual levels in the transceiver and patient cable plastic that meet ISO 10993-7 in conjunction with AAMI Technical Information Report 19, that the FDA currently endorses.

References

OSHA: Standard for acceptable levels of personnel exposure to Ethylene Oxide Gas: 1 ppm on an eight-hour time-weighted average basis.

Reference: U.S.A. Federal Regulations 49 FR 25734/29 CFR Part 1910.1047, June 22, 1984; final approval 50 FR 9800/2- CFR Part 1910.1047, March 12, 1985.

Test Procedure

Caution

You must perform this test each time you put a transceiver through the EO sterilization process.

This test allows you to verify that patient information for both ECG and SpO₂ (if you are monitoring pulse oximetry) appear at the Information Center and at the bedside. You can use this procedure with a Patient Simulator.

Note—This test assumes that the telemetry system and Information Center are fully installed, and that you have performed the procedure to learn the transceiver identity code.

Test the transceiver by performing the following steps. If the test indications do not appear, refer to your service provider.

Step	Action
1	Perform a mechanical inspection of the transceiver (connectors, battery door opening and closing, Telemetry and Check buttons).
2	At the Information Center, select the telemetry bedside you are testing.

Step	Action
3	<p>Test the transceiver:</p> <ol style="list-style-type: none"> a. Put fresh batteries in the transceiver (without a leadset attached) and close the battery door Result: All six lead lights should flash, and one light should remain on. b. Attach a leadset to the ECG port, and attach an SpO₂ sensor to the SpO₂ port. If an ECG simulator is available, attach the ECG leads to the simulator and the SpO₂ sensor to yourself. At TeleMon, set the SpO₂ sample rate to Continuous. Result: An ECG trace and SpO₂ information should be visible on the Information Center display. All transceiver lights should be off. c. Disconnect the Right Arm lead for standard ECG or the “I” electrode for EASI. Result: The RA LED or the “I” lead LED should turn on, and a Leads Off INOP should appear on the display at the Information Center. d. Reconnect the electrode.
4	<ol style="list-style-type: none"> a. Connect the transceiver to TeleMon and observe the ECG waveform and SpO₂ numerics on the TeleMon display. Result: The ECG waveform and SpO₂ numerics should be displayed on the TeleMon screen.

Troubleshooting

Basic Troubleshooting

For problems with...	see...
<ul style="list-style-type: none"> • ECG measurement 	<p>“Optimizing ECG Measurement Performance” on page 6-29.</p> <p>“Using EASI Leads to Troubleshoot” on page 6-28.</p> <p>“Technical Alarms (INOPs)” on page 5-10.</p>
<ul style="list-style-type: none"> • SpO₂ measurement 	<p>“Optimizing SpO₂ Measurement Performance” on page 8-22.</p> <p>“Technical Alarms (INOPs)” on page 5-10.</p>
<ul style="list-style-type: none"> • Batteries 	<p>“Battery Information” on page 4-13.</p> <p>“Self Test” on page 4-11.</p>
<ul style="list-style-type: none"> • Nurse call 	<p>Nurse Call may have been turned off for the patient. See “Telemetry Button” on page 9-6 for directions on how to turn it on.</p>
<ul style="list-style-type: none"> • Electromagnetic Interference 	<p>“Reducing Electromagnetic Interference” on page 12-7.</p>
<ul style="list-style-type: none"> • Short Range Radio Performance 	<p>“Short-Range Radio Monitoring Considerations” on page 10-22</p>

Important—If changes are made to the Group Settings (how telemetry devices, such as Access Points and Controllers, are grouped in order to provide coverage for patients throughout the hospital), there will be a break in monitoring of all transceivers within the Group(s) being modified. Monitoring will resume when the new Group Settings are in place. Clinical settings will be unaffected by the reconfiguration.

Information Signals

If there is a connection failure within the IntelliVue Clinical Network, an information signal will be generated. This information signal will be displayed in the system message area on the Information Center where the affected wireless patient monitoring device(s) (transceiver, access point, access point controller, sync unit, or router) is assigned, as well as on all other Information Centers connected to a common Database Server. The condition causing the failure will be described in the Wireless Status Log, which is available in Service Mode.

Information Signals

Information Signal	Description	What to Do
<p>Wireless monitoring loss - Contact Service</p> <p><i>Note</i>—This information signal appears on ALL Information Centers connected to a common Database Server.</p>	<p>Problem with wireless network infrastructure device(s).</p>	<p>Contact Service.</p> <p><i>Note</i>—Details about the communication disruption are available in the Wireless Status Log.</p>
<p>Router failure Call Service</p> <p><i>Note</i>—This information signal appears on ALL Information Centers connected to a common Database Server.</p>	<p>A router used in the wireless network has failed.</p>	<p>Contact Service.</p>

Troubleshooting

Safety Standards & Specifications

This chapter describes the regulatory standards that the product complies with, along with product and measurement specifications. It includes the following sections:

- Regulatory Information. 12-2
- Electromagnetic Compatibility 12-5
- Battery Specifications 12-8
- Radio Specifications 12-9
- Physical Specifications 12-13
- Environmental Specifications 12-15
- Measurement Specifications 12-16

Regulatory Information

Intended Use

The device is intended to provide ambulatory and bedside monitoring of ECG and SpO₂ parameters of adult and pediatric patients in professional healthcare facilities. It is intended to be used by trained healthcare personnel. It is not intended for home use.

Indications for Use

Indicated for use by health care professionals whenever there is a need for monitoring the physiological parameters of patients. Intended for monitoring, recording and alarming of multiple physiological parameters of adult and pediatric patients in transport and hospital environments.

Rx

Federal Law restricts this device to sale by or on the order of a physician.

Patient Population

This device is not for use with infant or neonatal patients.

Use of the transceiver is restricted to one patient at a time.

The components/accessories which come into contact with the patient's skin are in compliance with the relevant requirements of EN ISO 10993-1 for Biocompatibility. The transceiver is not designed for direct contact with the patient's skin. The accompanying pouch is the appropriate means for holding the transceiver.

Authorized EU Representative

Philips Medizin Systeme Deutschland
Hewlett-Packard-Strasse 2
D 71034, Boeblingen
Germany

Safety Standards

The device complies with the following safety requirements for medical electrical equipment:

- IEC 601-1:1988 + A1:1991 + A2:1995 General Requirements for Safety (with worldwide deviations, including U.S. deviations)
- IEC 60601-1-1:2000 System Safety
- IEC 60601-1-2:2001 Electromagnetic Compliance
- IEC 60601-1-4:1996 Safety for Programmable Electrical Medical Systems
- ISO 10993-1:2003 Biocompatibility (for lead wires and pouch)
- ISO 9919:2005 Pulse Oximeters
- EN 865:1997 Particular Requirements for Pulse Oximeters
- AAMI EC 13:2002 Performance Standard, Cardiac Monitors

Essential Performance

The IntelliVue Telemetry System provides Essential Performance (EP) under normal operating conditions (includes EMC exposure) only as a complete Medical Electrical System, consisting of the TRx4841A or TRx4851A Transceivers, the IntelliVue Telemetry Network Infrastructure, the M3150 Information Center, the M2636C TeleMon Companion Monitor (optional), and the M8105A/T MP5/5T, M8102A MP2, and M3002A X2 IntelliVue Patient Monitors (optional).

The IntelliVue Telemetry System achieves its Essential Performance exclusively through alarm generation at the M3150 Information Center.

The IntelliVue Telemetry System protects the patient from unacceptable immediate clinical risk by generating specific Physiological Alarms when appropriate. If the System cannot generate Physiological Alarms, then relevant Severe or Hard Technical Alarms (Inoperative Conditions) are created.

System Classification

The TRx4841A and TRx4851A Transceivers are FDA Class II devices. They have the following characteristics.

Characteristic	Definition
Internally Powered Equipment	The TRx4841A and TRx4851A transceivers are internally powered devices.
Continuous Operation	All equipment is Ordinary Equipment, IPX0, and provides continuous operation
Type CF Defibrillation Proof	The TRx4841A and TRx4851A transceivers are Type CF Defibrillation Proof relative to ECG and SpO ₂ patient applied parts.
Water Resistance	<p>Transceiver: IPX3, using leadsets with detachable shield.</p> <p>When placed inside a Philips-specified carrying pouch with the velcro closures secured, the combination of the transceiver and pouch will withstand showering for up to 10 minutes.</p> <p>Short-Range Radio Adapter: IPX3</p>

FCC Compliance (M4840A/ USA only)

Operation of this equipment requires the prior coordination with a frequency coordinator designated by the FCC for the Wireless Medical Telemetry Service.

The transceiver and the IntelliVue Telemetry System are subject to radio frequency interference. In the event of suspected radio frequency interference with your device, contact your service provider. This device complies with Parts 15 and 95H of the Federal Communications Commission (FCC) Rules.

Operation is subject to the condition that this device does not cause harmful interference.

Pursuant to Part 15.21 of the FCC Rules, any changes or modifications to this equipment not expressly approved by Philips Medical Systems may cause

harmful radio frequency interference, and void your authority to operate this equipment.

**Industrie
Canada
Compliance
(Canada)**

This Class A digital apparatus complies with Canadian ICES-003.

Cet appareil numérique de la classe A est conforme à la norme NMB-003 du Canada.

**AC Power
Source**

The system is not intended for connection to the public mains as defined in CISPR11.

**Software
Hazard
Prevention**

Potential hazards arising from errors in the software program have been identified. Mitigations applied to reduce the associated risk of such hazards are included as part of the Risk Management, Clinical Evaluation, and Verification and Validation phases of the product's development.

Electromagnetic Compatibility

Medical electrical equipment can either generate or receive electromagnetic interference. This product has been evaluated for electromagnetic compatibility (EMC) with the appropriate accessories according to IEC 60601-1-2:2001, the international standard for EMC for medical electrical equipment. This IEC standard has been adopted in the European Union as the European Norm, EN 60601-1-2:2001.

Radio frequency (RF) interference from nearby transmitting devices can degrade performance of the product. Electromagnetic compatibility with surrounding devices should be assessed prior to using the product.

Fixed, portable, and mobile radio frequency communications equipment can also affect the performance of medical equipment. See your service provider for assistance with the minimum recommended separation distance between RF communications equipment and the product.

The cables, sensors/transducers, and other accessories for which compliance is claimed are listed in the Service and User documentation accompanying the product.

Warning

The use of accessories, transducers and cables other than those specified in the product service and user documentation can result in increased electromagnetic emissions or decreased immunity of the product.

Warning

Short-range radio connections are subject to interruption due to interference from other radio sources in the vicinity, including microwaves, bluetooth devices, and DECT phones. Outside the frequency band and 5% above and below, i.e. the exclusion band according to IEC 60601-1-2, the short-range radio connection is immune up to 3V/m in the frequency range from 80MHz to 2.0 GHz and up to 1V/m in the frequency range from 2.0 to 2.3 GHz. Depending on the strength and duration of the interference, the interruption may occur for an extended period. Any interruption of the signal due to interference, moving out of range, or for other reasons is indicated with a Tele Disconnected INOP message.

Warning

The product should not be used next to or stacked with other equipment. If you must stack the product, you must check that normal operation is possible in the necessary configuration before the product is used on patients.

Reducing Electromagnetic Interference

The transceiver and associated accessories can be susceptible to interference from other RF energy sources and continuous, repetitive, power line bursts. Examples of other sources of RF interference are other medical electrical devices, cellular products, information technology equipment, and radio/television transmission. If interference is encountered, as demonstrated by artifact on the ECG or dramatic variations in physiological parameter measurement values, attempt to locate the source. Assess the following:

- Is the interference due to misplaced or poorly applied electrodes or sensors? If so, re-apply electrodes and sensors correctly according to directions in Chapter 6. ECG Monitoring.
- Is the interference intermittent or constant?
- Does the interference occur only in certain locations?
- Does the interference occur only when in close proximity to certain medical electrical equipment?

Once the source is located, attempt to attenuate the interference by distancing the transceiver from the source as much as possible. If assistance is needed, contact your local service representative.

Restrictions for Use

Artifact on ECG and other physiological waveforms caused by electromagnetic interference should be evaluated by a physician or physician authorized personnel to determine if it will negatively impact patient diagnosis or treatment.

Battery Specifications

Battery Type

Equipment	Specification
Battery Type	2 fresh AA disposable alkaline batteries

Battery Life

Note—The battery life specifications listed below are based on Duracell MN 1500 batteries. Battery life for other brands may differ.

Operating Mode	Battery Life
ECG Only	50 hours
ECG/SpO ₂ Continuous	18 hours
ECG/SpO ₂ Spot Check	between 18 hours and 50 hours, depending on usage rate
ECG Only w/ SRRA	38 hours
ECG/SpO ₂ Continuous w/ SRRA	14 hours
ECG/SpO ₂ Spot Check w/ SRRA	between 14 and 38 hours, depending on usage rate

Transceiver Current

Operating Mode	Nominal Current
ECG Only	51.3 mA @ 2.4V (TRx4841A) 42.0 mA @ 2.6V (TRx4851A)
ECG/SpO ₂ Continuous	116 mA @ 2.4V (TRx4841A) 100 mA @ 2.6V (TRx4851A)

Radio Specifications

TRx4841A

Parameter	Specification
Frequency Ranges	Bands: 1395-1400 MHz and 1427-1432 MHz Channel Spacing: 1.6 MHz
RF Output Power	8 dBm +2/-3 dB (3.2 mW to 10 mW), into antenna load @ nominal battery voltage
Transceiver Frequency Accuracy during normal operation	+/- 15 KHz relative to channel frequency, includes temperature compensation and aging effects
Modulation Type	FSK with Root Raised Cosine filtering (1M60Q7D)

Radio Specifications

Parameter	Specification
Out of Band Spurious Emission Levels: <ul style="list-style-type: none"> • ≤ 1394 MHz, ≥ 1401 MHz • ≤ 1428 MHz, ≥ 1433 MHz 	< -41 dBm in 1 MHz bandwidth for FCC limit
Occupied bandwidth as defined by power in 99% BW	$\leq \pm 800$ KHz

TRx4851A

Parameter	Specification
Frequency Range	ISM Band: 2400 - 2483.5 MHz Channel Spacing: 1.728 MHz
RF Output Power	FCC: 17 dBm ± 1 dB (40 mW to 63 mW, nominal 50 mW), into antenna load @ nominal battery voltage ETSI: 12 dBm ± 1 dB (13 mW to 20 mW, nominal 16 mW), into antenna load @ nominal battery voltage ARIB: 13.5 dBm ± 1 dB (18 mW to 28 mW, nominal 22 mW), into antenna load @ nominal battery voltage
Transceiver Frequency Accuracy during normal operation	$< \pm 60$ /- 100 KHz relative to channel frequency, includes temperature compensation and aging effects

Parameter	Specification
Modulation Type	GFSK, Gaussian Frequency Shift keying (1M40Q7D)
Modulation Bandwidth	Typically 1.4 MHz (20 dB Bandwidth)
Out of Band Spurious Emission Levels	Meets ETSI, RS210, FCC, ARIB standards

SRRA

Parameter	Specification
Frequency Ranges	ISM Band: 2400-2483.5MHz
Radio Channel assignment	16 Radio Channel assigned, $F_c = 2405 + 5 \cdot (k - 11)$ MHz, $k = 11, 12, \dots, 26$
Frequency Control	Configured via the bedside monitor.
RF Output Power	~ 1.5 to ~ 4.5 dBm $\pm 0/-3$ dB (0.7 mW to 0.3 mW), into Antenna load.
Transceiver Frequency Accuracy during normal operation	$< \pm 40$ ppm, includes temperature compensation & aging effects
Modulation Type	Direct Sequence Spread Spectrum (DSSS), O-QPSK with half sine pulse shaping modulation (1M40Q7D)
Modulation Bandwidth	> 500 KHz, typically ± 950 KHz (6dB Bandwidth), typically ± 1.4 MHz (20dB Bandwidth)

Physical Specifications

ECG-only Transceiver

Parameter	Specification
Height	140 mm (5.6 in)
Width	75 mm (3 in)
Depth	28.5 mm (1.14 in)
Weight <ul style="list-style-type: none"> • without batteries or leadset • with batteries only • with batteries and 3-wire leadset 	<ul style="list-style-type: none"> • <165 g (5.8 oz) • <210 g (7.4 oz) • <284 g (10 oz)
Volume	215 cm ³

ECG/SpO₂ Transceiver

Parameter	Specification
Height	140 mm (5.6 in)
Width	88 mm (3.52 in)
Depth	37 mm (1.48 in)

Physical Specifications

Parameter	Specification
Weight <ul style="list-style-type: none">without batteries or leadsetwith batteries onlywith batteries and 5-wire leadset	<ul style="list-style-type: none"><205 g (7.2 oz)<255 g (9.0 oz)<324 g (11.5 oz)
Volume	300 cm ³

SRRA

Parameter	Specification
Height	88 mm (3.5 in)
Width	25 mm (1 in)
Depth	13 mm (.5 in)
Weight	25g (1 oz)

Environmental Specifications

Parameter	Specification
Temperature <ul style="list-style-type: none"> • Operating • Storage 	<ul style="list-style-type: none"> • 0 to 37 °C (32 to 99° F) • -40° C to 60° C (-40 to 140° F) without batteries
Humidity <ul style="list-style-type: none"> • Operating • Storage 	<ul style="list-style-type: none"> • ≤ 95% RH at 37° C (99° F) non-condensing • ≤ 90% RH at 60° C (140° F) without batteries
Altitude <ul style="list-style-type: none"> • Operating & Non-operating 	0 to 3,048 m (10,000 ft)

Measurement Specifications

ECG

Parameter	Specification
ECG channel transmitted Leads <ul style="list-style-type: none"> • 3 electrodes • 5 electrodes • 5 electrodes, EASI • 6 electrodes 	<ul style="list-style-type: none"> • Channel #1 = I, II, or III • Channel #1 = II Channel #2 = III Channel #3 = MCL • Channel #1 = Va-i Channel #2 = Va-s Channel #3 = Ve-s • Channel #1 = II Channel #2 = III Channel #3 = Va Channel #4 = Vb
Resolution	5 μ V
ECG Input	Differential, defibrillator protected against 360 joules discharge into a 100 ohm load
Input Impedance	> 5 megohms (@ 10 Hz)
Input Dynamic Range	+/- 9 mV
DC Offset Range	+/- 320 mV
CMRR	\geq 90 dB @ 50, 60 Hz
Bandwidth +/- 3 dB	0.05 to 40 Hz

Parameter	Specification																
Gain Accuracy	+/- 5% at 25 °C (77 °F)																
Noise Referred to ECG Input (Peak-to-Peak)	AAMI: 30 μ V (as per AAMI EC 13)																
Lead Wires	3, 5 or 6-wire leadset compatible with IntelliVue Patient Monitor, AAMI/IEC color codes																
Time to baseline from Defibrillator	AAMI: 5 s max (until ECG wave is on display but not yet centered, monitoring bandwidth)																
Pacer Rejection Performance (Pace pulses with no tails).	Positive pacers ¹ <table data-bbox="759 654 1225 776"> <thead> <tr> <th><u>Amplitude</u></th> <th><u>Width</u></th> </tr> </thead> <tbody> <tr> <td>+2 to +700 mV</td> <td>0.1, 0.2, 0.5 and 1.0 ms</td> </tr> <tr> <td>+2 to +500 mV</td> <td>1.5 ms</td> </tr> <tr> <td>+2 to +400 mV</td> <td>2 ms</td> </tr> </tbody> </table> Negative pacers ¹ <table data-bbox="759 816 1225 938"> <thead> <tr> <th><u>Amplitude</u></th> <th><u>Width</u></th> </tr> </thead> <tbody> <tr> <td>-2 to -700 mV</td> <td>0.1, 0.2, 0.5 and 1.0 ms</td> </tr> <tr> <td>-2 to -500 mV</td> <td>1.5 ms</td> </tr> <tr> <td>-2 to -400 mV</td> <td>2 ms</td> </tr> </tbody> </table> <p>¹ Philips does not claim, verify, or validate support for all available pacemakers.</p>	<u>Amplitude</u>	<u>Width</u>	+2 to +700 mV	0.1, 0.2, 0.5 and 1.0 ms	+2 to +500 mV	1.5 ms	+2 to +400 mV	2 ms	<u>Amplitude</u>	<u>Width</u>	-2 to -700 mV	0.1, 0.2, 0.5 and 1.0 ms	-2 to -500 mV	1.5 ms	-2 to -400 mV	2 ms
<u>Amplitude</u>	<u>Width</u>																
+2 to +700 mV	0.1, 0.2, 0.5 and 1.0 ms																
+2 to +500 mV	1.5 ms																
+2 to +400 mV	2 ms																
<u>Amplitude</u>	<u>Width</u>																
-2 to -700 mV	0.1, 0.2, 0.5 and 1.0 ms																
-2 to -500 mV	1.5 ms																
-2 to -400 mV	2 ms																
EMC Performance Limits, radiated immunity	Meets Essential Performance, but may observe some waveform disturbance over 181 to 202 MHz @ >1.8 V/m and 203 to 213 MHz @ > 1.0 V/m																

SpO₂

Parameter	Specification
SpO ₂ Measurement Range (Calibration and Display)	0 to 100%
SpO ₂ Accuracy	See table following.
SpO ₂ Resolution	1%
SpO ₂ Numerics - Averaging	<p>10 seconds</p> <p><i>Note</i>—The update rate for the SpO₂ pulse oximetry value and pulse rate is typically 1 second. This can be extended to a max. 60 s when NIBP is measured on the same limb, with a corresponding INOP message after a max. of 30 s, indicating that the displayed values are not current values.</p> <p>The effect of SpO₂ pulse oximetry on data averaging is internally controllable by the transmitter, with no user controls.</p>
SpO ₂ & Pulse Numerics - Update Rate	Transmitted once per second.
Pleth Wave- Sampling Rate	125 sps
Technical Alarms (INOPs)	Triggered if the sensor is disconnected, if a pulse is not detected, if the signal is noisy, if light interference is detected, if the sensor is defective, if the measurement is erratic, or if the module is malfunctioning

Parameter	Specification
Wavelength Range	500 to 1000 nm <i>Note</i> —Information about wavelength range can be especially useful to clinicians (e.g., clinicians performing photodynamic therapy).
Pulse Rate Measurement (available only with Continuous SpO ₂)	Range: 30 to 300 bpm Accuracy: +/- 2% Resolution: 1 bpm
Display of SpO ₂ numerics	SpO ₂ values are displayed as xxx % SpO ₂ T to meet ISO/EN standard EN 865.
Maximum Optical Output Power	≤ 15 mW

**SpO₂
Sensor
Accuracy**

Type	Description	Model Number	Accuracy% A _{rms} (70-100% Range)
Philips Reusable Sensors	Adult Finger	M1191A	2.0
	Adult Finger	M1191AL	2.0
	Adult Finger	M1191ANL	2.0
	Adult Finger*	M1191T	3.0
	Adult Finger	M1196A	3.0
	Adult Finger	M1196T	3.0
	Pediatric Finger	M1192A	2.0
	Pediatric Finger*	M1192T	3.0
	Pediatric Finger	M1192AN	2.0
	Adult/Pediatric Ear	M1194A	3.0
	Adult/Pediatric Ear	M1194AN	3.0
	* Requires M1943A or M1943AL adapter cable.		

Type	Description	Model Number	Accuracy% A_{rms} (70-100% Range)
Philips Disposable Sensors	Adult Finger	M1901B	2.0
	Adult Finger	M1902B	2.0
	Pediatric Finger	M1903B	2.0
	Adult Finger	M1904B	2.0
	Adult/Pediatric Finger	M1131A	3.0

Measurement Specifications

Type	Description	Model Number	Accuracy% A_{rms} (70-100% Range)
Nellcor Disposable Sensors (not available from Philips)	OxiCliq A, Adult	N/A	3.0
	OxiCliq N, Adult >40 kg (88 lb)	N/A	3.0
	OxiCliq P, Pediatric	N/A	3.0
	OxiMax MAX-A, Adult >30 kg (66 lb)	N/A	3.0
	OxiMax MAX-AL, Adult >30 kg (>66 lb)	N/A	3.0
	OxiMax MAX-N, Adult >40 kg (>88 lb)	N/A	3.0
	OxiMax MAX-P, Pediatric 10-50 kg (22-110 lb)	N/A	3.0
	Oxisensor II D-20, Pediatric 10-50 kg (22-110 lb)	N/A	3.0
	Oxisensor II D-25, Adult >30 kg (>66 lb)	N/A	3.0
	Oxisensor II N-25, Adult >40 kg (>88 lb)	N/A	3.0

A

Accessories

This appendix lists the accessories for use with the Transceiver. Accessories are subject to change. Some accessories are not supplied by Philips.

To order accessories, visit the Philips Medical Supplies website located at the following web address: <http://shop.medical.philips.com>, or contact your local Philips representative.

Accessory Safety

Warning

Use only Philips-approved accessories. Use of product accessories (ECG leadsets, SpO₂ sensors, etc.) other than those specified in this manual may:

- lead to patient injury
- result in increased electromagnetic emissions or decreased immunity of the product

Warning

Reuse: Never reuse disposable sensors, accessories and so forth that are intended for single use, or single patient use only.

Packaging: Do not use a sterilized accessory if the packaging is damaged.

Transceiver Accessories

Pouches

Order Number	Description
989803137821	Telemetry Pouch, box of 5
989803137831	Telemetry Pouch, box of 50
989803140371	Telemetry Pouch, case of 200

Protective Covers

Order Number	Description
989803140431	Protective Cover for Monitor/Service port (ECG-only Transceiver), package of 10
989803140451	Protective Cover for Monitor/Service port (ECG/ SpO ₂ Transceiver), package of 10
989803140441	Protective Cover for SpO ₂ port (ECG/SpO ₂ Transceiver), package of 10

Monitor Interface Cable

Order Number	Description
989803143481	Transceiver tether cable
989803143491	Telemon tether cable
989803146911	MP5/MP5T Patient Monitor tether cable

Short-Range Radio Adapter

Order Number	Description
989803158241	Short-Range Radio Adapter
989803160381	Short Range Radio Adapter Strap (1 package of 10)

ECG Accessories

Electrodes

Order Number	Description
M2202A	Radio Translucent Foam Electrodes, 60 packages of 5 (300 per box)
40489E	Paper Tape Electrodes, 10 packages of 30 (300 per box)
40493D	Foam Electrodes, 60 packages of 5 (300 per box)
40493E	Foam Electrodes, 10 packages of 30 (300 per box)

Skin Prep Paper

Order Number	Description
989803134771	Skin Preparation Sheets, 10 preps/sheet, package of 10 sheets

Leadsets

Order Number	Description
989803151991	AAMI 3-wire Leadset, Snap, 79 cm (30 ")
989803151971	AAMI 3-wire Leadset, Grabber, 79 cm (30 ")
989803152071	AAMI 5-wire Color Leadset, Snap, 79 cm (30 ")
989803152051	AAMI 5-wire Color Leadset, Grabber, 79 cm (30 ")
989803152151	AAMI 6-wire Color Leadset, Snap, 79 cm (30 ")
989803152131	AAMI 6-wire Color Leadset, Grabber, 79 cm (30 ")
989803152001	IEC 3-wire Leadset, Snap, 79 cm (30")
989803151981	IEC 3-wire Leadset, Grabber, 79 cm (30")
989803152081	IEC 5-wire Color Leadset, Snap, 79 cm (30")
989803152061	IEC 5-wire Color Leadset, Grabber, 79 cm (30")
989803152161	IEC 6-wire Color Leadset, Snap, 79 cm
989803152141	IEC 6-wire Color Leadset, Grabber, 79 cm

Alignment Guides

Order Number	Description
989803140401	Single ECG Alignment Guide, package of 10
989803140411	Single ECG Alignment Guide, tethered, package of 10
989803140421	Double ECG Alignment Guide, package of 10

Detachable Shields

Order Number	Description
989803153031	3-wire Leadset Detachable Shield, package of 10
989803153041	5-wire Leadset Detachable Shield, package of 10
989803153051	6-wire Leadset Detachable Shield, package of 10

SpO₂ Accessories

Reusable Sensors

Order Number	Description
M1191A	Philips Adult Finger Sensor, 2m (6.6 feet)
M1191AL	Philips Adult Finger Sensor, 3m (9.8 feet)
M1191B	Philips Adult Finger Sensor, 2 m (6.6 feet)
M1191BL	Philips Adult Finger Sensor, 3 m (9.8 feet)
M1191T	Philips Adult Finger Sensor, 0.45 m (1.5 feet)
M1192A	Philips Pediatric Finger Sensor, 1.5 m (4.9 feet)
M1192T	Philips Pediatric Finger Sensor, 0.45 m (1.5 feet)
M1194A	Philips Adult & Pediatric Ear Sensor, 1.5 m (4.9 feet)
M1196A	Philips Adult Finger Clip Sensor (8-pin), 3 m (9.8 feet)
M1196T	Philips Adult Finger Clip Sensor (9-pin), 0.90 m (2.9 feet)
N/A from Phillips	Nellcor Dura-Y D-YS Adult and Pediatric
N/A from Phillips	Nellcor DS-100A Adult and Pediatric
N/A from Phillips	Nellcor Oxiband OXI-A/N Adult and Pediatric
N/A from Phillips	Nellcor Oxiband OXI-P/I Adult and Pediatric
N/A from Phillips	Nellcor D-YSE Adult
N/A from Phillips	Nellcor D-YSPD Pediatric
989803148281	Masimo LNCS DC-I Adult
989803148291	Masimo LNCS DC-IP Pediatric
989803148301	Masimo LNCS TC-I Ear Clip

Disposable Sensors - Single Use

Note—OxiCliq, OxiMax and Oxisensor II sensors are not available from Philips in the USA or Canada. In those countries, contact Nellcor Incorporated directly.

Order Number	Description
M1901B	*Philips Adult >40 kg (>88 lb)
M1902B	*Philips Pediatric 3-20 kg (7-44 lb)
M1903B	*Philips Pediatric 10-50 kg (22-110 lb)
M1904B	*Philips Adult >30 kg (>66 lb)
M1131A	*Philips Adult/Pediatric >20 kg (>44 lb)
N/A from Philips	*Nellcor Adhesive OxiCliq A, Adult
N/A from Philips	*Nellcor Adhesive OxiCliq N, Adult >40kg (>88 lb)
N/A from Philips	*Nellcor Adhesive OxiCliq P, Pediatric
N/A from Phillips	*Nellcor Adhesive OxiCliq I, Infant 3-20 kg
N/A from Philips	*Nellcor OxiMax MAX-A, Adult >30 kg (>66 lb) (M1904B equivalent)
N/A from Philips	*Nellcor OxiMax MAX-AL, Adult >30 kg (>66 lb)
N/A from Philips	*Nellcor OxiMax MAX-N, Adult >40 kg (>88 kg) (M1901B equivalent)
N/A from Philips	*Nellcor OxiMax MAX-P, Pediatric 10-50 kg (22-110 lb) (M1903B equivalent)
N/A from Philips	*Nellcor OxiMax MAX-I, Infant 3-20 kg (M1902B equivalent)
N/A from Philips	*Nellcor Oxisensor II D-20, Pediatric 10-50 kg (22-110 lb)
N/A from Philips	*Nellcor Oxisensor II D-25, Adult >30 kg (>66 lb)
N/A from Philips	*Nellcor Oxisensor II N-25, Adult >40 kg (>88 lb)
989803140261	**Masimo LNOP Pdt Pediatric 10-50 kg (22-110 lb)
N/A from Philips	**Masimo LNOP Pdt Pediatric 10-50 kg (22-110 lb)

SpO₂ Accessories

Order Number	Description
989803148231	***Masimo LNCS Amtx Adult >30 kg (>66 lb)
989803148241	***Masimo LNCS Pmtx Pediatric 10-50 kg (22-110 lb)
N/A from Philips	***Masimo LNCS Neo-3 Adult >40 kg (>88 lb)
* Uses Philips M1943A or Nellcor OC-3 Adapter Cable **Uses Philips M1020-61100 Adapter Cable ***Uses Philips 989803148221 Adapter Cable	

Adapter Cables

Note—Adapter cables are not available from Philips in Canada or Japan. In those countries, contact Nellcor Incorporated directly.

Order Number	Description
M1943A	Adapter cable for Nellcor SpO ₂ sensor, 2 m (6.6 ft)
M1943AL	Adapter cable for Nellcor SpO ₂ sensor, 3 m (9.8 ft)

Wristband

Order Number	Description
M1627A	Wristband, package of 10

Sales and Support Offices

Please call your local Philips Medical Systems sales office listed in your telephone directory or a Philips Medical Systems regional office listed below for the location of your nearest sales office.

On the web

www.medical.philips.com

Via email

medical@philips.com

By fax

+31 40 27 64 887

By postal service

**Philips Medical Systems
Global Information Center
P.O. Box 1168
5602 BD Eindhoven
The Netherlands**

Asia

Tel: +852 2821 5888

Europe, Middle East, Africa

Tel: +31 40 27 63005

Latin America

Tel: +55 11 2125 0764

North America

Tel: +1 800 229 6417

Index

A

alarms

- indicators, 5-2
- more bed alarms, 10-21
- physiologic, 5-5
- SpO₂, 8-21
- technical, 5-11
- testing indicators, 5-2
- testing, 11-2
- turning off, 4-3

audible tones

- definitions, 3-12
- start-up, 4-3

auditory information signals

- see audible tones, 3-12

B

battery

- inserting, removing, 4-14
- life, 4-18, 12-8
- safety, 4-13
- storing, 4-16
- type, 4-14

buttons 3-3

C

configuration

- group settings, 11-14
- label assignment, 11-2
- Telemetry Setup, 9-6
- unit settings, 9-9

controls

- buttons, 3-3
- indicators, 3-5
- labels,back, 3-9
- labels,front, 3-6
- on/off, 4-2
- other marks, 3-9

ports, 3-7

D

device location 9-4

dropouts (ECG), 6-30

E

ECG

- measuring, 6-4
- optimizing performance, 6-29

electrodes

- placement, 6-10
- skin prep, 6-11

electromagnetic interference, 12-5

essential performance, 12-3

F

fallback, 6-27

find device, 9-3

G

group settings 11-14

group settings, 11-14

I

Information Center

- transceiver use with, 1-9

information signals, 11-15

INOPs, see technical alarms, 5-11

intended use

- QT interval, 7-14
- ST/AR, 7-5
- transceiver, 12-2

interference, 6-29, 12-7

L

label assignment, 11-2

lead placement, 6-13

leads off, 6-27

M

MP5/MP5T, 10-1

N

noise

eliminating, 6-32

Nurse Call 5-6

on/off, 9-6

O

on/off, 4-2

operation, 4-3

ordering information

ECG supplies, A-3

SpO2 supplies, A-6

transceiver supplies, A-2

P

pairing at Information Center, 10-4

pairing with MP5, 10-4

patient window, 9-2

pause alarms, 5-2

pleth wave display on/off, 9-8, 9-13

pouch, 4-7

pulse rate display on/off, 9-8, 9-13

pulse tone on/off, 3-14, 9-6

Q

QT, 7-14

R

RF auto shutoff 9-18

RF auto shutoff, 9-11

RF interference, 6-31

S

safety

battery, 4-13

general, 2-2

paced, 7-3

SpO2 sensor, 8-11

SpO2, 8-2

ST/AR, 7-2

symbols, 3-9

transceiver, 4-2

self-test

alarm indicators, 5-2

service log, 11-15

Short-Range Radio

attaching adapter, 10-7

cleaning adapter, 11-6

error conditions, 10-23

monitoring considerations, 10-22

pairing (networked), 10-6

pairing (non-networked), 10-18

stopping communication, 10-9

unassigning, 10-20

unpairing, 10-8

shower

transceiver use in, 4-10, 12-4

signal strength, 6-31

skin prep, 6-11

smart hopping, 1-5

sounds

see audible tones, 3-12

specifications

environmental, 12-15

measurement, 12-16

physical, 12-13

SpO2

audible tones, 3-13, 8-17, 8-18

auto on/off, 8-20

Continuous, 8-18

measurement, 8-5

mode selection, 9-7, 9-12

NBP inop suppression, 9-8, 9-13

optimizing use, 8-22

Spot Check, 8-17

turning measurement on/off, 8-19

turning SpO2 parameter on/off, 8-20

SpO2 sensors

applying, 8-11

selecting, 8-9

ST 7-7

adjusting measurement points, 7-10

- alarm adjustments, 7-13
 - smart limits, 7-13
 - turning on/off, 7-9
- ST/AR
 - arrhythmia analysis, 7-5
 - intended use, 7-5
 - ST analysis, 7-7
- ST/AR QT analysis, 7-14
- ST/AR QT interval algorithm, 7-14
- standby mode, 4-4
- suspend alarms, 5-2
- symbols, 3-7
- system messages
 - see information signals, 11-15
- T**
- Telemetry Setup, 9-6
- TeleMon
 - NBP measurement with, 1-9
 - SpO2 measurement modes, 8-19, 9-20
 - transceiver use with, 1-9, 9-19
- testing
 - alarm indicators, 5-2
 - alarms, 5-2
 - status check, 4-12
- transceiver
 - controls, 3-2
 - models, 1-2
- troubleshooting 6-32, 11-14
- TRx (ECG-only)
 - see transceiver models, 1-2
- TRx+ (ECG + SpO2)
 - see transceiver models, 1-2
- U**
- unit settings, 9-9
- V**
- volume, 9-6

