

**COMPLIANCE WORLDWIDE INC.  
TEST REPORT 217-06R1**

**In Accordance with the Requirements of  
FCC PART 15, SUBPART C  
INDUSTRY CANADA RSS 210, ISSUE 6**

**Low Power License-Exempt Radio Communication Devices  
Intentional Radiators**

Issued to

**Philips Medical Systems  
3000 Minuteman Drive  
Andover, MA 01810  
978-659-2800**

for

**ITS4852A = M4852A Telemetry II Access Point / ROW  
with the  
IntelliVue Information Center  
System Revision "J"**

**Report Issued on October 25, 2006**

Tested by

  
\_\_\_\_\_  
Brian F. Breault

Reviewed by

  
\_\_\_\_\_  
Larry K. Stillings

This test report shall not be reproduced, except in full, without written permission from Compliance Worldwide, Inc.

## Table of Contents

1 Scope .....	3
2 Product Details .....	3
2.1 Manufacturer .....	3
2.3 Serial Number .....	3
2.4 Description .....	3
2.5 Power Source .....	3
2.6 EMC Modifications .....	3
3 Product Configuration .....	3
3.1 Operational Characteristics & Software .....	3
3.2 Support Equipment .....	4
3.3 Additional Support Equipment (Directly connected to the DUT) .....	4
3.4 Cables .....	4
3.5 Block Diagram .....	5
4 Measurements Parameters .....	6
4.1 Measurement Equipment Used to Perform Test .....	6
4.2 Measurement & Equipment Setup .....	6
4.3 Test Procedure .....	6
5 Measurement Summary .....	7
6 Measurement Data .....	8
6.1 Power Line Conducted Emissions .....	8
6.2 Radiated Field Strength of Fundamental .....	11
6.2 Radiated Field Strength of Harmonics .....	11
6.3 Spurious Radiated Emissions .....	13
6.4 Spurious Radiated Emissions >1 GHz .....	15
6.5 Band Edge Measurements .....	16
6.6 99% Power Bandwidth .....	18
7 Test Site Description .....	19
8 Test Setup Photographs .....	20

## 1 Scope

This test report certifies that the Philips ITS4852A = M4852A Telemetry II Access Point (AP)/ROW, as tested, meets the FCC Part 15, Subpart C and Industry Canada RSS 210, Issue 6 requirements. The scope of this test report is limited to the test sample provided by the client, only in as much as that sample represents other production units. If any significant changes are made to the unit, the changes shall be evaluated and a retest may be required. This report replaces test report# 217-06.

## 2 Product Details

- 2.1 Manufacturer:** Philips Medical Systems
- 2.2 Model Number:** ITS4852A = M4852A Telemetry II Access Point / ROW
- 2.3 Serial Number:** US42300589
- 2.4 Description:** ITS4852A = M4852A Access Point receives the telemetry signal from the Patient Worn Device and sends patient data to the IntelliVue Information Center through the current CTS Infrastructure via the M3185A IntelliVue Clinical Network.
- 2.5 Power Source:** 48 Volts DC through Ethernet cable
- 2.6 EMC Modifications:** None

## 3 Product Configuration

### 3.1 Operational Characteristics & Software

- 3.3.1 From APC Web interface,
- a) Go to 'WMTS AP Configuration' screen,
  - b) Select 'ISM AREA' pull down menu to select area below:
    - 1) Europe
    - 2) Europe (non-hopping)
    - 3) North America
    - 4) North America (non-hopping)
    - 5) Select save after highlighting the desired mode
- 3.3.2 Use the IntelliVue Information Center to monitor the proper operation of the PWD.

### 3 Product Configuration (continued)

#### 3.2 Support Equipment

Blk #	Mfgr	Model / Part #	Opt	HW Rev.	FW Rev.	SW Rev.	Serial # (if available)	Nom. Voltage	Description
2	Philips	M1191ANL	N/A	N/A	N/A	N/A	N/A	N/A	SpO2 transducer
3	DNI Nevada	Oxitest 7	N/A	N/A	N/A	N/A	DOS03040647	9 VDC	SpO2 simulator Recall #125346
4	Bio-Tek	Lionheart 2	N/A	N/A	N/A	N/A	203926	9 VDC	Multi-parameter patient simulator Recall #125005
5	Philips	M4851A	N/A				N/A	3 VDC	2.4 GHz ROW Patient Worn Device
6	Philips	M4844A/ 453563495101	ABA	Prd	N/A	N/A	US34300035	120 VAC	Synchronization Box
7	Power-D-Sine	PD-6006AC	N/A	NA	NA	NA	M03056809512000	120 VAC	Power Over Ethernet Hub 6 Port
8	Cisco	WS-C2950G-24	N/A	NA	NA	NA	F030732Z1WX	120 VAC	24 Port 10/100 Ethernet Switch
9	Philips	M3171A/ 453564009481	N/A	NA	NA	NA	US50100106	120 VAC	Access Point Controller
10	HP	EVO	N/A	NA	NA	G.	USU32301H2	120 VAC	IntelliVue Information Center- HP PC
11	HP	D2807A/ D2807-60011	N/A	N/A	N/A	N/A	JP50101212	120 VAC	Display for IntelliVue Information Center
12	Triplite	Smart Pro	N/A	N/A	N/A	N/A	9336ALCSM51390 1271	120 VAC	Uninterruptible Power Supply

#### 3.3 Additional Support Equipment (Directly connected to the DUT)

Blk #	Manufacturer	Model/Part Number	Serial Number	Nom. Voltage	Description
3	Bio-Tek	Lionheart2	204214	9 VDC	Multi-parameter patient simulator

#### 3.4 Cables

Blk Item	Part #	Shielded Y or N	Length	No. of Conductors (if avail.)	Port Tested (Y/N)	Termination	Function / Description
A	N/A	N	10 m	8	N	N/A	Category 5 UTP cable, various lengths
B	392 925	N	1 m	6	N	N/A	ECG leadset
C	N/A	N	2 m	3	N	N/A	AC power cords
D	M1941A	N	2 m	2	N	N/A	SpO2 extension cable

**3 Product Configuration (continued)**

**3.5 Block Diagram**

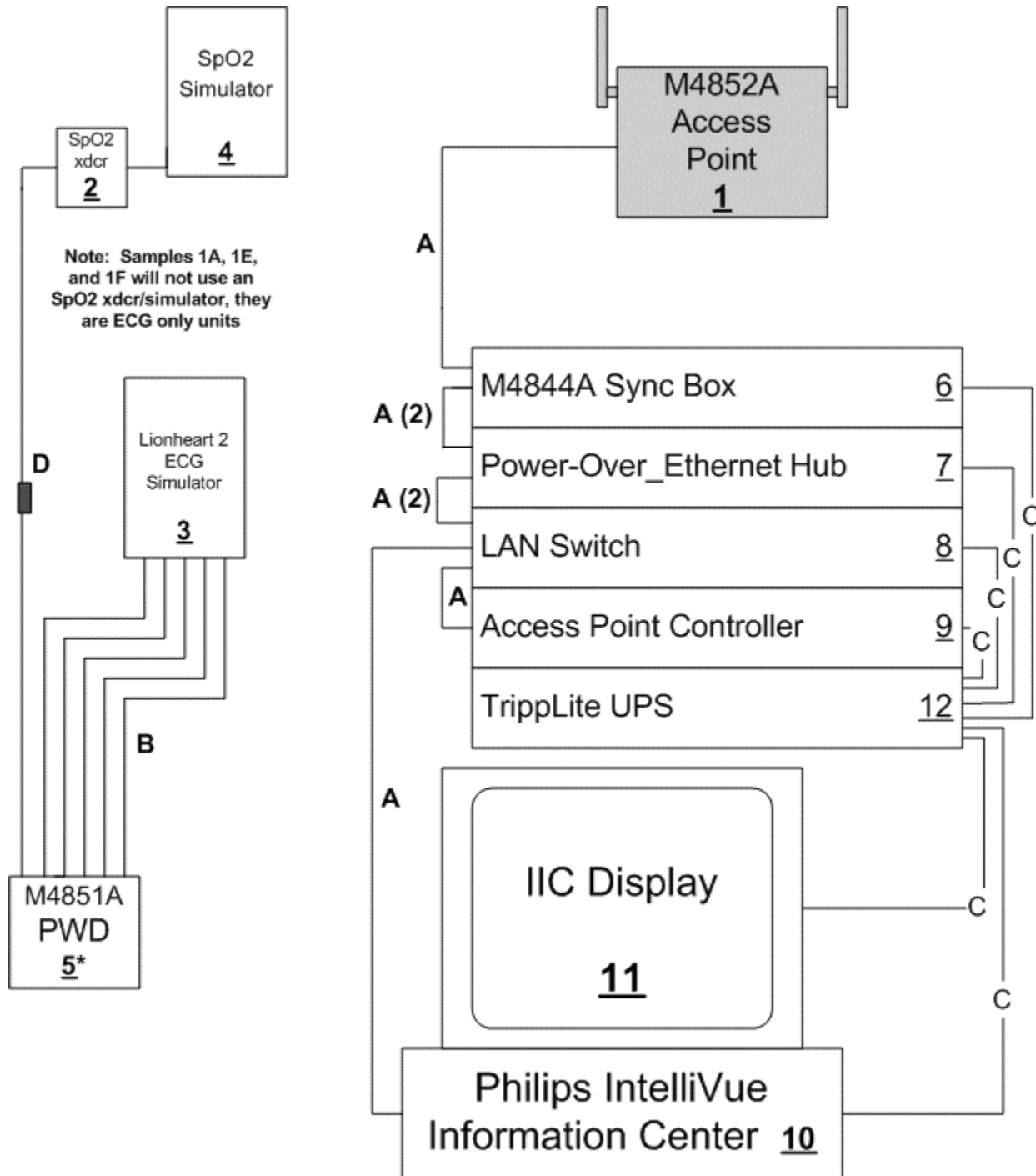

## 4 Measurements Parameters

### 4.1 Measurement Equipment Used to Perform Test

Device	Manufacturer	Model No.	Serial No.	Last Cal	Cal Due
EMI Receiver	Hewlett Packard	8546A	3650A00360	1/5/2005	1/5/2007
Spectrum Analyzer	Hewlett Packard	8593E	3829A03887	3/13/2006	3/13/2007
Microwave Preamp	Hewlett Packard	8449B	3008A01323	8/3/2004	8/3/2006
Bilog Antenna	Com-Power	AC220	25509	1/31/2006	1/31/2007
Horn Antenna	Electro-Metrics	EM-6961	6337	7/30/2004	7/30/2006
Horn Antenna	Com-Power	AH-840	03075	7/30/2004	7/30/2006
2.4 GHz BP Filter	Micro-Tronics	BRM50702	14	11/2/2004	11/2/2006

### 4.2 Measurement & Equipment Setup

Test Date:	July 10 <sup>th</sup> – 12 <sup>th</sup> , 2006
Test Engineer:	Brian Breault
Normal Site Temperature (15 - 35°C):	21.6
Extreme Test Temperatures (°C):	0 and +35
Relative Humidity (20 -75%RH):	25
Frequency Range:	2.402 GHz to 2.480 GHz
Measurement Distance:	3 Meters
EMI Receiver IF Bandwidth:	Depends on measurement
EMI Receiver Avg Bandwidth:	Depends on measurement
Detector Function:	Depends on measurement

### 4.3 Test Procedure

Test measurements were made in accordance FCC Part 15.249, IC RSS-210 Annex II: Operation within the bands 902 - 928 MHz, 2400 - 2483.5 MHz, 5725 - 5875 MHz, and 24.0 - 24.25 GHz.

The test methods used to generate the data in this test report is in accordance with ANSI C63.4: 2003, American National Standard for Methods of Measurement of Radio-Noise Emissions from Low-Voltage Electrical and Electronic Equipment in the Range of 9 kHz to 40 GHz

### 5 Measurement Summary

Test Requirement	FCC Part 15 Reference	Test Report Section	Result	Comment
Antenna Requirement	15.203	N/A	Compliant	The unit uses a reverse polarity TNC Connector
Conducted Emissions	15.207	6.1	Compliant	See Section 6.1 Test Note
Radiated Field Strength of Fundamental	15.249 (a)	6.2	Compliant	
Radiated Field Strength of Harmonics	15.249 (a)	6.3	Compliant	
Spurious Radiated Emissions	15.249 (d)	6.4	Compliant	
Band Edge Measurements	--	6.5	Compliant	
Bandwidth 99% Power	IC RSS-GEN	6.6	Compliant	

#### From IC RSS-GEN

#### User Manual for Transmitters with Detachable Antennas

The user manual of transmitter devices equipped with detachable antennas shall contain the following information in a conspicuous location:

*“This device has been designed to operate with the antennas listed below, and having a maximum gain of [x] dB. Antennas not included in this list or having a gain greater than [x] dB are strictly prohibited for use with this device. The required antenna impedance is [y] ohms.”*

Equipment manufacturers shall provide proper values of x and y to comply with the applicable RSS. Immediately following the above statement, the manufacturer shall provide a list of all antennas acceptable for use with the transmitter.

## 6 Measurement Data

### 6.1 Power Line Conducted Emissions (15.207), IC RSS-GEN

Requirement: For an intentional radiator that is designed to be connected to the public utility (AC) power line, the radio frequency voltage that is conducted back onto the AC power line on any frequency or frequencies within the band 150 kHz to 30 MHz shall not exceed the limits in the following table, as measured using a 50  $\mu$ H/50 ohms line impedance stabilization network (LISN). Compliance with the provisions of this paragraph shall be based on the measurement of the radio frequency voltage between each power line and ground at the power terminal.

Test Note: The DUT is powered by 48 volts DC supplied by the Ethernet cable. The power line conducted emissions test was performed on the Power-D-Sine POE Box that supplies the 48 VDC to the DUT via the Ethernet cable.

#### 6.1.1 Power Line Conducted Emissions Test Setup

##### 6.1.1.1 Regulatory Limit: (15.207) (FCC Part 15, Class B)

Frequency Range (MHz)	Limits (dB $\mu$ V)	
	Quasi-Peak	Average
0.15 to 0.50	66 to 56*	56 to 46*
0.50 to 5.0	56	46
5.0 to 30.0	60	50

\* Decreases with the logarithm of the frequency.

##### 6.1.1.2 Measurement Equipment Used to Perform Test

Device	Manufacturer	Model	Serial No.	Last Cal	Cal Due
EMI Receiver	Hewlett Packard	8546A	3650A00360	1/5/2005	1/5/2007
LISN	EMCO	3825/2	9109-1860	12/15/2004	12/15/2006

##### 6.1.1.3 Measurement & Equipment Setup

Test Date:	07/13/2006
Test Engineer:	Michael Desmarais
Site Temperature ( $^{\circ}$ C):	20.8
Relative Humidity (%RH):	30
Frequency Range:	0.15 MHz to 30 MHz
EMI Receiver IF Bandwidth:	9 kHz
EMI Receiver Avg Bandwidth:	30 kHz
Detector Functions:	Peak, Quasi-Peak. & Average

##### 6.1.1.4 Test Procedure

Test measurements were made in accordance with ANSI C63.4-2003, Standard Methods of Measurement of Radio Noise Emissions from Low-Voltage Electrical and Electronics Equipment in the Range of 9 kHz to 40 GHz.



## 6 Measurement Data (continued)

### 6.1.2 Conducted Emissions Test Data

#### 6.1.2.1 120 Volts, 60 Hz Phase

Test No.: 217-06, 120 Volts, 60 Hz Phase

FCC, Class B

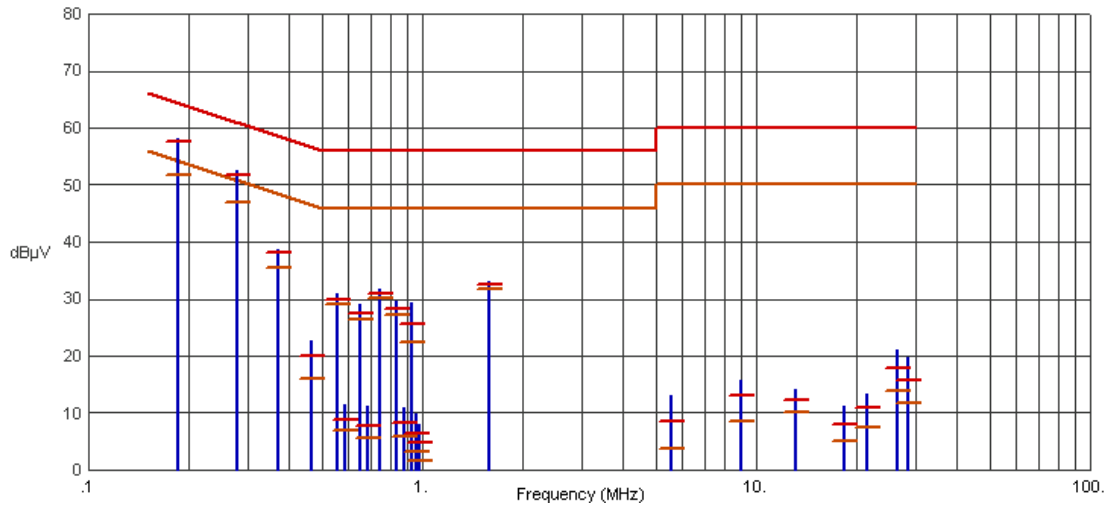

Frequency (MHz)	Pk Amp (dBµV)	QP Amp (dBµV)	QP Limit (dBµV)	QP Margin (dB)	Avg Amp (dBµV)	Avg Limit (dBµV)	Avg Margin (dB)	Comments
.1858	58.22	57.63	64.22	-6.59	51.78	54.22	-2.44	
.2787	52.64	51.80	60.85	-9.05	47.02	50.85	-3.83	
.3713	38.71	38.12	58.47	-20.35	35.49	48.47	-12.98	
.4637	22.46	19.96	56.63	-36.67	15.90	46.63	-30.73	
.4644	22.54	19.91	56.61	-36.70	15.98	46.61	-30.63	
.5578	30.88	29.89	56.00	-26.11	29.05	46.00	-16.95	
.5863	11.46	8.78	56.00	-47.22	7.04	46.00	-38.96	
.6517	29.18	27.56	56.00	-28.44	26.28	46.00	-19.72	
.6852	11.16	7.70	56.00	-48.30	5.62	46.00	-40.38	
.7432	31.83	30.91	56.00	-25.09	30.19	46.00	-15.81	
.8374	29.55	28.20	56.00	-27.80	27.22	46.00	-18.78	
.8819	10.84	8.16	56.00	-47.84	6.00	46.00	-40.00	
.9288	29.38	25.58	56.00	-30.42	22.28	46.00	-23.72	
.9589	9.78	6.35	56.00	-49.65	3.07	46.00	-42.93	
.9786	7.92	4.88	56.00	-51.12	1.51	46.00	-44.49	
1.5783	33.05	32.44	56.00	-23.56	31.77	46.00	-14.23	
5.5718	13.17	8.62	60.00	-51.38	3.77	50.00	-46.23	
9.0050	15.77	13.13	60.00	-46.87	8.62	50.00	-41.38	
13.1151	14.20	12.15	60.00	-47.85	10.08	50.00	-39.92	
18.3020	11.26	8.13	60.00	-51.87	4.96	50.00	-45.04	
21.5295	13.23	10.96	60.00	-49.04	7.43	50.00	-42.57	
26.4868	21.09	17.87	60.00	-42.13	13.87	50.00	-36.13	
28.5008	19.86	15.64	60.00	-44.36	11.85	50.00	-38.15	

Result: Passed

6 Measurement Data (continued)

6.1.2 Conducted Emissions Test Data (continued)

6.1.2.2 120 Volts, 60 Hz Neutral

Test No.: 217-06, 120 Volts, 60 Hz Neutral

FCC, Class B

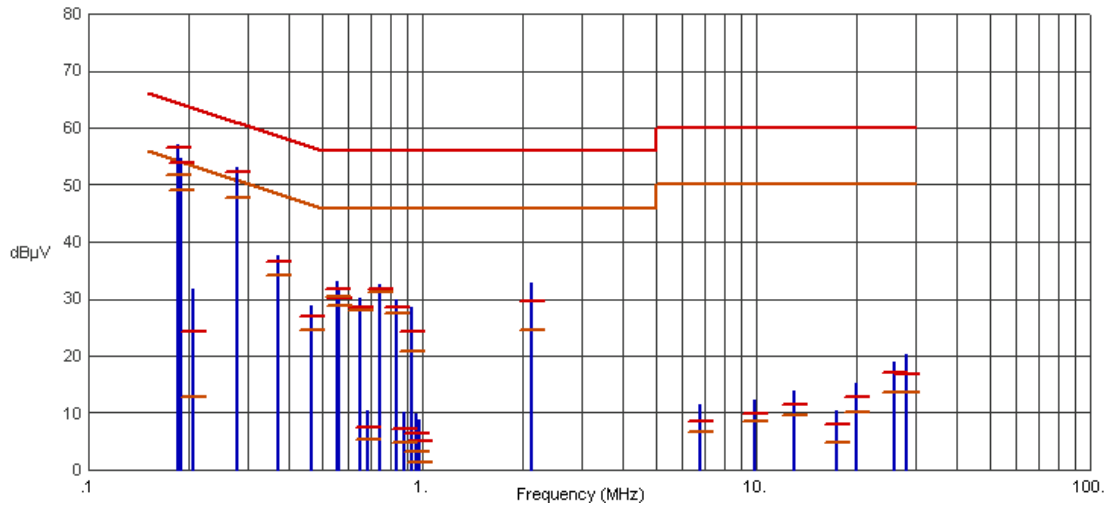

Frequency (MHz)	Pk Amp (dBµV)	QP Amp (dBµV)	QP Limit (dBµV)	QP Margin (dB)	Avg Amp (dBµV)	Avg Limit (dBµV)	Avg Margin (dB)	Comments
.1856	57.06	56.48	64.23	-7.75	51.63	54.23	-2.60	
.1889	54.78	53.98	64.08	-10.10	49.10	54.08	-4.98	
.2052	31.64	24.16	63.40	-39.24	12.82	53.40	-40.58	
.2786	53.06	52.22	60.86	-8.64	47.74	50.86	-3.12	
.3711	37.71	36.54	58.48	-21.94	34.14	48.48	-14.34	
.4654	28.80	26.95	56.60	-29.65	24.40	46.60	-22.20	
.5563	33.12	31.86	56.00	-24.14	30.48	46.00	-15.52	
.5597	31.62	30.15	56.00	-25.85	28.81	46.00	-17.19	
.6489	30.09	28.66	56.00	-27.34	28.02	46.00	-17.98	
.6858	10.44	7.59	56.00	-48.41	5.44	46.00	-40.56	
.7424	32.46	31.64	56.00	-24.36	31.13	46.00	-14.87	
.8352	29.82	28.50	56.00	-27.50	27.41	46.00	-18.59	
.8815	10.20	7.32	56.00	-48.68	4.90	46.00	-41.10	
.9267	28.47	24.35	56.00	-31.65	20.86	46.00	-25.14	
.9589	9.97	6.27	56.00	-49.73	3.12	46.00	-42.88	
.9806	8.86	5.01	56.00	-50.99	1.28	46.00	-44.72	
2.1349	32.80	29.55	56.00	-26.45	24.50	46.00	-21.50	
6.7584	11.39	8.59	60.00	-51.41	6.72	50.00	-43.28	
9.8935	12.15	9.89	60.00	-50.11	8.50	50.00	-41.50	
12.9268	13.95	11.56	60.00	-48.44	9.62	50.00	-40.38	
17.3348	10.41	7.92	60.00	-52.08	4.68	50.00	-45.32	
20.0002	15.32	12.77	60.00	-47.23	10.25	50.00	-39.75	
25.8764	18.96	17.12	60.00	-42.88	13.65	50.00	-36.35	
28.3182	20.35	16.86	60.00	-43.14	13.58	50.00	-36.42	

Result: Passed

**6 Measurement Data (continued)**

**6.2 Radiated Field Strength of Fundamental (15.249, Section (a)), IC RSS-210 A2.9**

Requirement: The 3 meter field strength of the fundamental emissions from intentional radiators operated within the 2400-2483.5 MHz frequency bands shall comply with the following requirement: 50 millivolts/meter (94 dB $\mu$ V/m), average mode measurement.

Note: The peak field strength of any emission shall not exceed the maximum permitted average limits specified by more than 20 dB under any condition of modulation.

Channel	Frequency (MHz)	Amplitude (dB $\mu$ V)		Corr Fact (dB)	Amplitude (dB $\mu$ V/m)		Average Limit	Margin (dB)	Ant Pol	Ant Ht	TT Pos	Result
		Peak	Avg		Peak	Avg						
Low	2401.056	81.84	35.64	29.85	111.69	65.49	94	-28.51	V	111	4	Passed
Middle	2439.072	83.13	34.67	29.96	95.48	64.63	94	-29.37	V	134	6	Passed
High	2482.272	79.77	35.11	29.96	109.73	65.07	94	-28.93	V	113	4	Passed

**6.2 Radiated Field Strength of Harmonics (15.249, Section (a)), IC RSS-210 A2.9**

Requirement: The 3 meter field strength of the harmonic emissions from intentional radiators operated within the 2400-2483.5 MHz frequency bands shall comply with the following: 500 microvolts/meter (54 dB $\mu$ V/m), average mode measurement

Note: The peak field strength of any emission shall not exceed the maximum permitted average limits specified by more than 20 dB under any condition of modulation.

**6.2.1 Lower Channel (2401.056 MHz)**

Frequency (MHz)	Amplitude (dB $\mu$ V)		Corr. Fact. (dB)	Amplitude (dB $\mu$ V/m)		Average Limit	Margin (dB)	Ant Pol	Ant Ht	TT Pos	Result
	Peak	Avg		Peak	Avg						
4802.112 <sup>1</sup>	46.96	26.96	0.64	47.60	27.60	54	-26.40	V	225	127	Passed
7203.168	49.61	29.61	4.33	53.94	33.94	54	-20.06	V	100	275	Passed
9604.224	50.83	30.83	7.58	58.41	38.41	54	-15.59	V	100	265	Passed
12005.280 <sup>1</sup>	44.55	24.55	11.05	55.60	35.60	54	-18.40	V	100	260	Passed
14406.336	46.16	26.16	18.18	64.34	44.34	54	-9.66	V	100	190	Passed
16807.392	46.84	26.84	20.29	67.13	47.13	54	-6.87	V	100	270	Passed
19208.448 <sup>1</sup>	47.02	27.02	8.44	55.46	35.46	54	-18.54	Noise Floor			Passed
21609.504	48.30	28.30	8.59	56.89	36.89	54	-17.11	Noise Floor			Passed
24010.560	47.95	27.95	9.43	57.38	37.38	54	-16.62	Noise Floor			Passed

<sup>1</sup> Frequency falls within the Restricted Bands of Operation. See FCC Part 15, Section 15.205 for additional information.

## 6 Measurement Data (continued)

### 6.2 Radiated Field Strength of Harmonics (continued)

#### 6.2.2 Middle Channel (2439.072 MHz)

Frequency (MHz)	Amplitude (dBµV)		Corr. Fact. (dB)	Amplitude (dBµV/m)		Average Limit	Margin (dB)	Ant Pol	Ant Ht	TT Pos	Result
	Peak	Avg		Peak	Avg						
4878.144 <sup>1</sup>	45.65	25.65	0.77	46.42	26.42	54	-27.58	V	136	185	Passed
7317.216 <sup>1</sup>	49.67	29.67	4.66	54.33	34.33	54	-19.67	V	115	225	Passed
9756.288	48.73	28.73	8.07	56.80	36.80	54	-17.20	V	100	0	Passed
12195.360 <sup>1</sup>	50.01	30.01	11.31	61.32	41.32	54	-12.68	V	100	230	Passed
14634.432	45.54	25.54	17.71	63.25	43.25	54	-10.75	V	100	225	Passed
17073.504	45.83	25.83	23.72	69.55	49.55	54	-4.45	V	100	225	Passed
19512.576 <sup>1</sup>	47.03	27.03	8.39	55.42	35.42	54	-18.58	Noise Floor		Passed	
21951.648	49.37	29.37	8.69	58.06	38.06	54	-15.94	Noise Floor		Passed	
24390.720	52.14	32.14	9.58	61.72	41.72	54	-12.28	Noise Floor		Passed	

<sup>1</sup> Frequency falls within the Restricted Bands of Operation. See FCC Part 15, Section 15.205 for additional information.

#### 6.2.3 Upper Channel (2482.272 MHz)

Frequency (MHz)	Amplitude (dBµV)		Corr. Fact. (dB)	Amplitude (dBµV/m)		Average Limit	Margin (dB)	Ant Pol	Ant Ht	TT Pos	Result
	Peak	Avg		Peak	Avg						
4964.544 <sup>1</sup>	43.68	23.68	1.20	44.88	24.88	54	-29.12	V	100	270	Passed
7446.816 <sup>1</sup>	49.90	29.90	5.05	54.95	34.95	54	-19.05	V	100	225	Passed
9929.088	48.86	28.86	8.22	57.08	37.08	54	-16.92	V	100	230	Passed
12411.360 <sup>1</sup>	43.56	23.56	11.51	55.07	35.07	54	-18.93	V	100	225	Passed
14893.632	43.65	23.65	16.23	59.88	39.88	54	-14.12	V	100	225	Passed
17375.904	40.03	20.03	26.81	66.84	46.84	54	-7.16	V	100	5	Passed
19858.176 <sup>1</sup>	48.66	28.66	7.57	56.23	36.23	54	-17.77	Noise Floor		Passed	
22340.448	48.94	28.94	10.05	58.99	38.99	54	-15.01	Noise Floor		Passed	
24822.720	53.24	33.24	10.77	64.01	44.01	54	-9.99	Noise Floor		Passed	

<sup>1</sup> Frequency falls within the Restricted Bands of Operation. See FCC Part 15, Section 15.205 for additional information.

**6 Measurement Data (continued)**

**6.3 Spurious Radiated Emissions, 30 MHz to 1 GHz (15.249, Section (d)), IC RSS-GEN**

Requirement: Emissions radiated outside of the specified frequency bands, except for harmonics, shall be attenuated by at least 50 dB below the level of the fundamental or to the general radiated emission limits in Section 15.209, whichever is the lesser attenuation.

**6.3.1 Spurious Radiated Emissions, 30 MHz to 1 GHz Test Setup**

6.3.1.1. Regulatory Limit: FCC Part 209, Quasi-Peak

Frequency Range (MHz)	Distance (Meters)	Limit (dBµV/m)
30 to 88	3	40.0
88 to 216	3	43.5
216 to 960	3	46.0
960 to 1000	3	54.0

6.3.1.2 Measurement Equipment Used to Perform Test

Device	Manufacturer	Model No.	Serial No.	Cal Due
EMI Receiver	Hewlett Packard	8546A	3650A00360	1/5/2007
Biconilog Antenna	Com-Power	AC220	25509	1/31/2007

6.3.1.3 Measurement & Equipment Setup

Test Date: 07/14/2006  
 Test Engineer: Michael Desmarais  
 Site Temperature (°C): 21.3  
 Relative Humidity (%RH): 31  
 Frequency Range: 30 MHz to 1 GHz  
 Measurement Distance: 3 Meters  
 EMI Receiver IF Bandwidth: 120 kHz  
 EMI Receiver Avg Bandwidth: 300 kHz  
 Detector Functions: Peak and Quasi-Peak.  
 Antenna Height: 1 to 4 meters

6.3.1.4 Test Procedure

Test measurements were made in accordance with ANSI C63.4-2003, Standard Methods of Measurement of Radio Noise Emissions from Low-Voltage Electrical and Electronics Equipment in the Range of 9 kHz to 40 GHz. As part of the prescreen process for hand-held or body-worn devices, outlined in Section 13.1.4.1 c, the DUT was rotated through three orthogonal axes to determine which attitude and equipment arrangement produced the highest emission relative to the limit.

6.3 Spurious Radiated Emissions, 30 MHz to 1 GHz (15.249, Section (d)) (continued))

6.3.2 Spurious Radiated Emissions (30 MHz to 1 GHz) Test Data

6.3.2.1 Horizontal Polarity

Test No.: 217-06, Radiated Emissions - Horizontal Polarity

FCC, Class B

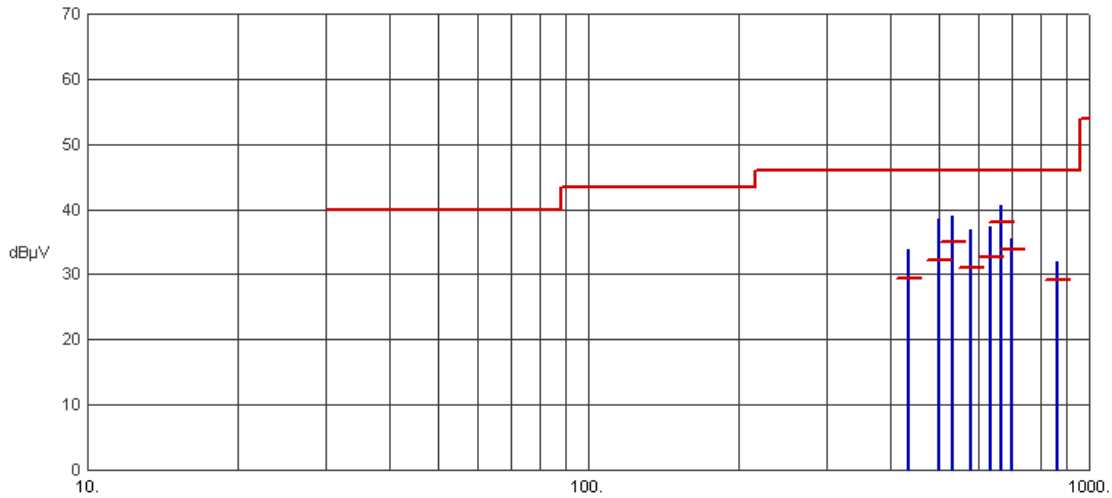

Frequency (MHz)	Pk Amp (dBµV/m)	QP Amp (dBµV/m)	QP Limit (dBµV/m)	Margin (dB)	Ant Ht (cm)	Table (Deg)	Comments
435.4676	33.86	29.36	46.00	-16.64	100	98	
500.1212	38.54	32.17	46.00	-13.83	100	70	
533.3300	39.04	34.93	46.00	-11.07	100	64	
580.6107	36.92	30.98	46.00	-15.02	172	300	
633.3225	37.44	32.67	46.00	-13.33	130	90	
666.6584	40.66	37.92	46.00	-8.08	136	220	
699.9874	35.45	33.89	46.00	-12.11	126	108	
866.6306	32.06	29.26	46.00	-16.74	100	354	

Result: Passed

6.3 Spurious Radiated Emissions, 30 MHz to 1 GHz (15.249, Section (d)) (continued)

6.3.2 Spurious Radiated Emissions (30 MHz to 1 GHz) Test Data (continued)

6.3.2.2 Vertical Polarity

Test No.: 217-06, Radiated Emissions - Vertical Polarity

FCC, Class B

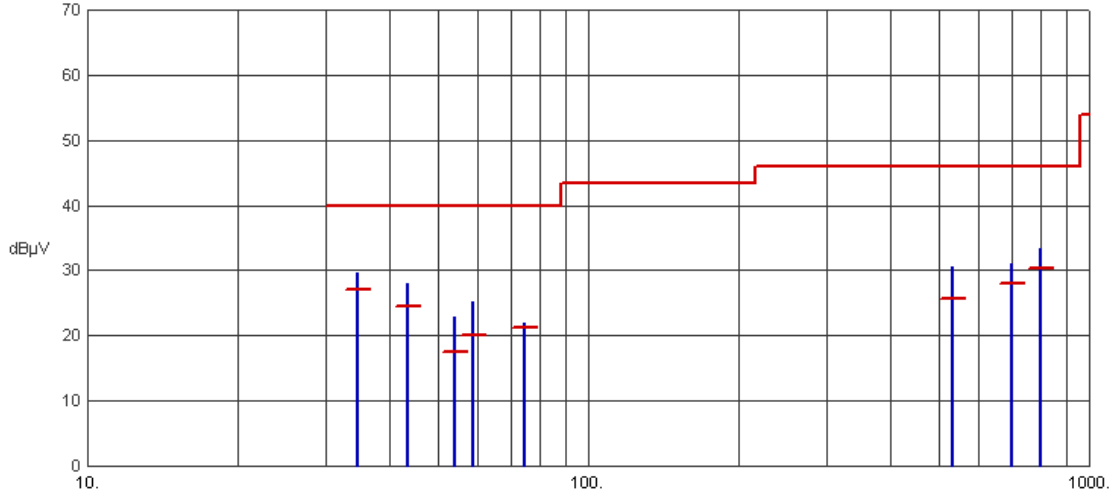

Frequency (MHz)	Pk Amp (dBµV/m)	QP Amp (dBµV/m)	QP Limit (dBµV/m)	Margin (dB)	Ant Ht (cm)	Table (Deg)	Comments
34.6529	29.52	27.18	40.00	-12.82	100	4	
43.4922	27.93	24.57	40.00	-15.43	100	354	
53.9338	22.88	17.52	40.00	-22.48	100	4	
58.7186	25.26	20.14	40.00	-19.86	100	354	
74.5616	22.01	21.17	40.00	-18.83	100	4	
533.3139	30.51	25.64	46.00	-20.36	100	354	
699.9824	30.98	27.89	46.00	-18.11	100	54	
799.9887	33.26	30.22	46.00	-15.78	100	40	

Result: Passed

6.4 Spurious Radiated Emissions >1 GHz (15.249, Section (d))

There were no measurable spurious emissions above 1 GHz.

### 6.5 Band Edge Measurements

Requirement: In any 100 kHz bandwidth outside the frequency band in which the spread spectrum or digitally modulated intentional radiator is operating, the radio frequency power that is produced by the intentional radiator shall be at least 20 dB below that in the 100 kHz bandwidth within the band that contains the highest level of the desired power, based on either an RF conducted or a radiated measurement, provided the transmitter demonstrates compliance with the peak conducted power limits. If the transmitter complies with the conducted power limits based on the use of RMS averaging over a time interval, as permitted under paragraph (b)(3) of this section, the attenuation required under this paragraph shall be 30 dB instead of 20 dB. Attenuation below the general limits specified in Section 15.209(a) is not required. In addition, radiated emissions which fall in the restricted bands, as defined in Section 15.205(a), must also comply with the radiated emission limits specified in Section 15.209(a) (see Section 15.205(c)).

#### 6.5.1 Measurement Results – Lower Band Edge

Lowest Channel (MHz)	Field Strength (dBµV/m)		Band Edge Frequency (MHz)	Field Strength (dBµV/m)		Margin (dB)		Result
	Peak	Average		Peak	Average	Peak	Avg	
2401.056	111.84	65.64	2400.0	81.87	39.35	>20 dB	>20 dB	Compliant

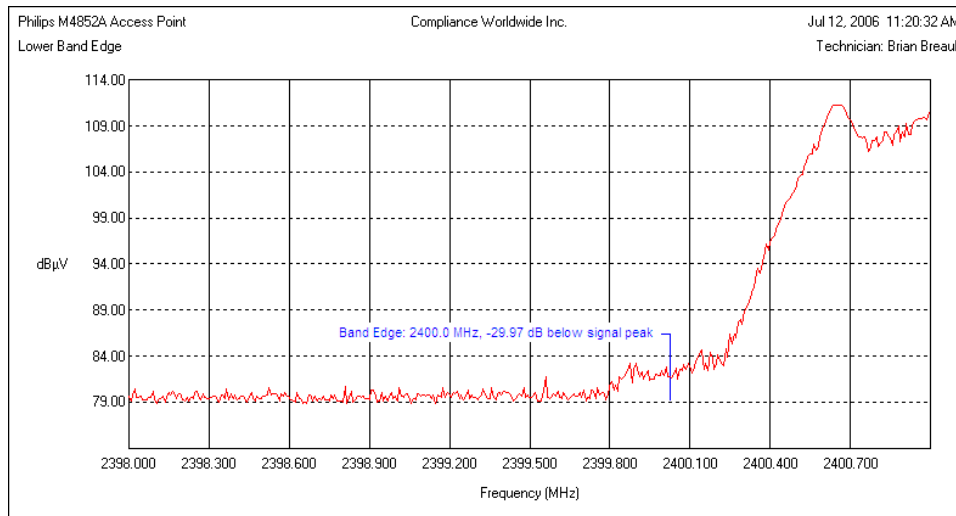



6.5 Band Edge Measurements (continued)

6.5.2 Measurement Results – Upper Band Edge

Highest Channel (MHz)	Field Strength (dBµV/m)		Band Edge Frequency (MHz)	Field Strength (dBµV/m)		Limit (dBµV/m)	Margin	Result
	Peak	Average		Peak	Average			
2482.272	109.77	65.11	2483.5	81.28	37.87	54.0	-16.13	Compliant

6.5.3 Worst case measurement – First bandwidth (2483.5 – 2484.5 MHz)

Frequency (MHz)	Field Strength (dBµV/m)		Limit (dBµV/m)	Margin	Result
	Peak	Average			
2483.978	82.23	43.12	54.0	-10.88	Compliant

6.5.4 Worst case measurement – Second bandwidth (2484.5 – 2485.5 MHz)

Frequency (MHz)	Field Strength (dBµV/m)		Limit (dBµV/m)	Margin	Result
	Peak	Average			
2484.735	82.16	43.55	54.0	-10.45	Compliant

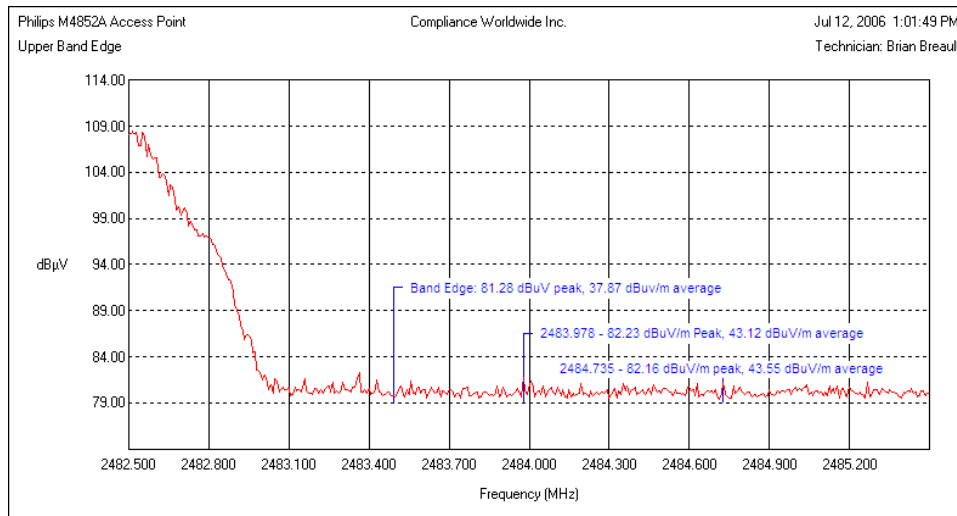

6.6 99% Bandwidth Measurements

Channel	Frequency (MHz)	99% Bandwidth (MHz)
Low	2401.056	1.313
Middle	2439.072	1.250
High	2482.272	1.262

6.6.1 99% Bandwidth Measurements – Low Channel Plot

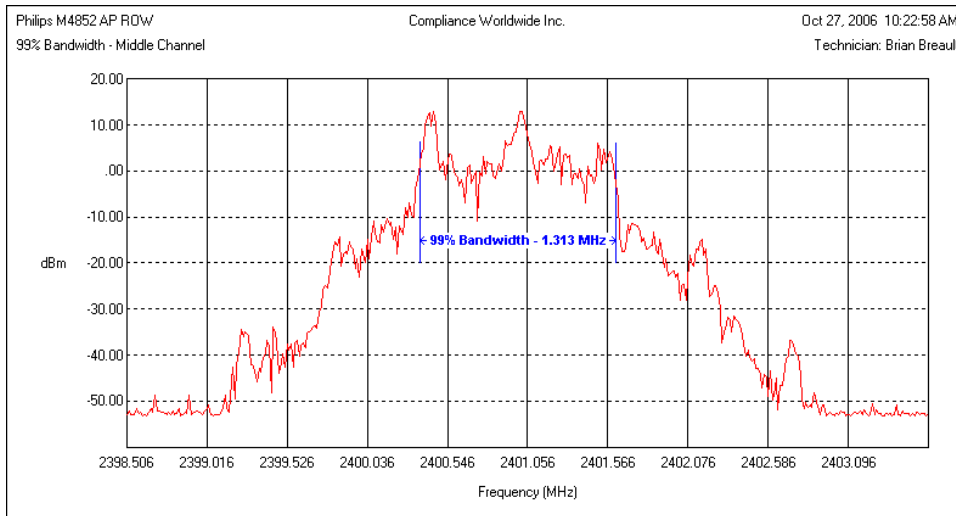

6.6.2 99% Bandwidth Measurements – Middle Channel Plot

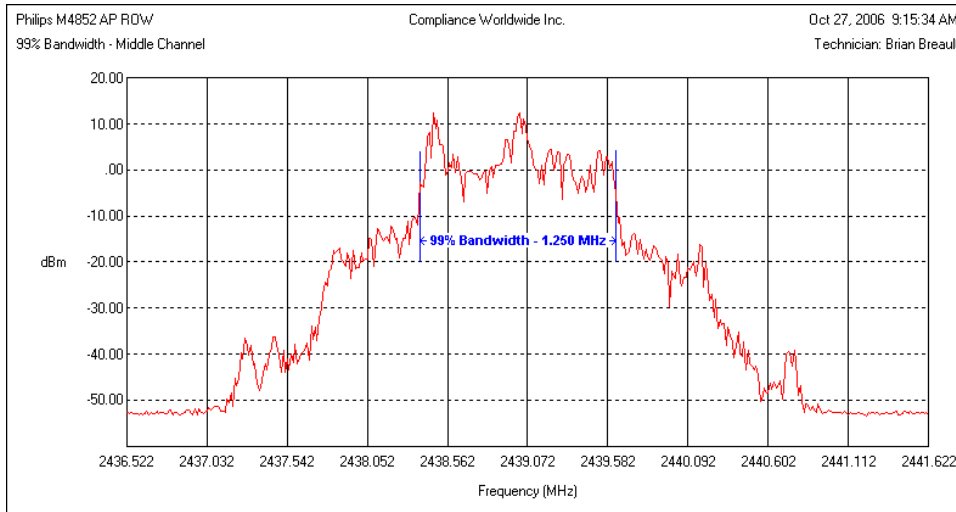

6.6 99% Bandwidth Measurements (continued)

6.6.3 99% Bandwidth Measurements – High Channel Plot

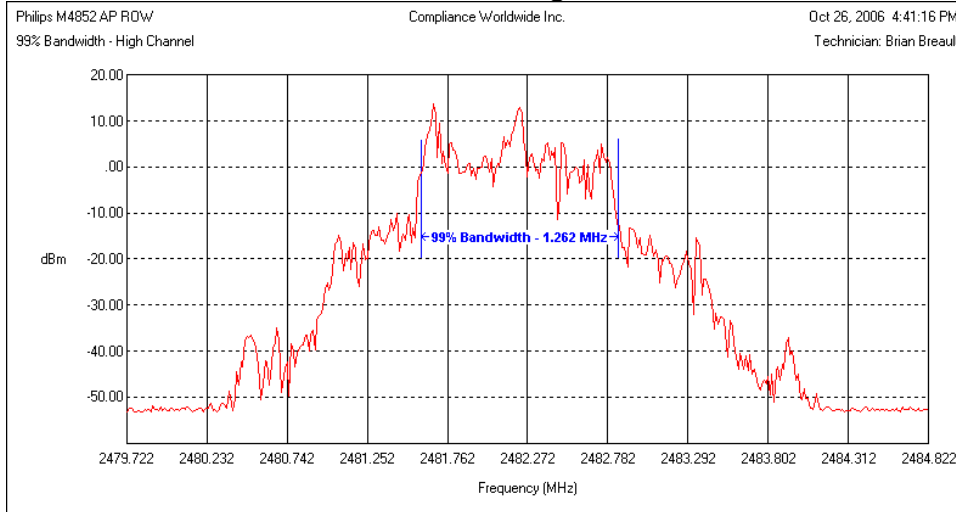

7 Test Site Description

Compliance Worldwide is located at 357 Main Street in Sandown, New Hampshire. The test sites at Compliance Worldwide are used for conducted and radiated emissions testing in accordance with Federal Communications Commission (FCC) and Industry Canada standards. A description of the test sites is on file with the FCC (registration number **96392**) and Industry Canada (file number **IC 3023**).

The radiated emissions test site is a 3 and 10 meter enclosed open area test site (OATS). Personnel, support equipment and test equipment are located in the basement beneath the OATS ground plane.

The conducted emissions site is part of a 16' x 20' x 12' ferrite tile chamber and uses one of the walls for the vertical ground plane required by EN 55022.

Both sites are designed to test products or systems 1.5 meter W x 1.5 meter L x 2.0 meter H, floor standing or table top.

Test Number: 217-06R1

Issue Date: 10/25/2006

## 8 Test Setup Photographs

Radiated Emissions Front:

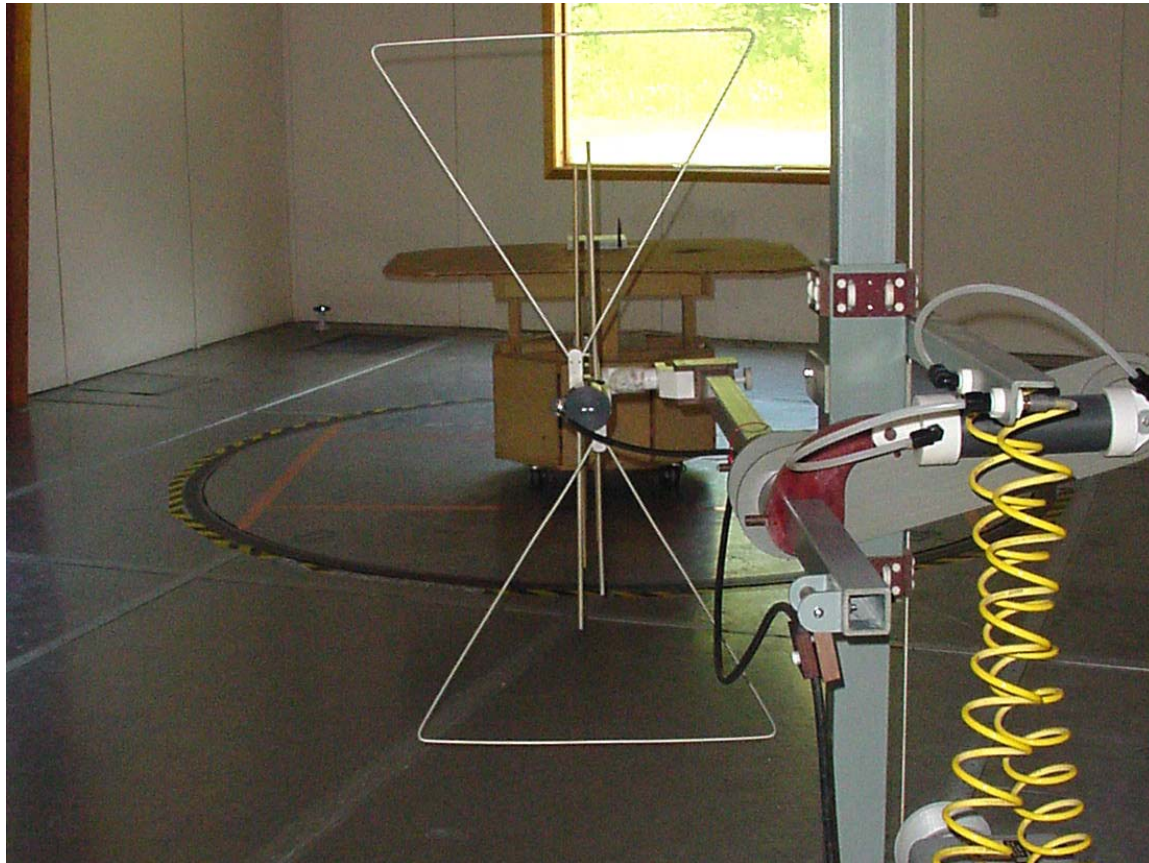

**Test Number: 217-06R1**

**Issue Date: 10/25/2006**

**8 Test Setup Photographs**

Radiated Emissions Back:

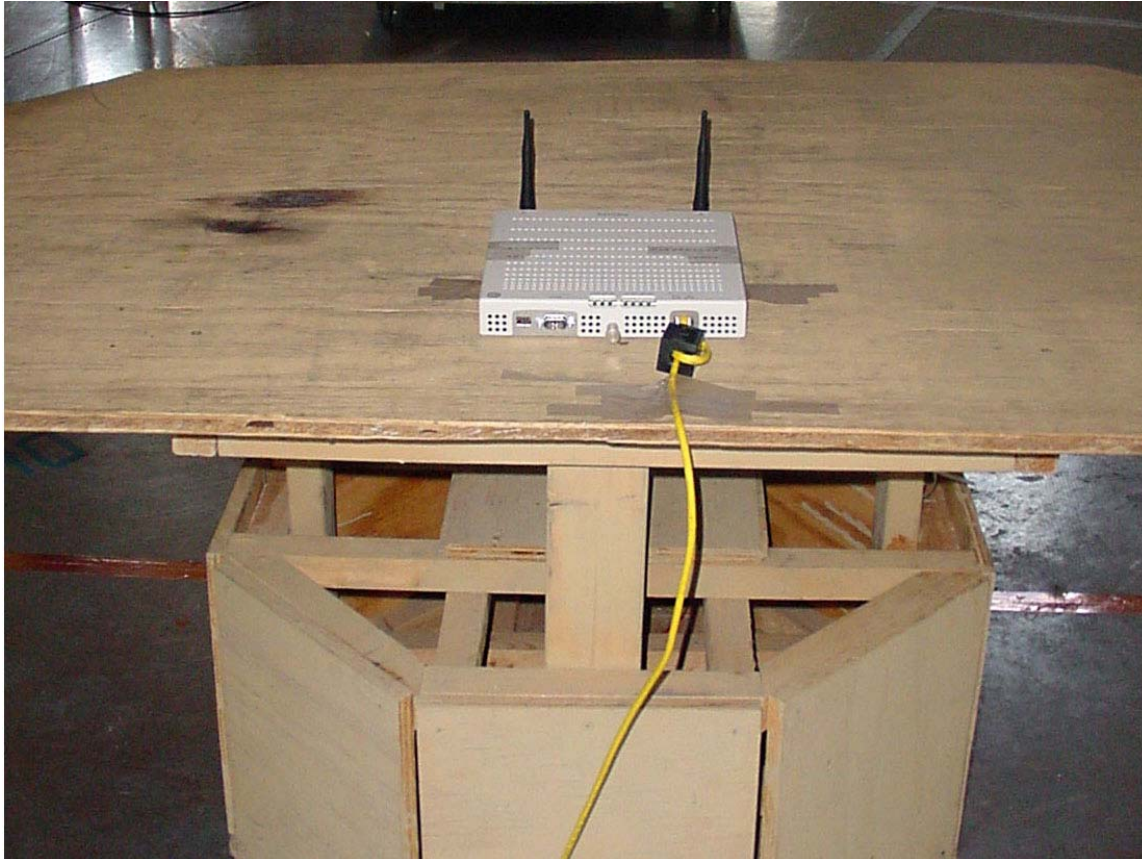



Test Number: 217-06R1

Issue Date: 10/25/2006

## 8 Test Setup Photographs

Conducted Emissions Front:



Test Number: 217-06R1

Issue Date: 10/25/2006

## 8 Test Setup Photographs

Conducted Emissions Back:

