

**COMPLIANCE WORLDWIDE INC.
TEST REPORT 257-06R1**

In Accordance with the Requirements of
**FCC PART 15, SUBPART C
INDUSTRY CANADA RSS 210, ISSUE 6**

Low Power License-Exempt Radio Communication Devices
Intentional Radiators

Issued to

**Philips Medical Systems
3000 Minuteman Drive
Andover, MA 01810
978-659-2800**

for

TRx4851A = M4851A Telemetry II Patient Worn Device / ROW

Report Issued on October 25, 2006

Tested by



Brian F. Breault

Reviewed by



Larry K. Stillings

This test report shall not be reproduced, except in full, without written permission from Compliance Worldwide, Inc.

Table of Contents

1 Scope.....	3
2 Product Details	3
2.1 Manufacturer.....	3
2.3 Serial Number.....	3
2.4 Description	3
2.5 Power Source	3
2.6 EMC Modifications.....	3
3 Product Configuration.....	3
3.1 Operational Characteristics & Software	3
3.2 Support Equipment.....	4
3.3 Additional Support Equipment (Directly connected to the DUT)	4
3.4 Cables.....	4
3.5 Block Diagram	5
4 Measurements Parameters	6
4.1 Measurement Equipment Used to Perform Test.....	6
4.2 Measurement & Equipment Setup	6
4.3 Test Procedure	6
5 Measurement Summary	7
6 Measurement Data	8
6.1 Radiated Field Strength of Fundamental.....	8
6.2 Radiated Field Strength of Harmonics	8
6.3 Spurious Radiated Emissions.....	10
6.4 Spurious Radiated Emissions >1 GHz	12
6.5 Band Edge Measurements.....	13
6.6 99% Occupied Bandwidth.....	15
7 Test Site Description	16
8 Test Setup Photos	17

1 Scope

This test report certifies that the Philips Trx4851A = M4851A Telemetry II Patient Worn Device (PWD)/ROW with Integral Antenna, as tested, meets the FCC Part 15, Subpart C and Industry Canada RSS 210, Issue 6 requirements. The scope of this test report is limited to the test sample provided by the client, only in as much as that sample represents other production units. If any significant changes are made to the unit, the changes shall be evaluated and a retest may be required. This report replaces test report #257-06.

2 Product Details

2.1 Manufacturer: Philips Medical Systems

2.2 Model Number: TRx4851A = M4851A Telemetry II Patient Worn Device/ ROW PP2

2.3 Serial Number: US42300566

2.4 Description: The TRx4851A = M4851A PWD is leveraged from the existing M4841A CTS PWD with a 2.4 GHz radio module and can operate in a Frequency hopping mode or a non-Frequency hopping mode. All other components are the same as the M4841A. The M4851A PWD will communicate with the Network Infrastructure via an M4852A 2.4 GHz ROW Access Point. Patient data is displayed on the IntelliVue Information Center. The M4851A is a transmitter with no local display or other indicators for monitoring. The only functions on the transmitter available to the user are the battery indicator LEDs, leads-off indicator LEDs, the Multi-use/Nursecall button, and the "Check" button. The performance of the M4851A transmitter will be verified by monitoring the IntelliVue Information Center.

The antenna built into the M4851A PWD meets the requirements outlined in Section 15.203 of the FCC regulations.

2.5 Power Source: DC 3 volts – 2 internal AA alkaline batteries, no external charger

2.6 EMC Modifications: None

3 Product Configuration

3.1 Operational Characteristics & Software

3.3.1 From APC Web interface,

- a) Go to 'WMTS AP Configuration' screen,
- b) Select 'ISM AREA' pull down menu to select area below:
 - 1) Europe
 - 2) Europe (non-hopping)
 - 3) North America
 - 4) North America (non-hopping)
 - 5) Select save after highlighting the desired mode

3.3.2 Use the IntelliVue Information Center to monitor the proper operation of the PWD.

3 Product Configuration (continued)

3.2 Support Equipment

Blk #	Mfgr	Model / Part #	Opt	HW Rev.	FW Rev.	SW Rev.	Serial # (if available)	Nom. Voltage	Description
2	Philips	M1191ANL	N/A	N/A	N/A	N/A	N/A	N/A	SpO2 transducer
3	DNI Nevada	Oxitest 7	N/A	N/A	N/A	N/A	DOS03040647	9 VDC	SpO2 simulator Recall #125346
4	Bio-Tek	Lionheart 2	N/A	N/A	N/A	N/A	203926	9 VDC	Multi-parameter patient simulator Recall #125005
5	Philips	M4852A RB-11	N/A	LP1	B.00.03	N/A	SB-4503530893	48 VDC	2.4 GHz ROW Access Point w/ PP2 Radio
6	Philips	M4844A/453563495101	ABA	Prd	N/A	N/A	US34300035	120 VAC	Synchronization Box
7	Power-D-Sine	PD-6006AC	N/A	NA	NA	NA	M03056809512000	120 VAC	Power Over Ethernet Hub 6 Port
8	Cisco	WS-C2950G-24	N/A	NA	NA	NA	F030732Z1WX	120 VAC	24 Port 10/100 Ethernet Switch
9	Philips	M3171A/453564009481	N/A	NA	NA	NA	US50100106	120 VAC	Access Point Controller
10	HP	EVO	N/A	NA	NA	G.	USU32301H2	120 VAC	IntelliVue Information Center- HP PC
11	HP	D2807A/D2807-60011	N/A	N/A	N/A	N/A	JP50101212	120 VAC	Display for IntelliVue Information Center
12	Triplite	Smart Pro	N/A	N/A	N/A	N/A	9336ALCSM513901271	120 VAC	Uninterruptible Power Supply

3.3 Additional Support Equipment (Directly connected to the DUT)

Blk #	Manufacturer	Model/Part Number	Serial Number	Nom. Voltage	Description
3	Bio-Tek	Lionheart2	204214	9 VDC	Multi-parameter patient simulator

3.4 Cables

Blk Item	Part #	Shielded Y or N	Length	No. of Conductors (if avail.)	Port Tested (Y/N)	Termination	Function / Description
A	N/A	N	10 m	8	N	N/A	Category 5 UTP cable, various lengths
B	392 925	N	1 m	6	N	N/A	ECG leadset
C	N/A	N	2 m	3	N	N/A	AC power cords
D	M1941A	N	2 m	2	N	N/A	SpO2 extension cable

3 Product Configuration (continued)

3.5 Block Diagram

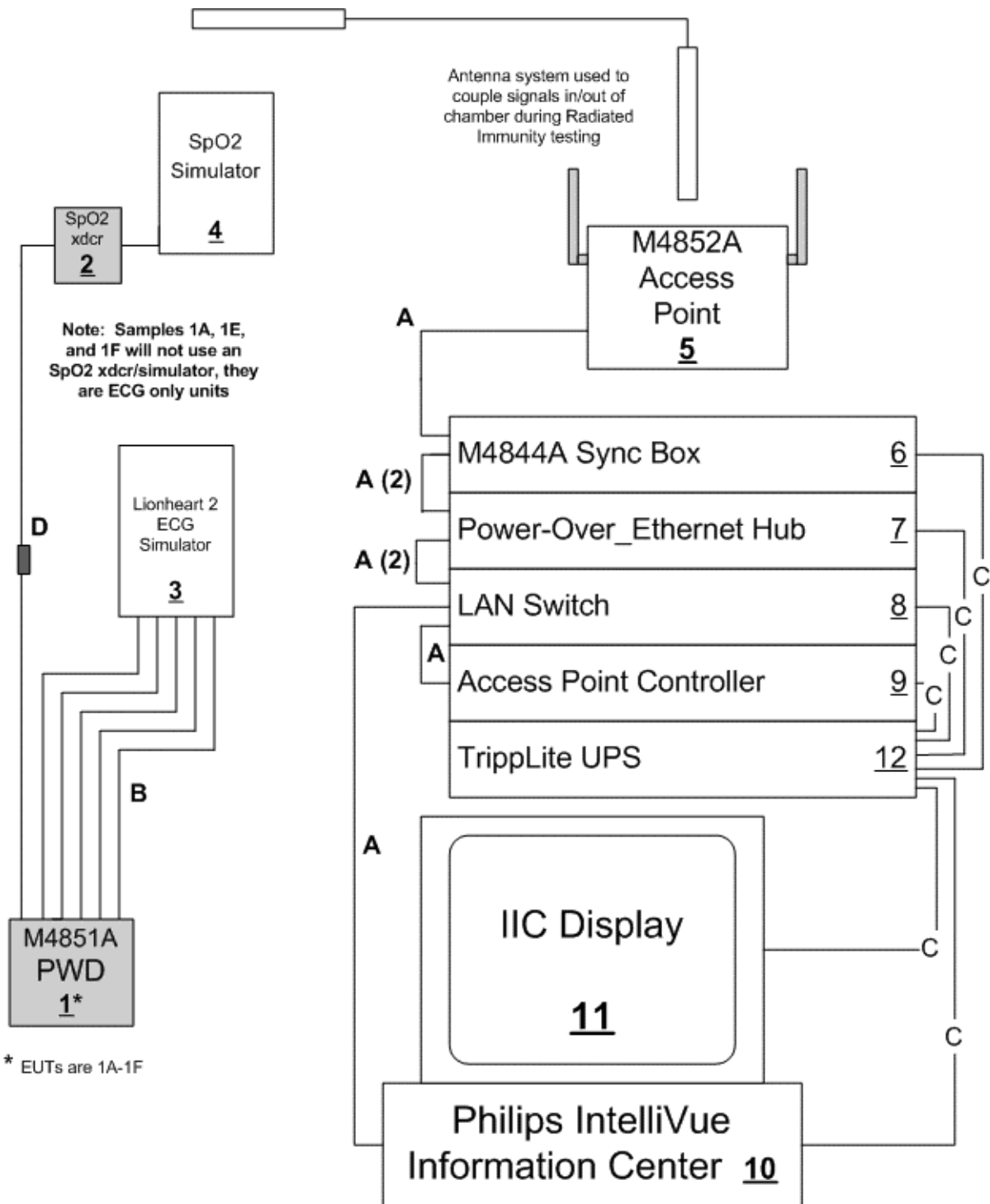

4 Measurements Parameters

4.1 Measurement Equipment Used to Perform Test

Device	Manufacturer	Model No.	Serial No.	Last Cal	Cal Due
EMI Receiver	Hewlett Packard	8546A	3650A00360	1/5/2005	1/5/2007
Spectrum Analyzer	Hewlett Packard	8593E	3829A03887	3/13/2006	3/13/2007
Microwave Preamp	Hewlett Packard	8449B	3008A01323	9/21/2006	9/21/2008
Bilog Antenna	Com-Power	AC-220	25509	1/31/2006	1/31/2007
Horn Antenna	Electro-Metrics	EM-6961	6337	8/25/2006	8/25/2008
2.4 GHz BP Filter	Micro-Tronics	BRM50702	14	11/2/2004	11/2/2006

4.2 Measurement & Equipment Setup

Test Date:	September 15 th , 2006
Test Engineer:	Brian Breault
Normal Site Temperature (15 - 35°C):	24.0
Extreme Test Temperatures (°C):	0 and +35
Relative Humidity (20 -75%RH):	33%
Frequency Range:	2.4000 GHz to 2.4835 GHz
Measurement Distance:	3 Meters
EMI Receiver IF Bandwidth:	Depends on measurement
EMI Receiver Avg Bandwidth:	Depends on measurement
Detector Function:	Depends on measurement

4.3 Test Procedure

Test measurements were made in accordance FCC Part 15.249, IC RSS-210 Annex II: Operation within the bands 902 - 928 MHz, 2400 - 2483.5 MHz, 5725 - 5875 MHz, and 24.0 - 24.25 GHz.

The test methods used to generate the data in this test report is in accordance with ANSI C63.4: 2003, American National Standard for Methods of Measurement of Radio-Noise Emissions from Low-Voltage Electrical and Electronic Equipment in the Range of 9 kHz to 40 GHz

5 Measurement Summary

Test Requirement	FCC Part 15 Reference	Test Report Section	Result	Comment
Antenna Requirement	15.203	N.A	Compliant	The Unit uses an integral pcb mount antenna
Conducted Emissions	15.207	N.A	Compliant	Unit is battery operated and does not have a charger
Radiated Field Strength of Fundamental	15.249 (a)	6.1	Compliant	
Radiated Field Strength of Harmonics	15.249 (a)	6.2	Compliant	
Spurious Radiated Emissions	15.249 (d)	6.3 6.4	Compliant	
Band Edge Measurements	--	6.5	Compliant	
Bandwidth 99% Power	IC RSS-GEN	6.6	Compliant	

6. Measurement Data

6.1 Radiated Field Strength of Fundamental (15.249, Section (a)), IC RSS-210 A2.9

Requirement: The 3 meter field strength of the fundamental emissions from intentional radiators operated within the 2400-2483.5 MHz frequency bands shall comply with the following requirement: 50 millivolts/meter (94 dBµV/m), average mode measurement.

Note: The peak field strength of any emission shall not exceed the maximum permitted average limits specified by more than 20 dB under any condition of modulation.

Channel	Frequency (MHz)	Amplitude (dBµV)		Corr Fact (dB)	Amplitude (dBµV/m)		Average Limit	Margin (dB)	Ant Pol	Ant Ht	TT Pos	Result
		Peak	Avg		Peak	Avg						
Low	2401.056	67.68	17.15	29.85	97.53	47.00	94	-47.00	V	100	358	Passed
Middle	2439.072	71.39	22.91	29.96	101.35	52.87	94	-41.12	V	100	358	Passed
High	2482.272	72.09	23.99	29.96	102.05	53.95	94	-40.05	V	100	220	Passed

6.2 Radiated Field Strength of Harmonics (15.249, Section (a)), IC RSS-210 A2.9

Requirement: The 3 meter field strength of the harmonic emissions from intentional radiators operated within the 2400-2483.5 MHz frequency bands shall comply with the following: 500 microvolts/meter (54 dBµV/m), average mode measurement

Note: The peak field strength of any emission shall not exceed the maximum permitted average limits specified by more than 20 dB under any condition of modulation.

6.2.1 Lower Channel (2401.056 MHz)

Frequency (MHz)	Amplitude (dBµV)		Corr. Fact. (dB)	Amplitude (dBµV/m)		Average Limit	Margin (dB)	Ant Pol	Ant Ht	TT Pos	Result
	Peak	Avg		Peak	Avg						
4802.112 ¹	43.72	23.72	0.64	44.36	24.36	54	-29.64	H	123	5	Passed
7203.168	44.76	24.76	4.33	49.09	29.09	54	-24.91	V	100	0	Passed
9604.224	49.01	29.01	7.58	56.59	36.59	54	-17.41	V	159	280	Passed
12005.280 ¹	44.78	24.78	11.05	55.83	35.83	54	-18.17	V	118	0	Passed
14406.336	45.54	25.54	18.18	63.72	43.72	54	-10.28	H	100	0	Passed
16807.392	45.75	25.75	20.29	66.04	46.04	54	-7.96	V	100	0	Passed
19208.448 ¹	45.65	25.65	8.44	54.09	34.09	54	-19.91	Noise Floor			Passed
21609.504	48.19	28.19	8.59	56.78	36.78	54	-17.22	Noise Floor			Passed
24010.560	50.36	30.36	9.43	59.79	39.79	54	-14.21	Noise Floor			Passed

¹ Frequency falls within the Restricted Bands of Operation. See FCC Part 15, Section 15.205 for additional information.

6 Measurement Data (continued)

6.2 Radiated Field Strength of Harmonics (continued)

6.2.2 Middle Channel (2439.072 MHz)

Frequency (MHz)	Amplitude (dB μ V)		Corr. Fact. (dB)	Amplitude (dB μ V/m)		Average Limit	Margin (dB)	Ant Pol	Ant Ht	TT Pos	Result
	Peak	Avg		Peak	Avg						
4878.144 ¹	46.68	26.68	0.77	47.45	27.45	54	-26.55	V	100	0	Passed
7317.216 ¹	44.87	24.87	4.66	49.53	29.53	54	-24.47	V	100	0	Passed
9756.288	53.93	33.93	8.07	62.00	42.00	54	-12.00	H	100	275	Passed
12195.360 ¹	50.71	30.71	11.31	62.02	42.02	54	-11.98	H	164	278	Passed
14634.432	45.15	25.15	17.71	62.86	42.86	54	-11.14	V	100	275	Passed
17073.504	45.01	25.01	23.72	68.73	48.73	54	-5.27	H	135	275	Passed
19512.576 ¹	47.84	27.84	8.39	56.23	36.23	54	-17.77	Noise Floor			Passed
21951.648	48.71	28.71	8.69	57.40	37.40	54	-16.60	Noise Floor			Passed
24390.720	52.52	32.52	9.58	62.10	42.10	54	-11.90	Noise Floor			Passed

¹ Frequency falls within the Restricted Bands of Operation. See FCC Part 15, Section 15.205 for additional information.

6.2.3 Upper Channel (2482.272 MHz)

Frequency (MHz)	Amplitude (dB μ V)		Corr. Fact. (dB)	Amplitude (dB μ V/m)		Average Limit	Margin (dB)	Ant Pol	Ant Ht	TT Pos	Result
	Peak	Avg		Peak	Avg						
4964.544 ¹	42.92	22.92	1.20	44.12	24.12	54	-29.88	H	198	0	Passed
7446.816 ¹	45.99	25.99	5.05	51.04	31.04	54	-22.96	H	135	0	Passed
9929.088	58.92	38.92	8.22	67.14	47.14	54	-6.86	V	119	348	Passed
12411.360 ¹	48.02	28.02	11.51	59.53	39.53	54	-14.47	H	129	278	Passed
14893.632	45.67	25.67	16.23	61.90	41.90	54	-12.10	V	164	0	Passed
17375.904	46.01	26.01	26.81	72.82	52.82	54	-1.18	H	130	0	Passed
19858.176 ¹	48.01	28.01	7.57	55.58	35.58	54	-18.42	Noise Floor			Passed
22340.448	50.28	30.28	10.05	60.33	40.33	54	-13.67	Noise Floor			Passed
24822.720	53.03	33.03	10.77	63.80	43.80	54	-10.20	Noise Floor			Passed

¹ Frequency falls within the Restricted Bands of Operation. See FCC Part 15, Section 15.205 for additional information.

6. Measurement Data (continued)

6.3 Spurious Radiated Emissions, 30 MHz to 1 GHz (15.249, Section (d)), IC RSS-GEN

Requirement: Emissions radiated outside of the specified frequency bands, except for harmonics, shall be attenuated by at least 50 dB below the level of the fundamental or to the general radiated emission limits in Section 15.209, whichever is the lesser attenuation.

6.3.1 Spurious Radiated Emissions, 30 MHz to 1 GHz Test Setup

6.3.1.1. Regulatory Limit: FCC Part 209, Quasi-Peak

Frequency Range (MHz)	Distance (Meters)	Limit (dBµV/m)
30 to 88	3	40.0
88 to 216	3	43.5
216 to 960	3	46.0
960 to 1000	3	54.0

6.3.1.2 Measurement Equipment Used to Perform Test

Device	Manufacturer	Model No.	Serial No.	Cal Due
EMI Receiver	Hewlett Packard	8546A	3650A00360	1/5/2007
Biconilog Antenna	Com-Power	AC220	25509	1/31/2007

6.3.1.3 Measurement & Equipment Setup

Test Date: 08/15/2006
 Test Engineer: Brian Breault
 Site Temperature (°C): 21.3
 Relative Humidity (%RH): 31
 Frequency Range: 30 MHz to 1 GHz
 Measurement Distance: 3 Meters
 EMI Receiver IF Bandwidth: 120 kHz
 EMI Receiver Avg Bandwidth: 300 kHz
 Detector Functions: Peak and Quasi-Peak.
 Antenna Height: 1 to 4 meters

6.3.1.4 Test Procedure

Test measurements were made in accordance with ANSI C63.4-2003, Standard Methods of Measurement of Radio Noise Emissions from Low-Voltage Electrical and Electronics Equipment in the Range of 9 kHz to 40 GHz. As part of the prescreen process for hand-held or body-worn devices, outlined in Section 13.1.4.1 c, the DUT was rotated through three orthogonal axes to determine which attitude and equipment arrangement produced the highest emission relative to the limit.

6.3 Spurious Radiated Emissions, 30 MHz to 1 GHz (15.249, Section (d)) (continued))

6.3.2 Spurious Radiated Emissions (30 MHz to 1 GHz) Test Data

6.3.2.1 Horizontal Polarity

Test No.: , Radiated Emissions - Horizontal Polarity

FCC, Class B

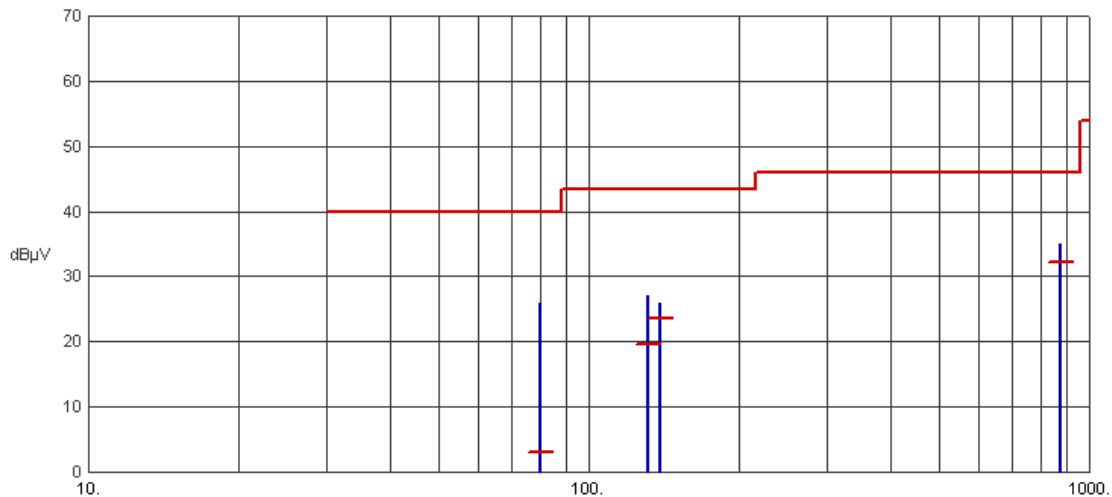

Frequency (MHz)	Pk Amp (dBµV/m)	QP Amp (dBµV/m)	QP Limit (dBµV/m)	Margin (dB)	Ant Ht (cm)	Table (Deg)	Comments
80.0349	25.94	2.97	40.00	-37.03	N/A	N/A	
131.0729	27.04	19.57	43.50	-23.93	N/A	N/A	
139.2631	25.93	23.60	43.50	-19.90	N/A	N/A	
874.9952	34.93	32.27	46.00	-13.73	N/A	N/A	

Result: Passed

6.3 Spurious Radiated Emissions, 30 MHz to 1 GHz (15.249, Section (d)) (continued))

6.3.2 Spurious Radiated Emissions (30 MHz to 1 GHz) Test Data (continued)

6.3.2.2 Vertical Polarity

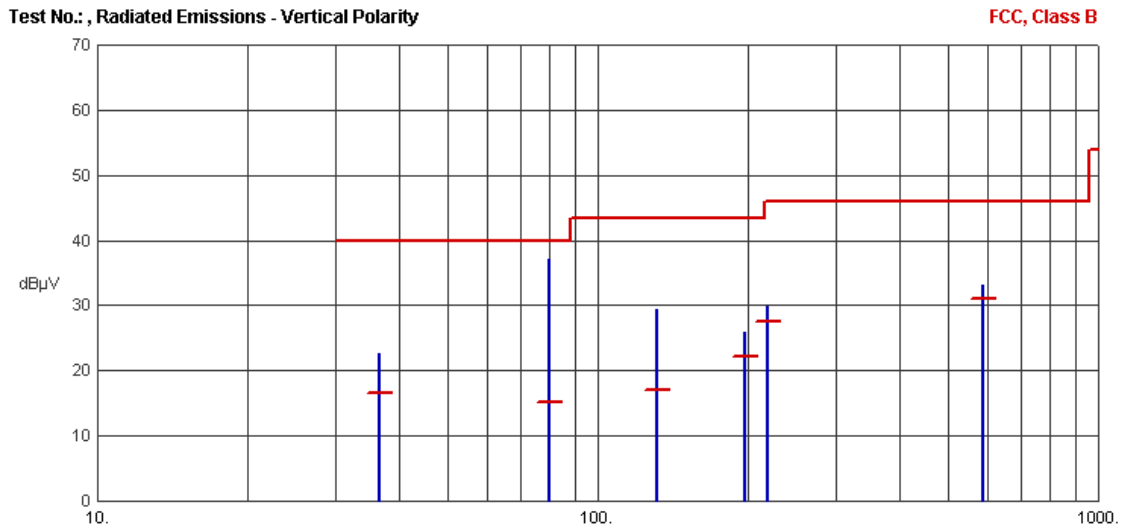

Frequency (MHz)	Pk Amp (dBµV/m)	QP Amp (dBµV/m)	QP Limit (dBµV/m)	Margin (dB)	Ant Ht (cm)	Table (Deg)	Comments
36.7473	22.59	16.67	40.00	-23.33	N/A	N/A	
80.0097	37.03	15.19	40.00	-24.81	N/A	N/A	
131.0718	29.37	17.03	43.50	-26.47	N/A	N/A	
196.9835	25.83	22.25	43.50	-21.25	N/A	N/A	
217.7366	29.91	27.49	46.00	-18.51	N/A	N/A	
589.8247	33.12	31.13	46.00	-14.87	N/A	N/A	

Result: Passed

6.4 Spurious Radiated Emissions >1 GHz (15.249, Section (d))

There were no measurable spurious emissions above 1 GHz.

6.5 Band Edge Measurements

Requirement: In any 100 kHz bandwidth outside the frequency band in which the spread spectrum or digitally modulated intentional radiator is operating, the radio frequency power that is produced by the intentional radiator shall be at least 20 dB below that in the 100 kHz bandwidth within the band that contains the highest level of the desired power, based on either an RF conducted or a radiated measurement, provided the transmitter demonstrates compliance with the peak conducted power limits. If the transmitter complies with the conducted power limits based on the use of RMS averaging over a time interval, as permitted under paragraph (b)(3) of this section, the attenuation required under this paragraph shall be 30 dB instead of 20 dB. Attenuation below the general limits specified in Section 15.209(a) is not required. In addition, radiated emissions which fall in the restricted bands, as defined in Section 15.205(a), must also comply with the radiated emission limits specified in Section 15.209(a) (see Section 15.205(c)).

6.5.1 Measurement Results – Lower Band Edge

Lowest Channel (MHz)	Field Strength (dBµV/m)		Band Edge Frequency (MHz)	Field Strength (dBµV/m)		Margin (dB)		Result
	Peak	Average		Peak	Average	Peak	Avg	
2401.056	97.53	50.70	2400.0	66.77	47.00	>20 dB	N/A	Compliant

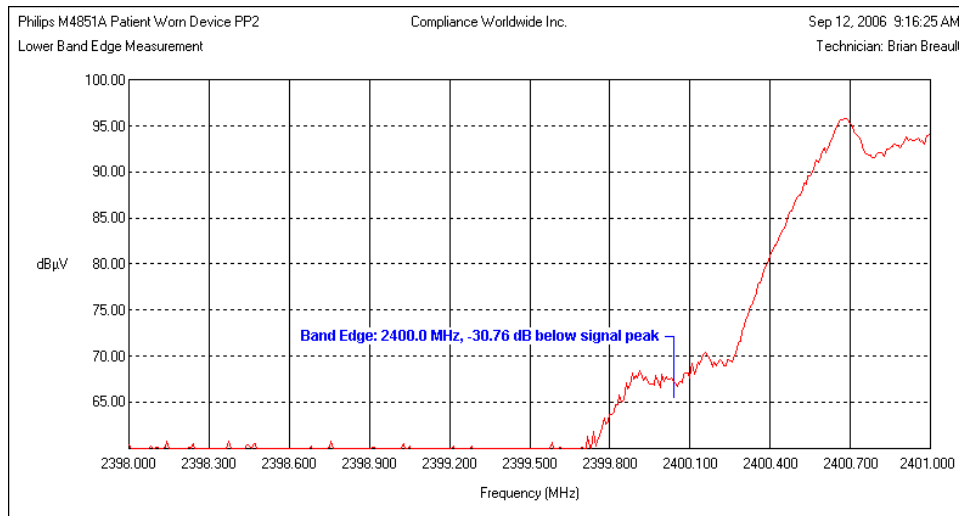

6.5 Band Edge Measurements (continued)

6.5.2 Measurement Results – Upper Band Edge

Highest Channel (MHz)	Field Strength (dB μ V/m)		Band Edge Frequency (MHz)	Field Strength (dB μ V/m)		Limit (dB μ V/m)	Margin	Result
	Peak	Average		Peak	Average			
2482.272	102.05	53.95	2483.5	65.16	34.59	54.0	-19.41	Compliant

6.5.3 Worst case measurement – First bandwidth (2483.5 – 2484.5 MHz)

Frequency (MHz)	Field Strength (dB μ V/m)		Limit (dB μ V/m)	Margin	Result
	Peak	Average			
2483.513	64.50	32.32	54.0	-21.68	Compliant

6.5.4 Worst case measurement – Second bandwidth (2484.5 – 2485.5 MHz)

Frequency (MHz)	Field Strength (dB μ V/m)		Limit (dB μ V/m)	Margin	Result
	Peak	Average			
2485.253	52.97	37.02	54.0	-16.98	Compliant

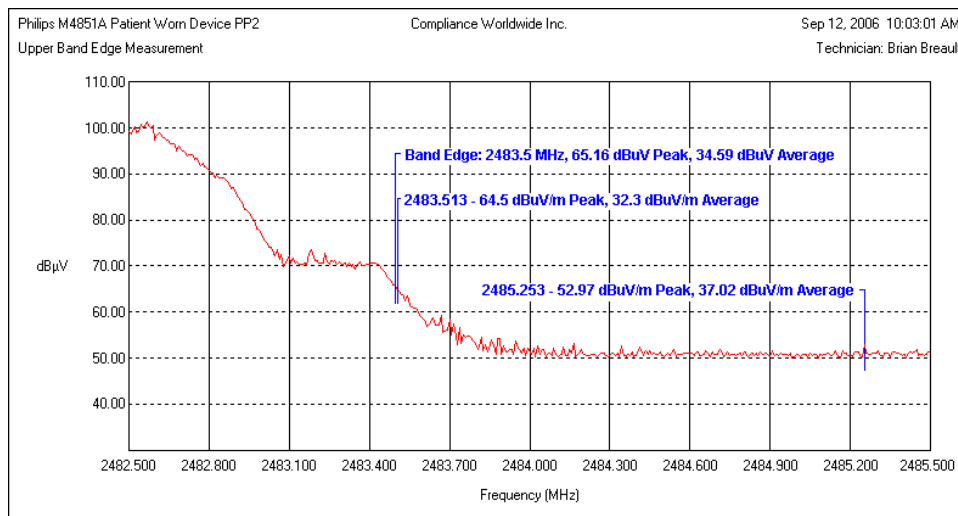

6.6 99% Bandwidth Measurements

Channel	Frequency (MHz)	99% Bandwidth (MHz)
Low	2401.056	1.250
Middle	2439.072	1.224
High	2482.272	1.160

6.6.1 99% Bandwidth Measurements – Low Channel Plot

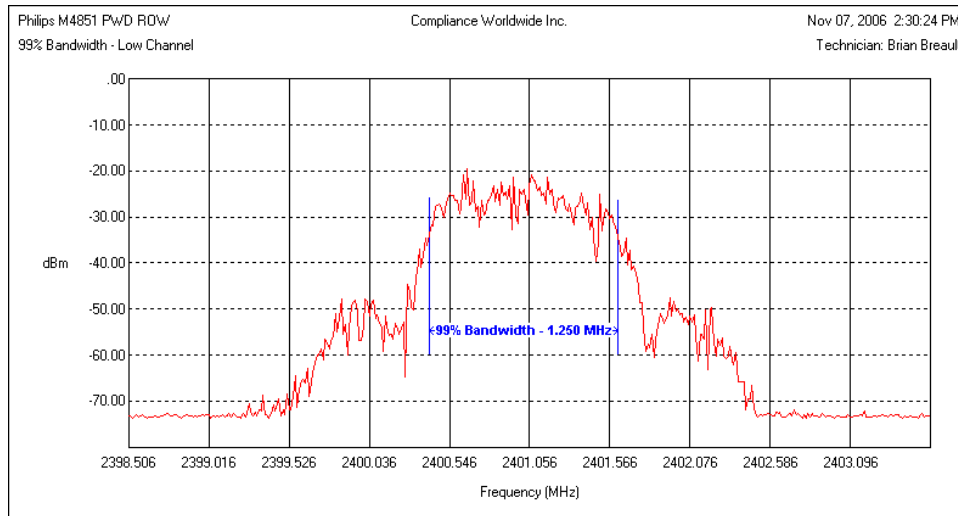

6.6.2 99% Bandwidth Measurements – Middle Channel Plot

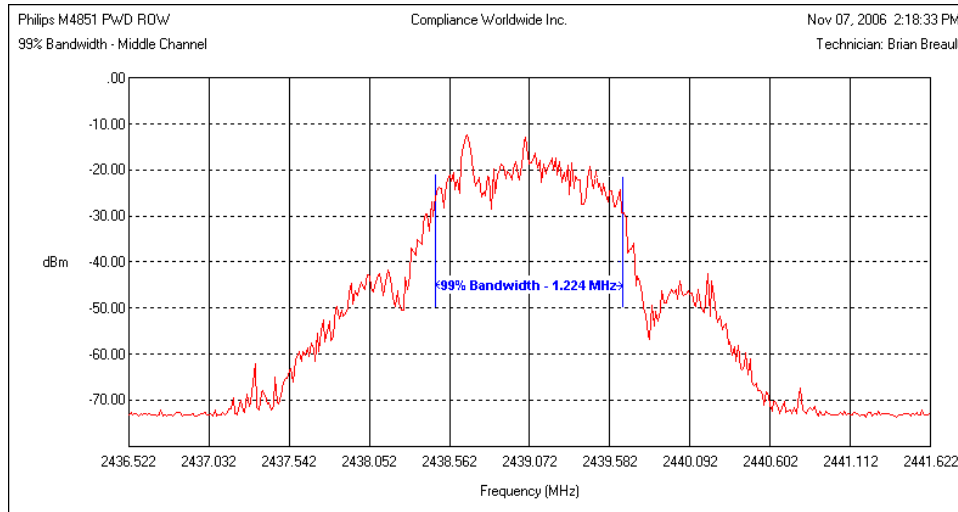

6.6 99% Bandwidth Measurements (continued)

6.6.3 99% Bandwidth Measurements – High Channel Plot

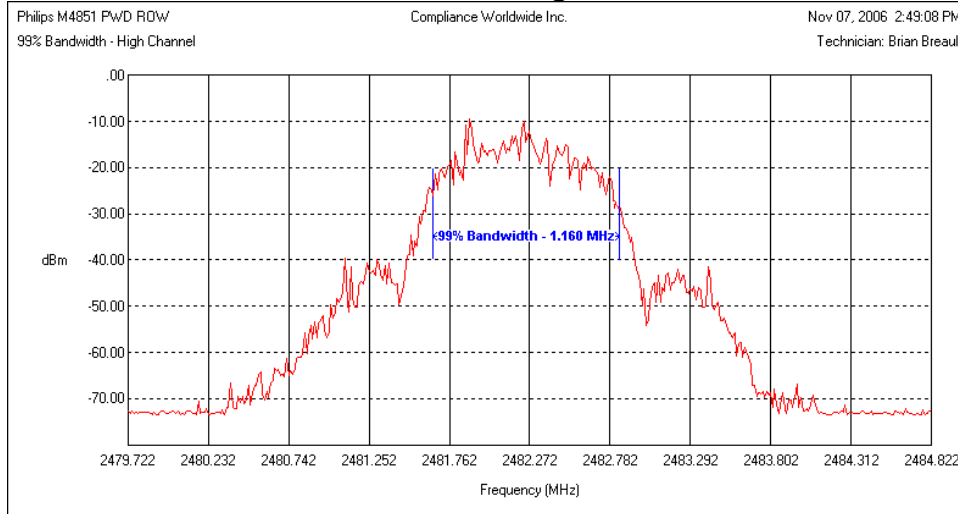

7. Test Site Description

Compliance Worldwide is located at 357 Main Street in Sandown, New Hampshire. The test sites at Compliance Worldwide are used for conducted and radiated emissions testing in accordance with Federal Communications Commission (FCC) and Industry Canada standards. A description of the test sites is on file with the FCC (registration number **96392**) and Industry Canada (file number **IC 3023**).

The radiated emissions test site is a 3 and 10 meter enclosed open area test site (OATS). Personnel, support equipment and test equipment are located in the basement beneath the OATS ground plane.

The conducted emissions site is part of a 16' x 20' x 12' ferrite tile chamber and uses one of the walls for the vertical ground plane required by EN 55022.

Both sites are designed to test products or systems 1.5 meter W x 1.5 meter L x 2.0 meter H, floor standing or table top.

8. Test Setup Photos

Radiated Emissions Front

8. Test Setup Photos (Continued)

Radiated Emissions Back