

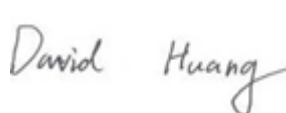

# RF TEST REPORT



Report No.: 17071350-FCC-R1

Supersede Report No.: N/A

Applicant	HONG KONG IPRO TECHNOLOGY CO.,LIMITED	
Product Name	Mobile Phone	
Model No.	Win	
Serial No.	N/A	
Test Standard	FCC Part 22(H):2016 ;FCC Part 24(E):2016; ANSI/TIA-603-D: 2010	
Test Date	December 05, 2017 to January 08, 2018	
Issue Date	January 09, 2018	
Test Result	<input checked="" type="checkbox"/> Pass <input type="checkbox"/> Fail	
Equipment complied with the specification	<input checked="" type="checkbox"/>	
Equipment did not comply with the specification	<input type="checkbox"/>	
		
Aaron Liang Test Engineer	David Huang Checked By	
<p>This test report may be reproduced in full only Test result presented in this test report is applicable to the tested sample only</p>		

Issued by:

**SIEMIC (SHENZHEN-CHINA) LABORATORIES**

Zone A, Floor 1, Building 2 Wan Ye Long Technology Park

South Side of Zhoushi Road, Bao' an District, Shenzhen, Guangdong China 518108

Phone: +86 0755 2601 4629801 Email: [China@siemic.com.cn](mailto:China@siemic.com.cn)

## Laboratories Introduction

SIEMIC, headquartered in the heart of Silicon Valley, with superior facilities in US and Asia, is one of the leading independent testing and certification facilities providing customers with one-stop shop services for Compliance Testing and Global Certifications.



In addition to testing and certification, SIEMIC provides initial design reviews and compliance management throughout a project. Our extensive experience with China, Asia Pacific, North America, European, and International compliance requirements, assures the fastest, most cost effective way to attain regulatory compliance for the global markets.

### Accreditations for Conformity Assessment

Country/Region	Scope
USA	EMC, RF/Wireless, SAR, Telecom
Canada	EMC, RF/Wireless, SAR, Telecom
Taiwan	EMC, RF, Telecom, SAR, Safety
Hong Kong	RF/Wireless, SAR, Telecom
Australia	EMC, RF, Telecom, SAR, Safety
Korea	EMI, EMS, RF, SAR, Telecom, Safety
Japan	EMI, RF/Wireless, SAR, Telecom
Singapore	EMC, RF, SAR, Telecom
Europe	EMC, RF, SAR, Telecom, Safety

Test Report	17071350-FCC-R1
Page	3 of 96

This page has been left blank intentionally.

# CONTENTS

SUPERSEDE REPORT NO.: N/A .....	1
ISSUED BY: .....	1
LABORATORIES INTRODUCTION .....	2
ACCREDITATIONS FOR CONFORMITY ASSESSMENT .....	2
THIS PAGE HAS BEEN LEFT BLANK INTENTIONALLY .....	3
CONTENTS .....	4
1. REPORT REVISION HISTORY.....	11
2. CUSTOMER INFORMATION .....	11
3. TEST SITE INFORMATION.....	11
4. EQUIPMENT UNDER TEST (EUT) INFORMATION .....	13
5. TEST SUMMARY .....	16
MEASUREMENT UNCERTAINTY .....	16
6. MEASUREMENTS, EXAMINATION AND DERIVED RESULTS .....	17
6.1 RF EXPOSURE (SAR) .....	17
TEST RESULT: PASS.....	17
6.2 RF OUTPUT POWER.....	18
REQUIREMENT(S):.....	18
CONDUCTED POWER .....	20
GSM MODE: .....	20
UMTS MODE: .....	22
UMTS-FDD BAND V .....	22
UMTS-FDD BAND II .....	23

ERP & EIRP .....	24
GSM VOICE .....	24
ERP FOR CELLULAR BAND (PART 22H) .....	24
EIRP FOR PCS BAND (PART 24E).....	24
GPRS: .....	25
ERP FOR CELLULAR BAND (PART 22H) .....	25
EIRP FOR PCS BAND (PART 24E).....	25
EGPRS (MCS1):.....	26
ERP FOR CELLULAR BAND (PART 22H) .....	26
EIRP FOR PCS BAND (PART 24E).....	26
RMC.....	27
ERP FOR UMTS-FDD BAND V (PART 22H) .....	27
EIRP FOR UMTS-FDD BAND II (PART 24E).....	27
HSDPA.....	28
ERP FOR UMTS-FDD BAND V (PART 22H) .....	28
EIRP FOR UMTS-FDD BAND II (PART 24E).....	28
HSUPA.....	29
ERP FOR UMTS-FDD BAND V (PART 22H) .....	29
EIRP FOR UMTS-FDD BAND II (PART 24E).....	29
6.3 PEAK-AVERAGE RATIO .....	30
GSM : GSM 1900 PK-AV POWER (PART 24E).....	32
GPRS 1900 PK-AV POWER (PART 24E).....	32
EGPRS (MSC1) 1900 PK-AV POWER (PART 24E) .....	32
RMC : UMTS-FDD BAND 2 PK-AV POWER (PART 24E).....	32

<b>HSDPA : UMTS-FDD BAND 2 PK-AV POWER (PART 24E)</b> .....	<b>32</b>
<b>HSUPA : UMTS-FDD BAND 2 PK-AV POWER (PART 24E)</b> .....	<b>33</b>
<b>6.4 OCCUPIED BANDWIDTH</b> .....	<b>34</b>
<b>REQUIREMENT(S):</b> .....	<b>34</b>
<b>GSM VOICE:</b> .....	<b>35</b>
<b>CELLULAR BAND (PART 22H) RESULT</b> .....	<b>35</b>
<b>GPRS:</b> .....	<b>35</b>
<b>CELLULAR BAND (PART 22H) RESULT</b> .....	<b>35</b>
<b>EGPRS (MSC 1):</b> .....	<b>36</b>
<b>CELLULAR BAND (PART 22H) RESULT</b> .....	<b>36</b>
<b>RMC:</b> .....	<b>37</b>
<b>UMTS-FDD BAND V (PART 22H)</b> .....	<b>37</b>
<b>HSDPA:</b> .....	<b>37</b>
<b>UMTS-FDD BAND V (PART 22H)</b> .....	<b>37</b>
<b>HSUPA:</b> .....	<b>38</b>
<b>UMTS-FDD BAND V (PART 22H)</b> .....	<b>38</b>
<b>TEST PLOTS</b> .....	<b>39</b>
<b>GSM VOICE:</b> .....	<b>39</b>
<b>GPRS:</b> .....	<b>40</b>
<b>EGPRS (MCS1):</b> .....	<b>41</b>
<b>RMC:</b> .....	<b>42</b>
<b>HSDPA:</b> .....	<b>43</b>
<b>HSUPA:</b> .....	<b>44</b>
<b>6.5 SPURIOUS EMISSIONS AT ANTENNA TERMINALS</b> .....	<b>45</b>

REQUIREMENT(S):.....	45
TEST PLOTS .....	46
GSM VOICE:.....	46
CELLULAR BAND (PART 22H) RESULT .....	46
PCS BAND (PART24E) RESULT .....	47
GPRS: .....	48
CELLULAR BAND (PART 22H) RESULT .....	48
PCS BAND (PART24E) RESULT .....	49
EGPRS (MSC 1):.....	50
CELLULAR BAND (PART 22H) RESULT .....	50
PCS BAND (PART24E) RESULT .....	51
RMC.....	52
UMTS-FDD BAND V (PART 22H).....	52
UMTS-FDD BAND II (PART 24E).....	53
HSDPA:.....	54
UMTS-FDD BAND V (PART 22H).....	54
UMTS-FDD BAND II (PART 24E).....	55
HSUPA:.....	56
UMTS-FDD BAND V (PART 22H).....	56
UMTS-FDD BAND II (PART 24E).....	57
6.6 SPURIOUS RADIATED EMISSIONS.....	58
CELLULAR BAND (PART 22H) RESULT .....	60
LOW CHANNEL.....	60
MIDDLE CHANNEL.....	60

HIGH CHANNEL.....	60
NOTE:.....	60
PCS BAND (PART24E) RESULT .....	61
LOW CHANNEL.....	61
MIDDLE CHANNEL.....	61
HIGH CHANNEL.....	61
UMTS-FDD BAND V (PART 22H).....	62
MIDDLE CHANNEL.....	62
HIGH CHANNEL.....	62
NOTE:.....	62
UMTS-FDD BAND II (PART 24E) .....	63
MIDDLE CHANNEL.....	63
HIGH CHANNEL.....	63
NOTE:.....	63
6.7 BAND EDGE .....	64
REQUIREMENT(S):.....	64
GSM VOICE: .....	65
CELLULAR BAND (PART 22H) RESULT .....	65
PCS BAND (PART24E) RESULT .....	65
GPRS: .....	65
CELLULAR BAND (PART 22H) RESULT .....	65
PCS BAND (PART24E) RESULT .....	65
EGPRS (MSC1):.....	66
CELLULAR BAND (PART 22H) RESULT .....	66



<b>PCS BAND (PART24E) RESULT .....</b>	<b>66</b>
<b>RMC:.....</b>	<b>66</b>
<b>UMTS-FDD BAND V (PART 22H).....</b>	<b>66</b>
<b>UMTS-FDD BAND II (PART 24E).....</b>	<b>66</b>
<b>HSDPA:.....</b>	<b>67</b>
<b>UMTS-FDD BAND V (PART 22H).....</b>	<b>67</b>
<b>UMTS-FDD BAND II (PART 24E).....</b>	<b>67</b>
<b>HSUPA:.....</b>	<b>67</b>
<b>UMTS-FDD BAND V (PART 22H).....</b>	<b>67</b>
<b>UMTS-FDD BAND II (PART 24E).....</b>	<b>67</b>
<b>GSM VOICE:.....</b>	<b>68</b>
<b>TEST PLOTS .....</b>	<b>68</b>
<b>GPRS:.....</b>	<b>69</b>
<b>TEST PLOTS .....</b>	<b>69</b>
<b>EGPRS:.....</b>	<b>70</b>
<b>TEST PLOTS .....</b>	<b>70</b>
<b>RMC:.....</b>	<b>71</b>
<b>HSDPA:.....</b>	<b>72</b>
<b>HSUPA:.....</b>	<b>73</b>
<b>6.8 FREQUENCY STABILITY.....</b>	<b>74</b>
<b>REQUIREMENT(S):.....</b>	<b>74</b>
<b>GSM VOICE:.....</b>	<b>76</b>
<b>CELLULAR BAND (PART 22H) RESULT .....</b>	<b>76</b>
<b>PCS BAND (PART 24E) RESULT .....</b>	<b>76</b>

RMC:.....	77
UMTS-FDD BAND V (PART 22H).....	77
UMTS-FDD BAND II (PART 24E).....	77
ANNEX A. TEST INSTRUMENT.....	78
ANNEX B. EUT AND TEST SETUP PHOTOGRAPHS.....	80
ANNEX B.I. PHOTOGRAPH: EUT EXTERNAL PHOTO .....	80
ANNEX C. TEST SETUP AND SUPPORTING EQUIPMENT.....	92
BLOCK CONFIGURATION DIAGRAM FOR RADIATED EMISSIONS .....	92
THE FOLLOWING IS A DESCRIPTION OF SUPPORTING EQUIPMENT AND DETAILS OF CABLES USED WITH THE EUT. ....	93
SUPPORTING EQUIPMENT:.....	93
SUPPORTING CABLE: .....	93
ANNEX C.II. EUT OPERATING CONKITIONS.....	94
N/A.....	94
ANNEX D. USER MANUAL / BLOCK DIAGRAM / SCHEMATICS / PARTLIST .....	95
PLEASE SEE THE ATTACHMENT.....	95
ANNEX E. DECLARATION OF SIMILARITY.....	96
N/A.....	96

## 1. Report Revision History

Report No.	Report Version	Description	Issue Date
17071350-FCC-R1	NONE	Original	January 09, 2018

## 2. Customer information

Applicant Name	HONG KONG IPRO TECHNOLOGY CO.,LIMITED
Applicant Add	FLAT/RM A3, 9/F SILVERCORP INT TOWER 707-713 NATHAN RD MONGKOK, HONGKONG
Manufacturer	HONG KONG IPRO TECHNOLOGY CO.,LIMITED
Manufacturer Add	FLAT/RM A3, 9/F SILVERCORP INT TOWER 707-713 NATHAN RD MONGKOK, HONGKONG

## 3. Test site information

Test Lab A:

Lab performing tests	SIEMIC (Shenzhen-China) LABORATORIES
Lab Address	Zone A, Floor 1, Building 2 Wan Ye Long Technology Park South Side of Zhoushi Road, Bao' an District, Shenzhen, Guangdong China 518108
FCC Test Site No.	535293
IC Test Site No.	4842E-1
Test Software	Radiated Emission Program-To Shenzhen v2.0

Test Lab B:

Lab performing tests	SIEMIC (Nanjing-China) Laboratories
Lab Address	2-1 Longcang Avenue Yuhua Economic and Technology Development Park, Nanjing, China
FCC Test Site No.	694825
IC Test Site No.	4842B-1
Test Software	EZ_EMG(ver.lcp-03A1)

Test Report	17071350-FCC-R1
Page	12 of 96

---

Note: We just perform Radiated Spurious Emission above 18GHz in the test Lab. B.

## 4. Equipment under Test (EUT) Information

Description of EUT:	Mobile Phone
Main Model:	Win
Serial Model:	N/A
Date EUT received:	December 04, 2017
Test Date(s):	December 05, 2017 to January 08, 2018
Equipment Category :	PCE
Antenna Gain:	GSM850: 0.5dBi PCS1900: 0.8dBi UMTS-FDD Band V: 0.5dBi UMTS-FDD Band II: 0.8dBi Bluetooth/BLE/WIFI: 1.5dBi GPS: 1dBi
Antenna Type:	PIFA antenna
Type of Modulation:	GSM / GPRS: GMSK EGPRS: GMSK UMTS-FDD: QPSK 802.11b/g/n: DSSS, OFDM Bluetooth: GFSK, $\pi$ /4DQPSK, 8DPSK BLE: GFSK GPS: BPSK
RF Operating Frequency (ies):	GSM850 TX: 824.2 ~ 848.8 MHz; RX: 869.2 ~ 893.8 MHz PCS1900 TX: 1850.2 ~ 1909.8 MHz; RX: 1930.2 ~ 1989.8 MHz UMTS-FDD Band V TX: 826.4 ~ 846.6 MHz; RX: 871.4 ~ 891.6 MHz UMTS-FDD Band II TX: 1852.4 ~ 1907.6 MHz; RX: 1932.4 ~ 1987.6 MHz WIFI: 802.11b/g/n(20M): 2412-2462 MHz WIFI: 802.11n(40M): 2422-2452 MHz Bluetooth& BLE: 2402-2480 MHz GPS: 1575.42 MHz

	GSM Voice:GSM850: 31.66dBm
	PCS1900: 30.85dBm
	GPRS:GSM850: 31.66dBm
	PCS1900: 30.86dBm
	EGPRS:GSM850: 31.76dBm
Maximum Conducted	PCS1900: 30.95dBm
AV Power to Antenna:	RMC:UMTS-FDD Band V: 23.22dBm
	UMTS-FDD Band II: 22.63dBm
	HSUPA:UMTS-FDD Band V: 22.62dBm
	UMTS-FDD Band II: 22.06dBm
	HSDPA:UMTS-FDD Band V: 22.70dBm
	UMTS-FDD Band II: 22.12dBm
	GSM Voice:GSM850: 30.01dBm / ERP
	PCS1900: 31.65dBm / EIRP
	GPRS:GSM850: 30.01dBm / ERP
	PCS1900: 31.66dBm / EIRP
	EGPRS:GSM850: 30.11dBm / ERP
ERP/EIRP:	PCS1900: 31.75dBm / EIRP
	RMC:UMTS-FDD Band V: 21.57dBm / ERP
	UMTS-FDD Band II: 23.43dBm / EIRP
	HSDPA:UMTS-FDD Band V: 21.05dBm / ERP
	UMTS-FDD Band II: 22.78dBm / EIRP
	HSUPA:UMTS-FDD Band V: 20.79dBm / ERP
	UMTS-FDD Band II: 22.68dBm / EIRP
	GSM 850: 124CH
	PCS1900: 299CH
	UMTS-FDD Band V: 102CH
	UMTS-FDD Band II: 277CH
Number of Channels:	WIFI :802.11b/g/n(20M): 11CH
	WIFI :802.11n(40M): 7CH
	Bluetooth: 79CH
	BLE: 40CH
	GPS:1CH
Port:	USB Port, Earphone Port

Test Report	17071350-FCC-R1
Page	15 of 96

---

Adapter:  
Model: NTR-WIN  
Input: AC100-240V~50/60Hz, 0.2A  
Output: DC 5.0V,1000mA

Input Power:  
Battery:  
Model: WIN  
Spec: 3.8V, 2700mAh  
Voltage: 4.35V

Trade Name : IPRO

GPRS/ EGPRS Multi-slot class 8/10/11/12

FCC ID: PQ4WIN

## 5. Test Summary

The product was tested in accordance with the following specifications.

All testing has been performed according to below product classification:

FCC Rules	Description of Test	Result
§ 1.1307; § 2.1093	RF Exposure (SAR)	Compliance
§2.1046; § 22.913(a); § 24.232(c); § 27.50(c.10) ;	RF Output Power	Compliance
§ 24.232 (d) ;	Peak-Average Ratio	Compliance
§ 2.1049; § 22.905; § 22.917; § 24.238;	99% & -26 dB Occupied Bandwidth	Compliance
§ 2.1051; § 22.917(a); § 24.238(a);	Spurious Emissions at Antenna Terminal	Compliance
§ 2.1053; § 22.917(a); § 24.238(a);	Field Strength of Spurious Radiation	Compliance
§ 22.917(a); § 24.238(a);	Out of band emission, Band Edge	Compliance
§ 2.1055; § 22.355; § 24.235;	Frequency stability vs. temperature Frequency stability vs. voltage	Compliance

Note: Testing was performed by configuring EUT to maximum output power status, the declared output power class for different

### Measurement Uncertainty

Emissions		
Test Item	Description	Uncertainty
Band Edge and Radiated Spurious Emissions	Confidence level of approximately 95% (in the case where distributions are normal), with a coverage factor of 2 (for EUTs < 0.5m X 0.5m X 0.5m)	+5.6dB/-4.5dB
-	-	-



## 6. MEASUREMENTS, EXAMINATION AND DERIVED RESULTS

### 6.1 RF Exposure (SAR)

Test Result: Pass

The EUT is a portable device, thus requires SAR evaluation;

Please refer to RF Exposure Evaluation Report: 17071350-FCC-H.

## 6.2 RF Output Power

Temperature	23°C
Relative Humidity	55%
Atmospheric Pressure	1012mbar
Test date :	December 04, 2017
Tested By :	Aaron Liang

### Requirement(s):

Spec	Item	Requirement	Applicable
§22.913 (a)	a)	ERP:38.45dBm	<input checked="" type="checkbox"/>
§24.232 (c)	b)	EIRP:33dBm	<input checked="" type="checkbox"/>

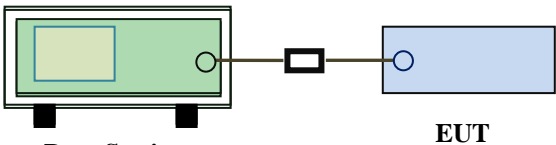
Test Setup	 <p style="text-align: center;">Base Station                      EUT</p>
------------	--

Test Procedure	<p>For Conducted Power:</p> <ul style="list-style-type: none"> <li>- The transmitter output port was connected to base station.</li> <li>- Set EUT at maximum power through base station.</li> <li>- Select lowest, middle, and highest channels for each band and different test mode.</li> </ul> <p>For ERP/EIRP:</p> <p>According with KDB 971168 v02r02</p> <ul style="list-style-type: none"> <li>- The transmitter was placed on a wooden turntable, and it was transmitting into a non-radiating load which was also placed on the turntable.</li> <li>- The measurement antenna was placed at a distance of 3 meters from the EUT. During the tests, the antenna height and polarization as well as EUT azimuth were varied in order to identify the maximum level of emissions from the EUT. The test was performed by placing the EUT on 3-orthogonal axis.</li> <li>- The frequency range up to tenth harmonic of the fundamental frequency was investigated.</li> </ul>
----------------	---

Test Report	17071350-FCC-R1
Page	19 of 96

	<ul style="list-style-type: none"> <li>- Remove the EUT and replace it with substitution antenna. A signal generator was connected to the substitution antenna by a non-radiating cable. The absolute levels of the spurious emissions were measured by the substitution.</li> <li>- Spurious emissions in dB = 10 log (TX power in Watts/0.001) – the absolute level</li> <li>- Spurious attenuation limit in dB = 43 + 10 Log10 (power out in Watts).</li> </ul>
Remark	
Result	<input checked="" type="checkbox"/> Pass <input type="checkbox"/> Fail

Test Data     Yes                       N/A  
 Test Plot     Yes (See below)             N/A

## Conducted Power

### GSM Mode:

Burst Average Power (dBm);								
Band	GSM850				PCS1900			
Channel	128	190	251	Tune up Power tolerant	512	661	810	Tune up Power tolerant
Frequency (MHz)	824.2	836.6	848.8	/	1850.2	1880	1909.8	/
GSM Voice (1 uplink),GMSK	31.66	31.56	31.43	32±1	30.44	30.64	30.85	31±1
GPRS Multi-Slot Class 8 (1 uplink),GMSK	31.56	31.66	31.55	32±1	30.44	30.68	30.86	31±1
GPRS Multi-Slot Class 10 (2 uplink) GMSK	31.09	30.96	30.76	31±1	29.69	29.84	29.95	30±1
GPRS Multi-Slot Class 11 (3 uplink) GMSK	29.3	29.01	28.44	29±1	27.81	28.33	28.41	28±1
GPRS Multi-Slot Class 12 (4 uplink) GMSK	28.01	27.9	27.61	28±1	26.42	26.71	27.12	27±1
EGPRS Multi-Slot Class 8 (1 uplink) GMSK MCS1	31.76	31.68	31.56	32±1	30.54	30.76	30.95	31±1
EGPRS Multi-Slot Class 10 (2 uplink) GMSK MCS1	31.06	30.94	30.79	31±1	29.85	29.63	29.99	30±1
EGPRS Multi-Slot Class 11 (3 uplink) GMSK MCS1	29.28	29.04	28.26	29±1	27.83	28.14	28.48	28±1
EGPRS Multi-Slot Class 12 (4 uplink) GMSK MCS1	28.09	27.87	27.54	28±1	26.46	26.73	27.07	27±1
Remark :								
GPRS, CS1 coding scheme.								
EGPRS, MCS1 coding scheme.								



Test Report	17071350-FCC-R1
Page	21 of 96

Multi-Slot Class 8 , Support Max 4 downlink, 1 uplink , 5 working link  
Multi-Slot Class 10 , Support Max 4 downlink, 2 uplink , 5 working link  
Multi-Slot Class 12 , Support Max 4 downlink, 4 uplink , 5 working link

## UMTS Mode:

### UMTS-FDD Band V

Band/ Time Slot configuration	Channel	Frequency	Average power (dBm)	Tune up Power tolerant
RMC 12.2kbps	4132	826.4	23.22	23±1
	4175	835	23.12	23±1
	4233	846.6	23.02	23±1
HSDPA Subtest1	4132	826.4	22.61	22±1
	4175	835	22.48	22±1
	4233	846.6	22.23	22±1
HSDPA Subtest2	4132	826.4	22.7	22±1
	4175	835	22.48	22±1
	4233	846.6	22.36	22±1
HSDPA Subtest3	4132	826.4	22.52	22±1
	4175	835	22.33	22±1
	4233	846.6	22.32	22±1
HSDPA Subtest4	4132	826.4	22.62	22±1
	4175	835	22.39	22±1
	4233	846.6	22.31	22±1
HSUPA Subtest1	4132	826.4	22.62	22±1
	4175	835	22.46	22±1
	4233	846.6	22.32	22±1
HSUPA Subtest2	4132	826.4	22.5	22±1
	4175	835	22.17	22±1
	4233	846.6	22.33	22±1
HSUPA Subtest3	4132	826.4	22.44	22±1
	4175	835	22.47	22±1
	4233	846.6	22.27	22±1
HSUPA Subtest4	4132	826.4	22.47	22±1
	4175	835	22.14	22±1
	4233	846.6	22.23	22±1
HSUPA Subtest5	4132	826.4	22.56	22±1
	4175	835	22.61	22±1
	4233	846.6	22.29	22±1

## UMTS-FDD Band II

Band/ Time Slot configuration	Channel	Frequency	Average power (dBm)	Tune up Power tolerant
RMC 12.2kbps	9262	1852.4	22.63	23±1
	9400	1880	22.53	23±1
	9538	1907.6	22.43	23±1
HSDPA Subtest1	9262	1852.4	22.03	22±1
	9400	1880	21.89	22±1
	9538	1907.6	21.78	22±1
HSDPA Subtest2	9262	1852.4	22.12	22±1
	9400	1880	21.95	22±1
	9538	1907.6	21.81	22±1
HSDPA Subtest3	9262	1852.4	21.98	22±1
	9400	1880	21.81	22±1
	9538	1907.6	21.75	22±1
HSDPA Subtest4	9262	1852.4	22.07	22±1
	9400	1880	21.94	22±1
	9538	1907.6	21.74	22±1
HSUPA Subtest1	9262	1852.4	21.84	22±1
	9400	1880	21.85	22±1
	9538	1907.6	21.68	22±1
HSUPA Subtest2	9262	1852.4	21.69	22±1
	9400	1880	21.63	22±1
	9538	1907.6	21.64	22±1
HSUPA Subtest3	9262	1852.4	21.93	22±1
	9400	1880	21.76	22±1
	9538	1907.6	21.79	22±1
HSUPA Subtest4	9262	1852.4	21.88	22±1
	9400	1880	21.74	22±1
	9538	1907.6	21.6	22±1
HSUPA Subtest5	9262	1852.4	22.06	22±1
	9400	1880	21.94	22±1
	9538	1907.6	21.74	22±1

## ERP & EIRP

### GSM Voice

#### ERP for Cellular Band (Part 22H)

Frequency (MHz)	Substituted level (dBm)	Antenna Polarization	Antenna Gain correction (dBi)	Cable Loss (dB)	Absolute Level (dBm)	Limit (dBm)
824.2	24.44	V	6.1	0.53	30.01	38.45
824.2	22.66	H	6.1	0.53	28.23	38.45
836.6	24.24	V	6.2	0.53	29.91	38.45
836.6	22.67	H	6.2	0.53	28.34	38.45
848.8	24.11	V	6.2	0.53	29.78	38.45
848.8	22.92	H	6.2	0.53	28.59	38.45

#### EIRP for PCS Band (Part 24E)

Frequency (MHz)	Substituted level (dBm)	Antenna Polarization	Antenna Gain correction (dBi)	Cable Loss (dB)	Absolute Level (dBm)	Limit (dBm)
1850.2	24.08	V	7.88	0.72	31.24	33
1850.2	23.3	H	7.88	0.72	30.46	33
1880	24.28	V	7.88	0.72	31.44	33
1880	23.51	H	7.88	0.72	30.67	33
1909.8	24.51	V	7.86	0.72	31.65	33
1909.8	22.78	H	7.86	0.72	29.92	33



**GPRS:**

**ERP for Cellular Band (Part 22H)**

Frequency (MHz)	Substituted level (dBm)	Antenna Polarization	Antenna Gain correction (dBi)	Cable Loss (dB)	Absolute Level (dBm)	Limit (dBm)
824.2	24.34	V	6.1	0.53	29.91	38.45
824.2	23.62	H	6.1	0.53	29.19	38.45
836.6	24.34	V	6.2	0.53	30.01	38.45
836.6	23.04	H	6.2	0.53	28.71	38.45
848.8	24.23	V	6.2	0.53	29.9	38.45
848.8	23.39	H	6.2	0.53	29.06	38.45

**EIRP for PCS Band (Part 24E)**

Frequency (MHz)	Substituted level (dBm)	Antenna Polarization	Antenna Gain correction (dBi)	Cable Loss (dB)	Absolute Level (dBm)	Limit (dBm)
1850.2	24.08	V	7.88	0.72	31.24	33
1850.2	23.19	H	7.88	0.72	30.35	33
1880	24.32	V	7.88	0.72	31.48	33
1880	22.95	H	7.88	0.72	30.11	33
1909.8	24.52	V	7.86	0.72	31.66	33
1909.8	22.64	H	7.86	0.72	29.78	33

**EGPRS (MCS1):**

**ERP for Cellular Band (Part 22H)**

Frequency (MHz)	Substituted level (dBm)	Antenna Polarization	Antenna Gain correction (dBi)	Cable Loss (dB)	Absolute Level (dBm)	Limit (dBm)
824.2	24.54	V	6.1	0.53	30.11	38.45
824.2	23.73	H	6.1	0.53	29.3	38.45
836.6	24.36	V	6.2	0.53	30.03	38.45
836.6	22.97	H	6.2	0.53	28.64	38.45
848.8	24.24	V	6.2	0.53	29.91	38.45
848.8	22.66	H	6.2	0.53	28.33	38.45

**EIRP for PCS Band (Part 24E)**

Frequency (MHz)	Substituted level (dBm)	Antenna Polarization	Antenna Gain correction (dBi)	Cable Loss (dB)	Absolute Level (dBm)	Limit (dBm)
1850.2	24.18	V	7.88	0.72	31.34	33
1850.2	22.38	H	7.88	0.72	29.54	33
1880	24.4	V	7.88	0.72	31.56	33
1880	22.82	H	7.88	0.72	29.98	33
1909.8	24.61	V	7.86	0.72	31.75	33
1909.8	23.73	H	7.86	0.72	30.87	33

## RMC

### ERP for UMTS-FDD Band V (Part 22H)

Frequency (MHz)	Substituted level (dBm)	Antenna Polarization	Antenna Gain correction (dBi)	Cable Loss (dB)	Absolute Level (dBm)	Limit (dBm)
826.4	16	V	6.1	0.53	21.57	38.45
826.4	14.93	H	6.1	0.53	20.5	38.45
835	15.8	V	6.2	0.53	21.47	38.45
835	13.93	H	6.2	0.53	19.6	38.45
846.6	15.7	V	6.2	0.53	21.37	38.45
846.6	14.99	H	6.2	0.53	20.66	38.45

### EIRP for UMTS-FDD Band II (Part 24E)

Frequency (MHz)	Substituted level (dBm)	Antenna Polarization	Antenna Gain correction (dBi)	Cable Loss (dB)	Absolute Level (dBm)	Limit (dBm)
1852.4	16.27	V	7.88	0.72	23.43	33
1852.4	15.56	H	7.88	0.72	22.72	33
1880	16.17	V	7.88	0.72	23.33	33
1880	14.37	H	7.88	0.72	21.53	33
1907.6	16.09	V	7.86	0.72	23.23	33
1907.6	14.46	H	7.86	0.72	21.6	33

## HSDPA

### ERP for UMTS-FDD Band V (Part 22H)

Frequency (MHz)	Substituted level (dBm)	Antenna Polarization	Antenna Gain correction (dBi)	Cable Loss (dB)	Absolute Level (dBm)	Limit (dBm)
826.4	15.48	V	6.1	0.53	21.05	38.45
826.4	14.57	H	6.1	0.53	20.14	38.45
835	15.04	V	6.2	0.53	20.71	38.45
835	14.03	H	6.2	0.53	19.7	38.45
846.6	15.01	V	6.2	0.53	20.68	38.45
846.6	13.71	H	6.2	0.53	19.38	38.45

### EIRP for UMTS-FDD Band II (Part 24E)

Frequency (MHz)	Substituted level (dBm)	Antenna Polarization	Antenna Gain correction (dBi)	Cable Loss (dB)	Absolute Level (dBm)	Limit (dBm)
1852.4	15.59	V	7.88	0.72	22.75	33
1852.4	13.76	H	7.88	0.72	20.92	33
1880	15.62	V	7.88	0.72	22.78	33
1880	14.5	H	7.88	0.72	21.66	33
1907.6	15.41	V	7.86	0.72	22.55	33
1907.6	14.6	H	7.86	0.72	21.74	33

## HSUPA

### ERP for UMTS-FDD Band V (Part 22H)

Frequency (MHz)	Substituted level (dBm)	Antenna Polarization	Antenna Gain correction (dBi)	Cable Loss (dB)	Absolute Level (dBm)	Limit (dBm)
826.4	14.95	V	6.1	0.53	20.52	38.45
826.4	14.21	H	6.1	0.53	19.78	38.45
835	15.12	V	6.2	0.53	20.79	38.45
835	13.97	H	6.2	0.53	19.64	38.45
846.6	14.95	V	6.2	0.53	20.62	38.45
846.6	13.84	H	6.2	0.53	19.51	38.45

### EIRP for UMTS-FDD Band II (Part 24E)

Frequency (MHz)	Substituted level (dBm)	Antenna Polarization	Antenna Gain correction (dBi)	Cable Loss (dB)	Absolute Level (dBm)	Limit (dBm)
1852.4	15.4	V	7.88	0.72	22.56	33
1852.4	13.61	H	7.88	0.72	20.77	33
1880	15.52	V	7.88	0.72	22.68	33
1880	14	H	7.88	0.72	21.16	33
1907.6	15.26	V	7.86	0.72	22.4	33
1907.6	14.03	H	7.86	0.72	21.17	33

### 6.3 Peak-Average Ratio

Temperature	23°C
Relative Humidity	55%
Atmospheric Pressure	1012mbar
Test date :	December 04, 2017
Tested By :	Aaron Liang

Requirement(s):

Spec	Item	Requirement	Applicable
§24.232(d)	a)	The peak-to-average ratio (PAR) of the transmission may not exceed 13dB.	<input checked="" type="checkbox"/>

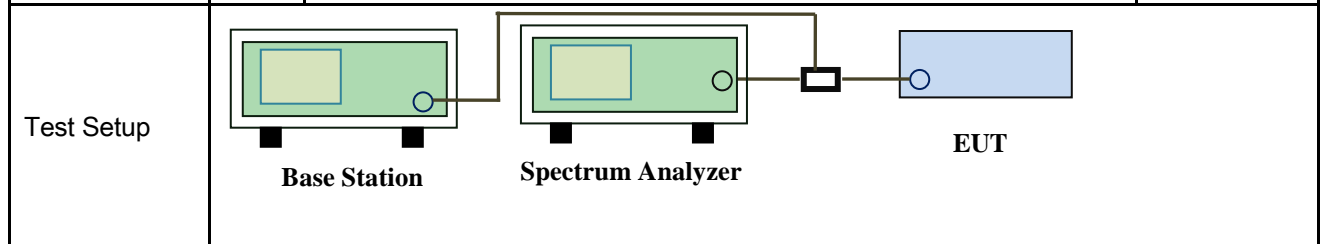

Test Procedure	<p><b>According with KDB 971168 v02r02</b></p> <p><b>5.7.2 Alternate procedure for PAPR</b></p> <p><b>5.1.2 Peak power measurements with a peak power meter</b></p> <p>The total peak output power may be measured using a broadband peak RF power meter. The power meter must have a video bandwidth that is greater than or equal to the emission bandwidth and utilize a fast-responding diode detector.</p> <p><b>5.2.3 Average power measurement with average power meter</b></p> <p>As an alternative to the use of a spectrum/signal analyzer or EMI receiver to perform a measurement of the total in-band average output power, a wideband RF average power meter with a thermocouple detector or equivalent can be used under certain conditions</p> <p>If the EUT can be configured to transmit continuously (i.e., the burst duty cycle <math>\geq 98\%</math>) and at all times the EUT is transmitting at its maximum output</p>
----------------	--

	<p>power level, then a conventional wide-band RF power meter can be used.</p> <p>If the EUT cannot be configured to transmit continuously (i.e., the burst duty cycle &lt; 98%), then there are two options for the use of an average power meter. First, a gated average power meter can be used to perform the measurement if the gating parameters can be adjusted such that the power is measured only over active transmission bursts at maximum output power levels. A conventional average power meter can also be used if the measured burst duty cycle is constant (i.e., duty cycle variations are less than <math>\pm 2</math> percent) by performing the measurement over the on/off burst cycles and then correcting (increasing) the measured level by a factor equal to <math>10\log(1/\text{duty cycle})</math></p>
Remark	
Result	<input checked="" type="checkbox"/> Pass <input type="checkbox"/> Fail

**Test Data**     Yes                       N/A  
**Test Plot**     Yes (See below)             N/A

**GSM : GSM 1900 PK-AV POWER (PART 24E)**

Frequency (MHz)	Conducted power(dBm)		Peak-Average Ratio(PAR)
	Peak	Average	
1850.2	31.26	30.44	0.82
1880	31.46	30.64	0.82
1909.8	31.59	30.86	0.73

**GPRS 1900 PK-AV POWER (PART 24E)**

Frequency (MHz)	Conducted power(dBm)		Peak-Average Ratio(PAR)
	Peak	Average	
1850.2	31.4	30.44	0.96
1880	31.49	30.68	0.81
1909.8	31.59	30.88	0.71

**EGPRS (MSC1) 1900 PK-AV POWER (PART 24E)**

Frequency (MHz)	Conducted power(dBm)		Peak-Average Ratio(PAR)
	Peak	Average	
1850.2	31.39	30.54	0.85
1880	31.57	30.76	0.81
1909.8	31.63	30.95	0.68

**RMC : UMTS-FDD Band 2 PK-AV POWER (PART 24E)**

Frequency (MHz)	Conducted power(dBm)		Peak-Average Ratio(PAR)
	Peak	Average	
1852.4	24.36	23.48	0.88
1880	24.46	23.45	1.01
1907.6	24.36	23.37	0.99

**HSDPA : UMTS-FDD Band 2 PK-AV POWER (PART 24E)**

Frequency (MHz)	Conducted power(dBm)		Peak-Average Ratio(PAR)
	Peak	Average	
1852.4	23.59	22.85	0.74
1880	23.69	22.78	0.91
1907.6	23.66	22.65	1.01



**HSUPA : UMTS-FDD Band 2 PK-AV POWER (PART 24E)**

Frequency (MHz)	Conducted power(dBm)		Peak-Average Ratio(PAR)
	Peak	Average	
1852.4	23.68	22.78	0.9
1880	23.68	22.77	0.91
1907.6	23.56	22.6	0.96

## 6.4 Occupied Bandwidth

Temperature	26°C
Relative Humidity	56%
Atmospheric Pressure	1022mbar
Test date :	December 26, 2017
Tested By :	Aaron Liang

### Requirement(s):

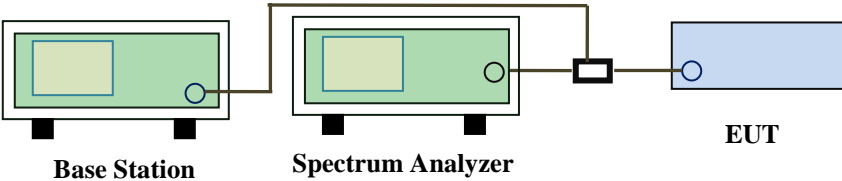
Spec	Item	Requirement	Applicable
§2.1049, §22.917, §22.905 §24.238	a)	99% Occupied Bandwidth(kHz)	<input checked="" type="checkbox"/>
	b)	26 dB Bandwidth(kHz)	<input checked="" type="checkbox"/>
Test Setup	 <p style="text-align: center;">Base Station      Spectrum Analyzer      EUT</p>		
Test Procedure	<ul style="list-style-type: none"> <li>- The EUT was connected to Spectrum Analyzer and Base Station via power divider.</li> <li>- The 99% and 26 dB occupied bandwidth (BW) of the middle channel for the highest RF powers.</li> </ul>		
Remark			
Result	<input checked="" type="checkbox"/> Pass <input type="checkbox"/> Fail		

Test Data     Yes       N/A

Test Plot     Yes (See below)       N/A

**GSM Voice:**

**Cellular Band (Part 22H) result**

Channel	Frequency (MHz)	99% Occupied Bandwidth (kHz)	26 dB Bandwidth (kHz)
128	824.2	245.85	315.2
190	836.6	246.65	313.8
251	848.8	248.71	318.7

**PCS Band (Part 24E) result**

Channel	Frequency (MHz)	99% Occupied Bandwidth (kHz)	26 dB Bandwidth (kHz)
512	1850	250.47	316.6
661	1880	247.85	320.7
810	1910	251.58	319.3

**GPRS:**

**Cellular Band (Part 22H) result**

Channel	Frequency (MHz)	99% Occupied Bandwidth (kHz)	26 dB Bandwidth (kHz)
128	824.2	245.79	318.4
190	836.6	246.83	313.8
251	848.8	247.75	317.8

**PCS Band (Part 24E) result**

Channel	Frequency (MHz)	99% Occupied Bandwidth (kHz)	26 dB Bandwidth (kHz)
512	1850	246.44	315.9
661	1880	248.30	318.1
810	1910	250.49	320.1

**EGPRS (MSC 1):**

**Cellular Band (Part 22H) result**

Channel	Frequency (MHz)	99% Occupied Bandwidth (kHz)	26 dB Bandwidth (kHz)
128	824.2	245.49	315.9
190	836.6	246.48	313.8
251	848.8	245.76	318.9

**PCS Band (Part 24E) result**

Channel	Frequency (MHz)	99% Occupied Bandwidth (kHz)	26 dB Bandwidth (kHz)
512	1850	246.44	315.9
661	1880	248.30	318.1
810	1910	250.49	320.1

**RMC:**

**UMTS-FDD Band V (Part 22H)**

Channel	Frequency (MHz)	99% Occupied Bandwidth (MHz)	26 dB Bandwidth (MHz)
4132	826.6	4.0952	4.655
4175	835.0	4.0826	4.640
4233	846.4	4.0667	4.629

**UMTS-FDD Band II (Part 24E)**

Channel	Frequency (MHz)	99% Occupied Bandwidth (MHz)	26 dB Bandwidth (MHz)
9262	1853	4.1036	4.655
9400	1880	4.0926	4.626
9538	1907	4.1050	4.687

**HSDPA:**

**UMTS-FDD Band V (Part 22H)**

Channel	Frequency (MHz)	99% Occupied Bandwidth (MHz)	26 dB Bandwidth (MHz)
4132	826.6	4.0984	4.655
4175	835.0	4.0839	4.664
4233	846.4	4.0769	4.618

**UMTS-FDD Band II (Part 24E)**

Channel	Frequency (MHz)	99% Occupied Bandwidth (MHz)	26 dB Bandwidth (MHz)
9262	1853	4.1063	4.673
9400	1880	4.0891	4.645
9538	1907	4.1145	4.674

**HSUPA:**

**UMTS-FDD Band V (Part 22H)**

Channel	Frequency (MHz)	99% Occupied Bandwidth (MHz)	26 dB Bandwidth (MHz)
4132	826.6	4.0975	4.637
4175	835.0	4.0830	4.660
4233	846.4	4.0663	4.629

**UMTS-FDD Band II (Part 24E)**

Channel	Frequency (MHz)	99% Occupied Bandwidth (MHz)	26 dB Bandwidth (MHz)
9262	1853	4.1057	4.666
9400	1880	4.0878	4.640
9538	1907	4.1014	4.672

### Test Plots

#### GSM Voice:

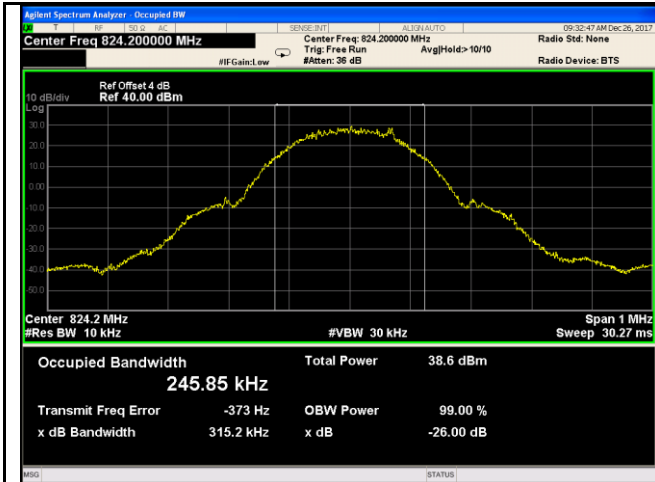

GSM 850 BW - Low CH 824.2MHz

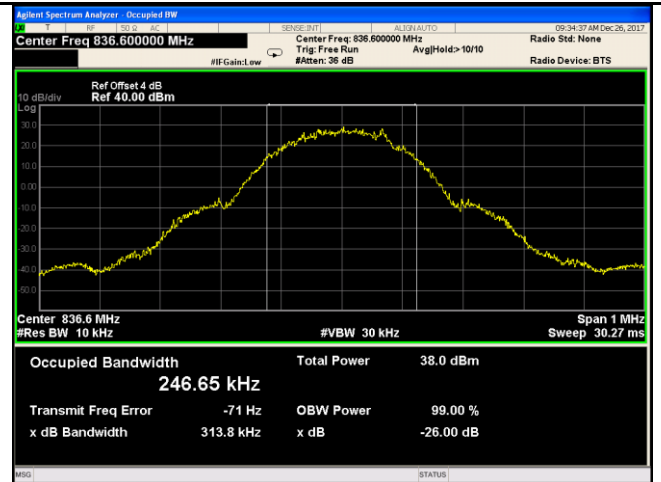

GSM 850 BW - Mid CH 836.6MHz

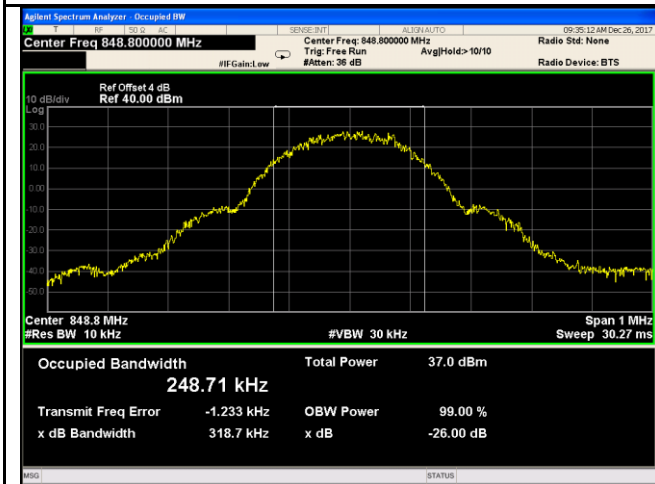

GSM 850 BW - High CH 848.8MHz

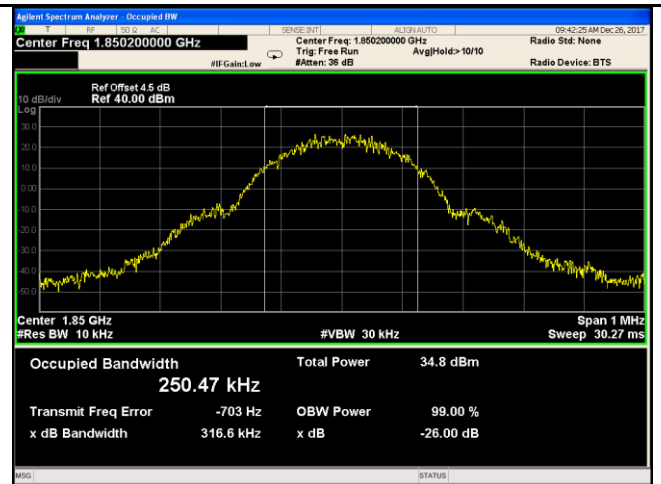

PCS 1900 BW - Low CH 1850MHz

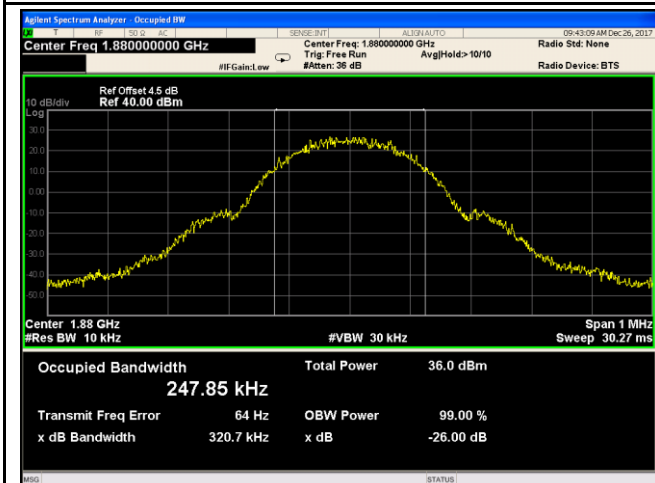

PCS 1900 BW - Mid CH 1880MHz

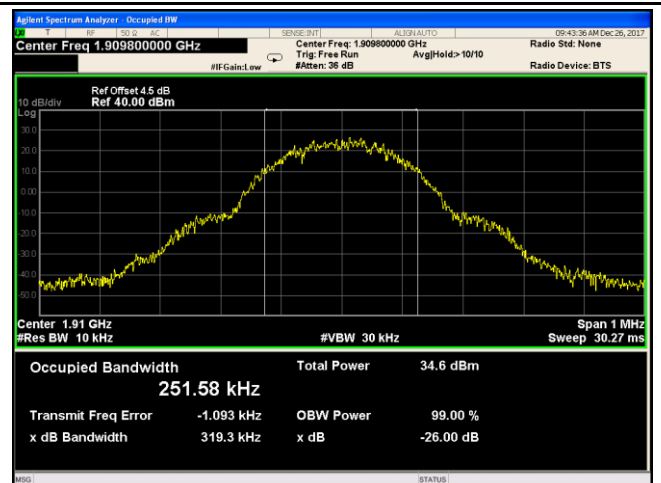

PCS 1900 BW - High CH 1910MHz

**GPRS:**

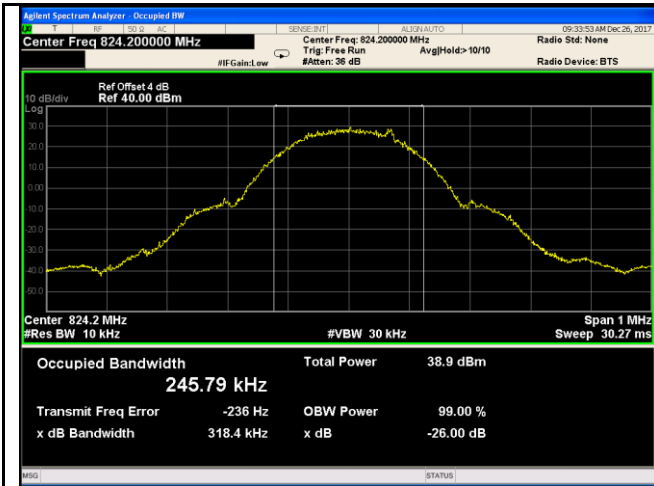

GSM 850 BW - Low CH 824.2MHz

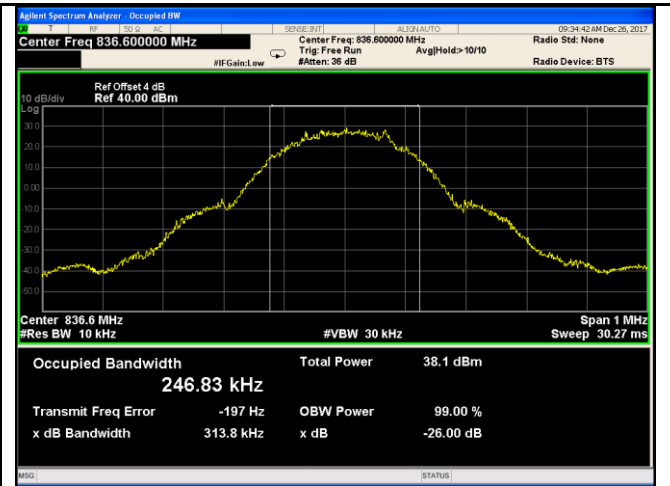

GSM 850 BW - Mid CH 836.6MHz

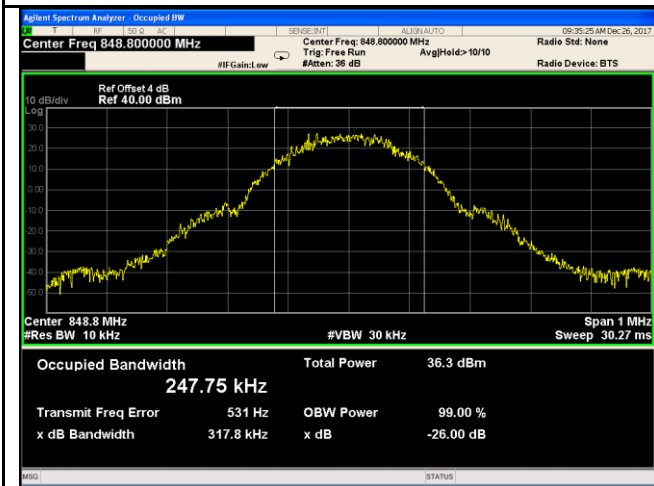

GSM 850 BW - High CH 848.8MHz

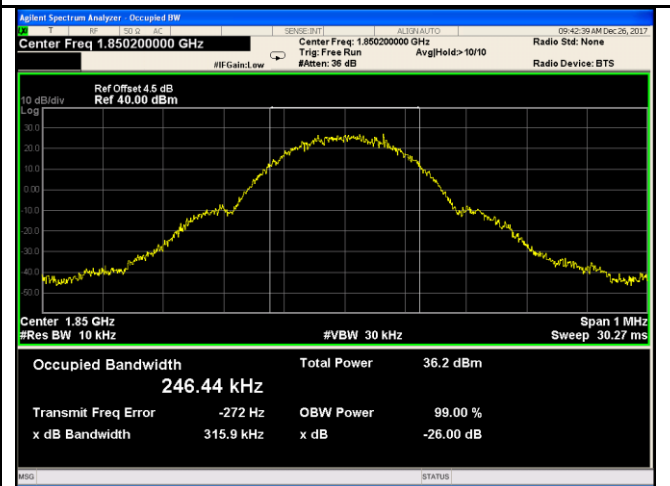

PCS 1900 BW - Low CH 1850MHz

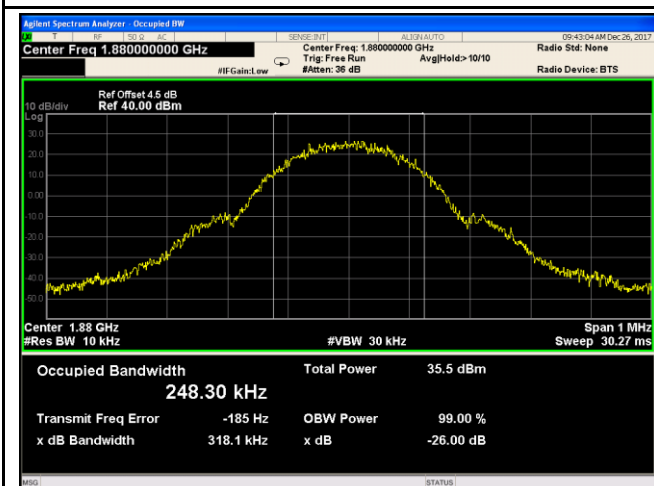

PCS 1900 BW - Mid CH 1880MHz

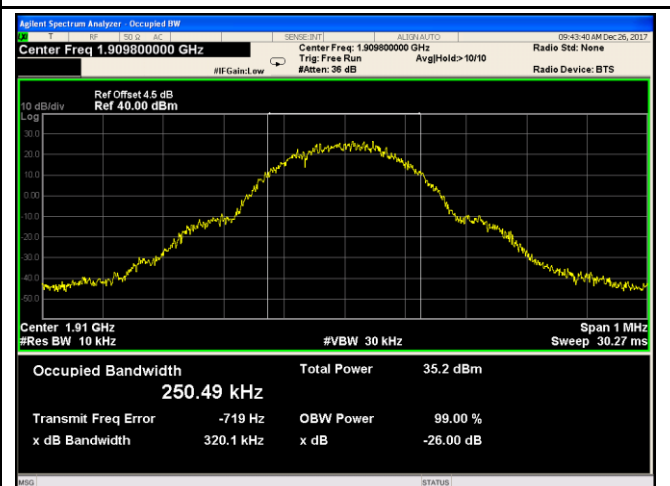

PCS 1900 BW - High CH 1910MHz



**EGPRS (MCS1):**

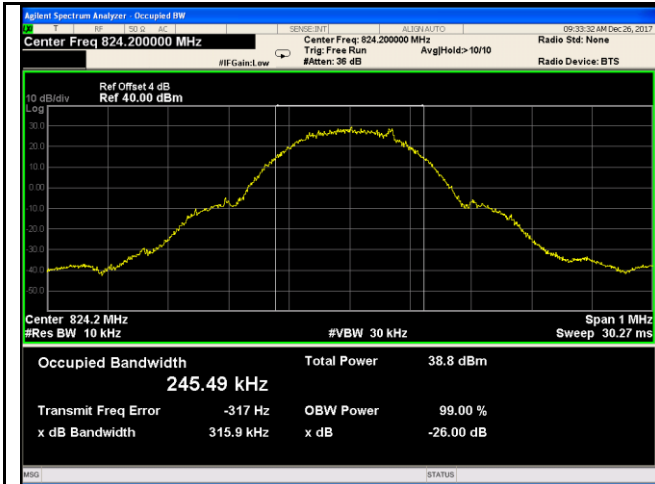

GSM 850 BW - Low CH 824.2MHz

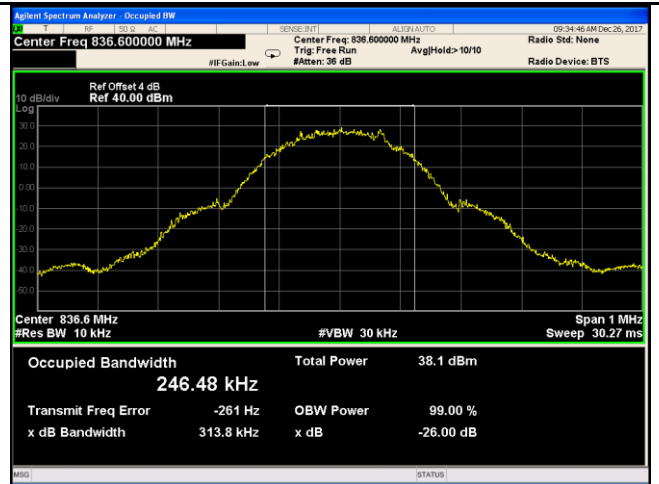

GSM 850 BW - Mid CH 836.6MHz

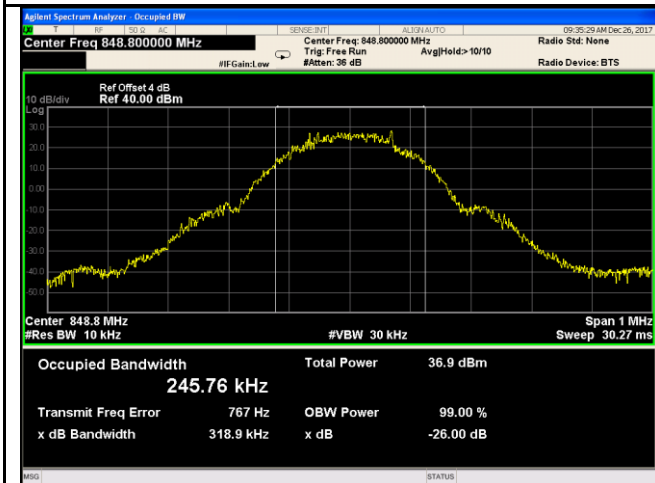

GSM 850 BW - High CH 848.8MHz

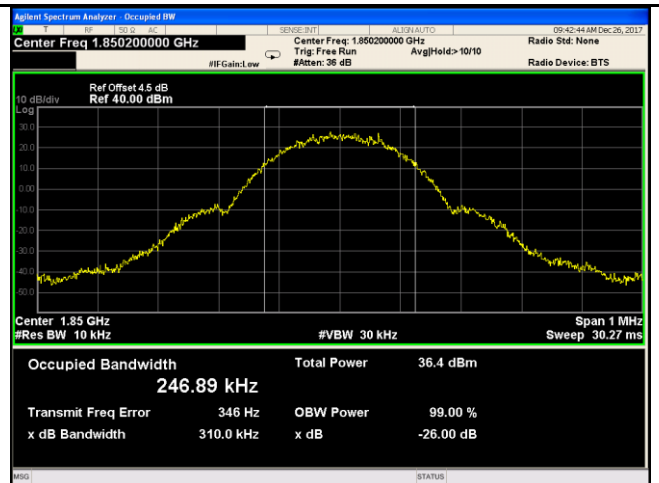

PCS 1900 BW - Low CH 1850MHz

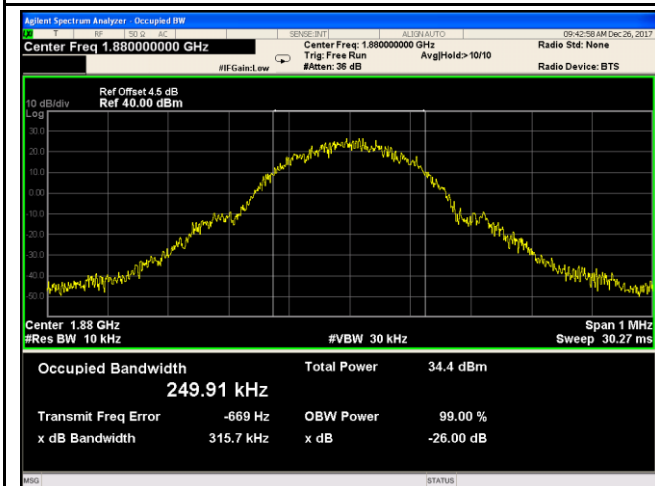

PCS 1900 BW - Mid CH 1880MHz

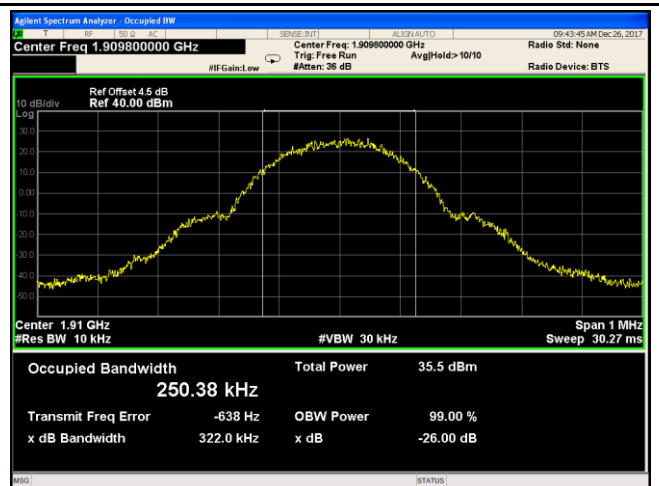

PCS 1900 BW - High CH 1910MHz

RMC:

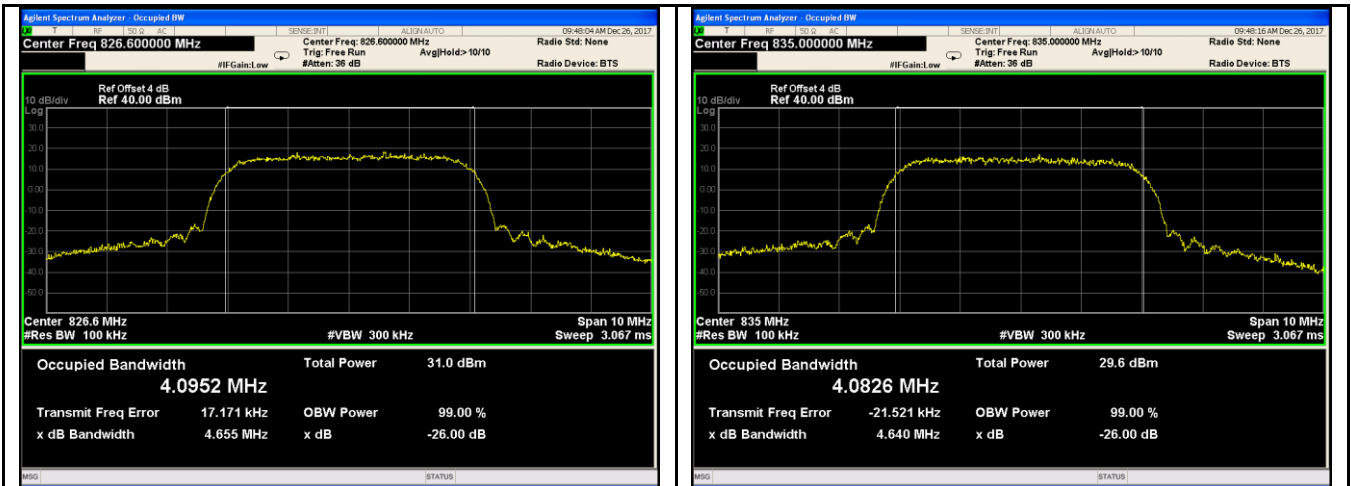

Band V BW - Low CH 826.6 MHz

Band V BW - Mid CH 835.0 MHz

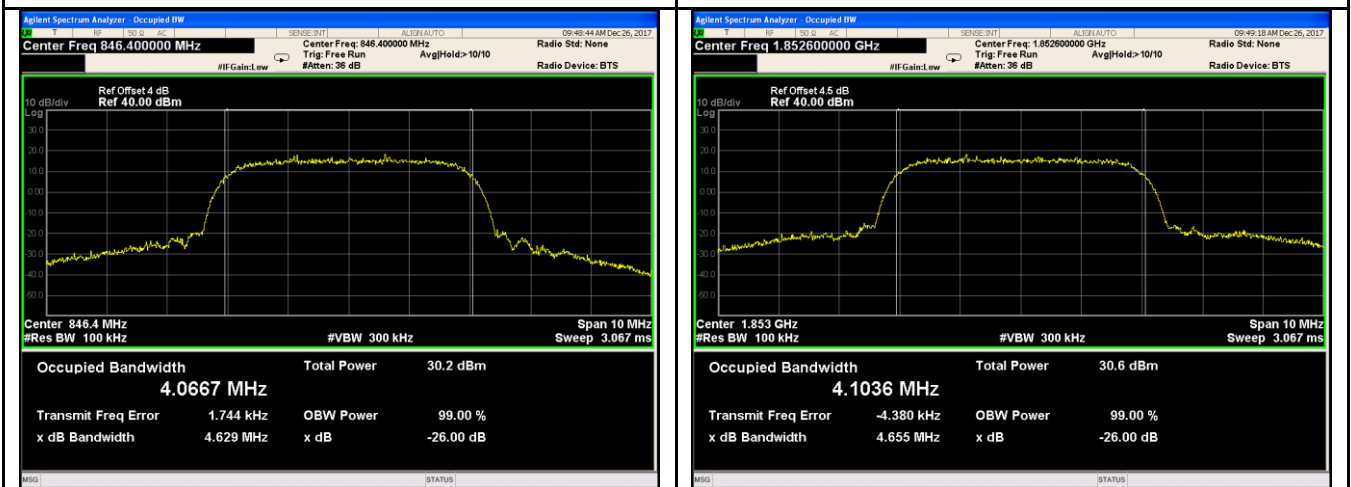

Band V BW - High CH 846.4 MHz

Band II BW - Low CH 1853MHz

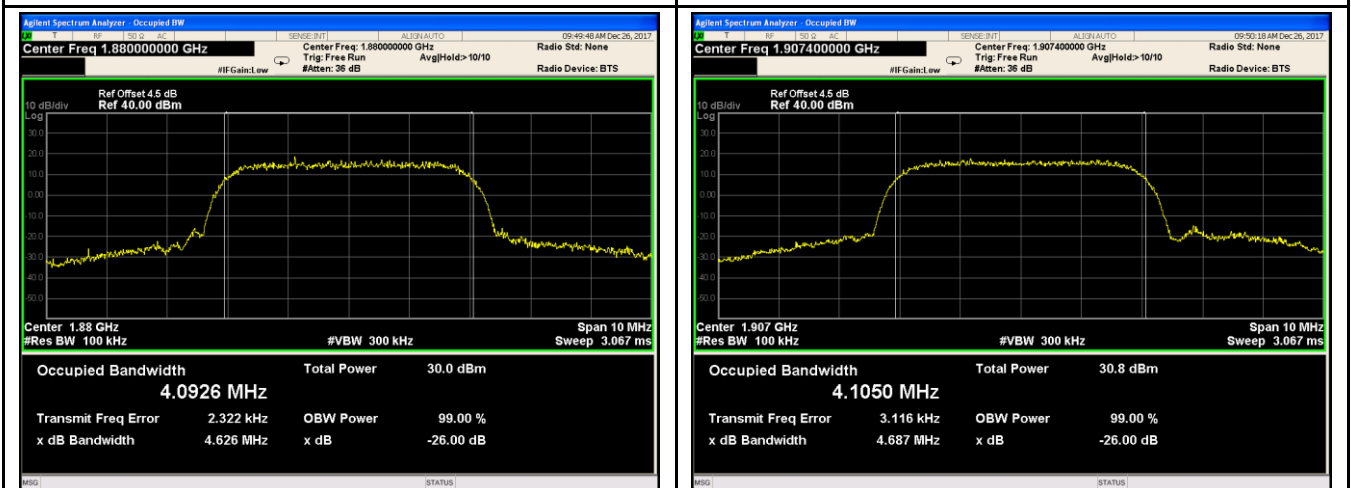

Band II BW - Mid CH 1880MHz

Band II BW - High CH 1907MHz

HSDPA:

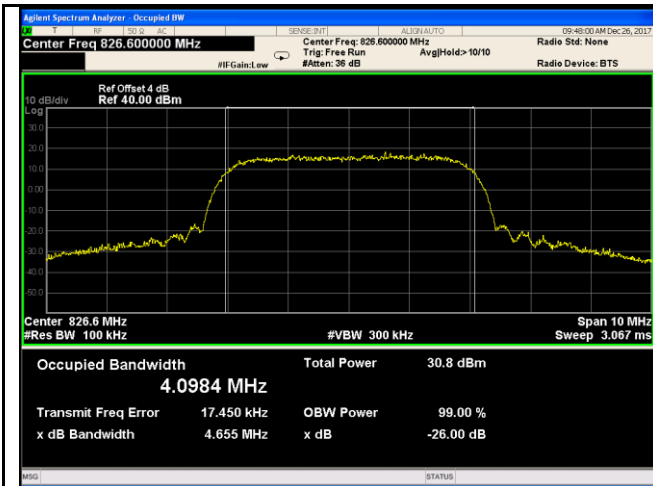

Band V BW - Low CH 826.6 MHz

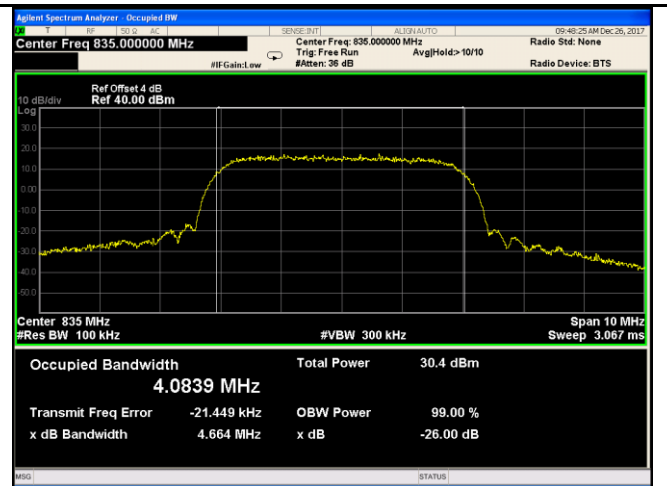

Band V BW - Mid CH 835.0 MHz

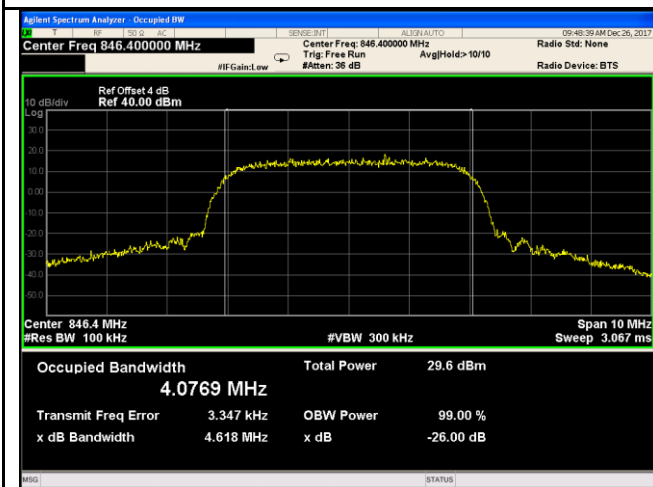

Band V BW - High CH 846.4 MHz

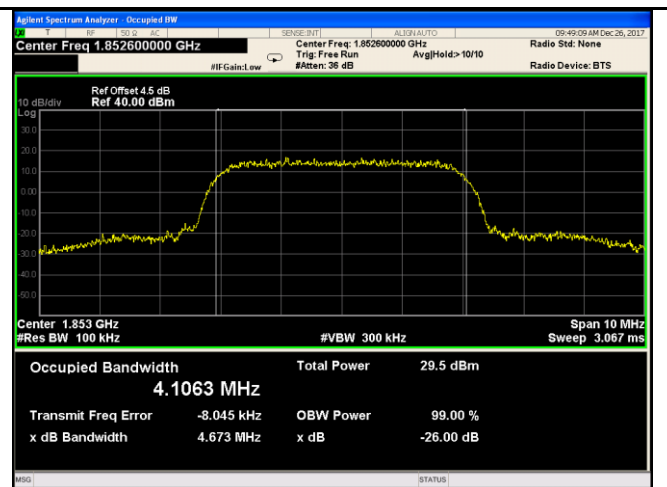

Band II BW - Low CH 1853MHz

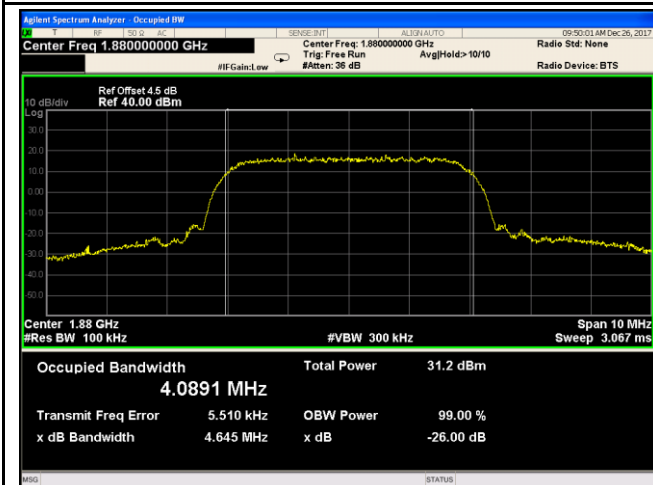

Band II BW - Mid CH 1880MHz

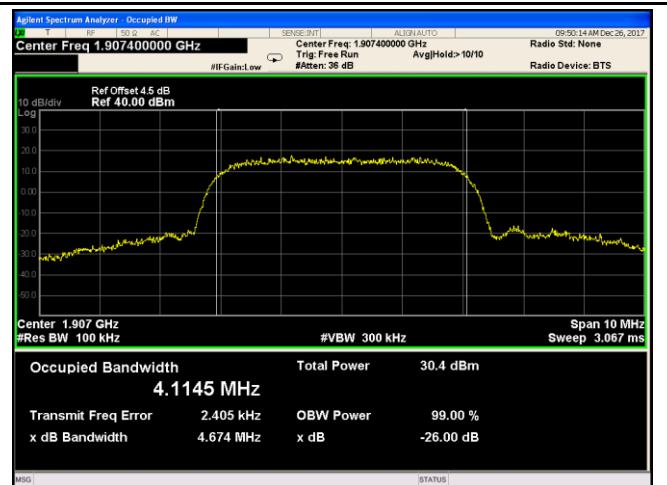

Band II BW - High CH 1907MHz

HSUPA:

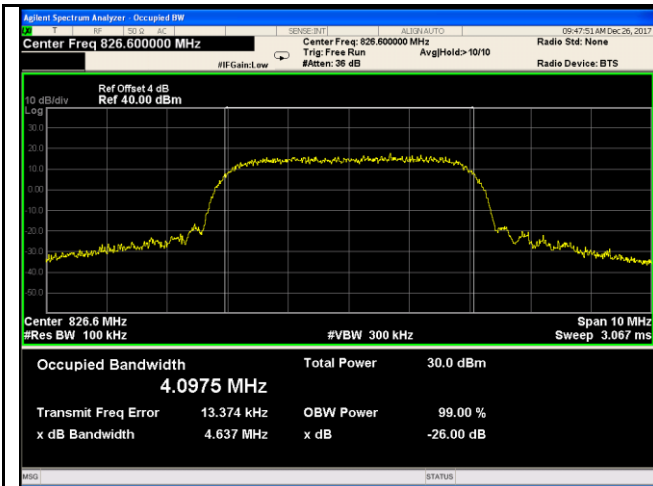

Band V BW - Low CH 826.6 MHz

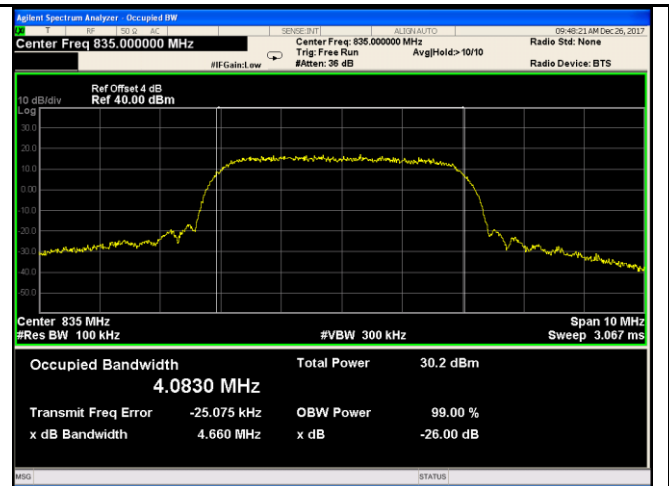

Band V BW - Mid CH 835.0 MHz

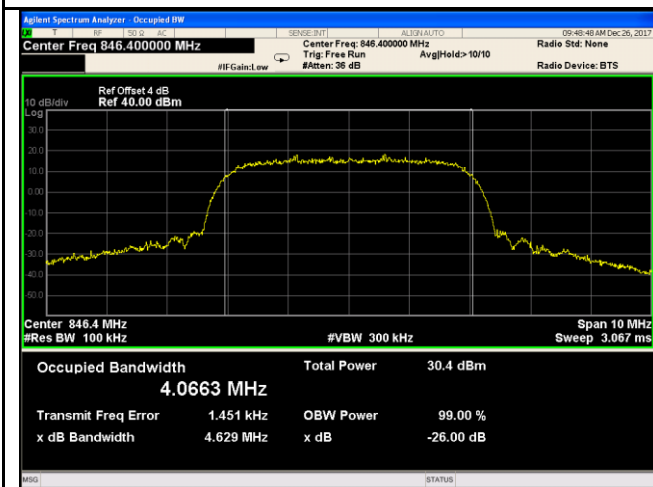

Band V BW - High CH 846.4 MHz

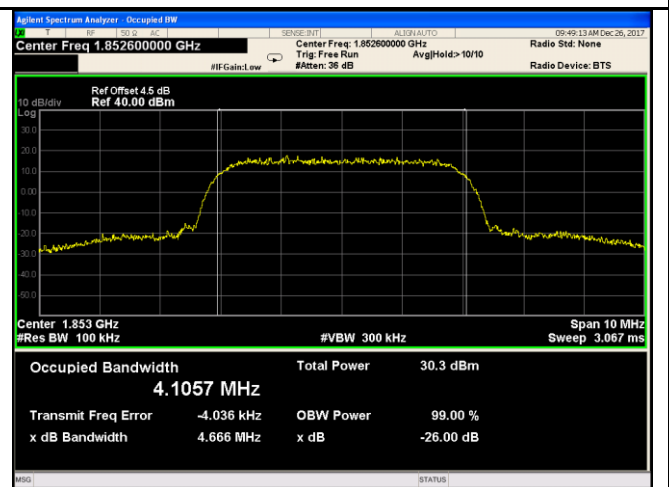

Band II BW - Low CH 1853MHz

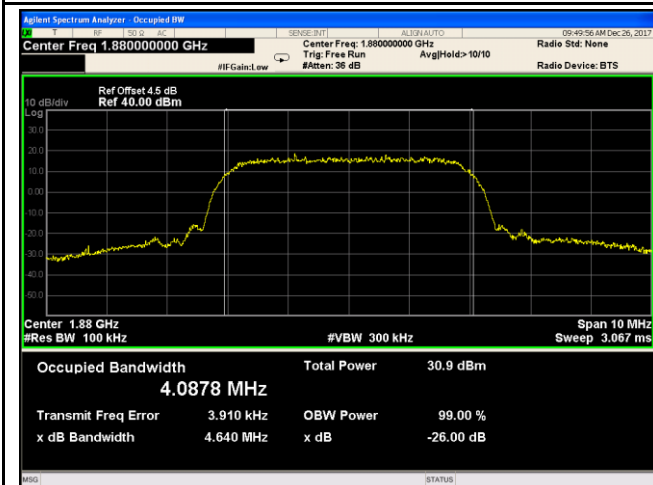

Band II BW - Mid CH 1880MHz

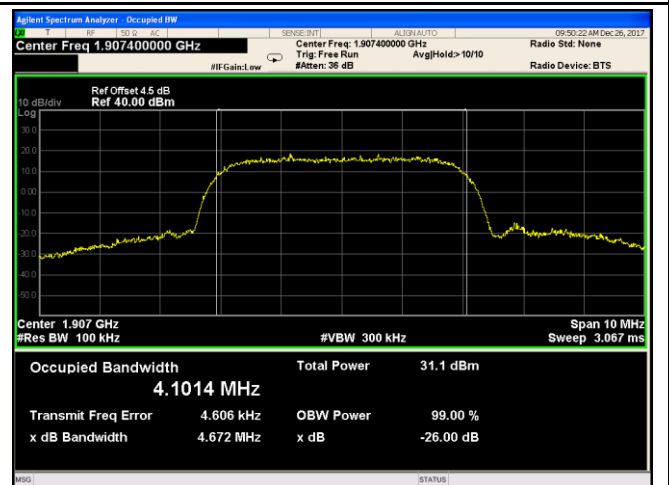

Band II BW - High CH 1907MHz

## 6.5 Spurious Emissions at Antenna Terminals

Temperature	26°C
Relative Humidity	56%
Atmospheric Pressure	1022mbar
Test date :	December 26, 2017
Tested By :	Aaron Liang

### Requirement(s):

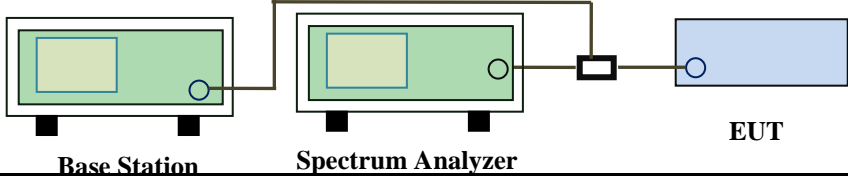
Spec	Item	Requirement	Applicable
§2.1051, §22.917(a)& §24.238(a)	a)	The power of any emission outside of the authorized operating frequency ranges must be lower than the transmitter power (P) by a factor of at least $43 + 10 \log(P)$ dB	<input checked="" type="checkbox"/>
Test Setup	 <p>The diagram shows a Base Station (green box) connected to a Spectrum Analyzer (green box) and an EUT (blue box) via a power divider (black box). The Base Station and Spectrum Analyzer are connected to the power divider, which then splits the signal to the EUT.</p>		
Test Procedure	<ul style="list-style-type: none"> <li>- The EUT was connected to Spectrum Analyzer and Base Station via power divider.</li> <li>- The Band Edges of low and high channels for the highest RF powers were measured.</li> <li>- Setting RBW as roughly BW/100.</li> </ul>		
Remark			
Result	<input checked="" type="checkbox"/> Pass <input type="checkbox"/> Fail		

Test Data     Yes       N/A  
 Test Plot     Yes (See below)       N/A

### Test Plots

#### GSM Voice:

#### Cellular Band (Part 22H) result

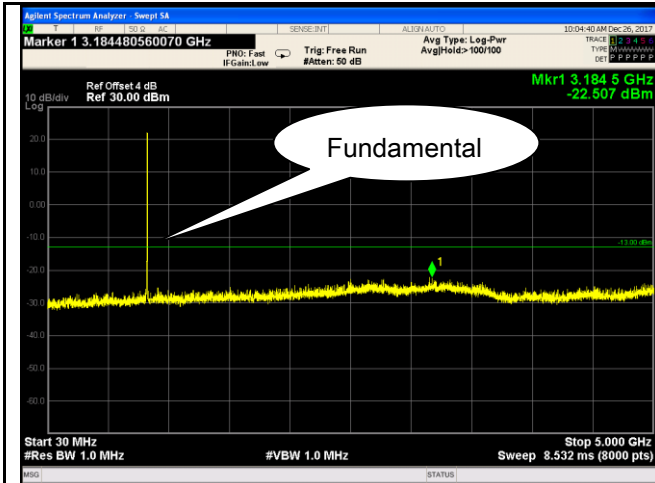

GSM 850 - Low Channel-1

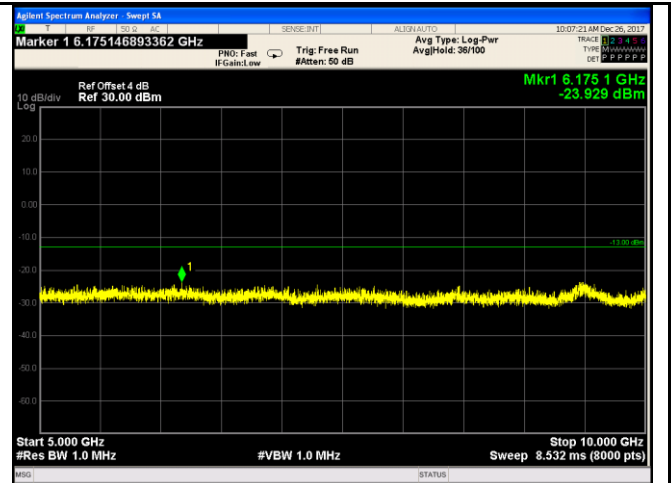

GSM 850 - Low Channel-2

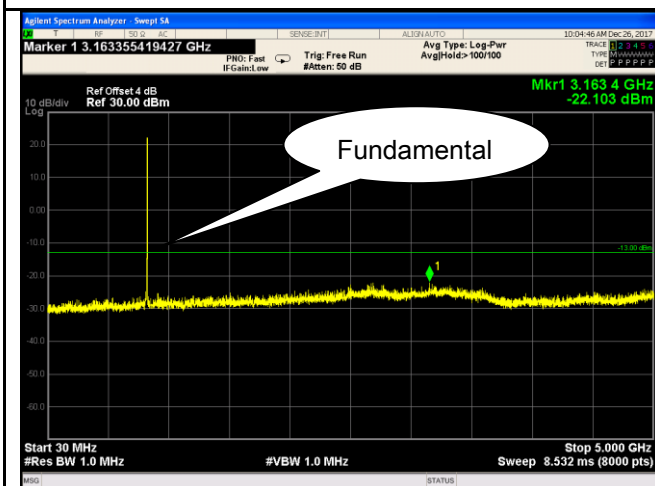

GSM 850 Middle Channel-1

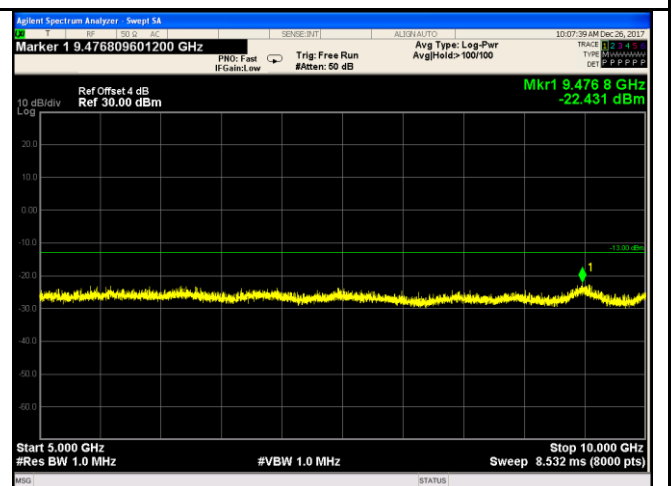

GSM 850 Middle Channel-2

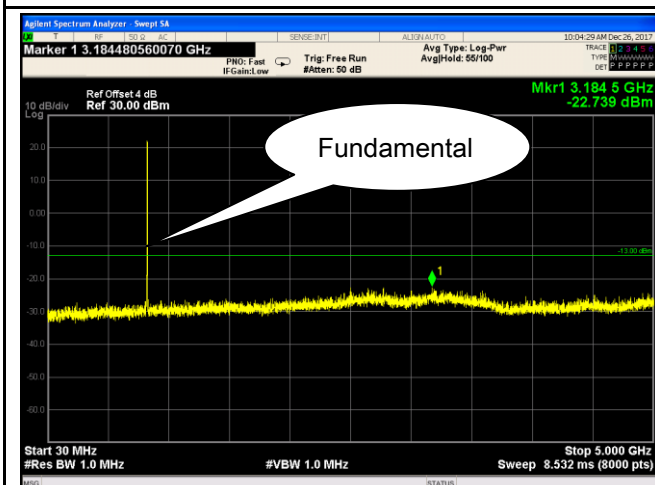

GSM 850 - High Channel-1

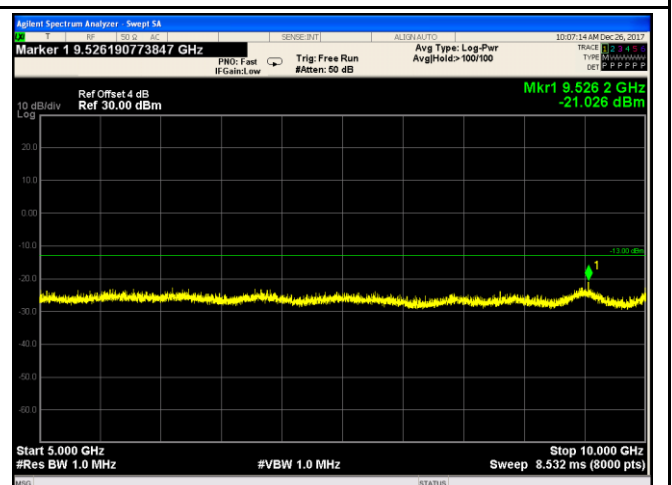

GSM 850 - High Channel-2

### PCS Band (Part24E) result

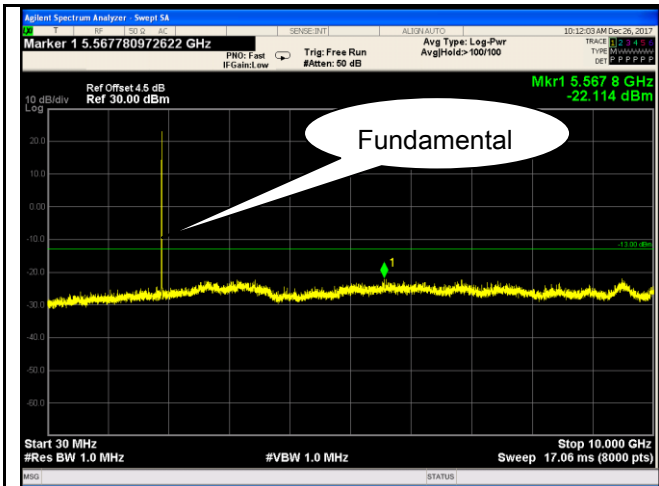

PCS1900 - Low Channel-1

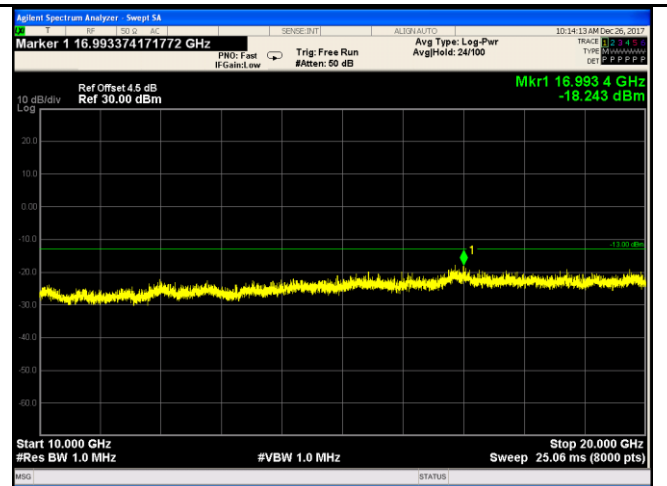

PCS 1900 - Low Channel-2

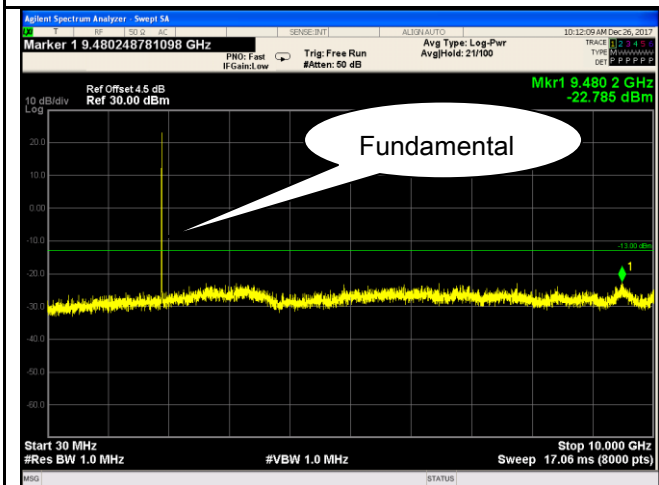

PCS1900 - Middle Channel-1

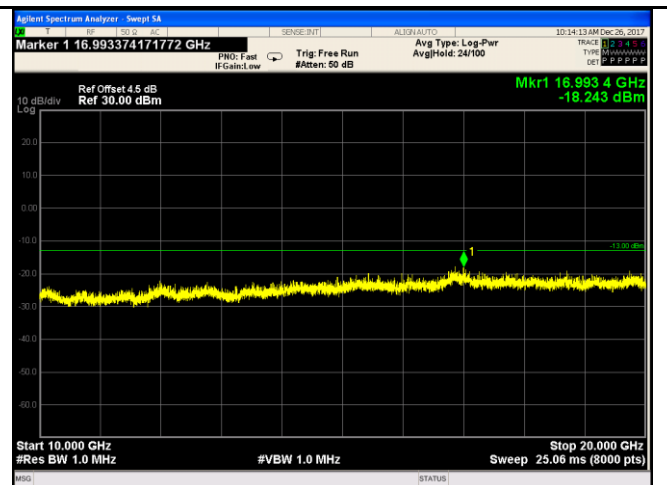

PCS 1900 - Middle Channel-2

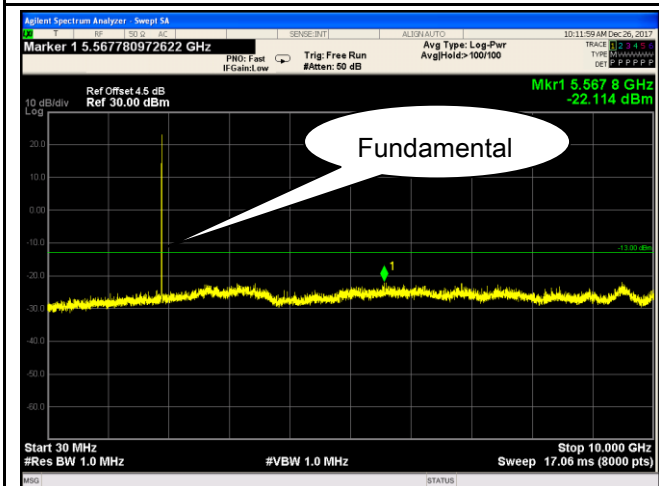

PCS1900 - High Channel-1

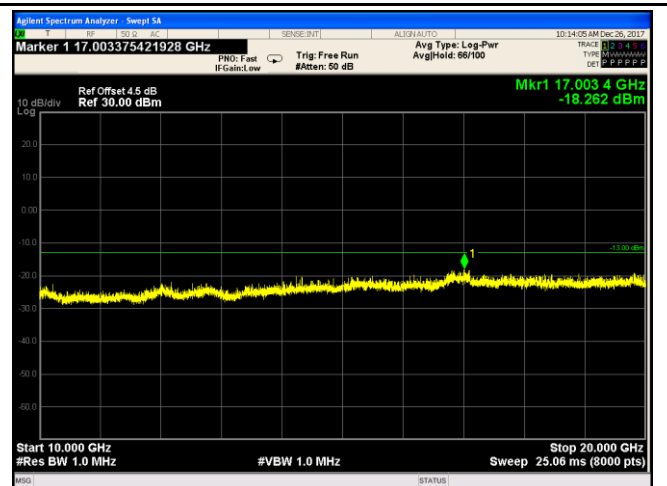

PCS 1900 - High Channel-2

GPRS:

Cellular Band (Part 22H) result

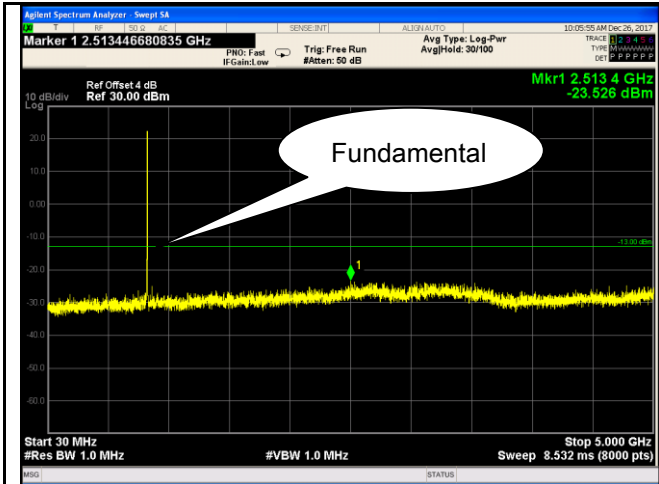

GSM 850 - Low Channel-1

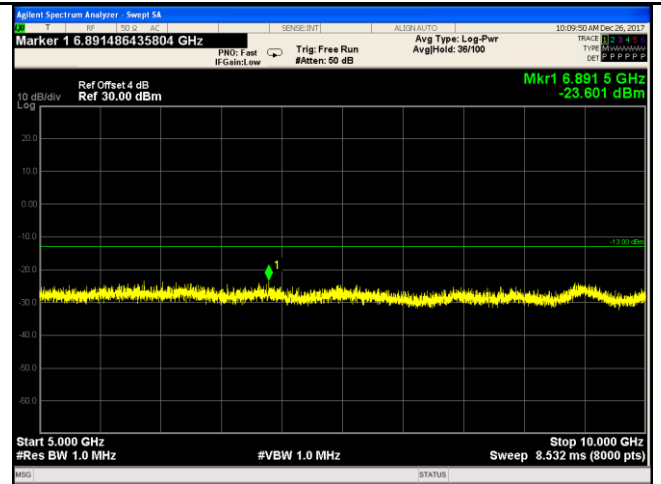

GSM 850 - Low Channel-2

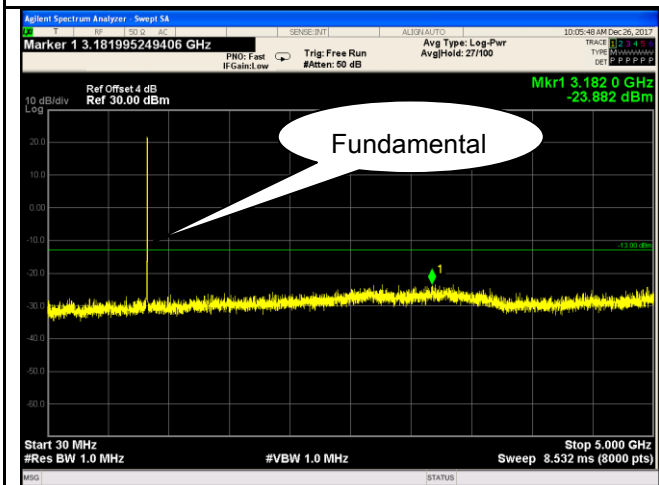

GSM 850 Middle Channel-1

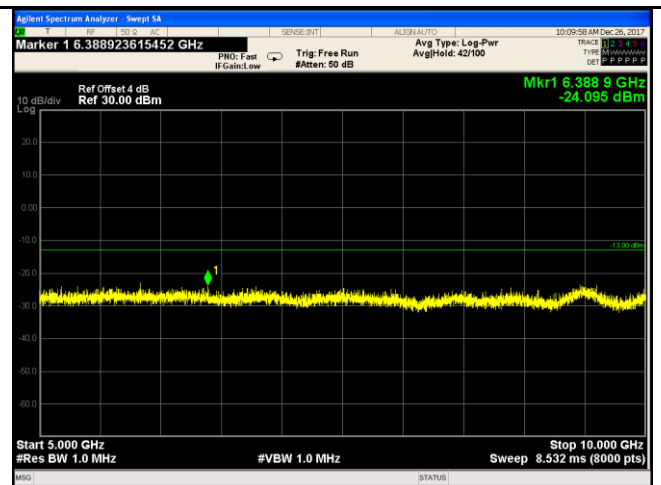

GSM 850 Middle Channel-2

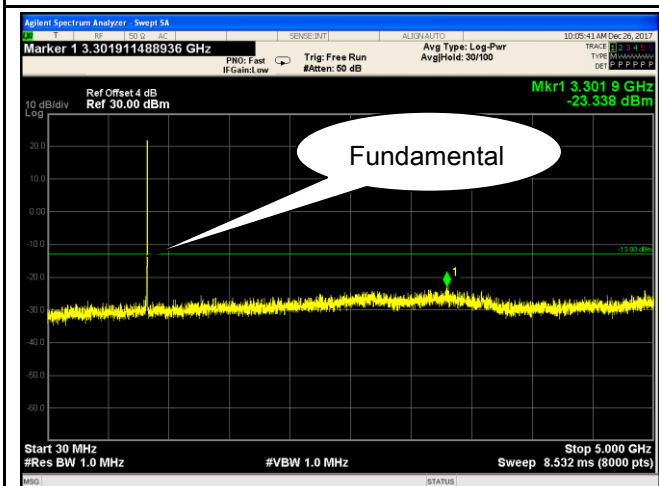

GSM 850 - High Channel-1

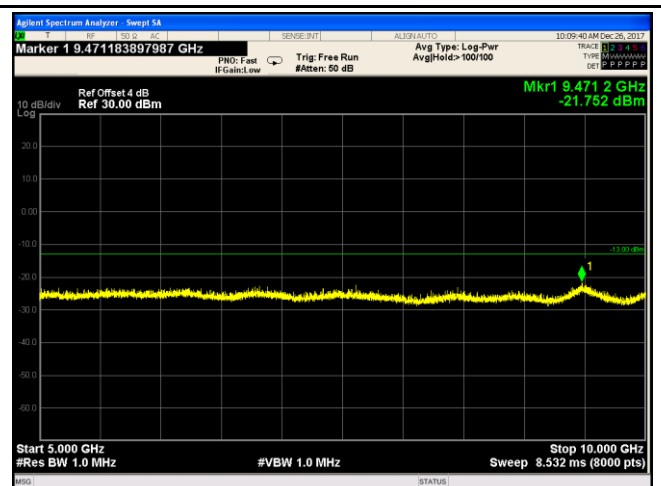

GSM 850 - High Channel-2



PCS Band (Part24E) result

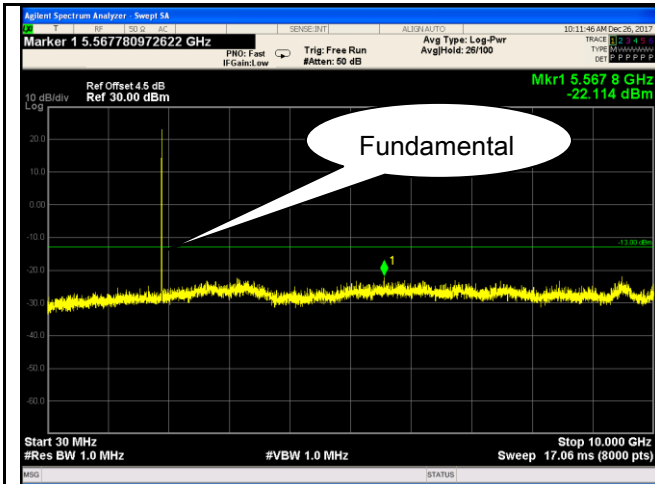

PCS1900 - Low Channel-1

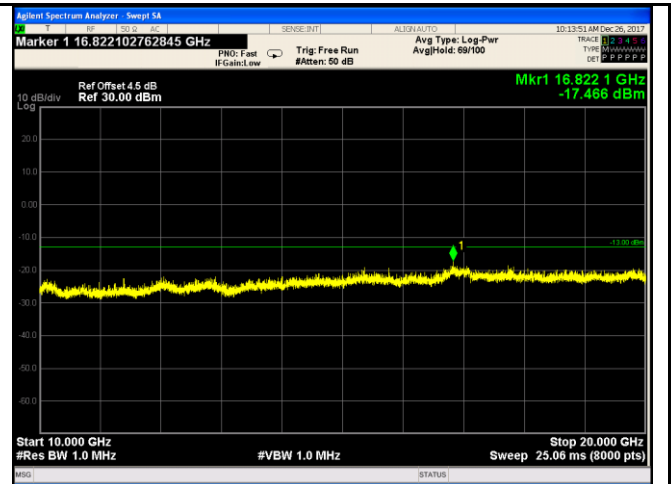

PCS 1900 - Low Channel-2

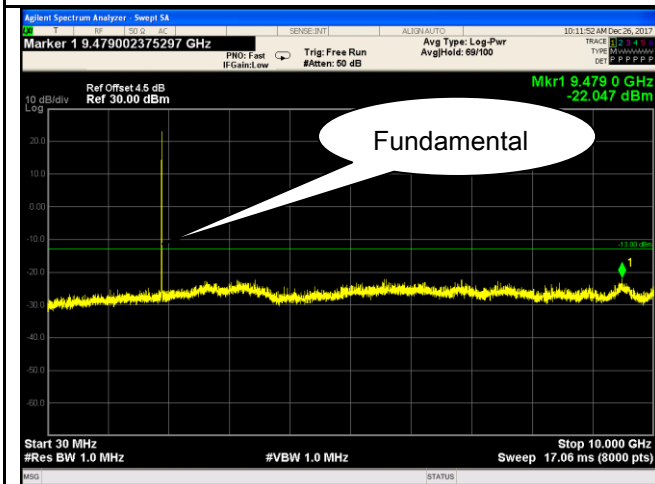

PCS1900 - Middle Channel-1

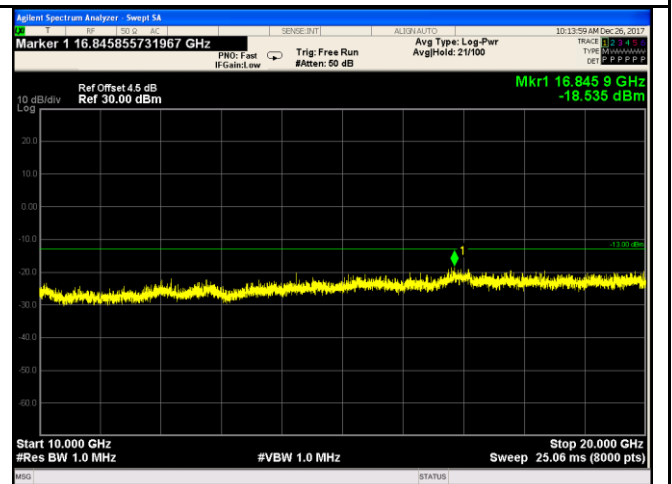

PCS 1900 - Middle Channel-2

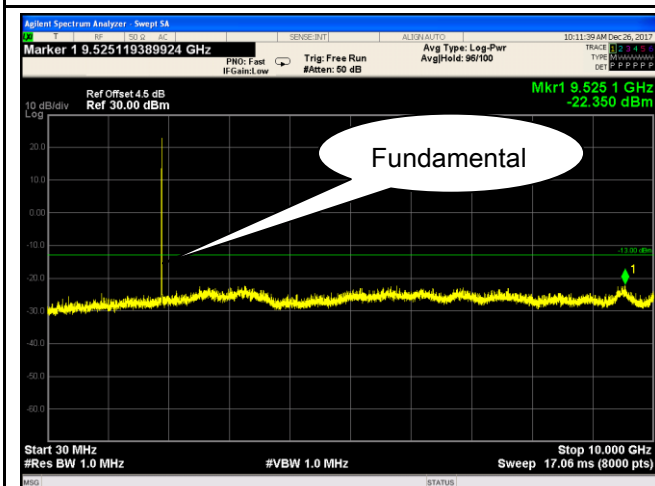

PCS1900 - High Channel-1

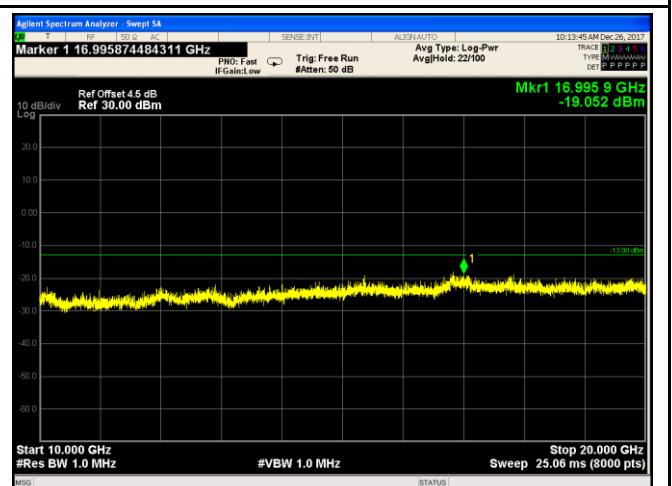

PCS 1900 - High Channel-2

EGPRS (MSC 1):  
Cellular Band (Part 22H) result

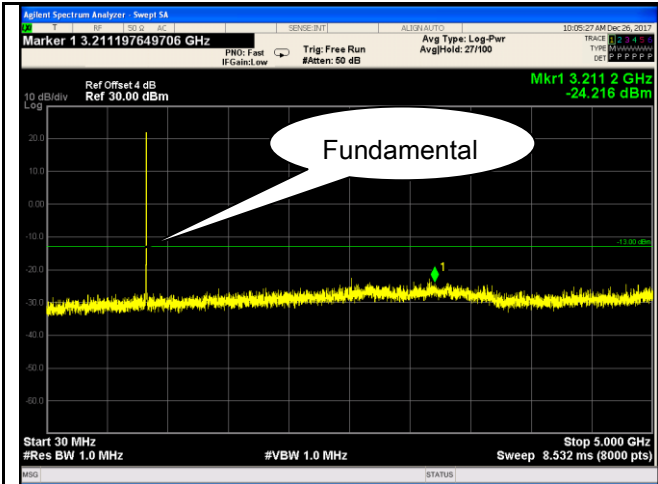

GSM 850 - Low Channel-1

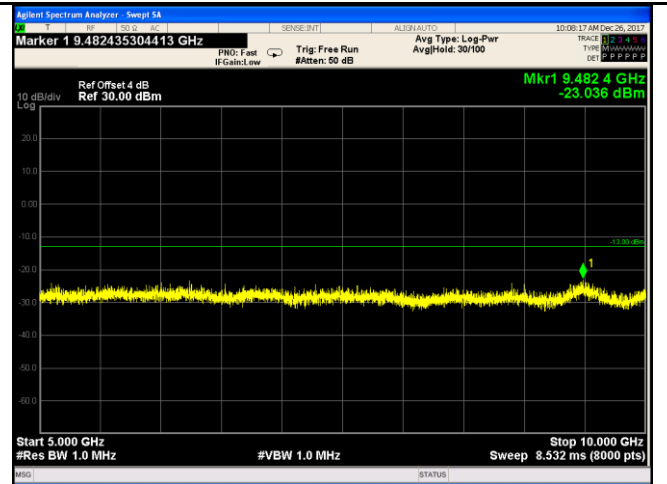

GSM 850 - Low Channel-2

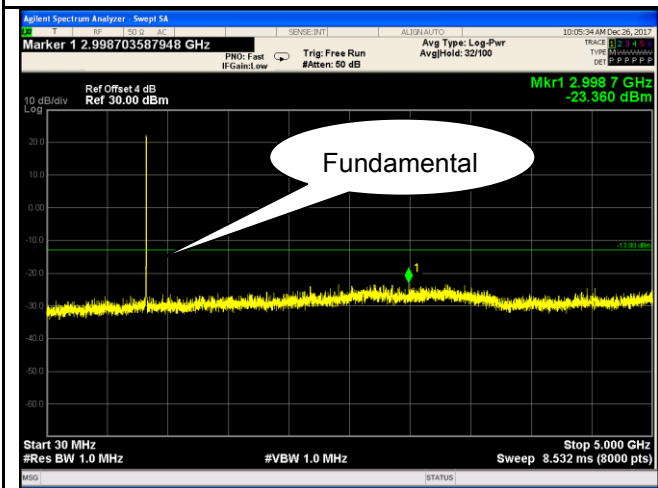

GSM 850 Middle Channel-1

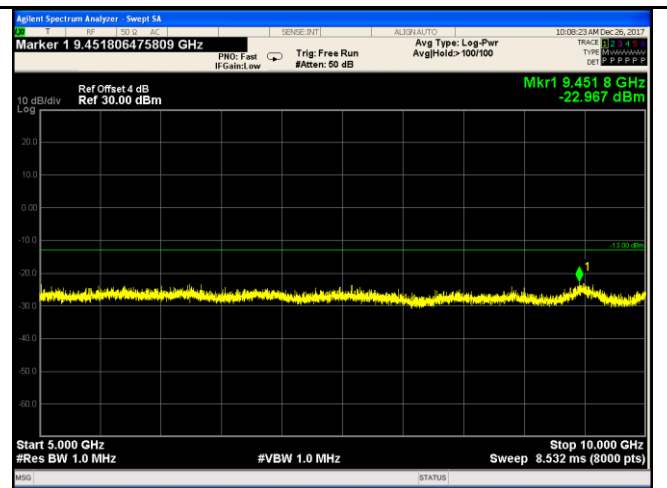

GSM 850 Middle Channel-2

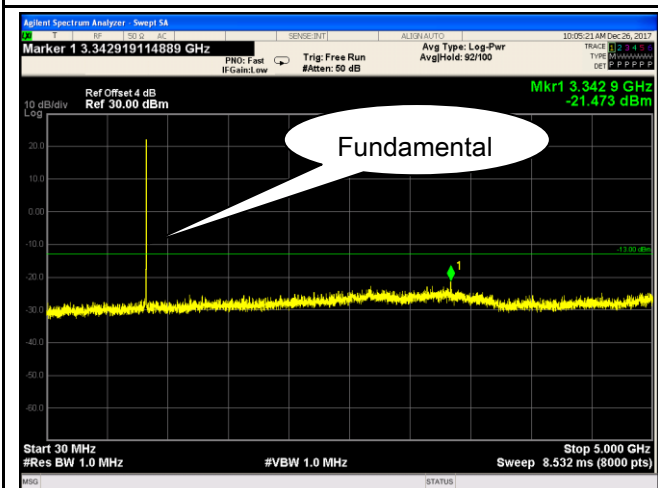

GSM 850 - High Channel-1

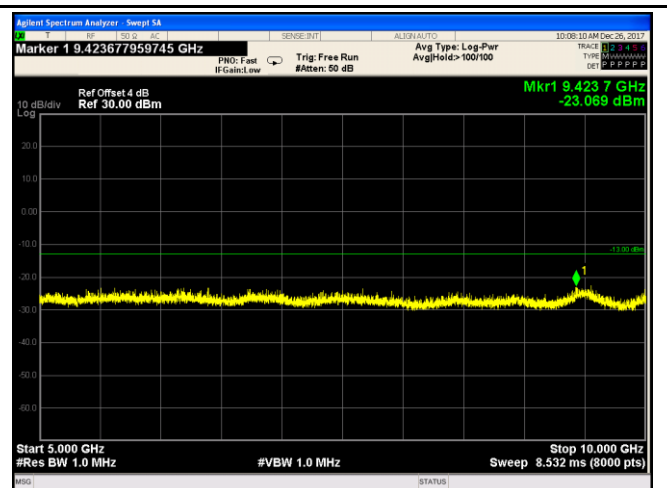

GSM 850 - High Channel-2