



FCC PART 15 B TEST REPORT

For

HONG KONG IPRO TECHNOLOGY CO., LIMITED

FLAT/RM A3, 9/F SILVERCORP INT TOWER 707-713 NATHAN RD MONGKOK, HONGKONG

FCC ID: PQ4IPROV7

Report Type: Original Report	Product Name: Mobile Phone
Test Engineer: Tom Tang	<i>Tom Tang</i>
Report Number: RDG170602002A	
Report Date: 2017-06-19	
Reviewed By: Henry Ding EMC Leader	<i>Henry Ding</i>
Test Laboratory: Bay Area Compliance Laboratories Corp. (Chengdu) No.5040, Huilongwan Plaza, No.1, Shawan Road, Jinniu District, Chengdu, Sichuan, China Tel: 028-65525123, Fax: 028-65525125 www.baclcorp.com	

Note: This test report was prepared for the customer shown above and for the device described herein. It may not be duplicated or used in part without prior written consent from Bay Area Compliance Laboratories Corp. (Chengdu). Any unauthorized alteration, forgery or falsification of the content or appearance of this document is unlawful and offenders may be prosecuted to the fullest extent of the law. This report was valid only with a valid digital signature.

TABLE OF CONTENTS

GENERAL INFORMATION	3
PRODUCT DESCRIPTION FOR EQUIPMENT UNDER TEST (EUT).....	3
OBJECTIVE	3
RELATED SUBMITTAL(S)/GRANT(S).....	3
TEST METHODOLOGY	4
TEST FACILITY.....	4
SYSTEM TEST CONFIGURATION.....	5
DESCRIPTION OF TEST CONFIGURATION	5
EUT EXERCISE SOFTWARE.....	5
EQUIPMENT MODIFICATIONS	5
LOCAL SUPPORT EQUIPMENT LIST AND DETAILS	5
SUPPORT CABLE LIST AND DETAILS.....	5
CONFIGURATION OF TEST SETUP.....	6
SUMMARY OF TEST RESULTS	7
FCC§15.107 - CONDUCTED EMISSIONS	8
EUT SETUP.....	8
EMI TEST RECEIVER SETUP	8
TEST EQUIPMENT LIST AND DETAILS	9
TEST PROCEDURE	9
CORRECTED AMPLITUDE & MARGIN CALCULATION	9
TEST DATA	10
FCC §15.109 - RADIATED SPURIOUS EMISSIONS	13
EUT SETUP.....	13
EMI TEST RECEIVER SETUP	14
TEST PROCEDURE	14
TEST EQUIPMENT LIST AND DETAILS	14
CORRECTED AMPLITUDE & MARGIN CALCULATION	15
TEST DATA	15

GENERAL INFORMATION

Product Description for Equipment Under Test (EUT)

The **HONG KONG IPRO TECHNOLOGY CO.,LIMITED**'s product, model number: **V7 (FCC ID: PQ4IPROV7)** (the "EUT") in this report was a **Mobile Phone**, which was measured approximately: 11.5 cm (L) × 6.4 cm (W) × 1.3 cm (H), rated input voltage: DC3.7V battery or DC5.0V charging from adapter. The highest operation frequency is 2480 MHz.

Adapter information:

Model: NTR-05

Input: 100-240V~ 50/60Hz 150mA

Output: DC5.0V 500mA

**All measurement and test data in this report was gathered from final production sample, serial number: 170602002 (assigned by the BAACL, Chengdu). It may have deviation from any other sample. The EUT supplied by the applicant was received on 2017-05-10, and EUT conformed to test requirement.*

Objective

This test report is prepared on behalf of **HONG KONG IPRO TECHNOLOGY CO.,LIMITED** in accordance with Part 2, Subpart J, and Part 15-Subparts A and B of the Federal Communications Commission's rules.

The objective of the manufacturer is to determine the compliance of EUT with FCC Rules Part 15 B Class B.

Related Submittal(s)/Grant(s)

FCC Part 15C DSS submissions with FCC ID: PQ4IPROV7.

FCC Part 22H, 24E PCE submissions with FCC ID: PQ4IPROV7.

Test Methodology

All measurements contained in this report were conducted with ANSI C63.4-2014, American National Standard for Methods of Measurement of Radio-Noise Emissions from Low-Voltage Electrical and Electronic Equipment in the range of 9 kHz to 40 GHz.

The Bay Area Compliance Laboratories Corp. Chengdu's measurement Uncertainties (calculated for a k=2 Coverage Factor corresponding to approximately 95% Coverage) were as follows:

-For all of the AC Line Conducted Emissions Tests reported herein: ± 3.17 dB.

-For of all of the direct Radiated Emissions Tests reported herein are:

30 MHz to 200 MHz: ± 4.7 dB;

200 MHz to 1 GHz: ± 6.0 dB;

1 GHz to 6 GHz: ± 5.13 dB; and,

6 GHz to 40 GHz: ± 5.47 dB.

And the uncertainty will not be taken into consideration for all test data recorded in the report.

Test Facility

The test site used by BACL to collect test data is located in the No.5040, Huilongwan Plaza, No.1, Shawan Road, Jinniu District, Chengdu, Sichuan, China

Test site at BACL has been fully described in reports submitted to the Federal Communication Commission (FCC). The details of these reports have been found to be in compliance with the requirements of Section 2.948 of the FCC Rules on April 24, 2015. The facility also complies with the radiated and AC line conducted test site criteria set forth in ANSI C63.4-2014.

The Federal Communications Commission has the reports on file and is listed under FCC Registration No.: 560332. The test site has been approved by the FCC for public use and is listed in the FCC Public Access Link (PAL) database.

SYSTEM TEST CONFIGURATION

Description of Test Configuration

The system was configured for testing in a typical fashion (as normally used by a typical user).

EUT Exercise Software

The software "winthrax.exe" was used during test.

Equipment Modifications

No modification was made to the EUT tested.

Local Support Equipment List and Details

Manufacturer	Description	Model	Serial Number
IBM	PC	8176	99Y7315
DELL	Display	E157FPC	060229-11
ANTER	Modem	EGW802	0508350054-1B
Lenovo	Keyboard	KB-US19EB	IMHYX011071016460
Lenovo	Mouse	MO-5013U	IMJS011041409259

Support Cable List and Details

Cable Description	Shielding Type	Ferrite Core	Length (m)	From Port	To
Serial Cable	yes	No	1.6	Serial Port of PC	Modem
Mouse Cable	yes	No	1.4	USB Port of PC	Mouse
Keyboard Cable	yes	No	1.3	USB Port of PC	Keyboard
VGA Cable	yes	Yes	1.5	VGA Port of PC	Display
Earphone Cable	no	no	1.2	EUT	Earphone

Configuration of Test Setup

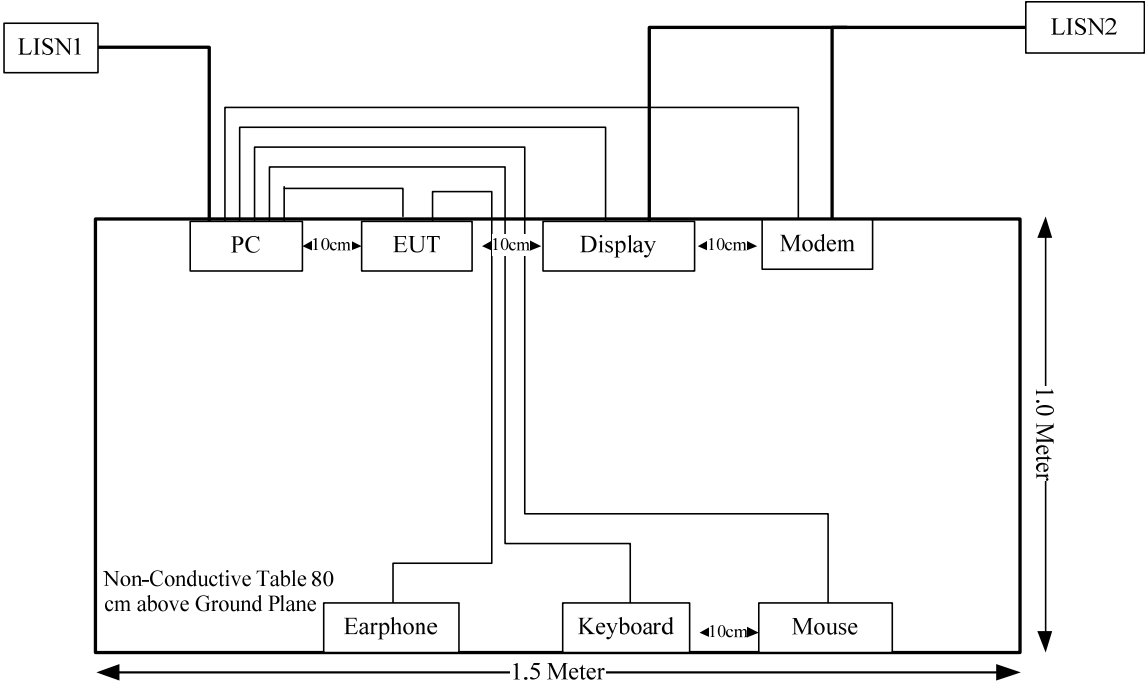

SUMMARY OF TEST RESULTS

FCC Rules	Description of Test	Results
§15.107	Conducted Emissions	Compliance
§15.109	Radiated Emissions	Compliance

FCC§15.107 - CONDUCTED EMISSIONS

EUT Setup

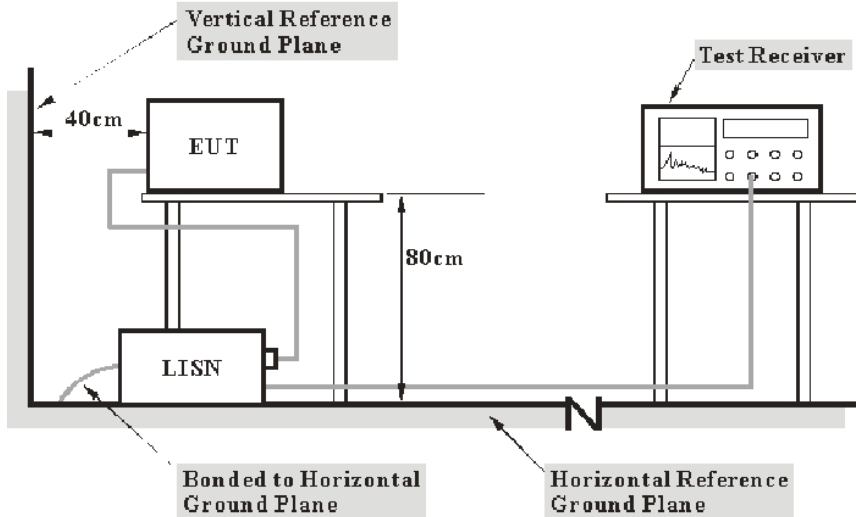

- Note: 1. Support units were connected to second LISN.
2. Both of LISNs (AMN) 80 cm from EUT and at the least 80 cm from other units and other metal planes support units.

The setup of EUT is according with per ANSI C63.4-2014 measurement procedure. The specification used was with the FCC Part 15 B Class B limits.

The external I/O cables were draped along the test table and formed a bundle 30 to 40 cm long in the middle.

The PC was connected to the main LISN with a 120V/60Hz AC power source.

EMI Test Receiver Setup

The EMI test receiver was set to investigate the spectrum from 150 kHz to 30 MHz.

During the conducted emission test, the EMI test receiver was set with the following configurations:

Frequency Range	IF B/W
150 kHz – 30 MHz	9 kHz

Test Equipment List and Details

Manufacturer	Description	Model	Serial Number	Calibration Date	Calibration Due Date
Rohde & Schwarz	EMI Test Receiver	ESCS 30	836858/0016	2016-12-02	2017-12-01
Rohde & Schwarz	L.I.S.N.	ENV216	100018	2016-12-02	2017-12-01
SOLAR ELECTRONICS	L.I.S.N.	9252-50-24 -BNC	984413	2016-12-02	2017-12-01
Rohde & Schwarz	PULSE LIMITER	ESH3Z2	DE14781	2016-10-31	2017-10-30
Unknown	Conducted Cable	Unknown	NO.5	2016-11-10	2017-11-09
R&S	Test Software	EMC32	Version8.53.0	N/A	N/A

* **Statement of Traceability:** BA CL(Chengdu) attests that all of the calibrations on the equipment items listed above were traceable to NIM or to another internationally recognized National Metrology Institute (NMI), and were compliant with the NIST HB 150-2016 Normative Annex B "Implementation of traceability policy in accredited laboratories".

Test Procedure

During the conducted emission test, the PC was connected to the outlet of the first LISN and the other support equipments were connected to the outlet of the second LISN.

Maximizing procedure was performed on the six (6) highest emissions of the EUT.

All data was recorded in the Quasi-peak and average detection mode.

Corrected Amplitude & Margin Calculation

The basic equation is as follows:

$$V_C = V_R + A_C + VDF$$

Herein,

V_C : corrected voltage amplitude

V_R : reading voltage amplitude

A_C : attenuation caused by cable loss

VDF : voltage division factor of AMN or ISN

The “**Margin**” column of the following data tables indicates the degree of compliance within the applicable limit. For example, a margin of 7dB means the emission is 7dB below the maximum limit. The equation for margin calculation is as follows:

$$\text{Margin} = \text{Limit} - \text{Corrected Amplitude}$$

Test Data

Environmental Conditions

Temperature:	26.3 °C
Relative Humidity:	64.8 %
ATM Pressure:	100.1 kPa

The testing was performed by Tom Tang on 2017-06-15.

Test Mode: Downloading

AC120V, 60Hz, Line:

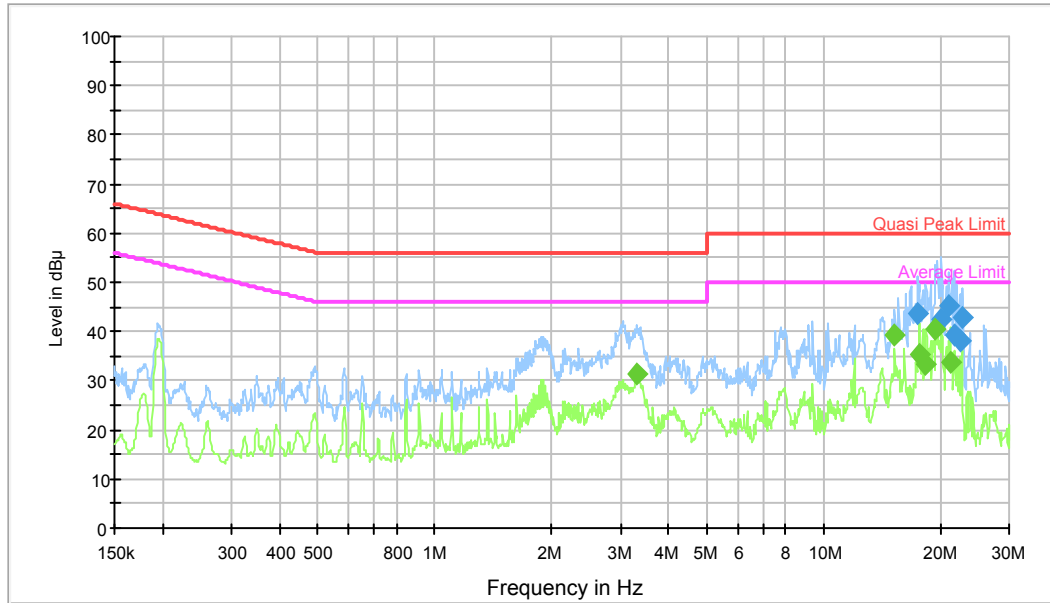

Frequency (MHz)	QuasiPeak (dBμV)	Bandwidth (kHz)	Line	Corr. (dB)	Margin (dB)	Limit (dBμV)	Comment
17.415803	43.5	9.000	L1	20.1	16.5	60.0	Compliance
20.107458	42.3	9.000	L1	20.1	17.7	60.0	Compliance
21.010095	45.2	9.000	L1	20.1	14.8	60.0	Compliance
21.605484	39.2	9.000	L1	20.2	20.8	60.0	Compliance
22.395843	38.2	9.000	L1	20.2	21.8	60.0	Compliance
22.847357	43.0	9.000	L1	20.2	17.0	60.0	Compliance

Frequency (MHz)	Average (dBμV)	Bandwidth (kHz)	Line	Corr. (dB)	Margin (dB)	Limit (dBμV)	Comment
3.322406	31.5	9.000	L1	19.9	14.5	46.0	Compliance
15.266201	39.4	9.000	L1	20.1	10.6	50.0	Compliance
17.625630	35.3	9.000	L1	20.1	14.7	50.0	Compliance
18.343482	33.4	9.000	L1	20.1	16.6	50.0	Compliance
19.397857	40.4	9.000	L1	20.1	9.6	50.0	Compliance
21.178511	33.7	9.000	L1	20.1	16.3	50.0	Compliance

AC120V, 60Hz, Neutral:

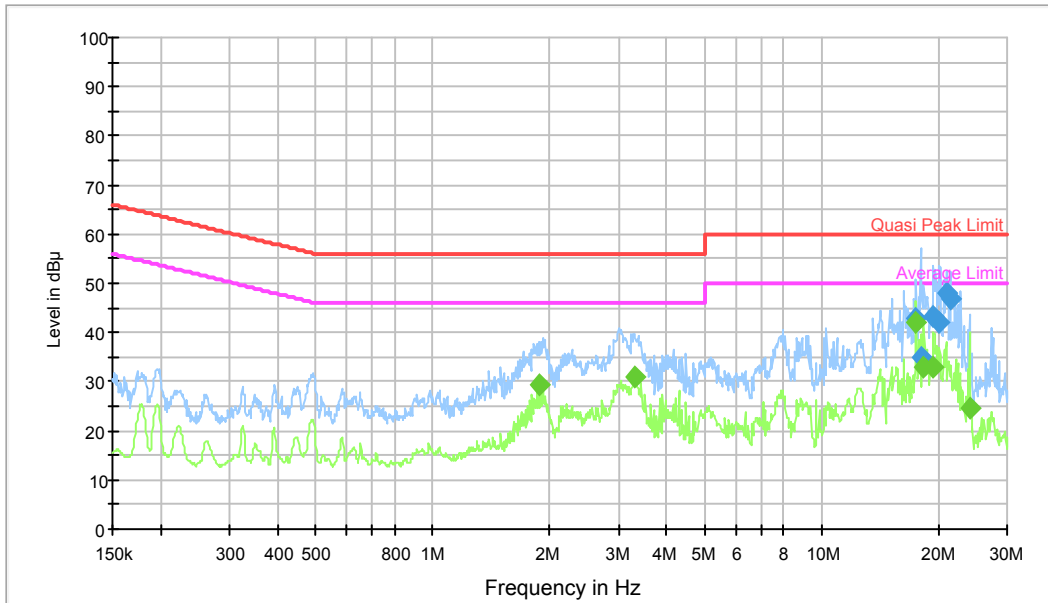

Frequency (MHz)	QuasiPeak (dBμV)	Bandwidth (kHz)	Line	Corr. (dB)	Margin (dB)	Limit (dBμV)	Comment
17.485466	42.8	9.000	N	19.9	17.2	60.0	Compliance
17.980974	35.0	9.000	N	19.9	25.0	60.0	Compliance
19.397857	43.3	9.000	N	19.9	16.7	60.0	Compliance
20.107458	41.9	9.000	N	19.9	18.1	60.0	Compliance
21.010095	47.8	9.000	N	19.9	12.2	60.0	Compliance
21.348278	46.8	9.000	N	20.0	13.2	60.0	Compliance

Frequency (MHz)	Average (dBμV)	Bandwidth (kHz)	Line	Corr. (dB)	Margin (dB)	Limit (dBμV)	Comment
1.877292	29.3	9.000	N	19.6	16.7	46.0	Compliance
3.322406	30.9	9.000	N	19.6	15.1	46.0	Compliance
17.485466	42.0	9.000	N	19.9	8.0	50.0	Compliance
18.343482	32.9	9.000	N	19.9	17.1	50.0	Compliance
19.397857	32.8	9.000	N	19.9	17.2	50.0	Compliance
23.968482	24.6	9.000	N	20.0	25.4	50.0	Compliance

FCC §15.109 - RADIATED SPURIOUS EMISSIONS

EUT Setup

Below 1GHz:

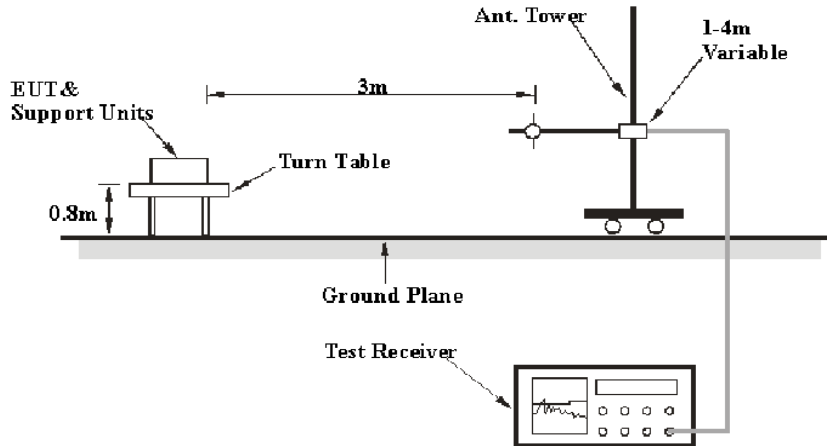

Above 1GHz:

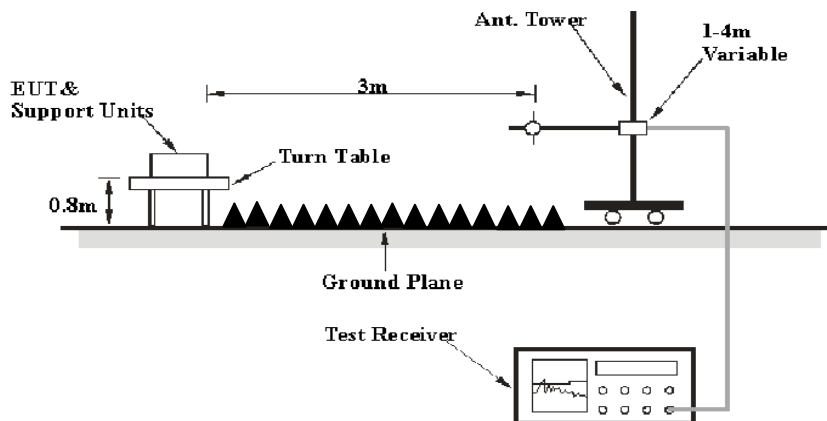

The radiated emission tests were performed at the 3 meters chamber test site, using the setup accordance with the ANSI C63.4-2014. The specification used was the FCC Part 15.109 Class B limits.

EMI Test Receiver Setup

The system was investigated from 30 MHz to 13 GHz.

During the radiated emission test, the EMI test receiver was set with the following configurations:

Frequency Range	RBW	Video B/W	IF B/W	Detector
30 MHz – 1000 MHz	120 kHz	300 kHz	120 kHz	QP
Above 1 GHz	1 MHz	3 MHz	/	Peak
	1 MHz	10 Hz	/	AVG

Test Procedure

During the radiated emissions, the PC was connected to the first AC floor outlet and the other support equipments were connected to the second AC floor outlet.

Maximizing procedure was performed on the highest emissions to ensure that the EUT complied with all installation combinations.

The data was recorded in the Quasi-peak detection mode for below 1 GHz, peak and average detection mode above 1 GHz.

Test Equipment List and Details

Manufacturer	Description	Model	Serial Number	Calibration Date	Calibration Due Date
Agilent	Amplifier	8447D	2944A10442	2016-12-02	2017-12-01
Rohde & Schwarz	EMI Test Receiver	ESCI	100028	2016-12-02	2017-12-01
Sunol Sciences	Broadband Antenna	JB3	A121808	2016-04-10	2019-04-09
Rohde & Schwarz	Spectrum Analyzer	FSEM30	100018	2016-12-02	2017-12-01
ETS	Horn Antenna	3115	003-6076	2016-12-02	2017-12-01
Mini-circuits	Amplifier	ZVA-183-S+	771001215	2017-05-20	2018-05-19
EMCT	Semi-Anechoic Chamber	966	966-1	2015-04-24	2018-04-23
Unknown	RF Cable (below 1GHz)	Unknown	NO.1	2016-11-10	2017-11-09
Unknown	RF Cable (below 1GHz)	Unknown	NO.4	2016-11-10	2017-11-09
Unknown	RF Cable (above 1GHz)	Unknown	NO.2	2016-11-10	2017-11-09

* **Statement of Traceability:** BAAC(Chengdu) attests that all of the calibrations on the equipment items listed above were traceable to NIM or to another internationally recognized National Metrology Institute (NMI), and were compliant with the NIST HB 150-2016 Normative Annex B "Implementation of traceability policy in accredited laboratories".

Corrected Amplitude & Margin Calculation

The Corrected Amplitude is calculated by adding the Antenna Factor and Cable Loss, and subtracting the Amplifier Gain from the Meter Reading. The basic equation is as follows:

$$\text{Corrected Amplitude} = \text{Meter Reading} + \text{Antenna Factor} + \text{Cable Loss} - \text{Amplifier Gain}$$

The “**Margin**” column of the following data tables indicates the degree of compliance with the applicable limit. For example, a margin of 7 dB means the emission is 7 dB below the limit. The equation for margin calculation is as follows:

$$\text{Margin} = \text{Limit} - \text{Corrected Amplitude}$$

Test Data

Environmental Conditions

Temperature:	27.4 °C
Relative Humidity:	62 %
ATM Pressure:	100.1 kPa

** The testing was performed by Tom Tang on 2017-06-16.*

Test Result: Compliance

Test Mode: Downloading

1) Below 1GHz:

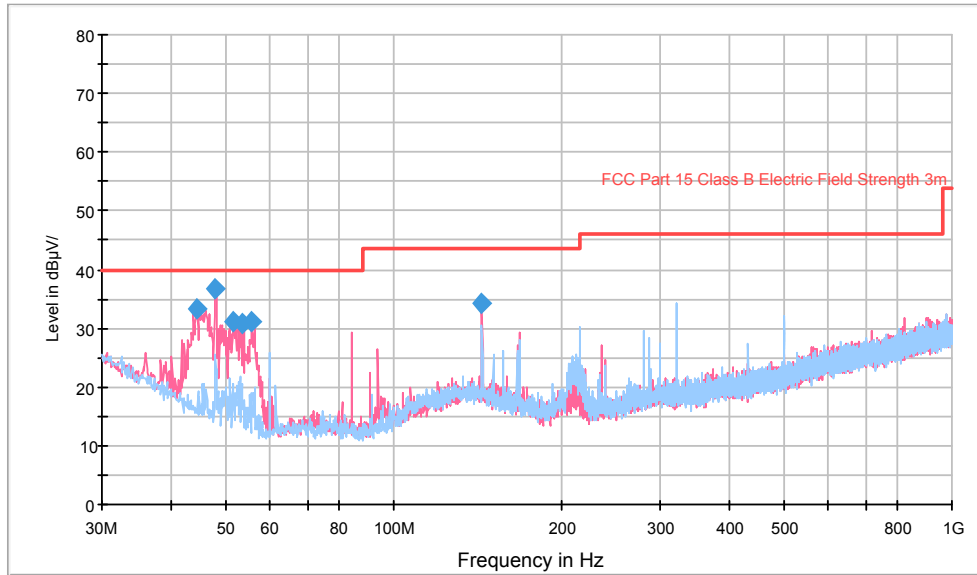

Frequency (MHz)	QuasiPeak (dBµV/m)	Height (cm)	Polarization	Azimuth (deg)	Corr. (dB)	Margin (dB)	Limit (dBµV/m)
44.428750	33.3	150.0	V	32.0	-9.8	6.7	40.0
47.945000	36.8	150.0	V	89.0	-11.8	3.2	40.0
51.582500	31.2	150.0	V	100.0	-13.1	8.8	40.0
53.643750	30.8	150.0	V	32.0	-13.2	9.2	40.0
55.705000	31.0	150.0	V	10.0	-13.4	9.0	40.0
143.975000	34.1	150.0	V	52.0	-6.6	9.4	43.5

2) Above 1GHz:

Frequency (MHz)	Receiver		Rx Antenna		Cable loss (dB)	Amplifier Gain (dB)	Corrected Amplitude (dBµV/m)	Limit (dBµV/m)	Margin (dB)
	Reading (dBµV)	Detector	Polar (H/V)	Factor (dB)					
1325	37.69	PK	H	24.58	2.43	26.50	38.20	74.00	35.80
1325	24.36	AV	H	24.58	2.43	26.50	24.87	54.00	29.13
2407	36.85	PK	H	28.72	3.00	26.88	41.69	74.00	32.31
2407	23.71	AV	H	28.72	3.00	26.88	28.55	54.00	25.45
3525	37.83	PK	H	31.85	4.22	26.59	47.31	74.00	26.69
3525	22.26	AV	H	31.85	4.22	26.59	31.74	54.00	22.26
1108	38.34	PK	V	24.06	2.13	26.71	37.82	74.00	36.18
1108	24.96	AV	V	24.06	2.13	26.71	24.44	54.00	29.56
1325	39.92	PK	V	24.58	2.43	26.50	40.43	74.00	33.57
1325	37.01	AV	V	24.58	2.43	26.50	37.52	54.00	16.48
1793	36.85	PK	V	26.47	2.89	26.62	39.59	74.00	34.41
1793	24.36	AV	V	26.47	2.89	26.62	27.10	54.00	26.90

***** END OF REPORT *****