

# HONG KONG IPRO TECHNOLOGY CO., LIMITED

## Smart Mobile Phone

**Main Model: V6**  
**Serial Model: N/A**



**June 30, 2014**

**Report No.: 14070280-FCC-R3**  
**(This report supersedes none)**

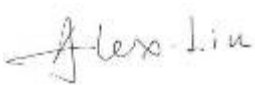

**Modifications made to the product : None**

**This Test Report is Issued Under the Authority of:**

		
<b>Hank Li</b> Compliance Engineer	<b>Alex Liu</b> Technical Manager	

**This test report may be reproduced in full only.**  
**Test result presented in this test report is applicable to the representative sample only.**

**SIEMIC, INC.**  
Accessing the  
**RF Test Report**

To: FCC Part 15.247: 2013, ANSI C63.4: 2009

## Laboratory Introduction

SIEMIC, headquartered in the heart of Silicon Valley, with superior facilities in US and Asia, is one of the leading independent testing and certification facilities providing customers with one-stop shop services for Compliance Testing and Global Certifications.



In addition to [testing](#) and [certification](#), SIEMIC provides initial design reviews and [compliance management](#) through out a project. Our extensive experience with [China](#), [Asia Pacific](#), [North America](#), [European](#), and [international](#) compliance requirements, assures the fastest, most cost effective way to attain regulatory compliance for the [global markets](#).

**SIEMIC (Shenzhen - China) Laboratories Accreditations for Conformity Assessment**

Country/Region	Scope
USA	EMC , RF/Wireless , Telecom
Canada	EMC, RF/Wireless , Telecom
Taiwan	EMC, RF, Telecom , Safety
Hong Kong	RF/Wireless ,Telecom
Australia	EMC, RF, Telecom , Safety
Korea	EMI, EMS, RF , Telecom, Safety
Japan	EMI, RF/Wireless, Telecom
Singapore	EMC , RF , Telecom
Europe	EMC, RF, Telecom , Safety



**SIEMIC, INC.**

Accessing global markets

Title: RF Test Report for Smart Mobile Phone  
Main Model: V6  
Serial Model: N/A  
To: FCC Part 15.247: 2013, ANSI C63.4: 2009

Report No.: 14070280-FCC-R3  
Issue Date: June 30, 2014  
Page: 3 of 72  
[www.siemic.com](http://www.siemic.com)  
[www.siemic.com.cn](http://www.siemic.com.cn)

This page has been left blank intentionally.

# CONTENTS

<b>1</b>	<b>EXECUTIVE SUMMARY &amp; EUT INFORMATION .....</b>	<b>5</b>
<b>2</b>	<b>TECHNICAL DETAILS .....</b>	<b>6</b>
<b>3</b>	<b>MODIFICATION.....</b>	<b>7</b>
<b>4</b>	<b>TEST SUMMARY.....</b>	<b>8</b>
<b>5</b>	<b>MEASUREMENTS, EXAMINATION AND DERIVED RESULTS .....</b>	<b>9</b>
	<b>ANNEX A. TEST INSTRUMENT &amp; METHOD .....</b>	<b>51</b>
	<b>ANNEX B. EUT AND TEST SETUP PHOTOGRAPHS .....</b>	<b>54</b>
	<b>ANNEX C. TEST SETUP AND SUPPORTING EQUIPMENT.....</b>	<b>67</b>
	<b>ANNEX D. USER MANUAL / BLOCK DIAGRAM / SCHEMATICS / PART LIST .....</b>	<b>71</b>
	<b>ANNEX E. DECLARATION OF SIMILARITY .....</b>	<b>72</b>

# 1 EXECUTIVE SUMMARY & EUT INFORMATION

The purpose of this test programme was to demonstrate compliance of the HONG KONG IPRO TECHNOLOGY CO., LIMITED, Smart Mobile Phone and model: V6 against the current Stipulated Standards. The Smart Mobile Phone has demonstrated compliance with the FCC Part 15.247: 2013, ANSI C63.4: 2009.

## EUT Information

**EUT Description** : Smart Mobile Phone

**Main Model** : V6

**Serial Model** : N/A

**Antenna Gain** : **GSM850/PCS1900: 1 dBi**  
**UMTS-FDD Band V/ UMTS-FDD Band II: 0.5 dBi**  
**Bluetooth/BLE: 0dBi**  
**WIFI: 0 dBi**

**Input Power** : **Battery:**  
**Model: V6**  
**Spec: 3.7V 2300mAh**  
**Limited charger voltage: 4.2V**  
**Adapter:**  
**Model: NTR-S01**  
**Input: AC 100-240V; 50/60Hz 150mA**  
**Output: DC 5.0V; 700mA**

**Classification Per Stipulated Test Standard** : **FCC Part 15.247: 2013, ANSI C63.4: 2009**

## 2 TECHNICAL DETAILS

<b>Purpose</b>	Compliance testing of Smart Mobile Phone with stipulated standard
<b>Applicant / Client</b>	HONG KONG IPRO TECHNOLOGY CO., LIMITED FLAT/RM A3, 9/F SILVERCORP INT TOWER 707-713 NATHAN RD MONGKOK, HONGKONG
<b>Manufacturer</b>	SHENZHEN ZHIKE COMMUNICATION CO., LTD 8th Floor, B Bldg. Dianzi Fuhua Jidi, Taojindi, Longsheng community, Longhua District, Shenzhen, China
<b>Laboratory performing the tests</b>	SIEMIC Shenzhen (Shenzhen - China) Laboratories Zone A, Floor 1, Building 2, Wan Ye Long Technology Park, South Side of Zhoushi Road, Bao'an District, Shenzhen, Guangdong, China Tel: +86-0755-2601 4629 / 2601 4953 Fax: +86-0755-2601 4953-810 Email: China@siemic.com.cn
<b>Test report reference number</b>	14070280-FCC-R3
<b>Date EUT received</b>	June 03, 2014
<b>Standard applied</b>	FCC Part 15.247: 2013, ANSI C63.4: 2009
<b>Dates of test (from – to)</b>	June 04 to June 30, 2014
<b>No of Units :</b>	#1
<b>Equipment Category :</b>	DTS
<b>Trade Name :</b>	IPRO
<b>RF Operating Frequency (ies)</b>	GSM850 TX : 824.2 ~ 848.8 MHz; RX : 869.2 ~ 893.8 MHz PCS1900 TX : 1850.2 ~ 1909.8 MHz; RX : 1930.2 ~ 1989.8 MHz UMTS-FDD Band V TX : 826.4 ~ 846.6 MHz; RX : 871.4 ~ 891.6 MHz UMTS-FDD Band II TX : 1852.4 ~ 1907.6 MHz; RX : 1932.4 ~ 1987.6 MHz 802.11b/g/n: 2412-2462 MHz Bluetooth& BLE: 2402-2480 MHz
<b>Number of Channels</b>	299CH (PCS1900) and 124CH (GSM850) UMTS-FDD Band V : 102CH UMTS-FDD Band II : 277CH Bluetooth: 79CH 802.11b/g/n: 11CH BLE: 40CH
<b>Modulation</b>	GSM / GPRS: GMSK UMTS-FDD: QPSK 802.11b/g/n: DSSS/OFDM Bluetooth: GFSK& $\pi/4$ DQPSK&8DPSK BLE: GFSK
<b>GPRS Multi-slot class</b>	8/10/12
<b>FCC ID</b>	PQ4IPROV6



**SIEMIC, INC.**

Accessing global markets

Title: RF Test Report for Smart Mobile Phone  
Main Model: V6  
Serial Model: N/A  
To: FCC Part 15.247: 2013, ANSI C63.4: 2009

Report No.: 14070280-FCC-R3  
Issue Date: June 30, 2014  
Page: 7 of 72  
[www.siemic.com](http://www.siemic.com)  
[www.siemic.com.cn](http://www.siemic.com.cn)

### **3 MODIFICATION**

**NONE**

## 4 TEST SUMMARY

The product was tested in accordance with the following specifications.  
 All testing has been performed according to below product classification:

### Test Results Summary

FCC Rules	Description of Test	Result
§15.247 (i), §2.1093	RF Exposure	Compliance
§15.203	Antenna Requirement	Compliance
§15.247 (a)(2)	DTS (6 dB&20 dB) CHANNEL BANDWIDTH	Compliance
§15.247(b)(3)	Conducted Maximum Output Power	Compliance
§15.247(e)	Power Spectral Density	Compliance
§15.247(d)	Band-Edge & Unwanted Emissions into Non-Restricted Frequency Bands	Compliance
§15.207 (a),	AC Power Line Conducted Emissions	Compliance
§15.205, §15.209, §15.247(d)	Radiated Spurious Emissions & Unwanted Emissions into Restricted Frequency Bands	Compliance



# 5 MEASUREMENTS, EXAMINATION AND DERIVED RESULTS

## 5.1 §15.247 (i) and §2.1093 – RF Exposure

**Standard Requirement:**

According to §15.247 (i) and §1.1307(b)(1), systems operating under the provisions of this section shall be operated in a manner that ensures that the public is not exposed to radio frequency energy level in excess of the Commission’s guidelines.

The 1-g and 10-g SAR test exclusion thresholds for 100 MHz to 6 GHz at *test separation distances* ≤ 50 mm are determined by:

$$[(\text{max. power of channel, including tune-up tolerance, mW}) / (\text{min. test separation distance, mm})] \cdot [\sqrt{f_{\text{GHz}}}] \leq 3.0 \text{ for 1-g SAR and } \leq 7.5 \text{ for 10-g extremity SAR,}^{16} \text{ where}$$

- $f_{\text{GHz}}$  is the RF channel transmit frequency in GHz
- Power and distance are rounded to the nearest mW and mm before calculation<sup>17</sup>
- The result is rounded to one decimal place for comparison

The test exclusions are applicable only when the minimum *test separation distance* is ≤ 50 mm and for transmission frequencies between 100 MHz and 6 GHz. When the minimum *test separation distance* is < 5 mm, a distance of 5 mm is applied to determine SAR test exclusion.

Routine SAR evaluation refers to that specifically required by § 2.1093, using measurements or computer simulation. When routine SAR evaluation is not required, portable transmitters with output power greater than the applicable low threshold require SAR evaluation to qualify for TCB approval.

Two antennas are available for the EUT (GSM antenna, Bluetooth/WIFI/BLE antenna).  
 The maximum average output power(turn-up power) in low channel of WIFI is 9.26 dBm= 8.43 mW  
 The calculation results=  $8.43 / 5 * \sqrt{2.412} = 2.62 < 3$

The maximum average output power(turn-up power) in middle channel of WIFI is 9.42 dBm= 8.75 mW  
 The calculation results=  $8.75 / 5 * \sqrt{2.437} = 2.73 < 3$

The maximum average output power(turn-up power) in high channel of WIFI is 9.31dBm= 8.53 mW  
 The calculation results=  $8.53 / 5 * \sqrt{2.462} = 2.68 < 3$

According to KDB 447498, no stand-alone required for WIFI antenna, and no simultaneous SAR measurement is required , please refer to SAR report.

**Test Result: Pass**

## **5.2 §15.203 - ANTENNA REQUIREMENT**

### **Applicable Standard**

According to § 15.203, an intentional radiator shall be designed to ensure that no antenna other than that furnished by the responsible party shall be used with the device. The use of a permanently attached antenna or of an antenna that uses a unique coupling to the intentional radiator shall be considered sufficient to comply with the provisions of this section. The manufacturer may design the unit so that a broken antenna can be replaced by the user, but the user of a standard antenna jack or electrical connector is prohibited. The structure and application of the EUT were analyzed to determine compliance with section §15.203 of the rules. §15.203 state that the subject device must meet the following criteria:

- a. Antenna must be permanently attached to the unit.
- b. Antenna must use a unique type of connector to attach to the EUT.

Unit must be professionally installed, and installer shall be responsible for verifying that the correct antenna is employed with the unit.

And according to FCC 47 CFR section 15.247 (b), if the transmitting antennas of directional gain greater than 6dBi are used, the power shall be reduced by the amount in dB that the directional gain of the antenna exceeds 6 dBi.

### **Antenna Connector Construction**

The EUT has 2 antennas: a PIFA antenna for WIFI/Bluetooth/BLE, the gain is 0 dBi for WIFI/ Bluetooth/ BLE.

a PIFA antenna for GSM and UMTS, the gain is 1 dBi for GSM850/ PCS1900 and 0.5 dBi for UMTS-FDD Band V/UMTS-FDD Band II .

which in accordance to section 15.203, please refer to the internal photos.

**Test Result: Pass**

### **5.3 §15.247(a) (2) –DTS (6 dB&20 dB) CHANNEL BANDWIDTH**

1. Conducted Measurement  
EUT was set for low, mid, high channel with modulated mode and highest RF output power.  
The spectrum analyzer was connected to the antenna terminal.
2. Environmental Conditions
 

Temperature	24°C
Relative Humidity	59%
Atmospheric Pressure	1010mbar
3. Conducted Emissions Measurement Uncertainty  
All test measurements carried out are traceable to national standards. The uncertainty of the measurement at a confidence level of approximately 95% (in the case where distributions are normal), with a coverage factor of 2, in the range 30MHz – 40GHz is ±1.5dB.
4. Test date : June 05, 2014  
Tested By : Hank Li

**Requirement(s):** The minimum 6 dB bandwidth of a DTS transmission shall be at least 500 kHz. Within this document, this bandwidth is referred to as the DTS bandwidth. The procedures provided herein for measuring the maximum peak conducted output power assume the use of the DTS bandwidth.

**Procedures:**

**6dB bandwidth**

- a) Set RBW = 100 kHz.
- b) Set the video bandwidth (VBW)  $\geq 3 \times$  RBW.
- c) Detector = Peak.
- d) Trace mode = max hold.
- e) Sweep = auto couple.
- f) Allow the trace to stabilize.
- g) Measure the maximum width of the emission that is constrained by the frequencies associated with the two outermost amplitude points (upper and lower frequencies) that are attenuated by 6 dB relative to the maximum level measured in the fundamental emission.

**20dB bandwidth**

**C63.10**

**Occupied Bandwidth (OBW=20dB bandwidth)**

1. Set RBW = 1%-5% OBW.
2. Set the video bandwidth (VBW)  $\geq 3 \times$  RBW.
3. Set the span range between 2 times and 5 times of the OBW.
4. Sweep time=Auto, Detector=PK, Trace=Max hold.
5. Once the reference level is established, the equipment is conditioned with typical modulating signals to produce the worst-case (i.e., the widest) bandwidth. Unless otherwise specified for an unlicensed wireless device, measure the bandwidth at the -20 dB levels with respect to the reference level.

**Test Result: Pass.**

Please refer to the following tables and plots.

**Note:**

B: 802.11b

G: 802.11g

N20: 802.11n

1: Low Channel

6: Middle Channel

11: High Channel



**SIEMIC, INC.**

Accessing global markets

Title: RF Test Report for Smart Mobile Phone  
Main Model: V6  
Serial Model: N/A  
To: FCC Part 15.247: 2013, ANSI C63.4: 2009

Report No.: 14070280-FCC-R3  
Issue Date: June 30, 2014  
Page: 12 of 72  
www.siemic.com  
www.siemic.com.cn

**6dB& 20dB bandwidth:**

Channel	Channel Frequency (MHz)	Data Rate (Mbps)	Measured 6dB Bandwidth (MHz)	Measured 20dB Bandwidth (MHz)	FCC Part 15.247 Limit (kHz)
<b>802.11b mode</b>					
Low	2412	1	9.567	14.127	>500
Middle	2437	1	9.586	14.161	>500
High	2462	1	9.595	14.157	>500
<b>802.11g mode</b>					
Low	2412	6	15.623	17.603	>500
Middle	2437	6	15.797	17.648	>500
High	2462	6	15.637	17.625	>500
<b>802.11n(20M) mode</b>					
Low	2412	MCS0	16.449	18.431	>500
Middle	2437	MCS0	16.580	18.626	>500
High	2462	MCS0	16.444	18.551	>500



**SIEMIC, INC.**

Accessing global markets

Title: RF Test Report for Smart Mobile Phone  
Main Model: V6  
Serial Model: N/A  
To: FCC Part 15.247: 2013, ANSI C63.4: 2009

Report No.: 14070280-FCC-R3  
Issue Date: June 30, 2014  
Page: 13 of 72  
www.siemec.com  
www.siemec.com.cn

**The 6dB bandwidth:**

Agilent 00:09:15 Jun 5, 2014 R T

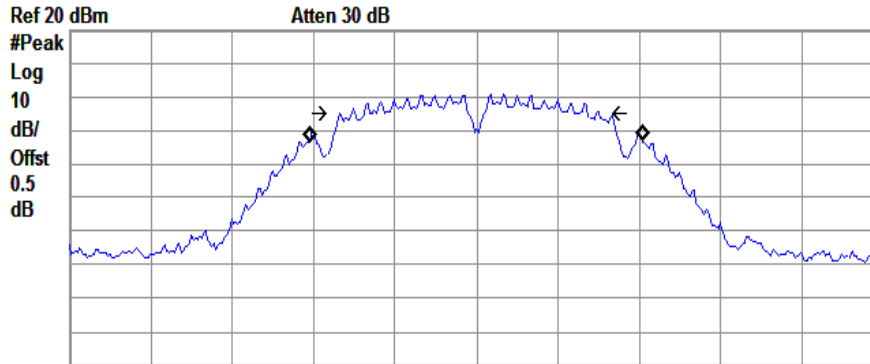

Center 2.412 GHz Span 30 MHz  
#Res BW 100 kHz #VBW 300 kHz Sweep 4 ms (401 pts)

**Occupied Bandwidth**  
12.3062 MHz

Occ BW % Pwr 99.00 %  
x dB -6.00 dB

Transmit Freq Error -28.487 kHz  
x dB Bandwidth 9.567 MHz



B-1 6dB

Agilent 00:08:04 Jun 5, 2014 R T

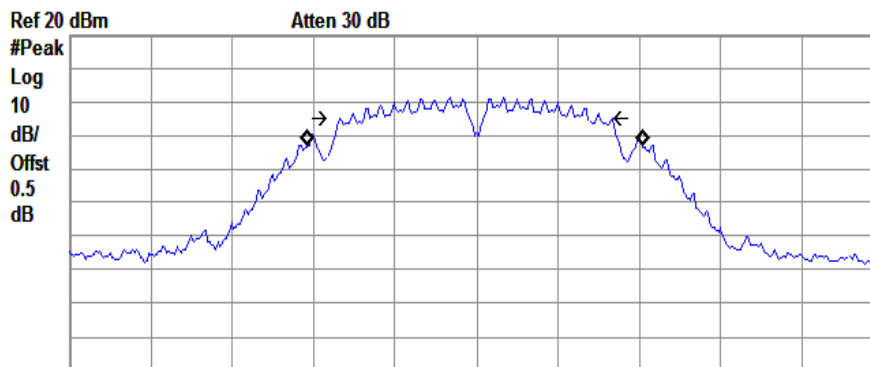

Center 2.437 GHz Span 30 MHz  
#Res BW 100 kHz #VBW 300 kHz Sweep 4 ms (401 pts)

**Occupied Bandwidth**  
12.3178 MHz

Occ BW % Pwr 99.00 %  
x dB -6.00 dB

Transmit Freq Error -31.429 kHz  
x dB Bandwidth 9.586 MHz



B-6 6dB



**SIEMIC, INC.**

Accessing global markets

Title: RF Test Report for Smart Mobile Phone  
Main Model: V6  
Serial Model: N/A  
To: FCC Part 15.247: 2013, ANSI C63.4: 2009

Report No.: 14070280-FCC-R3  
Issue Date: June 30, 2014  
Page: 14 of 72  
www.siemec.com  
www.siemec.com.cn

Agilent 00:10:00 Jun 5, 2014 R T

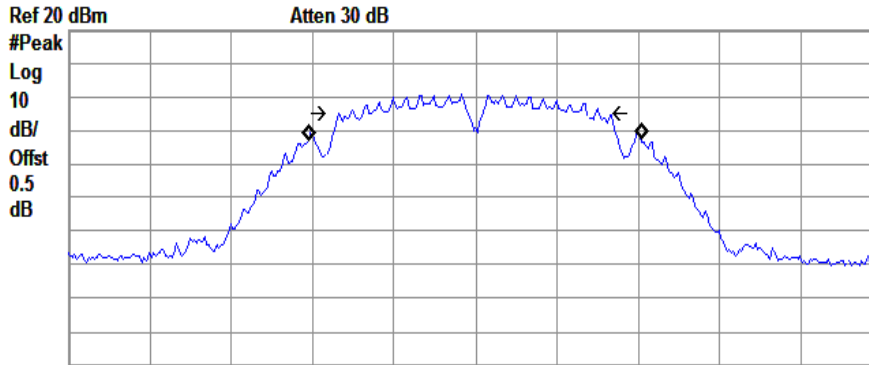

Center 2.462 GHz Span 30 MHz  
#Res BW 100 kHz #VBW 300 kHz Sweep 4 ms (401 pts)

<b>Occupied Bandwidth</b>	Occ BW % Pwr	99.00 %
12.2822 MHz	x dB	-6.00 dB

Transmit Freq Error -21.328 kHz  
x dB Bandwidth 9.595 MHz



B-11 6dB

Agilent 00:32:05 Jun 5, 2014 R T

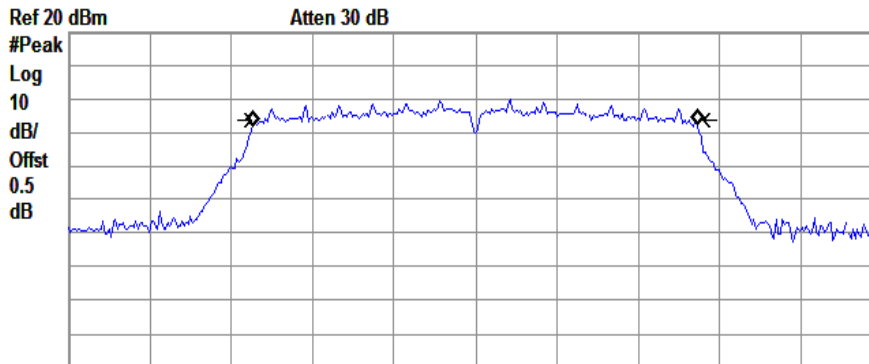

Center 2.412 GHz Span 30 MHz  
#Res BW 100 kHz #VBW 300 kHz Sweep 4 ms (401 pts)

<b>Occupied Bandwidth</b>	Occ BW % Pwr	99.00 %
16.3624 MHz	x dB	-6.00 dB

Transmit Freq Error -11.012 kHz  
x dB Bandwidth 15.623 MHz



G-1 6dB



# SIEMIC, INC.

Accessing global markets

Title: RF Test Report for Smart Mobile Phone  
Main Model: V6  
Serial Model: N/A  
To: FCC Part 15.247: 2013, ANSI C63.4: 2009

Report No.: 14070280-FCC-R3  
Issue Date: June 30, 2014  
Page: 15 of 72  
www.siemec.com  
www.siemec.com.cn

Agilent 00:32:45 Jun 5, 2014 R T

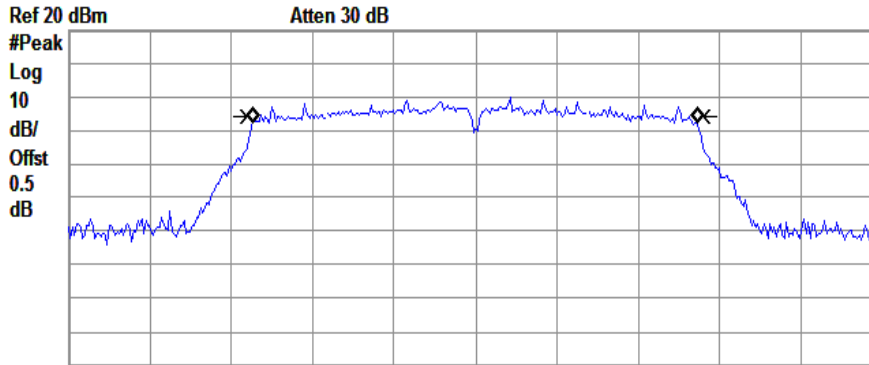

Center 2.437 GHz Span 30 MHz  
#Res BW 100 kHz #VBW 300 kHz Sweep 4 ms (401 pts)

Occupied Bandwidth 16.3589 MHz  
Occ BW % Pwr 99.00 %  
x dB -6.00 dB

Transmit Freq Error -5.371 kHz  
x dB Bandwidth 15.797 MHz



G-6 6dB

Agilent 00:42:40 Jun 5, 2014 R T

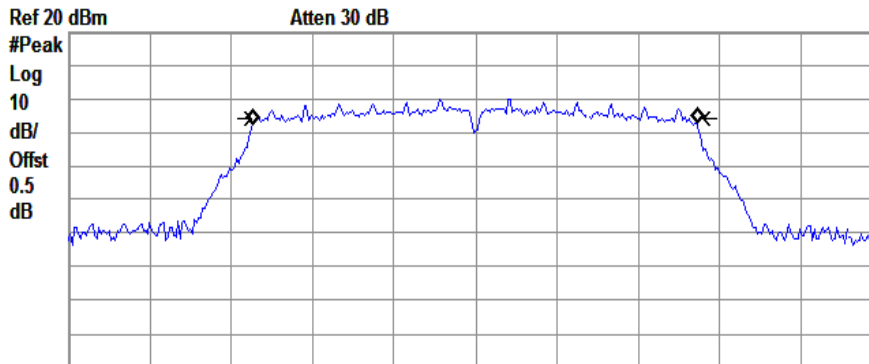

Center 2.462 GHz Span 30 MHz  
#Res BW 100 kHz #VBW 300 kHz Sweep 4 ms (401 pts)

Occupied Bandwidth 16.3497 MHz  
Occ BW % Pwr 99.00 %  
x dB -6.00 dB

Transmit Freq Error -12.604 kHz  
x dB Bandwidth 15.637 MHz



G-11 6dB



Agilent 01:07:20 Jun 5, 2014 R T

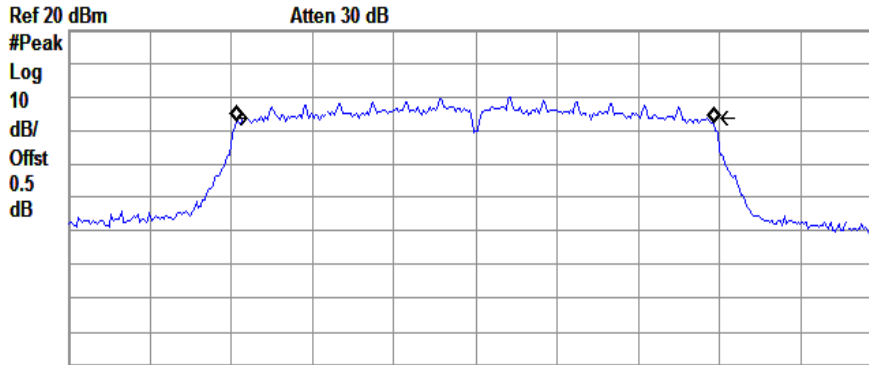

Center 2.412 GHz Span 30 MHz  
#Res BW 100 kHz #VBW 300 kHz Sweep 4 ms (401 pts)

<b>Occupied Bandwidth</b>	Occ BW % Pwr	99.00 %
17.5024 MHz	x dB	-6.00 dB

Transmit Freq Error -5.858 kHz  
x dB Bandwidth 16.449 MHz



N20-1 6dB

Agilent 01:14:11 Jun 5, 2014 R T

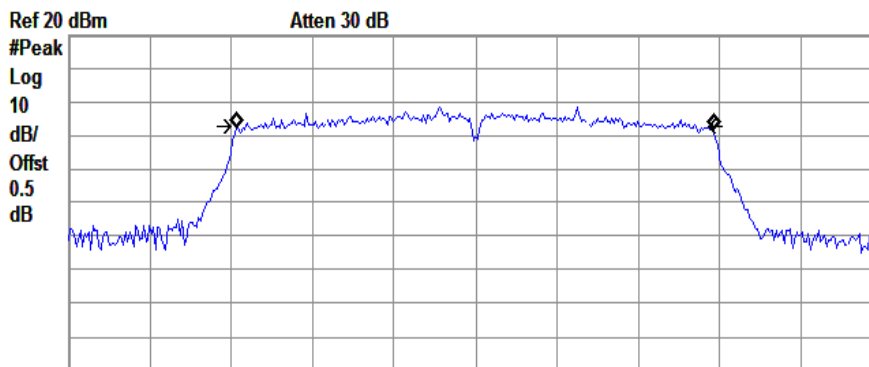

Center 2.437 GHz Span 30 MHz  
#Res BW 100 kHz #VBW 300 kHz Sweep 4 ms (401 pts)

<b>Occupied Bandwidth</b>	Occ BW % Pwr	99.00 %
17.5202 MHz	x dB	-6.00 dB

Transmit Freq Error -11.987 kHz  
x dB Bandwidth 16.580 MHz



N20-6 6dB





# SIEMIC, INC.

Accessing global markets

Title: RF Test Report for Smart Mobile Phone  
Main Model: V6  
Serial Model: N/A  
To: FCC Part 15.247: 2013, ANSI C63.4: 2009

Report No.: 14070280-FCC-R3  
Issue Date: June 30, 2014  
Page: 17 of 72  
www.siemic.com  
www.siemic.com.cn

Agilent 01:21:56 Jun 5, 2014 R T

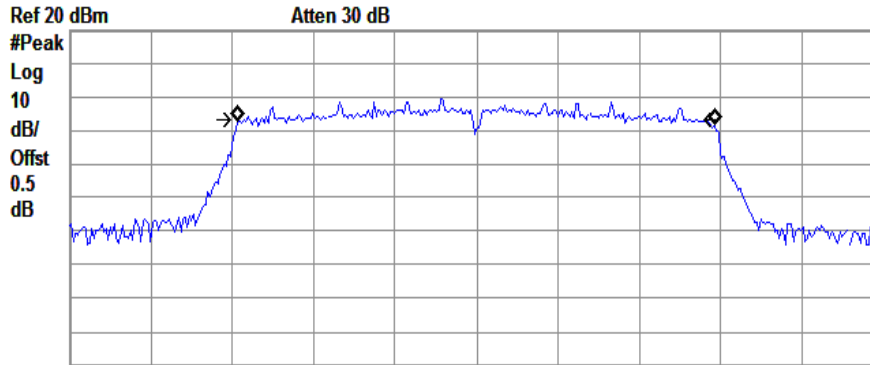

Center 2.462 GHz Span 30 MHz  
#Res BW 100 kHz #VBW 300 kHz Sweep 4 ms (401 pts)

Occupied Bandwidth  
17.5050 MHz

Occ BW % Pwr 99.00 %  
x dB -6.00 dB

Transmit Freq Error -6.106 kHz  
x dB Bandwidth 16.444 MHz



N20-11 6dB



**SIEMIC, INC.**

Accessing global markets

Title: RF Test Report for Smart Mobile Phone  
Main Model: V6  
Serial Model: N/A  
To: FCC Part 15.247: 2013, ANSI C63.4: 2009

Report No.: 14070280-FCC-R3  
Issue Date: June 30, 2014  
Page: 18 of 72  
www.siemec.com  
www.siemec.com.cn

**The 20dB bandwidth:**

Agilent 23:48:32 Jun 4, 2014 R T

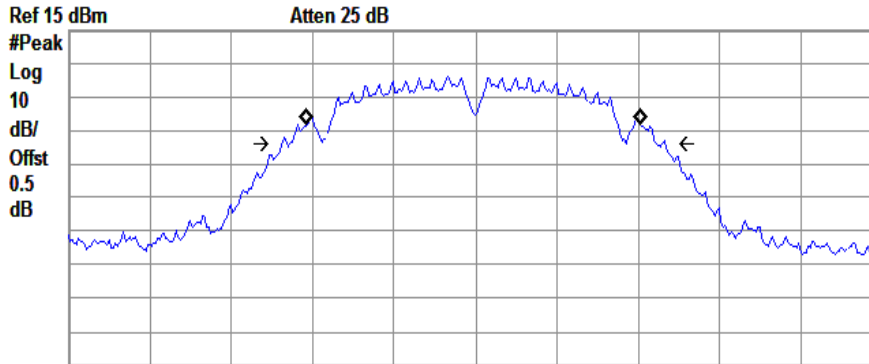

Center 2.412 GHz Span 30 MHz  
#Res BW 100 kHz #VBW 300 kHz Sweep 4 ms (401 pts)

**Occupied Bandwidth**  
12.2917 MHz

Occ BW % Pwr 99.00 %  
x dB -20.00 dB

Transmit Freq Error -63.597 kHz  
x dB Bandwidth 14.127 MHz



B-1 20dB

Agilent 23:49:21 Jun 4, 2014 R T

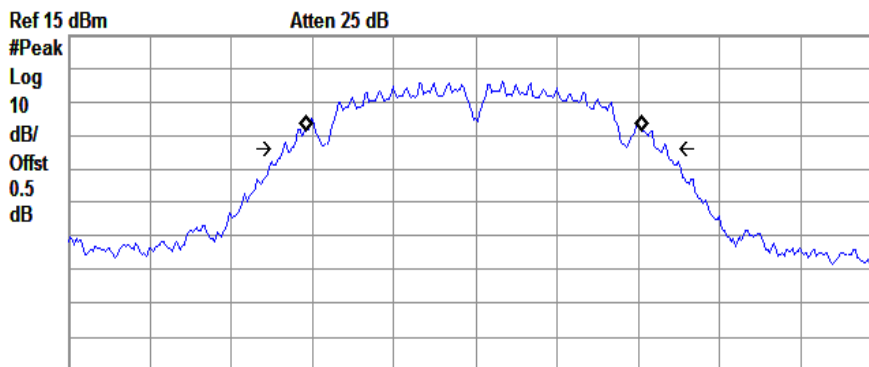

Center 2.437 GHz Span 30 MHz  
#Res BW 100 kHz #VBW 300 kHz Sweep 4 ms (401 pts)

**Occupied Bandwidth**  
12.3416 MHz

Occ BW % Pwr 99.00 %  
x dB -20.00 dB

Transmit Freq Error -29.866 kHz  
x dB Bandwidth 14.161 MHz



B-6 20dB



**SIEMIC, INC.**

Accessing global markets

Title: RF Test Report for Smart Mobile Phone  
Main Model: V6  
Serial Model: N/A  
To: FCC Part 15.247: 2013, ANSI C63.4: 2009

Report No.: 14070280-FCC-R3  
Issue Date: June 30, 2014  
Page: 19 of 72  
www.siemec.com  
www.siemec.com.cn

Agilent 23:50:13 Jun 4, 2014 R T

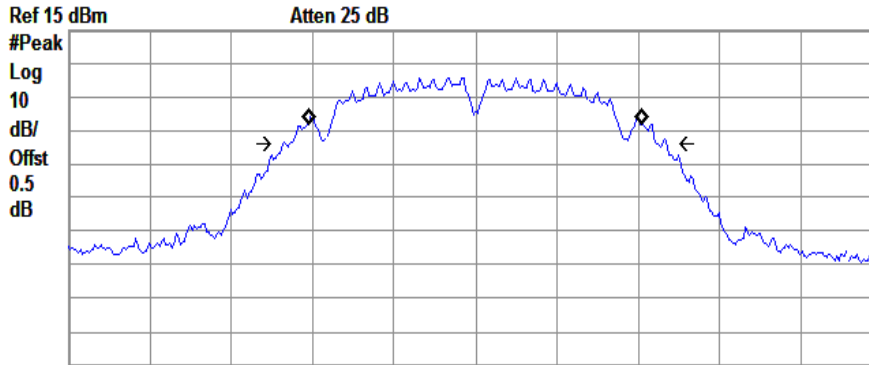

Center 2.462 GHz Span 30 MHz  
#Res BW 100 kHz #VBW 300 kHz Sweep 4 ms (401 pts)

Occupied Bandwidth 12.2814 MHz Occ BW % Pwr 99.00 %  
x dB -20.00 dB

Transmit Freq Error -11.486 kHz  
x dB Bandwidth 14.157 MHz



B-11 20dB

Agilent 00:38:03 Jun 5, 2014 R T

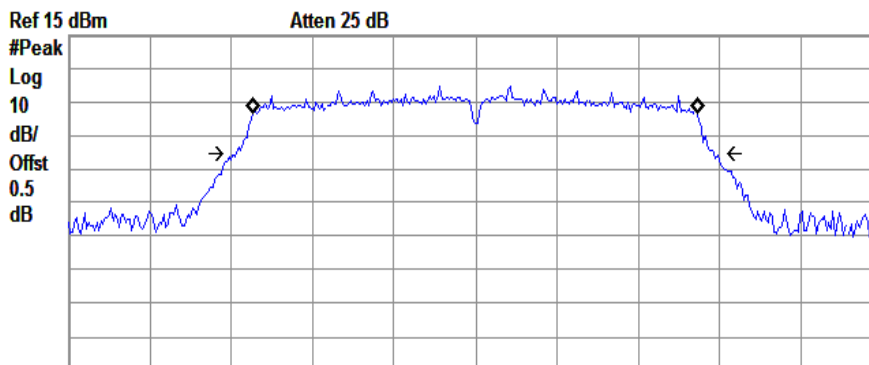

Center 2.412 GHz Span 30 MHz  
#Res BW 100 kHz #VBW 300 kHz Sweep 4 ms (401 pts)

Occupied Bandwidth 16.3526 MHz Occ BW % Pwr 99.00 %  
x dB -20.00 dB

Transmit Freq Error -8.173 kHz  
x dB Bandwidth 17.603 MHz



G-1 20dB



# SIEMIC, INC.

Accessing global markets

Title: RF Test Report for Smart Mobile Phone  
Main Model: V6  
Serial Model: N/A  
To: FCC Part 15.247: 2013, ANSI C63.4: 2009

Report No.: 14070280-FCC-R3  
Issue Date: June 30, 2014  
Page: 20 of 72  
www.siemec.com  
www.siemec.com.cn

Agilent 00:36:07 Jun 5, 2014 R T

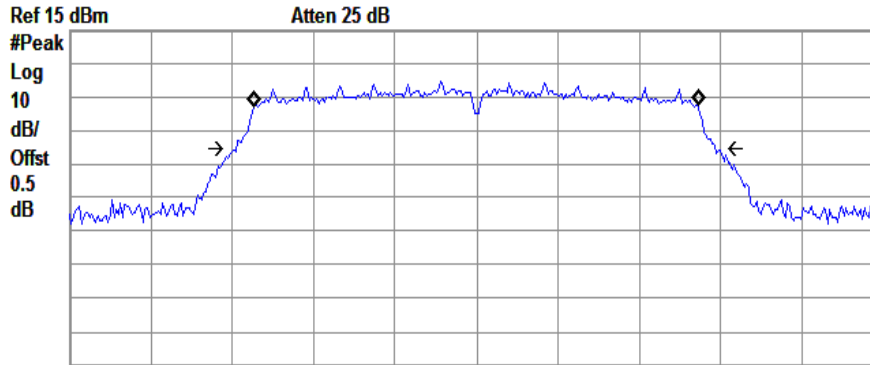

Center 2.437 GHz Span 30 MHz  
#Res BW 100 kHz #VBW 300 kHz Sweep 4 ms (401 pts)

Occupied Bandwidth 16.3467 MHz  
Occ BW % Pwr 99.00 %  
x dB -20.00 dB

Transmit Freq Error -5.765 kHz  
x dB Bandwidth 17.648 MHz



G-6 20dB

Agilent 00:38:49 Jun 5, 2014 R T

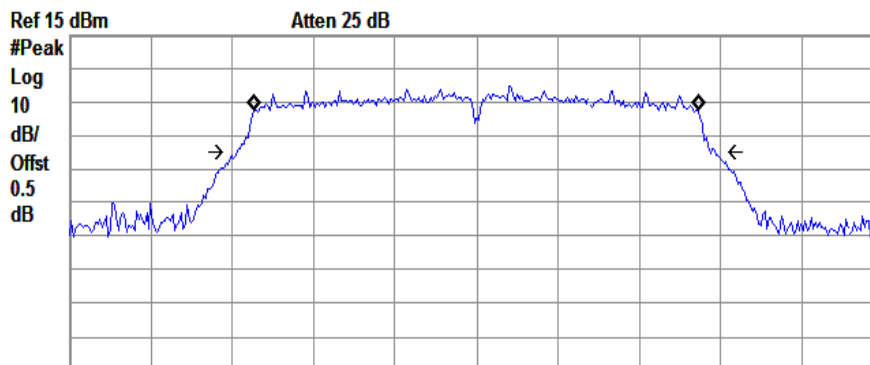

Center 2.462 GHz Span 30 MHz  
#Res BW 100 kHz #VBW 300 kHz Sweep 4 ms (401 pts)

Occupied Bandwidth 16.3503 MHz  
Occ BW % Pwr 99.00 %  
x dB -20.00 dB

Transmit Freq Error -4.525 kHz  
x dB Bandwidth 17.625 MHz



G-11 20dB



# SIEMIC, INC.

Accessing global markets

Title: RF Test Report for Smart Mobile Phone  
Main Model: V6  
Serial Model: N/A  
To: FCC Part 15.247: 2013, ANSI C63.4: 2009

Report No.: 14070280-FCC-R3  
Issue Date: June 30, 2014  
Page: 21 of 72  
www.siemec.com  
www.siemec.com.cn

Agilent 01:26:44 Jun 5, 2014 R T

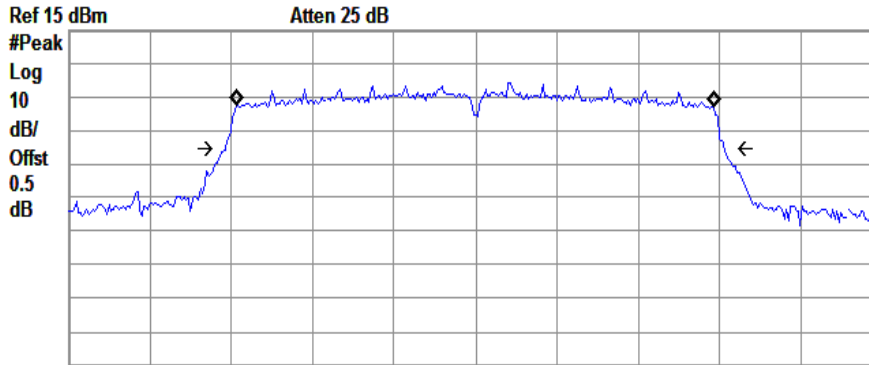

Center 2.412 GHz Span 30 MHz  
#Res BW 100 kHz #VBW 300 kHz Sweep 4 ms (401 pts)

Occupied Bandwidth 17.5168 MHz  
Occ BW % Pwr 99.00 %  
x dB -20.00 dB

Transmit Freq Error -11.009 kHz  
x dB Bandwidth 18.431 MHz



N20-1 20dB

Agilent 01:25:57 Jun 5, 2014 R T

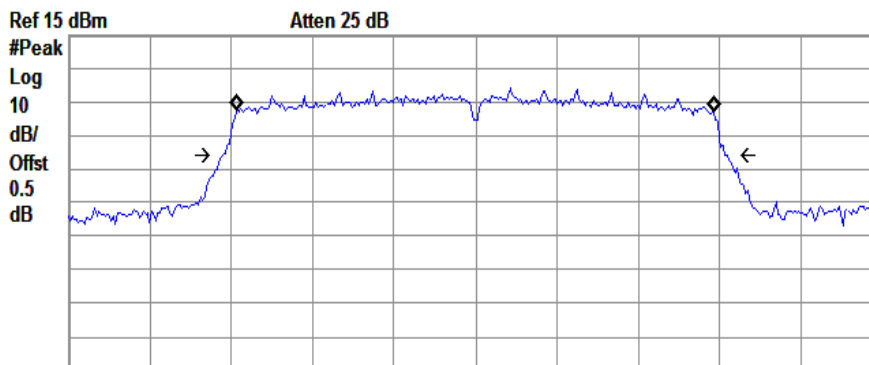

Center 2.437 GHz Span 30 MHz  
#Res BW 100 kHz #VBW 300 kHz Sweep 4 ms (401 pts)

Occupied Bandwidth 17.5178 MHz  
Occ BW % Pwr 99.00 %  
x dB -20.00 dB

Transmit Freq Error -3.305 kHz  
x dB Bandwidth 18.626 MHz



N20-6 20dB



# SIEMIC, INC.

Accessing global markets

Title: RF Test Report for Smart Mobile Phone  
Main Model: V6  
Serial Model: N/A  
To: FCC Part 15.247: 2013, ANSI C63.4: 2009

Report No.: 14070280-FCC-R3  
Issue Date: June 30, 2014  
Page: 22 of 72  
www.siemic.com  
www.siemic.com.cn

Agilent 01:24:36 Jun 5, 2014 R T

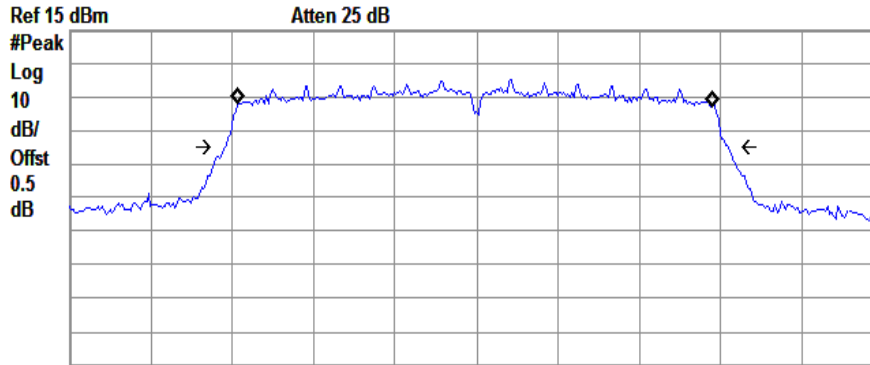

Center 2.462 GHz #Res BW 100 kHz #VBW 300 kHz Sweep 4 ms (401 pts) Span 30 MHz

Occupied Bandwidth  
17.4935 MHz

Occ BW % Pwr 99.00 %  
x dB -20.00 dB

Transmit Freq Error -14.569 kHz  
x dB Bandwidth 18.551 MHz



N20-11 20dB

## **5.4 §15.247(b) (3) - Conducted Maximum Output Power**

1. **Conducted Measurement**  
EUT was set for low, mid, high channel with modulated mode and highest RF output power.  
The spectrum analyzer was connected to the antenna terminal.
2. **Conducted Emissions Measurement Uncertainty**  
All test measurements carried out are traceable to national standards. The uncertainty of the measurement at a confidence level of approximately 95% (in the case where distributions are normal), with a coverage factor of 2, in the range 30MHz – 40GHz is  $\pm 1.5\text{dB}$ .
3. **Environmental Conditions**

Temperature	24°C
Relative Humidity	59%
Atmospheric Pressure	1010mbar
4. Test date : June 05, 2014  
Tested By : Hank Li

### **Standard Requirement:**

#### **Measurement Procedure AVG:**

- a) Set span to at least 1.5 times the OBW.
- b) Set RBW = 1-5% of the OBW, not to exceed 1 MHz.
- c) Set VBW  $\geq 3 \times$  RBW.
- d) Number of points in sweep  $\geq 2 \times$  span / RBW. (This gives bin-to-bin spacing  $\leq$  RBW/2, so that narrowband signals are not lost between frequency bins.)
- e) Sweep time = auto.
- f) Detector = RMS (i.e., power averaging), if available. Otherwise, use sample detector mode.
- g) If transmit duty cycle  $< 98\%$ , use a sweep trigger with the level set to enable triggering only on full power pulses. The transmitter shall operate at maximum power control level for the entire duration of every sweep. If the EUT transmits continuously (i.e., with no off intervals) or at duty cycle  $\geq 98\%$ , and if each transmission is entirely at the maximum power control level, then the trigger shall be set to “free run”.
- h) Trace average at least 100 traces in power averaging (i.e., RMS) mode.
  - i) Compute power by integrating the spectrum across the OBW of the signal using the instrument’s band power measurement function, with band limits set equal to the OBW band edges. If the instrument does not have a band power function, sum the spectrum levels (in power units) at intervals equal to the RBW extending across the entire OBW of the spectrum.

**Test Result: Pass.**

Please refer to the following tables and plots.

**Note:**

B: 802.11b  
G: 802.11g  
N: 802.11n

1: Low Channel  
6: Middle Channel  
11: High Channel

**The Average Power**

Channel	Channel Frequency (MHz)	Data Rate (Mbps)	AV Output Power (dBm)	Limit (dBm)
<b>802.11b mode</b>				
Low	2412	1	<b>9.26</b>	30
Middle	2437	1	<b>9.42</b>	30
High	2462	1	<b>9.31</b>	30
<b>802.11g mode</b>				
Low	2412	6	8.59	30
Middle	2437	6	8.92	30
High	2462	6	9.09	30
<b>802.11n mode</b>				
Low	2412	MCS0 (20M)	8.25	30
Middle	2437	MCS0 (20M)	9.32	30
High	2462	MCS0 (20M)	9.30	30





**SIEMIC, INC.**

Accessing global markets

Title: RF Test Report for Smart Mobile Phone  
Main Model: V6  
Serial Model: N/A  
To: FCC Part 15.247: 2013, ANSI C63.4: 2009

Report No.: 14070280-FCC-R3  
Issue Date: June 30, 2014  
Page: 25 of 72  
www.siemec.com  
www.siemec.com.cn

### The Average Power

Agilent 00:13:59 Jun 5, 2014 R T

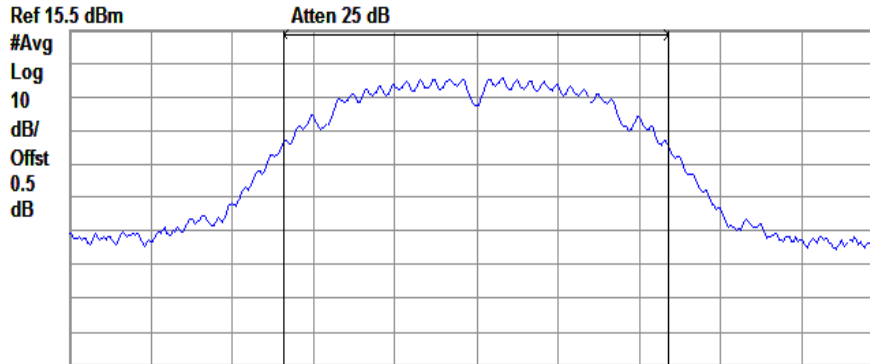

Center 2.412 GHz Span 30 MHz  
#Res BW 300 kHz #VBW 1 MHz Sweep 8 ms (401 pts)

Channel Power Power Spectral Density  
9.26 dBm / 14.1270 MHz -62.25 dBm/Hz



B-1 AV

Agilent 00:18:43 Jun 5, 2014 R T

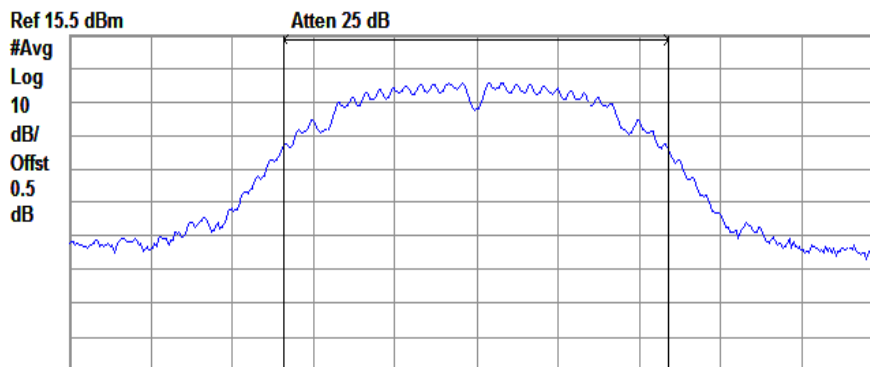

Center 2.437 GHz Span 30 MHz  
#Res BW 300 kHz #VBW 1 MHz Sweep 8 ms (401 pts)

Channel Power Power Spectral Density  
9.42 dBm / 14.1610 MHz -62.09 dBm/Hz



B-6 AV



# SIEMIC, INC.

Accessing global markets

Title: RF Test Report for Smart Mobile Phone  
Main Model: V6  
Serial Model: N/A  
To: FCC Part 15.247: 2013, ANSI C63.4: 2009

Report No.: 14070280-FCC-R3  
Issue Date: June 30, 2014  
Page: 26 of 72  
www.siemec.com  
www.siemec.com.cn

Agilent 00:20:17 Jun 5, 2014 R T

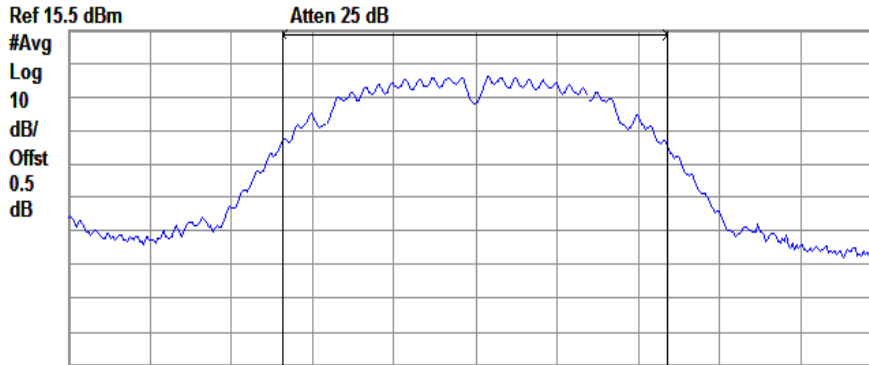

Center 2.462 GHz Span 30 MHz  
#Res BW 300 kHz #VBW 1 MHz Sweep 8 ms (401 pts)

Channel Power Power Spectral Density  
9.31 dBm / 14.1570 MHz -62.20 dBm/Hz



B-11 AV

Agilent 00:56:56 Jun 5, 2014 R T

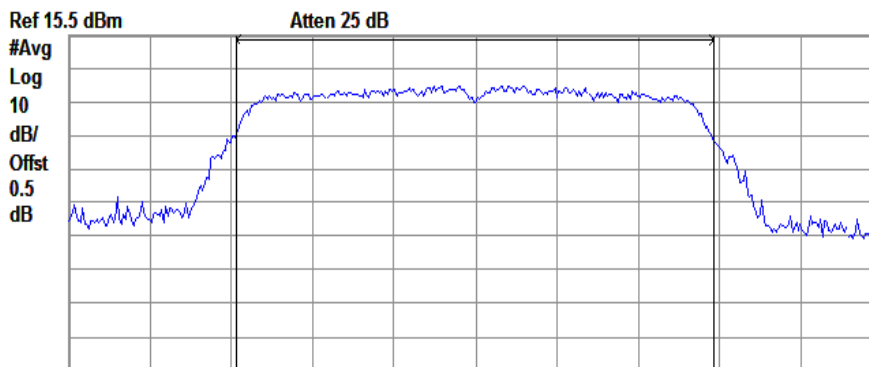

Center 2.412 GHz Span 30 MHz  
#Res BW 300 kHz #VBW 1 MHz Sweep 8 ms (401 pts)

Channel Power Power Spectral Density  
8.59 dBm / 17.6030 MHz -63.87 dBm/Hz



G-1 AV



# SIEMIC, INC.

Accessing global markets

Title: RF Test Report for Smart Mobile Phone  
Main Model: V6  
Serial Model: N/A  
To: FCC Part 15.247: 2013, ANSI C63.4: 2009

Report No.: 14070280-FCC-R3  
Issue Date: June 30, 2014  
Page: 27 of 72  
www.siemec.com  
www.siemec.com.cn

Agilent 00:57:55 Jun 5, 2014 R T

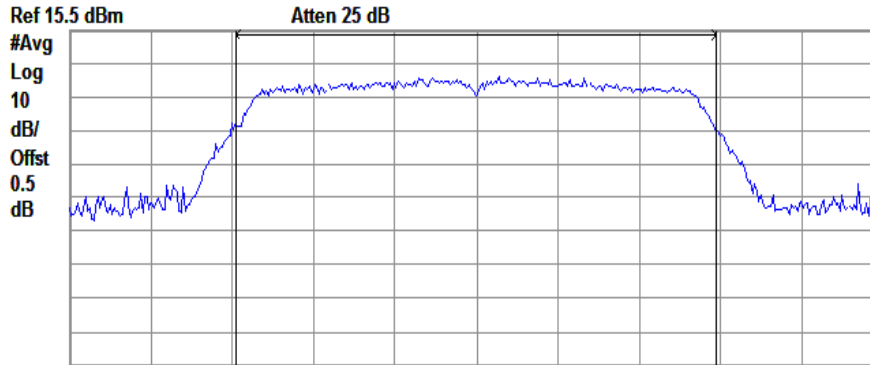

Center 2.437 GHz #Res BW 300 kHz #VBW 1 MHz Sweep 8 ms (401 pts) Span 30 MHz

Channel Power 8.92 dBm / 17.6480 MHz Power Spectral Density -63.55 dBm/Hz



G-6 AV

Agilent 00:59:50 Jun 5, 2014 R T

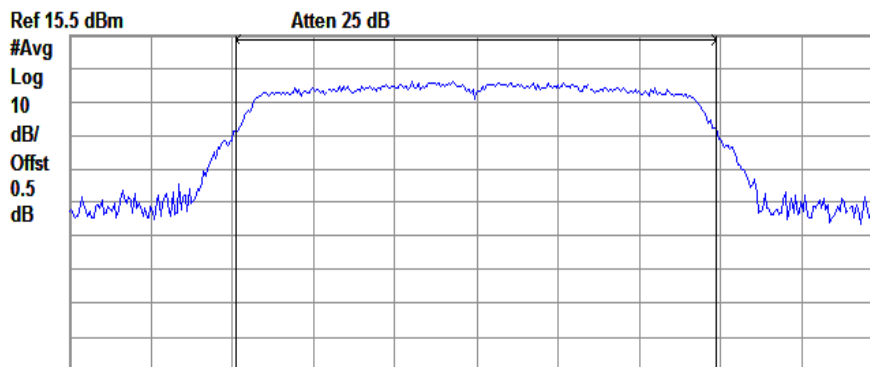

Center 2.462 GHz #Res BW 300 kHz #VBW 1 MHz Sweep 8 ms (401 pts) Span 30 MHz

Channel Power 9.09 dBm / 17.6250 MHz Power Spectral Density -63.37 dBm/Hz



G-11 AV



**SIEMIC, INC.**

Accessing global markets

Title: RF Test Report for Smart Mobile Phone  
Main Model: V6  
Serial Model: N/A  
To: FCC Part 15.247: 2013, ANSI C63.4: 2009

Report No.: 14070280-FCC-R3  
Issue Date: June 30, 2014  
Page: 28 of 72  
www.siemec.com  
www.siemec.com.cn

Agilent 01:35:01 Jun 5, 2014 R T

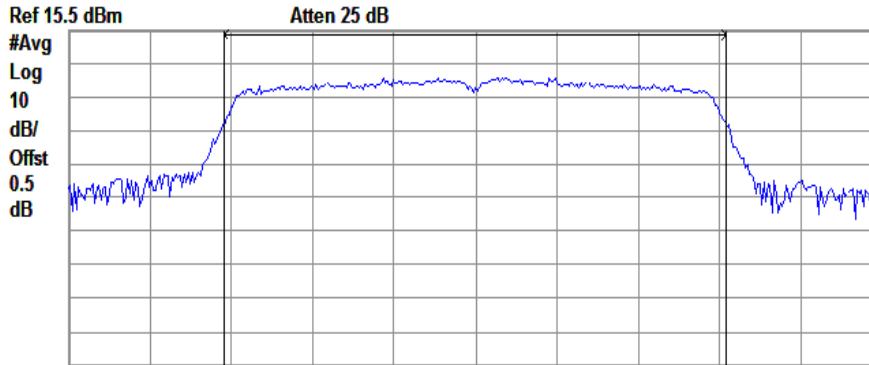

Center 2.412 GHz Span 30 MHz  
#Res BW 300 kHz #VBW 1 MHz Sweep 8 ms (401 pts)

Channel Power Power Spectral Density  
9.25 dBm / 18.4310 MHz -63.40 dBm/Hz



N20-1 AV

Agilent 01:30:41 Jun 5, 2014 R T

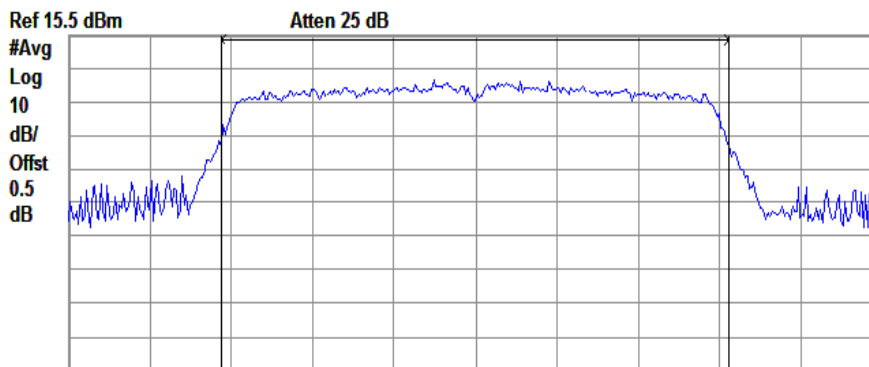

Center 2.437 GHz Span 30 MHz  
#Res BW 300 kHz #VBW 1 MHz Sweep 8 ms (401 pts)

Channel Power Power Spectral Density  
9.32 dBm / 18.6260 MHz -63.39 dBm/Hz



N20-6 AV



**SIEMIC, INC.**

Accessing global markets

Title: RF Test Report for Smart Mobile Phone  
Main Model: V6  
Serial Model: N/A  
To: FCC Part 15.247: 2013, ANSI C63.4: 2009

Report No.: 14070280-FCC-R3  
Issue Date: June 30, 2014  
Page: 29 of 72  
www.siemec.com  
www.siemec.com.cn

Agilent 01:31:46 Jun 5, 2014 R T

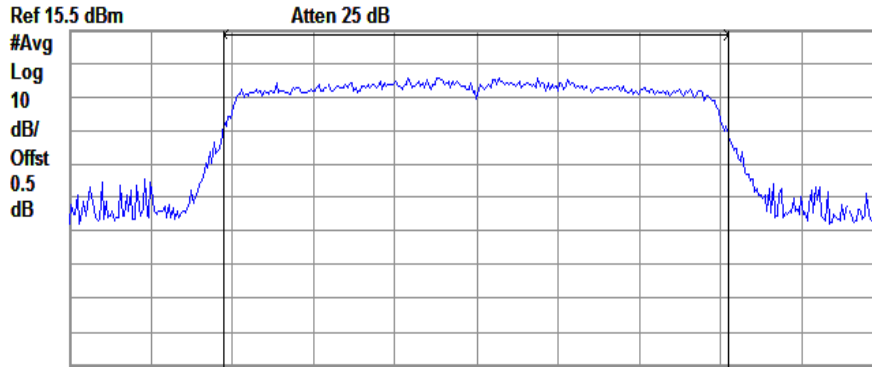

Center 2.462 GHz Span 30 MHz  
#Res BW 300 kHz #VBW 1 MHz Sweep 8 ms (401 pts)

Channel Power

Power Spectral Density

9.30 dBm / 18.5510 MHz

-63.31 dBm/Hz

N20-11 AV

## **5.5 §15.247(e) - Power Spectral Density**

1. **Conducted Measurement**  
EUT was set for low, mid, high channel with modulated mode and highest RF output power.  
The spectrum analyzer was connected to the antenna terminal.
2. **Environmental Conditions**

Temperature	24°C
Relative Humidity	59%
Atmospheric Pressure	1010mbar
3. **Conducted Emissions Measurement Uncertainty**  
All test measurements carried out are traceable to national standards. The uncertainty of the measurement at a confidence level of approximately 95% (in the case where distributions are normal), with a coverage factor of 2, in the range 30MHz – 40GHz is ±1.5dB.
4. Test date : June 05, 2014  
Tested By : Hank Li

### Requirement(s):

A conducted power spectral density (PSD) limit of 8 dBm in any 3 kHz band segment within the DTS bandwidth is specified during any time interval of continuous transmission. By rule, the same method as used to determine the conducted output power shall be used to determine the power spectral density (i.e., if maximum peak conducted output power was measured then the peak PSD procedure shall be used and if maximum conducted output power was measured then the average PSD procedure shall be used).

If the average PSD is measured with a power averaging (RMS) detector or a sample detector, then the spectrum analyzer must be capable of utilizing a number of measurement points in each sweep that is greater than or equal to twice the span/RBW in order to ensure bin-to-bin spacing of  $\leq RBW/2$  so that narrowband signals are not lost between frequency bins.

### Procedures:

- a) Set analyzer center frequency to DTS channel center frequency.
- b) Set the span to 1.5 times the DTS bandwidth.
- c) Set the RBW to:  $3 \text{ kHz} \leq RBW \leq 100 \text{ kHz}$ .
- d) Set the VBW  $\geq 3 \times RBW$ .
- e) Detector = peak.
- f) Sweep time = auto couple.
- g) Trace mode = max hold.
- h) Allow trace to fully stabilize.
- i) Use the peak marker function to determine the maximum amplitude level within the RBW.
- j) If measured value exceeds limit, reduce RBW (no less than 3 kHz) and repeat.

**Test Result: Pass.**

Please refer to the following tables and plots.

Channel	Frequency (MHz)	Data Rate	PSD (dBm)	Limit (dBm)
<b>802.11b mode</b>				
Low	2412	1	0.433	8
Middle	2437	1	1.130	8
High	2462	1	1.301	8
<b>802.11g mode</b>				
Low	2412	6	-0.668	8
Middle	2437	6	-0.089	8
High	2462	6	-0.247	8
<b>802.11n mode</b>				
Low	2412	MCS0	-0.472	8
Middle	2437	MCS0	-0.223	8
High	2462	MCS0	-0.022	8

**Note:**

B: 802.11b

G: 802.11g

N20: 802.11n

1: Low Channel

6: Middle Channel

11: High Channel



**SIEMIC, INC.**

Accessing global markets

Title: RF Test Report for Smart Mobile Phone  
Main Model: V6  
Serial Model: N/A  
To: FCC Part 15.247: 2013, ANSI C63.4: 2009

Report No.: 14070280-FCC-R3  
Issue Date: June 30, 2014  
Page: 32 of 72  
www.siemic.com  
www.siemic.com.cn

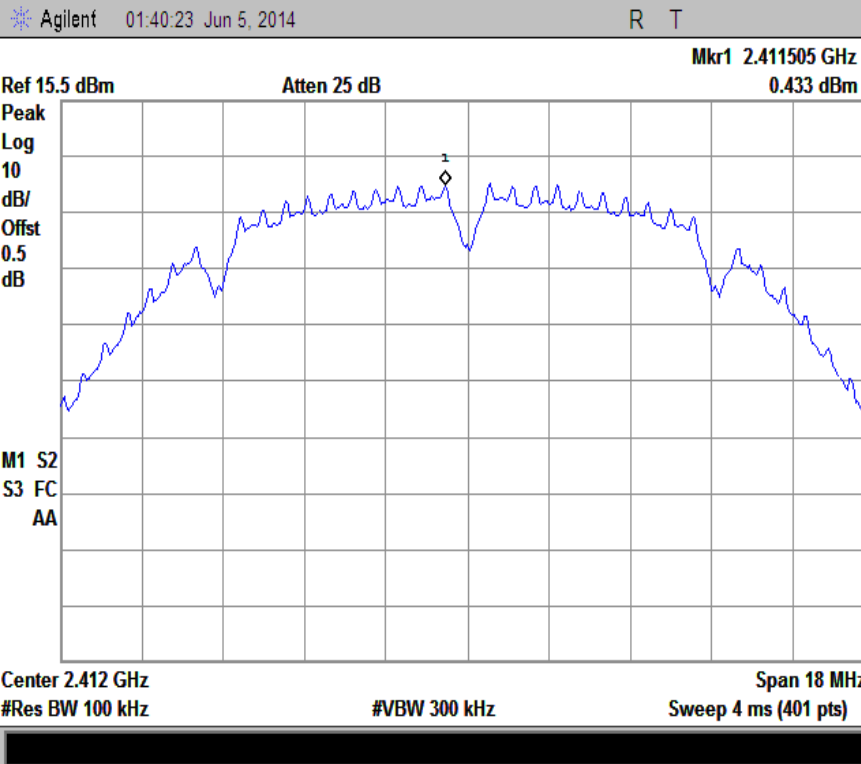

B-1

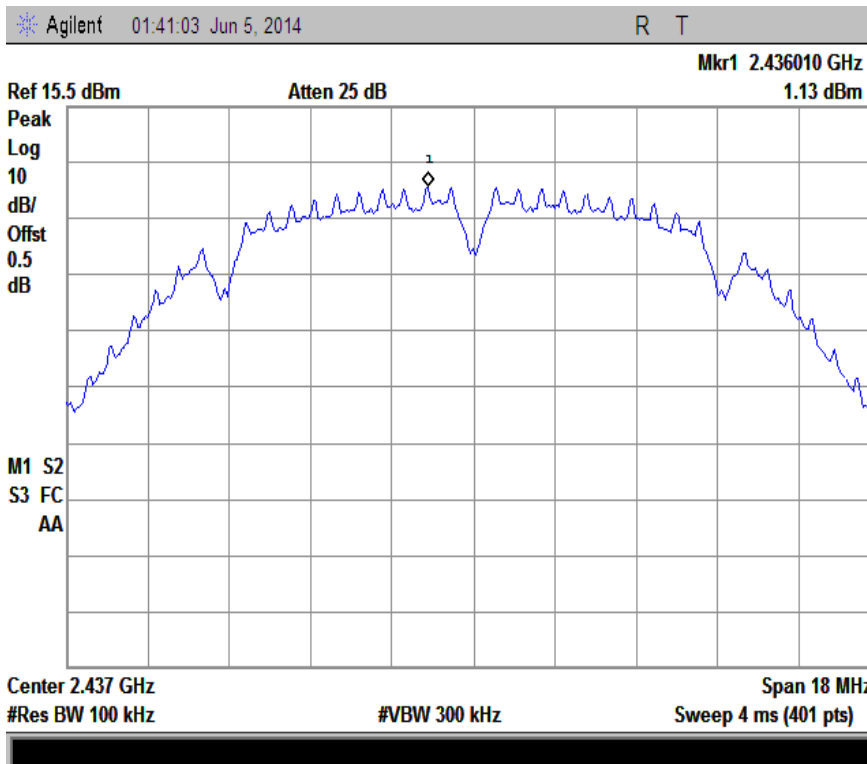

B-6





**SIEMIC, INC.**

Accessing global markets

Title: RF Test Report for Smart Mobile Phone  
Main Model: V6  
Serial Model: N/A  
To: FCC Part 15.247: 2013, ANSI C63.4: 2009

Report No.: 14070280-FCC-R3  
Issue Date: June 30, 2014  
Page: 33 of 72  
www.siemic.com  
www.siemic.com.cn

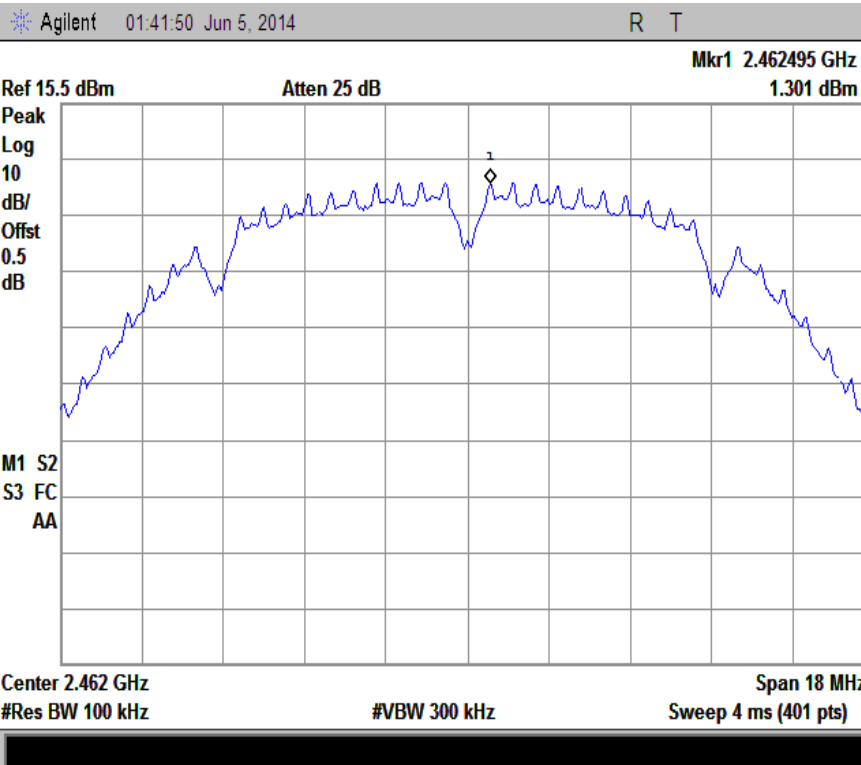

B-11

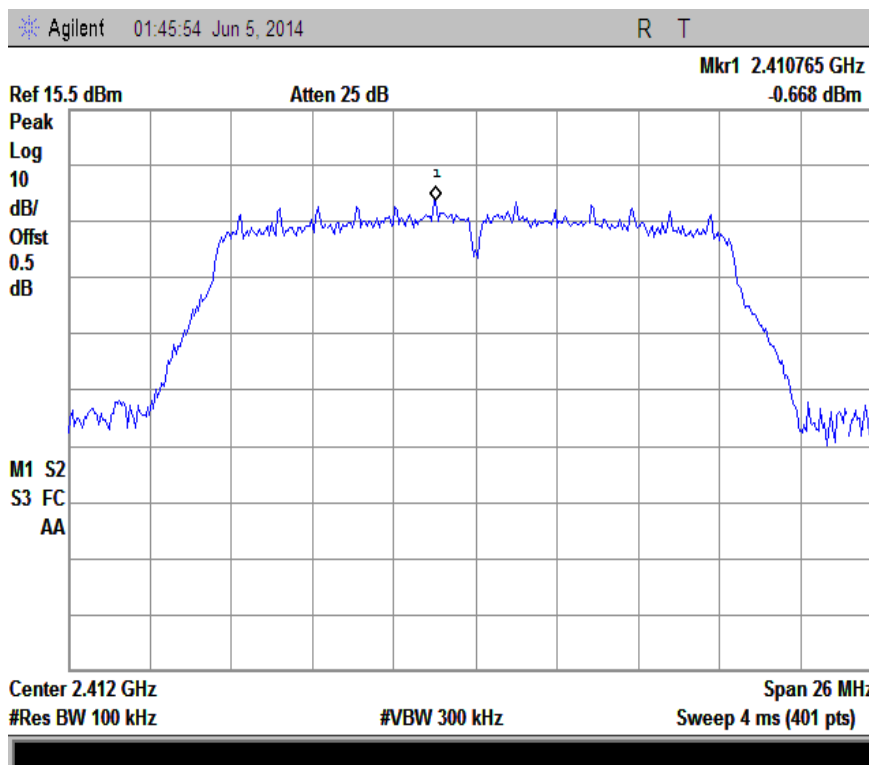

G-1



# SIEMIC, INC.

Accessing global markets

Title: RF Test Report for Smart Mobile Phone  
Main Model: V6  
Serial Model: N/A  
To: FCC Part 15.247: 2013, ANSI C63.4: 2009

Report No.: 14070280-FCC-R3  
Issue Date: June 30, 2014  
Page: 34 of 72  
www.siemic.com  
www.siemic.com.cn

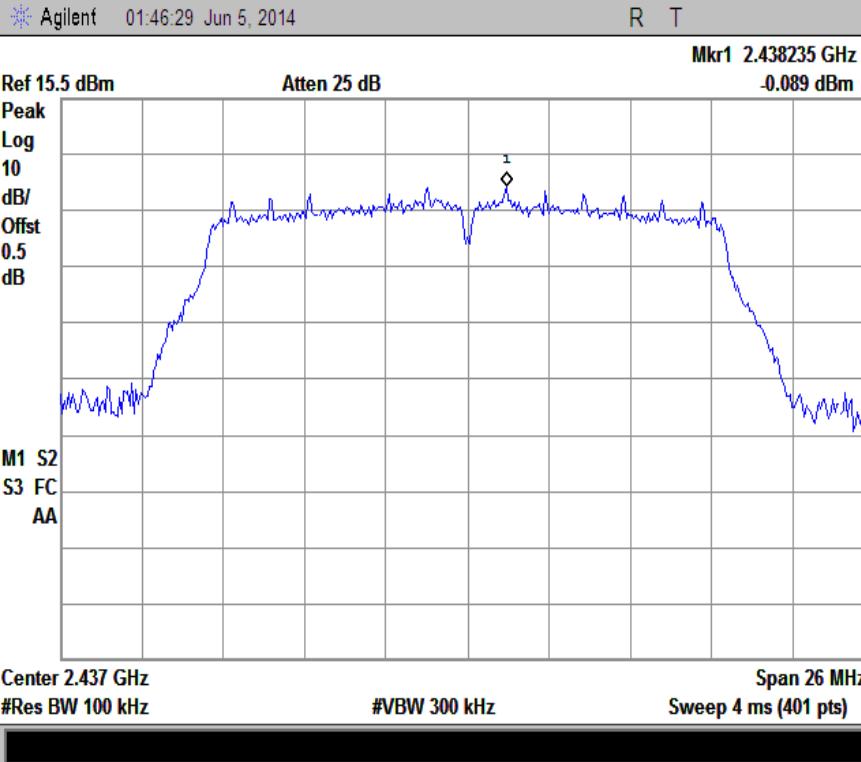

G-6

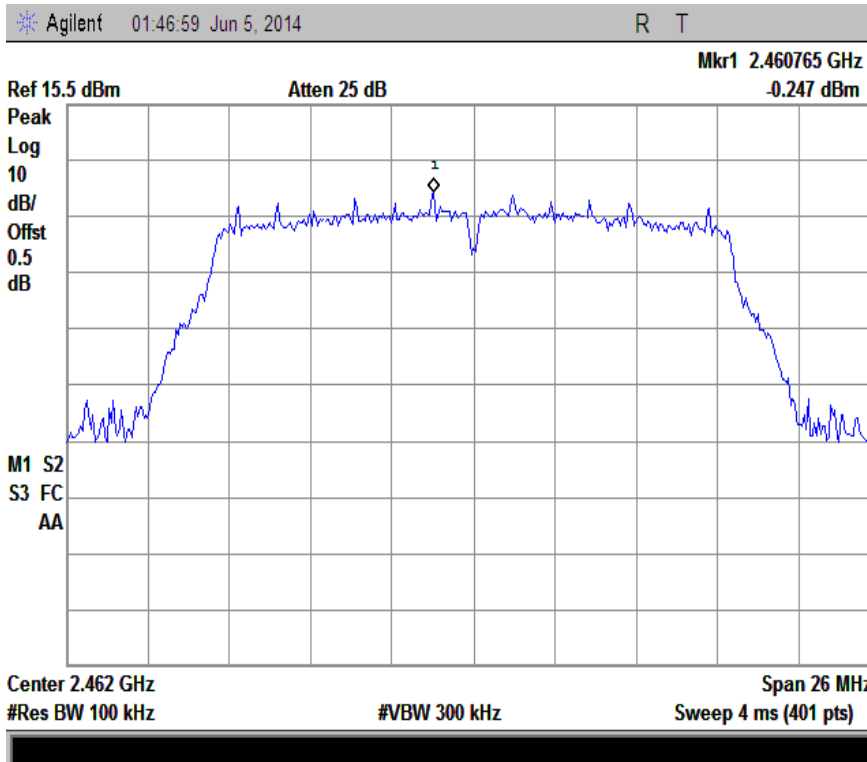

G-11



**SIEMIC, INC.**

Accessing global markets

Title: RF Test Report for Smart Mobile Phone  
Main Model: V6  
Serial Model: N/A  
To: FCC Part 15.247: 2013, ANSI C63.4: 2009

Report No.: 14070280-FCC-R3  
Issue Date: June 30, 2014  
Page: 35 of 72  
www.siemec.com  
www.siemec.com.cn

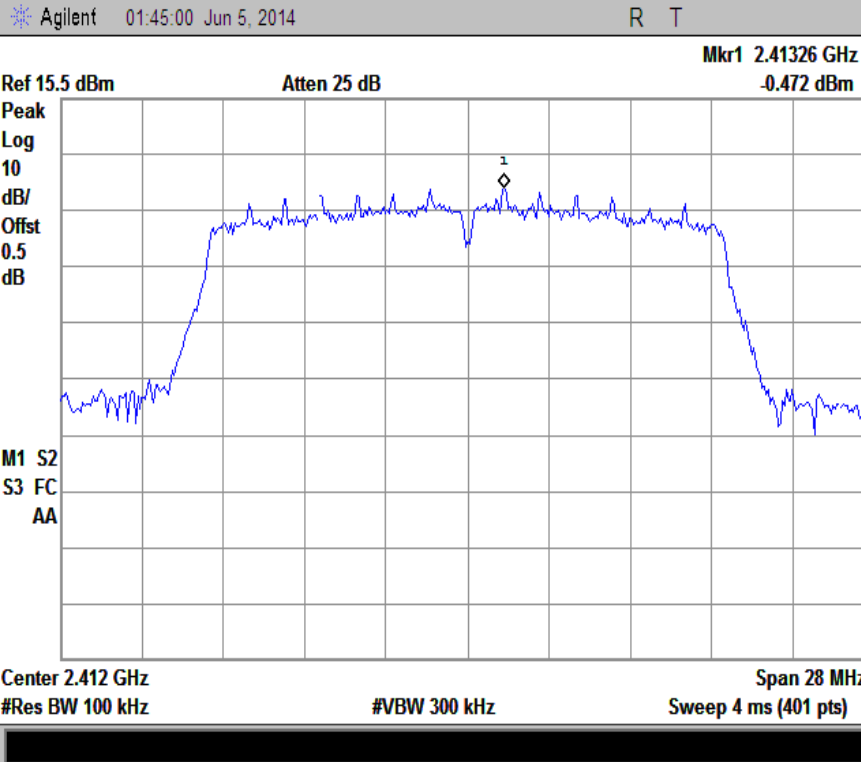

N20-1

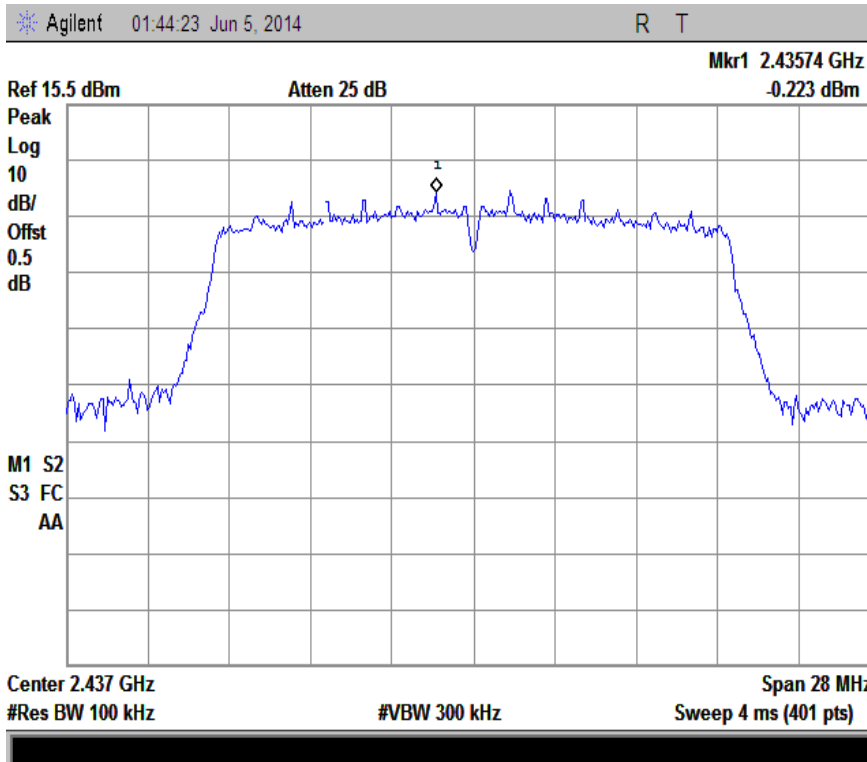

N20-6



**SIEMIC, INC.**

Accessing global markets

Title: RF Test Report for Smart Mobile Phone  
Main Model: V6  
Serial Model: N/A  
To: FCC Part 15.247: 2013, ANSI C63.4: 2009

Report No.: 14070280-FCC-R3  
Issue Date: June 30, 2014  
Page: 36 of 72  
www.siemic.com  
www.siemic.com.cn

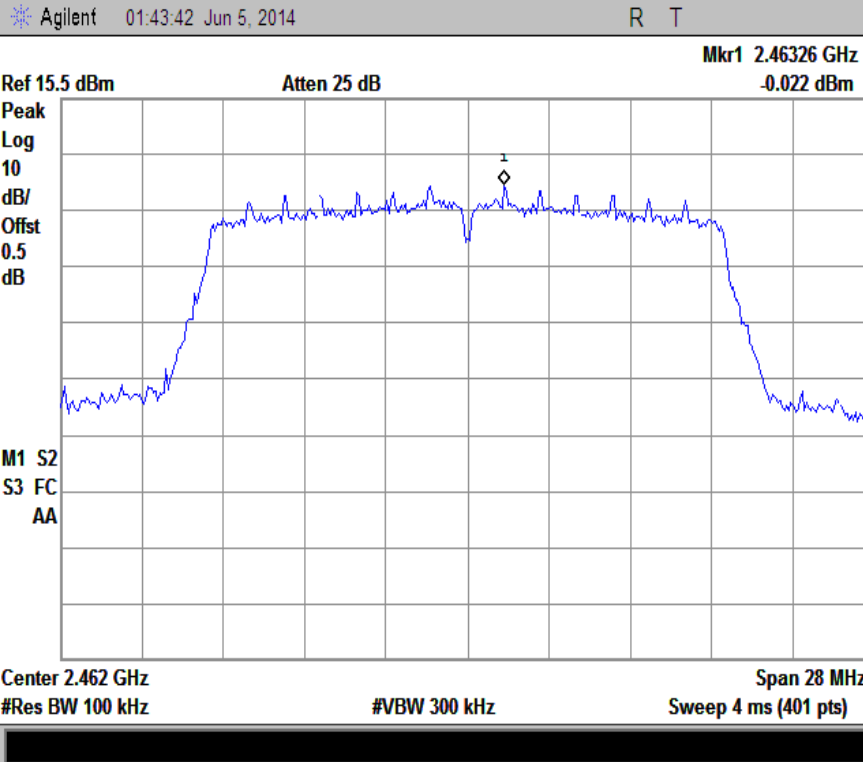

N20-11

## **5.6 §15.247(d) –Band-Edge & Unwanted Emissions into Non-Restricted Frequency Bands**

- In any 100 kHz bandwidth outside the frequency band in which the spread spectrum or digitally modulated intentional radiator is operating, the radio frequency power that is produced by the intentional radiator shall be at least 20 dB below that in the 100 kHz bandwidth within the band that contains the highest level of the desired power, based on either an RF conducted or a radiated measurement, provided the transmitter demonstrates compliance with the peak conducted power limits. If the transmitter complies with the conducted power limits based on the use of RMS averaging over a time interval, as permitted under paragraph (b)(3) of this section, the attenuation required under this paragraph shall be 30 dB instead of 20 dB. Attenuation below the general limits specified in §15.209(a) is not required. In addition, radiated emissions which fall in the restricted bands, as defined in §15.205(a), must also comply with the radiated emission limits specified in §15.209(a) (see §15.205(c))
- |                          |                      |          |
|--------------------------|----------------------|----------|
| Environmental Conditions | Temperature          | 23°C     |
|                          | Relative Humidity    | 54%      |
|                          | Atmospheric Pressure | 1020mbar |
- |                           |
|---------------------------|
| Test date : June 30, 2014 |
| Tested By : Hank Li       |

### **Requirement(s):**

#### **Band-Edge Measurements**

An additional consideration when performing conducted measurements of restricted band emissions is that unwanted emissions radiating from the EUT cabinet, control circuits, power leads, or intermediate circuit elements will likely go undetected in a conducted measurement configuration. To address this concern, a radiated test shall be performed to ensure that emissions emanating from the EUT cabinet (rather than the antenna port) also comply with the applicable limits.

For these cabinet radiated spurious emission measurements the EUT transmit antenna may be replaced with a termination matching the nominal impedance of the antenna. Procedures for performing radiated measurements are specified in ANSI C63.10. All detected emissions shall comply with the applicable limits.

### **Procedures: (Radiated Method Only)**

- Check the calibration of the measuring instrument using either an internal calibrator or a known signal from an external generator.
- Position the EUT without connection to measurement instrument. Put it on the Rotated table and turn on the EUT and make it operate in transmitting mode. Then set it to Low Channel and High Channel within its operating range, and make sure the instrument is operated in its linear range.
- First, set both RBW and VBW of spectrum analyzer to 100 kHz with a convenient frequency span including 100kHz bandwidth from band edge, check the emission of EUT, if pass then set Spectrum Analyzer as below:
  - The resolution bandwidth and video bandwidth of test receiver/spectrum analyzer is 120 kHz for Quasiy Peak detection at frequency below 1GHz.
  - The resolution bandwidth of test receiver/spectrum analyzer is 1MHz and video bandwidth is 3MHz for Peak detection at frequency above 1GHz.
  - The resolution bandwidth of test receiver/spectrum analyzer is 1MHz and the video bandwidth for Average detection (AV) as below at frequency above 1GHz.
 

<input type="checkbox"/> 1 kHz (Duty cycle < 98%)	<input checked="" type="checkbox"/> 10 Hz (Duty cycle > 98%)
---	--
- Measure the highest amplitude appearing on spectral display and set it as a reference level. Plot the graph with marking the highest point and edge frequency.
- Repeat above procedures until all measured frequencies were complete.

**Note:**

For Hopping device, should test hopping mode and CW Tx mode separately. For hopping mode, find out the worst points outside the frequency band firstly, then set the worst points as the center frequency, use above average 3 (c) spectrum analyzer set, find out the final worst average value separately.

**Test Result: Pass.**

Please refer to the following tables and plots.

**Note:**

B: 802.11b

G: 802.11g

N: 802.11n

1: Left Side

11: Right Side



**SIEMIC, INC.**

Accessing global markets

Title: RF Test Report for Smart Mobile Phone  
Main Model: V6  
Serial Model: N/A  
To: FCC Part 15.247: 2013, ANSI C63.4: 2009

Report No.: 14070280-FCC-R3  
Issue Date: June 30, 2014  
Page: 39 of 72  
www.siemec.com  
www.siemec.com.cn

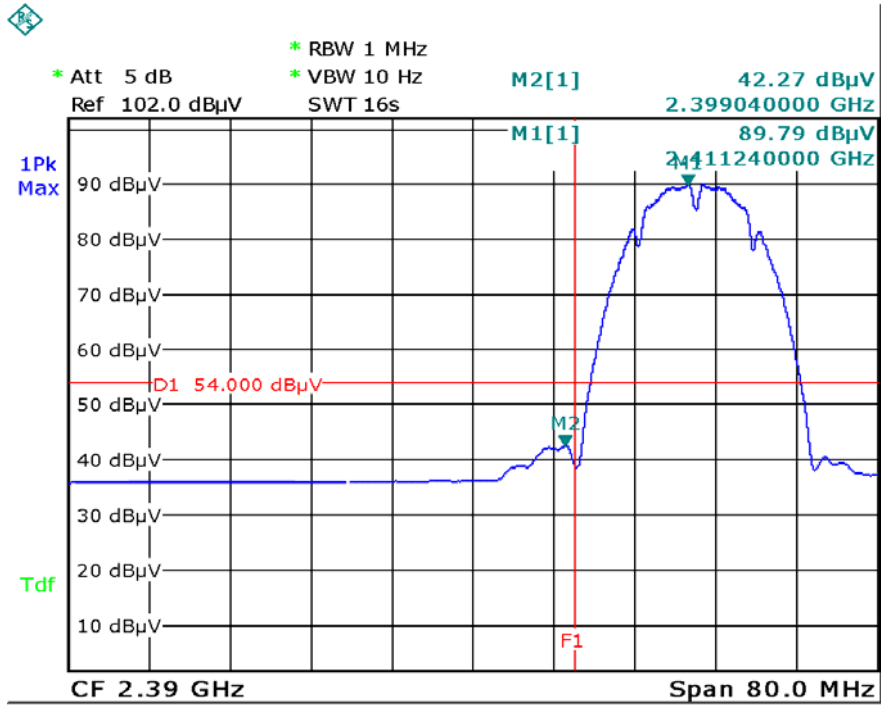

Date: 30.JUN.2014 11:27:20

B-1 AV

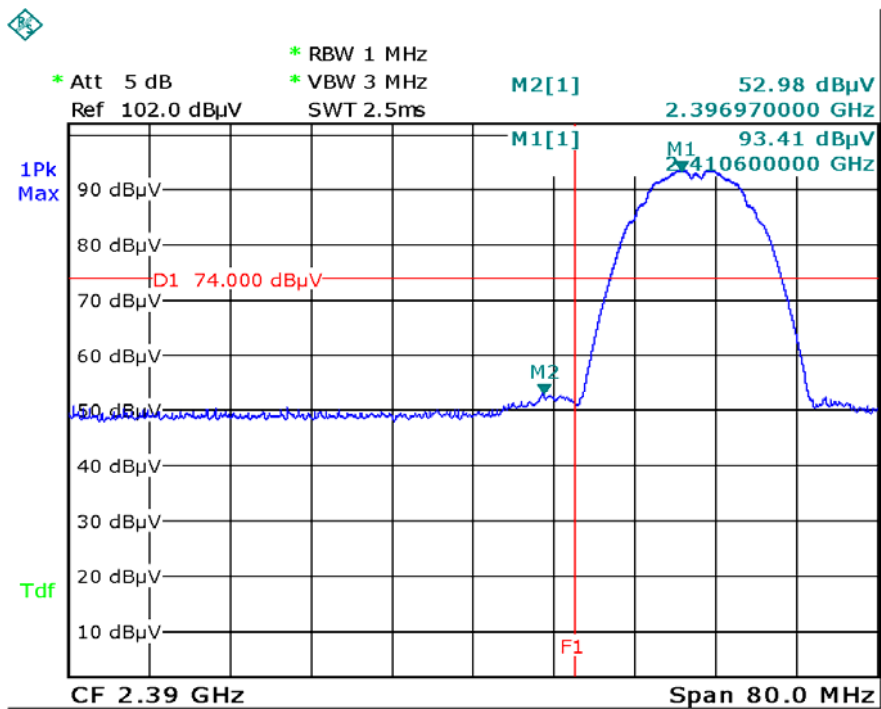

Date: 30.JUN.2014 11:26:19

B-1 PK



**SIEMIC, INC.**

Accessing global markets

Title: RF Test Report for Smart Mobile Phone  
Main Model: V6  
Serial Model: N/A  
To: FCC Part 15.247: 2013, ANSI C63.4: 2009

Report No.: 14070280-FCC-R3  
Issue Date: June 30, 2014  
Page: 40 of 72  
www.siemic.com  
www.siemic.com.cn

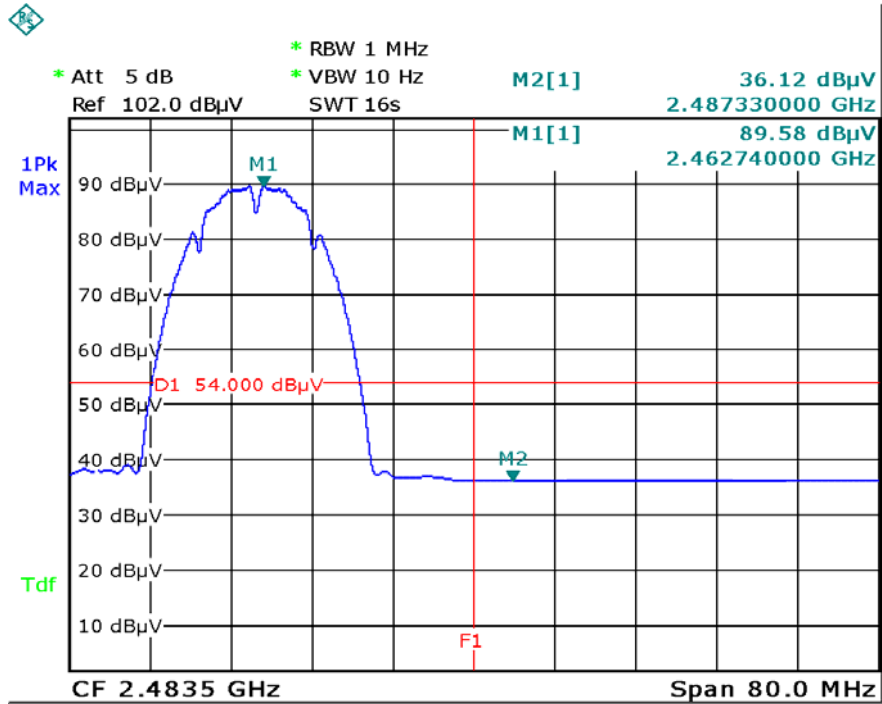

Date: 30.JUN.2014 11:55:14

### B-11 AV

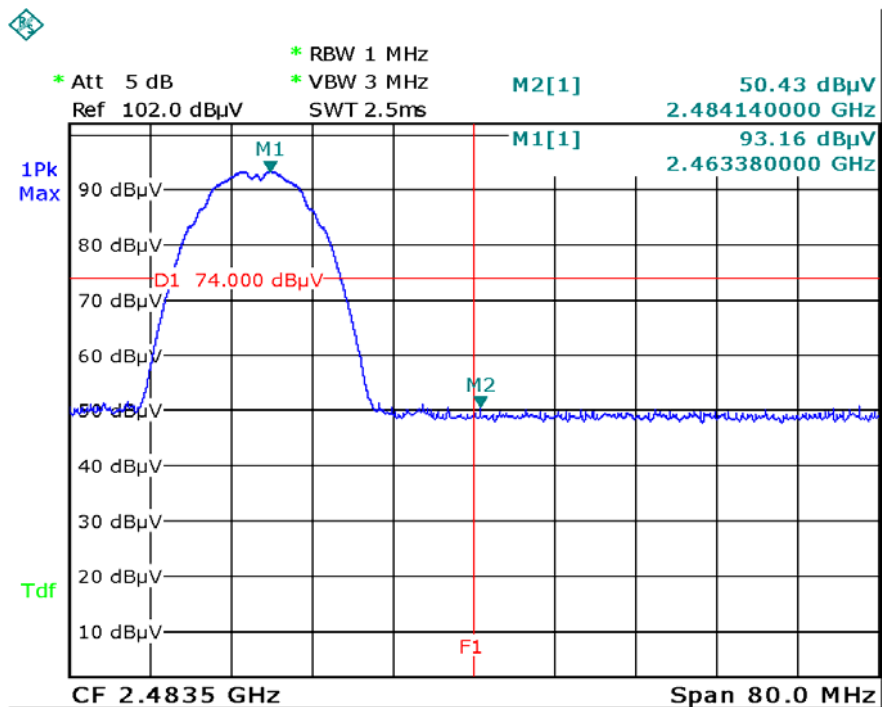

Date: 30.JUN.2014 11:54:11

### B-11 PK





**SIEMIC, INC.**

Accessing global markets

Title: RF Test Report for Smart Mobile Phone  
Main Model: V6  
Serial Model: N/A  
To: FCC Part 15.247: 2013, ANSI C63.4: 2009

Report No.: 14070280-FCC-R3  
Issue Date: June 30, 2014  
Page: 41 of 72  
www.siemec.com  
www.siemec.com.cn

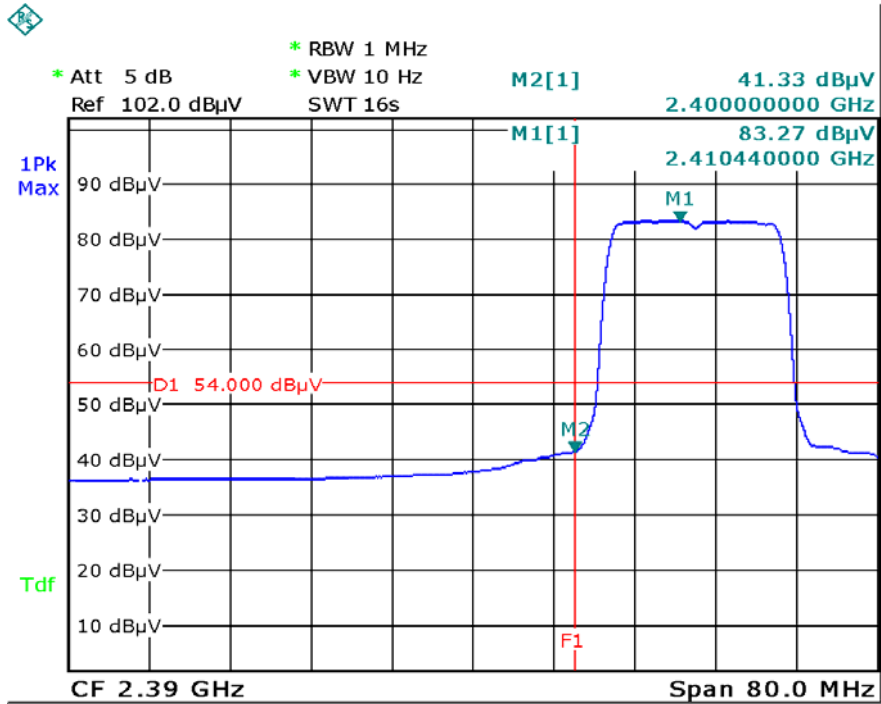

Date: 30.JUN.2014 11:30:37

G-1 AV

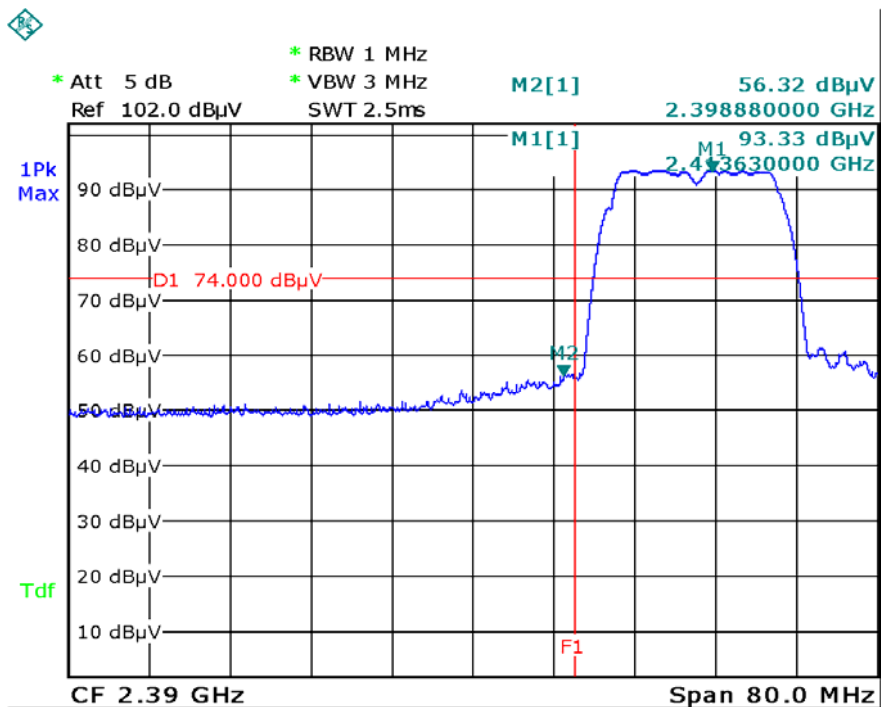

Date: 30.JUN.2014 11:32:26

G-1 PK



**SIEMIC, INC.**

Accessing global markets

Title: RF Test Report for Smart Mobile Phone  
Main Model: V6  
Serial Model: N/A  
To: FCC Part 15.247: 2013, ANSI C63.4: 2009

Report No.: 14070280-FCC-R3  
Issue Date: June 30, 2014  
Page: 42 of 72  
www.siemic.com  
www.siemic.com.cn

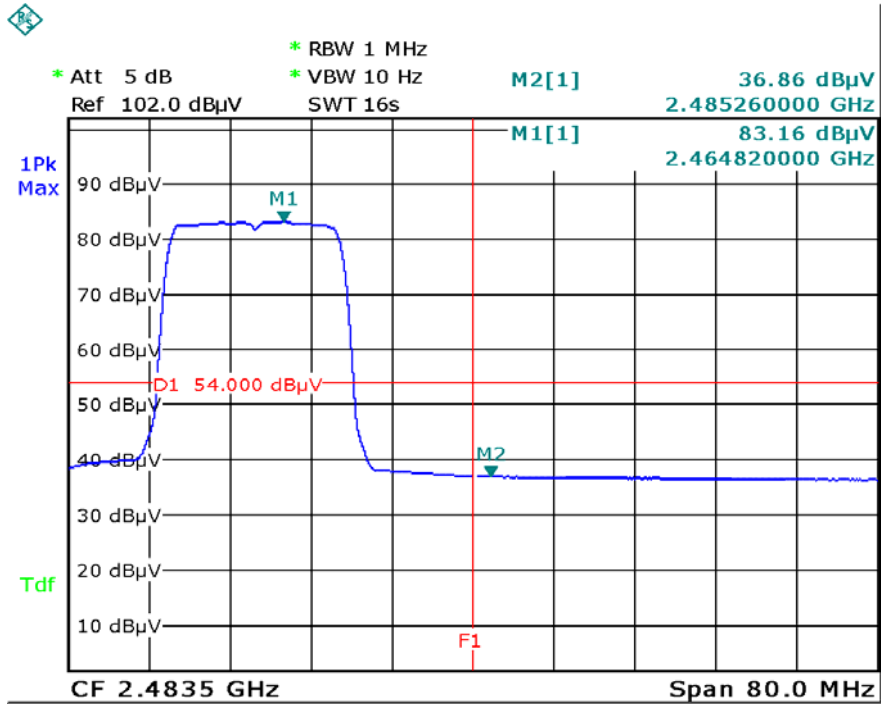

Date: 30.JUN.2014 11:50:51

G-11 AV

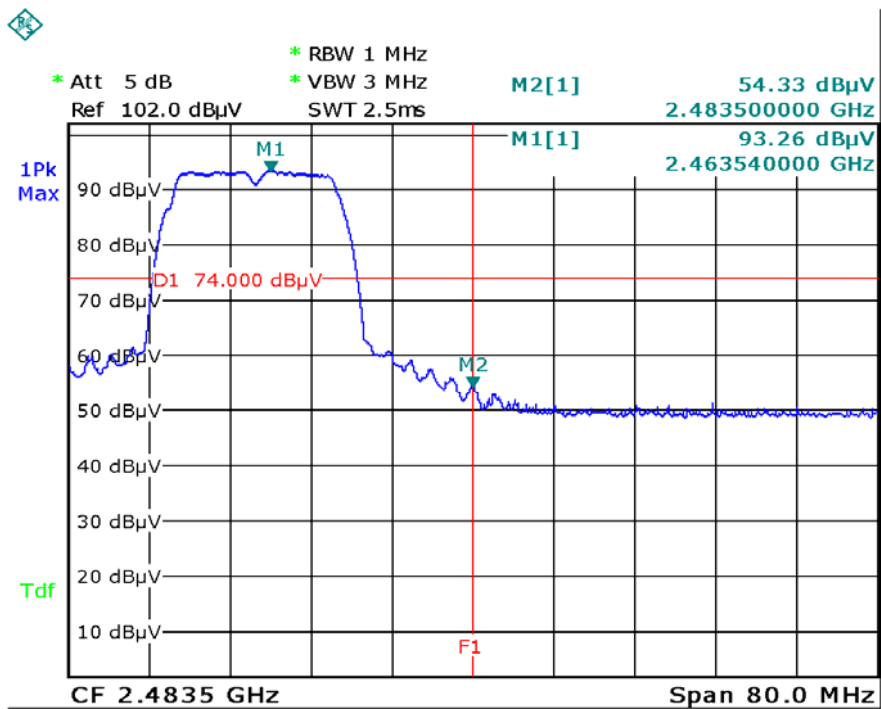

Date: 30.JUN.2014 11:52:16

G-11 PK



**SIEMIC, INC.**

Accessing global markets

Title: RF Test Report for Smart Mobile Phone  
Main Model: V6  
Serial Model: N/A  
To: FCC Part 15.247: 2013, ANSI C63.4: 2009

Report No.: 14070280-FCC-R3  
Issue Date: June 30, 2014  
Page: 43 of 72  
www.siemec.com  
www.siemec.com.cn

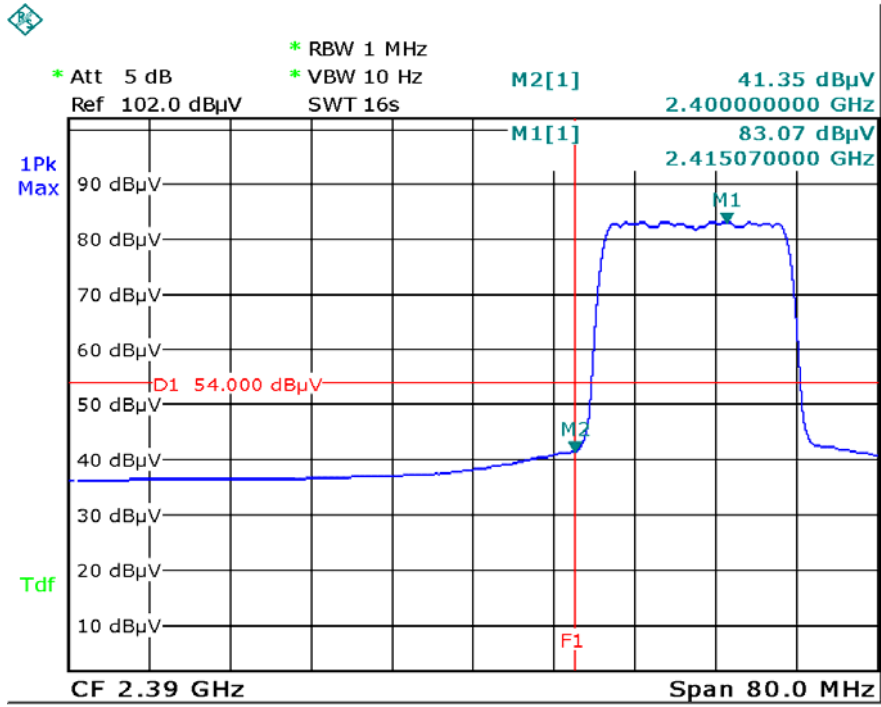

Date: 30.JUN.2014 11:40:36

N-1 AV

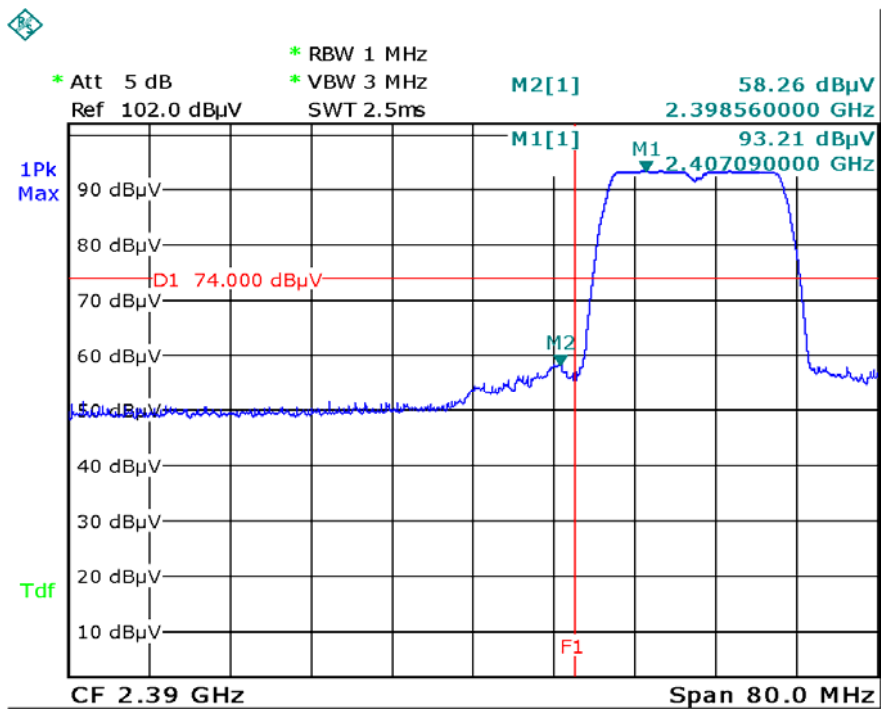

Date: 30.JUN.2014 11:37:41

N-1 PK



**SIEMIC, INC.**

Accessing global markets

Title: RF Test Report for Smart Mobile Phone  
Main Model: V6  
Serial Model: N/A  
To: FCC Part 15.247: 2013, ANSI C63.4: 2009

Report No.: 14070280-FCC-R3  
Issue Date: June 30, 2014  
Page: 44 of 72  
www.siemic.com  
www.siemic.com.cn

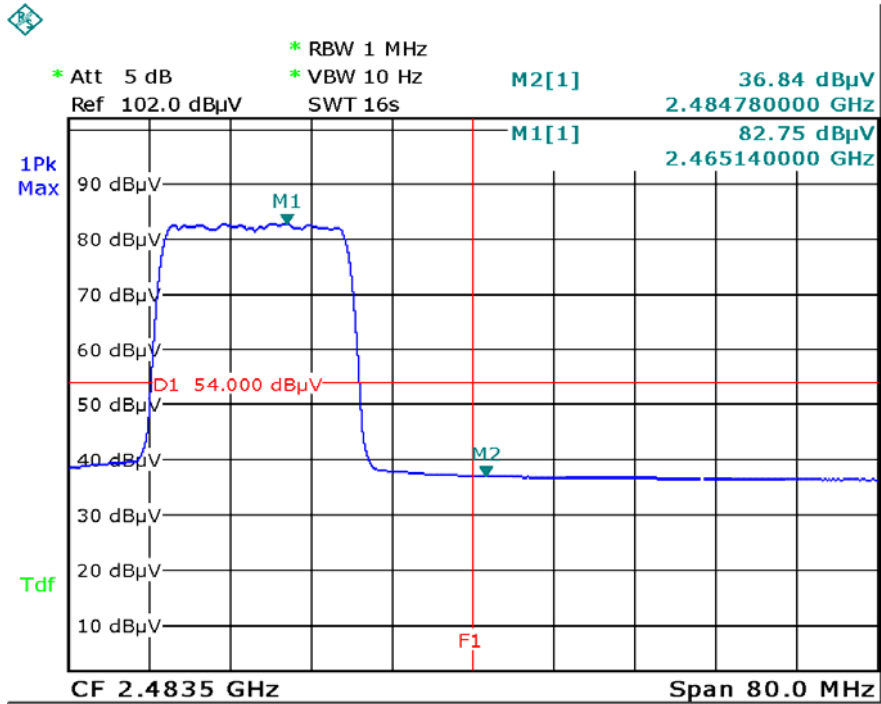

Date: 30.JUN.2014 11:48:19

N-11 AV

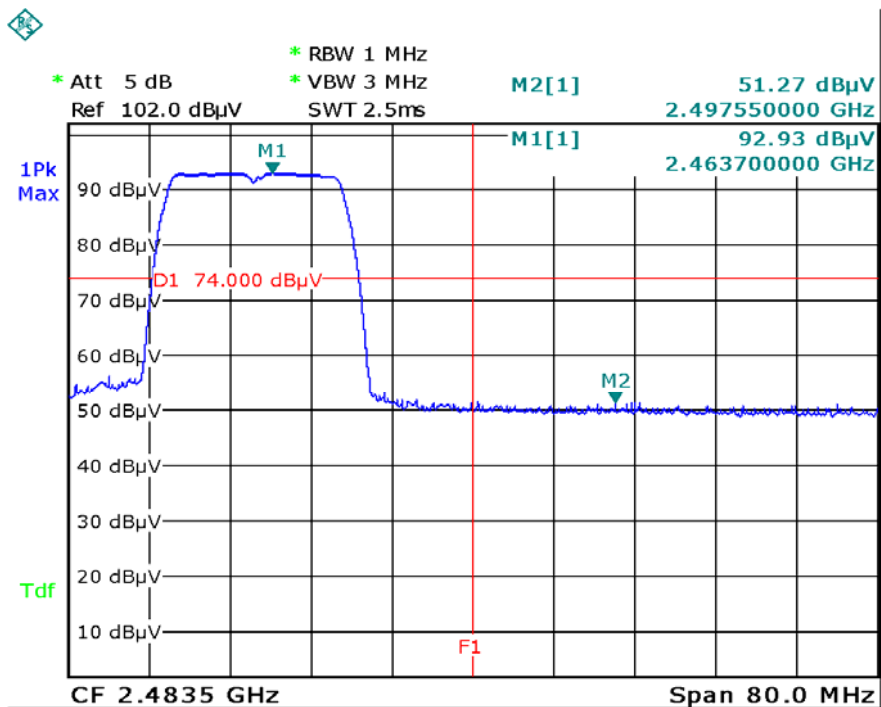

Date: 30.JUN.2014 11:46:13

N-11 PK

## **5.7 §15.207 (a) - AC Power Line Conducted Emissions**

Requirement:

Frequency of emission (MHz)	Conducted limit (dB $\mu$ V)	
	Quasi-peak	Average
0.15–0.5	66 to 56*	56 to 46*
0.5–5	56	46
5–30	60	50

\*Decreases with the logarithm of the frequency.

### **Procedures:**

1. All possible modes of operation were investigated. Only the 6 worst case emissions measured, using the correct CISPR and Average detectors, are reported. All other emissions were relatively insignificant.
2. A "-ve" margin indicates a PASS as it refers to the margin present below the limit line at the particular frequency.
3. Conducted Emissions Measurement Uncertainty  
All test measurements carried out are traceable to national standards. The uncertainty of the measurement at a confidence level of approximately 95% (in the case where distributions are normal), with a coverage factor of 2, in the range 9kHz – 30MHz (Average & Quasi-peak) is  $\pm 3.5$ dB.
4. Environmental Conditions

Temperature	23°C
Relative Humidity	56%
Atmospheric Pressure	1018mbar
5. Test date: June 04, 2014  
Tested By : Hank Li

<b>Test Mode:</b>	<b>Transmitting Mode(Worse Case)</b>
-------------------	--------------------------------------

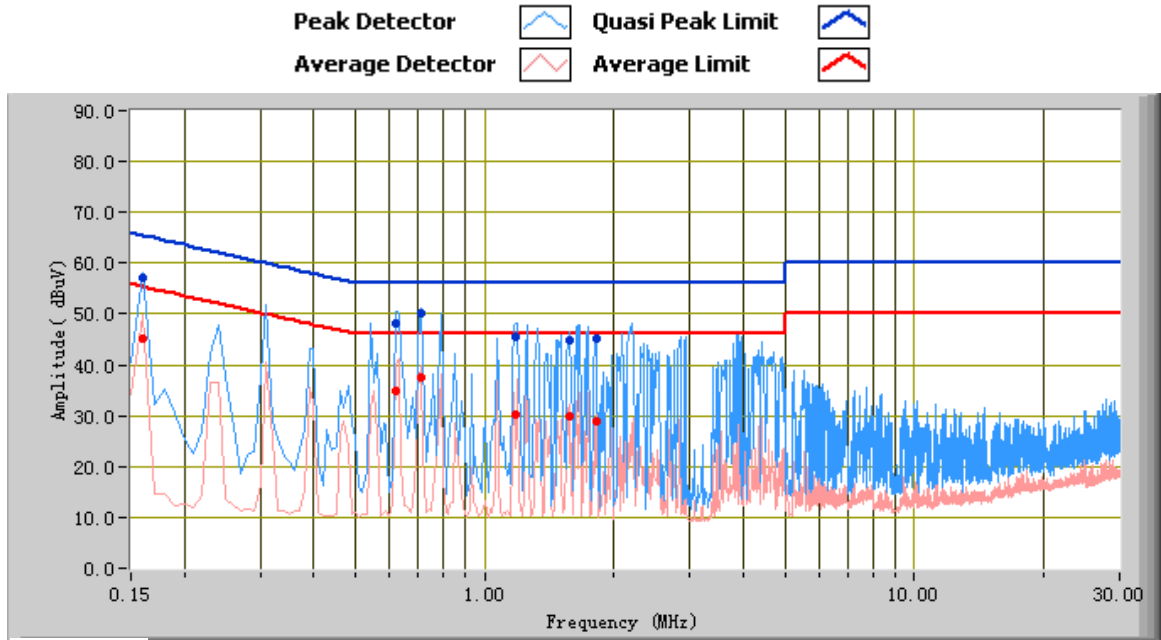

**Test Data**

**Phase Line Plot at 120Vac, 60Hz**

Frequency (MHz)	Quasi Peak (dBuV)	Limit (dBuV)	Margin (dB)	Average (dBuV)	Limit (dBuV)	Margin (dB)	Factors (dB)
0.71	50.12	56.00	-5.88	37.69	46.00	-8.31	10.44
0.62	48.09	56.00	-7.91	34.87	46.00	-11.13	10.49
0.16	57.18	65.47	-8.29	45.02	55.47	-10.45	12.43
1.18	45.62	56.00	-10.38	30.17	46.00	-15.83	10.29
1.58	44.67	56.00	-11.33	29.80	46.00	-16.20	10.36
1.82	45.21	56.00	-10.79	29.04	46.00	-16.96	10.41

<b>Test Mode:</b>	<b>Transmitting Mode(Worse Case)</b>
-------------------	--------------------------------------

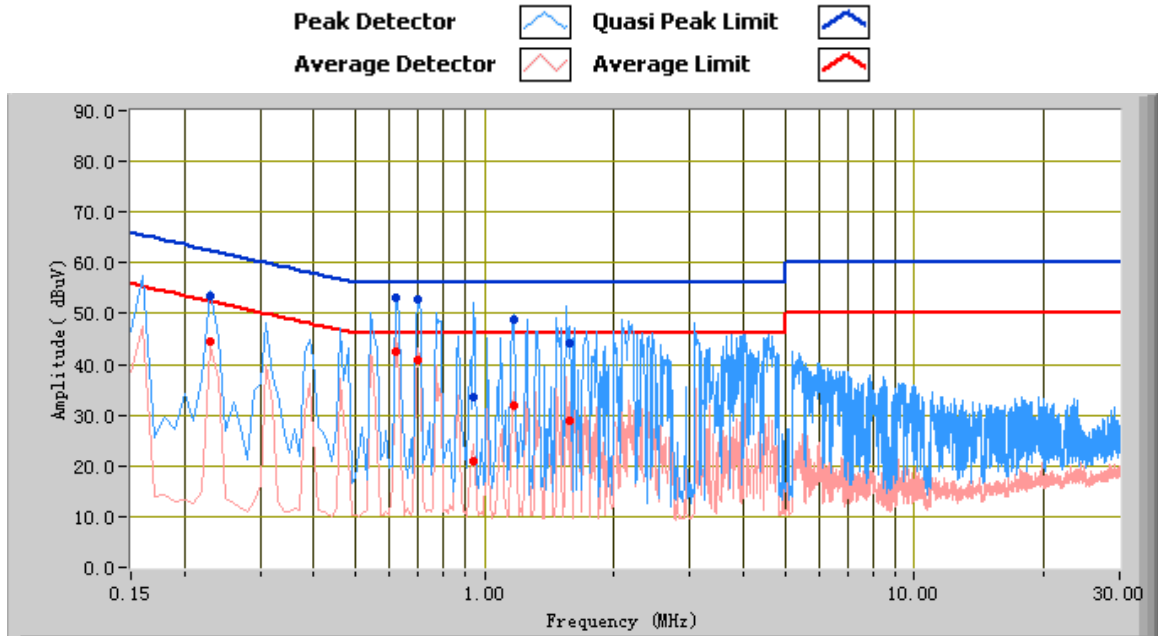

**Test Data**

**Phase Neutral Plot at 120Vac, 60Hz**

Frequency (MHz)	Quasi Peak (dBuV)	Limit (dBuV)	Margin (dB)	Average (dBuV)	Limit (dBuV)	Margin (dB)	Factors (dB)
0.62	53.02	56.00	-2.98	42.41	46.00	-3.59	10.49
0.70	52.95	56.00	-3.05	40.97	46.00	-5.03	10.45
0.94	33.56	56.00	-22.44	20.97	46.00	-25.03	10.33
1.17	48.70	56.00	-7.30	31.84	46.00	-14.16	10.29
0.23	53.52	62.45	-8.93	44.51	52.45	-7.94	11.93
1.58	44.33	56.00	-11.67	29.00	46.00	-17.00	10.36

## **5.8 §15.209, §15.205 & §15.247(d) - Radiated Spurious Emissions & Unwanted Emissions into Restricted Frequency Bands**

1. All possible modes of operation were investigated. Only the 6 worst case emissions measured, using the correct CISPR detectors, are reported. All other emissions were relatively insignificant.
2. A "-ve" margin indicates a PASS as it refers to the margin present below the limit line at the particular frequency.
3. Radiated Emissions Measurement Uncertainty  
All test measurements carried out are traceable to national standards. The uncertainty of the measurement at a confidence level of approximately 95% (in the case where distributions are normal), with a coverage factor of 2, in the range 30MHz – 1GHz & 1GHz above ( 3m & 10m) is +/-6dB.
4. Environmental Conditions
 

Temperature	24°C
Relative Humidity	59%
Atmospheric Pressure	1012mbar
5. Test date : June 07, 2014  
Tested By : Hank Li

### **Requirement:**

In any 100 kHz bandwidth outside the frequency band in which the spread spectrum or digitally modulated intentional radiator is operating, the radio frequency power that is produced by the intentional radiator shall be at least 20 dB below that in the 100 kHz bandwidth within the band that contains the highest level of the desired power, based on either an RF conducted or a radiated measurement, provided the transmitter demonstrates compliance with the peak conducted power limits. If the transmitter complies with the conducted power limits based on the use of RMS averaging over a time interval, as permitted under paragraph (b)(3) of this section, the attenuation required under this paragraph shall be 30 dB instead of 20 dB. Attenuation below the general limits specified in §15.209(a) is not required. In addition, radiated emissions which fall in the restricted bands, as defined in §15.205(a), must also comply with the radiated emission limits specified in §15.209(a) (see §15.205(c)).

### **Procedures:**

1. The EUT was switched on and allowed to warm up to its normal operating condition.
2. The test was carried out at the selected frequency points obtained from the EUT characterisation. Maximization of the emissions was carried out by rotating the EUT, changing the antenna polarization, and adjusting the antenna height in the following manner:
  - a. Vertical or horizontal polarisation (whichever gave the higher emission level over a full rotation of the EUT) was chosen.
  - b. The EUT was then rotated to the direction that gave the maximum emission.
  - c. Finally, the antenna height was adjusted to the height that gave the maximum emission.
3. A Quasi-peak measurement was then made for that frequency point for below 1GHz test, PK and AV for above 1GHz emission test.
  - a. The resolution bandwidth and video bandwidth of test receiver/spectrum analyzer is 120 kHz for Quasiy Peak detection at frequency below 1GHz.
  - b. The resolution bandwidth of test receiver/spectrum analyzer is 1MHz and video bandwidth is 3MHz for Peak detection at frequency above 1GHz.
  - c. The resolution bandwidth of test receiver/spectrum analyzer is 1MHz and the video bandwidth for Average detection (AV) as below at frequency above 1GHz.





1 kHz (Duty cycle < 98%)     
  10 Hz (Duty cycle > 98%)

4. Steps 2 and 3 were repeated for the next frequency point, until all selected frequency points were measured.

**Test Result: Pass**

<b>Test Mode:</b>	<b>Transmitting Mode(Worse Case)</b>
-------------------	--------------------------------------

(Below 1GHz)

Peak Detector   
 Quasi Peak Limit 

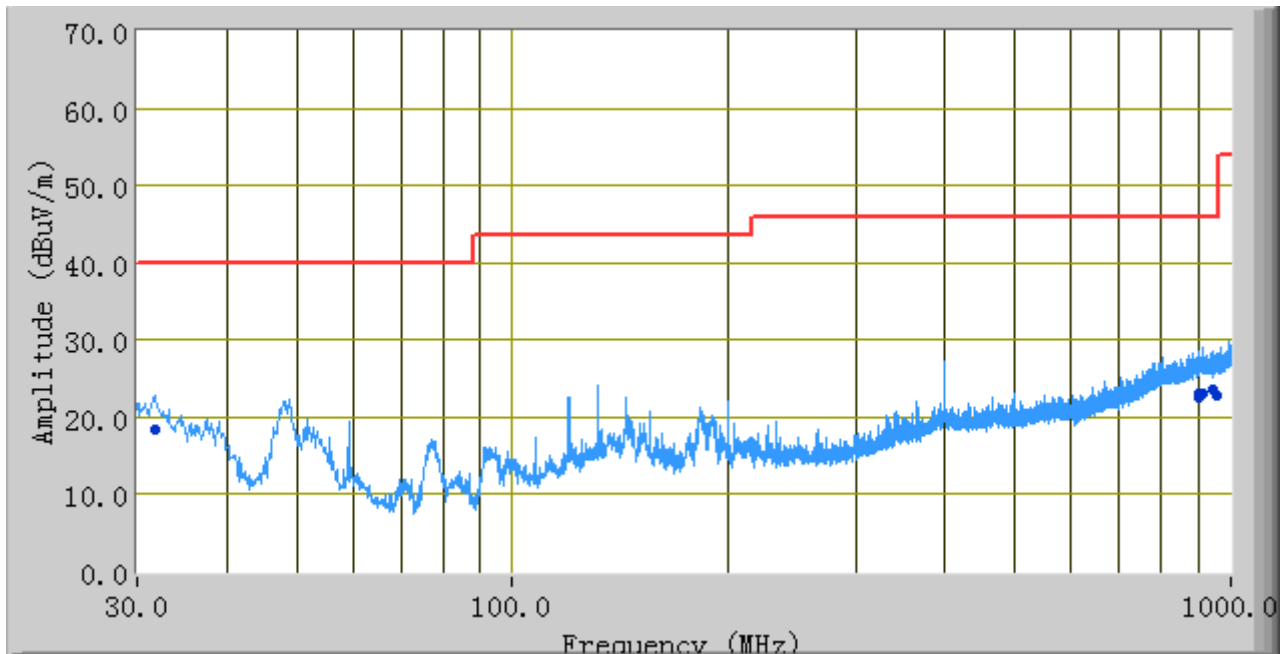

**Test Data**

**Vertical & Horizontal Polarity Plot @3m**

Frequency (MHz)	Quasi Peak (dBuV/m)	Azimuth	Polarity(H/V)	Height (cm)	Factors (dB)	Limit (dBuV)	Margin (dB)
914.49	22.98	0.00	V	400.00	5.00	46.00	-23.02
31.75	18.44	102.00	V	111.00	-2.54	40.00	-21.56
945.79	23.56	45.00	V	341.00	5.49	46.00	-22.44
904.26	22.96	0.00	H	145.00	4.84	46.00	-23.04
902.36	22.68	29.00	H	238.00	4.81	46.00	-23.32
956.43	22.85	34.00	V	274.00	5.66	46.00	-23.15

**Above 1 GHz:**

*Test Mode: Transmitting*

**Note: Other modes were verified, only the result of worst case basic rate mode was presented.**

**Mode: 802.11b**  
 Low Channel (2412 MHz)

Frequency (MHz)	Substituted level (dBμV/m)	Detector (PK/AV)	Polarity (H/V)	Ant. Factor (dB/m)	Cable Loss (dB)	Pre-Amp. Gain (dB)	Cord. Amp. (dBμV/m)	Limit (dBμV/m)	Margin (dB)
4824	39.23	AV	V	34.0	4.87	26.79	51.31	54	-2.69
4824	38.87	AV	H	33.8	4.87	26.79	50.75	54	-3.25
4824	48.06	PK	V	34.0	4.87	26.79	60.14	74	-13.86
4824	47.24	PK	H	33.8	4.87	26.79	59.12	74	-14.88

Middle Channel (2437 MHz)

Frequency (MHz)	Substituted level (dBμV/m)	Detector (PK/AV)	Polarity (H/V)	Ant. Factor (dB/m)	Cable Loss (dB)	Pre-Amp. Gain (dB)	Cord. Amp. (dBμV/m)	Limit (dBμV/m)	Margin (dB)
4874	39.17	AV	V	33.6	4.87	26.78	50.86	54	-3.14
4874	39.21	AV	H	33.8	4.87	26.78	51.10	54	-2.90
4874	47.83	PK	V	33.6	4.87	26.78	59.52	74	-14.48
4874	48.11	PK	H	33.8	4.87	26.78	60.0	74	-14.0

High Channel (2462 MHz)

Frequency (MHz)	Substituted level (dBμV/m)	Detector (PK/AV)	Polarity (H/V)	Ant. Factor (dB/m)	Cable Loss (dB)	Pre-Amp. Gain (dB)	Cord. Amp. (dBμV/m)	Limit (dBμV/m)	Margin (dB)
4924	38.89	AV	V	34.6	4.87	26.75	51.61	54	-2.39
4924	38.75	AV	H	34.7	4.87	26.75	51.57	54	-2.43
4924	48.06	PK	V	34.6	4.87	26.75	60.78	74	-13.22
4924	47.96	PK	H	34.7	4.87	26.75	60.78	74	-13.22

## **Annex A. TEST INSTRUMENT & METHOD**

### **Annex A.i. TEST INSTRUMENTATION & GENERAL PROCEDURES**

<b>Instrument</b>	<b>Model</b>	<b>Serial #</b>	<b>Calibration Date</b>	<b>Calibration Due Date</b>
<b>AC Line Conducted Emissions</b>				
EMI test receiver	ESCS30	8471241027	05/27/2014	05/26/2015
Line Impedance Stabilization Network	LI-125A	191106	11/14/2013	11/13/2014
Line Impedance Stabilization Network	LI-125A	191107	11/14/2013	11/13/2014
LISN	ISN T800	34373	01/11/2014	01/10/2015
Double Ridge Horn Antenna (1 ~18GHz)	AH-118	71283	11/20/2013	11/19/2014
Transient Limiter	LIT-153	531118	09/02/2013	09/01/2014
<b>RF conducted test</b>				
Agilent ESA-E SERIES SPECTRUM ANALYZER	E4407B	MY45108319	09/17/2013	09/16/2014
Power Splitter	1#	1#	09/02/2013	09/01/2014
DC Power Supply	E3640A	MY40004013	09/17/2013	09/16/2014
Wireless Connectivity Test Set	N4010A	GB44440198	03/20/2014	03/19/2015
<b>Radiated Emissions</b>				
EMI test receiver	ESL6	100262	11/23/2013	11/22/2014
Positioning Controller	UC3000	MF780208282	11/19/2013	11/19/2014
OPT 010 AMPLIFIER (0.1-1300MHz)	8447E	2727A02430	09/02/2013	09/01/2014
Microwave Preamplifier (0.5~18GHz)	PAM-118	443008	09/02/2013	09/01/2014
Bilog Antenna (30MHz~6GHz)	JB6	A110712	09/23/2013	09/22/2014
Double Ridge Horn Antenna (1 ~18GHz)	AH-118	71283	11/20/2013	11/19/2014
Universal Radio Communication Tester	CMU200	121393	09/17/2013	09/16/2014

## **Annex A.ii. CONDUCTED EMISSIONS TEST DESCRIPTION**

### **Test Set-up**

1. The EUT and supporting equipment were set up in accordance with the requirements of the standard on top of a 1.5m x 1m x 0.8m high, non-metallic table, as shown in Annex B.
2. The power supply for the EUT was fed through a 50Ω/50μH EUT LISN, connected to filtered mains.
3. The RF OUT of the EUT LISN was connected to the EMI test receiver via a low-loss coaxial cable.
4. All other supporting equipments were powered separately from another main supply.

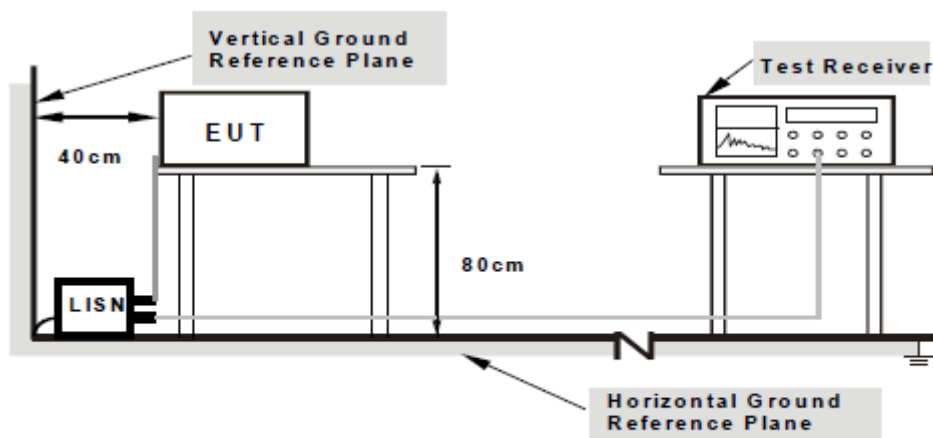

**Note: 1. Support units were connected to second LISN.  
 2. Both of LISNs (AMN) are 80cm from EUT and at least 80cm from other units and other metal planes support units.**

For the actual test configuration, please refer to the related item – Photographs of the Test Configuration1.

### **Test Method**

1. The EUT was switched on and allowed to warm up to its normal operating condition.
2. A scan was made on the NEUTRAL line (for AC mains) or Earth line (for DC power) over the required frequency range using an EMI test receiver.
3. High peaks, relative to the limit line, were then selected.
4. The EMI test receiver was then tuned to the selected frequencies and the necessary measurements made with a receiver bandwidth setting of 10 kHz. For FCC tests, only Quasi-peak measurements were made; while for CISPR/EN tests, both Quasi-peak and Average measurements were made.
5. Steps 2 to 4 were then repeated for the LIVE line (for AC mains) or DC line (for DC power).

### **Description of Conducted Emission Program**

This EMC Measurement software run LabView automation software and offers a common user interface for electromagnetic interference (EMI) measurements. This software is a modern and powerful tool for controlling and monitoring EMI test receivers and EMC test systems. It guarantees reliable collection, evaluation, and documentation of measurement results. Basically, this program will run a pre-scan measurement before it proceeds with the final measurement. The pre-scan routine will run the common scan range from 150 kHz to 30 MHz; the program will first start a peak and average scan on selectable measurement time and step size. After the program complete the pre-scan, this program will perform the Quasi Peak and Average measurement, based on the pre-scan peak data reduction result.



**SIEMIC, INC.**

Accessing global markets

Title: RF Test Report for Smart Mobile Phone  
Main Model: V6  
Serial Model: N/A  
To: FCC Part 15.247: 2013, ANSI C63.4: 2009

Report No.: 14070280-FCC-R3  
Issue Date: June 30, 2014  
Page: 53 of 72  
www.siemec.com  
www.siemec.com.cn

### **Sample Calculation Example**

At 20 MHz

limit =  $250 \mu\text{V} = 47.96 \text{ dB}\mu\text{V}$

Transducer factor of LISN, pulse limiter & cable loss at 20 MHz = 11.20 dB

Q-P reading obtained directly from EMI Receiver =  $40.00 \text{ dB}\mu\text{V}$   
(Calibrated for system losses)

Therefore, Q-P margin =  $47.96 - 40.00 = 7.96$  i.e. **7.96 dB below limit**

**Annex B. EUT AND TEST SETUP PHOTOGRAPHS**

**Annex B.i. Photograph 1: EUT External Photo**



Whole Package - Top View

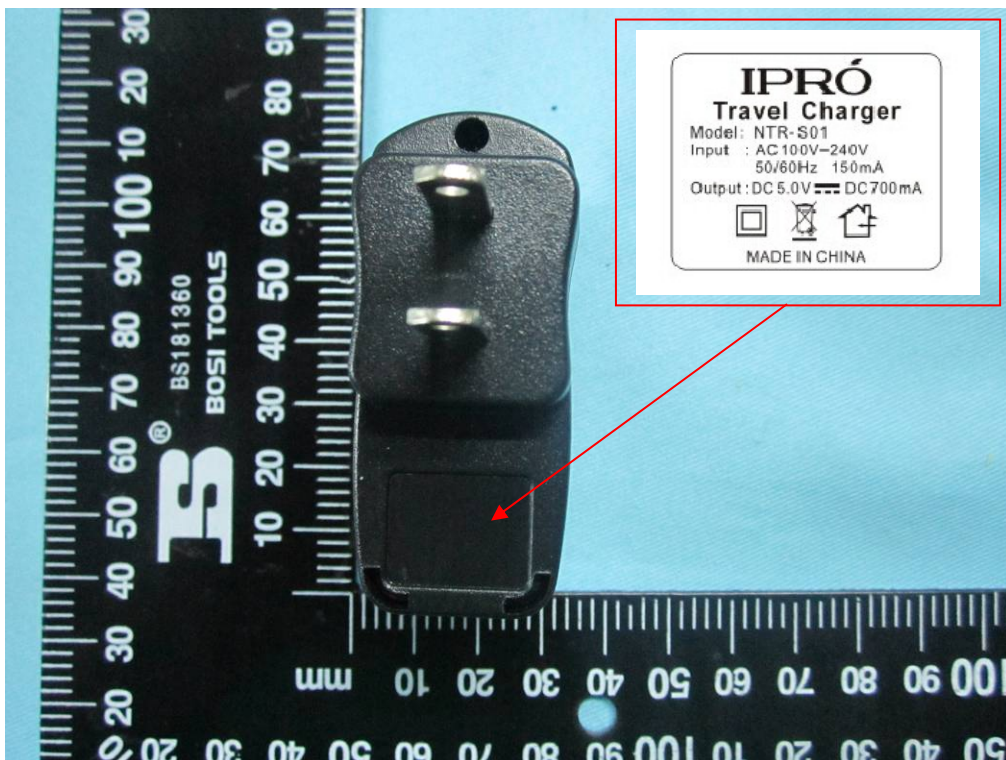

Adapter – Front View



EUT - Front View



EUT - Rear View



**SIEMIC, INC.**

Accessing global markets

Title: RF Test Report for Smart Mobile Phone  
Main Model: V6  
Serial Model: N/A  
To: FCC Part 15.247: 2013, ANSI C63.4: 2009

Report No.: 14070280-FCC-R3  
Issue Date: June 30, 2014  
Page: 56 of 72  
www.siemic.com  
www.siemic.com.cn



EUT - Top View



EUT - Bottom View





EUT - Left View



EUT - Right View

**Annex B.ii. Photograph 2: EUT Internal Photo**



Cover Off - Top View 1



Cover Off - Top View 2

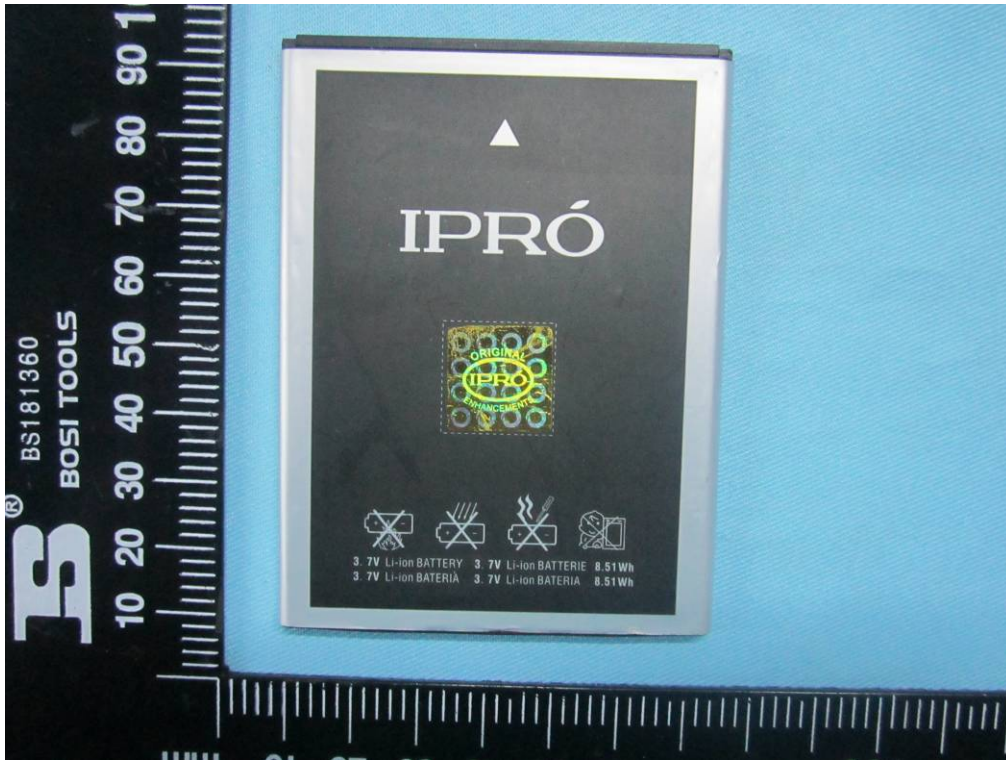

Battery - Top View



Battery - Bottom View



LCD – Front View

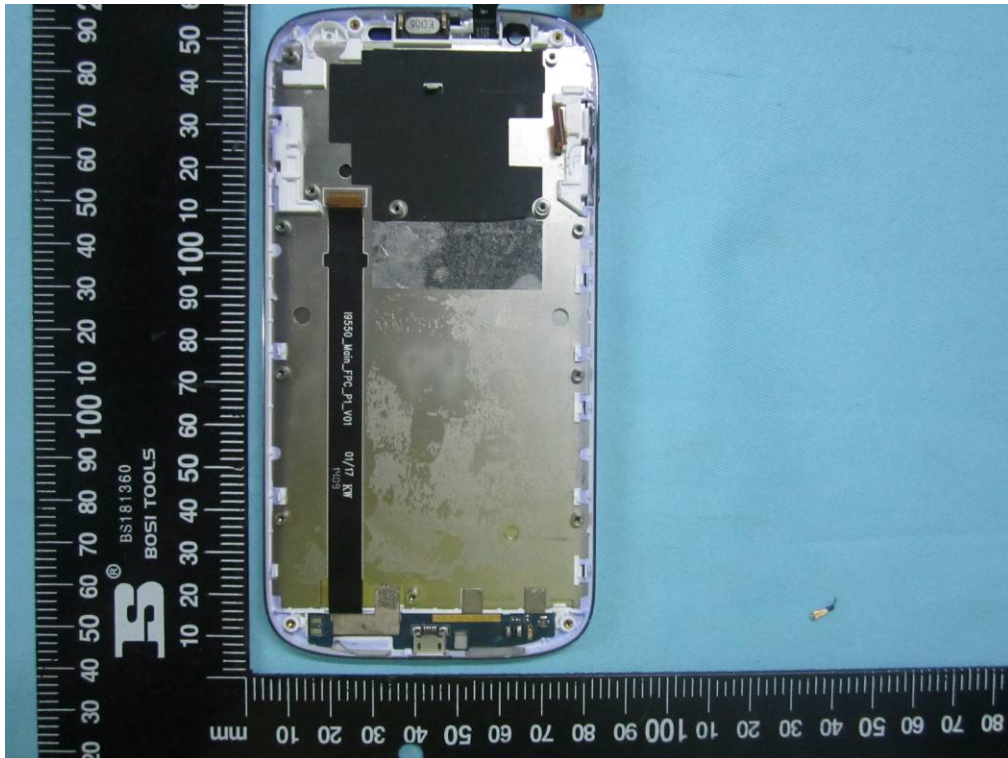

LCD – Rear View

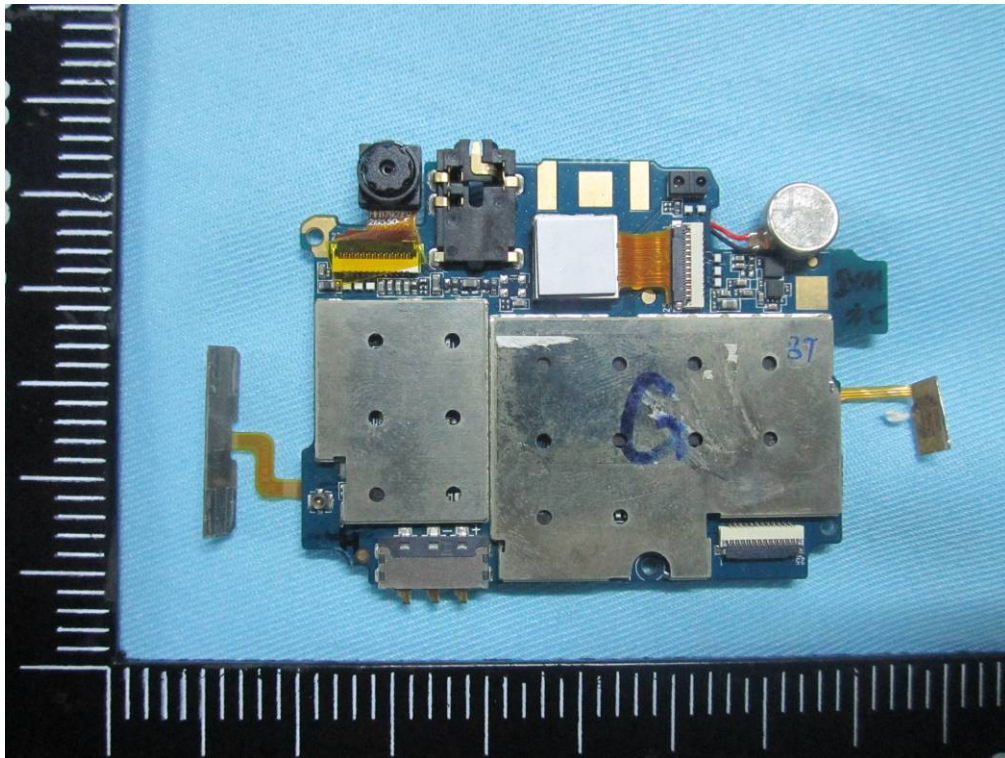

Mainboard With Shielding - Front View

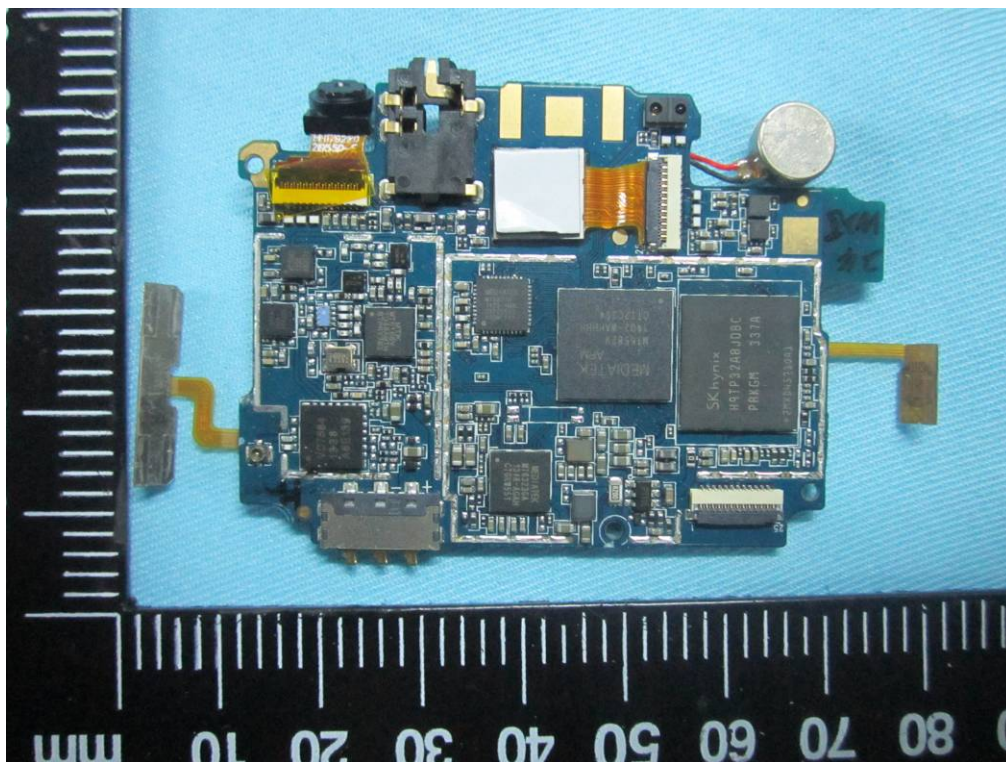

Mainboard Without Shielding - Front View

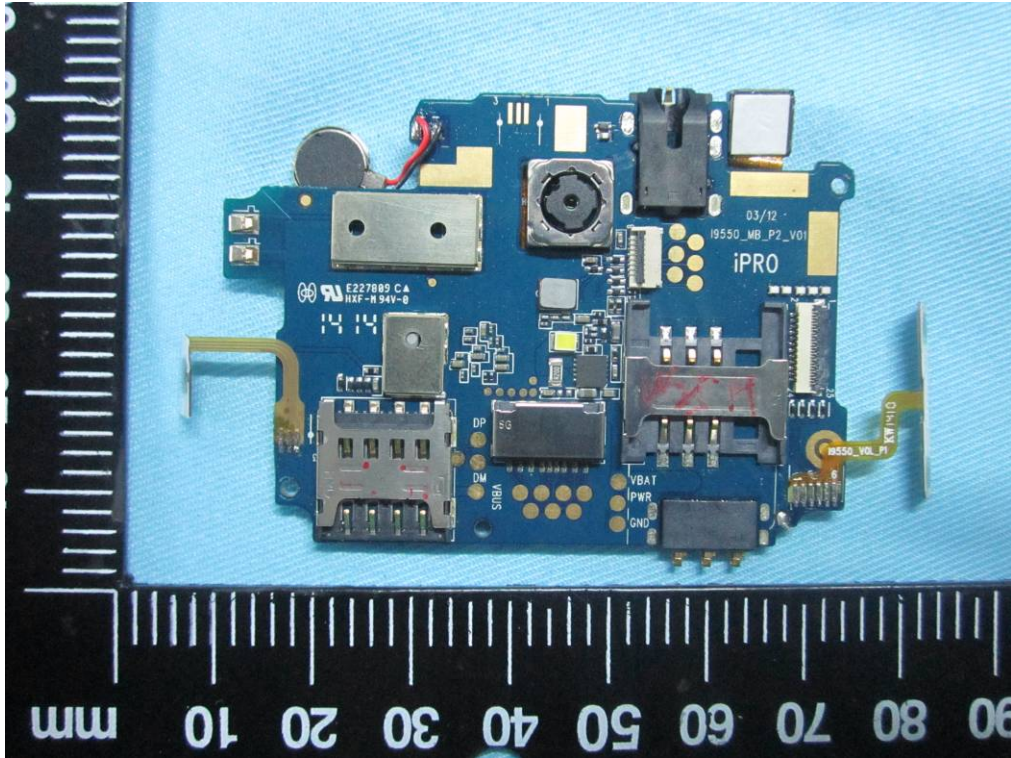

Mainboard With Shielding– Rear View

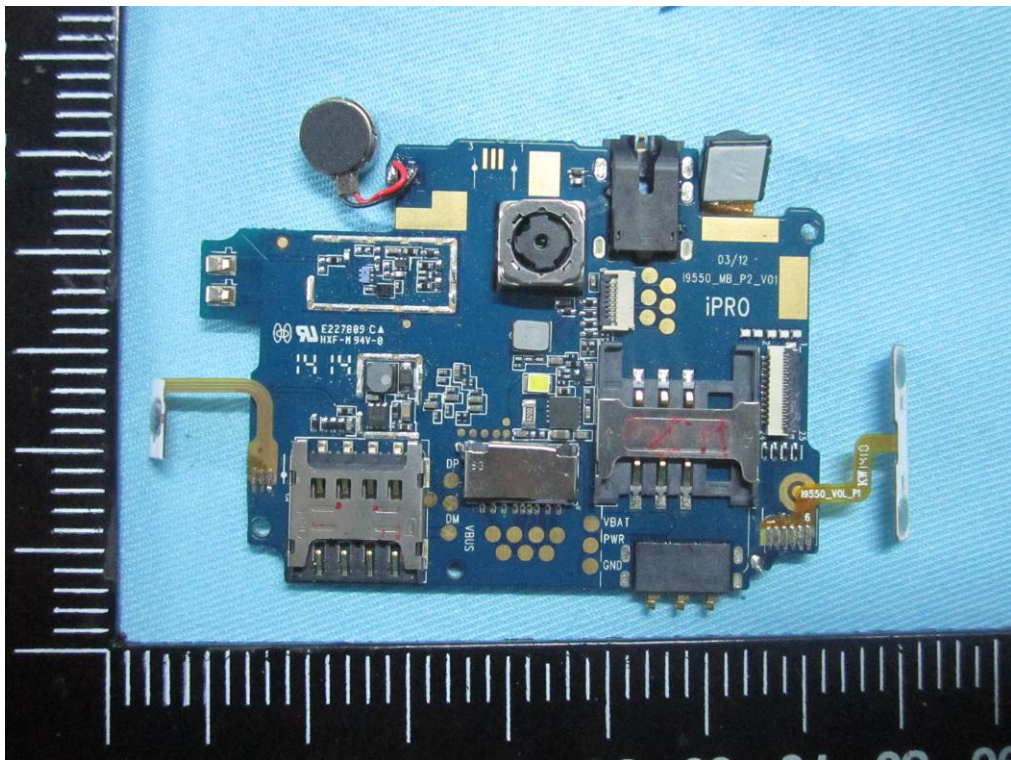

Mainboard Without Shielding– Rear View

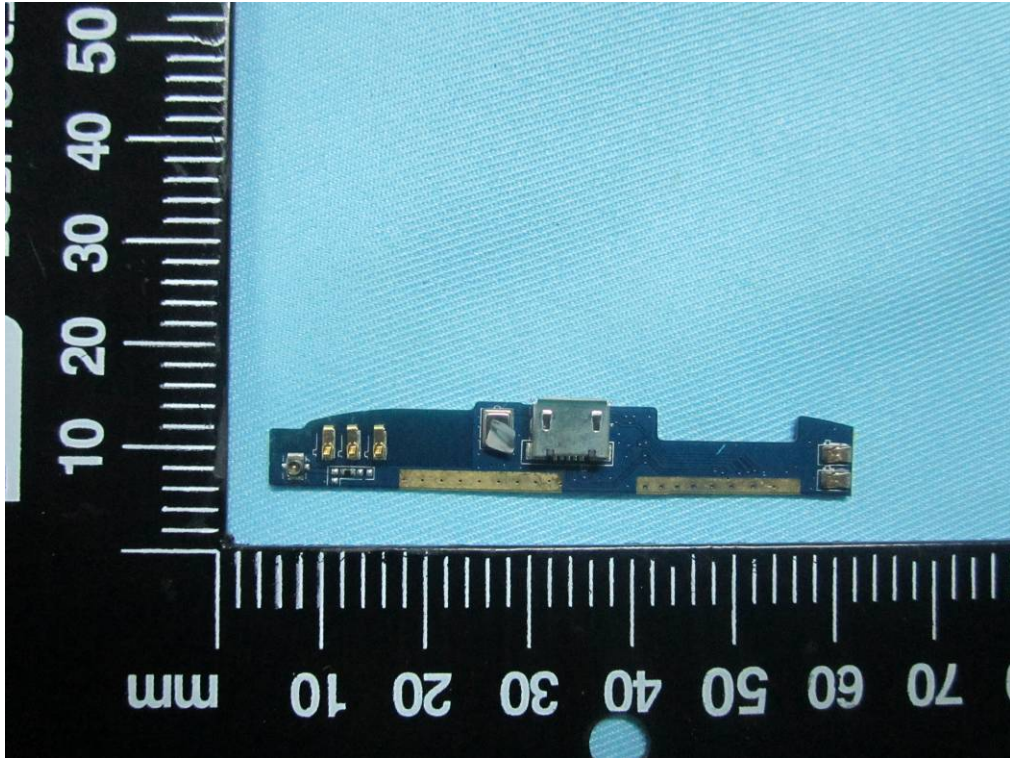

Connect board – Front View

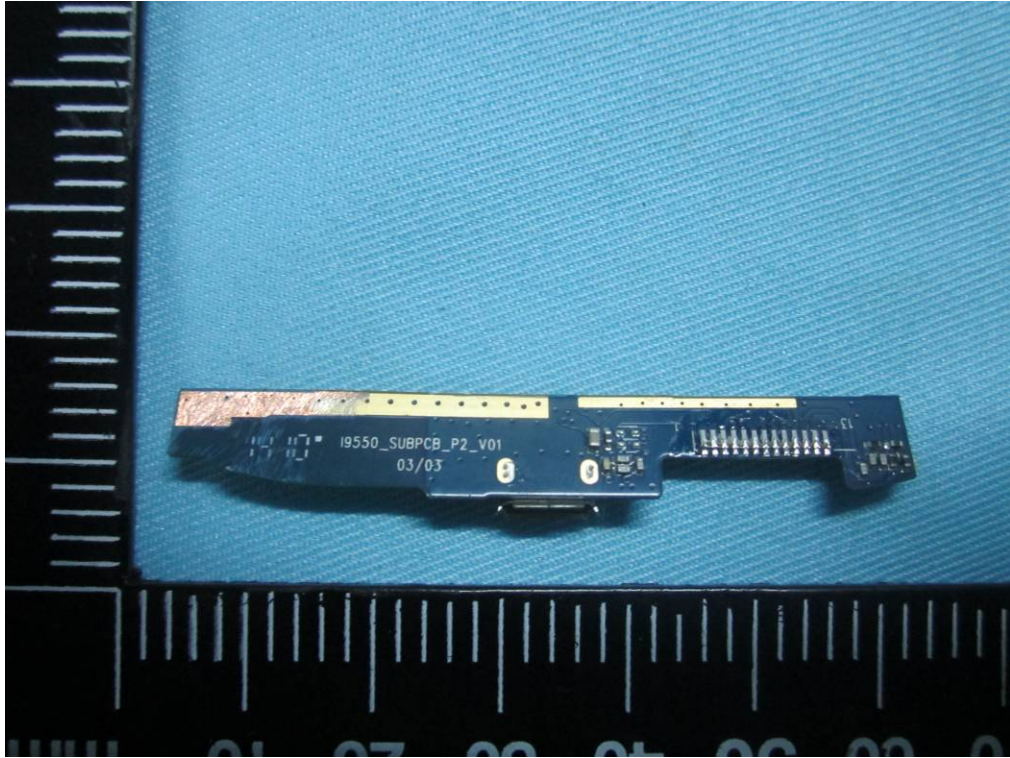

Connect board – Rear View

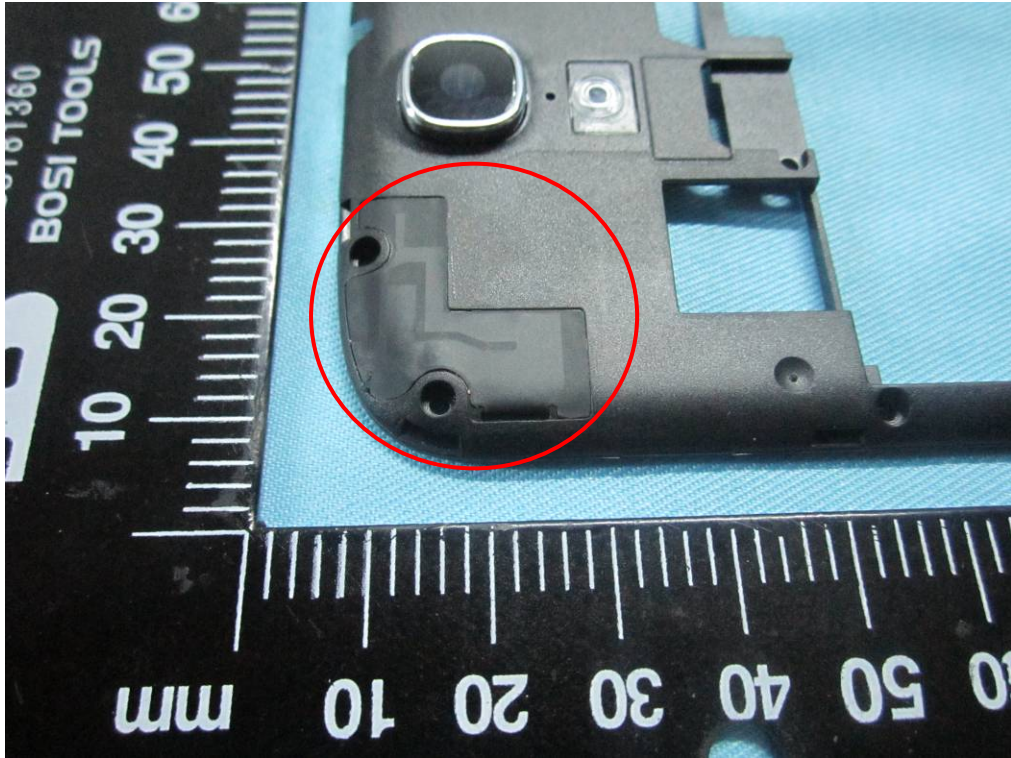

BT/BLE/WIFI Antenna View



GSM/PCS/UMTS-FDD Antenna



**Annex B.iii. Photograph 3: Test Setup Photo**



Conducted Emissions Test Setup Front View



Conducted Emissions Test Setup Side View

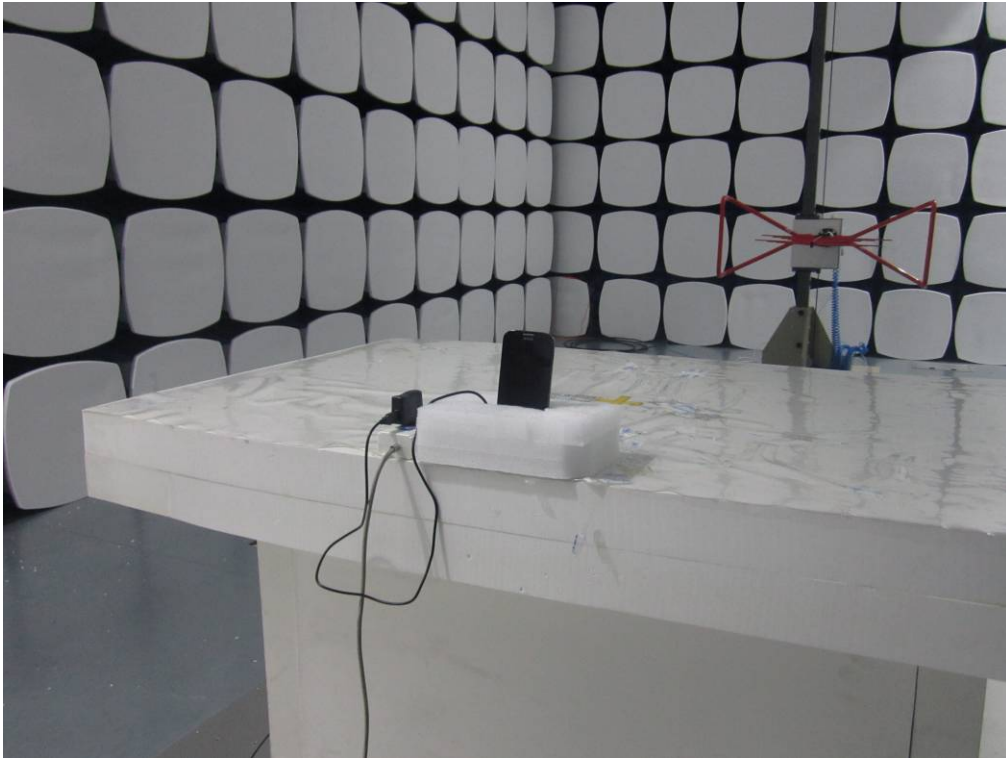

Radiated Spurious Emissions Test Setup Below 1GHz - Front View

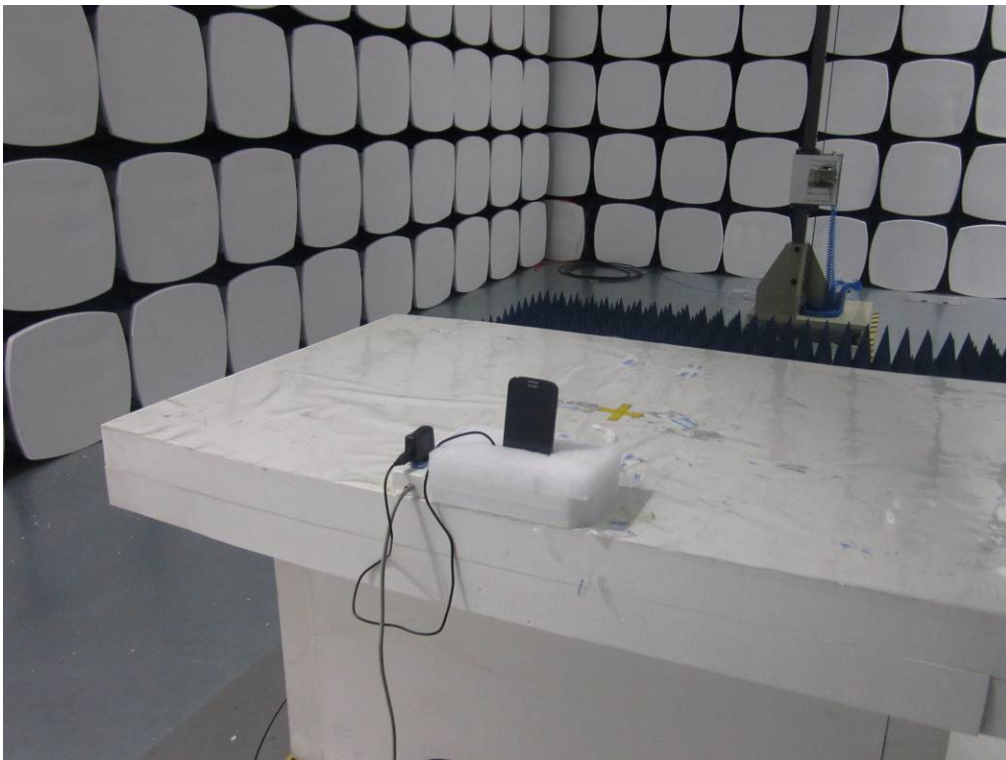

Radiated Spurious Emissions Test Setup Above 1GHz –Front View

**Annex C. TEST SETUP AND SUPPORTING EQUIPMENT**

**EUT TEST CONDITIONS**

**Annex C. i. SUPPORTING EQUIPMENT DESCRIPTION**

The following is a description of supporting equipment and details of cables used with the EUT.

Manufacturer	Equipment Description (Including Brand Name)	Model	Calibration Date	Calibration Due Date
N/A	N/A	N/A	N/A	N/A

**Block Configuration Diagram for AC Line Conducted Emissions**

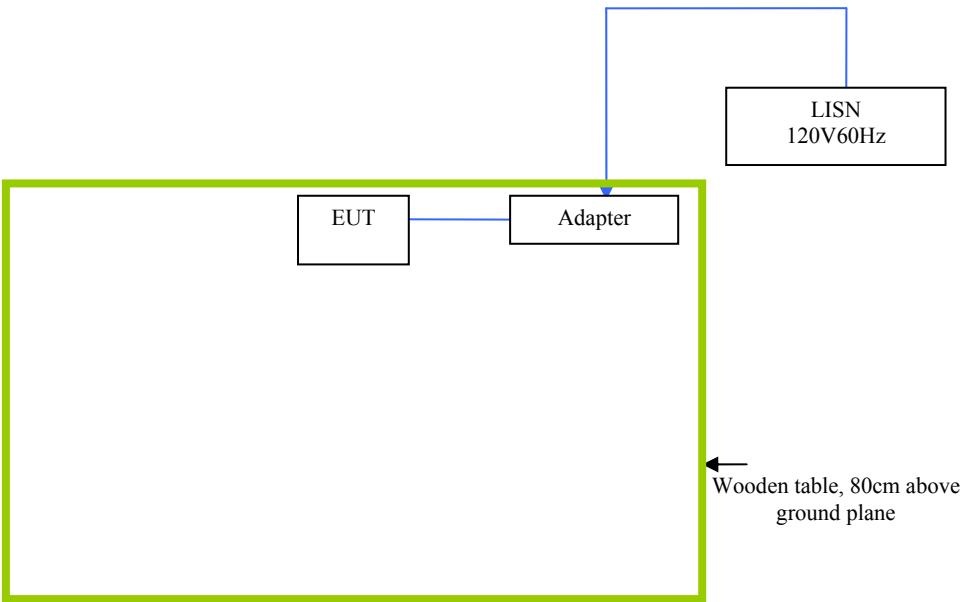

**Block Configuration Diagram for Radiated Emissions**

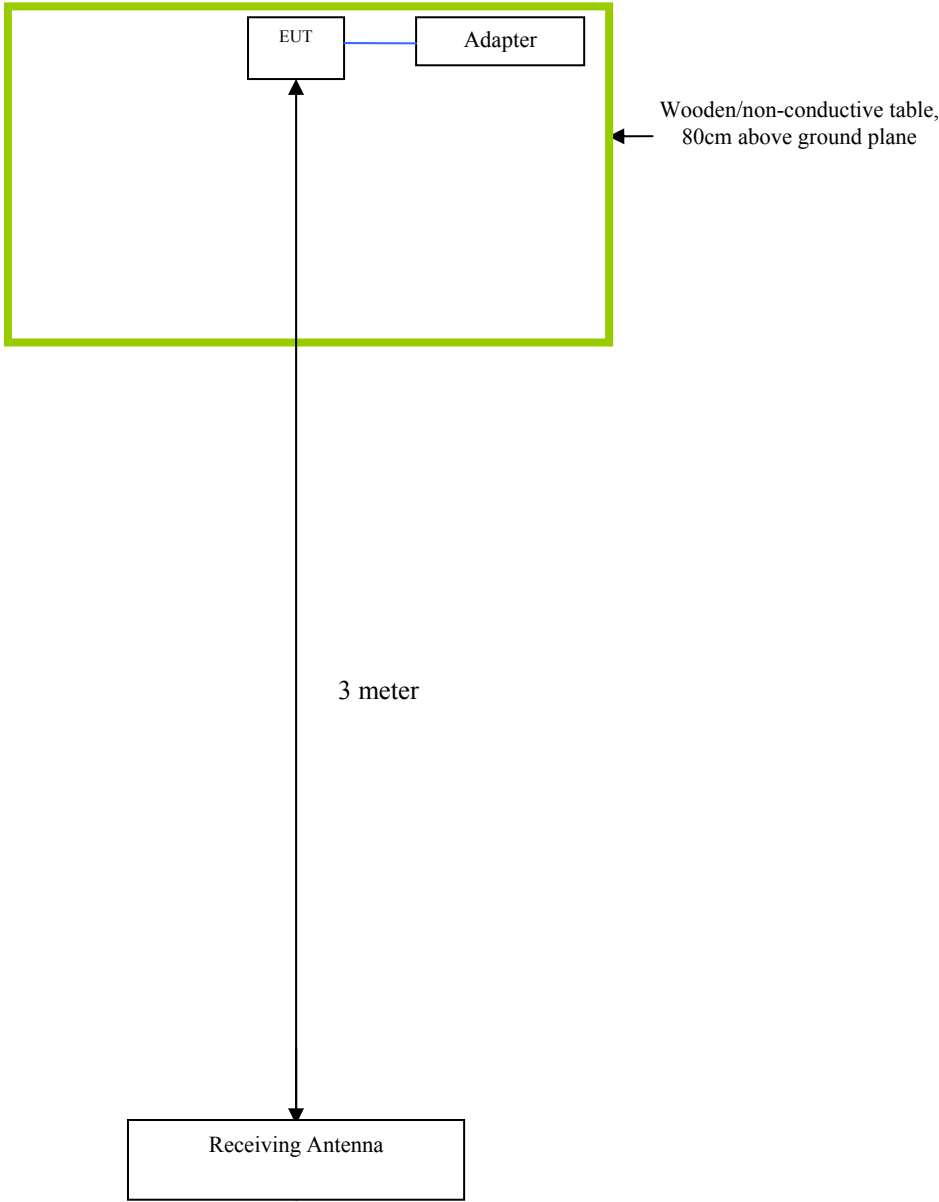

**Annex C.ii. EUT OPERATING CONDITIONS**

The following is the description of how the EUT is exercised during testing.

Test	Description Of Operation
Emissions Testing	The EUT was continuously transmitting to stimulate the worst case.



**SIEMIC, INC.**

Accessing global markets

Title: RF Test Report for Smart Mobile Phone  
Main Model: V6  
Serial Model: N/A  
To: FCC Part 15.247: 2013, ANSI C63.4: 2009

Report No.: 14070280-FCC-R3  
Issue Date: June 30, 2014  
Page: 71 of 72  
[www.siemic.com](http://www.siemic.com)  
[www.siemic.com.cn](http://www.siemic.com.cn)

## **Annex D. USER MANUAL / BLOCK DIAGRAM / SCHEMATICS / PART LIST**

**Please see attachment**



**SIEMIC, Inc.**

Accessing global markets

Title: RF Test Report for Smart Mobile Phone  
Main Model: V6  
Serial Model: N/A  
To: FCC Part 15.247: 2013, ANSI C63.4: 2009

Report No.: 14070280-FCC-R3  
Issue Date: June 30, 2014  
Page: 72 of 72  
[www.siemic.com](http://www.siemic.com)  
[www.siemic.com.cn](http://www.siemic.com.cn)

## **Annex E. DECLARATION OF SIMILARITY**

**N/A**