SAR Test Report

Report No.: AGC10211200901FH01

FCC ID : PQ4IPROS601

APPLICATION PURPOSE : Original Equipment

PRODUCT DESIGNATION : SMART PHONE

BRAND NAME : IPRO

MODEL NAME : S601

APPLICANT : HONG KONG IPRO TECHNOLOGY CO.,LIMITED

DATE OF ISSUE : Oct. 16,2020

STANDARD(S) : IEEE Std. 1528:2013
FCC 47 CFR Part 2§2.1093:2013
IEEE Std C95.1™-2005
IEC 62209-1: 2016

REPORT VERSION : V1.0

Attestation of Global Compliance (Shenzhen) Co., Ltd.



Any report having not been signed by authorized approver, or having been altered without authorization, or having not been stamped by the "Dedicated Testing/Inspection Stamp" is deemed to be invalid. Copying or excerpting portion of, or altering the content of the report is not permitted without the written authorization of AGC. The test results presented in the report apply only to the tested sample. Any objections to report issued by AGC should be submitted to AGC within 15days after the issuance of the test report. Further enquiry of validity or verification of the test report should be addressed to AGC by agc@agc-cert.com.

Attestation of Global Compliance(Shenzhen)Co., Ltd
Attestation of Global Compliance(Shenzhen)Std & Tech Co., Ltd
Tel: +86-755 2523 4088 E-mail: agc@agc-cert.com Web: <http://cn.agc-cert.com/>



Report Revise Record

| Report Version | Revise Time | Issued Date | Valid Version | Notes |
|----------------|-------------|--------------|---------------|-----------------|
| V1.0 | / | Oct. 16,2020 | Valid | Initial Release |

Any report having not been signed by authorized approver, or having been altered without authorization, or having not been stamped by the "Dedicated Testing/Inspection Stamp" is deemed to be invalid. Copying or excerpting portion of, or altering the content of the report is not permitted without the written authorization of AGC. The test results presented in the report apply only to the tested sample. Any objections to report issued by AGC should be submitted to AGC within 15days after the issuance of the test report. Further enquiry of validity or verification of the test report should be addressed to AGC by agc@agc-cert.com.

Attestation of Global Compliance(Shenzhen)Co., Ltd
Attestation of Global Compliance(Shenzhen)Std & Tech Co., Ltd
Tel: +86-755 2523 4088 E-mail: agc@agc-cert.com Web: <http://cn.agc-cert.com/>



| Test Report | |
|----------------------|---|
| Applicant Name | HONG KONG IPRO TECHNOLOGY CO.,LIMITED |
| Applicant Address | 12/F,3 LOCKHART ROAD,WANCHAI ,HK |
| Manufacturer Name | HONG KONG IPRO TECHNOLOGY CO.,LIMITED |
| Manufacturer Address | 12/F,3 LOCKHART ROAD,WANCHAI ,HK |
| Factory Name | HONG KONG IPRO TECHNOLOGY CO.,LIMITED |
| Factory Address | 12/F,3 LOCKHART ROAD,WANCHAI ,HK |
| Product Designation | SMART PHONE |
| Brand Name | IPRO |
| Model Name | S601 |
| EUT Voltage | DC3.8V by battery |
| Applicable Standard | IEEE Std. 1528:2013 FCC 47 CFR Part 2§2.1093:2013 IEEE Std C95.1™-2005 IEC 62209-1: 2016 |
| Test Date | Sep. 23,2020 to Sep. 29,2020 |
| Report Template | AGCRT-US-4G/SAR (2018-01-01) |

Note: The results of testing in this report apply to the product/system which was tested only.

Jack Gui

Prepared By

Jack Gui (Project Engineer)

Sep. 29,2020

Angela Li

Reviewed By

Angela Li (Reviewer)

Oct. 16,2020

Forrest Lei

Approved By

Forrest Lei (Authorized Officer)

Oct. 16,2020

Any report having not been signed by authorized approver, or having been altered without authorization, or having not been stamped by the "Dedicated Testing/Inspection Stamp" is deemed to be invalid. Copying or excerpting portion of, or altering the content of the report is not permitted without the written authorization of AGC. The test results presented in the report apply only to the tested sample. Any objections to report issued by AGC should be submitted to AGC within 15days after the issuance of the test report. Further enquiry of validity or verification of the test report should be addressed to AGC by agc@agc-cert.com.

Attestation of Global Compliance(Shenzhen)Co., Ltd

Attestation of Global Compliance(Shenzhen)Std & Tech Co., Ltd

Tel: +86-755 2523 4088 E-mail: agc@agc-cert.com Web: http://cn.agc-cert.com/



TABLE OF CONTENTS

| | |
|---|------------|
| 1. SUMMARY OF MAXIMUM SAR VALUE | 5 |
| 2. GENERAL INFORMATION..... | 6 |
| 2.1. EUT DESCRIPTION..... | 6 |
| 3. SAR MEASUREMENT SYSTEM..... | 8 |
| 3.1. THE SATIMO SYSTEM USED FOR PERFORMING COMPLIANCE TESTS CONSISTS OF FOLLOWING ITEMS | 8 |
| 3.2. COMOSAR E-FIELD PROBE | 9 |
| 3.3. ROBOT..... | 9 |
| 3.4. VIDEO POSITIONING SYSTEM | 10 |
| 3.5. DEVICE HOLDER | 10 |
| 3.6. SAM TWIN PHANTOM..... | 11 |
| 4. SAR MEASUREMENT PROCEDURE..... | 12 |
| 4.1. SPECIFIC ABSORPTION RATE (SAR)..... | 12 |
| 4.2. SAR MEASUREMENT PROCEDURE | 13 |
| 4.3. RF EXPOSURE CONDITIONS | 15 |
| 5. TISSUE SIMULATING LIQUID..... | 17 |
| 5.1. THE COMPOSITION OF THE TISSUE SIMULATING LIQUID..... | 17 |
| 5.2. TISSUE DIELECTRIC PARAMETERS FOR HEAD AND BODY PHANTOMS | 18 |
| 5.3. TISSUE CALIBRATION RESULT | 19 |
| 6. SAR SYSTEM CHECK PROCEDURE | 20 |
| 6.1. SAR SYSTEM CHECK PROCEDURES | 20 |
| 6.2. SAR SYSTEM CHECK..... | 21 |
| 7. EUT TEST POSITION..... | 23 |
| 7.1. DEFINE TWO IMAGINARY LINES ON THE HANDSET..... | 23 |
| 7.2. CHEEK POSITION | 24 |
| 7.3. TILT POSITION..... | 24 |
| 7.4. BODY WORN POSITION | 25 |
| 8. SAR EXPOSURE LIMITS | 26 |
| 9. TEST FACILITY | 27 |
| 10. TEST EQUIPMENT LIST | 28 |
| 11. MEASUREMENT UNCERTAINTY | 29 |
| 12. CONDUCTED POWER MEASUREMENT..... | 32 |
| 13. TEST RESULTS | 52 |
| 13.1. SAR TEST RESULTS SUMMARY..... | 52 |
| APPENDIX A. SAR SYSTEM CHECK DATA | 71 |
| APPENDIX B. SAR MEASUREMENT DATA..... | 95 |
| APPENDIX C. TEST SETUP PHOTOGRAPHS..... | 145 |
| APPENDIX D. CALIBRATION DATA | 152 |

Any report having not been signed by authorized approver, or having been altered without authorization, or having not been stamped by the "Dedicated Testing/Inspection Stamp" is deemed to be invalid. Copying or excerpting portion of, or altering the content of the report is not permitted without the written authorization of AGC. The test results presented in the report apply only to the tested sample. Any objections to report issued by AGC should be submitted to AGC within 15days after the issuance of the test report. Further enquiry of validity or verification of the test report should be addressed to AGC by agc@agc-cert.com.



1. SUMMARY OF MAXIMUM SAR VALUE

The maximum results of Specific Absorption Rate (SAR) found during testing for EUT are as follows:

| Frequency Band | Highest Reported 1g-SAR(W/Kg) | | SAR Test Limit (W/Kg) |
|---------------------------|-------------------------------|-----------|-----------------------|
| | Head | Body-worn | |
| GSM 850 | 0.088 | 0.311 | 1.6 |
| PCS 1900 | 0.112 | 0.851 | |
| UMTS Band II | 0.172 | 0.533 | |
| UMTS Band V | 0.078 | 0.110 | |
| LTE Band 2-1RB | 0.176 | 0.482 | |
| LTE Band 4-1RB | 0.150 | 0.364 | |
| LTE Band 7-1RB | 0.159 | 0.222 | |
| LTE Band 2-50%RB | 0.152 | 0.181 | |
| LTE Band 4-50%RB | 0.111 | 0.278 | |
| LTE Band 7-50%RB | 0.040 | 0.202 | |
| WIFI 2.4G | 0.130 | 0.047 | |
| Simultaneous Reported SAR | 1.023 | | |
| SAR Test Result | PASS | | |

This device is compliance with Specific Absorption Rate (SAR) for general population/uncontrolled exposure limits (1.6W/Kg) specified in IEEE Std. 1528:2013; FCC 47CFR § 2.1093; IEEE/ANSI C95.1:2005 and the following specific FCC Test Procedures:

- KDB 447498 D01 General RF Exposure Guidance v06
- KDB 648474 D04 Handset SAR v01r03
- KDB 865664 D01 SAR Measurement 100MHz to 6GHz v01r04
- KDB 941225 D01 3G SAR Procedures v03r01
- KDB 941225 D06 Hotspot Mode v02r01
- KDB 248227 D01 802 11 Wi-Fi SAR v02r02
- KDB 941225 D05 SAR for LTE Devices v02r05

Any report having not been signed by authorized approver, or having been altered without authorization, or having not been stamped by the "Dedicated Testing/Inspection Stamp" is deemed to be invalid. Copying or excerpting portion of, or altering the content of the report is not permitted without the written authorization of AGC. The test results presented in the report apply only to the tested sample. Any objections to report issued by AGC should be submitted to AGC within 15days after the issuance of the test report. Further enquiry of validity or verification of the test report should be addressed to AGC by agc@agc-cert.com.



2. GENERAL INFORMATION

2.1. EUT Description

| General Information | |
|-------------------------|---|
| Product Designation | SMART PHONE |
| Test Model | S601 |
| Hardware Version | MT6761V/WE- V00 |
| Software Version | TEENO_i12_V01_20200903 |
| Device Category | Portable |
| RF Exposure Environment | Uncontrolled |
| Antenna Type | Internal |
| Sample ID | 200922031 |
| GSM and GPRS& EGPRS | |
| Support Band | <input checked="" type="checkbox"/> GSM 850 <input checked="" type="checkbox"/> PCS 1900 <input type="checkbox"/> GSM 900 <input type="checkbox"/> DCS 1800 |
| GPRS & EGPRS Type | Class B |
| GPRS & EGPRS Class | Class 12(1Tx+4Rx, 2Tx+3Rx, 3Tx+2Rx, 4Tx+1Rx) |
| TX Frequency Range | GSM 850 : 820-850MHz; PCS 1900: 1850-1910MHz; |
| RX Frequency Range | GSM 850 : 869~894MHz; PCS 1900: 1930~1990MHz |
| Release Version | R99 |
| Type of modulation | GMSK for GSM/GPRS; GMSK & 8-PSK for EGPRS |
| Antenna Gain | GSM850: 0.31dBi; PCS1900: 0.62dBi |
| Max. Average Power | GSM850: 32.00dBm; PCS1900: 29.96dBm |
| WCDMA | |
| Support Band | <input checked="" type="checkbox"/> UMTS FDD Band II <input checked="" type="checkbox"/> UMTS FDD Band V <input type="checkbox"/> UMTS FDD Band IV <input type="checkbox"/> UMTS FDD Band I <input type="checkbox"/> UMTS FDD Band III <input type="checkbox"/> UMTS FDD Band VIII |
| HS Type | HSPA(HSUPA/HSDPA) |
| TX Frequency Range | FDD Band II: 1850-1910MHz; FDD Band V: 820-850MHz |
| RX Frequency Range | FDD Band II: 1930-1990MHz; FDD Band V: 869-894MHz |
| Release Version | Rel-6 |
| Type of modulation | HSDPA:QPSK/16QAM; HSUPA:BPSK; WCDMA:QPSK |
| Antenna Gain | Band II: 0.62dBi; Band V:0.31dBi |
| Max. Average Power | Band II: 22.68dBm; Band V: 22.64dBm |

Any report having not been signed by authorized approver, or having been altered without authorization, or having not been stamped by the "Dedicated Testing/Inspection Stamp" is deemed to be invalid. Copying or excerpting portion of, or altering the content of the report is not permitted without the written authorization of AGC. The test results presented in the report apply only to the tested sample. Any objections to report issued by AGC should be submitted to AGC within 15days after the issuance of the test report. Further enquiry of validity or verification of the test report should be addressed to AGC by agc@agc-cert.com.



EUT Description(Continue)

| | |
|---------------------|--|
| LTE | |
| Support Band | <input checked="" type="checkbox"/> FDD Band 2 <input checked="" type="checkbox"/> FDD Band 4 <input type="checkbox"/> FDD Band 5 <input checked="" type="checkbox"/> FDD Band 7 <input type="checkbox"/> FDD Band 12 <input type="checkbox"/> FDD Band 17 <input type="checkbox"/> FDD Band 25 <input type="checkbox"/> FDD Band 26 <input type="checkbox"/> TDD Band 41 (U.S. Bands) <input type="checkbox"/> FDD Band 1 <input type="checkbox"/> FDD Band 3 <input type="checkbox"/> FDD Band 7 <input type="checkbox"/> FDD Band 8 <input type="checkbox"/> FDD Band 20 <input type="checkbox"/> TDD Band 28 <input type="checkbox"/> TDD Band 38 <input type="checkbox"/> FDD Band 40 <input type="checkbox"/> FDD Band 42 <input type="checkbox"/> FDD Band 43 (Non-U.S. Bands) |
| TX Frequency Range | Band 2:1850-1910MHz; Band 4:1710-1755MHz;Band 7:2500-2570MHz; |
| RX Frequency Range | Band 2:1930-1990MHz; Band 4:2110-2155MHz; Band 7:2620-2690MHz; |
| Release Version | Rel-8 |
| Type of modulation | QPSK, 16QAM |
| Antenna Gain | Band 2: 0.62dBi; Band 4: 0.68dBi; Band 7: 0.73dBi; |
| Max. Average Power | Band 2: 23.66dBm; Band 4: 23.30dBm; Band 7:23.31dBm; |
| Bluetooth | |
| Bluetooth Version | <input type="checkbox"/> V2.0 <input type="checkbox"/> V2.1 <input type="checkbox"/> V2.1+EDR <input type="checkbox"/> V3.0 <input type="checkbox"/> V3.0+HS <input type="checkbox"/> V4.0 <input checked="" type="checkbox"/> V5.0 |
| Operation Frequency | 2402~2480MHz |
| Type of modulation | <input checked="" type="checkbox"/> GFSK <input checked="" type="checkbox"/> π/4-DQPSK <input checked="" type="checkbox"/> 8-DPSK |
| Peak Power | 9.18dBm |
| Antenna Gain | 0.85dBi |
| WIFI | |
| WIFI Specification | <input type="checkbox"/> 802.11a <input checked="" type="checkbox"/> 802.11b <input checked="" type="checkbox"/> 802.11g <input checked="" type="checkbox"/> 802.11n(20) <input checked="" type="checkbox"/> 802.11n(40) |
| Operation Frequency | 2412~2462MHz |
| Avg. Burst Power | 11b: 17.76dBm,11g:13.52dBm,11n(20):13.41dBm,11n(40):10.73dBm |
| Antenna Gain | 0.85dBi |
| Accessories | |
| Battery | Brand name: IPRO Model No. : S601 Voltage and Capacitance: 3.8 V & 3000mAh |

- Note:1.CMU200 can measure the average power and Peak power at the same time
 2.The sample used for testing is end product.
 3. The test sample has no any deviation to the test method of standard mentioned in page 1.

| | |
|---------|--|
| Product | Type |
| | <input checked="" type="checkbox"/> Production unit <input type="checkbox"/> Identical Prototype |

Any report having not been signed by authorized approver, or having been altered without authorization, or having not been stamped by the "Dedicated Testing/Inspection Stamp" is deemed to be invalid. Copying or excerpting portion of, or altering the content of the report is not permitted without the written authorization of AGC. The test results presented in the report apply only to the tested sample. Any objections to report issued by AGC should be submitted to AGC within 15days after the issuance of the test report. Further enquiry of validity or verification of the test report should be addressed to AGC by agc@agc-cert.com.



3. SAR MEASUREMENT SYSTEM

3.1. The SATIMO system used for performing compliance tests consists of following items

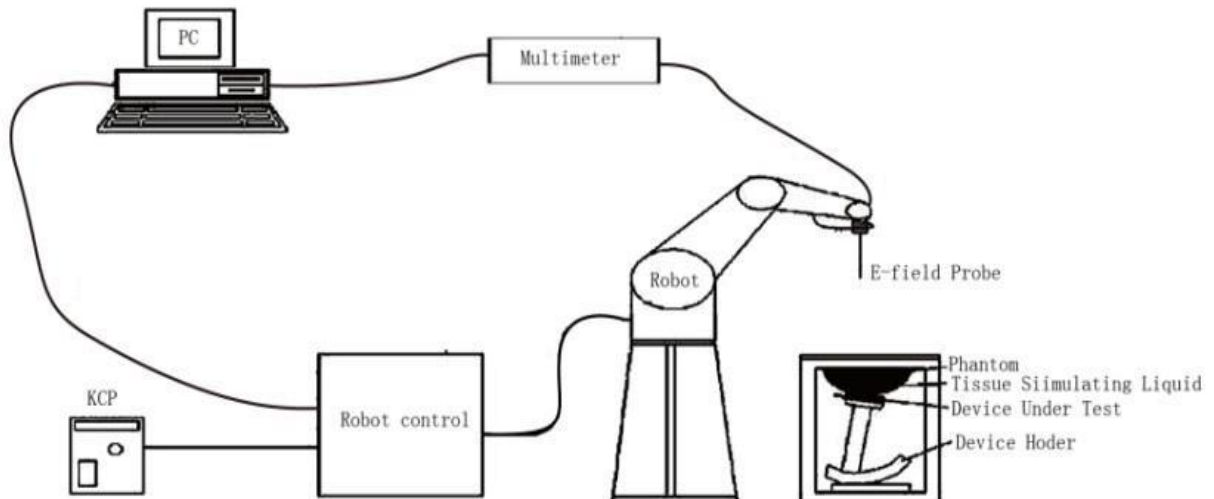

The COMOSAR system for performing compliance tests consists of the following items:

- The PC. It controls most of the bench devices and stores measurement data. A computer running WinXP and the Opensar software.
- The E-Field probe. The probe is a 3-axis system made of 3 distinct dipoles. Each dipole returns a voltage in function of the ambient electric field.
- The Keithley multimeter measures each probe dipole voltages.
- The SAM phantom simulates a human head. The measurement of the electric field is made inside the phantom.
- The liquids simulate the dielectric properties of the human head tissues.
- The network emulator controls the mobile phone under test.
- The validation dipoles are used to measure a reference SAR. They are used to periodically check the bench to make sure that there is no drift of the system characteristics over time.
- The phantom, the device holder and other accessories according to the targeted measurement.

Any report having not been signed by authorized approver, or having been altered without authorization, or having not been stamped by the "Dedicated Testing/Inspection Stamp" is deemed to be invalid. Copying or excerpting portion of, or altering the content of the report is not permitted without the written authorization of AGC. The test results presented in the report apply only to the tested sample. Any objections to report issued by AGC should be submitted to AGC within 15 days after the issuance of the test report. Further enquiry of validity or verification of the test report should be addressed to AGC by agc@agc-cert.com.

Attestation of Global Compliance(Shenzhen)Co., Ltd
Attestation of Global Compliance(Shenzhen)Std & Tech Co., Ltd
Tel: +86-755 2523 4088 E-mail: agc@agc-cert.com Web: <http://cn.agc-cert.com/>



3.2. COMOSAR E-Field Probe

The SAR measurement is conducted with the dosimetric probe manufactured by SATIMO. The probe is specially designed and calibrated for use in liquid with high permittivity. The dosimetric probe has special calibration in liquid at different frequency. SATIMO conducts the probe calibration in compliance with international and national standards (e.g. IEEE 1528 and relevant KDB files.) The calibration data are in Appendix D.

Isotropic E-Field Probe Specification

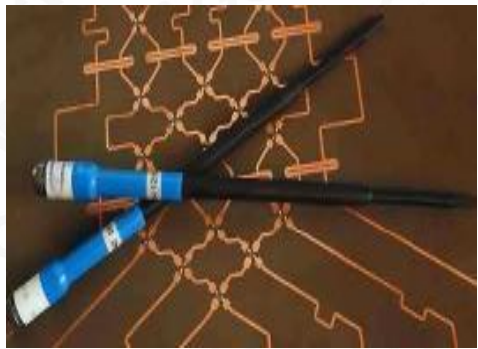
| | | |
|---------------------------|--|--|
| Model | SSE5 | |
| Manufacture | MVG | |
| Identification No. | SN 24/20 EP336 | |
| Frequency | 0.7GHz-3GHz Linearity: $\pm 0.08\text{dB}$ (0.7GHz-3GHz) |  |
| Dynamic Range | 0.01W/Kg-100W/Kg Linearity: $\pm 0.08\text{dB}$ | |
| Dimensions | Overall length:330mm Length of individual dipoles:4.5mm Maximum external diameter:8mm Probe Tip external diameter:5mm Distance between dipoles/ probe extremity:2.7mm | |
| Application | High precision dosimetric measurements in any exposure scenario (e.g., very strong gradient fields). Only probe which enables compliance testing for frequencies up to 3 GHz with precision of better 30%. | |

3.3. Robot

The COMOSAR system uses the KUKA robot from SATIMO SA (France). For the 6-axis controller COMOSAR system, the KUKA robot controller version from SATIMO is used.

The XL robot series have many features that are important for our application:

- High precision (repeatability 0.02 mm)
- High reliability (industrial design)
- Jerk-free straight movements
- Low ELF interference (the closed metallic construction shields against motor control fields)
- 6-axis controller



Any report having not been signed by authorized approver, or having been altered without authorization, or having not been stamped by the "Dedicated Testing/Inspection Stamp" is deemed to be invalid. Copying or excerpting portion of, or altering the content of the report is not permitted without the written authorization of AGC. The test results presented in the report apply only to the tested sample. Any objections to report issued by AGC should be submitted to AGC within 15 days after the issuance of the test report. Further enquiry of validity or verification of the test report should be addressed to AGC by agc@agc-cert.com.



3.4. Video Positioning System

The video positioning system is used in OpenSAR to check the probe. Which is composed of a camera, LED, mirror and mechanical parts. The camera is piloted by the main computer with firewire link. During the process, the actual position of the probe tip with respect to the robot arm is measured, as well as the probe length and the horizontal probe offset. The software then corrects all movements, such that the robot coordinates are valid for the probe tip. The repeatability of this process is better than 0.1 mm. If a position has been taught with an aligned probe, the same position will be reached with another aligned probe within 0.1 mm, even if the other probe has different dimensions. During probe rotations, the probe tip will keep its actual position.

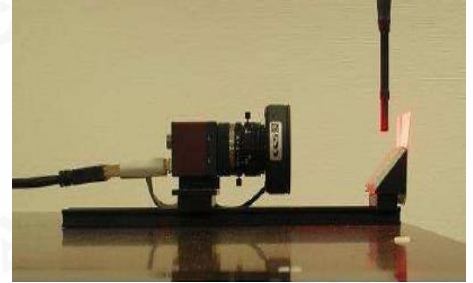

3.5. Device Holder

The COMOSAR device holder is designed to cope with different positions given in the standard. It has two scales for the device rotation (with respect to the body axis) and the device inclination (with respect to the line between the ear reference points). The rotation center for both scales is the ear reference point (EPR). Thus the device needs no repositioning when changing the angles. The COMOSAR device holder has been made out of low-loss POM material having the following dielectric parameters: relative permittivity $\epsilon_r = 3$ and loss tangent $\delta = 0.02$. The amount of dielectric material has been reduced in the closest vicinity of the device, since measurements have suggested that the influence of the clamp on the test results could thus be lowered.

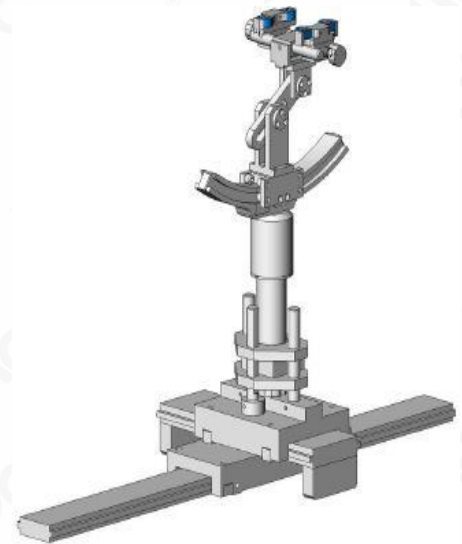

Any report having not been signed by authorized approver, or having been altered without authorization, or having not been stamped by the "Dedicated Testing/Inspection Stamp" is deemed to be invalid. Copying or excerpting portion of, or altering the content of the report is not permitted without the written authorization of AGC. The test results presented in the report apply only to the tested sample. Any objections to report issued by AGC should be submitted to AGC within 15 days after the issuance of the test report. Further enquiry of validity or verification of the test report should be addressed to AGC by agc@agc-cert.com.

Attestation of Global Compliance(Shenzhen)Co., Ltd
Attestation of Global Compliance(Shenzhen)Std & Tech Co., Ltd
Tel: +86-755 2523 4088 E-mail: agc@agc-cert.com Web: <http://cn.agc-cert.com/>



3.6. SAM Twin Phantom

The SAM twin phantom is a fiberglass shell phantom with 2mm shell thickness (except the ear region where shell thickness increases to 6mm). It has three measurement areas:

- Left head
- Right head
- Flat phantom



The bottom plate contains three pair of bolts for locking the device holder. The device holder positions are adjusted to the standard measurement positions in the three sections. A white cover is provided to tap the phantom during off-periods to prevent water evaporation and changes in the liquid parameters. On the phantom top, three reference markers are provided to identify the phantom position with respect to the robot.

ELLI39 Phantom

The Flat phantom is a fiberglass shellphantom with 2mm+/- 0.2 mm shell thickness. It has only one measurement area for Flat phantom



Any report having not been signed by authorized approver, or having been altered without authorization, or having not been stamped by the "Dedicated Testing/Inspection Stamp" is deemed to be invalid. Copying or excerpting portion of, or altering the content of the report is not permitted without the written authorization of AGC. The test results presented in the report apply only to the tested sample. Any objections to report issued by AGC should be submitted to AGC within 15days after the issuance of the test report. Further enquiry of validity or verification of the test report should be addressed to AGC by agc@agc-cert.com.



4. SAR MEASUREMENT PROCEDURE

4.1. Specific Absorption Rate (SAR)

SAR is related to the rate at which energy is absorbed per unit mass in object exposed to a radio field. The SAR distribution in a biological body is complicated and is usually carried out by experimental techniques or numerical modeling. The standard recommends limits for two tiers of groups, occupational/controlled and occupational/uncontrolled, based on a person's awareness and ability to exercise control over his or her exposure. In general, occupational/controlled exposure limits are higher than the limits for general population/uncontrolled.

The SAR definition is the time derivative (rate) of the incremental energy (dW) absorbed by (dissipated in) an incremental mass (dm) contained in a volume element(dv) of given mass density (ρ). The equation description is as below:

$$SAR = \frac{d}{dt} \left(\frac{dW}{dm} \right) = \frac{d}{dt} \left(\frac{dW}{\rho dV} \right)$$

SAR is expressed in units of Watts per kilogram (W/Kg)

SAR can be obtained using either of the following equations:

$$SAR = \frac{\sigma E^2}{\rho}$$

$$SAR = c_h \left. \frac{dT}{dt} \right|_{t=0}$$

Where

| | |
|--------------------------------------|--|
| SAR | is the specific absorption rate in watts per kilogram; |
| E | is the r.m.s. value of the electric field strength in the tissue in volts per meter; |
| σ | is the conductivity of the tissue in siemens per metre; |
| ρ | is the density of the tissue in kilograms per cubic metre; |
| c_h | is the heat capacity of the tissue in joules per kilogram and Kelvin; |
| $\left. \frac{dT}{dt} \right _{t=0}$ | is the initial time derivative of temperature in the tissue in kelvins per second |

Any report having not been signed by authorized approver, or having been altered without authorization, or having not been stamped by the "Dedicated Testing/Inspection Stamp" is deemed to be invalid. Copying or excerpting portion of, or altering the content of the report is not permitted without the written authorization of AGC. The test results presented in the report apply only to the tested sample. Any objections to report issued by AGC should be submitted to AGC within 15days after the issuance of the test report. Further enquiry of validity or verification of the test report should be addressed to AGC by agc@agc-cert.com.



4.2. SAR Measurement Procedure

Step 1: Power Reference Measurement

The Power Reference Measurement and Power Drift Measurement are for monitoring the power drift of the device under test in the batch process. The minimum distance of probe sensors to surface is 2.7mm This distance cannot be smaller than the distance os sensor calibration points to probe tip as `defined in the probe properties,

Step 2: Area Scan

The Area Scan is used as a fast scan in two dimensions to find the area of high field values, before doing a fine measurement around the hot spot. The sophisticated interpolation routines implemented in SATIMO software can find the maximum locations even in relatively coarse grids. When an Area Scan has measured all reachable points, it computes the field maximal found in the scanned area, within a range of the global maximum. The range (in db) is specified in the standards for compliance testing. For example, a 2db range is required in IEEE Standard 1528 and IEC62209 standards, whereby 3db is a requirement when compliance is assessed in accordance with the ARIB standard (Japan) If one Zoom Scan follows the Area Scan, then only the absolute maximum will be taken as reference. For cases where multiple maximum are detected, the number of Zoom Scan has to be increased accordingly.

Area Scan Parameters extracted from KDB 865664 D01 SAR Measurement 100MHz to 6GHz

| | ≤ 3 GHz | > 3 GHz |
|--|---|--|
| Maximum distance from closest measurement point (geometric center of probe sensors) to phantom surface | 5 ± 1 mm | $\frac{1}{2} \cdot \delta \cdot \ln(2) \pm 0.5$ mm |
| Maximum probe angle from probe axis to phantom surface normal at the measurement location | 30° ± 1° | 20° ± 1° |
| Maximum area scan spatial resolution: Δx_{Area} , Δy_{Area} | ≤ 2 GHz: ≤ 15 mm 2 – 3 GHz: ≤ 12 mm | 3 – 4 GHz: ≤ 12 mm 4 – 6 GHz: ≤ 10 mm |
| | When the x or y dimension of the test device, in the measurement plane orientation, is smaller than the above, the measurement resolution must be ≤ the corresponding x or y dimension of the test device with at least one measurement point on the test device. | |

Step 3: Zoom Scan

Zoom Scan are used to assess the peak spatial SAR value within a cubic average volume containing 1g abd 10g of simulated tissue. The Zoom Scan measures points(refer to table below) within a cube whose base faces are centered on the maxima found in a preceding area scan job within the same procedure. When the measurement is done, the Zoom Scan evaluates the averaged SAR for 1g and 10g and displays these values next to the job's label.



Zoom Scan Parameters extracted from KDB865664 d01 SAR Measurement 100MHz to 6GHz

| | | | |
|--|------------------------------------|--|---|
| Maximum zoom scan spatial resolution: Δx_{Zoom} , Δy_{Zoom} | | ≤ 2 GHz: ≤ 8 mm 2 – 3 GHz: ≤ 5 mm* | 3 – 4 GHz: ≤ 5 mm* 4 – 6 GHz: ≤ 4 mm* |
| Maximum zoom scan spatial resolution, normal to phantom surface | uniform grid: $\Delta z_{Zoom}(n)$ | ≤ 5 mm | 3 – 4 GHz: ≤ 4 mm 4 – 5 GHz: ≤ 3 mm 5 – 6 GHz: ≤ 2 mm |
| | graded grid | $\Delta z_{Zoom}(1)$: between 1 st two points closest to phantom surface | ≤ 4 mm |
| | | $\Delta z_{Zoom}(n>1)$: between subsequent points | $\leq 1.5 \cdot \Delta z_{Zoom}(n-1)$ |
| Minimum zoom scan volume | x, y, z | ≥ 30 mm | 3 – 4 GHz: ≥ 28 mm 4 – 5 GHz: ≥ 25 mm 5 – 6 GHz: ≥ 22 mm |
| <p>Note: δ is the penetration depth of a plane-wave at normal incidence to the tissue medium; see draft standard IEEE P1528-2011 for details.</p> <p>* When zoom scan is required and the <i>reported</i> SAR from the <i>area scan based 1-g SAR estimation</i> procedures of KDB 447498 is ≤ 1.4 W/kg, ≤ 8 mm, ≤ 7 mm and ≤ 5 mm zoom scan resolution may be applied, respectively, for 2 GHz to 3 GHz, 3 GHz to 4 GHz and 4 GHz to 6 GHz.</p> | | | |

Step 4: Power Drift Measurement

The Power Drift Measurement measures the field at the same location as the most recent power reference measurement within the same procedure, and with the same settings. The Power Drift Measurement gives the field difference in dB from the reading conducted within the same settings. This allows a user to monitor the power drift of the device under test within a batch process. The measurement procedure is the same as Step 1.

Any report having not been signed by authorized approver, or having been altered without authorization, or having not been stamped by the "Dedicated Testing/Inspection Stamp" is deemed to be invalid. Copying or excerpting portion of, or altering the content of the report is not permitted without the written authorization of AGC. The test results presented in the report apply only to the tested sample. Any objections to report issued by AGC should be submitted to AGC within 15days after the issuance of the test report. Further enquiry of validity or verification of the test report should be addressed to AGC by agc@agc-cert.com.



4.3. RF Exposure Conditions

Test Configuration and setting:

The EUT is a model of GSM Portable Mobile Station (MS). It supports GSM/GPRS/EGPRS, WCDMA/HSPA, LTE, BT, WIFI, and support hot spot mode.

For WWAN SAR testing, the device was controlled by using a base station emulator. Communication between the device and the emulator were established by air link. The distance between the EUT and the antenna is larger than 50cm, and the output power radiated from the emulator antenna is at least 30db smaller than the output power of EUT.

For WLAN testing, the EUT is configured with the WLAN continuous TX tool through engineering command.

Antenna Location: (the back view)

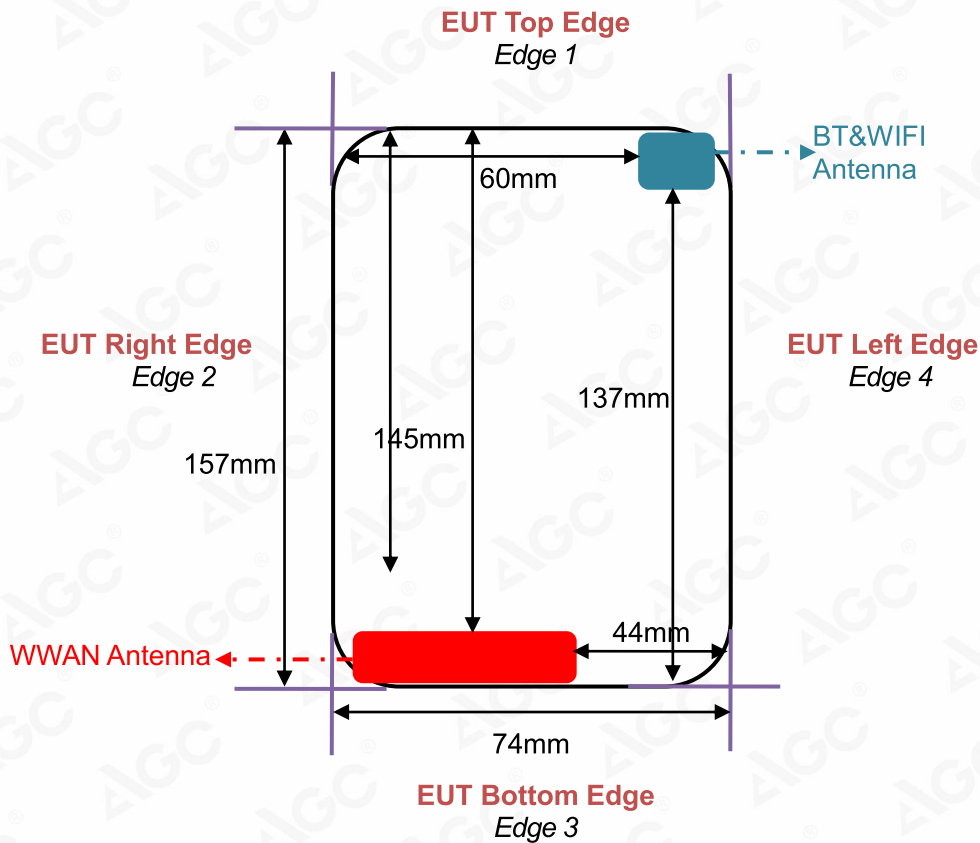

Any report having not been signed by authorized approver, or having been altered without authorization, or having not been stamped by the "Dedicated Testing/Inspection Stamp" is deemed to be invalid. Copying or excerpting portion of, or altering the content of the report is not permitted without the written authorization of AGC. The test results presented in the report apply only to the tested sample. Any objections to report issued by AGC should be submitted to AGC within 15days after the issuance of the test report. Further enquiry of validity or verification of the test report should be addressed to AGC by agc@agc-cert.com.



For WWAN mode:

| Test Configurations | Antenna to edges/surface | SAR required | Note |
|---------------------|--------------------------|--------------|--|
| Head | | | |
| Left Touch | | Yes | -- |
| Left Tilt | | Yes | -- |
| Right Touch | | Yes | -- |
| Right Tilt | | Yes | -- |
| Body | | | |
| Back | <25mm | Yes | -- |
| Front | <25mm | Yes | -- |
| Hotspot | | | |
| Back | <25mm | Yes | -- |
| Front | <25mm | Yes | -- |
| Edge 1 (Top) | 145mm | No | SAR is not required for the distance between the antenna and the edge is >25mm as per KDB 941225 D06 Hotspot SAR |
| Edge 2 (Right) | 1mm | Yes | -- |
| Edge 3 (Bottom) | 1mm | Yes | -- |
| Edge 4 (Left) | 44mm | No | SAR is not required for the distance between the antenna and the edge is >25mm as per KDB 941225 D06 Hotspot SAR |

For WLAN mode:

| Test Configurations | Antenna to edges/surface | SAR required | Note |
|---------------------|--------------------------|--------------|--|
| Head | | | |
| Left Touch | | Yes | -- |
| Left Tilt | | Yes | -- |
| Right Touch | | Yes | -- |
| Right Tilt | | Yes | -- |
| Body | | | |
| Back | <25mm | Yes | -- |
| Front | <25mm | Yes | -- |
| Hotspot | | | |
| Back | <25mm | Yes | -- |
| Front | <25mm | Yes | -- |
| Edge 1 (Top) | 1mm | Yes | -- |
| Edge 2 (Right) | 60mm | No | SAR is not required for the distance between the antenna and the edge is >25mm as per KDB 941225 D06 Hotspot SAR |
| Edge 3 (Bottom) | 137mm | No | SAR is not required for the distance between the antenna and the edge is >25mm as per KDB 941225 D06 Hotspot SAR |
| Edge 4 (Left) | 1mm | Yes | -- |

Any report having not been signed by authorized approver, or having been altered without authorization, or having not been stamped by the "Dedicated Testing/Inspection Stamp" is deemed to be invalid. Copying or excerpting portion of, or altering the content of the report is not permitted without the written authorization of AGC. The test results presented in the report apply only to the tested sample. Any objections to report issued by AGC should be submitted to AGC within 15days after the issuance of the test report. Further enquiry of validity or verification of the test report should be addressed to AGC by agc@agc-cert.com.



5. TISSUE SIMULATING LIQUID

For SAR measurement of the field distribution inside the phantom, the phantom must be filled with homogeneous tissue simulating liquid to a depth of at least 15cm. For head SAR testing the liquid height from the ear reference point (ERP) of the phantom to the liquid top surface is larger than 15cm For body SAR testing, the liquid height from the center of the flat phantom to the liquid top surface is larger than 15cm. The nominal dielectric values of the tissue simulating liquids in the phantom and the tolerance of 10% are listed in 6.2

5.1. The composition of the tissue simulating liquid

| Ingredient (% Weight) Frequency (MHz) | Water | Nacl | Polysorbate 20 | DGBE | 1,2 Propanediol | Triton X-100 |
|--|--------|-------|----------------|--------|--------------------|-----------------|
| 835 Head | 50.36 | 1.25 | 48.39 | 0.0 | 0.0 | 0.0 |
| 1750 Head | 52.64 | 0.36 | 0.0 | 47 | 0.0 | 0.0 |
| 1900 Head | 54.9 | 0.18 | 0.0 | 44.92 | 0.0 | 0.0 |
| 2450 Head | 71.88 | 0.16 | 0.0 | 7.99 | 0.0 | 19.97 |
| 2600 Head | 55.242 | 0.306 | 0 | 44.452 | 0 | 0 |

Any report having not been signed by authorized approver, or having been altered without authorization, or having not been stamped by the "Dedicated Testing/Inspection Stamp" is deemed to be invalid. Copying or excerpting portion of, or altering the content of the report is not permitted without the written authorization of AGC. The test results presented in the report apply only to the tested sample. Any objections to report issued by AGC should be submitted to AGC within 15days after the issuance of the test report. Further enquiry of validity or verification of the test report should be addressed to AGC by agc@agc-cert.com.

Attestation of Global Compliance(Shenzhen)Co., Ltd
Attestation of Global Compliance(Shenzhen)Std & Tech Co., Ltd
Tel: +86-755 2523 4088 E-mail: agc@agc-cert.com Web: http://cn.agc-cert.com/



5.2. Tissue Dielectric Parameters for Head and Body Phantoms

The head tissue dielectric parameters recommended by the IEC 62209-1 have been incorporated in the following table. The body tissue dielectric parameters recommended by the IEC 62209-2 have been incorporated in the following table.

| Target Frequency (MHz) | head | | body | |
|------------------------|--------------|----------------|--------------|----------------|
| | ϵ_r | σ (S/m) | ϵ_r | σ (S/m) |
| 300 | 45.3 | 0.87 | 45.3 | 0.87 |
| 450 | 43.5 | 0.87 | 43.5 | 0.87 |
| 750 | 41.9 | 0.89 | 41.9 | 0.89 |
| 835 | 41.5 | 0.90 | 41.5 | 0.90 |
| 900 | 41.5 | 0.97 | 41.5 | 0.97 |
| 915 | 41.5 | 1.01 | 41.5 | 1.01 |
| 1450 | 40.5 | 1.20 | 40.5 | 1.20 |
| 1610 | 40.3 | 1.29 | 40.3 | 1.29 |
| 1750 | 40.1 | 1.37 | 40.1 | 1.37 |
| 1800 – 2000 | 40.0 | 1.40 | 40.0 | 1.40 |
| 2450 | 39.2 | 1.80 | 39.2 | 1.80 |
| 2600 | 39.0 | 1.96 | 39.0 | 1.96 |
| 3000 | 38.5 | 2.40 | 38.5 | 2.40 |

(ϵ_r = relative permittivity, σ = conductivity and $\rho = 1000 \text{ kg/m}^3$)

Any report having not been signed by authorized approver, or having been altered without authorization, or having not been stamped by the "Dedicated Testing/Inspection Stamp" is deemed to be invalid. Copying or excerpting portion of, or altering the content of the report is not permitted without the written authorization of AGC. The test results presented in the report apply only to the tested sample. Any objections to report issued by AGC should be submitted to AGC within 15 days after the issuance of the test report. Further enquiry of validity or verification of the test report should be addressed to AGC by agc@agc-cert.com.

Attestation of Global Compliance(Shenzhen)Co., Ltd
Attestation of Global Compliance(Shenzhen)Std & Tech Co., Ltd
Tel: +86-755 2523 4088 E-mail: agc@agc-cert.com Web: <http://cn.agc-cert.com/>



5.3. Tissue Calibration Result

The dielectric parameters of the liquids were verified prior to the SAR evaluation using SATIMO Dielectric Probe Kit and R&S Network Analyzer ZVL6.

| Tissue Stimulant Measurement for 835MHz | | | | | |
|---|-----------|--------------------------------------|--------------------------------|------------------|--------------|
| Head | Fr. (MHz) | Dielectric Parameters ($\pm 10\%$) | | Tissue Temp [°C] | Test time |
| | | ϵ_r 41.5 (37.35-45.65) | δ [s/m] 0.90(0.81-0.99) | | |
| | 835 | 40.36 | 0.89 | 20.2 | Sep. 25,2020 |
| 836.6 | 39.68 | 0.91 | | | |

| Tissue Stimulant Measurement for 1750MHz | | | | | |
|--|-----------|--------------------------------------|---------------------------------|------------------|--------------|
| Head | Fr. (MHz) | Dielectric Parameters ($\pm 10\%$) | | Tissue Temp [°C] | Test time |
| | | ϵ_r 40.1 (36.09-44.11) | δ [s/m]1.37(1.233-1.507) | | |
| | 1732.5 | 41.39 | 1.37 | 19.9 | Sep. 26,2020 |
| 1750 | 40.60 | 1.39 | | | |

| Tissue Stimulant Measurement for 1900MHz | | | | | |
|--|-----------|--------------------------------------|-------------------------------|------------------|--------------|
| Head | Fr. (MHz) | Dielectric Parameters ($\pm 10\%$) | | Tissue Temp [°C] | Test time |
| | | ϵ_r 40.00(36.00-44.00) | δ [s/m]1.40(1.26-1.54) | | |
| | 1850.2 | 41.89 | 1.33 | 20.1 | Sep. 24,2020 |
| | 1880 | 41.22 | 1.36 | | |
| | 1900 | 40.51 | 1.38 | | |
| 1909.8 | 39.86 | 1.39 | | | |

| Tissue Stimulant Measurement for 1900MHz | | | | | |
|--|-----------|--------------------------------------|-------------------------------|------------------|--------------|
| Head | Fr. (MHz) | Dielectric Parameters ($\pm 10\%$) | | Tissue Temp [°C] | Test time |
| | | ϵ_r 40.00(36.00-44.00) | δ [s/m]1.40(1.26-1.54) | | |
| | 1880 | 39.21 | 1.37 | 18.9 | Sep. 29,2020 |
| 1900 | 38.69 | 1.38 | | | |

| Tissue Stimulant Measurement for 2450MHz | | | | | |
|--|-----------|--------------------------------------|-------------------------------|------------------|--------------|
| Head | Fr. (MHz) | Dielectric Parameters ($\pm 10\%$) | | Tissue Temp [°C] | Test time |
| | | ϵ_r 39.2(35.28-43.12) | δ [s/m]1.80(1.62-1.98) | | |
| | 2437 | 39.53 | 1.81 | 19.4 | Sep. 23,2020 |
| 2450 | 38.51 | 1.84 | | | |

| Tissue Stimulant Measurement for 2600MHz | | | | | |
|--|-----------|--------------------------------------|---------------------------------|------------------|--------------|
| Head | Fr. (MHz) | Dielectric Parameters ($\pm 10\%$) | | Tissue Temp [°C] | Test time |
| | | ϵ_r 39(35.1-42.9) | δ [s/m]1.96(1.764-2.156) | | |
| | 2535 | 39.56 | 1.95 | 19.9 | Sep. 28,2020 |
| 2600 | 38.62 | 1.98 | | | |

Any report having not been signed by authorized approver, or having been altered without authorization, or having not been stamped by the "Dedicated Testing/Inspection Stamp" is deemed to be invalid. Copying or excerpting portion of, or altering the content of the report is not permitted without the written authorization of AGC. The test results presented in the report apply only to the tested sample. Any objections to report issued by AGC should be submitted to AGC within 15days after the issuance of the test report. Further enquiry of validity or verification of the test report should be addressed to AGC by agc@agc-cert.com.



6. SAR SYSTEM CHECK PROCEDURE

6.1. SAR System Check Procedures

SAR system check is required to confirm measurement accuracy, according to the tissue dielectric media, probe calibration points and other system operating parameters required for measuring the SAR of a test device. The system verification must be performed for each frequency band and within the valid range of each probe calibration point required for testing the device. The same SAR probe(s) and tissue-equivalent media combinations used with each specific SAR system for system verification must be used for device testing. When multiple probe calibration points are required to cover substantially large transmission bands, independent system verifications are required for each probe calibration point. A system verification must be performed before each series of SAR measurements using the same probe calibration point and tissue-equivalent medium. Additional system verification should be considered according to the conditions of the tissue-equivalent medium and measured tissue dielectric parameters, typically every three to four days when the liquid parameters are remeasured or sooner when marginal liquid parameters are used at the beginning of a series of measurements.

Each SATIMO system is equipped with one or more system check kits. These units, together with the predefined measurement procedures within the SATIMO software, enable the user to conduct the system check and system validation. System kit includes a dipole, and dipole device holder.

The system check verifies that the system operates within its specifications. It's performed daily or before every SAR measurement. The system check uses normal SAR measurement in the flat section of the phantom with a matched dipole at a specified distance. The system check setup is shown as below.

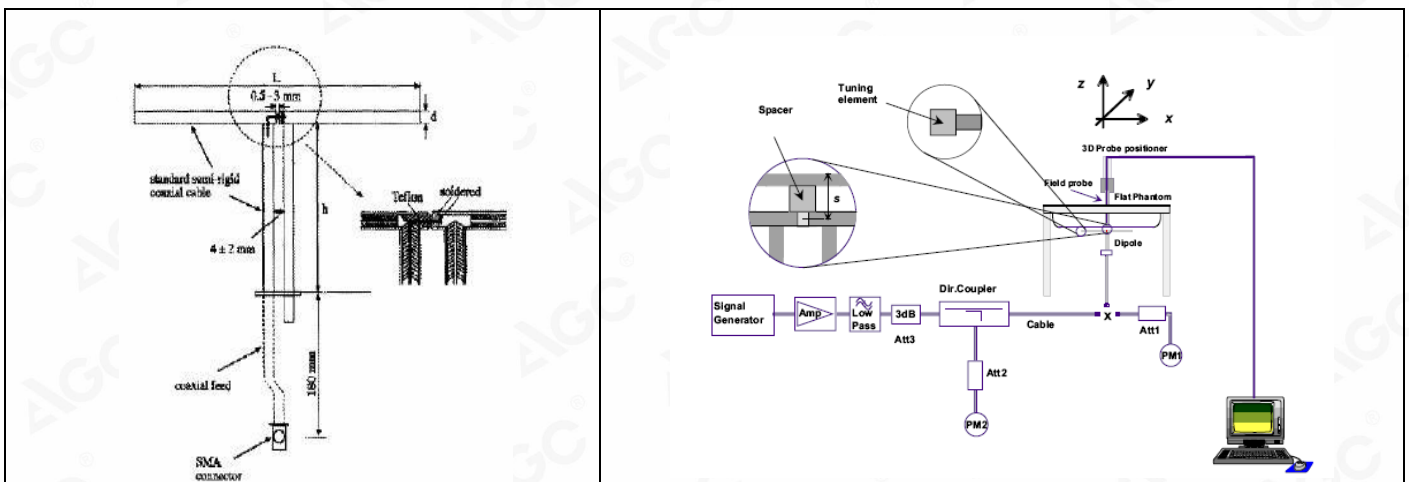

Any report having not been signed by authorized approver, or having been altered without authorization, or having not been stamped by the "Dedicated Testing/Inspection Stamp" is deemed to be invalid. Copying or excerpting portion of, or altering the content of the report is not permitted without the written authorization of AGC. The test results presented in the report apply only to the tested sample. Any objections to report issued by AGC should be submitted to AGC within 15 days after the issuance of the test report. Further enquiry of validity or verification of the test report should be addressed to AGC by agc@agc-cert.com.

Attestation of Global Compliance(Shenzhen)Co., Ltd
Attestation of Global Compliance(Shenzhen)Std & Tech Co., Ltd
Tel: +86-755 2523 4088 E-mail: agc@agc-cert.com Web: <http://cn.agc-cert.com/>



6.2. SAR System Check

6.2.1. Dipoles

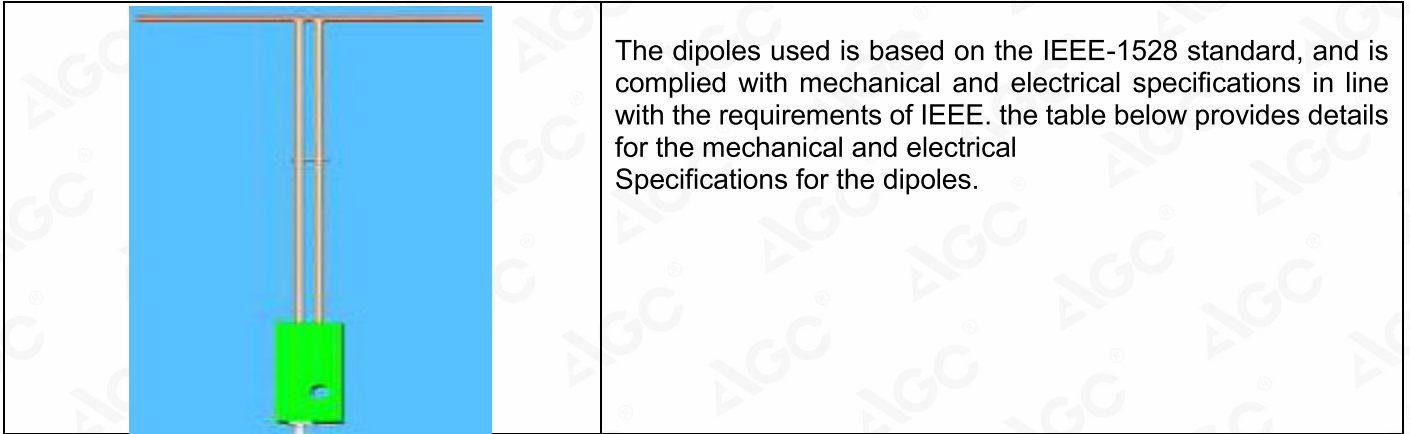

| Frequency | L (mm) | h (mm) | d (mm) |
|-----------|--------|--------|--------|
| 835MHz | 161.0 | 89.8 | 3.6 |
| 1800MHz | 71.6 | 41.7 | 3.6 |
| 1900MHz | 68 | 39.5 | 3.6 |
| 2450MHz | 51.5 | 30.4 | 3.6 |
| 2600MHz | 48.5 | 28.8 | 3.6 |

Any report having not been signed by authorized approver, or having been altered without authorization, or having not been stamped by the "Dedicated Testing/Inspection Stamp" is deemed to be invalid. Copying or excerpting portion of, or altering the content of the report is not permitted without the written authorization of AGC. The test results presented in the report apply only to the tested sample. Any objections to report issued by AGC should be submitted to AGC within 15days after the issuance of the test report. Further enquiry of validity or verification of the test report should be addressed to AGC by agc@agc-cert.com.



6.2.2. System Check Result

| System Performance Check at 835MHz &1800MHz &1900MHz &2450MHz&2600MHz for Head | | | | | | | | |
|---|--------------------|-------|---------------------------------|---------------|--------------------|-------|-------------------|--------------|
| Validation Kit: SN29/15 DIP 0G835-383& SN46/11 DIP 1G800-186& SN 46/11 DIP 1G900-187& SN46/11 DIP 2G450-189& SN 47/14 DIP 2G600-342 | | | | | | | | |
| Frequency [MHz] | Target Value(W/Kg) | | Reference Result ($\pm 10\%$) | | Tested Value(W/Kg) | | Tissue Temp. [°C] | Test time |
| | 1g | 10g | 1g | 10g | 1g | 10g | | |
| 835 | 9.85 | 6.27 | 8.865-10.835 | 5.643-6.897 | 9.66 | 6.16 | 20.2 | Sep. 25,2020 |
| 1800 | 39.07 | 20.29 | 35.163-42.977 | 18.261-22.319 | 38.24 | 19.43 | 19.9 | Sep. 26,2020 |
| 1900 | 40.25 | 20.50 | 36.225-44.275 | 18.45-22.55 | 42.04 | 20.21 | 20.1 | Sep. 24,2020 |
| 1900 | 40.25 | 20.50 | 36.225-44.275 | 18.45-22.55 | 38.63 | 19.31 | 18.9 | Sep. 29,2020 |
| 2450 | 53.97 | 24.01 | 48.573-59.367 | 21.609-26.411 | 52.96 | 23.84 | 19.4 | Sep. 23,2020 |
| 2600 | 56.86 | 24.84 | 51.174-62.546 | 22.356-27.324 | 53.15 | 23.43 | 19.9 | Sep. 28,2020 |
| 835 | 9.85 | 6.27 | 8.865-10.835 | 5.643-6.897 | 9.47 | 5.97 | 20.2 | Sep. 25,2020 |
| 1800 | 39.07 | 20.29 | 35.163-42.977 | 18.261-22.319 | 37.74 | 19.33 | 19.9 | Sep. 26,2020 |
| 1900 | 40.25 | 20.50 | 36.225-44.275 | 18.45-22.55 | 39.48 | 19.35 | 20.1 | Sep. 24,2020 |
| 1900 | 40.25 | 20.50 | 36.225-44.275 | 18.45-22.55 | 39.57 | 19.47 | 18.9 | Sep. 29,2020 |
| 2450 | 53.97 | 24.01 | 48.573-59.367 | 21.609-26.411 | 53.61 | 25.05 | 19.4 | Sep. 23,2020 |
| 2600 | 56.86 | 24.84 | 51.174-62.546 | 22.356-27.324 | 53.52 | 24.02 | 19.9 | Sep. 28,2020 |

Note:

(1) We use a CW signal of 18dBm for system check, and then all SAR value are normalized to 1W forward power. The result must be within $\pm 10\%$ of target value.

Any report having not been signed by authorized approver, or having been altered without authorization, or having not been stamped by the "Dedicated Testing/Inspection Stamp" is deemed to be invalid. Copying or excerpting portion of, or altering the content of the report is not permitted without the written authorization of AGC. The test results presented in the report apply only to the tested sample. Any objections to report issued by AGC should be submitted to AGC within 15days after the issuance of the test report. Further enquiry of validity or verification of the test report should be addressed to AGC by agc@agc-cert.com.



7. EUT TEST POSITION

This EUT was tested in **Right Cheek, Right Tilted, Left Cheek, Left Tilted, Body back, Body front and 4 edges**.

7.1. Define Two Imaginary Lines on the Handset

- (1) The vertical centerline passes through two points on the front side of the handset: the midpoint of the width w_t of the handset at the level of the acoustic output, and the midpoint of the width w_b of the handset.
- (2) The horizontal line is perpendicular to the vertical centerline and passes through the center of the acoustic output. The horizontal line is also tangential to the face of the handset at point A.
- (3) The two lines intersect at point A. Note that for many handsets, point A coincides with the center of the acoustic output; however, the acoustic output may be located elsewhere on the horizontal line. Also note that the vertical centerline is not necessarily to the front face of the handset, especially for clamshell handsets, handsets with flip covers, and other irregularly shaped handsets.

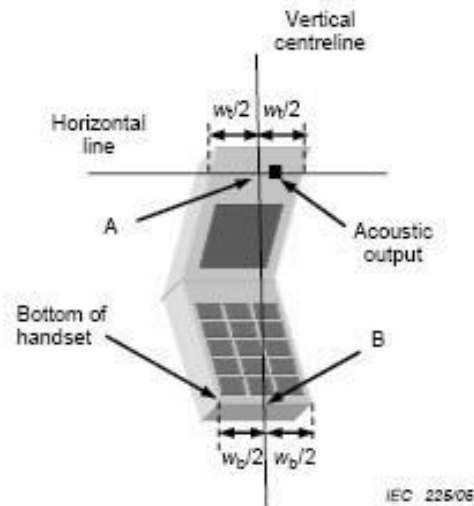
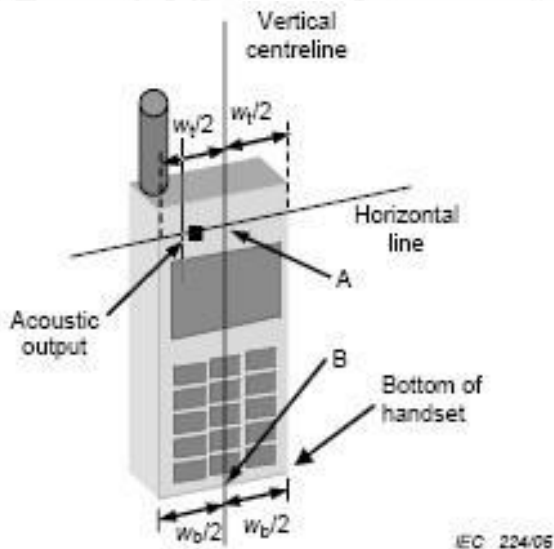

Any report having not been signed by authorized approver, or having been altered without authorization, or having not been stamped by the "Dedicated Testing/Inspection Stamp" is deemed to be invalid. Copying or excerpting portion of, or altering the content of the report is not permitted without the written authorization of AGC. The test results presented in the report apply only to the tested sample. Any objections to report issued by AGC should be submitted to AGC within 15 days after the issuance of the test report. Further enquiry of validity or verification of the test report should be addressed to AGC by agc@agc-cert.com.

Attestation of Global Compliance(Shenzhen)Co., Ltd
Attestation of Global Compliance(Shenzhen)Std & Tech Co., Ltd
Tel: +86-755 2523 4088 E-mail: agc@agc-cert.com Web: <http://cn.agc-cert.com/>



7.2. Cheek Position

- (1) To position the device with the vertical center line of the body of the device and the horizontal line crossing the center piece in a plane parallel to the sagittal plane of the phantom. While maintaining the device in this plane, align the vertical center line with the reference plane containing the ear and mouth reference point (M: Mouth, RE: Right Ear, and LE: Left Ear) and align the center of the ear piece with the line RE-LE.
- (2) To move the device towards the phantom with the ear piece aligned with the the line LE-RE until the phone touched the ear. While maintaining the device in the reference plane and maintaining the phone contact with ear, move the bottom of the phone until any point on the front side is in contact with the cheek of the phantom or until contact with the ear is lost



7.3. Tilt Position

- (1) To position the device in the “cheek” position described above.
- (2) While maintaining the device in the reference plane described above and pivoting against the ear, moves it outward away from the mouth by an angle of 15 degrees or until with the ear is lost.



Any report having not been signed by authorized approver, or having been altered without authorization, or having not been stamped by the “Dedicated Testing/Inspection Stamp” is deemed to be invalid. Copying or excerpting portion of, or altering the content of the report is not permitted without the written authorization of AGC. The test results presented in the report apply only to the tested sample. Any objections to report issued by AGC should be submitted to AGC within 15days after the issuance of the test report. Further enquiry of validity or verification of the test report should be addressed to AGC by agc@agc-cert.com.

7.4. Body Worn Position

- (1) To position the EUT parallel to the phantom surface.
- (2) To adjust the EUT parallel to the flat phantom.
- (3) To adjust the distance between the EUT surface and the flat phantom to **10mm**.

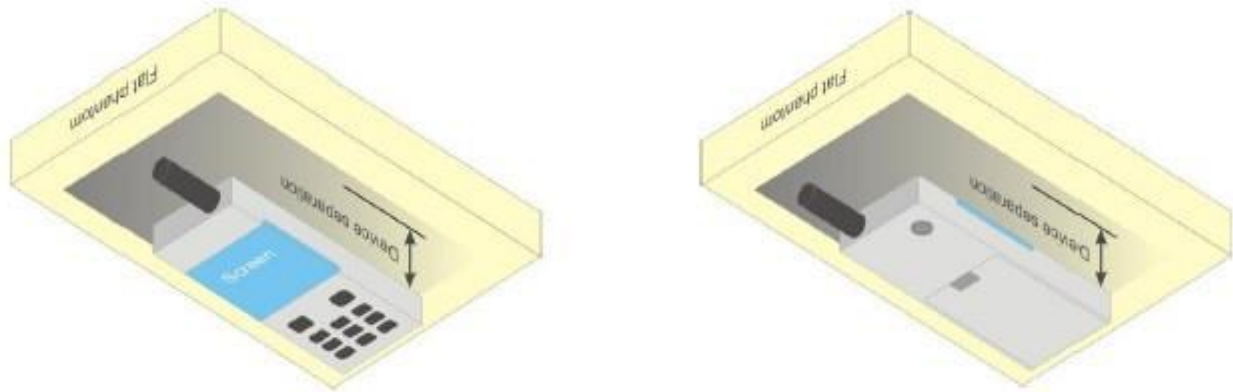

Any report having not been signed by authorized approver, or having been altered without authorization, or having not been stamped by the "Dedicated Testing/Inspection Stamp" is deemed to be invalid. Copying or excerpting portion of, or altering the content of the report is not permitted without the written authorization of AGC. The test results presented in the report apply only to the tested sample. Any objections to report issued by AGC should be submitted to AGC within 15days after the issuance of the test report. Further enquiry of validity or verification of the test report should be addressed to AGC by agc@agc-cert.com.

Attestation of Global Compliance(Shenzhen)Co., Ltd
Attestation of Global Compliance(Shenzhen)Std & Tech Co., Ltd
Tel: +86-755 2523 4088 E-mail: agc@agc-cert.com Web: <http://cn.agc-cert.com/>



8. SAR EXPOSURE LIMITS

Limits for General Population/Uncontrolled Exposure (W/kg)

| Type Exposure | Uncontrolled Environment Limit (W/kg) |
|---|---------------------------------------|
| Spatial Peak SAR (1g cube tissue for brain or body) | 1.60 |
| Spatial Average SAR (Whole body) | 0.08 |
| Spatial Peak SAR (Limbs) | 4.0 |

Any report having not been signed by authorized approver, or having been altered without authorization, or having not been stamped by the "Dedicated Testing/Inspection Stamp" is deemed to be invalid. Copying or excerpting portion of, or altering the content of the report is not permitted without the written authorization of AGC. The test results presented in the report apply only to the tested sample. Any objections to report issued by AGC should be submitted to AGC within 15 days after the issuance of the test report. Further enquiry of validity or verification of the test report should be addressed to AGC by agc@agc-cert.com.

Attestation of Global Compliance(Shenzhen)Co., Ltd
Attestation of Global Compliance(Shenzhen)Std & Tech Co., Ltd
Tel: +86-755 2523 4088 E-mail: agc@agc-cert.com Web: <http://cn.agc-cert.com/>



9. TEST FACILITY

| | |
|--|--|
| Test Site | Attestation of Global Compliance (Shenzhen) Co., Ltd |
| Location | 1-2/F, Building 19, Junfeng Industrial Park, Chongqing Road, Heping Community, Fuhai Street, Bao'an District, Shenzhen, Guangdong, China |
| Designation Number | CN1259 |
| FCC Test Firm Registration Number | 975832 |
| A2LA Cert. No. | 5054.02 |
| Description | Attestation of Global Compliance(Shenzhen) Co., Ltd is accredited by A2LA |

Any report having not been signed by authorized approver, or having been altered without authorization, or having not been stamped by the "Dedicated Testing/Inspection Stamp" is deemed to be invalid. Copying or excerpting portion of, or altering the content of the report is not permitted without the written authorization of AGC. The test results presented in the report apply only to the tested sample. Any objections to report issued by AGC should be submitted to AGC within 15days after the issuance of the test report. Further enquiry of validity or verification of the test report should be addressed to AGC by agc@agc-cert.com.

Attestation of Global Compliance(Shenzhen)Co., Ltd
Attestation of Global Compliance(Shenzhen)Std & Tech Co., Ltd
Tel: +86-755 2523 4088 E-mail: agc@agc-cert.com Web: <http://cn.agc-cert.com/>



10. TEST EQUIPMENT LIST

| Equipment description | Manufacturer/ Model | Identification No. | Current calibration date | Next calibration date |
|-----------------------|-------------------------|------------------------|-----------------------------|-----------------------------|
| SAR Probe | MVG | SN 24/20 EP336 | Jun. 24,2020 | Jun. 23,2021 |
| Phantom | SATIMO | SN_4511_SAM90 | Validated. No cal required. | Validated. No cal required. |
| Phantom | SATIMO | SN_2316_ELLI39 | Validated. No cal required. | Validated. No cal required. |
| Liquid | SATIMO | - | Validated. No cal required. | Validated. No cal required. |
| Comm Tester | Agilent-8960 | GB46310822 | Oct. 08,2019 | Oct. 07,2020 |
| Comm Tester | R&S- CMW500 | S/N120909 | Aug. 12,2020 | Aug. 11,2021 |
| Multimeter | Keithley 2000 | 4114939 | Sep. 06,2020 | Sep. 05,2021 |
| Dipole | SATIMO SID835 | SN29/15 DIP 0G835-383 | Apr. 26,2019 | Apr. 25,2022 |
| Dipole | SATIMO SID1800 | SN46/11 DIP 1G800-186 | Apr. 26,2019 | Apr. 25,2022 |
| Dipole | SATIMO SID1900 | SN 46/11 DIP 1G900-187 | Apr. 26,2019 | Apr. 25,2022 |
| Dipole | SATIMO SID2450 | SN46/11 DIP 2G450-189 | Apr. 26,2019 | Apr. 25,2022 |
| Dipole | SATIMO SID2600 | SN 47/14 DIP 2G600-342 | Apr. 26,2019 | Apr. 25,2022 |
| Signal Generator | Agilent-E4438C | US41461365 | Oct. 08,2019 | Oct. 07,2020 |
| Vector Analyzer | Agilent / E4440A | US41421290 | Sep. 06,2020 | Sep. 05,2021 |
| Network Analyzer | Rhode & Schwarz ZVL6 | SN101443 | Oct. 08,2019 | Oct. 07,2020 |
| Attenuator | Warison /WATT-6SR1211 | S/N:WRJ34AYM2F1 | June 10,2020 | June 09,2021 |
| Attenuator | Mini-circuits / VAT-10+ | 31405 | June 10,2020 | June 09,2021 |
| Amplifier | AS0104-55_55 | 1004793 | June 11,2020 | June 10,2021 |
| Directional Couple | Werlatone/ C5571-10 | SN99463 | May 15,2020 | May 14,2022 |
| Directional Couple | Werlatone/ C6026-10 | SN99482 | May 15,2020 | May 14,2022 |
| Power Sensor | NRP-Z21 | 1137.6000.02 | Sep. 08,2020 | Sep. 07,2021 |
| Power Sensor | NRP-Z23 | US38261498 | Feb. 18,2020 | Feb. 17,2021 |
| Power Viewer | R&S | V2.3.1.0 | N/A | N/A |

Note: Per KDB 865664 Dipole SAR Validation, AGC Lab has adopted 3 years calibration intervals. On annual basis, every measurement dipole has been evaluated and is in compliance with the following criteria:

1. There is no physical damage on the dipole;
2. System validation with specific dipole is within 10% of calibrated value;
3. Return-loss is within 20% of calibrated measurement;
4. Impedance is within 5Ω of calibrated measurement.

Any report having not been signed by authorized approver, or having been altered without authorization, or having not been stamped by the "Dedicated Testing/Inspection Stamp" is deemed to be invalid. Copying or excerpting portion of, or altering the content of the report is not permitted without the written authorization of AGC. The test results presented in the report apply only to the tested sample. Any objections to report issued by AGC should be submitted to AGC within 15days after the issuance of the test report. Further enquiry of validity or verification of the test report should be addressed to AGC by agc@agc-cert.com.

Attestation of Global Compliance(Shenzhen)Co., Ltd
Attestation of Global Compliance(Shenzhen)Std & Tech Co., Ltd
Tel: +86-755 2523 4088 E-mail: agc@agc-cert.com Web: http://cn.agc-cert.com/



11. MEASUREMENT UNCERTAINTY

| SATIMO Uncertainty- SN 24/20 EP336 Measurement uncertainty for DUT averaged over 1 gram / 10 gram. | | | | | | | | | |
|---|-------|-----------|-------------|------------|--------------|--------------|-------------|--------------|----|
| Uncertainty Component | Sec. | Tol (+-%) | Prob. Dist. | Div. | Ci (1g) | Ci (10g) | 1g Ui (+-%) | 10g Ui (+-%) | vi |
| Measurement System | | | | | | | | | |
| Probe calibration | E.2.1 | 7.000 | N | 1 | 1 | 1 | 7.000 | 7.000 | ∞ |
| Axial Isotropy | E.2.2 | 0.105 | R | $\sqrt{3}$ | $\sqrt{0.5}$ | $\sqrt{0.5}$ | 0.043 | 0.043 | ∞ |
| Hemispherical Isotropy | E.2.2 | 0.105 | R | $\sqrt{3}$ | $\sqrt{0.5}$ | $\sqrt{0.5}$ | 0.043 | 0.043 | ∞ |
| Boundary effect | E.2.3 | 1.000 | R | $\sqrt{3}$ | 1 | 1 | 0.577 | 0.577 | ∞ |
| Linearity | E.2.4 | 0.870 | R | $\sqrt{3}$ | 1 | 1 | 0.502 | 0.502 | ∞ |
| System detection limits | E.2.4 | 1.000 | R | $\sqrt{3}$ | 1 | 1 | 0.577 | 0.577 | ∞ |
| Modulation response | E.2.5 | 3.000 | R | $\sqrt{3}$ | 1 | 1 | 1.732 | 1.732 | ∞ |
| Readout Electronics | E.2.6 | 0.021 | N | 1 | 1 | 1 | 0.021 | 0.021 | ∞ |
| Response Time | E.2.7 | 0.000 | R | $\sqrt{3}$ | 1 | 1 | 0.000 | 0.000 | ∞ |
| Integration Time | E.2.8 | 1.400 | R | $\sqrt{3}$ | 1 | 1 | 0.808 | 0.808 | ∞ |
| RF ambient conditions-Noise | E.6.1 | 3.000 | R | $\sqrt{3}$ | 1 | 1 | 1.732 | 1.732 | ∞ |
| RF ambient conditions-reflections | E.6.1 | 3.000 | R | $\sqrt{3}$ | 1 | 1 | 1.732 | 1.732 | ∞ |
| Probe positioner mechanical tolerance | E.6.2 | 1.400 | R | $\sqrt{3}$ | 1 | 1 | 0.808 | 0.808 | ∞ |
| Probe positioning with respect to phantom shell | E.6.3 | 1.400 | R | $\sqrt{3}$ | 1 | 1 | 0.808 | 0.808 | ∞ |
| Extrapolation, interpolation, and integrations algorithms for max. SAR evaluation | E.5 | 2.300 | R | $\sqrt{3}$ | 1 | 1 | 1.328 | 1.328 | ∞ |
| Test sample Related | | | | | | | | | |
| Test sample positioning | E.4.2 | 2.6 | N | 1 | 1 | 1 | 2.600 | 2.600 | ∞ |
| Device holder uncertainty | E.4.1 | 3 | N | 1 | 1 | 1 | 3.000 | 3.000 | ∞ |
| Output power variation—SAR drift measurement | E.2.9 | 5 | R | $\sqrt{3}$ | 1 | 1 | 2.887 | 2.887 | ∞ |
| SAR scaling | E.6.5 | 5 | R | $\sqrt{3}$ | 1 | 1 | 2.887 | 2.887 | ∞ |
| Phantom and tissue parameters | | | | | | | | | |
| Phantom shell uncertainty—shape, thickness, and permittivity | E.3.1 | 4 | R | $\sqrt{3}$ | 1 | 1 | 2.309 | 2.309 | ∞ |
| Uncertainty in SAR correction for deviations in permittivity and conductivity | E.3.2 | 1.9 | N | 1 | 1 | 0.84 | 1.900 | 1.596 | ∞ |
| Liquid conductivity measurement | E.3.3 | 2.5 | R | $\sqrt{3}$ | 0.78 | 0.71 | 1.126 | 1.025 | ∞ |
| Liquid permittivity measurement | E.3.3 | 4 | N | 1 | 0.78 | 0.71 | 3.120 | 2.840 | M |
| Liquid conductivity—temperature uncertainty | E.3.4 | 2.5 | R | $\sqrt{3}$ | 0.23 | 0.26 | 0.332 | 0.375 | ∞ |
| Liquid permittivity—temperature uncertainty | E.3.4 | 5 | N | 1 | 0.23 | 0.26 | 1.150 | 1.300 | M |
| Combined Standard Uncertainty | | | RSS | | | | 10.525 | 10.341 | |
| Expanded Uncertainty (95% Confidence interval) | | | K=2 | | | | 21.051 | 20.681 | |

Any report having not been signed by authorized approver, or having been altered without authorization, or having not been stamped by the "Dedicated Testing/Inspection Stamp" is deemed to be invalid. Copying or excerpting portion of, or altering the content of the report is not permitted without the written authorization of AGC. The test results presented in the report apply only to the tested sample. Any objections to report issued by AGC should be submitted to AGC within 15 days after the issuance of the test report. Further enquiry of validity or verification of the test report should be addressed to AGC by agc@agc-cert.com.



| SATIMO Uncertainty- SN 24/20 EP336 System Validation uncertainty for DUT averaged over 1 gram / 10 gram. | | | | | | | | | |
|---|---------|-----------|-------------|------------|---------|----------|-------------|--------------|----|
| Uncertainty Component | Sec. | Tol (+-%) | Prob. Dist. | Div. | Ci (1g) | Ci (10g) | 1g Ui (+-%) | 10g Ui (+-%) | vi |
| Measurement System | | | | | | | | | |
| Probe calibration | E.2.1 | 7 | N | 1 | 1 | 1 | 7.000 | 7.000 | ∞ |
| Axial Isotropy | E.2.2 | 0.105 | R | $\sqrt{3}$ | 1 | 1 | 0.061 | 0.061 | ∞ |
| Hemispherical Isotropy | E.2.2 | 0.105 | R | $\sqrt{3}$ | 0 | 0 | 0.000 | 0.000 | ∞ |
| Boundary effect | E.2.3 | 1 | R | $\sqrt{3}$ | 1 | 1 | 0.577 | 0.577 | ∞ |
| Linearity | E.2.4 | 0.870 | R | $\sqrt{3}$ | 1 | 1 | 0.502 | 0.502 | ∞ |
| System detection limits | E.2.4 | 1.0 | R | $\sqrt{3}$ | 1 | 1 | 0.58 | 0.58 | ∞ |
| Modulation response | E.2.5 | 3.0 | R | $\sqrt{3}$ | 0 | 0 | 0.00 | 0.00 | ∞ |
| Readout Electronics | E.2.6 | 0.021 | N | 1 | 1 | 1 | 0.021 | 0.021 | ∞ |
| Response Time | E.2.7 | 0.0 | R | $\sqrt{3}$ | 0 | 0 | 0.00 | 0.00 | ∞ |
| Integration Time | E.2.8 | 1.4 | R | $\sqrt{3}$ | 0 | 0 | 0.00 | 0.00 | ∞ |
| RF ambient conditions-Noise | E.6.1 | 3.0 | R | $\sqrt{3}$ | 1 | 1 | 1.73 | 1.73 | ∞ |
| RF ambient conditions-reflections | E.6.1 | 3.0 | R | $\sqrt{3}$ | 1 | 1 | 1.73 | 1.73 | ∞ |
| Probe positioner mechanical tolerance | E.6.2 | 1.4 | R | $\sqrt{3}$ | 1 | 1 | 0.81 | 0.81 | ∞ |
| Probe positioning with respect to phantom shell | E.6.3 | 1.4 | R | $\sqrt{3}$ | 1 | 1 | 0.81 | 0.81 | ∞ |
| Extrapolation, interpolation, and integrations algorithms for max. SAR evaluation | E.5 | 2.3 | R | $\sqrt{3}$ | 1 | 1 | 1.33 | 1.33 | ∞ |
| System validation source | | | | | | | | | |
| Deviation of experimental dipole from numerical dipole | E.6.4 | 5.0 | N | 1 | 1 | 1 | 5.00 | 5.00 | ∞ |
| Input power and SAR drift measurement | 8,6.6.4 | 5.0 | R | $\sqrt{3}$ | 1 | 1 | 2.89 | 2.89 | ∞ |
| Dipole axis to liquid distance | 8,E.6.6 | 2.0 | R | $\sqrt{3}$ | 1 | 1 | 1.15 | 1.15 | ∞ |
| Phantom and set-up | | | | | | | | | |
| Phantom shell uncertainty—shape, thickness, and permittivity | E.3.1 | 4.0 | R | $\sqrt{3}$ | 1 | 1 | 2.31 | 2.31 | ∞ |
| Uncertainty in SAR correction for deviations in permittivity and conductivity | E.3.2 | 1.9 | N | 1 | 1 | 0.84 | 1.90 | 1.60 | ∞ |
| Liquid conductivity (temperature uncertainty) | E.3.3 | 2.5 | R | $\sqrt{3}$ | 0.78 | 0.71 | 1.13 | 1.02 | ∞ |
| Liquid conductivity (measured) | E.3.3 | 4 | N | 1 | 0.78 | 0.71 | 3.12 | 2.84 | M |
| Liquid permittivity (temperature uncertainty) | E.3.4 | 2.5 | R | $\sqrt{3}$ | 0.23 | 0.26 | 0.33 | 0.38 | ∞ |
| Liquid permittivity (measured) | E.3.4 | 5 | N | 1 | 0.23 | 0.26 | 1.15 | 1.30 | M |
| Combined Standard Uncertainty | | | RSS | | | | 10.458 | 10.272 | |
| Expanded Uncertainty (95% Confidence interval) | | | K=2 | | | | 20.916 | 20.544 | |

Any report having not been signed by authorized approver, or having been altered without authorization, or having not been stamped by the "Dedicated Testing/Inspection Stamp" is deemed to be invalid. Copying or excerpting portion of, or altering the content of the report is not permitted without the written authorization of AGC. The test results presented in the report apply only to the tested sample. Any objections to report issued by AGC should be submitted to AGC within 15 days after the issuance of the test report. Further enquiry of validity or verification of the test report should be addressed to AGC by agc@agc-cert.com.



| SATIMO Uncertainty- SN 24/20 EP336 | | | | | | | | | |
|---|---------|-----------|-------------|------------|---------|----------|-------------|--------------|----|
| System Check uncertainty for DUT averaged over 1 gram / 10 gram. | | | | | | | | | |
| Uncertainty Component | Sec. | Tol (+-%) | Prob. Dist. | Div. | Ci (1g) | Ci (10g) | 1g Ui (+-%) | 10g Ui (+-%) | vi |
| Measurement System | | | | | | | | | |
| Probe calibration drift | E.2.1.3 | 0.5 | N | 1 | 1 | 1 | 0.50 | 0.50 | ∞ |
| Axial Isotropy | E.2.2 | 0.105 | R | $\sqrt{3}$ | 0 | 0 | 0.00 | 0.00 | ∞ |
| Hemispherical Isotropy | E.2.2 | 0.105 | R | $\sqrt{3}$ | 0 | 0 | 0.00 | 0.00 | ∞ |
| Boundary effect | E.2.3 | 1 | R | $\sqrt{3}$ | 0 | 0 | 0.00 | 0.00 | ∞ |
| Linearity | E.2.4 | 0.870 | R | $\sqrt{3}$ | 0 | 0 | 0.00 | 0.00 | ∞ |
| System detection limits | E.2.4 | 1.0 | R | $\sqrt{3}$ | 0 | 0 | 0.00 | 0.00 | ∞ |
| Modulation response | E.2.5 | 3.0 | R | $\sqrt{3}$ | 0 | 0 | 0.00 | 0.00 | ∞ |
| Readout Electronics | E.2.6 | 0.021 | N | 1 | 0 | 0 | 0.00 | 0.00 | ∞ |
| Response Time | E.2.7 | 0 | R | $\sqrt{3}$ | 0 | 0 | 0.00 | 0.00 | ∞ |
| Integration Time | E.2.8 | 1.4 | R | $\sqrt{3}$ | 0 | 0 | 0.00 | 0.00 | ∞ |
| RF ambient conditions-Noise | E.6.1 | 3.0 | R | $\sqrt{3}$ | 0 | 0 | 0.00 | 0.00 | ∞ |
| RF ambient conditions-reflections | E.6.1 | 3.0 | R | $\sqrt{3}$ | 0 | 0 | 0.00 | 0.00 | ∞ |
| Probe positioner mechanical tolerance | E.6.2 | 1.4 | R | $\sqrt{3}$ | 1 | 1 | 0.81 | 0.81 | ∞ |
| Probe positioning with respect to phantom shell | E.6.3 | 1.4 | R | $\sqrt{3}$ | 1 | 1 | 0.81 | 0.81 | ∞ |
| Extrapolation, interpolation, and integrations algorithms for max. SAR evaluation | E.5 | 2.3 | R | $\sqrt{3}$ | 0 | 0 | 0.00 | 0.00 | ∞ |
| System check source (dipole) | | | | | | | | | |
| Deviation of experimental dipoles | E.6.4 | 2.0 | N | 1 | 1 | 1 | 2.00 | 2.00 | ∞ |
| Input power and SAR drift measurement | 8,6.6.4 | 5.0 | R | $\sqrt{3}$ | 1 | 1 | 2.89 | 2.89 | ∞ |
| Dipole axis to liquid distance | 8,E.6.6 | 2.0 | R | $\sqrt{3}$ | 1 | 1 | 1.15 | 1.15 | ∞ |
| Phantom and tissue parameters | | | | | | | | | |
| Phantom shell uncertainty—shape, thickness, and permittivity | E.3.1 | 4 | R | $\sqrt{3}$ | 1 | 1 | 2.31 | 2.31 | ∞ |
| Uncertainty in SAR correction for deviations in permittivity and conductivity | E.3.2 | 1.9 | N | 1 | 1 | 0.84 | 1.90 | 1.60 | ∞ |
| Liquid conductivity measurement | E.3.3 | 2.5 | R | $\sqrt{3}$ | 0.78 | 0.71 | 1.13 | 1.02 | ∞ |
| Liquid permittivity measurement | E.3.3 | 4 | N | 1 | 0.78 | 0.71 | 3.12 | 2.84 | M |
| Liquid conductivity—temperature uncertainty | E.3.4 | 2.5 | R | $\sqrt{3}$ | 0.23 | 0.26 | 0.33 | 0.38 | ∞ |
| Liquid permittivity—temperature uncertainty | E.3.4 | 5 | N | 1 | 0.23 | 0.26 | 1.15 | 1.30 | M |
| Combined Standard Uncertainty | | | RSS | | | | 5.562 | 5.203 | |
| Expanded Uncertainty (95% Confidence interval) | | | K=2 | | | | 11.124 | 10.406 | |

Any report having not been signed by authorized approver, or having been altered without authorization, or having not been stamped by the "Dedicated Testing/Inspection Stamp" is deemed to be invalid. Copying or excerpting portion of, or altering the content of the report is not permitted without the written authorization of AGC. The test results presented in the report apply only to the tested sample. Any objections to report issued by AGC should be submitted to AGC within 15days after the issuance of the test report. Further enquiry of validity or verification of the test report should be addressed to AGC by agc@agc-cert.com.



12. CONDUCTED POWER MEASUREMENT GSM BAND

| Mode | Frequency(MHz) | Avg. Burst Power(dBm) | Duty cycle Factor(dBm) | Frame Power(dBm) |
|-----------------------|----------------|-----------------------|------------------------|------------------|
| Maximum Power <1> | | | | |
| GSM 850 | 824.2 | 31.94 | -9 | 22.94 |
| | 836.6 | 32.00 | -9 | 23.00 |
| | 848.8 | 31.91 | -9 | 22.91 |
| GPRS 850 (1 Slot) | 824.2 | 31.64 | -9 | 22.64 |
| | 836.6 | 31.50 | -9 | 22.50 |
| | 848.8 | 31.36 | -9 | 22.36 |
| GPRS 850 (2 Slot) | 824.2 | 29.93 | -6 | 23.93 |
| | 836.6 | 30.19 | -6 | 24.19 |
| | 848.8 | 29.95 | -6 | 23.95 |
| GPRS 850 (3 Slot) | 824.2 | 29.17 | -4.26 | 24.91 |
| | 836.6 | 29.19 | -4.26 | 24.93 |
| | 848.8 | 29.13 | -4.26 | 24.87 |
| GPRS 850 (4 Slot) | 824.2 | 26.79 | -3 | 23.79 |
| | 836.6 | 27.24 | -3 | 24.24 |
| | 848.8 | 26.94 | -3 | 23.94 |
| EGPRS 850 (1 Slot) | 824.2 | 23.76 | -9 | 14.76 |
| | 836.6 | 24.14 | -9 | 15.14 |
| | 848.8 | 24.48 | -9 | 15.48 |
| EGPRS 850 (2 Slot) | 824.2 | 22.74 | -6 | 16.74 |
| | 836.6 | 22.42 | -6 | 16.42 |
| | 848.8 | 22.90 | -6 | 16.90 |
| EGPRS 850 (3 Slot) | 824.2 | 21.20 | -4.26 | 16.94 |
| | 836.6 | 20.43 | -4.26 | 16.17 |
| | 848.8 | 20.45 | -4.26 | 16.19 |
| EGPRS 850 (4 Slot) | 824.2 | 19.44 | -3 | 16.44 |
| | 836.6 | 19.23 | -3 | 16.23 |
| | 848.8 | 19.46 | -3 | 16.46 |

Any report having not been signed by authorized approver, or having been altered without authorization, or having not been stamped by the "Dedicated Testing/Inspection Stamp" is deemed to be invalid. Copying or excerpting portion of, or altering the content of the report is not permitted without the written authorization of AGC. The test results presented in the report apply only to the tested sample. Any objections to report issued by AGC should be submitted to AGC within 15days after the issuance of the test report. Further enquiry of validity or verification of the test report should be addressed to AGC by agc@agc-cert.com.



| Mode | Frequency(MHz) | Avg. Burst Power(dBm) | Duty cycle Factor(dBm) | Frame Power(dBm) |
|----------------------|----------------|-----------------------|------------------------|------------------|
| Maximum Power <2> | | | | |
| GSM 850 | 824.2 | 31.82 | -9 | 22.82 |
| | 836.6 | 31.93 | -9 | 22.93 |
| | 848.8 | 31.80 | -9 | 22.80 |
| GPRS 850 (1 Slot) | 824.2 | 31.55 | -9 | 22.55 |
| | 836.6 | 31.43 | -9 | 22.43 |
| | 848.8 | 31.27 | -9 | 22.27 |
| GPRS 850 (2 Slot) | 824.2 | 29.85 | -6 | 23.85 |
| | 836.6 | 30.10 | -6 | 24.10 |
| | 848.8 | 29.87 | -6 | 23.87 |
| GPRS 850 (3 Slot) | 824.2 | 29.09 | -4.26 | 24.83 |
| | 836.6 | 29.12 | -4.26 | 24.86 |
| | 848.8 | 29.03 | -4.26 | 24.77 |
| GPRS 850 (4 Slot) | 824.2 | 26.81 | -3 | 23.81 |
| | 836.6 | 27.16 | -3 | 24.16 |
| | 848.8 | 26.83 | -3 | 23.83 |

Any report having not been signed by authorized approver, or having been altered without authorization, or having not been stamped by the "Dedicated Testing/Inspection Stamp" is deemed to be invalid. Copying or excerpting portion of, or altering the content of the report is not permitted without the written authorization of AGC. The test results presented in the report apply only to the tested sample. Any objections to report issued by AGC should be submitted to AGC within 15days after the issuance of the test report. Further enquiry of validity or verification of the test report should be addressed to AGC by agc@agc-cert.com.



GSM BAND CONTINUE

| Mode | Frequency(MHz) | Avg. Burst Power(dBm) | Duty cycle Factor(dBm) | Frame Power(dBm) |
|-----------------------|----------------|-----------------------|------------------------|------------------|
| Maximum Power <1> | | | | |
| PCS1900 | 1850.2 | 29.91 | -9 | 20.91 |
| | 1880 | 29.96 | -9 | 20.96 |
| | 1909.8 | 29.86 | -9 | 20.86 |
| GPRS1900 (1 Slot) | 1850.2 | 29.63 | -9 | 20.63 |
| | 1880 | 29.30 | -9 | 20.30 |
| | 1909.8 | 29.52 | -9 | 20.52 |
| GPRS1900 (2 Slot) | 1850.2 | 27.64 | -6 | 21.64 |
| | 1880 | 27.51 | -6 | 21.51 |
| | 1909.8 | 27.59 | -6 | 21.59 |
| GPRS1900 (3 Slot) | 1850.2 | 26.33 | -4.26 | 22.07 |
| | 1880 | 26.38 | -4.26 | 22.12 |
| | 1909.8 | 26.75 | -4.26 | 22.49 |
| GPRS1900 (4 Slot) | 1850.2 | 25.34 | -3 | 22.34 |
| | 1880 | 25.65 | -3 | 22.65 |
| | 1909.8 | 25.72 | -3 | 22.72 |
| EGPRS1900 (1 Slot) | 1850.2 | 22.44 | -9 | 13.44 |
| | 1880 | 22.99 | -9 | 13.99 |
| | 1909.8 | 22.38 | -9 | 13.38 |
| EGPRS1900 (2 Slot) | 1850.2 | 22.64 | -6 | 16.64 |
| | 1880 | 21.90 | -6 | 15.90 |
| | 1909.8 | 22.70 | -6 | 16.70 |
| EGPRS1900 (3 Slot) | 1850.2 | 20.48 | -4.26 | 16.22 |
| | 1880 | 20.30 | -4.26 | 16.04 |
| | 1909.8 | 20.39 | -4.26 | 16.13 |
| EGPRS1900 (4 Slot) | 1850.2 | 18.67 | -3 | 15.67 |
| | 1880 | 18.51 | -3 | 15.51 |
| | 1909.8 | 18.35 | -3 | 15.35 |

Any report having not been signed by authorized approver, or having been altered without authorization, or having not been stamped by the "Dedicated Testing/Inspection Stamp" is deemed to be invalid. Copying or excerpting portion of, or altering the content of the report is not permitted without the written authorization of AGC. The test results presented in the report apply only to the tested sample. Any objections to report issued by AGC should be submitted to AGC within 15days after the issuance of the test report. Further enquiry of validity or verification of the test report should be addressed to AGC by agc@agc-cert.com.

Attestation of Global Compliance(Shenzhen)Co., Ltd
Attestation of Global Compliance(Shenzhen)Std & Tech Co., Ltd
Tel: +86-755 2523 4088 E-mail: agc@agc-cert.com Web: http://cn.agc-cert.com/



| Mode | Frequency(MHz) | Avg. Burst Power(dBm) | Duty cycle Factor(dBm) | Frame Power(dBm) |
|----------------------|----------------|-----------------------|------------------------|------------------|
| Maximum Power <2> | | | | |
| PCS1900 | 1850.2 | 29.82 | -9 | 20.82 |
| | 1880 | 29.86 | -9 | 20.86 |
| | 1909.8 | 29.77 | -9 | 20.77 |
| GPRS1900 (1 Slot) | 1850.2 | 29.52 | -9 | 20.52 |
| | 1880 | 29.23 | -9 | 20.23 |
| | 1909.8 | 29.44 | -9 | 20.44 |
| GPRS1900 (2 Slot) | 1850.2 | 27.53 | -6 | 21.53 |
| | 1880 | 27.47 | -6 | 21.47 |
| | 1909.8 | 27.50 | -6 | 21.50 |
| GPRS1900 (3 Slot) | 1850.2 | 26.22 | -4.26 | 21.96 |
| | 1880 | 26.27 | -4.26 | 22.01 |
| | 1909.8 | 26.65 | -4.26 | 22.39 |
| GPRS1900 (4 Slot) | 1850.2 | 25.23 | -3 | 22.23 |
| | 1880 | 25.57 | -3 | 22.57 |
| | 1909.8 | 25.60 | -3 | 22.60 |

Note 1:

The Frame Power (Source-based time-averaged Power) is scaled the maximum burst average power based on time slots. The calculated methods are show as following:

Frame Power = Max burst power (1 Up Slot) – 9 dB

Frame Power = Max burst power (2 Up Slot) – 6 dB

Frame Power = Max burst power (3 Up Slot) – 4.26 dB

Frame Power = Max burst power (4 Up Slot) – 3 dB

Note 2:

SAR is not required for GPRS (1 Slot) Mode because its output power is less than of Voice Mode

Any report having not been signed by authorized approver, or having been altered without authorization, or having not been stamped by the "Dedicated Testing/Inspection Stamp" is deemed to be invalid. Copying or excerpting portion of, or altering the content of the report is not permitted without the written authorization of AGC. The test results presented in the report apply only to the tested sample. Any objections to report issued by AGC should be submitted to AGC within 15days after the issuance of the test report. Further enquiry of validity or verification of the test report should be addressed to AGC by agc@agc-cert.com.

Attestation of Global Compliance(Shenzhen)Co., Ltd

Attestation of Global Compliance(Shenzhen)Std & Tech Co., Ltd

Tel: +86-755 2523 4088 E-mail: agc@agc-cert.com Web: http://cn.agc-cert.com/



**UMTS BAND
HSDPA Setup Configuration:**

- The EUT was connected to Base Station Agilent E5515C referred to the Setup Configuration.
- The RF path losses were compensated into the measurements.
- A call was established between EUT and Based Station with following setting:
 - (1) Set Gain Factors(β_c and β_d) parameters set according to each
 - (2) Set RMC 12.2Kbps+HSDPA mode.
 - (3) Set Cell Power=-86dBm
 - (4) Set HS-DSCH Configuration Type to FRC (H-set 1, QPSK)
 - (5) Select HSDPA Uplink Parameters
 - (6) Set Delta ACK, Delta NACK and Delta CQI=8
 - (7) Set Ack - Nack Repetition Factor to 3
 - (8) Set CQI Feedback Cycle (k) to 4ms
 - (9) Set CQI Repetition Factor to 2
 - (10) Power Ctrl Mode=All Up bits
- The transmitted maximum output power was recorded.

Table C.10.2.4: β values for transmitter characteristics tests with HS-DPCCH

| Sub-test | β_c (Note5) | β_d | β_d (SF) | β_c/β_d | β_{HS} (Note1, Note 2) | CM (dB) (Note 3) | MPR (dB) (Note 3) |
|----------|-------------------|---------------|----------------|-------------------|------------------------------|------------------|-------------------|
| 1 | 2/15 | 15/15 | 64 | 2/15 | 4/15 | 0.0 | 0.0 |
| 2 | 12/15(Note 4) | 15/15(Note 4) | 64 | 12/15(Note 4) | 24/15 | 1.0 | 0.0 |
| 3 | 15/15 | 8/15 | 64 | 15/8 | 30/15 | 1.5 | 0.5 |
| 4 | 15/15 | 4/15 | 64 | 15/4 | 30/15 | 1.5 | 0.5 |

Note 1: $\Delta ACK, \Delta NACK$ and $\Delta CQI = 30/15$ with $\beta_{hs} = 30/15 * \beta_c$.

Note 2: For the HS-DPCCH power mask requirement test in clause 5.2C, 5.7A, and the Error Vector Magnitude (EVM) with HS-DPCCH test in clause 5.13.1A, and HSDPA EVM with phase discontinuity in clause 5.13.1AA, ΔACK and $\Delta NACK = 30/15$ with $\beta_{hs} = 30/15 * \beta_c$, and $\Delta CQI = 24/15$ with $\beta_{hs} = 24/15 * \beta_c$.

Note 3: CM = 1 for $\beta_c/\beta_d = 12/15, hs/ c=24/15$. For all other combinations of DPDCH, DPCCH and HS-DPCCH the MPR is based on the relative CM difference. This is applicable for only UEs that support HSDPA in release 6 and later releases.

Note 4: For substest 2 the c/ d ratio of 12/15 for the TFC during the measurement period (TF1, TF0) is achieved by setting the signalled gain factors for the reference TFC (TF1, TF1) to $c = 11/15$ and $d = 15/15$.

Any report having not been signed by authorized approver, or having been altered without authorization, or having not been stamped by the "Dedicated Testing/Inspection Stamp" is deemed to be invalid. Copying or excerpting portion of, or altering the content of the report is not permitted without the written authorization of AGC. The test results presented in the report apply only to the tested sample. Any objections to report issued by AGC should be submitted to AGC within 15days after the issuance of the test report. Further enquiry of validity or verification of the test report should be addressed to AGC by agc@agc-cert.com.



HSUPA Setup Configuration:

- The EUT was connected to Base Station Agilent E5515C referred to the Setup Configuration.
- The RF path losses were compensated into the measurements.
- A call was established between EUT and Base Station with following setting * :
 - (1) Call Configs = 5.2B, 5.9B, 5.10B, and 5.13.2B with QPSK
 - (2) Set the Gain Factors (β_c and β_d) and parameters (AG Index) were set according to each specific sub-test in the following table, C11.1.3, quoted from the TS 34.121
 - (3) Set Cell Power = -86 dBm
 - (4) Set Channel Type = 12.2k + HSPA
 - (5) Set UE Target Power
 - (6) Power Ctrl Mode= Alternating bits
 - (7) Set and observe the E-TFCI
 - (8) Confirm that E-TFCI is equal to the target E-TFCI of 75 for sub-test 1, and other subtest's E-TFCI
- The transmitted maximum output power was recorded.

Table C.11.1.3: β values for transmitter characteristics tests with HS-DPCCH and E-DCH

| Sub-test | β_c | β_d | β_d (SF) | β_c/β_d | β_{HS} (Note 1) | β_{ec} | β_{ed} (Note 4) (Note 5) | β_{ed} (SF) | β_{ed} (Codes) | CM (dB) (Note 2) | MPR (dB) (Note 2) (Note 6) | AG Index (Note 5) | E-TF CI |
|----------|----------------|----------------|----------------|-------------------|-----------------------|--------------|--|-------------------|----------------------|------------------|----------------------------|-------------------|---------|
| 1 | 11/15 (Note 3) | 15/15 (Note 3) | 64 | 11/15 (Note 3) | 22/15 | 209/225 | 1309/225 | 4 | 1 | 1.0 | 0.0 | 20 | 75 |
| 2 | 6/15 | 15/15 | 64 | 6/15 | 12/15 | 12/15 | 94/75 | 4 | 1 | 3.0 | 2.0 | 12 | 67 |
| 3 | 15/15 | 9/15 | 64 | 15/9 | 30/15 | 30/15 | β_{ed1} : 47/15 β_{ed2} : 47/15 | 4 4 | 2 | 2.0 | 1.0 | 15 | 92 |
| 4 | 2/15 | 15/15 | 64 | 2/15 | 4/15 | 2/15 | 56/75 | 4 | 1 | 3.0 | 2.0 | 17 | 71 |
| 5 | 15/15 | 0 | - | - | 5/15 | 5/15 | 47/15 | 4 | 1 | 1.0 | 0.0 | 12 | 67 |

Note 1: For sub-test 1 to 4, ΔACK , $\Delta NACK$ and $\Delta CQI = 30/15$ with $\beta_{hs} = 30/15 * \beta_c$. For sub-test 5, ΔACK , $\Delta NACK$ and $\Delta CQI = 5/15$ with $\beta_{hs} = 5/15 * \beta_c$.

Note 2: CM = 1 for $\beta_c/\beta_d = 12/15$, $hs/c = 24/15$. For all other combinations of DPDCH, DPCCH, HS-DPCCH, E-DPDCH and E-DPCCH the MPR is based on the relative CM difference.

Note 3: For subtest 1 the c/d ratio of 11/15 for the TFC during the measurement period (TF1, TF0) is achieved by setting the signalled gain factors for the reference TFC (TF1, TF1) to $c = 10/15$ and $d = 15/15$.

Note 4: In case of testing by UE using E-DPDCH Physical Layer category 1, Sub-test 3 is omitted according to TS25.306 Table 5.1g.

Note 5: β_{ed} cannot be set directly; it is set by Absolute Grant Value.

Note 6: For subtests 2, 3 and 4, UE may perform E-DPDCH power scaling at max power which could results in slightly smaller MPR values.



UMTS BAND II

| Mode | Frequency (MHz) | Avg. Burst Power (dBm) |
|-----------------|-----------------|------------------------|
| WCDMA 1900 RMC | 1852.4 | 22.68 |
| | 1880 | 22.19 |
| | 1907.6 | 22.27 |
| WCDMA 1900 AMR | 1852.4 | 22.10 |
| | 1880 | 21.97 |
| | 1907.6 | 21.70 |
| HSDPA Subtest 1 | 1852.4 | 21.07 |
| | 1880 | 20.94 |
| | 1907.6 | 20.91 |
| HSDPA Subtest 2 | 1852.4 | 20.38 |
| | 1880 | 20.22 |
| | 1907.6 | 20.73 |
| HSDPA Subtest 3 | 1852.4 | 19.94 |
| | 1880 | 19.93 |
| | 1907.6 | 20.20 |
| HSDPA Subtest 4 | 1852.4 | 20.23 |
| | 1880 | 20.48 |
| | 1907.6 | 20.64 |
| HSUPA Subtest 1 | 1852.4 | 20.51 |
| | 1880 | 20.41 |
| | 1907.6 | 20.31 |
| HSUPA Subtest 2 | 1852.4 | 21.61 |
| | 1880 | 21.53 |
| | 1907.6 | 21.33 |
| HSUPA Subtest 3 | 1852.4 | 21.11 |
| | 1880 | 21.07 |
| | 1907.6 | 21.35 |
| HSUPA Subtest 4 | 1852.4 | 21.35 |
| | 1880 | 22.23 |
| | 1907.6 | 22.01 |
| HSUPA Subtest 5 | 1852.4 | 21.08 |
| | 1880 | 21.87 |
| | 1907.6 | 21.70 |

Any report having not been signed by authorized approver, or having been altered without authorization, or having not been stamped by the "Dedicated Testing/Inspection Stamp" is deemed to be invalid. Copying or excerpting portion of, or altering the content of the report is not permitted without the written authorization of AGC. The test results presented in the report apply only to the tested sample. Any objections to report issued by AGC should be submitted to AGC within 15days after the issuance of the test report. Further enquiry of validity or verification of the test report should be addressed to AGC by agc@agc-cert.com.



UMTS BAND V

| Mode | Frequency (MHz) | Avg. Burst Power (dBm) |
|-----------------|-----------------|------------------------|
| WCDMA 850 RMC | 826.4 | 22.64 |
| | 836.6 | 21.91 |
| | 846.6 | 22.00 |
| WCDMA 850 AMR | 826.4 | 22.01 |
| | 836.6 | 21.92 |
| | 846.6 | 21.66 |
| HSDPA Subtest 1 | 826.4 | 21.02 |
| | 836.6 | 21.01 |
| | 846.6 | 20.81 |
| HSDPA Subtest 2 | 826.4 | 20.18 |
| | 836.6 | 19.96 |
| | 846.6 | 20.79 |
| HSDPA Subtest 3 | 826.4 | 19.90 |
| | 836.6 | 20.05 |
| | 846.6 | 19.94 |
| HSDPA Subtest 4 | 826.4 | 20.01 |
| | 836.6 | 20.38 |
| | 846.6 | 20.74 |
| HSUPA Subtest 1 | 826.4 | 20.66 |
| | 836.6 | 20.20 |
| | 846.6 | 20.45 |
| HSUPA Subtest 2 | 826.4 | 21.56 |
| | 836.6 | 21.65 |
| | 846.6 | 21.53 |
| HSUPA Subtest 3 | 826.4 | 21.22 |
| | 836.6 | 21.12 |
| | 846.6 | 21.37 |
| HSUPA Subtest 4 | 826.4 | 21.03 |
| | 836.6 | 22.16 |
| | 846.6 | 22.16 |
| HSUPA Subtest 5 | 826.4 | 21.16 |
| | 836.6 | 21.55 |
| | 846.6 | 21.86 |

Any report having not been signed by authorized approver, or having been altered without authorization, or having not been stamped by the "Dedicated Testing/Inspection Stamp" is deemed to be invalid. Copying or excerpting portion of, or altering the content of the report is not permitted without the written authorization of AGC. The test results presented in the report apply only to the tested sample. Any objections to report issued by AGC should be submitted to AGC within 15days after the issuance of the test report. Further enquiry of validity or verification of the test report should be addressed to AGC by agc@agc-cert.com.



According to 3GPP 25.101 sub-clause 6.2.2 , the maximum output power is allowed to be reduced by following the table.

Table 6.1aA: UE maximum output power with HS-DPCCH and E-DCH

| UE Transmit Channel Configuration | CM(db) | MPR(db) |
|--|----------------------|---------------|
| For all combinations of ,DPDCH,DPCCH HS-DPDCH,E-DPDCH and E-DPCCH | $0 \leq CM \leq 3.5$ | $MAX(CM-1,0)$ |

Note: CM=1 for $\beta_d/\beta_d=12/15$, $\beta_{hs}/\beta_c=24/15$.For all other combinations of DPDCH, DPCCH, HS-DPCCH, E-DPDCH and E-DPCCH the MPR is based on the relative CM difference.

The device supports MPR to solve linearity issues (ACLR or SEM) due to the higher peak-to average ratios (PAR) of the HSUPA signal. This prevents saturating the full range of the TX DAC inside of device and provides a reduced power output to the RF transceiver chip according to the Cubic Metric (a function of the combinations of DPDCH, DPCCH, HS-DPCCH, E-DPDCH and E-DPCCH).

When E-DPDCH channels are present the beta gains on those channels are reduced firsts to try to get the power under the allowed limit. If the beta gains are lowered as far as possible, then a hard limiting is applied at the maximum allowed level.

The SW currently recalculates the cubic metric every time the beta gains on the E-DPDCH are reduced. The cubic metric will likely get lower each time this is done .However, there is no reported reduction of maximum output power in the HSUPA mode since the device also provides a compensation for the power back-off by increasing the gain of TX_AGC in the transceiver (PA) device.

The end effect is that the DUT output power is identical to the case where there is no MPR in the device.

Any report having not been signed by authorized approver, or having been altered without authorization, or having not been stamped by the "Dedicated Testing/Inspection Stamp" is deemed to be invalid. Copying or excerpting portion of, or altering the content of the report is not permitted without the written authorization of AGC. The test results presented in the report apply only to the tested sample. Any objections to report issued by AGC should be submitted to AGC within 15days after the issuance of the test report. Further enquiry of validity or verification of the test report should be addressed to AGC by agc@agc-cert.com.

Attestation of Global Compliance(Shenzhen)Co., Ltd
Attestation of Global Compliance(Shenzhen)Std & Tech Co., Ltd
Tel: +86-755 2523 4088 E-mail: agc@agc-cert.com Web: http://cn.agc-cert.com/



LTE Band

| Conducted Power of LTE Band 2(dBm) | | | | | | | | | |
|------------------------------------|------------|-----------|------------|------------|-----------|--------------|---------|---------|---------|
| Bandwidth | Modulation | RB size | RB offset | Target MPR | Channel | Channel | Channel | | |
| | | | | | 18607 | 18900 | 19193 | | |
| 1.4MHz | QPSK | 1 | 0 | 0 | 23.21 | 23.30 | 22.75 | | |
| | | | 3 | 0 | 23.50 | 23.66 | 22.97 | | |
| | | | 5 | 0 | 23.26 | 23.38 | 22.76 | | |
| | | 3 | 0 | 0 | 23.30 | 23.33 | 23.26 | | |
| | | | 2 | 0 | 23.30 | 23.36 | 22.79 | | |
| | | | 3 | 0 | 23.26 | 23.42 | 22.88 | | |
| | 6 | 0 | 1 | 22.38 | 22.37 | 22.36 | | | |
| | 16QAM | 1 | 0 | 1 | 22.43 | 22.39 | 22.01 | | |
| | | | 3 | 1 | 22.61 | 22.59 | 22.32 | | |
| | | | 5 | 1 | 22.43 | 22.38 | 22.05 | | |
| | | 3 | 0 | 1 | 22.54 | 22.29 | 21.86 | | |
| | | | 2 | 1 | 22.51 | 22.29 | 21.91 | | |
| | | | 3 | 1 | 22.52 | 22.37 | 21.91 | | |
| | | 6 | 0 | 2 | 21.32 | 21.47 | 20.90 | | |
| | | Bandwidth | Modulation | RB size | RB offset | Target MPR | Channel | Channel | Channel |
| | | | | | | | 18615 | 18900 | 19185 |
| | 3MHz | QPSK | 1 | 0 | 0 | 22.92 | 22.93 | 22.81 | |
| | | | | 7 | 0 | 22.94 | 22.93 | 22.81 | |
| 14 | | | | 0 | 22.91 | 22.94 | 22.78 | | |
| 8 | | | 0 | 1 | 21.82 | 22.39 | 21.84 | | |
| | | | 4 | 1 | 21.83 | 22.35 | 21.81 | | |
| | | | 7 | 1 | 21.81 | 22.35 | 21.81 | | |
| 15 | | 0 | 1 | 22.29 | 22.28 | 22.26 | | | |
| 16QAM | | 1 | 0 | 1 | 22.00 | 22.06 | 22.38 | | |
| | | | 7 | 1 | 21.95 | 22.06 | 22.44 | | |
| | | | 14 | 1 | 21.95 | 22.03 | 22.42 | | |
| | | 8 | 0 | 2 | 20.91 | 21.42 | 21.06 | | |
| | | | 4 | 2 | 20.90 | 21.44 | 21.09 | | |
| | | | 7 | 2 | 21.28 | 21.42 | 21.07 | | |
| | | 15 | 0 | 2 | 20.83 | 20.96 | 20.80 | | |

Any report having not been signed by authorized approver, or having been altered without authorization, or having not been stamped by the "Dedicated Testing/Inspection Stamp" is deemed to be invalid. Copying or excerpting portion of, or altering the content of the report is not permitted without the written authorization of AGC. The test results presented in the report apply only to the tested sample. Any objections to report issued by AGC should be submitted to AGC within 15days after the issuance of the test report. Further enquiry of validity or verification of the test report should be addressed to AGC by agc@agc-cert.com.



| Conducted Power of LTE Band 2(dBm) | | | | | | | | |
|------------------------------------|------------|-----------|------------|------------|-----------|------------|---------|---------|
| Bandwidth | Modulation | RB size | RB offset | Target MPR | Channel | Channel | Channel | |
| | | | | | 18625 | 18900 | 19175 | |
| 5MHz | QPSK | 1 | 0 | 0 | 23.18 | 23.30 | 23.11 | |
| | | | 13 | 0 | 22.96 | 23.37 | 22.82 | |
| | | | 24 | 0 | 22.83 | 22.80 | 22.70 | |
| | | 12 | 0 | 1 | 22.24 | 22.39 | 21.86 | |
| | | | 6 | 1 | 22.22 | 22.36 | 22.23 | |
| | | | 13 | 1 | 21.80 | 22.39 | 22.18 | |
| | 25 | 1 | 22.33 | 22.34 | 22.28 | | | |
| | 16QAM | 1 | 0 | 1 | 22.61 | 22.33 | 22.28 | |
| | | | 13 | 1 | 22.67 | 22.46 | 22.45 | |
| | | | 24 | 1 | 22.56 | 22.32 | 22.31 | |
| | | 12 | 0 | 2 | 21.44 | 21.25 | 21.35 | |
| | | | 6 | 2 | 21.44 | 21.26 | 21.34 | |
| | | | 13 | 2 | 21.35 | 21.26 | 21.26 | |
| | | 25 | 2 | 20.85 | 21.38 | 20.83 | | |
| | | Bandwidth | Modulation | RB size | RB offset | Target MPR | Channel | Channel |
| | | | | | | 18650 | 18900 | 19150 |
| 10MHz | QPSK | 1 | 0 | 0 | 23.29 | 22.88 | 22.88 | |
| | | | 25 | 0 | 23.20 | 23.12 | 23.18 | |
| | | | 49 | 0 | 22.88 | 22.88 | 22.92 | |
| | | 25 | 0 | 1 | 22.37 | 22.43 | 21.82 | |
| | | | 13 | 1 | 22.34 | 22.46 | 21.86 | |
| | | | 25 | 1 | 22.41 | 22.40 | 21.81 | |
| | 50 | 1 | 22.37 | 22.34 | 21.80 | | | |
| | 16QAM | 1 | 0 | 1 | 22.57 | 22.88 | 21.99 | |
| | | | 25 | 1 | 22.62 | 23.09 | 22.33 | |
| | | | 49 | 1 | 22.46 | 22.80 | 22.06 | |
| | | 25 | 0 | 2 | 21.53 | 21.41 | 20.89 | |
| | | | 13 | 2 | 21.47 | 21.42 | 20.90 | |
| | | | 25 | 2 | 21.55 | 21.42 | 20.87 | |
| | | 50 | 2 | 20.85 | 20.88 | 20.77 | | |

Any report having not been signed by authorized approver, or having been altered without authorization, or having not been stamped by the "Dedicated Testing/Inspection Stamp" is deemed to be invalid. Copying or excerpting portion of, or altering the content of the report is not permitted without the written authorization of AGC. The test results presented in the report apply only to the tested sample. Any objections to report issued by AGC should be submitted to AGC within 15days after the issuance of the test report. Further enquiry of validity or verification of the test report should be addressed to AGC by agc@agc-cert.com.



| Conducted Power of LTE Band 2(dBm) | | | | | | | | | |
|------------------------------------|------------|---------|------------|------------|-----------|------------|---------|---------|---------|
| Bandwidth | Modulation | RB size | RB offset | Target MPR | Channel | Channel | Channel | | |
| | | | | | 18675 | 18900 | 19125 | | |
| 15MHz | QPSK | 1 | 0 | 0 | 22.88 | 23.26 | 22.72 | | |
| | | | 38 | 0 | 23.02 | 22.98 | 22.92 | | |
| | | | 74 | 0 | 22.94 | 22.80 | 22.81 | | |
| | | 36 | 0 | 1 | 21.92 | 22.46 | 21.93 | | |
| | | | 18 | 1 | 21.96 | 22.51 | 21.91 | | |
| | | | 39 | 1 | 21.97 | 22.46 | 21.93 | | |
| | | 75 | 0 | 1 | 22.48 | 22.44 | 21.92 | | |
| | | 16QAM | 1 | 0 | 1 | 22.45 | 22.39 | 22.34 | |
| | | | | 38 | 1 | 22.07 | 22.95 | 22.47 | |
| | 74 | | | 1 | 22.40 | 22.77 | 22.38 | | |
| | 36 | | 0 | 2 | 21.04 | 21.39 | 20.94 | | |
| | | | 18 | 2 | 21.42 | 21.41 | 20.94 | | |
| | | | 39 | 2 | 21.42 | 21.38 | 20.90 | | |
| | 75 | | 0 | 2 | 20.94 | 20.93 | 20.89 | | |
| | Bandwidth | | Modulation | RB size | RB offset | Target MPR | Channel | Channel | Channel |
| | | | | | | | 18700 | 18900 | 19100 |
| | 20MHz | QPSK | 1 | 0 | 0 | 22.69 | 22.84 | 22.66 | |
| | | | | 50 | 0 | 23.14 | 23.42 | 23.12 | |
| 99 | | | | 0 | 22.76 | 22.81 | 22.65 | | |
| 50 | | | 0 | 1 | 22.28 | 22.40 | 21.83 | | |
| | | | 25 | 1 | 21.81 | 22.37 | 21.82 | | |
| | | | 50 | 1 | 21.94 | 22.25 | 21.78 | | |
| 100 | | | 0 | 1 | 22.35 | 22.11 | 22.25 | | |
| 16QAM | | | 1 | 0 | 1 | 22.00 | 22.37 | 22.13 | |
| | | | | 50 | 1 | 22.56 | 22.91 | 22.64 | |
| | | 99 | | 1 | 21.98 | 22.31 | 22.20 | | |
| | | 50 | 0 | 2 | 20.91 | 21.31 | 20.80 | | |
| | | | 25 | 2 | 20.90 | 21.39 | 20.84 | | |
| | | | 50 | 2 | 21.34 | 21.26 | 20.83 | | |
| | | 100 | 0 | 2 | 20.90 | 20.84 | 20.77 | | |

Any report having not been signed by authorized approver, or having been altered without authorization, or having not been stamped by the "Dedicated Testing/Inspection Stamp" is deemed to be invalid. Copying or excerpting portion of, or altering the content of the report is not permitted without the written authorization of AGC. The test results presented in the report apply only to the tested sample. Any objections to report issued by AGC should be submitted to AGC within 15days after the issuance of the test report. Further enquiry of validity or verification of the test report should be addressed to AGC by agc@agc-cert.com.



| Conducted Power of LTE Band 4(dBm) | | | | | | | | | |
|------------------------------------|------------|-----------|------------|------------|--------------|------------|---------|---------|---------|
| Bandwidth | Modulation | RB size | RB offset | Target MPR | Channel | Channel | Channel | | |
| | | | | | 19957 | 20175 | 20393 | | |
| 1.4MHz | QPSK | 1 | 0 | 0 | 23.13 | 23.14 | 22.74 | | |
| | | | 3 | 0 | 23.28 | 23.26 | 22.93 | | |
| | | | 5 | 0 | 23.17 | 23.05 | 22.66 | | |
| | | 3 | 0 | 0 | 23.30 | 23.23 | 23.05 | | |
| | | | 2 | 0 | 23.27 | 23.22 | 22.61 | | |
| | | | 3 | 0 | 23.28 | 23.21 | 22.59 | | |
| | 6 | 0 | 1 | 22.34 | 22.17 | 22.17 | | | |
| | 16QAM | 1 | 0 | 1 | 22.43 | 22.25 | 21.96 | | |
| | | | 3 | 1 | 22.71 | 22.52 | 21.83 | | |
| | | | 5 | 1 | 22.38 | 22.32 | 21.97 | | |
| | | 3 | 0 | 1 | 22.37 | 22.37 | 21.86 | | |
| | | | 2 | 1 | 22.38 | 22.34 | 22.02 | | |
| | | | 3 | 1 | 22.41 | 22.43 | 21.95 | | |
| | | 6 | 0 | 2 | 21.26 | 21.27 | 20.67 | | |
| | | Bandwidth | Modulation | RB size | RB offset | Target MPR | Channel | Channel | Channel |
| | | | | | | | 19965 | 20175 | 20385 |
| | 3MHz | QPSK | 1 | 0 | 0 | 22.68 | 22.78 | 22.59 | |
| | | | | 7 | 0 | 22.70 | 22.82 | 22.75 | |
| 14 | | | | 0 | 22.64 | 22.77 | 22.67 | | |
| 8 | | | 0 | 1 | 21.68 | 21.71 | 21.69 | | |
| | | | 4 | 1 | 22.18 | 21.75 | 21.66 | | |
| | | | 7 | 1 | 22.17 | 21.64 | 21.64 | | |
| 15 | | 0 | 1 | 22.27 | 21.69 | 21.48 | | | |
| 16QAM | | 1 | 0 | 1 | 22.74 | 21.86 | 21.72 | | |
| | | | 7 | 1 | 22.35 | 21.79 | 21.75 | | |
| | | | 14 | 1 | 22.31 | 21.76 | 21.73 | | |
| | | 8 | 0 | 2 | 20.97 | 20.72 | 20.72 | | |
| | | | 4 | 2 | 21.46 | 20.72 | 20.71 | | |
| | | | 7 | 2 | 21.43 | 20.63 | 20.69 | | |
| | | 15 | 0 | 2 | 20.75 | 20.71 | 20.64 | | |

Any report having not been signed by authorized approver, or having been altered without authorization, or having not been stamped by the "Dedicated Testing/Inspection Stamp" is deemed to be invalid. Copying or excerpting portion of, or altering the content of the report is not permitted without the written authorization of AGC. The test results presented in the report apply only to the tested sample. Any objections to report issued by AGC should be submitted to AGC within 15days after the issuance of the test report. Further enquiry of validity or verification of the test report should be addressed to AGC by agc@agc-cert.com.



| Conducted Power of LTE Band 4(dBm) | | | | | | | | |
|------------------------------------|------------|-----------|------------|------------|-----------|------------|---------|---------|
| Bandwidth | Modulation | RB size | RB offset | Target MPR | Channel | Channel | Channel | |
| | | | | | 19975 | 20175 | 20375 | |
| 5MHz | QPSK | 1 | 0 | 0 | 22.59 | 22.49 | 22.64 | |
| | | | 13 | 0 | 22.65 | 22.68 | 22.76 | |
| | | | 24 | 0 | 22.48 | 22.56 | 22.60 | |
| | | 12 | 0 | 1 | 21.65 | 21.67 | 21.56 | |
| | | | 6 | 1 | 21.65 | 21.68 | 21.56 | |
| | | | 13 | 1 | 21.71 | 21.65 | 21.52 | |
| | 25 | 0 | 1 | 21.75 | 21.61 | 21.45 | | |
| | 16QAM | 1 | 0 | 1 | 21.78 | 21.60 | 21.75 | |
| | | | 13 | 1 | 21.91 | 21.72 | 21.87 | |
| | | | 24 | 1 | 21.74 | 21.59 | 21.73 | |
| | | 12 | 0 | 2 | 20.75 | 20.66 | 20.62 | |
| | | | 6 | 2 | 20.76 | 20.67 | 20.64 | |
| | | | 13 | 2 | 20.78 | 20.61 | 20.54 | |
| | | 25 | 0 | 2 | 20.69 | 20.75 | 20.61 | |
| | | Bandwidth | Modulation | RB size | RB offset | Target MPR | Channel | Channel |
| | | | | | | 20000 | 20175 | 20350 |
| 10MHz | QPSK | 1 | 0 | 0 | 22.67 | 22.75 | 22.68 | |
| | | | 25 | 0 | 22.80 | 22.87 | 23.01 | |
| | | | 49 | 0 | 22.67 | 22.77 | 22.71 | |
| | | 25 | 0 | 1 | 21.64 | 21.73 | 21.69 | |
| | | | 13 | 1 | 21.65 | 21.69 | 21.70 | |
| | | | 25 | 1 | 21.71 | 21.72 | 21.47 | |
| | 50 | 0 | 1 | 21.81 | 21.67 | 21.50 | | |
| | 16QAM | 1 | 0 | 1 | 22.37 | 21.89 | 21.71 | |
| | | | 25 | 1 | 22.59 | 22.14 | 22.00 | |
| | | | 49 | 1 | 22.30 | 21.77 | 21.70 | |
| | | 25 | 0 | 2 | 20.83 | 20.79 | 20.69 | |
| | | | 13 | 2 | 20.82 | 20.81 | 20.71 | |
| | | | 25 | 2 | 20.91 | 20.69 | 20.58 | |
| | | 50 | 0 | 2 | 20.67 | 20.75 | 20.64 | |

Any report having not been signed by authorized approver, or having been altered without authorization, or having not been stamped by the "Dedicated Testing/Inspection Stamp" is deemed to be invalid. Copying or excerpting portion of, or altering the content of the report is not permitted without the written authorization of AGC. The test results presented in the report apply only to the tested sample. Any objections to report issued by AGC should be submitted to AGC within 15days after the issuance of the test report. Further enquiry of validity or verification of the test report should be addressed to AGC by agc@agc-cert.com.



| Conducted Power of LTE Band 4(dBm) | | | | | | | | |
|------------------------------------|------------|------------|-----------|------------|------------|---------|---------|---------|
| Bandwidth | Modulation | RB size | RB offset | Target MPR | Channel | Channel | Channel | |
| | | | | | 20025 | 20175 | 20325 | |
| 15MHz | QPSK | 1 | 0 | 0 | 22.69 | 22.60 | 22.73 | |
| | | | 38 | 0 | 22.64 | 22.72 | 22.88 | |
| | | | 74 | 0 | 22.66 | 22.63 | 22.70 | |
| | | 36 | 0 | 1 | 21.73 | 21.82 | 21.77 | |
| | | | 18 | 1 | 21.77 | 21.82 | 21.75 | |
| | | | 39 | 1 | 21.76 | 21.82 | 21.80 | |
| | | 75 | 0 | 1 | 21.82 | 21.77 | 21.66 | |
| | | 16QAM | 1 | 0 | 1 | 22.26 | 22.20 | 21.66 |
| | | | | 38 | 1 | 22.35 | 22.25 | 21.75 |
| | 74 | | | 1 | 22.24 | 22.07 | 21.59 | |
| | 36 | | 0 | 2 | 20.81 | 20.71 | 20.65 | |
| | | | 18 | 2 | 20.81 | 20.74 | 20.58 | |
| | | | 39 | 2 | 20.73 | 20.74 | 20.66 | |
| | 75 | 0 | 2 | 20.75 | 20.77 | 20.74 | | |
| | Bandwidth | Modulation | RB size | RB offset | Target MPR | Channel | Channel | Channel |
| | | | | | 20050 | 20175 | 20300 | |
| 20MHz | QPSK | 1 | 0 | 0 | 22.51 | 22.49 | 22.36 | |
| | | | 50 | 0 | 23.02 | 23.02 | 22.90 | |
| | | | 99 | 0 | 22.52 | 22.53 | 22.37 | |
| | | 50 | 0 | 1 | 21.57 | 21.59 | 21.57 | |
| | | | 25 | 1 | 21.56 | 21.61 | 21.63 | |
| | | | 50 | 1 | 21.67 | 21.63 | 21.50 | |
| | | 100 | 0 | 1 | 21.69 | 21.66 | 21.47 | |
| | | 16QAM | 1 | 0 | 1 | 21.94 | 21.82 | 21.86 |
| | | | | 50 | 1 | 22.36 | 22.17 | 22.24 |
| | 99 | | | 1 | 21.82 | 21.57 | 21.73 | |
| | 50 | | 0 | 2 | 20.70 | 20.73 | 20.54 | |
| | | | 25 | 2 | 20.66 | 20.74 | 20.57 | |
| | | | 50 | 2 | 20.71 | 20.62 | 20.49 | |
| | 100 | | 0 | 2 | 20.69 | 20.65 | 20.60 | |

Any report having not been signed by authorized approver, or having been altered without authorization, or having not been stamped by the "Dedicated Testing/Inspection Stamp" is deemed to be invalid. Copying or excerpting portion of, or altering the content of the report is not permitted without the written authorization of AGC. The test results presented in the report apply only to the tested sample. Any objections to report issued by AGC should be submitted to AGC within 15days after the issuance of the test report. Further enquiry of validity or verification of the test report should be addressed to AGC by agc@agc-cert.com.



| Conducted Power of LTE Band 7 (dBm) | | | | | | | | |
|-------------------------------------|------------|-----------|------------|------------|-----------|------------|---------|---------|
| Bandwidth | Modulation | RB size | RB offset | Target MPR | Channel | Channel | Channel | |
| | | | | | 20775 | 21100 | 21425 | |
| 5MHz | QPSK | 1 | 0 | 0 | 23.06 | 23.18 | 22.85 | |
| | | | 12 | 0 | 23.22 | 22.81 | 22.97 | |
| | | | 24 | 0 | 23.04 | 22.74 | 22.80 | |
| | | 12 | 0 | 1 | 22.19 | 22.22 | 22.00 | |
| | | | 6 | 1 | 22.18 | 22.23 | 21.95 | |
| | | | 13 | 1 | 22.24 | 22.31 | 21.95 | |
| | 25 | 0 | 1 | 23.65 | 22.22 | 21.90 | | |
| | 16QAM | 1 | 0 | 1 | 22.14 | 22.05 | 21.94 | |
| | | | 12 | 1 | 22.28 | 22.15 | 22.07 | |
| | | | 24 | 1 | 22.17 | 22.04 | 21.94 | |
| | | 12 | 0 | 2 | 21.19 | 20.76 | 20.95 | |
| | | | 6 | 2 | 21.11 | 21.27 | 20.90 | |
| | | | 13 | 2 | 21.24 | 20.80 | 21.00 | |
| | | 25 | 0 | 2 | 21.24 | 20.81 | 20.98 | |
| | | Bandwidth | Modulation | RB size | RB offset | Target MPR | Channel | Channel |
| | | | | | | 20800 | 21100 | 21400 |
| 10MHz | QPSK | 1 | 0 | 0 | 22.76 | 22.74 | 23.09 | |
| | | | 24 | 0 | 22.93 | 23.03 | 23.31 | |
| | | | 49 | 0 | 22.68 | 22.78 | 23.00 | |
| | | 25 | 0 | 1 | 21.69 | 21.74 | 22.23 | |
| | | | 12 | 1 | 21.74 | 21.79 | 22.19 | |
| | | | 25 | 1 | 21.78 | 21.94 | 22.02 | |
| | 50 | 0 | 1 | 22.25 | 21.82 | 22.00 | | |
| | 16QAM | 1 | 0 | 1 | 22.02 | 22.34 | 22.11 | |
| | | | 24 | 1 | 22.27 | 22.60 | 22.35 | |
| | | | 49 | 1 | 22.01 | 22.36 | 22.16 | |
| | | 25 | 0 | 2 | 20.80 | 20.91 | 21.16 | |
| | | | 12 | 2 | 20.82 | 20.92 | 21.17 | |
| | | | 25 | 2 | 20.93 | 20.95 | 21.10 | |
| | | 50 | 0 | 2 | 20.78 | 20.88 | 21.09 | |

Any report having not been signed by authorized approver, or having been altered without authorization, or having not been stamped by the "Dedicated Testing/Inspection Stamp" is deemed to be invalid. Copying or excerpting portion of, or altering the content of the report is not permitted without the written authorization of AGC. The test results presented in the report apply only to the tested sample. Any objections to report issued by AGC should be submitted to AGC within 15days after the issuance of the test report. Further enquiry of validity or verification of the test report should be addressed to AGC by agc@agc-cert.com.



Conducted Power of LTE Band 7 (dBm)

| Bandwidth | Modulation | RB size | RB offset | Target MPR | Channel | Channel | Channel | |
|-----------|------------|------------|-----------|------------|------------|---------|---------|---------|
| | | | | | 20825 | 21100 | 21375 | |
| 15MHz | QPSK | 1 | 0 | 0 | 22.82 | 22.68 | 23.01 | |
| | | | 37 | 0 | 22.77 | 22.88 | 23.09 | |
| | | | 74 | 0 | 22.59 | 22.88 | 22.90 | |
| | | 37 | 0 | 1 | 21.70 | 21.89 | 22.11 | |
| | | | 16 | 1 | 21.69 | 21.88 | 22.11 | |
| | | | 35 | 1 | 21.69 | 21.89 | 22.12 | |
| | 75 | 0 | 1 | 22.24 | 21.95 | 22.10 | | |
| | 16QAM | 1 | 0 | 1 | 21.87 | 22.33 | 22.54 | |
| | | | 37 | 1 | 22.01 | 22.39 | 22.63 | |
| | | | 74 | 1 | 21.92 | 22.37 | 22.47 | |
| | | 37 | 0 | 2 | 20.75 | 20.88 | 21.10 | |
| | | | 16 | 2 | 20.82 | 20.96 | 21.10 | |
| | | | 35 | 2 | 20.82 | 20.95 | 21.04 | |
| | | 75 | 0 | 2 | 20.75 | 20.94 | 21.18 | |
| Bandwidth | | Modulation | RB size | RB offset | Target MPR | Channel | Channel | Channel |
| | | | | | | 20850 | 21100 | 21350 |
| 20MHz | QPSK | 1 | 0 | 0 | 22.72 | 22.47 | 22.84 | |
| | | | 49 | 0 | 23.12 | 22.96 | 23.30 | |
| | | | 99 | 0 | 22.58 | 22.69 | 22.72 | |
| | | 50 | 0 | 1 | 21.63 | 21.74 | 22.14 | |
| | | | 25 | 1 | 21.61 | 21.71 | 22.14 | |
| | | | 49 | 1 | 21.62 | 22.01 | 21.86 | |
| | 100 | 0 | 1 | 21.70 | 21.88 | 21.98 | | |
| | 16QAM | 1 | 0 | 1 | 21.87 | 22.09 | 22.02 | |
| | | | 49 | 1 | 22.41 | 22.66 | 22.52 | |
| | | | 99 | 1 | 21.83 | 22.14 | 22.07 | |
| | | 50 | 0 | 2 | 20.72 | 20.80 | 21.05 | |
| | | | 25 | 2 | 20.69 | 20.80 | 21.02 | |
| | | | 49 | 2 | 20.80 | 20.99 | 20.85 | |
| | | 100 | 0 | 2 | 20.64 | 20.97 | 21.09 | |

Any report having not been signed by authorized approver, or having been altered without authorization, or having not been stamped by the "Dedicated Testing/Inspection Stamp" is deemed to be invalid. Copying or excerpting portion of, or altering the content of the report is not permitted without the written authorization of AGC. The test results presented in the report apply only to the tested sample. Any objections to report issued by AGC should be submitted to AGC within 15days after the issuance of the test report. Further enquiry of validity or verification of the test report should be addressed to AGC by agc@agc-cert.com.



The following tests were conducted according to the test requirements outlined in section 6.2 of the 3GPP TS36.101 specification.

UE Power Class: 3 (23 +/- 2dBm). The allowed Maximum Power Reduction (MPR) for the maximum output power due to higher order modulation and transmit bandwidth configuration (resource blocks) is specified in Table 6.2.3.3-1 of the 3GPP TS36.101.

Table 6.2.3.3-1 Maximum Power Reduction (MPR) for Power class3

| Modulation | Maximum Power Reduction (MPR) for Power[RB] | | | | | | MPR(dB) |
|------------|---|------|------|-------|-------|-------|---------|
| | 1.4MHz | 3MHz | 5MHz | 10MHz | 15MHz | 20MHz | |
| QPSK | >5 | >4 | >8 | >12 | >16 | >18 | ≤1 |
| 16QAM | ≤5 | ≤4 | ≤8 | ≤12 | ≤16 | ≤18 | ≤1 |
| 16QAM | >5 | >4 | >8 | >12 | >16 | >18 | ≤2 |

The allowed A-MPR values specified below in Table 6.2.4.3-1 of 3GPP TS36.101 are in addition to the allowed MPR requirements. All the measurements below were performed with A-MPR disabled, by using Network Signaling Value of "NS_01".3

Any report having not been signed by authorized approver, or having been altered without authorization, or having not been stamped by the "Dedicated Testing/Inspection Stamp" is deemed to be invalid. Copying or excerpting portion of, or altering the content of the report is not permitted without the written authorization of AGC. The test results presented in the report apply only to the tested sample. Any objections to report issued by AGC should be submitted to AGC within 15days after the issuance of the test report. Further enquiry of validity or verification of the test report should be addressed to AGC by agc@agc-cert.com.



Table 6.2.4.3-1: Additional Maximum Power Reduction (A-MPR) / Spectrum Emission requirements

| Network Signaling value | Requirements (sub-clause) | E-UTRA Band | Channel bandwidth (MHz) | Resources Blocks (N_{RB}) | A-MPR (dB) |
|-------------------------|----------------------------|----------------------|-------------------------|---|--------------------------------------|
| NS_01 | 6.6.2.1.1 | Table 5.2-1 | 1.4,3,5,10,15,20 | Table 5.4.2-1 | N/A |
| NS_03 | 6.6.2.2.3.1 | 2,4,10, 23, 25,35,36 | 3 | >5 | ≤ 1 |
| | | | 5 | >6 | ≤ 1 |
| | | | 10 | >6 | ≤ 1 |
| | | | 15 | >8 | ≤ 1 |
| | | | 20 | >10 | ≤ 1 |
| NS_04 | 6.6.2.2.3.2 | 41 | 5 | >6 | ≤ 1 |
| | | | 10, 15, 20 | Table 6.2.4.3-4 | |
| NS_05 | 6.6.3.3.3.1 | 1 | 10,15,20 | ≥ 50 | ≤ 1 |
| NS_06 | 6.6.2.2.3.3 | 12, 13, 14, 17 | 1.4, 3, 5, 10 | Table 5.4.2-1 | N/A |
| NS_07 | 6.6.2.2.3.3 6.6.3.3.3.2 | 13 | 10 | Table 6.2.4.3-2 | Table 6.2.4.3-2 |
| NS_08 | 6.6.3.3.3.3 | 19 | 10, 15 | > 44 | ≤ 3 |
| NS_09 | 6.6.3.3.3.4 | 21 | 10, 15 | > 40 | ≤ 1 |
| | | | | > 55 | ≤ 2 |
| | | | | Table 6.2.4.3-3 | |
| NS_10 | | 20 | 15, 20 | Table 6.2.4.3-3 | Table 6.2.4.3-3 |
| NS_11 | 6.6.2.2.1 6.6.3.3.13 | 231 | 1.4, 3, 5, 10,15,20 | Table 6.2.4.3-5 | Table 6.2.4.3-5 |
| NS_12 | 6.6.3.3.5 | 26 | 1.4, 3, 5 | Table 6.2.4.3-6 | Table 6.2.4.3-6 |
| NS_13 | 6.6.3.3.6 | 26 | 5 | Table 6.2.4.3-7 | Table 6.2.4.3-7 |
| NS_14 | 6.6.3.3.7 | 26 | 10, 15 | Table 6.2.4.3-8 | Table 6.2.4.3-8 |
| NS_15 | 6.6.3.3.8 | 26 | 1.4, 3, 5, 10, 15 | Table 6.2.4.3-9 Table 6.2.4.3-10 | Table 6.2.4.3-9, Table 6.2.4.3-10 |
| NS_16 | 6.6.3.3.9 | 27 | 3, 5, 10 | Table 6.2.4.3-11, Table 6.2.4.3-12, Table 6.2.4.3-13 | |
| NS_17 | 6.6.3.3.10 6.6.3.3.11 | 28 28 | 5, 10 | Table 5.4.2-1 | N/A |
| | | | 5 | ≥ 2 | ≤ 1 |
| NS_18 | | | 10, 15, 20 | ≥ 1 | ≤ 4 |
| NS_19 | | | 10, 15, 20 | Table 6.2.4.3-15 | Table 6.2.4.3-15 |
| NS_20 | | | 5, 10, 15, 20 | Table 6.2.4.3-14 | Table 6.2.4.3-14 |
| ... | | | | | |
| NS_20 | - | - | - | - | - |

Any report having not been signed by authorized approver, or having been altered without authorization, or having not been stamped by the "Dedicated Testing/Inspection Stamp" is deemed to be invalid. Copying or excerpting portion of, or altering the content of the report is not permitted without the written authorization of AGC. The test results presented in the report apply only to the tested sample. Any objections to report issued by AGC should be submitted to AGC within 15 days after the issuance of the test report. Further enquiry of validity or verification of the test report should be addressed to AGC by agc@agc-cert.com.



WIFI

| Mode | Data Rate (Mbps) | Channel | Frequency(MHz) | Avg. Burst Power(dBm) |
|-------------|------------------|---------|----------------|-----------------------|
| 802.11b | 1 | 01 | 2412 | 17.76 |
| | | 06 | 2437 | 17.61 |
| | | 11 | 2462 | 17.71 |
| 802.11g | 6 | 01 | 2412 | 13.52 |
| | | 06 | 2437 | 13.33 |
| | | 11 | 2462 | 13.47 |
| 802.11n(20) | 6.5 | 01 | 2412 | 13.41 |
| | | 06 | 2437 | 13.16 |
| | | 11 | 2462 | 13.33 |
| 802.11n(40) | 13.5 | 03 | 2422 | 10.73 |
| | | 06 | 2437 | 10.50 |
| | | 09 | 2452 | 10.56 |

Bluetooth_V4.0(BR/EDR)

| Modulation | Channel | Frequency(MHz) | Peak Power (dBm) |
|------------|---------|----------------|------------------|
| GFSK | 0 | 2402 | 9.18 |
| | 39 | 2441 | 9.14 |
| | 78 | 2480 | 9.14 |
| π /4-DQPSK | 0 | 2402 | 9.15 |
| | 39 | 2441 | 8.27 |
| | 78 | 2480 | 8.29 |
| 8-DPSK | 0 | 2402 | 9.17 |
| | 39 | 2441 | 8.22 |
| | 78 | 2480 | 8.32 |

Bluetooth_V4.0(BLE)

| Modulation | Channel | Frequency(MHz) | Peak Power (dBm) |
|------------|---------|----------------|------------------|
| 1M | | | |
| GFSK | 0 | 2402 | -1.98 |
| | 19 | 2440 | -1.92 |
| | 39 | 2480 | -1.88 |
| 2M | | | |
| GFSK | 0 | 2402 | -2.04 |
| | 19 | 2440 | -1.94 |
| | 39 | 2480 | -1.84 |

Any report having not been signed by authorized approver, or having been altered without authorization, or having not been stamped by the "Dedicated Testing/Inspection Stamp" is deemed to be invalid. Copying or excerpting portion of, or altering the content of the report is not permitted without the written authorization of AGC. The test results presented in the report apply only to the tested sample. Any objections to report issued by AGC should be submitted to AGC within 15days after the issuance of the test report. Further enquiry of validity or verification of the test report should be addressed to AGC by agc@agc-cert.com.



13. TEST RESULTS

13.1. SAR Test Results Summary

13.1.1. Test position and configuration

Head SAR was performed with the device configured in the positions according to IEEE 1528-2013, Body-worn and 4 Edges SAR was performed with the device 10mm from the phantom.

13.1.2. Operation Mode

1. Per KDB 447498 D01 v06 ,for each exposure position, if the highest 1-g SAR is ≤ 0.8 W/kg, testing for low and high channel is optional.
2. Per KDB 865664 D01 v01r04,for each frequency band, if the measured SAR is ≥ 0.8 W/Kg, testing for repeated SAR measurement is required , that the highest measured SAR is only to be tested. When the SAR results are near the limit, the following procedures are required for each device to verify these types of SAR measurement related variation concerns by repeating the highest measured SAR configuration in each frequency band.
 - (1) When the original highest measured SAR is ≥ 0.8 W/Kg, repeat that measurement once.
 - (2) Perform a second repeated measurement only if the ratio of largest to smallest SAR for the original and first repeated measurements is >1.20 or when the original or repeated measurement is ≥ 1.45 W/Kg.
 - (3) Perform a third repeated measurement only if the original, first and second repeated measurement is ≥ 1.5 W/Kg and ratio of largest to smallest SAR for the original, first and second measurement is ≥ 1.20 .
3. Body-worn exposure conditions are intended to voice call operations, therefore GSM voice call mode is selected to be test.
4. Per KDB 648474 D04 v01r03,when the reported SAR for a body-worn accessory measured without a headset connected to the handset is ≤ 1.2 W/Kg, SAR testing with a headset connected is not required.
5. Per KDB 248227 D01v02r02,for 2.4GHz 802.11g/n SAR testing is not required when the highest reported SAR for DSSS is adjusted by the ratio of OFDM to DSSS specified maximum output power and the adjusted SAR is ≤ 1.2 W/kg.
6. Per KDB 941225 D06 V02r01, When the same wireless mode transmission configurations for voice and data are required for SAR measurements, the more conservative configuration with a smaller separation distance should be tested for the overlapping SAR configurations.
7. Maximum Scaling SAR in order to calculate the Maximum SAR values to test under the standard Peak Power, Calculation method is as follows:
Maximum Scaling SAR =tested SAR (Max.) \times [maximum turn-up power (mw)/ maximum measurement output power(mw)]
8. Proximity sensor, just for avoiding the wrong operation in the phone screen when call, and has no influence on output power or SAR result
9. Per KDB 941225 D05v02r03, start with the largest channel bandwidth and measure SAR for QPSK with 1RB allocation using the RB offset and required test channel combination with highest maximum output power for RB offsets at the upper edge, middle and lower edge of each required test channel.
10. Per KDB 941125 D05v02r03, 50% RB allocation for QPSK SAR testing follows 1RB QPSK allocation procedure.
11. Per KDB 941125 D05v02r03. For QPSK with 100% RB allocation. SAR is not required when the highest maximum output power for 100% RB allocation is less than the highest maximum output power in 50% and

Any report having not been signed by authorized approver, or having been altered without authorization, or having not been stamped by the "Dedicated Testing/Inspection Stamp" is deemed to be invalid. Copying or excerpting portion of, or altering the content of the report is not permitted without the written authorization of AGC. The test results presented in the report apply only to the tested sample. Any objections to report issued by AGC should be submitted to AGC within 15days after the issuance of the test report. Further enquiry of validity or verification of the test report should be addressed to AGC by agc@agc-cert.com.



1RB allocation and the highest reported SAR is >1.45 W/Kg, the remaining required test channels must also be tested.

12. Per KDB 941125 D05v02r03. 16QAM output power for each RB allocation configuration is not 1/2 dB higher than the same configuration in QPSK and the reported SAR for the QPSK configuration is ≤ 1.45 W/Kg, Per KDB 941225 D05v02r02, 16QAM SAR testing is not required.
13. Per KDB 941125 D05v02r03. Smaller bandwidth output power for each RB allocation configuration is $>$ not 1/2 dB higher than the same configuration in the largest supported bandwidth, and the reported SAR for the largest supported bandwidth is ≤ 1.45 W/Kg. Per KDB 941125 D05v02r03, smaller bandwidth SAR testing is not required.

Any report having not been signed by authorized approver, or having been altered without authorization, or having not been stamped by the "Dedicated Testing/Inspection Stamp" is deemed to be invalid. Copying or excerpting portion of, or altering the content of the report is not permitted without the written authorization of AGC. The test results presented in the report apply only to the tested sample. Any objections to report issued by AGC should be submitted to AGC within 15days after the issuance of the test report. Further enquiry of validity or verification of the test report should be addressed to AGC by agc@agc-cert.com.

Attestation of Global Compliance(Shenzhen)Co., Ltd
Attestation of Global Compliance(Shenzhen)Std & Tech Co., Ltd
Tel: +86-755 2523 4088 E-mail: agc@agc-cert.com Web: <http://cn.agc-cert.com/>



13.1.3. Test Result

| SAR MEASUREMENT | | | | | | | | | |
|--|-------------|-----|-----------|--------------------|-----------------------------|--------------------------|--------------------------|-------------------|--------------|
| Depth of Liquid (cm):>15 | | | | | Relative Humidity (%): 50.6 | | | | |
| Product: SMART PHONE | | | | | | | | | |
| Test Mode: GSM850 with GMSK modulation | | | | | | | | | |
| Position | Mode | Ch. | Fr. (MHz) | Power Drift (<±5%) | SAR (1g) (W/kg) | Max. Tune-up Power (dBm) | Meas. output Power (dBm) | Scaled SAR (W/Kg) | Limit (W/kg) |
| SIM 1 Card | | | | | | | | | |
| Left Cheek | voice | 190 | 836.6 | -0.36 | 0.073 | 32.10 | 32.00 | 0.075 | 1.6 |
| Left Tilt | voice | 190 | 836.6 | -0.27 | 0.062 | 32.10 | 32.00 | 0.063 | 1.6 |
| Right Cheek | voice | 190 | 836.6 | -0.54 | 0.086 | 32.10 | 32.00 | 0.088 | 1.6 |
| Right Tilt | voice | 190 | 836.6 | 0.42 | 0.075 | 32.10 | 32.00 | 0.077 | 1.6 |
| Body back | voice | 190 | 836.6 | -0.18 | 0.109 | 32.10 | 32.00 | 0.112 | 1.6 |
| Body front | voice | 190 | 836.6 | -0.62 | 0.081 | 32.10 | 32.00 | 0.083 | 1.6 |
| Body back | GPRS-3 slot | 190 | 836.6 | -0.35 | 0.310 | 29.20 | 29.19 | 0.311 | 1.6 |
| Body front | GPRS-3 slot | 190 | 836.6 | 0.26 | 0.226 | 29.20 | 29.19 | 0.227 | 1.6 |
| Edge 2(Right) | GPRS-3 slot | 190 | 836.6 | -0.27 | 0.166 | 29.20 | 29.19 | 0.166 | 1.6 |
| Edge 3(Bottom) | GPRS-3 slot | 190 | 836.6 | -0.42 | 0.197 | 29.20 | 29.19 | 0.197 | 1.6 |

Note:

- When the 1-g Reported SAR is ≤ 0.8 W/kg, testing for low and high channel is optional. Refer to KDB 447498.
- The test separation for body back, body front and 4 Edges is 10mm of all above table.

Any report having not been signed by authorized approver, or having been altered without authorization, or having not been stamped by the "Dedicated Testing/Inspection Stamp" is deemed to be invalid. Copying or excerpting portion of, or altering the content of the report is not permitted without the written authorization of AGC. The test results presented in the report apply only to the tested sample. Any objections to report issued by AGC should be submitted to AGC within 15days after the issuance of the test report. Further enquiry of validity or verification of the test report should be addressed to AGC by agc@agc-cert.com.



| SAR MEASUREMENT | | | | | | | | | |
|---|-------------|-----|-----------|--------------------|-----------------------------|--------------------------|--------------------------|-------------------|--------------|
| Depth of Liquid (cm):>15 | | | | | Relative Humidity (%): 49.8 | | | | |
| Product: SMART PHONE | | | | | | | | | |
| Test Mode: PCS1900 with GMSK modulation | | | | | | | | | |
| Position | Mode | Ch. | Fr. (MHz) | Power Drift (<±5%) | SAR (1g) (W/kg) | Max. Tune-up Power (dBm) | Meas. output Power (dBm) | Scaled SAR (W/Kg) | Limit (W/kg) |
| SIM 1 Card | | | | | | | | | |
| Left Cheek | voice | 661 | 1880.0 | -0.17 | 0.077 | 30.00 | 29.96 | 0.078 | 1.6 |
| Left Tilt | voice | 661 | 1880.0 | -0.26 | 0.033 | 30.00 | 29.96 | 0.033 | 1.6 |
| Right Cheek | voice | 661 | 1880.0 | 0.32 | 0.111 | 30.00 | 29.96 | 0.112 | 1.6 |
| Right Tilt | voice | 661 | 1880.0 | -0.04 | 0.048 | 30.00 | 29.96 | 0.048 | 1.6 |
| Body back | voice | 661 | 1880.0 | -0.24 | 0.275 | 30.00 | 29.96 | 0.278 | 1.6 |
| Body front | voice | 661 | 1880.0 | -0.11 | 0.164 | 30.00 | 29.96 | 0.166 | 1.6 |
| Body back | GPRS-4 slot | 512 | 1850.2 | -0.33 | 0.719 | 25.80 | 25.34 | 0.799 | 1.6 |
| Body back | GPRS-4 slot | 661 | 1880 | -0.24 | 0.822 | 25.80 | 25.65 | 0.851 | 1.6 |
| Body back | GPRS-4 slot | 810 | 1909.8 | 0.51 | 0.731 | 25.80 | 25.72 | 0.745 | 1.6 |
| Body front | GPRS-4 slot | 661 | 1880.0 | -0.08 | 0.519 | 25.80 | 25.65 | 0.537 | 1.6 |
| Edge 2(Right) | GPRS-4 slot | 661 | 1880.0 | -0.24 | 0.287 | 25.80 | 25.65 | 0.297 | 1.6 |
| Edge 3(Bottom) | GPRS-4 slot | 661 | 1880.0 | -0.32 | 0.446 | 25.80 | 25.65 | 0.462 | 1.6 |

Note:

- When the 1-g Reported SAR is ≤ 0.8 W/kg, testing for low and high channel is optional. Refer to KDB 447498.
- The test separation for body back, body front and 4 Edges is 10mm of all above table.

Any report having not been signed by authorized approver, or having been altered without authorization, or having not been stamped by the "Dedicated Testing/Inspection Stamp" is deemed to be invalid. Copying or excerpting portion of, or altering the content of the report is not permitted without the written authorization of AGC. The test results presented in the report apply only to the tested sample. Any objections to report issued by AGC should be submitted to AGC within 15days after the issuance of the test report. Further enquiry of validity or verification of the test report should be addressed to AGC by agc@agc-cert.com.



| SAR MEASUREMENT | | | | | | | | | |
|---|--------------|------|-----------|------------------------------------|-----------------------------|--------------------------|--------------------------|-------------------|--------------|
| Depth of Liquid (cm):>15 | | | | | Relative Humidity (%): 49.8 | | | | |
| Product: SMART PHONE | | | | | | | | | |
| Test Mode: WCDMA Band II with QPSK modulation | | | | | | | | | |
| Position | Mode | Ch. | Fr. (MHz) | Power Drift ($\pm 5\%$) | SAR (1g) (W/kg) | Max. Tune-up Power (dBm) | Meas. output Power (dBm) | Scaled SAR (W/Kg) | Limit (W/kg) |
| Left Cheek | RMC 12.2kbps | 9400 | 1880 | -0.39 | 0.122 | 22.70 | 22.19 | 0.137 | 1.6 |
| Left Tilt | RMC 12.2kbps | 9400 | 1880 | -0.65 | 0.045 | 22.70 | 22.19 | 0.051 | 1.6 |
| Right Cheek | RMC 12.2kbps | 9400 | 1880 | 0.27 | 0.153 | 22.70 | 22.19 | 0.172 | 1.6 |
| Right Tilt | RMC 12.2kbps | 9400 | 1880 | -0.42 | 0.055 | 22.70 | 22.19 | 0.062 | 1.6 |
| Body back | RMC 12.2kbps | 9400 | 1880 | -0.15 | 0.474 | 22.70 | 22.19 | 0.533 | 1.6 |
| Body front | RMC 12.2kbps | 9400 | 1880 | 0.24 | 0.234 | 22.70 | 22.19 | 0.263 | 1.6 |
| Edge 2(Right) | RMC 12.2kbps | 9400 | 1880 | -0.27 | 0.145 | 22.70 | 22.19 | 0.163 | 1.6 |
| Edge 3(Bottom) | RMC 12.2kbps | 9400 | 1880 | -0.42 | 0.244 | 22.70 | 22.19 | 0.274 | 1.6 |

Note:

- When the 1-g Reported SAR is ≤ 0.8 W/kg, testing for low and high channel is optional. Refer to KDB 447498.
- The test separation for body back, body front and 4 Edges is 10mm of all above table.

Any report having not been signed by authorized approver, or having been altered without authorization, or having not been stamped by the "Dedicated Testing/Inspection Stamp" is deemed to be invalid. Copying or excerpting portion of, or altering the content of the report is not permitted without the written authorization of AGC. The test results presented in the report apply only to the tested sample. Any objections to report issued by AGC should be submitted to AGC within 15days after the issuance of the test report. Further enquiry of validity or verification of the test report should be addressed to AGC by agc@agc-cert.com.

Attestation of Global Compliance(Shenzhen)Co., Ltd
Attestation of Global Compliance(Shenzhen)Std & Tech Co., Ltd
Tel: +86-755 2523 4088 E-mail: agc@agc-cert.com Web: http://cn.agc-cert.com/



| SAR MEASUREMENT | | | | | | | | | |
|--|--------------|------|-----------|---|-----------------------------|--------------------------|--------------------------|-------------------|--------------|
| Depth of Liquid (cm):>15 | | | | | Relative Humidity (%): 50.6 | | | | |
| Product: SMART PHONE | | | | | | | | | |
| Test Mode: WCDMA Band V with QPSK modulation | | | | | | | | | |
| Position | Mode | Ch. | Fr. (MHz) | Power Drift ($\leq \pm 5\%$) | SAR (1g) (W/kg) | Max. Tune-up Power (dBm) | Meas. output Power (dBm) | Scaled SAR (W/Kg) | Limit (W/kg) |
| Left Cheek | RMC 12.2kbps | 4183 | 836.6 | -0.33 | 0.060 | 22.70 | 21.91 | 0.072 | 1.6 |
| Left Tilt | RMC 12.2kbps | 4183 | 836.6 | -0.15 | 0.065 | 22.70 | 21.91 | 0.078 | 1.6 |
| Right Cheek | RMC 12.2kbps | 4183 | 836.6 | -0.07 | 0.065 | 22.70 | 21.91 | 0.078 | 1.6 |
| Right Tilt | RMC 12.2kbps | 4183 | 836.6 | 0.42 | 0.065 | 22.70 | 21.91 | 0.078 | 1.6 |
| Body back | RMC 12.2kbps | 4183 | 836.6 | -0.16 | 0.092 | 22.70 | 21.91 | 0.110 | 1.6 |
| Body front | RMC 12.2kbps | 4183 | 836.6 | -0.32 | 0.066 | 22.70 | 21.91 | 0.079 | 1.6 |
| Edge 2(Right) | RMC 12.2kbps | 4183 | 836.6 | -0.05 | 0.039 | 22.70 | 21.91 | 0.047 | 1.6 |
| Edge 3(Bottom) | RMC 12.2kbps | 4183 | 836.6 | 0.12 | 0.054 | 22.70 | 21.91 | 0.065 | 1.6 |

Note:

- When the 1-g Reported SAR is ≤ 0.8 W/kg, testing for low and high channel is optional. Refer to KDB 447498.
- The test separation for body back, body front and 4 Edges is 10mm of all above table.

Any report having not been signed by authorized approver, or having been altered without authorization, or having not been stamped by the "Dedicated Testing/Inspection Stamp" is deemed to be invalid. Copying or excerpting portion of, or altering the content of the report is not permitted without the written authorization of AGC. The test results presented in the report apply only to the tested sample. Any objections to report issued by AGC should be submitted to AGC within 15days after the issuance of the test report. Further enquiry of validity or verification of the test report should be addressed to AGC by agc@agc-cert.com.

Attestation of Global Compliance(Shenzhen)Co., Ltd
Attestation of Global Compliance(Shenzhen)Std & Tech Co., Ltd
Tel: +86-755 2523 4088 E-mail: agc@agc-cert.com Web: http://cn.agc-cert.com/



| SAR MEASUREMENT | | | | | | | | | | | | |
|--------------------------|------|----------------|------------------|-------------|-------|----------------------------|--------------------|-----------------|--------------------------|--------------------------|-------------------|--------------|
| Depth of Liquid (cm):>15 | | | | | | Relative Humidity (%):47.9 | | | | | | |
| Product: SMART PHONE | | | | | | | | | | | | |
| Test Mode: LTE Band 2 | | | | | | | | | | | | |
| BM MHz | MOD | Position | Test Mode | | Ch. | Freq. (MHz) | Power Drift (<±5%) | SAR (1g) (W/kg) | Max. Tune up Power (dBm) | Meas. output Power (dBm) | Scaled SAR (W/Kg) | Limit (W/kg) |
| | | | UL RB Allocation | UL RB START | | | | | | | | |
| 20 | QPSK | Left Cheek | 1 | 0 | 18900 | 1880 | -0.15 | 0.128 | 23.70 | 22.84 | 0.156 | 1.6 |
| | | Left Tilt | 1 | 0 | 18900 | 1880 | -0.32 | 0.040 | 23.70 | 22.84 | 0.049 | 1.6 |
| | | Right Cheek | 1 | 0 | 18900 | 1880 | 0.05 | 0.144 | 23.70 | 22.84 | 0.176 | 1.6 |
| | | Right Tilt | 1 | 0 | 18900 | 1880 | -0.35 | 0.052 | 23.70 | 22.84 | 0.063 | 1.6 |
| | | Body back | 1 | 0 | 18900 | 1880 | -0.25 | 0.395 | 23.70 | 22.84 | 0.482 | 1.6 |
| | | Body front | 1 | 0 | 18900 | 1880 | -0.32 | 0.220 | 23.70 | 22.84 | 0.268 | 1.6 |
| | | Edge 2(Right) | 1 | 0 | 18900 | 1880 | -0.04 | 0.141 | 23.70 | 22.84 | 0.172 | 1.6 |
| | | Edge 3(Bottom) | 1 | 0 | 18900 | 1880 | -0.20 | 0.235 | 23.70 | 22.84 | 0.286 | 1.6 |
| | | Left Cheek | 50% | 0 | 18900 | 1880 | -0.02 | 0.093 | 23.70 | 22.40 | 0.125 | 1.6 |
| | | Left Tilt | 50% | 0 | 18900 | 1880 | 0.15 | 0.028 | 23.70 | 22.40 | 0.038 | 1.6 |
| | | Right Cheek | 50% | 0 | 18900 | 1880 | -0.32 | 0.113 | 23.70 | 22.40 | 0.152 | 1.6 |
| | | Right Tilt | 50% | 0 | 18900 | 1880 | -0.04 | 0.037 | 23.70 | 22.40 | 0.050 | 1.6 |
| | | Body back | 50% | 0 | 18900 | 1880 | -0.17 | 0.134 | 23.70 | 22.40 | 0.181 | 1.6 |
| | | Body front | 50% | 0 | 18900 | 1880 | 0.12 | 0.067 | 23.70 | 22.40 | 0.090 | 1.6 |
| | | Edge 2(Right) | 50% | 0 | 18900 | 1880 | -0.06 | 0.052 | 23.70 | 22.40 | 0.070 | 1.6 |
| | | Edge 3(Bottom) | 50% | 0 | 18900 | 1880 | 0.32 | 0.073 | 23.70 | 22.40 | 0.098 | 1.6 |

Note:

- When the 1-g Reported SAR is ≤ 0.8 W/kg, testing for low and high channel is optional. Refer to KDB 447498.
- The test separation for body back, body front and 4 Edges is 10mm of all above table.

Any report having not been signed by authorized approver, or having been altered without authorization, or having not been stamped by the "Dedicated Testing/Inspection Stamp" is deemed to be invalid. Copying or excerpting portion of, or altering the content of the report is not permitted without the written authorization of AGC. The test results presented in the report apply only to the tested sample. Any objections to report issued by AGC should be submitted to AGC within 15days after the issuance of the test report. Further enquiry of validity or verification of the test report should be addressed to AGC by agc@agc-cert.com.



| SAR MEASUREMENT | | | | | | | | | | | | |
|--------------------------|------|----------------|------------------|-------------|-------|----------------------------|------------------------------------|-----------------|-------------------------|--------------------------|-------------------|--------------|
| Depth of Liquid (cm):>15 | | | | | | Relative Humidity (%):49.8 | | | | | | |
| Product: SMART PHONE | | | | | | | | | | | | |
| Test Mode: LTE Band 4 | | | | | | | | | | | | |
| BM MHz | MOD | Position | Test Mode | | Ch. | Freq. (MHz) | Power Drift ($\pm 5\%$) | SAR (1g) (W/kg) | Max. Tuneup Power (dBm) | Meas. output Power (dBm) | Scaled SAR (W/Kg) | Limit (W/kg) |
| | | | UL RB Allocation | UL RB START | | | | | | | | |
| 20 | QPSK | Left Cheek | 1 | 0 | 20175 | 1732.5 | 0.17 | 0.078 | 23.40 | 22.49 | 0.096 | 1.6 |
| | | Left Tilt | 1 | 0 | 20175 | 1732.5 | -0.35 | 0.029 | 23.40 | 22.49 | 0.036 | 1.6 |
| | | Right Cheek | 1 | 0 | 20175 | 1732.5 | -0.26 | 0.122 | 23.40 | 22.49 | 0.150 | 1.6 |
| | | Right Tilt | 1 | 0 | 20175 | 1732.5 | 0.24 | 0.050 | 23.40 | 22.49 | 0.062 | 1.6 |
| | | Body back | 1 | 0 | 20175 | 1732.5 | 0.13 | 0.295 | 23.40 | 22.49 | 0.364 | 1.6 |
| | | Body front | 1 | 0 | 20175 | 1732.5 | -0.25 | 0.212 | 23.40 | 22.49 | 0.261 | 1.6 |
| | | Edge 2(Right) | 1 | 0 | 20175 | 1732.5 | 0.27 | 0.102 | 23.40 | 22.49 | 0.126 | 1.6 |
| | | Edge 3(Bottom) | 1 | 0 | 20175 | 1732.5 | -0.42 | 0.159 | 23.40 | 22.49 | 0.196 | 1.6 |
| | | Left Cheek | 50% | 0 | 20175 | 1732.5 | 0.25 | 0.073 | 23.40 | 21.59 | 0.111 | 1.6 |
| | | Left Tilt | 50% | 0 | 20175 | 1732.5 | 0.46 | 0.027 | 23.40 | 21.59 | 0.041 | 1.6 |
| | | Right Cheek | 50% | 0 | 20175 | 1732.5 | -0.15 | 0.072 | 23.40 | 21.59 | 0.109 | 1.6 |
| | | Right Tilt | 50% | 0 | 20175 | 1732.5 | -0.32 | 0.038 | 23.40 | 21.59 | 0.058 | 1.6 |
| | | Body back | 50% | 0 | 20175 | 1732.5 | 0.06 | 0.183 | 23.40 | 21.59 | 0.278 | 1.6 |
| | | Body front | 50% | 0 | 20175 | 1732.5 | 0.52 | 0.143 | 23.40 | 21.59 | 0.217 | 1.6 |
| | | Edge 2(Right) | 50% | 0 | 20175 | 1732.5 | 0.12 | 0.055 | 23.40 | 21.59 | 0.083 | 1.6 |
| | | Edge 3(Bottom) | 50% | 0 | 20175 | 1732.5 | -0.05 | 0.151 | 23.40 | 21.59 | 0.229 | 1.6 |

Note:

- When the 1-g Reported SAR is ≤ 0.8 W/kg, testing for low and high channel is optional. Refer to KDB 447498.
- The test separation for body back, body front and 4 Edges is 10mm of all above table.

Any report having not been signed by authorized approver, or having been altered without authorization, or having not been stamped by the "Dedicated Testing/Inspection Stamp" is deemed to be invalid. Copying or excerpting portion of, or altering the content of the report is not permitted without the written authorization of AGC. The test results presented in the report apply only to the tested sample. Any objections to report issued by AGC should be submitted to AGC within 15days after the issuance of the test report. Further enquiry of validity or verification of the test report should be addressed to AGC by agc@agc-cert.com.

Attestation of Global Compliance(Shenzhen)Co., Ltd
Attestation of Global Compliance(Shenzhen)Std & Tech Co., Ltd
Tel: +86-755 2523 4088 E-mail: agc@agc-cert.com Web: http://cn.agc-cert.com/



| SAR MEASUREMENT | | | | | | | | | | | | |
|--------------------------|------|----------------|------------------|-------------|-------|----------------------------|------------------------------------|-----------------|-------------------------|--------------------------|-------------------|--------------|
| Depth of Liquid (cm):>15 | | | | | | Relative Humidity (%):51.8 | | | | | | |
| Product: SMART PHONE | | | | | | | | | | | | |
| Test Mode: LTE Band 7 | | | | | | | | | | | | |
| BM MHz | MOD | Position | Test Mode | | Ch. | Freq. (MHz) | Power Drift ($\pm 5\%$) | SAR (1g) (W/kg) | Max. Tuneup Power (dBm) | Meas. output Power (dBm) | Scaled SAR (W/Kg) | Limit (W/kg) |
| | | | UL RB Allocation | UL RB START | | | | | | | | |
| 20 | QPSK | Left Cheek | 1 | 0 | 21100 | 2535 | -0.33 | 0.083 | 23.40 | 22.47 | 0.103 | 1.6 |
| | | Left Tilt | 1 | 0 | 21100 | 2535 | -0.20 | 0.037 | 23.40 | 22.47 | 0.046 | 1.6 |
| | | Right Cheek | 1 | 0 | 21100 | 2535 | 0.05 | 0.128 | 23.40 | 22.47 | 0.159 | 1.6 |
| | | Right Tilt | 1 | 0 | 21100 | 2535 | -0.27 | 0.030 | 23.40 | 22.47 | 0.037 | 1.6 |
| | | Body back | 1 | 0 | 21100 | 2535 | 0.42 | 0.179 | 23.40 | 22.47 | 0.222 | 1.6 |
| | | Body front | 1 | 0 | 21100 | 2535 | -0.05 | 0.105 | 23.40 | 22.47 | 0.130 | 1.6 |
| | | Edge 2(Right) | 1 | 0 | 21100 | 2535 | -0.16 | 0.062 | 23.40 | 22.47 | 0.077 | 1.6 |
| | | Edge 3(Bottom) | 1 | 0 | 21100 | 2535 | -0.37 | 0.095 | 23.40 | 22.47 | 0.118 | 1.6 |
| | | Left Cheek | 50% | 0 | 21100 | 2535 | -0.11 | 0.022 | 23.40 | 21.74 | 0.032 | 1.6 |
| | | Left Tilt | 50% | 0 | 21100 | 2535 | 0.32 | 0.014 | 23.40 | 21.74 | 0.021 | 1.6 |
| | | Right Cheek | 50% | 0 | 21100 | 2535 | -0.05 | 0.027 | 23.40 | 21.74 | 0.040 | 1.6 |
| | | Right Tilt | 50% | 0 | 21100 | 2535 | -0.24 | 0.008 | 23.40 | 21.74 | 0.012 | 1.6 |
| | | Body back | 50% | 0 | 21100 | 2535 | -0.17 | 0.138 | 23.40 | 21.74 | 0.202 | 1.6 |
| | | Body front | 50% | 0 | 21100 | 2535 | -0.52 | 0.085 | 23.40 | 21.74 | 0.125 | 1.6 |
| | | Edge 2(Right) | 50% | 0 | 21100 | 2535 | 0.16 | 0.058 | 23.40 | 21.74 | 0.085 | 1.6 |
| | | Edge 3(Bottom) | 50% | 0 | 21100 | 2535 | -0.36 | 0.079 | 23.40 | 21.74 | 0.116 | 1.6 |

Note:

- When the 1-g Reported SAR is ≤ 0.8 W/kg, testing for low and high channel is optional. Refer to KDB 447498.
- The test separation for body back, body front and 4 Edges is 10mm of all above table.

Any report having not been signed by authorized approver, or having been altered without authorization, or having not been stamped by the "Dedicated Testing/Inspection Stamp" is deemed to be invalid. Copying or excerpting portion of, or altering the content of the report is not permitted without the written authorization of AGC. The test results presented in the report apply only to the tested sample. Any objections to report issued by AGC should be submitted to AGC within 15days after the issuance of the test report. Further enquiry of validity or verification of the test report should be addressed to AGC by agc@agc-cert.com.



| SAR MEASUREMENT | | | | | | | | | |
|--------------------------|------|-----|-----------|--------------------|-----------------------------|--------------------------|--------------------------|-------------------|--------------|
| Depth of Liquid (cm):>15 | | | | | Relative Humidity (%): 51.0 | | | | |
| Product: SMART PHONE | | | | | | | | | |
| Test Mode:802.11b | | | | | | | | | |
| Position | Mode | Ch. | Fr. (MHz) | Power Drift (<±5%) | SAR (1g) (W/kg) | Max. Tune-up Power (dBm) | Meas. output Power (dBm) | Scaled SAR (W/Kg) | Limit (W/kg) |
| Left Cheek | DTS | 6 | 2437 | -0.02 | 0.048 | 17.76 | 17.61 | 0.050 | 1.6 |
| Left Tilt | DTS | 6 | 2437 | 0.05 | 0.055 | 17.76 | 17.61 | 0.057 | 1.6 |
| Right Cheek | DTS | 6 | 2437 | -0.32 | 0.126 | 17.76 | 17.61 | 0.130 | 1.6 |
| Right Tilt | DTS | 6 | 2437 | -0.04 | 0.100 | 17.76 | 17.61 | 0.104 | 1.6 |
| Body back | DTS | 6 | 2437 | 0.27 | 0.034 | 17.76 | 17.61 | 0.035 | 1.6 |
| Body front | DTS | 6 | 2437 | -0.11 | 0.045 | 17.76 | 17.61 | 0.047 | 1.6 |
| Edge 1 (Top) | DTS | 6 | 2437 | -0.05 | 0.024 | 17.76 | 17.61 | 0.025 | 1.6 |
| Edge 4(Left) | DTS | 6 | 2437 | -0.09 | 0.038 | 17.76 | 17.61 | 0.039 | 1.6 |

Note:

- According to KDB248227, SAR is not required for 802.11n HT20/HT40 channels when the maximum average output power is less than 1/4 dB higher than that measured on the corresponding 802.11a/b channels.
- All of above "DTS" means data transmitters.
- The test separation for body back, body front and 4 Edges is 10mm of all above table.

| Repeated SAR | | | | | | | | | | |
|---|-------------|-----|-----------|--------------------|----------------------|--------------------|-----------------------|--------------------|-----------------------|------------|
| Product: SMART PHONE | | | | | | | | | | |
| Test Mode: PCS1900 with GMSK modulation | | | | | | | | | | |
| Position | Mode | Ch. | Fr. (MHz) | Power Drift (<±5%) | Once SAR (1g) (W/kg) | Power Drift (<±5%) | Twice SAR (1g) (W/kg) | Power Drift (<±5%) | Third SAR (1g) (W/kg) | Limit W/kg |
| Body back | GPRS-4 slot | 661 | 1880 | -0.19 | 0.811 | -- | -- | -- | -- | -- |

| The second repeated SAR judge reference | | | | | | | | |
|---|-----------|-------------|-----|-----------|--------------------------|-----------------------|-------|------------|
| Product: SMART PHONE | | | | | | | | |
| Test Mode: PCS1900 with GMSK modulation | | | | | | | | |
| Band | Position | Mode | Ch. | Fr. (MHz) | Original SAR (1g) (W/kg) | First SAR (1g) (W/kg) | Ratio | Limit W/kg |
| PCS1900 | Body back | GPRS-4 slot | 661 | 1880 | 0.822 | 0.811 | 1.014 | <1.2 |

Any report having not been signed by authorized approver, or having been altered without authorization, or having not been stamped by the "Dedicated Testing/Inspection Stamp" is deemed to be invalid. Copying or excerpting portion of, or altering the content of the report is not permitted without the written authorization of AGC. The test results presented in the report apply only to the tested sample. Any objections to report issued by AGC should be submitted to AGC within 15days after the issuance of the test report. Further enquiry of validity or verification of the test report should be addressed to AGC by agc@agc-cert.com.



Simultaneous Multi-band Transmission Evaluation:

Application Simultaneous Transmission information:

Sum of the SAR for GSM 850 & Wi-Fi & BT:

| NO | Simultaneous state | Portable Handset | | |
|----|---------------------------------|------------------|-----------|---------|
| | | Head | Body-worn | Hotspot |
| 1 | GSM(voice)+ WLAN 2.4GHz (data) | Yes | Yes | - |
| 2 | GSM(voice)+ Bluetooth(data) | Yes | Yes | - |
| 3 | GSM (Data) + WLAN 2.4GHz (data) | - | Yes | Yes |
| 4 | GSM (Data) + Bluetooth(data) | - | Yes | Yes |
| 5 | WCDMA+ WLAN 2.4GHz (data) | Yes | Yes | Yes |
| 6 | WCDMA+ Bluetooth(data) | Yes | Yes | Yes |
| 7 | LTE + WLAN 2.4GHz (data) | Yes | Yes | Yes |
| 8 | LTE + Bluetooth(data) | Yes | Yes | Yes |

NOTE:

1. WIFI and BT share the same antenna, and cannot transmit simultaneously.
2. Simultaneous with every transmitter must be the same test position.
3. KDB 447498 D01, BT SAR is excluded as below table.
4. KDB 447498 D01, for handsets the test separation distance is determined by the smallest distance between the outer surface of the device and the user; which is 0mm for head SAR and 10mm for body-worn SAR.
5. According to KDB 447498 D01 4.3.1, Standalone SAR test exclusion is as follow:
For 100 MHz to 6 GHz and test separation distances ≤ 50 mm, the 1-g and 10-g SAR test exclusion thresholds are determined by the following:

$$[(\text{max. power of channel, including tune-up tolerance, mW}) / (\text{min. test separation distance, mm})] \cdot [\sqrt{f(\text{GHz})}] \leq 3.0$$
for 1-g SAR, and ≤ 7.5 for 10-g extremity SAR³⁰, where
 - f(GHz) is the RF channel transmit frequency in GHz
 - Power and distance are rounded to the nearest mW and mm before calculation³¹
 - The result is rounded to one decimal place for comparison
 - The values 3.0 and 7.5 are referred to as numeric thresholds in step b) below
The test exclusions are applicable only when the minimum test separation distance is ≤ 50 mm, and for transmission frequencies between 100 MHz and 6 GHz. When the minimum test separation distance is < 5 mm, a distance of 5 mm according to 4.1 f) is applied to determine SAR test exclusion.
6. If the test separation distance is < 5 mm, 5mm is used for excluded SAR calculation.
7. According to KDB 447498 D01 4.3.2, simultaneous transmission SAR test exclusion is as follow:
 - (1) Simultaneous transmission SAR test exclusion is determined for each operating configuration and exposure condition according to the reported standalone SAR of each applicable simultaneous transmitting antenna.
 - (2) Any transmitters and antennas should be considered when calculating simultaneous mode.
 - (3) For mobile phone and PC, it's the sum of all transmitters and antennas at the same mode with same position in each applicable exposure condition
 - (4) When the standalone SAR test exclusion of section 4.3.2 is applied to an antenna that transmits simultaneously with other antennas, the standalone SAR must be estimated according to the following to det
$$[(\text{max. power of channel, including tune-up tolerance, mW}) / (\text{min. test separation distance, mm})] \cdot [\sqrt{f(\text{GHz})/x}] \text{ W/kg}$$
for test separation distances ≤ 50 mm; where $x = 7.5$ for 1-g SAR, and $x = 18.75$ for 10-g SAR.

Any report having not been signed by authorized approver, or having been altered without authorization, or having not been stamped by the "Dedicated Testing/Inspection Stamp" is deemed to be invalid. Copying or excerpting portion of, or altering the content of the report is not permitted without the written authorization of AGC. The test results presented in the report apply only to the tested sample. Any objections to report issued by AGC should be submitted to AGC within 15 days after the issuance of the test report. Further enquiry of validity or verification of the test report should be addressed to AGC by agc@agc-cert.com.



8. When the sum of SAR is larger than the limit, SAR test exclusion is determined by the SAR to peak location separation ratio. The simultaneous transmitting antennas in each operating mode and exposure condition combination must be considered one pair at a time to determine the SAR to peak location separation ratio to qualify for test exclusion. The ratio is determined by $(SAR1 + SAR2)1.5/R_i$, rounded to two decimal digits, and must be ≤ 0.04 for all antenna pairs in the configuration to qualify for 1-g SAR test exclusion.

| Estimated SAR | | Max Power including Tune-up Tolerance | | Separation Distance (mm) | Estimated SAR (W/kg) |
|---------------|------|---------------------------------------|-------|--------------------------|----------------------|
| | | dBm | mW | | |
| BT | Head | 9.20 | 8.318 | 0 | 0.344 |
| | Body | 9.20 | 8.318 | 10 | 0.172 |

Any report having not been signed by authorized approver, or having been altered without authorization, or having not been stamped by the "Dedicated Testing/Inspection Stamp" is deemed to be invalid. Copying or excerpting portion of, or altering the content of the report is not permitted without the written authorization of AGC. The test results presented in the report apply only to the tested sample. Any objections to report issued by AGC should be submitted to AGC within 15days after the issuance of the test report. Further enquiry of validity or verification of the test report should be addressed to AGC by agc@agc-cert.com.



Sum of the SAR for GSM 850 & Wi-Fi & BT:

| RF Exposure Conditions | Test Position | Simultaneous Transmission Scenario | | | Σ1-g SAR (W/Kg) | SPLSR (Yes/No) |
|------------------------|---------------|------------------------------------|----------------|-----------|-----------------|----------------|
| | | GSM 850 | Wi-Fi DTS Band | Bluetooth | | |
| Head (voice) | Left Touch | 0.075 | 0.050 | | 0.125 | No |
| | Left Tilt | 0.063 | 0.057 | | 0.120 | No |
| | Right Touch | 0.088 | 0.130 | | 0.218 | No |
| | Right Tilt | 0.077 | 0.104 | | 0.181 | No |
| | Left Touch | 0.075 | | 0.344 | 0.419 | No |
| | Left Tilt | 0.063 | | 0.344 | 0.407 | No |
| | Right Touch | 0.088 | | 0.344 | 0.432 | No |
| | Right Tilt | 0.077 | | 0.344 | 0.421 | No |
| Body-worn (voice) | Rear | 0.112 | 0.035 | | 0.147 | No |
| | | 0.112 | | 0.172 | 0.284 | No |
| | Front | 0.083 | 0.047 | | 0.130 | No |
| | | 0.083 | | 0.172 | 0.255 | No |
| Body-worn (Data) | Rear | 0.311 | | 0.172 | 0.483 | No |
| | | 0.311 | 0.035 | | 0.346 | No |
| | Front | 0.227 | | 0.172 | 0.399 | No |
| | | 0.227 | 0.047 | | 0.274 | No |
| Body-worn (Hotspot) | Edge 1 | -- | 0.025 | | 0.025 | No |
| | Edge 2 | 0.166 | -- | | 0.166 | No |
| | Edge 3 | 0.197 | -- | | 0.197 | No |
| | Edge 4 | -- | 0.039 | | 0.039 | No |
| | Edge 1 | -- | | 0.172 | 0.172 | No |
| | Edge 2 | 0.166 | | 0.172 | 0.338 | No |
| | Edge 3 | 0.197 | | 0.172 | 0.369 | No |
| | Edge 4 | -- | | 0.172 | 0.172 | No |

Note:

According to KDB 447498 D01 General RF Exposure Guidance, when the simultaneous transmission SAR is less than 1.6 W/Kg, SPLSR assessment is not required.

SPLSR mean is “The SAR to Peak Location Separation Ratio “

Any report having not been signed by authorized approver, or having been altered without authorization, or having not been stamped by the “Dedicated Testing/Inspection Stamp” is deemed to be invalid. Copying or excerpting portion of, or altering the content of the report is not permitted without the written authorization of AGC. The test results presented in the report apply only to the tested sample. Any objections to report issued by AGC should be submitted to AGC within 15 days after the issuance of the test report. Further enquiry of validity or verification of the test report should be addressed to AGC by agc@agc-cert.com.



Sum of the SAR for GSM 1900 & Wi-Fi & BT:

| RF Exposure Conditions | Test Position | Simultaneous Transmission Scenario | | | Σ1-g SAR (W/Kg) | SPLSR (Yes/No) |
|------------------------|---------------|------------------------------------|----------------|-----------|-----------------|----------------|
| | | PCS 1900 | Wi-Fi DTS Band | Bluetooth | | |
| Head (voice) | Left Touch | 0.078 | 0.050 | | 0.128 | No |
| | Left Tilt | 0.033 | 0.057 | | 0.090 | No |
| | Right Touch | 0.112 | 0.130 | | 0.242 | No |
| | Right Tilt | 0.048 | 0.104 | | 0.152 | No |
| | Left Touch | 0.078 | | 0.344 | 0.422 | No |
| | Left Tilt | 0.033 | | 0.344 | 0.377 | No |
| | Right Touch | 0.112 | | 0.344 | 0.456 | No |
| | Right Tilt | 0.048 | | 0.344 | 0.392 | No |
| Body-worn (voice) | Rear | 0.278 | 0.035 | | 0.313 | No |
| | | 0.278 | | 0.172 | 0.450 | No |
| | Front | 0.166 | 0.047 | | 0.213 | No |
| | | 0.166 | | 0.172 | 0.338 | No |
| Body-worn (Data) | Rear | 0.851 | | 0.172 | 1.023 | No |
| | | 0.851 | 0.035 | | 0.886 | No |
| | Front | 0.537 | | 0.172 | 0.709 | No |
| | | 0.537 | 0.047 | | 0.584 | No |
| Body-worn (Hotspot) | Edge 1 | -- | 0.025 | | 0.025 | No |
| | Edge 2 | 0.297 | -- | | 0.297 | No |
| | Edge 3 | 0.462 | -- | | 0.462 | No |
| | Edge 4 | -- | 0.039 | | 0.039 | No |
| | Edge 1 | -- | | 0.172 | 0.172 | No |
| | Edge 2 | 0.297 | | 0.172 | 0.469 | No |
| | Edge 3 | 0.462 | | 0.172 | 0.634 | No |
| | Edge 4 | -- | | 0.172 | 0.172 | No |

Note:

According to KDB 447498 D01 General RF Exposure Guidance, when the simultaneous transmission SAR is less than 1.6 W/Kg, SPLSR assessment is not required.
SPLSR mean is "The SAR to Peak Location Separation Ratio"

Any report having not been signed by authorized approver, or having been altered without authorization, or having not been stamped by the "Dedicated Testing/Inspection Stamp" is deemed to be invalid. Copying or excerpting portion of, or altering the content of the report is not permitted without the written authorization of AGC. The test results presented in the report apply only to the tested sample. Any objections to report issued by AGC should be submitted to AGC within 15 days after the issuance of the test report. Further enquiry of validity or verification of the test report should be addressed to AGC by agc@agc-cert.com.



Sum of the SAR for WCDMA Band II & Wi-Fi & BT:

| RF Exposure Conditions | Test Position | Simultaneous Transmission Scenario | | | Σ1-g SAR (W/Kg) | SPLSR (Yes/No) |
|------------------------|---------------|------------------------------------|----------------|-----------|-----------------|----------------|
| | | WCDMA Band II | Wi-Fi DTS Band | Bluetooth | | |
| Head | Left Touch | 0.137 | 0.050 | | 0.187 | No |
| | Left Tilt | 0.051 | 0.057 | | 0.108 | No |
| | Right Touch | 0.172 | 0.130 | | 0.302 | No |
| | Right Tilt | 0.062 | 0.104 | | 0.166 | No |
| | Left Touch | 0.137 | | 0.344 | 0.481 | No |
| | Left Tilt | 0.051 | | 0.344 | 0.395 | No |
| | Right Touch | 0.172 | | 0.344 | 0.516 | No |
| | Right Tilt | 0.062 | | 0.344 | 0.406 | No |
| Body-worn | Rear | 0.533 | 0.035 | | 0.568 | No |
| | Front | 0.263 | 0.047 | | 0.310 | No |
| | Edge 1 | -- | 0.025 | | 0.025 | No |
| | Edge 2 | 0.163 | -- | | 0.163 | No |
| | Edge 3 | 0.274 | -- | | 0.274 | No |
| | Edge 4 | -- | 0.039 | | 0.039 | No |
| | Rear | 0.533 | | 0.172 | 0.705 | No |
| | Front | 0.263 | | 0.172 | 0.435 | No |
| | Edge 1 | -- | | 0.172 | 0.172 | No |
| | Edge 2 | 0.163 | | 0.172 | 0.335 | No |
| | Edge 3 | 0.274 | | 0.172 | 0.446 | No |
| | Edge 4 | -- | | 0.172 | 0.172 | No |

Note:

According to KDB 447498 D01 General RF Exposure Guidance, when the simultaneous transmission SAR is less than 1.6 W/Kg, SPLSR assessment is not required.
SPLSR mean is "The SAR to Peak Location Separation Ratio "

Any report having not been signed by authorized approver, or having been altered without authorization, or having not been stamped by the "Dedicated Testing/Inspection Stamp" is deemed to be invalid. Copying or excerpting portion of, or altering the content of the report is not permitted without the written authorization of AGC. The test results presented in the report apply only to the tested sample. Any objections to report issued by AGC should be submitted to AGC within 15 days after the issuance of the test report. Further enquiry of validity or verification of the test report should be addressed to AGC by agc@agc-cert.com.

Attestation of Global Compliance(Shenzhen)Co., Ltd
Attestation of Global Compliance(Shenzhen)Std & Tech Co., Ltd
Tel: +86-755 2523 4088 E-mail: agc@agc-cert.com Web: http://cn.agc-cert.com/



Sum of the SAR for WCDMA Band V & Wi-Fi & BT:

| RF Exposure Conditions | Test Position | Simultaneous Transmission Scenario | | | Σ1-g SAR (W/Kg) | SPLSR (Yes/No) |
|------------------------|---------------|------------------------------------|----------------|-----------|-----------------|----------------|
| | | WCDMA Band V | Wi-Fi DTS Band | Bluetooth | | |
| Head | Left Touch | 0.072 | 0.050 | | 0.122 | No |
| | Left Tilt | 0.078 | 0.057 | | 0.135 | No |
| | Right Touch | 0.078 | 0.130 | | 0.208 | No |
| | Right Tilt | 0.078 | 0.104 | | 0.182 | No |
| | Left Touch | 0.072 | | 0.344 | 0.416 | No |
| | Left Tilt | 0.078 | | 0.344 | 0.422 | No |
| | Right Touch | 0.078 | | 0.344 | 0.422 | No |
| | Right Tilt | 0.078 | | 0.344 | 0.422 | No |
| Body-worn | Rear | 0.110 | 0.035 | | 0.145 | No |
| | Front | 0.079 | 0.047 | | 0.126 | No |
| | Edge 1 | -- | 0.025 | | 0.025 | No |
| | Edge 2 | 0.047 | -- | | 0.047 | No |
| | Edge 3 | 0.065 | -- | | 0.065 | No |
| | Edge 4 | -- | 0.039 | | 0.039 | No |
| | Rear | 0.110 | | 0.172 | 0.282 | No |
| | Front | 0.079 | | 0.172 | 0.251 | No |
| | Edge 1 | -- | | 0.172 | 0.172 | No |
| | Edge 2 | 0.047 | | 0.172 | 0.219 | No |
| | Edge 3 | 0.065 | | 0.172 | 0.237 | No |
| | Edge 4 | -- | | 0.172 | 0.172 | No |

Note:

According to KDB 447498 D01 General RF Exposure Guidance, when the simultaneous transmission SAR is less than 1.6 W/Kg, SPLSR assessment is not required.
SPLSR mean is "The SAR to Peak Location Separation Ratio "

Any report having not been signed by authorized approver, or having been altered without authorization, or having not been stamped by the "Dedicated Testing/Inspection Stamp" is deemed to be invalid. Copying or excerpting portion of, or altering the content of the report is not permitted without the written authorization of AGC. The test results presented in the report apply only to the tested sample. Any objections to report issued by AGC should be submitted to AGC within 15 days after the issuance of the test report. Further enquiry of validity or verification of the test report should be addressed to AGC by agc@agc-cert.com.

Attestation of Global Compliance(Shenzhen)Co., Ltd
Attestation of Global Compliance(Shenzhen)Std & Tech Co., Ltd
Tel: +86-755 2523 4088 E-mail: agc@agc-cert.com Web: http://cn.agc-cert.com/



Sum of the SAR for LTE Band 2 & Wi-Fi & BT:

| RF Exposure Conditions | Test Position | Simultaneous Transmission Scenario | | | Σ1-g SAR (W/Kg) | SPLSR (Yes/No) | |
|------------------------|---------------|------------------------------------|----------------|-----------|-----------------|----------------|----|
| | | LTE Band 2 | Wi-Fi DTS Band | Bluetooth | | | |
| 1RB | | | | | | | |
| Head | Left Touch | 0.156 | 0.050 | | 0.206 | No | |
| | Left Tilt | 0.049 | 0.057 | | 0.106 | No | |
| | Right Touch | 0.176 | 0.130 | | 0.306 | No | |
| | Right Tilt | 0.063 | 0.104 | | 0.167 | No | |
| | Left Touch | 0.156 | | 0.344 | 0.500 | No | |
| | Left Tilt | 0.049 | | 0.344 | 0.393 | No | |
| | Right Touch | 0.176 | | 0.344 | 0.520 | No | |
| | Right Tilt | 0.063 | | 0.344 | 0.407 | No | |
| Body-worn | Rear | 0.482 | 0.035 | | 0.517 | No | |
| | Front | 0.268 | 0.047 | | 0.315 | No | |
| | Edge 1 | -- | 0.025 | | 0.025 | No | |
| | Edge 2 | 0.172 | -- | | 0.172 | No | |
| | Edge 3 | 0.286 | -- | | 0.286 | No | |
| | Edge 4 | -- | 0.039 | | 0.039 | No | |
| | Rear | 0.482 | | 0.172 | 0.654 | No | |
| | Front | 0.268 | | 0.172 | 0.440 | No | |
| | Edge 1 | -- | | 0.172 | 0.172 | No | |
| | Edge 2 | 0.172 | | 0.172 | 0.344 | No | |
| | Edge 3 | 0.286 | | 0.172 | 0.458 | No | |
| | Edge 4 | -- | | 0.172 | 0.172 | No | |
| | 50%RB | | | | | | |
| | Head | Left Touch | 0.125 | 0.050 | | 0.175 | No |
| Left Tilt | | 0.038 | 0.057 | | 0.095 | No | |
| Right Touch | | 0.152 | 0.130 | | 0.282 | No | |
| Right Tilt | | 0.050 | 0.104 | | 0.154 | No | |
| Left Touch | | 0.125 | | 0.344 | 0.469 | No | |
| Left Tilt | | 0.038 | | 0.344 | 0.382 | No | |
| Right Touch | | 0.152 | | 0.344 | 0.496 | No | |
| Right Tilt | | 0.050 | | 0.344 | 0.394 | No | |
| Body-worn | Rear | 0.181 | 0.035 | | 0.216 | No | |
| | Front | 0.090 | 0.047 | | 0.137 | No | |
| | Edge 1 | -- | 0.025 | | 0.025 | No | |
| | Edge 2 | 0.070 | -- | | 0.070 | No | |
| | Edge 3 | 0.098 | -- | | 0.098 | No | |
| | Edge 4 | -- | 0.039 | | 0.039 | No | |
| | Rear | 0.181 | | 0.172 | 0.353 | No | |
| | Front | 0.090 | | 0.172 | 0.262 | No | |
| | Edge 1 | -- | | 0.172 | 0.172 | No | |
| | Edge 2 | 0.070 | | 0.172 | 0.242 | No | |
| | Edge 3 | 0.098 | | 0.172 | 0.270 | No | |
| | Edge 4 | -- | | 0.172 | 0.172 | No | |

Note:

According to KDB 447498 D01 General RF Exposure Guidance, when the simultaneous transmission SAR is less than 1.6 W/Kg, SPLSR assessment is not required.
SPLSR mean is "The SAR to Peak Location Separation Ratio "

Any report having not been signed by authorized approver, or having been altered without authorization, or having not been stamped by the "Dedicated Testing/Inspection Stamp" is deemed to be invalid. Copying or excerpting portion of, or altering the content of the report is not permitted without the written authorization of AGC. The test results presented in the report apply only to the tested sample. Any objections to report issued by AGC should be submitted to AGC within 15 days after the issuance of the test report. Further enquiry of validity or verification of the test report should be addressed to AGC by agc@agc-cert.com.



Sum of the SAR for LTE Band 4 & Wi-Fi & BT:

| RF Exposure Conditions | Test Position | Simultaneous Transmission Scenario | | | Σ1-g SAR (W/Kg) | SPLSR (Yes/No) | |
|------------------------|---------------|------------------------------------|----------------|-----------|-----------------|----------------|----|
| | | LTE Band 4 | Wi-Fi DTS Band | Bluetooth | | | |
| 1RB | | | | | | | |
| Head | Left Touch | 0.096 | 0.050 | | 0.146 | No | |
| | Left Tilt | 0.036 | 0.057 | | 0.093 | No | |
| | Right Touch | 0.150 | 0.130 | | 0.280 | No | |
| | Right Tilt | 0.062 | 0.104 | | 0.166 | No | |
| | Left Touch | 0.096 | | 0.344 | 0.440 | No | |
| | Left Tilt | 0.036 | | 0.344 | 0.380 | No | |
| | Right Touch | 0.150 | | 0.344 | 0.494 | No | |
| | Right Tilt | 0.062 | | 0.344 | 0.406 | No | |
| Body-worn | Rear | 0.364 | 0.035 | | 0.399 | No | |
| | Front | 0.261 | 0.047 | | 0.308 | No | |
| | Edge 1 | -- | 0.025 | | 0.025 | No | |
| | Edge 2 | 0.126 | -- | | 0.126 | No | |
| | Edge 3 | 0.196 | -- | | 0.196 | No | |
| | Edge 4 | -- | 0.039 | | 0.039 | No | |
| | Rear | 0.364 | | 0.172 | 0.536 | No | |
| | Front | 0.261 | | 0.172 | 0.433 | No | |
| | Edge 1 | -- | | 0.172 | 0.172 | No | |
| | Edge 2 | 0.126 | | 0.172 | 0.298 | No | |
| | Edge 3 | 0.196 | | 0.172 | 0.368 | No | |
| | Edge 4 | -- | | 0.172 | 0.172 | No | |
| | 50%RB | | | | | | |
| | Head | Left Touch | 0.111 | 0.050 | | 0.161 | No |
| Left Tilt | | 0.041 | 0.057 | | 0.098 | No | |
| Right Touch | | 0.109 | 0.130 | | 0.239 | No | |
| Right Tilt | | 0.058 | 0.104 | | 0.162 | No | |
| Left Touch | | 0.111 | | 0.344 | 0.455 | No | |
| Left Tilt | | 0.041 | | 0.344 | 0.385 | No | |
| Right Touch | | 0.109 | | 0.344 | 0.453 | No | |
| Right Tilt | | 0.058 | | 0.344 | 0.402 | No | |
| Body-worn | Rear | 0.278 | 0.035 | | 0.313 | No | |
| | Front | 0.217 | 0.047 | | 0.264 | No | |
| | Edge 1 | -- | 0.025 | | 0.025 | No | |
| | Edge 2 | 0.083 | -- | | 0.083 | No | |
| | Edge 3 | 0.229 | -- | | 0.229 | No | |
| | Edge 4 | -- | 0.039 | | 0.039 | No | |
| | Rear | 0.278 | | 0.172 | 0.450 | No | |
| | Front | 0.217 | | 0.172 | 0.389 | No | |
| | Edge 1 | -- | | 0.172 | 0.172 | No | |
| | Edge 2 | 0.083 | | 0.172 | 0.255 | No | |
| | Edge 3 | 0.229 | | 0.172 | 0.401 | No | |
| | Edge 4 | -- | | 0.172 | 0.172 | No | |

Note:

According to KDB 447498 D01 General RF Exposure Guidance, when the simultaneous transmission SAR is less than 1.6 W/Kg, SPLSR assessment is not required.
SPLSR mean is "The SAR to Peak Location Separation Ratio "

Any report having not been signed by authorized approver, or having been altered without authorization, or having not been stamped by the "Dedicated Testing/Inspection Stamp" is deemed to be invalid. Copying or excerpting portion of, or altering the content of the report is not permitted without the written authorization of AGC. The test results presented in the report apply only to the tested sample. Any objections to report issued by AGC should be submitted to AGC within 15 days after the issuance of the test report. Further enquiry of validity or verification of the test report should be addressed to AGC by agc@agc-cert.com.



Sum of the SAR for LTE Band 7 & Wi-Fi & BT:

| RF Exposure Conditions | Test Position | Simultaneous Transmission Scenario | | | Σ1-g SAR (W/Kg) | SPLSR (Yes/No) | |
|------------------------|---------------|------------------------------------|----------------|-----------|-----------------|----------------|----|
| | | LTE Band 7 | Wi-Fi DTS Band | Bluetooth | | | |
| 1RB | | | | | | | |
| Head | Left Touch | 0.103 | 0.050 | | 0.153 | No | |
| | Left Tilt | 0.046 | 0.057 | | 0.103 | No | |
| | Right Touch | 0.159 | 0.130 | | 0.289 | No | |
| | Right Tilt | 0.037 | 0.104 | | 0.141 | No | |
| | Left Touch | 0.103 | | 0.344 | 0.447 | No | |
| | Left Tilt | 0.046 | | 0.344 | 0.390 | No | |
| | Right Touch | 0.159 | | 0.344 | 0.503 | No | |
| | Right Tilt | 0.037 | | 0.344 | 0.381 | No | |
| Body-worn | Rear | 0.222 | 0.035 | | 0.257 | No | |
| | Front | 0.130 | 0.047 | | 0.177 | No | |
| | Edge 1 | -- | 0.025 | | 0.025 | No | |
| | Edge 2 | 0.077 | -- | | 0.077 | No | |
| | Edge 3 | 0.118 | -- | | 0.118 | No | |
| | Edge 4 | -- | 0.039 | | 0.039 | No | |
| | Rear | 0.222 | | 0.172 | 0.394 | No | |
| | Front | 0.130 | | 0.172 | 0.302 | No | |
| | Edge 1 | -- | | 0.172 | 0.172 | No | |
| | Edge 2 | 0.077 | | 0.172 | 0.249 | No | |
| | Edge 3 | 0.118 | | 0.172 | 0.290 | No | |
| | Edge 4 | -- | | 0.172 | 0.172 | No | |
| | 50%RB | | | | | | |
| | Head | Left Touch | 0.032 | 0.050 | | 0.082 | No |
| Left Tilt | | 0.021 | 0.057 | | 0.078 | No | |
| Right Touch | | 0.040 | 0.130 | | 0.170 | No | |
| Right Tilt | | 0.012 | 0.104 | | 0.116 | No | |
| Left Touch | | 0.032 | | 0.344 | 0.376 | No | |
| Left Tilt | | 0.021 | | 0.344 | 0.365 | No | |
| Right Touch | | 0.040 | | 0.344 | 0.384 | No | |
| Right Tilt | | 0.012 | | 0.344 | 0.356 | No | |
| Body-worn | Rear | 0.202 | 0.035 | | 0.237 | No | |
| | Front | 0.125 | 0.047 | | 0.172 | No | |
| | Edge 1 | -- | 0.025 | | 0.025 | No | |
| | Edge 2 | 0.085 | -- | | 0.085 | No | |
| | Edge 3 | 0.116 | -- | | 0.116 | No | |
| | Edge 4 | -- | 0.039 | | 0.039 | No | |
| | Rear | 0.202 | | 0.172 | 0.374 | No | |
| | Front | 0.125 | | 0.172 | 0.297 | No | |
| | Edge 1 | -- | | 0.172 | 0.172 | No | |
| | Edge 2 | 0.085 | | 0.172 | 0.257 | No | |
| | Edge 3 | 0.116 | | 0.172 | 0.288 | No | |
| | Edge 4 | -- | | 0.172 | 0.172 | No | |

Note:

According to KDB 447498 D01 General RF Exposure Guidance, when the simultaneous transmission SAR is less than 1.6 W/Kg, SPLSR assessment is not required.
SPLSR mean is "The SAR to Peak Location Separation Ratio "

Any report having not been signed by authorized approver, or having been altered without authorization, or having not been stamped by the "Dedicated Testing/Inspection Stamp" is deemed to be invalid. Copying or excerpting portion of, or altering the content of the report is not permitted without the written authorization of AGC. The test results presented in the report apply only to the tested sample. Any objections to report issued by AGC should be submitted to AGC within 15 days after the issuance of the test report. Further enquiry of validity or verification of the test report should be addressed to AGC by agc@agc-cert.com.



APPENDIX A. SAR SYSTEM CHECK DATA

Test Laboratory: AGC Lab

Date: Sep. 25,2020

System Check Head 835 MHz

DUT: Dipole 835 MHz Type: SID 835

Communication System CW; Communication System Band: D835 (835.0 MHz); Duty Cycle: 1:1; Conv.F=5.26

Frequency: 835 MHz; Medium parameters used: $f = 835$ MHz; $\sigma = 0.89$ mho/m; $\epsilon_r = 40.36$; $\rho = 1000$ kg/m³ ;

Phantom section: Flat Section; Input Power=18dBm

Ambient temperature (°C):20.5, Liquid temperature (°C): 20.2

SATIMO Configuration:

- Probe: SSE5; Calibrated: Jun. 24,2020; Serial No.: SN 24/20 EP336
- Sensor-Surface: 4mm (Mechanical Surface Detection)
- Phantom: SAM twin phantom
- Measurement SW: OpenSAR V4_02_35

Configuration/System Check 835MHz Head/Area Scan: Measurement grid: dx=8mm, dy=8mm

Configuration/System Check 835MHz Head/Zoom Scan: Measurement grid: dx=8mm,dy=8mm, dz=5mm

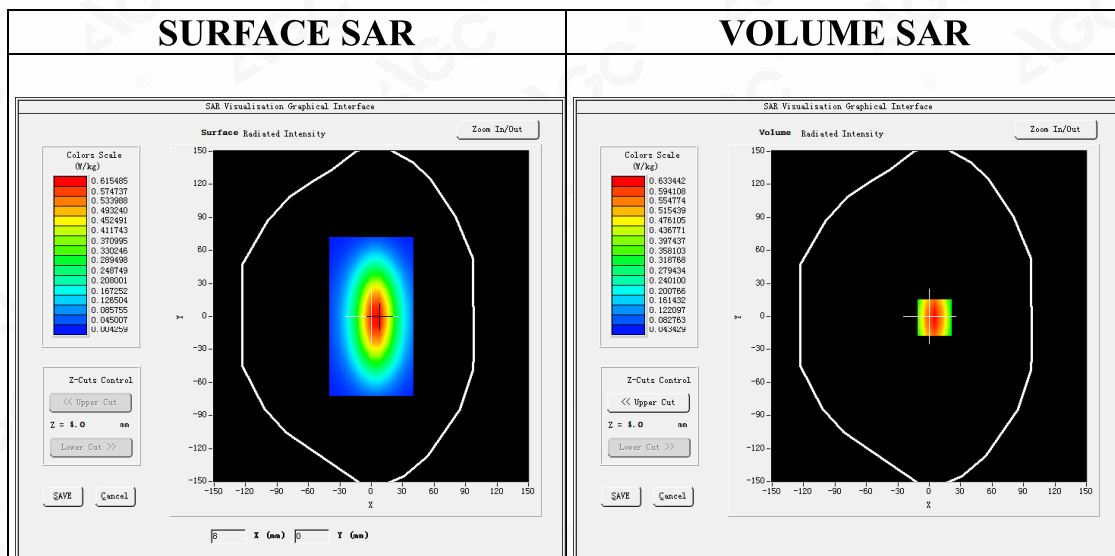

Maximum location: X=5.00, Y=-1.00

SAR Peak: 0.90 W/kg

| | |
|----------------|----------|
| SAR 10g (W/Kg) | 0.388452 |
| SAR 1g (W/Kg) | 0.609361 |

Any report having not been signed by authorized approver, or having been altered without authorization, or having not been stamped by the "Dedicated Testing/Inspection Stamp" is deemed to be invalid. Copying or excerpting portion of, or altering the content of the report is not permitted without the written authorization of AGC. The test results presented in the report apply only to the tested sample. Any objections to report issued by AGC should be submitted to AGC within 15days after the issuance of the test report. Further enquiry of validity or verification of the test report should be addressed to AGC by agc@agc-cert.com.

Attestation of Global Compliance(Shenzhen)Co., Ltd

Attestation of Global Compliance(Shenzhen)Std & Tech Co., Ltd

Tel: +86-755 2523 4088 E-mail: agc@agc-cert.com Web: http://cn.agc-cert.com/



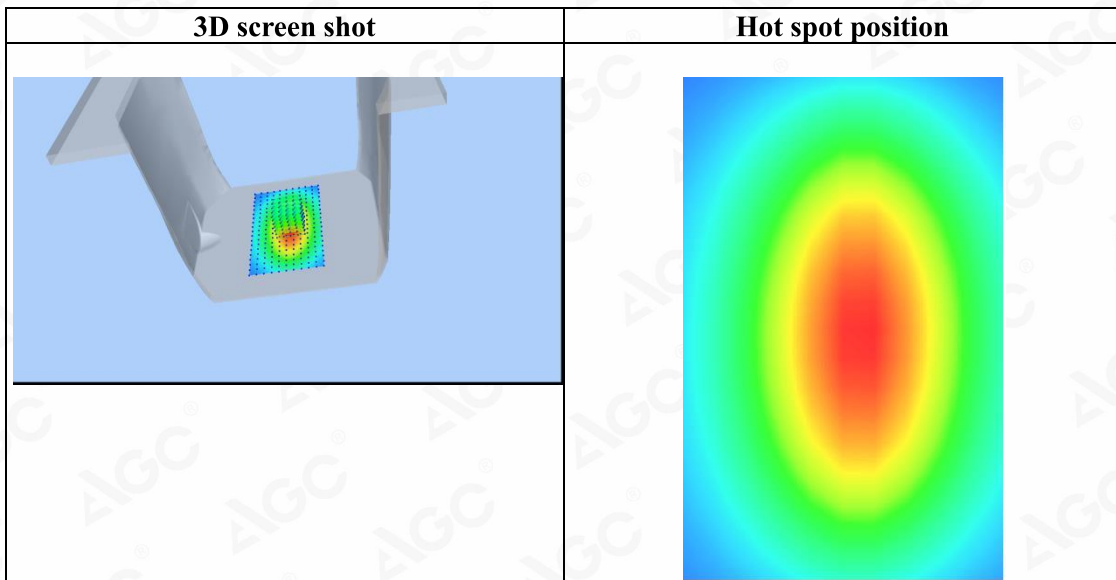
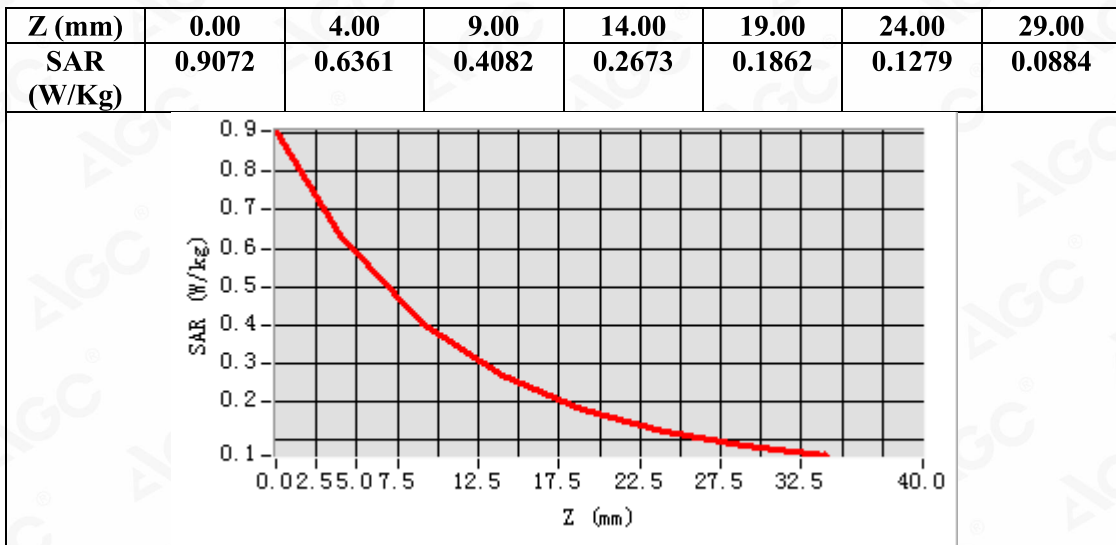

Any report having not been signed by authorized approver, or having been altered without authorization, or having not been stamped by the "Dedicated Testing/Inspection Stamp" is deemed to be invalid. Copying or excerpting portion of, or altering the content of the report is not permitted without the written authorization of AGC. The test results presented in the report apply only to the tested sample. Any objections to report issued by AGC should be submitted to AGC within 15days after the issuance of the test report. Further enquiry of validity or verification of the test report should be addressed to AGC by agc@agc-cert.com.



Test Laboratory: AGC Lab
System Check Head 1750MHz
DUT: Dipole 1800 MHz; Type: SID 1800

Date: Sep. 26,2020

Communication System: CW; Communication System Band: D1700 (1750.0 MHz); Duty Cycle:1:1; Conv.F=4.48
Frequency: 1750 MHz; Medium parameters used: $f = 1800\text{MHz}$; $\sigma = 1.39 \text{ mho/m}$; $\epsilon_r = 40.60$; $\rho = 1000 \text{ kg/m}^3$;
Phantom section: Flat Section; Input Power=18dBm
Ambient temperature ($^{\circ}\text{C}$): 20.1, Liquid temperature ($^{\circ}\text{C}$): 19.9

SATIMO Configuration:

- Probe: SSE5; Calibrated: Jun. 24,2020; Serial No.: SN 24/20 EP336
- Sensor-Surface: 4mm (Mechanical Surface Detection)
- Phantom: SAM twin phantom
- Measurement SW: OpenSAR V4_02_35

Configuration/System Check 1750MHz Head/Area Scan: Measurement grid: dx=8mm,dy=8mm

Configuration/System Check 1750MHz Head/Zoom Scan: Measurement grid: dx=8mm,dy=8mm, dz=5mm

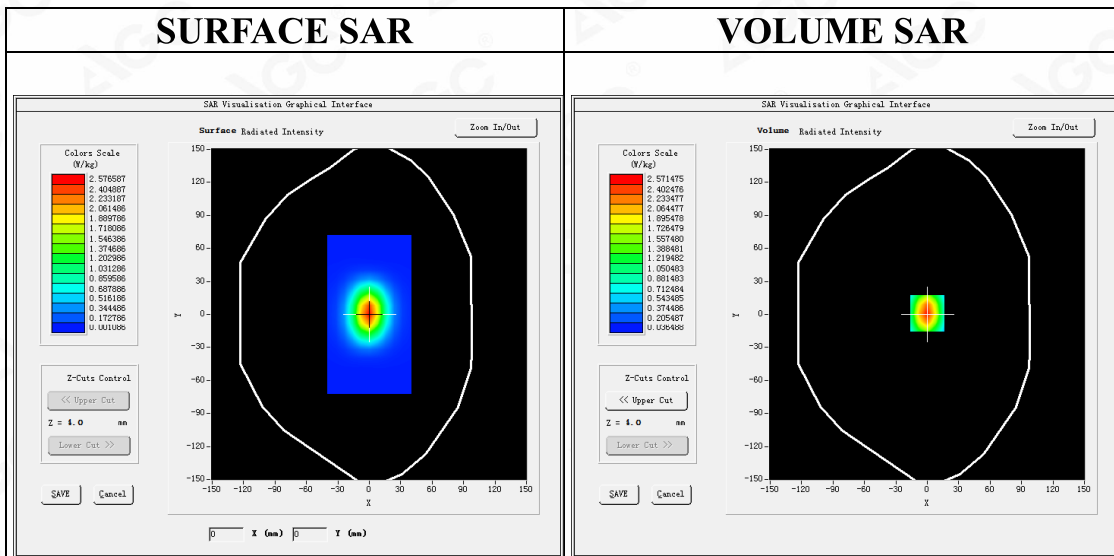

Maximum location: X=0.00, Y=1.00
SAR Peak: 4.12 W/kg

| | |
|-----------------------|----------|
| SAR 10g (W/Kg) | 1.225895 |
| SAR 1g (W/Kg) | 2.412684 |

Any report having not been signed by authorized approver, or having been altered without authorization, or having not been stamped by the "Dedicated Testing/Inspection Stamp" is deemed to be invalid. Copying or excerpting portion of, or altering the content of the report is not permitted without the written authorization of AGC. The test results presented in the report apply only to the tested sample. Any objections to report issued by AGC should be submitted to AGC within 15days after the issuance of the test report. Further enquiry of validity or verification of the test report should be addressed to AGC by agc@agc-cert.com.



| Z (mm) | 0.00 | 4.00 | 9.00 | 14.00 | 19.00 | 24.00 | 29.00 |
|------------|--------|--------|--------|--------|--------|--------|--------|
| SAR (W/Kg) | 4.1524 | 2.5708 | 1.3667 | 0.7525 | 0.4236 | 0.2405 | 0.1371 |

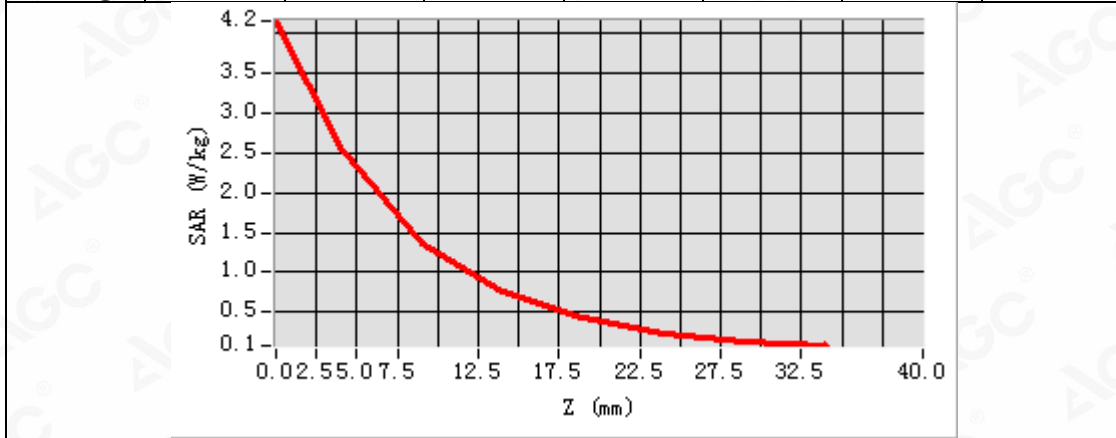

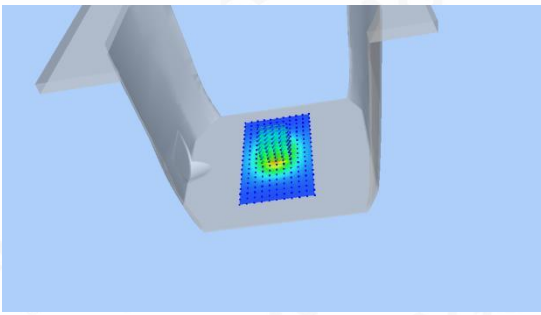
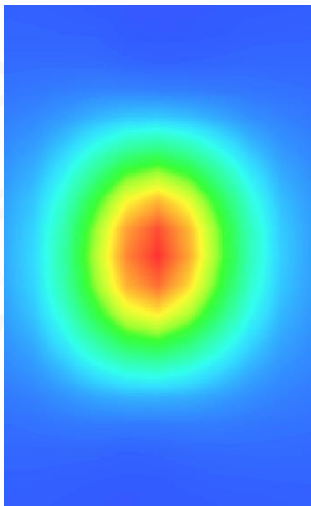
| 3D screen shot | Hot spot position |
|--|---|
|  |  |

Any report having not been signed by authorized approver, or having been altered without authorization, or having not been stamped by the "Dedicated Testing/Inspection Stamp" is deemed to be invalid. Copying or excerpting portion of, or altering the content of the report is not permitted without the written authorization of AGC. The test results presented in the report apply only to the tested sample. Any objections to report issued by AGC should be submitted to AGC within 15days after the issuance of the test report. Further enquiry of validity or verification of the test report should be addressed to AGC by agc@agc-cert.com.



Test Laboratory: AGC Lab
System Check Head 1900MHz
DUT: Dipole 1900 MHz; Type: SID 1900

Date: Sep. 24,2020

Communication System: CW; Communication System Band: D1900 (1900.0 MHz); Duty Cycle:1:1; Conv.F=4.72
Frequency: 1900 MHz; Medium parameters used: $f = 1900$ MHz; $\sigma = 1.38$ mho/m; $\epsilon_r = 40.51$; $\rho = 1000$ kg/m³ ;
Phantom section: Flat Section; Input Power=18dBm
Ambient temperature (°C):20.3, Liquid temperature (°C): 20.1

SATIMO Configuration:

- Probe: SSE5; Calibrated: Jun. 24,2020; Serial No.: SN 24/20 EP336
- Sensor-Surface: 4mm (Mechanical Surface Detection)
- Phantom: SAM twin phantom
- Measurement SW: OpenSAR V4_02_35

Configuration/System Check 1900MHz Head/Area Scan: Measurement grid: dx=8mm, dy=8mm

Configuration/System Check 1900MHz Head/Zoom Scan: Measurement grid: dx=8mm,dy=8mm, dz=5mm

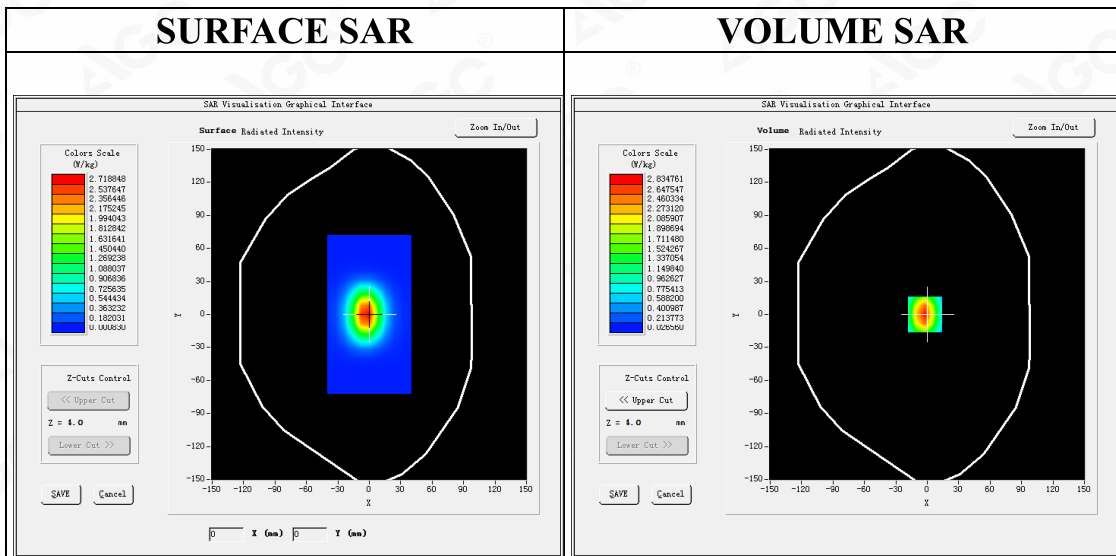

Maximum location: X=-2.00, Y=0.00
SAR Peak: 4.70 W/kg

| | |
|-----------------------|----------|
| SAR 10g (W/Kg) | 1.275282 |
| SAR 1g (W/Kg) | 2.652741 |

Any report having not been signed by authorized approver, or having been altered without authorization, or having not been stamped by the "Dedicated Testing/Inspection Stamp" is deemed to be invalid. Copying or excerpting portion of, or altering the content of the report is not permitted without the written authorization of AGC. The test results presented in the report apply only to the tested sample. Any objections to report issued by AGC should be submitted to AGC within 15days after the issuance of the test report. Further enquiry of validity or verification of the test report should be addressed to AGC by agc@agc-cert.com.



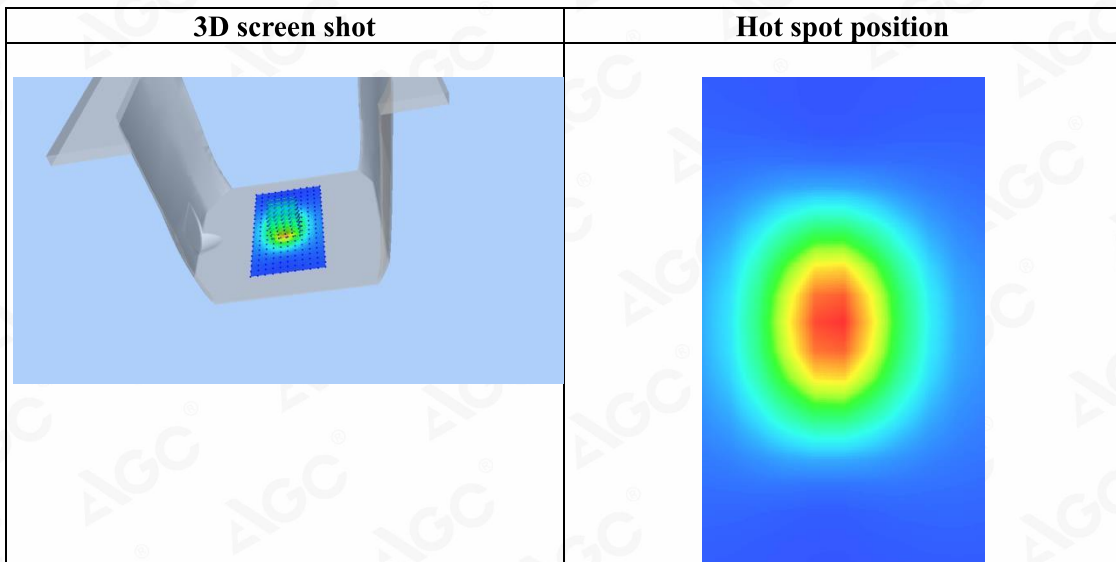
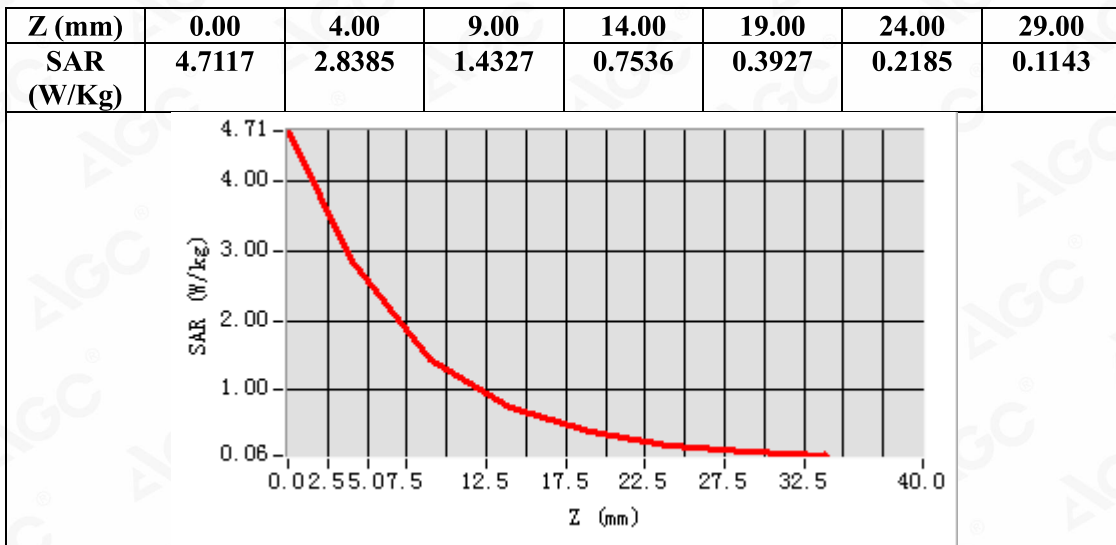

Any report having not been signed by authorized approver, or having been altered without authorization, or having not been stamped by the "Dedicated Testing/Inspection Stamp" is deemed to be invalid. Copying or excerpting portion of, or altering the content of the report is not permitted without the written authorization of AGC. The test results presented in the report apply only to the tested sample. Any objections to report issued by AGC should be submitted to AGC within 15days after the issuance of the test report. Further enquiry of validity or verification of the test report should be addressed to AGC by agc@agc-cert.com.

