



中认信通
CHINA CERTIFICATION ICT CO., LTD (DONGGUAN)



TEST REPORT

Applicant: HONG KONG IPRO TECHNOLOGY CO.,LIMITED

Address: 12/F., San Toi Building 137-139 Connaught Road Central HK

FCC ID: PQ4IPROF188

Product Name: Mobile Phone

**Standard(s): 47 CFR Part 15 Subpart B
ANSI C63.4-2014**

The above equipment has been tested and found compliant with the requirement of the relative standards by China Certification ICT Co., Ltd (Dongguan)

Report Number: CR230744255-00C

Date Of Issue: 2023/8/23

Reviewed By: Julie Tan
Title: RF Engineer

Julie Tan

Approved By: Sun Zhong
Title: Manager

Sun Zhong

Test Laboratory: China Certification ICT Co., Ltd (Dongguan)

No. 113, Pingkang Road, Dalang Town, Dongguan,
Guangdong, China
Tel: +86-769-82016888

Test Facility

The Test site used by China Certification ICT Co., Ltd (Dongguan) to collect test data is located on the No. 113, Pingkang Road, Dalang Town, Dongguan, Guangdong, China.

The lab has been recognized as the FCC accredited lab under the KDB 974614 D01 and is listed in the FCC Public Access Link (PAL) database, FCC Registration No. : 442868, the FCC Designation No. : CN1314.

The lab has been recognized by Innovation, Science and Economic Development Canada to test to Canadian radio equipment requirements, the CAB identifier: CN0123.

Declarations

China Certification ICT Co., Ltd (Dongguan) is not responsible for the authenticity of any test data provided by the applicant. Data included from the applicant that may affect test results are marked with a triangle symbol “▲”. Customer model name, addresses, names, trademarks etc. are not considered data.

Unless otherwise stated the results shown in this test report refer only to the sample(s) tested.

This report cannot be reproduced except in full, without prior written approval of the Company.

This report is valid only with a valid digital signature. The digital signature may be available only under the Adobe software above version 7.0.

This report may contain data that are not covered by the accreditation scope and shall be marked with an asterisk “★”.

CONTENTS

TEST FACILITY	2
DECLARATIONS.....	2
DOCUMENT REVISION HISTORY	4
1. GENERAL INFORMATION.....	5
1.1 PRODUCT DESCRIPTION FOR EQUIPMENT UNDER TEST (EUT)	5
1.2 DESCRIPTION OF TEST CONFIGURATION	6
1.2.2 Support Equipment List and Details	6
1.2.3 Support Cable List and Details	6
1.2.4 Block Diagram of Test Setup.....	7
1.3 MEASUREMENT UNCERTAINTY	8
2. SUMMARY OF TEST RESULTS	9
3. REQUIREMENTS AND TEST PROCEDURES	10
3.1 AC LINE CONDUCTED EMISSIONS	10
3.1.1 EUT Setup.....	10
3.1.2 EMI Test Receiver Setup	10
3.1.3 Test Procedure	11
3.1.4 Corrected Amplitude & Margin Calculation.....	11
3.2 RADIATION SPURIOUS EMISSIONS	12
3.2.1 EUT Setup.....	12
3.2.2 EMI Test Receiver Setup	13
3.2.3 Test Procedure	13
3.2.4 Corrected Amplitude & Margin Calculation.....	13
4. TEST DATA AND RESULTS.....	14
4.1 AC LINE CONDUCTED EMISSIONS	14
4.2 RADIATION SPURIOUS EMISSIONS	17

DOCUMENT REVISION HISTORY

Revision Number	Report Number	Description of Revision	Date of Revision
1.0	CR230744255-00C	Original Report	2023/8/23

1. GENERAL INFORMATION

1.1 Product Description for Equipment under Test (EUT)

EUT Name:	Mobile Phone
EUT Model:	F188
Multiple Model:	F181, F182, F185, F186, F187, F189
Highest Operation Frequency:	2480 MHz
Rated Input Voltage:	DC 3.7V from battery or DC 5V from Adapter
Serial Number:	2958-3
EUT Received Date:	2023/8/1
EUT Received Status:	Good
Note: The Multiple model is electrically identical with test model, please refer to the declaration letter for more detail, which was provided by manufacturer.	

Accessory Information:

Accessory Description	Manufacturer	Model
Adapter	HONG KONG IPRO TECHNOLOGY CO.,LIMITED	NTR-02

1.2 Description of Test Configuration

1.2.1 EUT Operation Condition:

EUT Operation Mode:	The system was configured for testing in Typical Use Mode, which was provided by the manufacturer. Test Mode : downloading
Equipment Modifications:	No
EUT Exercise Software:	Winthrax.exe

1.2.2 Support Equipment List and Details

Manufacturer	Description	Model	Serial Number
CLC	Earphone	Whiteview5.0	EP21106054
PHILIPS	Keyboard	SPT6234	K234210510746
PHILIPS	Mouse	SPT6234	C234210506222
Lenovo	Laptop	T460S	60PDTEK8
Lenovo	Laptop Adapter	ADLX45DLC3A	00HM613
TOTO LINK	Router	X5000R	X5000RK9T0560

1.2.3 Support Cable List and Details

Cable Description	Shielding Type	Ferrite Core	Length (m)	From Port	To
RJ45 Cable	Yes	No	1.2	Router	Laptop
RJ45 Cable	Yes	No	10	Network	Router
USB Cable	No	No	0.8	EUT	Laptop
Adapter Cable	Yes	No	1.5	Laptop	Adapter
Keyboard Cable	No	No	1.2	Keyboard	Laptop
Mouse Cable	No	No	1.2	Mouse	Laptop
Earphone Cable	No	No	1.2	Earphone	EUT

1.2.4 Block Diagram of Test Setup

AC line conducted emissions:

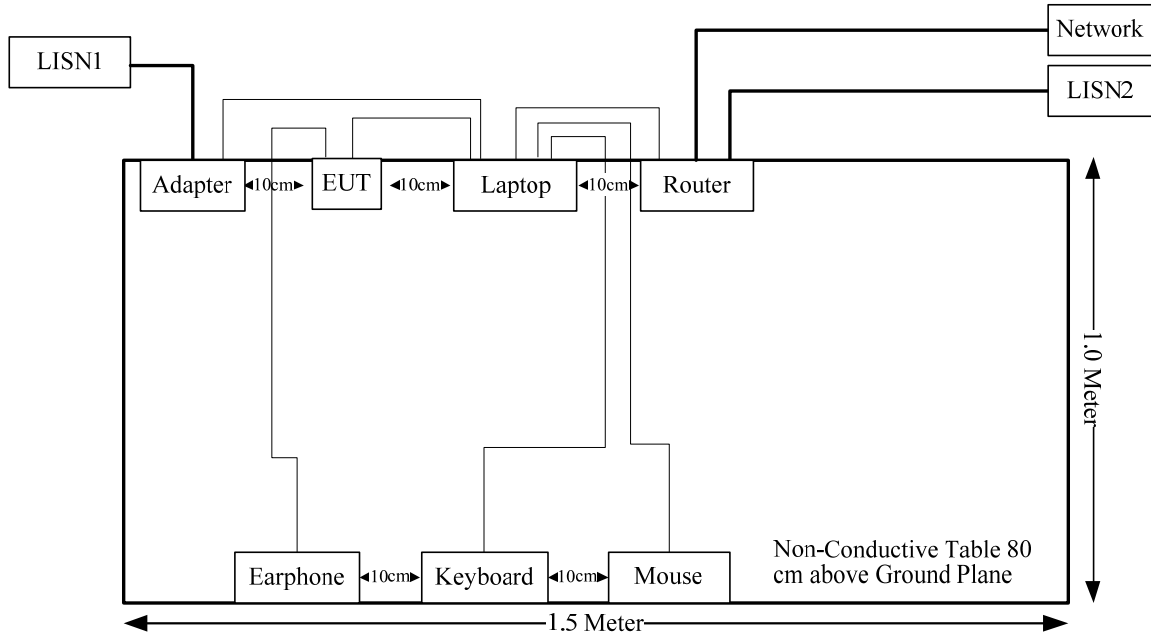

Radiated emissions:

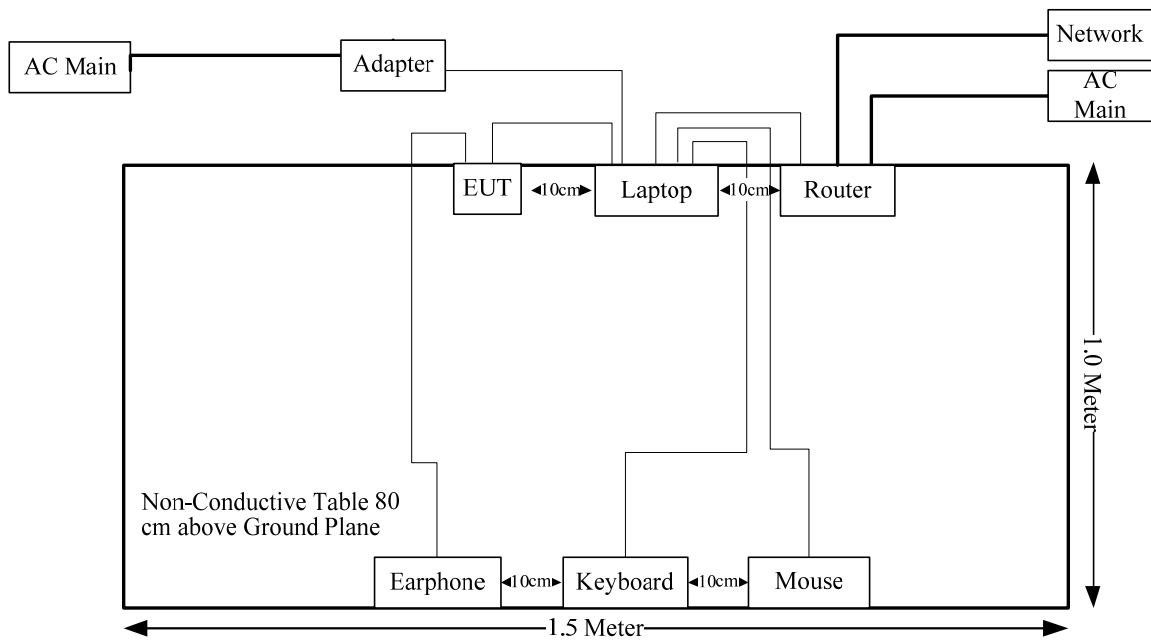

1.3 Measurement Uncertainty

Otherwise required by the applicant or Product Regulations, Decision Rule in this report did not consider the uncertainty. The extended uncertainty given in this report is obtained by combining the standard uncertainty times the coverage factor K with the 95% confidence interval.

Parameter	Measurement Uncertainty
Unwanted Emissions, radiated	30M~200MHz: 4.15 dB, 200M~1GHz: 5.61 dB, 1G~6GHz: 5.14 dB, 6G~18GHz: 5.93 dB, 18G~26.5G: 5.47 dB, 26.5G~40G: 5.63 dB
Temperature	$\pm 1^{\circ}\text{C}$
Humidity	$\pm 5\%$
AC Power Lines Conducted Emission	2.8 dB (150 kHz to 30 MHz)

2. SUMMARY OF TEST RESULTS

Standard(s) Section	Description of Test	Result
§15.107	Conducted emissions	Compliant
§15.109	Radiated emissions	Compliant

3. REQUIREMENTS AND TEST PROCEDURES

3.1 AC Line Conducted Emissions

3.1.1 EUT Setup

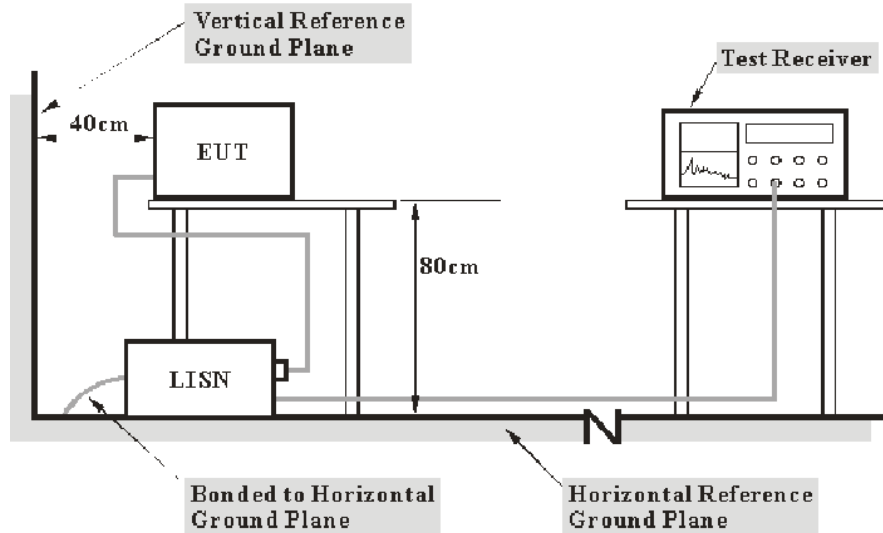

Note: 1. Support units were connected to second LISN.
 2. Both of LISNs (AMN) 80 cm from EUT and at the least 80 cm from other units and other metal planes support units.

The setup of EUT is according with per ANSI C63.4-2014 measurement procedure. The specification used was with the FCC Part 15 B Class B limits.

The external I/O cables were draped along the test table and formed a bundle 30 to 40 cm long in the middle.

The adapter or EUT was connected to the main LISN with a 120 V/60 Hz AC power source.

3.1.2 EMI Test Receiver Setup

The EMI test receiver was set to investigate the spectrum from 150 kHz to 30 MHz.

During the conducted emission test, the EMI test receiver was set with the following configurations:

Frequency Range	IF B/W
150 kHz – 30 MHz	9 kHz

3.1.3 Test Procedure

During the conducted emission test, the adapter was connected to the outlet of the first LISN and the other support equipments were connected to the outlet of the second LISN.

Maximizing procedure was performed on the six (6) highest emissions of the EUT, the report shall list the six emissions with the smallest margin relative to the limit, unless the margin is greater than 20 dB.

All data was recorded in the Quasi-peak and average detection mode.

The report shall list the six emissions with the smallest margin relative to the limit, unless the margin is greater than 20 dB.

3.1.4 Corrected Amplitude & Margin Calculation

The basic equation is as follows:

Result = Reading + Factor

Factor = attenuation caused by cable loss + voltage division factor of AMN

The “**Margin**” column of the following data tables indicates the degree of compliance within the applicable limit. The equation for margin calculation is as follows:

Margin = Limit – Result

3.2 Radiation Spurious Emissions

3.2.1 EUT Setup

Below 1GHz:

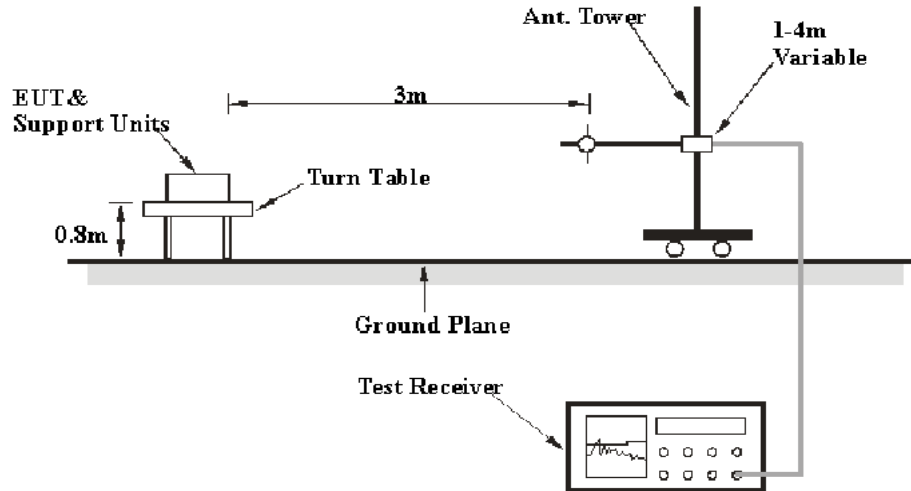

Above 1GHz:

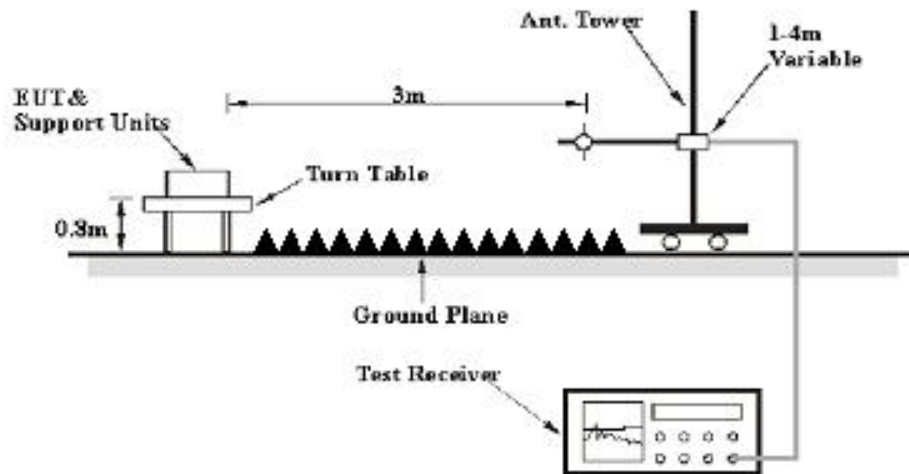

The radiated emission were performed in the 3 meters chamber test site, using the setup accordance with the ANSI C63.4-2014. The specification used was with the FCC Part 15 B Class B limits.

3.2.2 EMI Test Receiver Setup

The system was investigated from 30 MHz to 13 GHz.

During the radiated emission test, the EMI test receiver was set with the following configurations:

Frequency Range	RBW	Video B/W	IF B/W	Detector
30 MHz – 1000 MHz	120 kHz	300 kHz	120 kHz	QP
Above 1 GHz	1 MHz	3 MHz	/	Peak
	1 MHz	3 MHz	/	AVG

If the maximized peak measured value complies with under the limit more than 6dB, then it is unnecessary to perform an QP/Average measurement.

3.2.3 Test Procedure

During the radiated emissions, the adapter was connected to the first AC floor outlet and the other support equipments were connected to the second AC floor outlet.

Maximizing procedure was performed on the highest emissions to ensure that the EUT complied with all installation combinations.

The data was recorded in the Quasi-peak detection mode for below 1 GHz.

All emissions under the average limit and under the noise floor have not recorded in the report.

3.2.4 Corrected Amplitude & Margin Calculation

The basic equation is as follows:

Result = Reading + Factor

Factor = Antenna Factor + Cable Loss - Amplifier Gain

The “**Margin**” column of the following data tables indicates the degree of compliance within the applicable limit. The equation for margin calculation is as follows:

Margin = Limit – Result

4. TEST DATA AND RESULTS

4.1 AC Line Conducted Emissions

Serial Number:	2958-3	Test Date:	2023/08/14
Test Site:	CE	Test Mode:	Downloading
Tester:	David Huang	Test Result:	Pass

Environmental Conditions:

Temperature: (°C)	26	Relative Humidity: (%)	72	ATM Pressure: (kPa)	100.5
----------------------	----	------------------------------	----	------------------------	-------

Test Equipment List and Details:

Manufacturer	Description	Model	Serial Number	Calibration Date	Calibration Due Date
R&S	LISN	ENV216	101134	2023/03/31	2024/03/30
R&S	EMI Test Receiver	ESR3	102726	2023/03/31	2024/03/30
MICRO-COAX	Coaxial Cable	UTIFLEX	C-0200-01	2023/08/06	2024/08/05
Audix	Test Software	E3	190306 (V9)	N/A	N/A

* Statement of Traceability: China Certification ICT Co., Ltd (Dongguan) attests that all calibrations have been performed, traceable to National Primary Standards and International System of Units (SI).

Test Mode: Downloading
 Port: Line
 Note:

Date: 2023-08-14

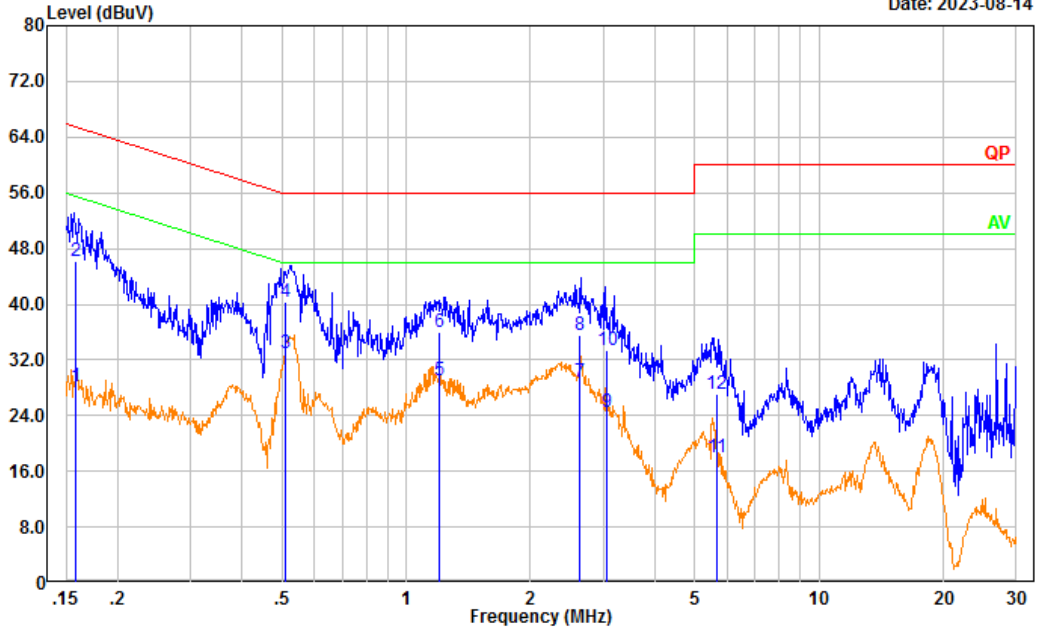

No.	Frequency (MHz)	Reading (dBμV)	Factor (dB)	Result (dBμV)	Limit (dBμV)	Margin (dB)	Detector
1	0.158	18.63	9.61	28.24	55.57	27.33	Average
2	0.158	36.58	9.61	46.19	65.57	19.38	QP
3	0.510	23.29	9.61	32.90	46.00	13.10	Average
4	0.510	30.65	9.61	40.26	56.00	15.74	QP
5	1.203	19.45	9.62	29.07	46.00	16.93	Average
6	1.203	26.35	9.62	35.97	56.00	20.03	QP
7	2.623	19.10	9.64	28.74	46.00	17.26	Average
8	2.623	25.94	9.64	35.58	56.00	20.42	QP
9	3.060	14.94	9.65	24.59	46.00	21.41	Average
10	3.060	23.80	9.65	33.45	56.00	22.55	QP
11	5.632	8.38	9.66	18.04	50.00	31.96	Average
12	5.632	17.42	9.66	27.08	60.00	32.92	QP

Test Mode: Downloading
 Port: neutral
 Note:

Date: 2023-08-14

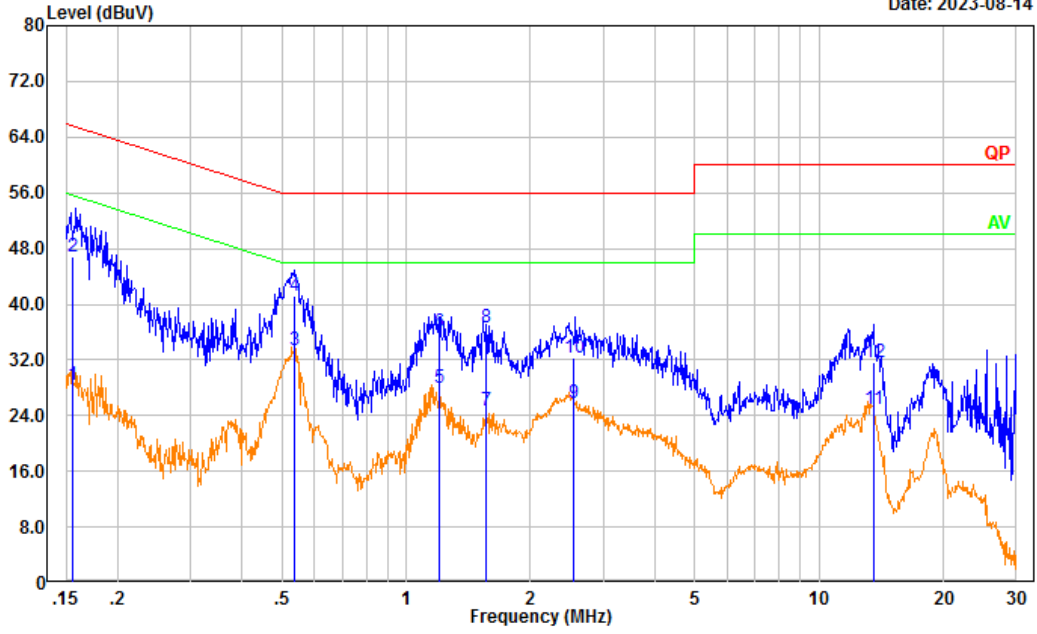

No.	Frequency (MHz)	Reading (dBμV)	Factor (dB)	Result (dBμV)	Limit (dBμV)	Margin (dB)	Detector
1	0.156	18.84	9.61	28.45	55.66	27.21	Average
2	0.156	37.23	9.61	46.84	65.66	18.82	QP
3	0.538	23.85	9.61	33.46	46.00	12.54	Average
4	0.538	31.48	9.61	41.09	56.00	14.91	QP
5	1.205	18.42	9.62	28.04	46.00	17.96	Average
6	1.205	26.27	9.62	35.89	56.00	20.11	QP
7	1.565	15.00	9.63	24.63	46.00	21.37	Average
8	1.565	26.94	9.63	36.57	56.00	19.43	QP
9	2.550	16.21	9.64	25.85	46.00	20.15	Average
10	2.550	22.67	9.64	32.31	56.00	23.69	QP
11	13.570	15.22	9.68	24.90	50.00	25.10	Average
12	13.570	21.98	9.68	31.66	60.00	28.34	QP

4.2 Radiation Spurious Emissions

Serial Number:	2958-3	Test Date:	2023/8/11~2023/8/17
Test Site:	966-2, 966-1	Test Mode:	Downloading
Tester:	Vic Du, Mack Huang	Test Result:	Pass

Environmental Conditions:

Temperature: (°C)	26.6~27.8	Relative Humidity: (%)	60~68	ATM Pressure: (kPa)	99.7~100
----------------------	-----------	---------------------------	-------	------------------------	----------

Test Equipment List and Details:

Manufacturer	Description	Model	Serial Number	Calibration Date	Calibration Due Date
Below 1GHz					
Sunol Sciences	Antenna	JB6	A082520-5	2020/10/19	2023/10/18
R&S	EMI Test Receiver	ESR3	102724	2023/3/31	2024/3/30
TIMES MICROWAVE	Coaxial Cable	LMR-600-UltraFlex	C-0470-02	2023/7/16	2024/7/15
TIMES MICROWAVE	Coaxial Cable	LMR-600-UltraFlex	C-0780-01	2023/7/16	2024/7/15
Sonoma	Amplifier	310N	186165	2023/7/16	2024/7/15
Audix	Test Software	E3	201021 (V9)	N/A	N/A
Above 1GHz					
ETS-Lindgren	Horn Antenna	3115	9912-5985	2020/10/13	2023/10/12
R&S	Spectrum Analyzer	FSV40	101591	2023/3/31	2024/3/30
MICRO-COAX	Coaxial Cable	UFA210A-1-1200-70U300	217423-008	2023/8/6	2024/8/5
MICRO-COAX	Coaxial Cable	UFA210A-1-2362-300300	235780-001	2023/8/6	2024/8/5
Mini	Pre-amplifier	ZVA-183-S+	5969001149	2022/11/9	2023/11/8
Audix	Test Software	E3	201021 (V9)	N/A	N/A

* Statement of Traceability: China Certification ICT Co., Ltd (Dongguan) attests that all calibrations have been performed, traceable to National Primary Standards and International System of Units (SI).

1) 30MHz-1GHz:

Test Mode: Downloading
 Polarization: horizontal
 Note:

Date: 2023-08-11

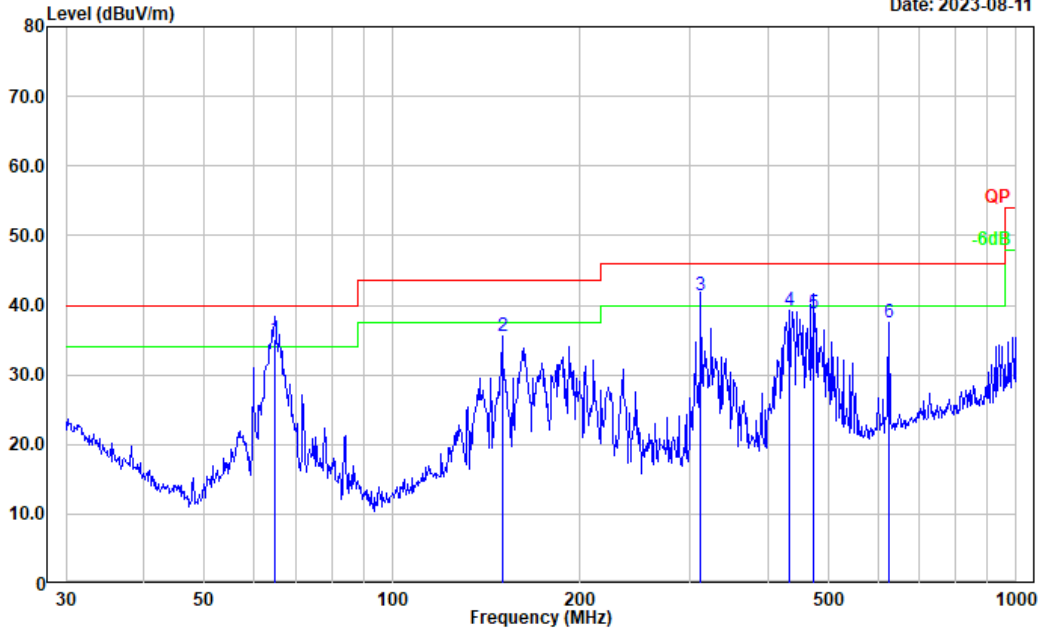

No.	Frequency (MHz)	Reading (dBμV)	Factor (dB/m)	Result (dBμV/m)	Limit (dBμV/m)	Margin (dB)	Detector
1	64.843	52.11	-16.94	35.17	40.00	4.83	QP
2	150.011	47.51	-12.00	35.51	43.50	7.99	Peak
3	312.005	52.11	-10.61	41.50	46.00	4.50	QP
4	432.546	46.60	-7.42	39.18	46.00	6.82	Peak
5	473.803	45.14	-6.30	38.84	46.00	7.16	QP
6	625.078	42.19	-4.60	37.59	46.00	8.41	Peak

Test Mode: Downloading
 Polarization: vertical
 Note:

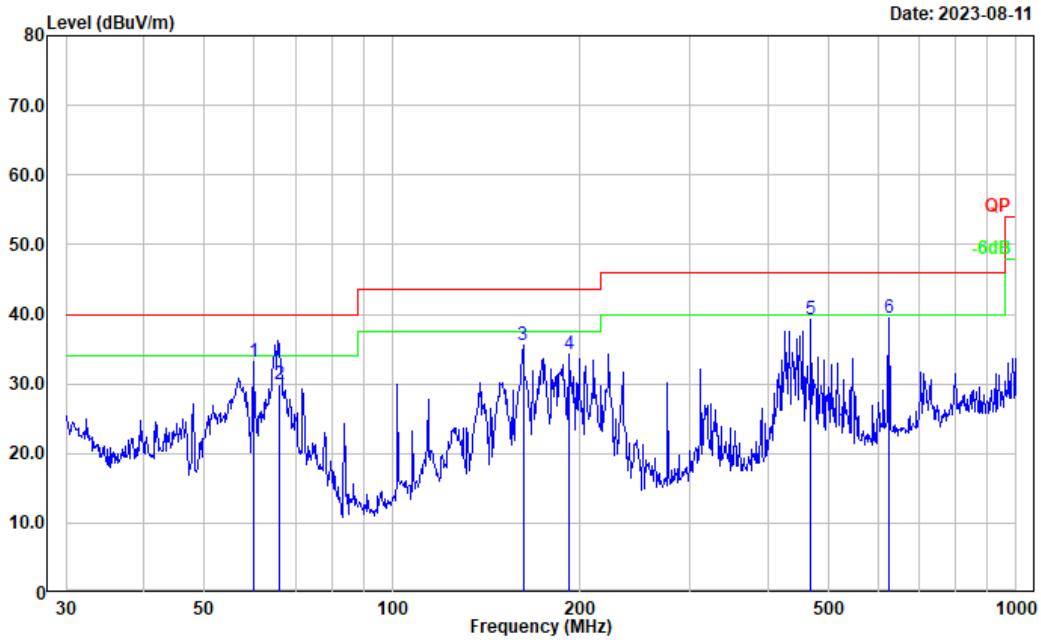

No.	Frequency (MHz)	Reading (dBμV)	Factor (dB/m)	Result (dBμV/m)	Limit (dBμV/m)	Margin (dB)	Detector
1	59.859	50.48	-17.41	33.07	40.00	6.93	Peak
2	66.013	46.74	-16.87	29.87	40.00	10.13	QP
3	162.041	47.75	-12.25	35.50	43.50	8.00	Peak
4	192.419	47.48	-13.13	34.35	43.50	9.15	Peak
5	468.876	45.56	-6.38	39.18	46.00	6.82	Peak
6	625.078	44.04	-4.60	39.44	46.00	6.56	Peak

2) Above 1GHz:

Test Mode: Downloading
 Polarization: horizontal
 Note:

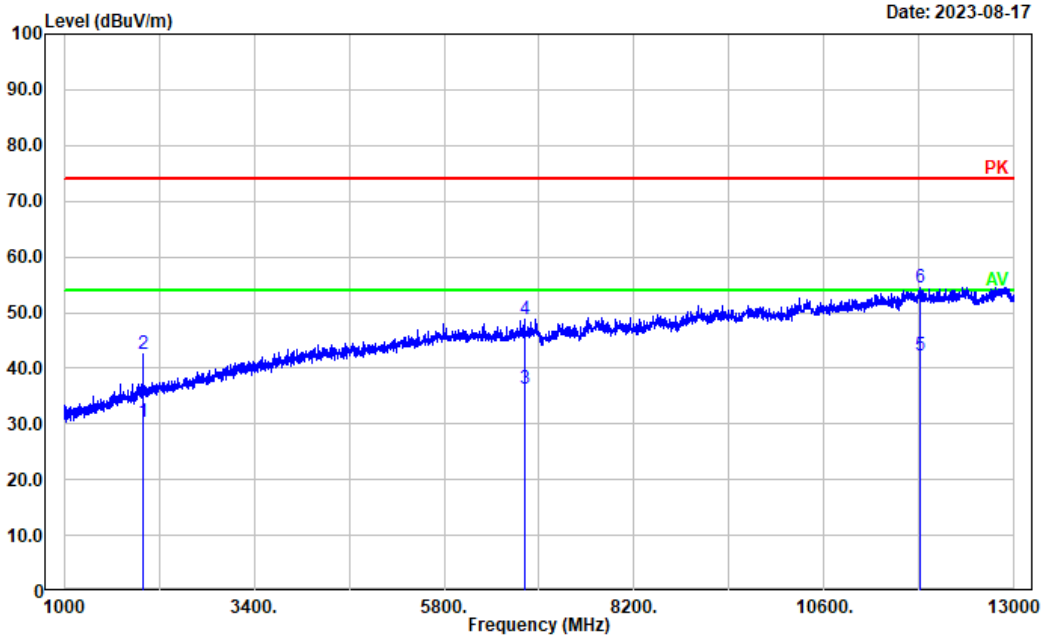

No.	Frequency (MHz)	Reading (dBμV)	Factor (dB/m)	Result (dBμV/m)	Limit (dBμV/m)	Margin (dB)	Detector
1	1996.399	27.94	2.30	30.24	54.00	23.76	Average
2	1996.399	40.18	2.30	42.48	74.00	31.52	Peak
3	6815.163	22.49	13.91	36.40	54.00	17.60	Average
4	6815.163	34.88	13.91	48.79	74.00	25.21	Peak
5	11814.160	21.19	21.09	42.28	54.00	11.72	Average
6	11814.160	33.46	21.09	54.55	74.00	19.45	Peak

Test Mode: Downloading
 Polarization: vertical
 Note:

Date: 2023-08-17

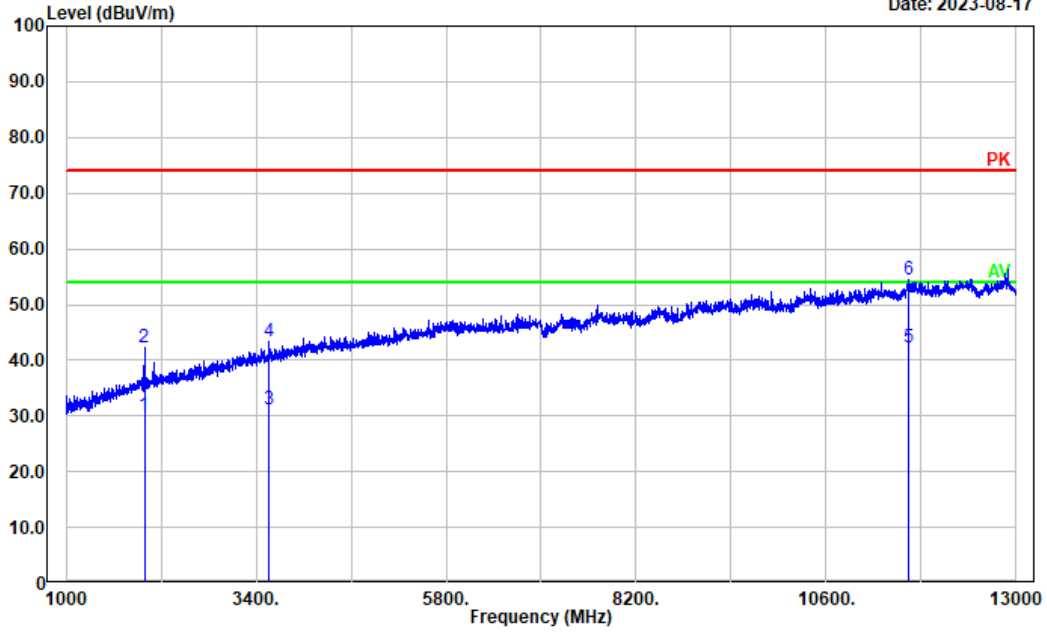

No.	Frequency (MHz)	Reading (dBμV)	Factor (dB/m)	Result (dBμV/m)	Limit (dBμV/m)	Margin (dB)	Detector
1	1989.598	27.90	2.28	30.18	54.00	23.82	Average
2	1989.598	40.08	2.28	42.36	74.00	31.64	Peak
3	3560.712	23.32	7.89	31.21	54.00	22.79	Average
4	3560.712	35.53	7.89	43.42	74.00	30.58	Peak
5	11647.530	21.22	21.06	42.28	54.00	11.72	Average
6	11647.530	33.49	21.06	54.55	74.00	19.45	Peak

==== END OF REPORT ====