

# PROBE CALIBRATION CERTIFICATES

**Calibration Laboratory of  
Schmid & Partner  
Engineering AG**  
Zeughausstrasse 43, 8004 Zurich, Switzerland



**S** Schweizerischer Kalibrierdienst  
**C** Service suisse d'étalonnage  
**S** Servizio svizzero di taratura  
**S** Swiss Calibration Service

Accredited by the Swiss Accreditation Service (SAS)  
The Swiss Accreditation Service is one of the signatories to the EA  
Multilateral Agreement for the recognition of calibration certificates

Accreditation No.: **SCS 0108**

Client **BACL**

Certificate No: **EX3-7441\_Nov16**

## CALIBRATION CERTIFICATE

Object: **EX3DV4 - SN:7441**

Calibration procedure(s): **QA CAL-01.v9, QA CAL-12.v9, QA CAL-14.v4, QA CAL-23.v5,  
QA CAL-25.v6  
Calibration procedure for dosimetric E-field probes**

Calibration date: **November 15, 2016**

This calibration certificate documents the traceability to national standards, which realize the physical units of measurements (SI).  
The measurements and the uncertainties with confidence probability are given on the following pages and are part of the certificate.

All calibrations have been conducted in the closed laboratory facility: environment temperature (22 ± 3)°C and humidity < 70%.

Calibration Equipment used (M&TE critical for calibration)

Primary Standards	ID	Cal Date (Certificate No.)	Scheduled Calibration
Power meter NRP	SN: 104778	06-Apr-16 (No. 217-02288/02289)	Apr-17
Power sensor NRP-Z91	SN: 103244	06-Apr-16 (No. 217-02288)	Apr-17
Power sensor NRP-Z91	SN: 103245	06-Apr-16 (No. 217-02289)	Apr-17
Reference 20 dB Attenuator	SN: S5277 (20x)	05-Apr-16 (No. 217-02293)	Apr-17
Reference Probe ES3DV2	SN: 3013	31-Dec-15 (No. ES3-3013_Dec15)	Dec-16
DAE4	SN: 660	23-Dec-15 (No. DAE4-660_Dec15)	Dec-16
Secondary Standards	ID	Check Date (in house)	Scheduled Check
Power meter E4419B	SN: GB41293874	06-Apr-16 (in house check Jun-16)	In house check: Jun-18
Power sensor E4412A	SN: MY41498087	06-Apr-16 (in house check Jun-16)	In house check: Jun-18
Power sensor E4412A	SN: 000110210	06-Apr-16 (in house check Jun-16)	In house check: Jun-18
RF generator HP 8648C	SN: US3642U01700	04-Aug-99 (in house check Jun-16)	In house check: Jun-18
Network Analyzer HP 8753E	SN: US37390585	18-Oct-01 (in house check Oct-16)	In house check: Oct-17

	Name	Function	Signature
Calibrated by:	Jeton Kastrati	Laboratory Technician	
Approved by:	Katja Pokovic	Technical Manager	

Issued: November 15, 2016

This calibration certificate shall not be reproduced except in full without written approval of the laboratory.

Calibration Laboratory of  
Schmid & Partner  
Engineering AG  
Zeughausstrasse 43, 8004 Zurich, Switzerland



S Schweizerischer Kalibrierdienst  
C Service suisse d'étalonnage  
S Servizio svizzero di taratura  
S Swiss Calibration Service

Accredited by the Swiss Accreditation Service (SAS)

The Swiss Accreditation Service is one of the signatories to the EA  
Multilateral Agreement for the recognition of calibration certificates

Accreditation No.: SCS 0108

#### Glossary:

TSL	tissue simulating liquid
NORM <sub>x,y,z</sub>	sensitivity in free space
ConvF	sensitivity in TSL / NORM <sub>x,y,z</sub>
DCP	diode compression point
CF	crest factor (1/duty_cycle) of the RF signal
A, B, C, D	modulation dependent linearization parameters
Polarization $\phi$	$\phi$ rotation around probe axis
Polarization $\vartheta$	$\vartheta$ rotation around an axis that is in the plane normal to probe axis (at measurement center), i.e., $\vartheta = 0$ is normal to probe axis
Connector Angle	information used in DASY system to align probe sensor X to the robot coordinate system

#### Calibration is Performed According to the Following Standards:

- IEEE Std 1528-2013, "IEEE Recommended Practice for Determining the Peak Spatial-Averaged Specific Absorption Rate (SAR) in the Human Head from Wireless Communications Devices: Measurement Techniques", June 2013
- IEC 62209-1, "Procedure to measure the Specific Absorption Rate (SAR) for hand-held devices used in close proximity to the ear (frequency range of 300 MHz to 3 GHz)", February 2005
- IEC 62209-2, "Procedure to determine the Specific Absorption Rate (SAR) for wireless communication devices used in close proximity to the human body (frequency range of 30 MHz to 6 GHz)", March 2010
- KDB 865664, "SAR Measurement Requirements for 100 MHz to 6 GHz"

#### Methods Applied and Interpretation of Parameters:

- NORM<sub>x,y,z</sub>**: Assessed for E-field polarization  $\vartheta = 0$  ( $f \leq 900$  MHz in TEM-cell;  $f > 1800$  MHz: R22 waveguide). NORM<sub>x,y,z</sub> are only intermediate values, i.e., the uncertainties of NORM<sub>x,y,z</sub> does not affect the E<sup>2</sup>-field uncertainty inside TSL (see below ConvF).
- NORM(f)<sub>x,y,z</sub>** = NORM<sub>x,y,z</sub> \* frequency\_response (see Frequency Response Chart). This linearization is implemented in DASY4 software versions later than 4.2. The uncertainty of the frequency response is included in the stated uncertainty of ConvF.
- DCP<sub>x,y,z</sub>**: DCP are numerical linearization parameters assessed based on the data of power sweep with CW signal (no uncertainty required). DCP does not depend on frequency nor media.
- PAR**: PAR is the Peak to Average Ratio that is not calibrated but determined based on the signal characteristics
- A<sub>x,y,z</sub>; B<sub>x,y,z</sub>; C<sub>x,y,z</sub>; D<sub>x,y,z</sub>; VR<sub>x,y,z</sub>; A, B, C, D** are numerical linearization parameters assessed based on the data of power sweep for specific modulation signal. The parameters do not depend on frequency nor media. VR is the maximum calibration range expressed in RMS voltage across the diode.
- ConvF and Boundary Effect Parameters**: Assessed in flat phantom using E-field (or Temperature Transfer Standard for  $f \leq 800$  MHz) and inside waveguide using analytical field distributions based on power measurements for  $f > 800$  MHz. The same setups are used for assessment of the parameters applied for boundary compensation (alpha, depth) of which typical uncertainty values are given. These parameters are used in DASY4 software to improve probe accuracy close to the boundary. The sensitivity in TSL corresponds to NORM<sub>x,y,z</sub> \* ConvF whereby the uncertainty corresponds to that given for ConvF. A frequency dependent ConvF is used in DASY version 4.4 and higher which allows extending the validity from  $\pm 50$  MHz to  $\pm 100$  MHz.
- Spherical isotropy (3D deviation from isotropy)**: in a field of low gradients realized using a flat phantom exposed by a patch antenna.
- Sensor Offset**: The sensor offset corresponds to the offset of virtual measurement center from the probe tip (on probe axis). No tolerance required.
- Connector Angle**: The angle is assessed using the information gained by determining the NORM<sub>x</sub> (no uncertainty required).

EX3DV4 – SN:7441

November 15, 2016

# Probe EX3DV4

## SN:7441

Manufactured: May 31, 2016  
Calibrated: November 15, 2016

Calibrated for DASY/EASY Systems  
(Note: non-compatible with DASY2 system!)

EX3DV4- SN:7441

November 15, 2016

## DASY/EASY - Parameters of Probe: EX3DV4 - SN:7441

### Basic Calibration Parameters

	Sensor X	Sensor Y	Sensor Z	Unc (k=2)
Norm ( $\mu\text{V}/(\text{V}/\text{m})^2$ ) <sup>A</sup>	0.40	0.45	0.36	± 10.1 %
DCP (mV) <sup>B</sup>	100.2	101.2	104.2	

### Modulation Calibration Parameters

UID	Communication System Name		A dB	B dB $\sqrt{\mu\text{V}}$	C	D dB	VR mV	Unc <sup>E</sup> (k=2)
0	CW	X	0.0	0.0	1.0	0.00	188.5	±3.5 %
		Y	0.0	0.0	1.0		177.8	
		Z	0.0	0.0	1.0		182.4	

The reported uncertainty of measurement is stated as the standard uncertainty of measurement multiplied by the coverage factor k=2, which for a normal distribution corresponds to a coverage probability of approximately 95%.

<sup>A</sup> The uncertainties of Norm X,Y,Z do not affect the E<sup>2</sup>-field uncertainty inside TSL (see Pages 5 and 6).

<sup>B</sup> Numerical linearization parameter; uncertainty not required.

<sup>E</sup> Uncertainty is determined using the max. deviation from linear response applying rectangular distribution and is expressed for the square of the field value.

EX3DV4- SN:7441

November 15, 2016

**DASY/EASY - Parameters of Probe: EX3DV4 - SN:7441**

**Calibration Parameter Determined in Head Tissue Simulating Media**

f (MHz) <sup>C</sup>	Relative Permittivity <sup>F</sup>	Conductivity (S/m) <sup>F</sup>	ConvF X	ConvF Y	ConvF Z	Alpha <sup>G</sup>	Depth <sup>G</sup> (mm)	Unc (k=2)
150	52.3	0.76	13.25	13.25	13.25	0.00	1.00	± 13.3 %
450	43.5	0.87	10.98	10.98	10.98	0.02	1.20	± 13.3 %
750	41.9	0.89	10.73	10.73	10.73	0.53	0.85	± 12.0 %
900	41.5	0.97	10.22	10.22	10.22	0.41	0.96	± 12.0 %
1750	40.1	1.37	8.92	8.92	8.92	0.35	0.80	± 12.0 %
1900	40.0	1.40	8.48	8.48	8.48	0.33	0.80	± 12.0 %
2450	39.2	1.80	7.85	7.85	7.85	0.35	0.84	± 12.0 %
2600	39.0	1.96	7.53	7.53	7.53	0.36	0.80	± 12.0 %
5250	35.9	4.71	5.67	5.67	5.67	0.35	1.80	± 13.1 %
5600	35.5	5.07	5.00	5.00	5.00	0.40	1.80	± 13.1 %
5800	35.3	5.27	5.11	5.11	5.11	0.40	1.80	± 13.1 %

<sup>C</sup> Frequency validity above 300 MHz of ± 100 MHz only applies for DASY v4.4 and higher (see Page 2), else it is restricted to ± 50 MHz. The uncertainty is the RSS of the ConvF uncertainty at calibration frequency and the uncertainty for the indicated frequency band. Frequency validity below 300 MHz is ± 10, 25, 40, 50 and 70 MHz for ConvF assessments at 30, 64, 126, 150 and 220 MHz respectively. Above 5 GHz frequency validity can be extended to ± 110 MHz.

<sup>F</sup> At frequencies below 3 GHz, the validity of tissue parameters ( $\epsilon$  and  $\sigma$ ) can be relaxed to ± 10% if liquid compensation formula is applied to measured SAR values. At frequencies above 3 GHz, the validity of tissue parameters ( $\epsilon$  and  $\sigma$ ) is restricted to ± 5%. The uncertainty is the RSS of the ConvF uncertainty for indicated target tissue parameters.

<sup>G</sup> Alpha/Depth are determined during calibration. SPEAG warrants that the remaining deviation due to the boundary effect after compensation is always less than ± 1% for frequencies below 3 GHz and below ± 2% for frequencies between 3-6 GHz at any distance larger than half the probe tip diameter from the boundary.



EX3DV4- SN:7441

November 15, 2016

## DASY/EASY - Parameters of Probe: EX3DV4 - SN:7441

### Calibration Parameter Determined in Body Tissue Simulating Media

f (MHz) <sup>C</sup>	Relative Permittivity <sup>F</sup>	Conductivity (S/m) <sup>F</sup>	ConvF X	ConvF Y	ConvF Z	Alpha <sup>G</sup>	Depth <sup>H</sup> (mm)	Unc (k=2)
150	61.9	0.80	12.58	12.58	12.58	0.00	1.00	± 13.3 %
450	56.7	0.94	12.08	12.08	12.08	0.06	1.20	± 13.3 %
750	55.5	0.96	10.12	10.12	10.12	0.53	0.80	± 12.0 %
900	55.0	1.05	9.85	9.85	9.85	0.44	0.80	± 12.0 %
1750	53.4	1.49	8.25	8.25	8.25	0.37	0.80	± 12.0 %
1900	53.3	1.52	7.95	7.95	7.95	0.31	1.00	± 12.0 %
2450	52.7	1.95	7.67	7.67	7.67	0.36	0.80	± 12.0 %
2600	52.5	2.16	7.39	7.39	7.39	0.29	0.80	± 12.0 %
5250	48.9	5.36	5.24	5.24	5.24	0.40	1.90	± 13.1 %
5600	48.5	5.77	4.33	4.33	4.33	0.50	1.90	± 13.1 %
5800	48.2	6.00	4.48	4.48	4.48	0.50	1.90	± 13.1 %

<sup>C</sup> Frequency validity above 300 MHz of ± 100 MHz only applies for DASY v4.4 and higher (see Page 2), else it is restricted to ± 50 MHz. The uncertainty is the RSS of the ConvF uncertainty at calibration frequency and the uncertainty for the indicated frequency band. Frequency validity below 300 MHz is ± 10, 25, 40, 50 and 70 MHz for ConvF assessments at 30, 64, 128, 150 and 220 MHz respectively. Above 5 GHz frequency validity can be extended to ± 110 MHz.

<sup>F</sup> At frequencies below 3 GHz, the validity of tissue parameters ( $\epsilon$  and  $\sigma$ ) can be relaxed to ± 10% if liquid compensation formula is applied to measured SAR values. At frequencies above 3 GHz, the validity of tissue parameters ( $\epsilon$  and  $\sigma$ ) is restricted to ± 5%. The uncertainty is the RSS of the ConvF uncertainty for indicated target tissue parameters.

<sup>G</sup> Alpha/Depth are determined during calibration. SPEAG warrants that the remaining deviation due to the boundary effect after compensation is always less than ± 1% for frequencies below 3 GHz and below ± 2% for frequencies between 3-6 GHz at any distance larger than half the probe tip diameter from the boundary.

EX3DV4-SN:7441

November 15, 2016

### Frequency Response of E-Field (TEM-Cell: ifi110 EXX, Waveguide: R22)

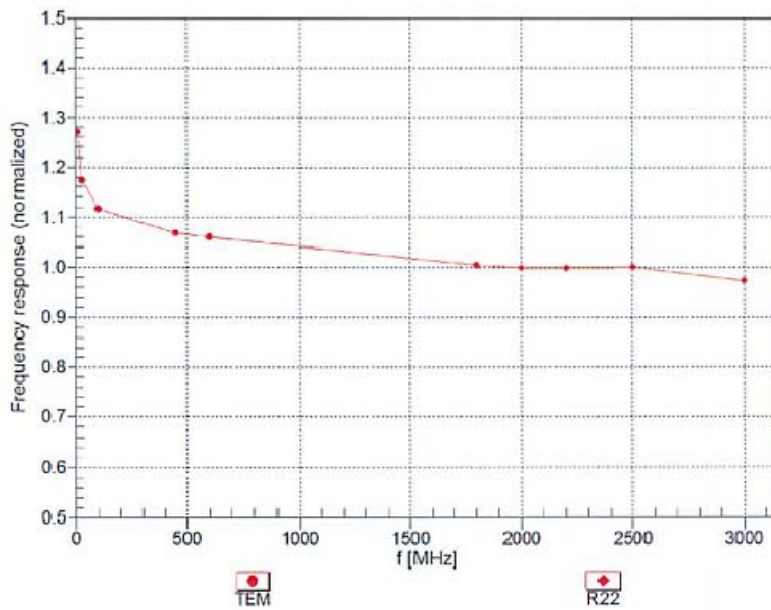

Uncertainty of Frequency Response of E-field:  $\pm 6.3\%$  (k=2)

EX3DV4- SN:7441

November 15, 2016

### Receiving Pattern ( $\phi$ ), $\theta = 0^\circ$

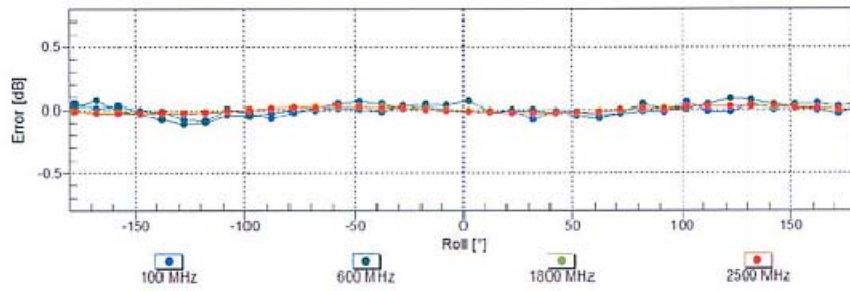
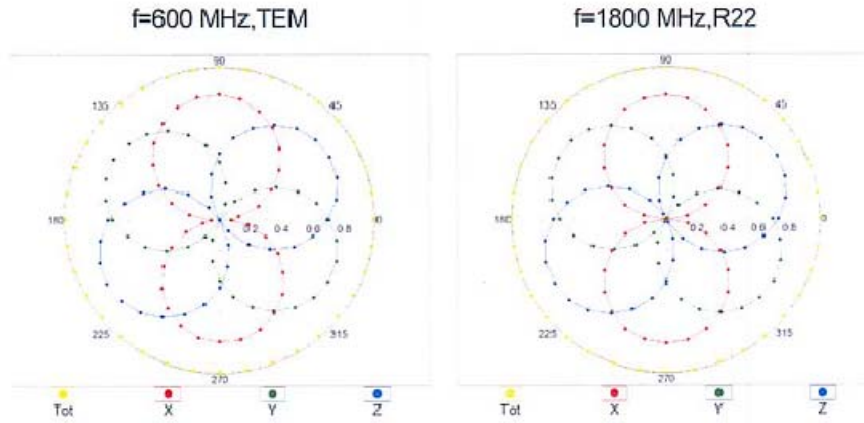

Uncertainty of Axial Isotropy Assessment:  $\pm 0.5\%$  ( $k=2$ )



EX3DV4- SN:7441

November 15, 2016

### Dynamic Range f(SAR<sub>head</sub>) (TEM cell , f<sub>eval</sub>= 1900 MHz)

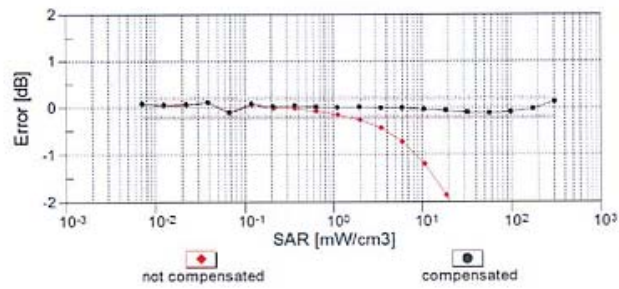
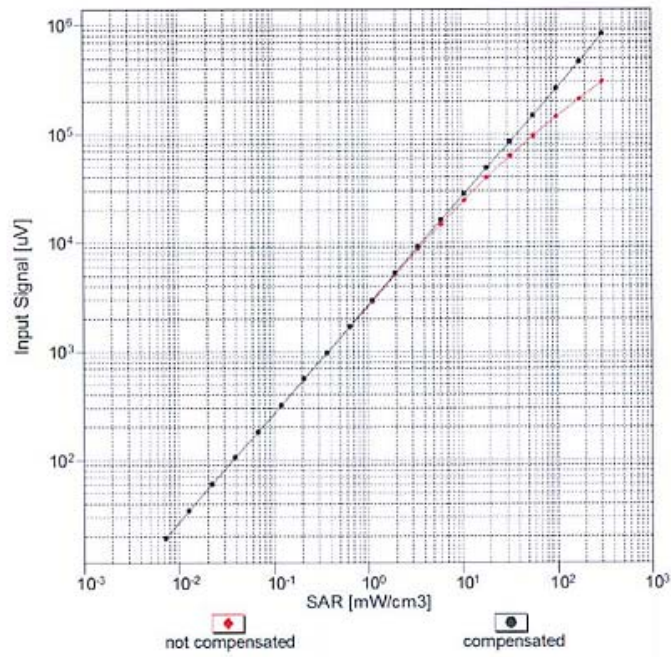

Uncertainty of Linearity Assessment: ± 0.6% (k=2)

EX3DV4- SN:7441

November 15, 2016

### Conversion Factor Assessment

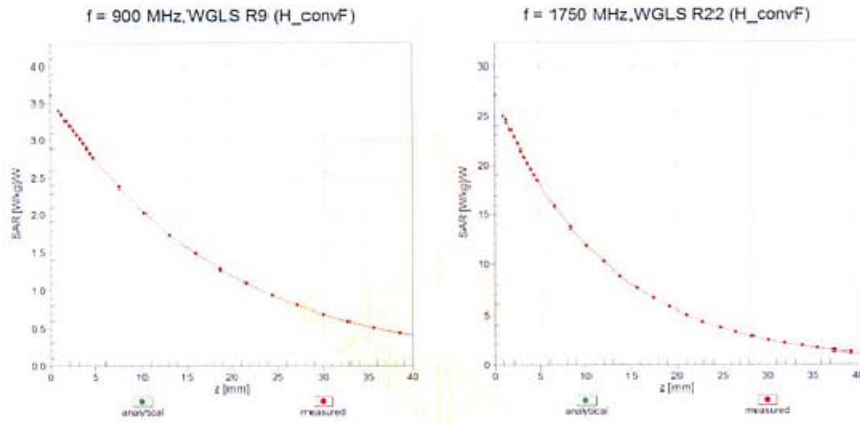

### Deviation from Isotropy in Liquid Error ( $\phi, \theta$ ), f = 900 MHz

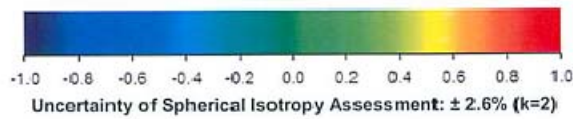
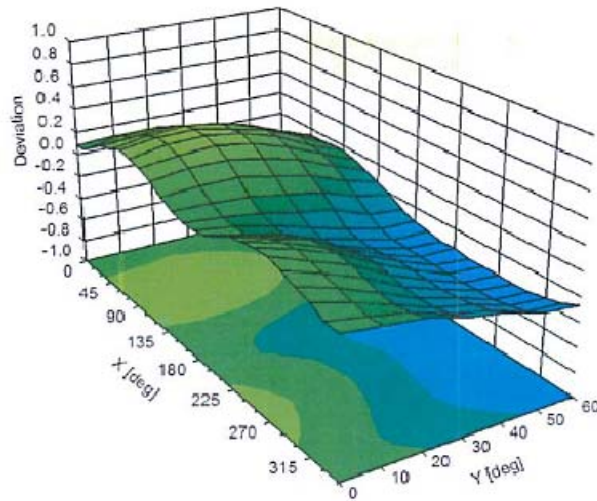

Uncertainty of Spherical Isotropy Assessment:  $\pm 2.6\%$  (k=2)

EX3DV4- SN:7441

November 15, 2016

## DASY/EASY - Parameters of Probe: EX3DV4 - SN:7441

### Other Probe Parameters

Sensor Arrangement	Triangular
Connector Angle (°)	102.1
Mechanical Surface Detection Mode	enabled
Optical Surface Detection Mode	disabled
Probe Overall Length	337 mm
Probe Body Diameter	10 mm
Tip Length	9 mm
Tip Diameter	2.5 mm
Probe Tip to Sensor X Calibration Point	1 mm
Probe Tip to Sensor Y Calibration Point	1 mm
Probe Tip to Sensor Z Calibration Point	1 mm
Recommended Measurement Distance from Surface	1.4 mm

# DIPOLE CALIBRATION CERTIFICATES

**Calibration Laboratory of  
Schmid & Partner  
Engineering AG**  
Zeughausstrasse 43, 8004 Zurich, Switzerland



**S** Schweizerischer Kalibrierdienst  
**C** Service suisse d'étalonnage  
**S** Servizio svizzero di taratura  
**S** Swiss Calibration Service

Accredited by the Swiss Accreditation Service (SAS)  
The Swiss Accreditation Service is one of the signatories to the EA  
Multilateral Agreement for the recognition of calibration certificates

Accreditation No.: SCS 0108

Client **BACL**

Certificate No: D835V2-453\_Aug15

## CALIBRATION CERTIFICATE

Object: D835V2 - SN: 453

Calibration procedure(s): QA CAL-05.v9  
Calibration procedure for dipole validation kits above 700 MHz

Calibration date: August 17, 2015

This calibration certificate documents the traceability to national standards, which realize the physical units of measurements (SI).  
The measurements and the uncertainties with confidence probability are given on the following pages and are part of the certificate.

All calibrations have been conducted in the closed laboratory facility: environment temperature (22 ± 3)°C and humidity < 70%.

Calibration Equipment used (M&TE critical for calibration)

Primary Standards	ID #	Cal Date (Certificate No.)	Scheduled Calibration
Power meter EPM-442A	GB37480704	07-Oct-14 (No. 217-02020)	Oct-15
Power sensor HP 8481A	US37292783	07-Oct-14 (No. 217-02020)	Oct-15
Power sensor HP 8481A	MY41092317	07-Oct-14 (No. 217-02021)	Oct-15
Reference 20 dB Attenuator	SN: 5058 (20k)	01-Apr-15 (No. 217-02131)	Mar-16
Type-N mismatch combination	SN: 5047.2 / 06327	01-Apr-15 (No. 217-02134)	Mar-16
Reference Probe ES3DV3	SN: 3205	30-Dec-14 (No. ES3-3205_Dec14)	Dec-15
DAE4	SN: 654	08-Jul-15 (No. DAE4-654_Jul15)	Jul-16
Secondary Standards	ID #	Check Date (in house)	Scheduled Check
RF generator R&S SMT-06	100005	04-Aug-99 (in house check Oct-13)	In house check: Oct-16
Network Analyzer HP 8753E	US37390585 S4206	18-Oct-01 (in house check Oct-14)	In house check: Oct-15

Calibrated by:	Name Jeton Kastrati	Function Laboratory Technician	Signature 
Approved by:	Name Katja Pokovic	Function Technical Manager	Signature 

Issued: August 18, 2015

This calibration certificate shall not be reproduced except in full without written approval of the laboratory.



**Calibration Laboratory of  
Schmid & Partner  
Engineering AG**  
Zeughausstrasse 43, 8004 Zurich, Switzerland



**S** Schweizerischer Kalibrierdienst  
**C** Service suisse d'étalonnage  
**S** Servizio svizzero di taratura  
**S** Swiss Calibration Service

Accredited by the Swiss Accreditation Service (SAS)  
The Swiss Accreditation Service is one of the signatories to the EA  
Multilateral Agreement for the recognition of calibration certificates

Accreditation No.: **SCS 0108**

**Glossary:**

TSL	tissue simulating liquid
ConvF	sensitivity in TSL / NORM x,y,z
N/A	not applicable or not measured

**Calibration is Performed According to the Following Standards:**

- IEEE Std 1528-2013, "IEEE Recommended Practice for Determining the Peak Spatial-Averaged Specific Absorption Rate (SAR) in the Human Head from Wireless Communications Devices: Measurement Techniques", June 2013
- IEC 62209-1, "Procedure to measure the Specific Absorption Rate (SAR) for hand-held devices used in close proximity to the ear (frequency range of 300 MHz to 3 GHz)", February 2005
- IEC 62209-2, "Procedure to determine the Specific Absorption Rate (SAR) for wireless communication devices used in close proximity to the human body (frequency range of 30 MHz to 6 GHz)", March 2010
- KDB 865664, "SAR Measurement Requirements for 100 MHz to 6 GHz"

**Additional Documentation:**

- DASY4/5 System Handbook

**Methods Applied and Interpretation of Parameters:**

- Measurement Conditions:** Further details are available from the Validation Report at the end of the certificate. All figures stated in the certificate are valid at the frequency indicated.
- Antenna Parameters with TSL:** The dipole is mounted with the spacer to position its feed point exactly below the center marking of the flat phantom section, with the arms oriented parallel to the body axis.
- Feed Point Impedance and Return Loss:** These parameters are measured with the dipole positioned under the liquid filled phantom. The impedance stated is transformed from the measurement at the SMA connector to the feed point. The Return Loss ensures low reflected power. No uncertainty required.
- Electrical Delay:** One-way delay between the SMA connector and the antenna feed point. No uncertainty required.
- SAR measured:** SAR measured at the stated antenna input power.
- SAR normalized:** SAR as measured, normalized to an input power of 1 W at the antenna connector.
- SAR for nominal TSL parameters:** The measured TSL parameters are used to calculate the nominal SAR result.

The reported uncertainty of measurement is stated as the standard uncertainty of measurement multiplied by the coverage factor  $k=2$ , which for a normal distribution corresponds to a coverage probability of approximately 95%.

**Measurement Conditions**

DASY system configuration, as far as not given on page 1.

DASY Version	DASY5	V52.8.8
Extrapolation	Advanced Extrapolation	
Phantom	Modular Flat Phantom	
Distance Dipole Center - TSL	15 mm	with Spacer
Zoom Scan Resolution	dx, dy, dz = 5 mm	
Frequency	835 MHz ± 1 MHz	

**Head TSL parameters**

The following parameters and calculations were applied.

	Temperature	Permittivity	Conductivity
Nominal Head TSL parameters	22.0 °C	41.5	0.90 mho/m
Measured Head TSL parameters	(22.0 ± 0.2) °C	41.9 ± 6 %	0.93 mho/m ± 6 %
Head TSL temperature change during test	< 0.5 °C	----	----

**SAR result with Head TSL**

SAR averaged over 1 cm <sup>3</sup> (1 g) of Head TSL	Condition	
SAR measured	250 mW input power	2.41 W/kg
SAR for nominal Head TSL parameters	normalized to 1W	9.43 W/kg ± 17.0 % (k=2)

SAR averaged over 10 cm <sup>3</sup> (10 g) of Head TSL	condition	
SAR measured	250 mW input power	1.56 W/kg
SAR for nominal Head TSL parameters	normalized to 1W	6.13 W/kg ± 16.5 % (k=2)

**Body TSL parameters**

The following parameters and calculations were applied.

	Temperature	Permittivity	Conductivity
Nominal Body TSL parameters	22.0 °C	55.2	0.97 mho/m
Measured Body TSL parameters	(22.0 ± 0.2) °C	56.1 ± 6 %	1.02 mho/m ± 6 %
Body TSL temperature change during test	< 0.5 °C	----	----

**SAR result with Body TSL**

SAR averaged over 1 cm <sup>3</sup> (1 g) of Body TSL	Condition	
SAR measured	250 mW input power	2.47 W/kg
SAR for nominal Body TSL parameters	normalized to 1W	9.55 W/kg ± 17.0 % (k=2)

SAR averaged over 10 cm <sup>3</sup> (10 g) of Body TSL	condition	
SAR measured	250 mW input power	1.61 W/kg
SAR for nominal Body TSL parameters	normalized to 1W	6.27 W/kg ± 16.5 % (k=2)



**Appendix (Additional assessments outside the scope of SCS 0108)**

**Antenna Parameters with Head TSL**

Impedance, transformed to feed point	50.7 $\Omega$ - 4.6 j $\Omega$
Return Loss	- 26.8 dB

**Antenna Parameters with Body TSL**

Impedance, transformed to feed point	46.8 $\Omega$ - 6.0 j $\Omega$
Return Loss	- 23.1 dB

**General Antenna Parameters and Design**

Electrical Delay (one direction)	1.392 ns
----------------------------------	----------

After long term use with 100W radiated power, only a slight warming of the dipole near the feedpoint can be measured.

The dipole is made of standard semirigid coaxial cable. The center conductor of the feeding line is directly connected to the second arm of the dipole. The antenna is therefore short-circuited for DC-signals. On some of the dipoles, small end caps are added to the dipole arms in order to improve matching when loaded according to the position as explained in the "Measurement Conditions" paragraph. The SAR data are not affected by this change. The overall dipole length is still according to the Standard.

No excessive force must be applied to the dipole arms, because they might bend or the soldered connections near the feedpoint may be damaged.

**Additional EUT Data**

Manufactured by	SPEAG
Manufactured on	January 31, 2002

## DASY5 Validation Report for Head TSL

Date: 17.08.2015

Test Laboratory: SPEAG, Zurich, Switzerland

**DUT: Dipole 835 MHz; Type: D835V2; Serial: D835V2 - SN: 453**

Communication System: UID 0 - CW; Frequency: 835 MHz

Medium parameters used:  $f = 835$  MHz;  $\sigma = 0.93$  S/m;  $\epsilon_r = 41.9$ ;  $\rho = 1000$  kg/m<sup>3</sup>

Phantom section: Flat Section

Measurement Standard: DASY5 (IEEE/IEC/ANSI C63.19-2011)

DASY52 Configuration:

- Probe: ES3DV3 - SN3205; ConvF(6.2, 6.2, 6.2); Calibrated: 30.12.2014;
- Sensor-Surface: 3mm (Mechanical Surface Detection)
- Electronics: DAE4 Sn654; Calibrated: 08.07.2015
- Phantom: Flat Phantom 4.9L; Type: QD000P49AA; Serial: 1001
- DASY52 52.8.8(1222); SEMCAD X 14.6.10(7331)

### Dipole Calibration for Head Tissue/Pin=250 mW, d=15mm/Zoom Scan (7x7x7)/Cube 0:

Measurement grid: dx=5mm, dy=5mm, dz=5mm

Reference Value = 58.20 V/m; Power Drift = -0.06 dB

Peak SAR (extrapolated) = 3.65 W/kg

**SAR(1 g) = 2.41 W/kg; SAR(10 g) = 1.56 W/kg**

Maximum value of SAR (measured) = 2.84 W/kg

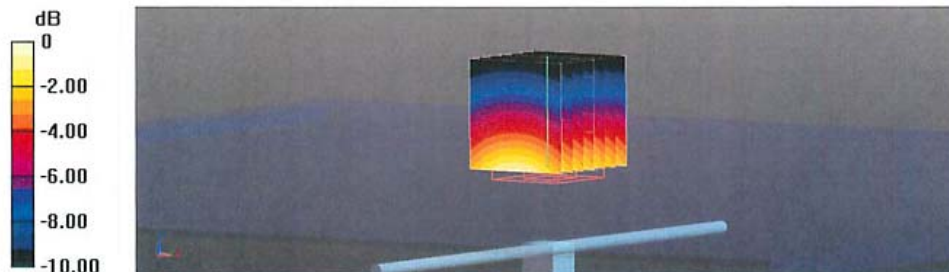

0 dB = 2.84 W/kg = 4.53 dBW/kg

### Impedance Measurement Plot for Head TSL

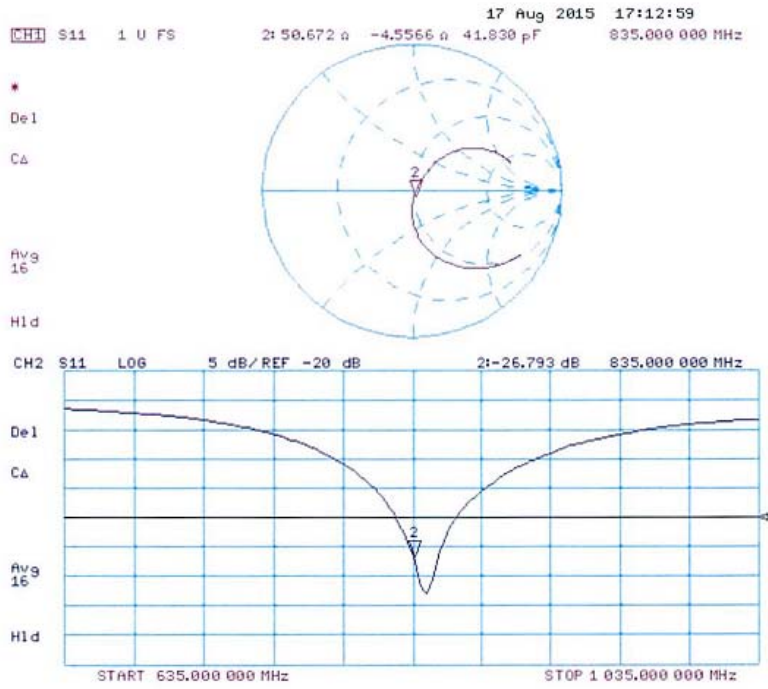

**DASY5 Validation Report for Body TSL**

Date: 17.08.2015

Test Laboratory: SPEAG, Zurich, Switzerland

**DUT: Dipole 835 MHz; Type: D835V2; Serial: D835V2 - SN: 453**

Communication System: UID 0 - CW; Frequency: 835 MHz  
Medium parameters used:  $f = 835 \text{ MHz}$ ;  $\sigma = 1.02 \text{ S/m}$ ;  $\epsilon_r = 56.1$ ;  $\rho = 1000 \text{ kg/m}^3$   
Phantom section: Flat Section  
Measurement Standard: DASY5 (IEEE/IEC/ANSI C63.19-2011)

DASY52 Configuration:

- Probe: ES3DV3 - SN3205; ConvF(6.17, 6.17, 6.17); Calibrated: 30.12.2014;
- Sensor-Surface: 3mm (Mechanical Surface Detection)
- Electronics: DAE4 Sn654; Calibrated: 08.07.2015
- Phantom: Flat Phantom 4.9L; Type: QD000P49AA; Serial: 1001
- DASY52 52.8.8(1222); SEMCAD X 14.6.10(7331)

**Dipole Calibration for Body Tissue/Pin=250 mW, d=15mm/Zoom Scan (7x7x7)/Cube 0:**

Measurement grid:  $dx=5\text{mm}$ ,  $dy=5\text{mm}$ ,  $dz=5\text{mm}$   
Reference Value = 55.00 V/m; Power Drift = 0.01 dB  
Peak SAR (extrapolated) = 3.69 W/kg  
**SAR(1 g) = 2.47 W/kg; SAR(10 g) = 1.61 W/kg**  
Maximum value of SAR (measured) = 2.89 W/kg

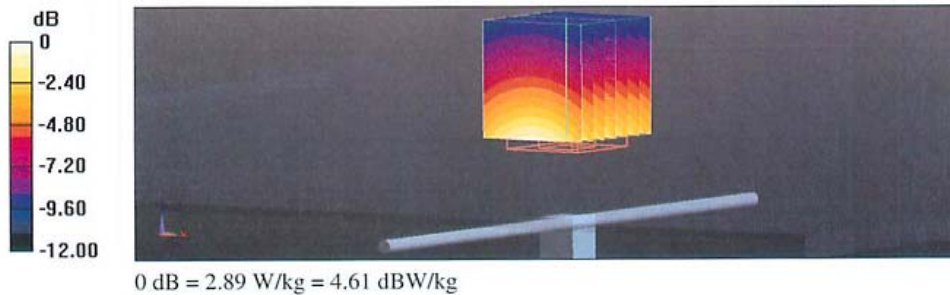

### Impedance Measurement Plot for Body TSL

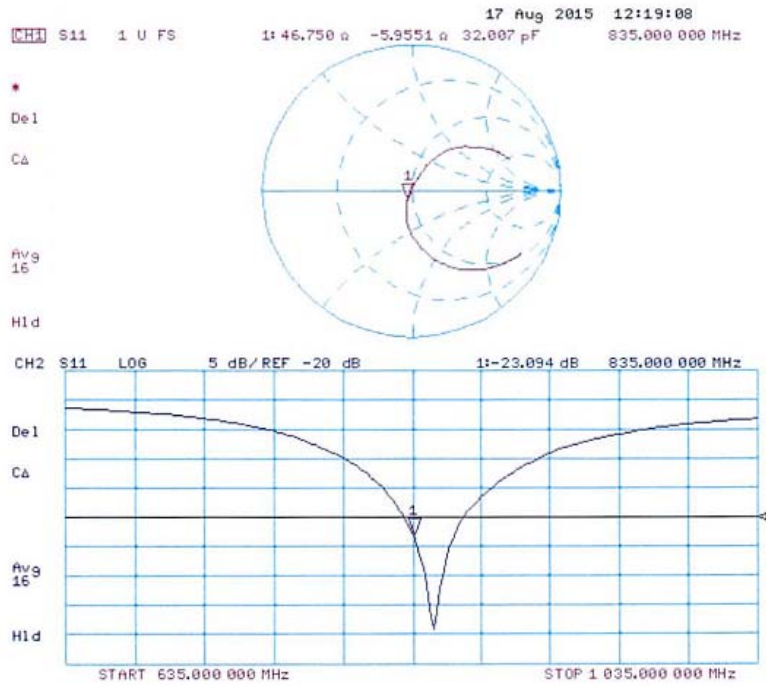

**Calibration Laboratory of  
Schmid & Partner  
Engineering AG**  
Zeughausstrasse 43, 8004 Zurich, Switzerland



**S** Schweizerischer Kalibrierdienst  
**C** Service suisse d'étalonnage  
**S** Servizio svizzero di taratura  
**S** Swiss Calibration Service

Accredited by the Swiss Accreditation Service (SAS)  
The Swiss Accreditation Service is one of the signatories to the EA  
Multilateral Agreement for the recognition of calibration certificates

Accreditation No.: **SCS 0108**

Client **BACL**

Certificate No: **D1900V2-5d206\_Jul15**

## CALIBRATION CERTIFICATE

Object **D1900V2 - SN:5d206**

Calibration procedure(s) **QA CAL-05.v9  
Calibration procedure for dipole validation kits above 700 MHz**

Calibration date: **July 14, 2015**

This calibration certificate documents the traceability to national standards, which realize the physical units of measurements (SI).  
The measurements and the uncertainties with confidence probability are given on the following pages and are part of the certificate.

All calibrations have been conducted in the closed laboratory facility: environment temperature (22 ± 3)°C and humidity < 70%.

Calibration Equipment used (M&TE critical for calibration)

Primary Standards	ID #	Cal Date (Certificate No.)	Scheduled Calibration
Power meter EPM-442A	GB37480704	07-Oct-14 (No. 217-02020)	Oct-15
Power sensor HP 8481A	US37292783	07-Oct-14 (No. 217-02020)	Oct-15
Power sensor HP 8481A	MY41092317	07-Oct-14 (No. 217-02021)	Oct-15
Reference 20 dB Attenuator	SN: 5058 (20k)	01-Apr-15 (No. 217-02131)	Mar-16
Type-N mismatch combination	SN: 5047.2 / 06327	01-Apr-15 (No. 217-02134)	Mar-16
Reference Probe ES3DV3	SN: 3205	30-Dec-14 (No. ES3-3205_Dec14)	Dec-15
DAE4	SN: 601	18-Aug-14 (No. DAE4-601_Aug14)	Aug-15
Secondary Standards	ID #	Check Date (in house)	Scheduled Check
RF generator R&S SMT-06	100005	04-Aug-99 (in house check Oct-13)	In house check: Oct-16
Network Analyzer HP 8753E	US37390585 S4206	18-Oct-01 (in house check Oct-14)	In house check: Oct-15

Calibrated by:	Name Leif Klysnar	Function Laboratory Technician	Signature 
Approved by:	Name Katja Pokovic	Function Technical Manager	Signature 

Issued: July 14, 2015

This calibration certificate shall not be reproduced except in full without written approval of the laboratory.



**Calibration Laboratory of  
Schmid & Partner  
Engineering AG**  
Zeughausstrasse 43, 8004 Zurich, Switzerland



**S** Schweizerischer Kalibrierdienst  
**C** Service suisse d'étalonnage  
**S** Servizio svizzero di taratura  
**S** Swiss Calibration Service

Accredited by the Swiss Accreditation Service (SAS)  
The Swiss Accreditation Service is one of the signatories to the EA  
Multilateral Agreement for the recognition of calibration certificates

Accreditation No.: **SCS 0108**

**Glossary:**

TSL tissue simulating liquid  
ConvF sensitivity in TSL / NORM x,y,z  
N/A not applicable or not measured

**Calibration is Performed According to the Following Standards:**

- a) IEEE Std 1528-2013, "IEEE Recommended Practice for Determining the Peak Spatial-Averaged Specific Absorption Rate (SAR) in the Human Head from Wireless Communications Devices: Measurement Techniques", June 2013
- b) IEC 62209-1, "Procedure to measure the Specific Absorption Rate (SAR) for hand-held devices used in close proximity to the ear (frequency range of 300 MHz to 3 GHz)", February 2005
- c) IEC 62209-2, "Procedure to determine the Specific Absorption Rate (SAR) for wireless communication devices used in close proximity to the human body (frequency range of 30 MHz to 6 GHz)", March 2010
- d) KDB 865664, "SAR Measurement Requirements for 100 MHz to 6 GHz"

**Additional Documentation:**

- e) DASY4/5 System Handbook

**Methods Applied and Interpretation of Parameters:**

- *Measurement Conditions:* Further details are available from the Validation Report at the end of the certificate. All figures stated in the certificate are valid at the frequency indicated.
- *Antenna Parameters with TSL:* The dipole is mounted with the spacer to position its feed point exactly below the center marking of the flat phantom section, with the arms oriented parallel to the body axis.
- *Feed Point Impedance and Return Loss:* These parameters are measured with the dipole positioned under the liquid filled phantom. The impedance stated is transformed from the measurement at the SMA connector to the feed point. The Return Loss ensures low reflected power. No uncertainty required.
- *Electrical Delay:* One-way delay between the SMA connector and the antenna feed point. No uncertainty required.
- *SAR measured:* SAR measured at the stated antenna input power.
- *SAR normalized:* SAR as measured, normalized to an input power of 1 W at the antenna connector.
- *SAR for nominal TSL parameters:* The measured TSL parameters are used to calculate the nominal SAR result.

The reported uncertainty of measurement is stated as the standard uncertainty of measurement multiplied by the coverage factor  $k=2$ , which for a normal distribution corresponds to a coverage probability of approximately 95%.

**Measurement Conditions**

DASY system configuration, as far as not given on page 1.

<b>DASY Version</b>	DASY5	V52.8.8
<b>Extrapolation</b>	Advanced Extrapolation	
<b>Phantom</b>	Modular Flat Phantom	
<b>Distance Dipole Center - TSL</b>	10 mm	with Spacer
<b>Zoom Scan Resolution</b>	dx, dy, dz = 5 mm	
<b>Frequency</b>	1900 MHz ± 1 MHz	

**Head TSL parameters**

The following parameters and calculations were applied.

	Temperature	Permittivity	Conductivity
<b>Nominal Head TSL parameters</b>	22.0 °C	40.0	1.40 mho/m
<b>Measured Head TSL parameters</b>	(22.0 ± 0.2) °C	39.7 ± 6 %	1.38 mho/m ± 6 %
<b>Head TSL temperature change during test</b>	< 0.5 °C	----	----

**SAR result with Head TSL**

<b>SAR averaged over 1 cm<sup>3</sup> (1 g) of Head TSL</b>	Condition	
SAR measured	250 mW input power	10.1 W/kg
SAR for nominal Head TSL parameters	normalized to 1W	<b>40.7 W/kg ± 17.0 % (k=2)</b>

<b>SAR averaged over 10 cm<sup>3</sup> (10 g) of Head TSL</b>	condition	
SAR measured	250 mW input power	5.35 W/kg
SAR for nominal Head TSL parameters	normalized to 1W	<b>21.5 W/kg ± 16.5 % (k=2)</b>

**Body TSL parameters**

The following parameters and calculations were applied.

	Temperature	Permittivity	Conductivity
<b>Nominal Body TSL parameters</b>	22.0 °C	53.3	1.52 mho/m
<b>Measured Body TSL parameters</b>	(22.0 ± 0.2) °C	52.7 ± 6 %	1.54 mho/m ± 6 %
<b>Body TSL temperature change during test</b>	< 0.5 °C	----	----

**SAR result with Body TSL**

<b>SAR averaged over 1 cm<sup>3</sup> (1 g) of Body TSL</b>	Condition	
SAR measured	250 mW input power	10.3 W/kg
SAR for nominal Body TSL parameters	normalized to 1W	<b>40.8 W/kg ± 17.0 % (k=2)</b>

<b>SAR averaged over 10 cm<sup>3</sup> (10 g) of Body TSL</b>	condition	
SAR measured	250 mW input power	5.51 W/kg
SAR for nominal Body TSL parameters	normalized to 1W	<b>21.9 W/kg ± 16.5 % (k=2)</b>

**Appendix (Additional assessments outside the scope of SCS 0108)**

**Antenna Parameters with Head TSL**

Impedance, transformed to feed point	52.5 $\Omega$ + 6.5 j $\Omega$
Return Loss	- 23.3 dB

**Antenna Parameters with Body TSL**

Impedance, transformed to feed point	48.6 $\Omega$ + 7.1 j $\Omega$
Return Loss	- 22.8 dB

**General Antenna Parameters and Design**

Electrical Delay (one direction)	1.203 ns
----------------------------------	----------

After long term use with 100W radiated power, only a slight warming of the dipole near the feedpoint can be measured.

The dipole is made of standard semirigid coaxial cable. The center conductor of the feeding line is directly connected to the second arm of the dipole. The antenna is therefore short-circuited for DC-signals. On some of the dipoles, small end caps are added to the dipole arms in order to improve matching when loaded according to the position as explained in the "Measurement Conditions" paragraph. The SAR data are not affected by this change. The overall dipole length is still according to the Standard.

No excessive force must be applied to the dipole arms, because they might bend or the soldered connections near the feedpoint may be damaged.

**Additional EUT Data**

Manufactured by	SPEAG
Manufactured on	October 21, 2014

## DASY5 Validation Report for Head TSL

Date: 14.07.2015

Test Laboratory: SPEAG, Zurich, Switzerland

**DUT: Dipole 1900 MHz; Type: D1900V2; Serial: D1900V2 - SN:5d206**

Communication System: UID 0 - CW; Frequency: 1900 MHz

Medium parameters used:  $f = 1900$  MHz;  $\sigma = 1.38$  S/m;  $\epsilon_r = 39.7$ ;  $\rho = 1000$  kg/m<sup>3</sup>

Phantom section: Flat Section

Measurement Standard: DASY5 (IEEE/IEC/ANSI C63.19-2011)

DASY52 Configuration:

- Probe: ES3DV3 - SN3205; ConvF(5, 5, 5); Calibrated: 30.12.2014;
- Sensor-Surface: 3mm (Mechanical Surface Detection)
- Electronics: DAE4 Sn601; Calibrated: 18.08.2014
- Phantom: Flat Phantom 5.0 (front); Type: QD000P50AA; Serial: 1001
- DASY52 52.8.8(1222); SEMCAD X 14.6.10(7331)

### Dipole Calibration for Head Tissue/Pin=250 mW, d=10mm/Zoom Scan (7x7x7)/Cube 0:

Measurement grid: dx=5mm, dy=5mm, dz=5mm

Reference Value = 99.02 V/m; Power Drift = 0.02 dB

Peak SAR (extrapolated) = 18.4 W/kg

**SAR(1 g) = 10.1 W/kg; SAR(10 g) = 5.35 W/kg**

Maximum value of SAR (measured) = 12.8 W/kg

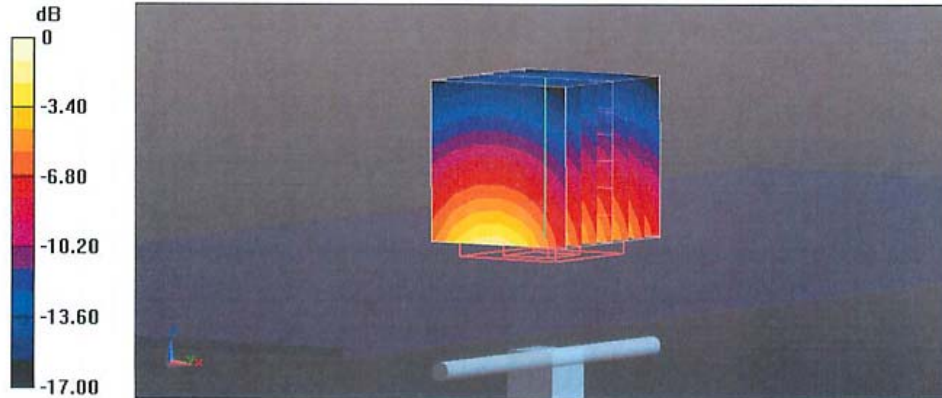

### Impedance Measurement Plot for Head TSL

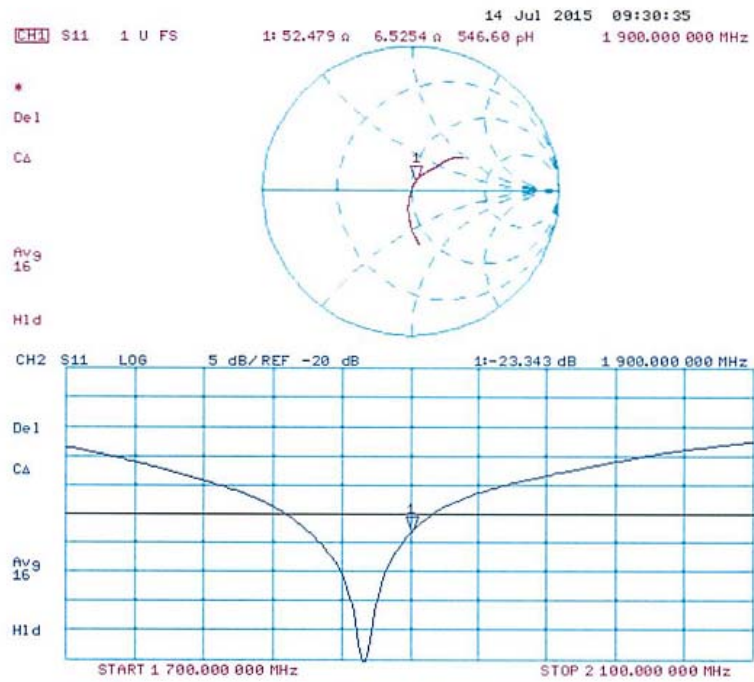



## DASY5 Validation Report for Body TSL

Date: 14.07.2015

Test Laboratory: SPEAG, Zurich, Switzerland

**DUT: Dipole 1900 MHz; Type: D1900V2; Serial: D1900V2 - SN:5d206**

Communication System: UID 0 - CW; Frequency: 1900 MHz

Medium parameters used:  $f = 1900$  MHz;  $\sigma = 1.54$  S/m;  $\epsilon_r = 52.7$ ;  $\rho = 1000$  kg/m<sup>3</sup>

Phantom section: Flat Section

Measurement Standard: DASY5 (IEEE/IEC/ANSI C63.19-2011)

DASY52 Configuration:

- Probe: ES3DV3 - SN3205; ConvF(4.65, 4.65, 4.65); Calibrated: 30.12.2014;
- Sensor-Surface: 3mm (Mechanical Surface Detection)
- Electronics: DAE4 Sn601; Calibrated: 18.08.2014
- Phantom: Flat Phantom 5.0 (back); Type: QD000P50AA; Serial: 1002
- DASY52 52.8.8(1222); SEMCAD X 14.6.10(7331)

### Dipole Calibration for Body Tissue/Pin=250 mW, d=10mm/Zoom Scan (7x7x7)/Cube 0:

Measurement grid: dx=5mm, dy=5mm, dz=5mm

Reference Value = 95.62 V/m; Power Drift = 0.02 dB

Peak SAR (extrapolated) = 17.3 W/kg

**SAR(1 g) = 10.3 W/kg; SAR(10 g) = 5.51 W/kg**

Maximum value of SAR (measured) = 12.9 W/kg

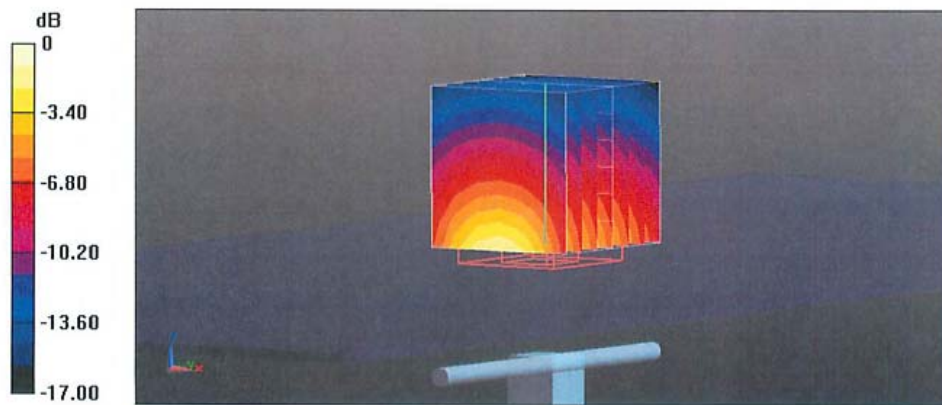

0 dB = 12.9 W/kg = 11.11 dBW/kg



### Impedance Measurement Plot for Body TSL

14 Jul 2015 09:29:57  
CHI S11 1 U FS 1: 48.594  $\Omega$  7.0527  $\mu$  598.78 pF 1 900.000 000 MHz

\*  
De1  
CA

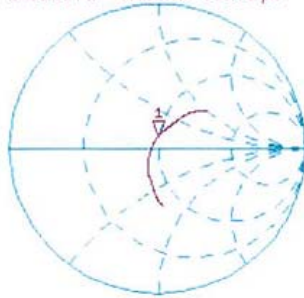

Avg  
16

H1d

CH2 S11 LOG 5 dB/REF -20 dB 1:-22.760 dB 1 900.000 000 MHz

De1

CA

Avg  
16

H1d

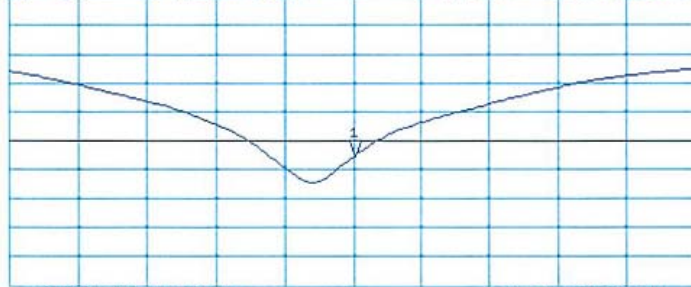

START 1 700.000 000 MHz

STOP 2 100.000 000 MHz