

MMI BOARD WDS052 V01  
 CIE 287986941  
 CIU 287986954  
 2020.08.10

DATE	08/12/2017
NOMNAME	SCHEMATIC
VERIFIE	CHECKED
NUMERO DU DOCUMENT	1 / 9
FORMAT	A2
TYPE	
VERS. REV.	
LIBELLE	MT623P
DENOMINATION	
R.FAB/P.N.	

A

B

C

D

A

B

C

D

U101

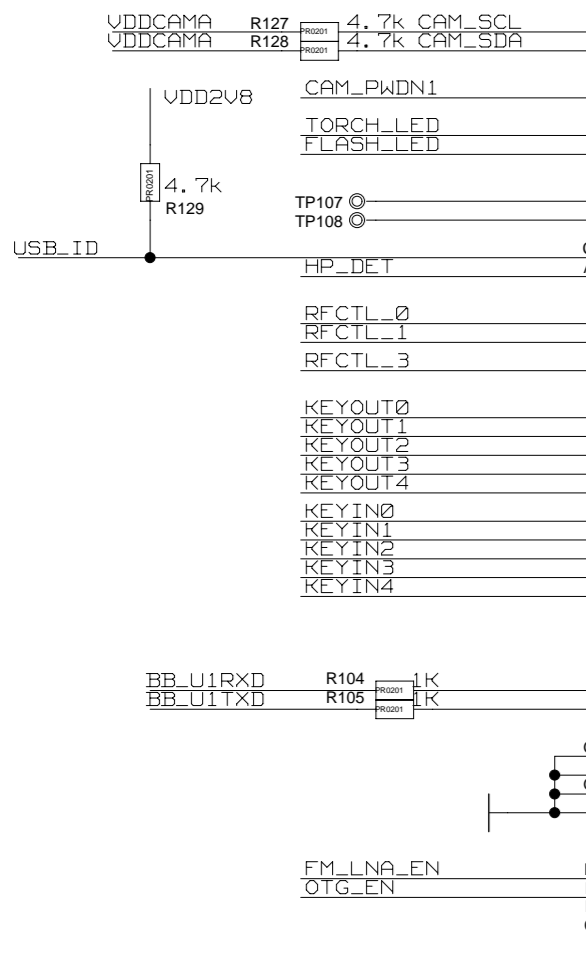
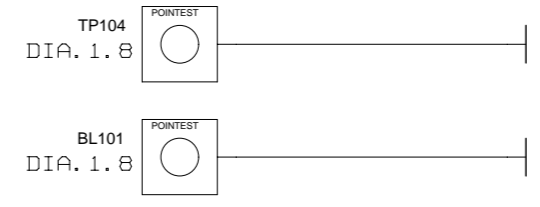
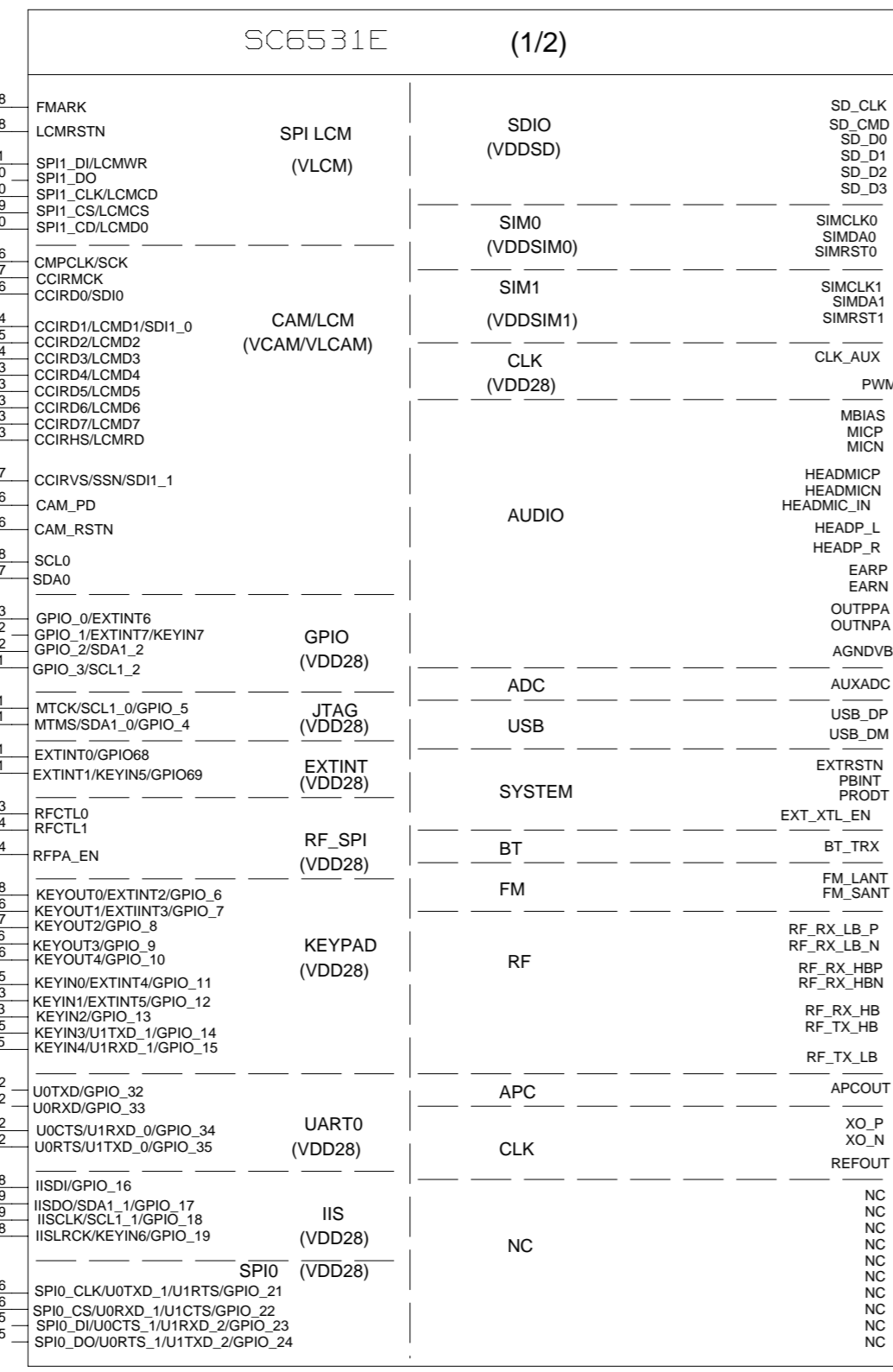





4

3

2

1

A

B

C

D

4

3

2

1

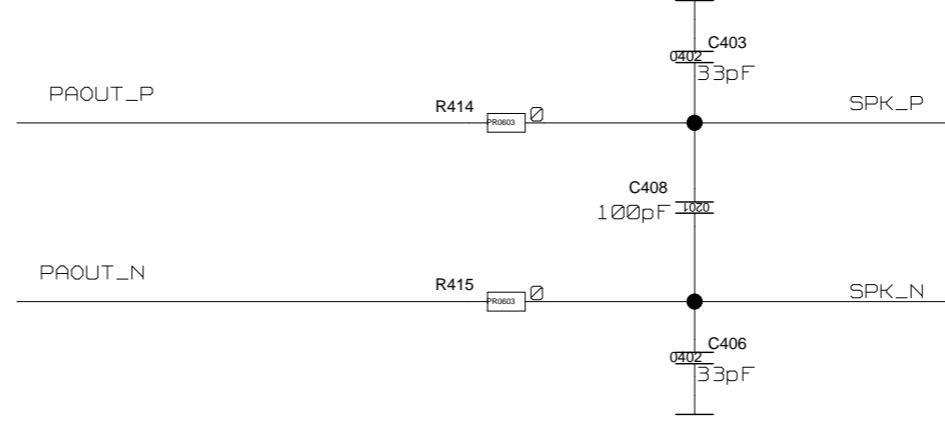
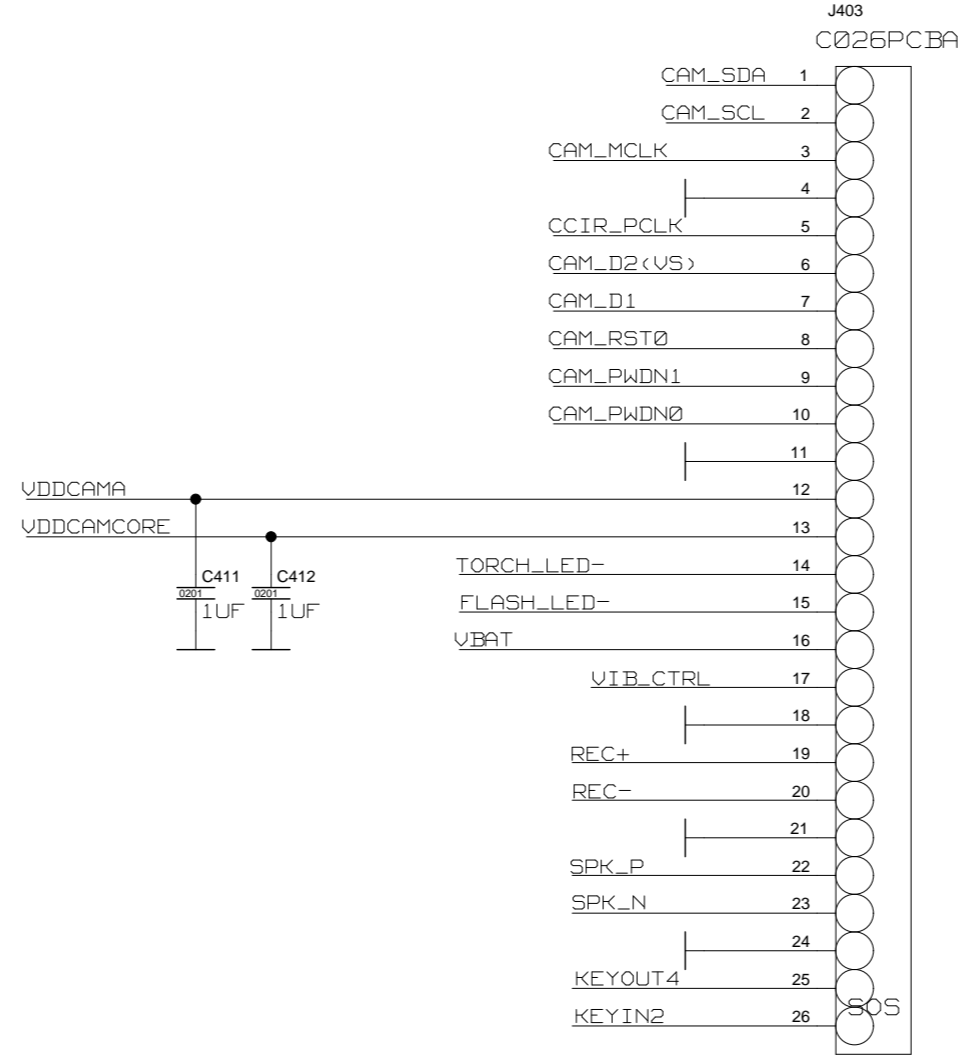
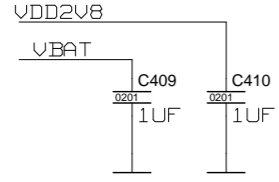
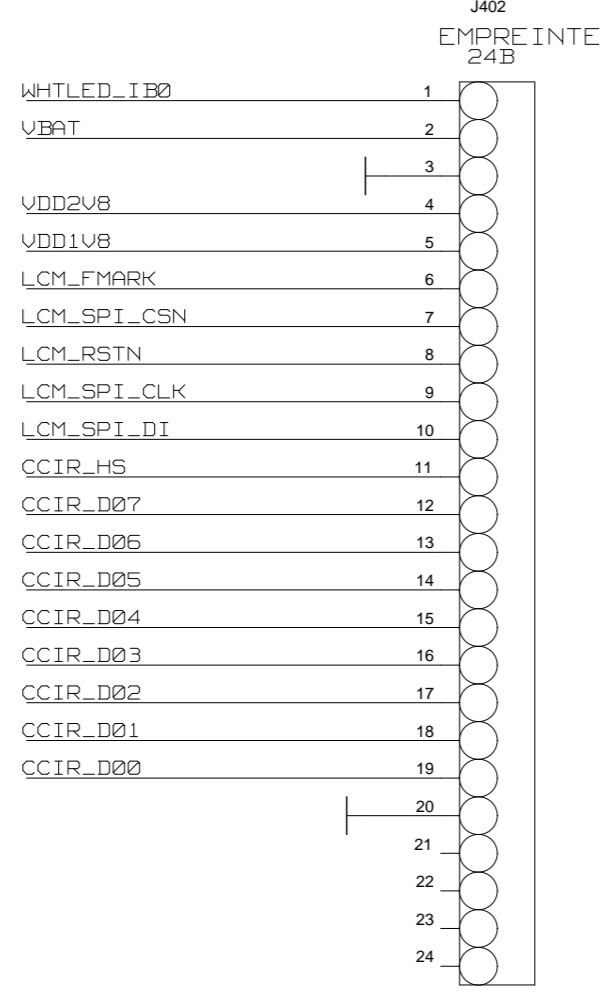

MODIFIE	NOM/NAME	DATE	VERIFIE	NOM/NAME	DATE
MODIFIED	SCHMATIC	08/12/2017	CHECKED		
	LIBELLE				
	LCD				
	DENOMINATION				
	R.FAB/P.N.				
	FORMAT SIZE				
	A2				
	NUMERO DU DOCUMENT				
	DRAWING NUMBER				
	TYPE				
	PART				
	VERS. REV.				



