

## FCC Test Report

**Report No.:** RF171227D04-5

**FCC ID:** PPQIC3A

**Test Model:** EZ-0762-0A31

**Received Date:** Dec. 27, 2017

**Test Date:** Jan. 8 ~ 18, 2018

**Issued Date:** Jan. 22, 2018

**Applicant:** Lite-On Technology Corporation

**Address:** 90,Chien I Road, Chung Ho, Taipei Hsien, Taiwan, R.O.C

**Issued By:** Bureau Veritas Consumer Products Services (H.K.) Ltd., Taoyuan Branch

**Lab Address:** No. 47-2, 14th Ling, Chia Pau Vil., Lin Kou Dist., New Taipei City, Taiwan (R.O.C.)

**FCC Registration /  
Designation Number:** 198487 / TW2021



This report is for your exclusive use. Any copying or replication of this report to or for any other person or entity, or use of our name or trademark, is permitted only with our prior written permission. This report sets forth our findings solely with respect to the test samples identified herein. The results set forth in this report are not indicative or representative of the quality or characteristics of the lot from which a test sample was taken or any similar or identical product unless specifically and expressly noted. Our report includes all of the tests requested by you and the results thereof based upon the information that you provided to us. You have 60 days from date of issuance of this report to notify us of any material error or omission caused by our negligence, provided, however, that such notice shall be in writing and shall specifically address the issue you wish to raise. A failure to raise such issue within the prescribed time shall constitute your unqualified acceptance of the completeness of this report, the tests conducted and the correctness of the report contents. Unless specific mention, the uncertainty of measurement has been explicitly taken into account to declare the compliance or non-compliance to the specification. The report must not be used by the client to claim product certification, approval, or endorsement by TAF or any government agencies.

## Table of Contents

<b>Release Control Record</b> .....	<b>4</b>
<b>1 Certificate of Conformity</b> .....	<b>5</b>
<b>2 Summary of Test Results</b> .....	<b>6</b>
2.1 Measurement Uncertainty .....	6
2.2 Modification Record .....	6
<b>3 General Information</b> .....	<b>7</b>
3.1 General Description of EUT .....	7
3.2 Description of Test Modes .....	8
3.2.1 Test Mode Applicability and Tested Channel Detail .....	9
3.3 Duty Cycle of Test Signal .....	11
3.4 Description of Support Units .....	12
3.4.1 Configuration of System under Test .....	12
3.5 General Description of Applied Standards .....	13
<b>4 Test Types and Results</b> .....	<b>14</b>
4.1 Radiated Emission and Bandedge Measurement.....	14
4.1.1 Limits of Radiated Emission and Bandedge Measurement .....	14
4.1.2 Test Instruments .....	15
4.1.3 Test Procedures.....	16
4.1.4 Deviation from Test Standard .....	16
4.1.5 Test Setup.....	17
4.1.6 EUT Operating Conditions.....	18
4.1.7 Test Results .....	19
4.2 Conducted Emission Measurement .....	40
4.2.1 Limits of Conducted Emission Measurement .....	40
4.2.2 Test Instruments .....	40
4.2.3 Test Procedures.....	41
4.2.4 Deviation from Test Standard .....	41
4.2.5 Test Setup.....	41
4.2.6 EUT Operating Conditions.....	41
4.2.7 Test Results .....	42
4.3 6dB Bandwidth Measurement .....	44
4.3.1 Limits of 6dB Bandwidth Measurement .....	44
4.3.2 Test Setup.....	44
4.3.3 Test Instruments .....	44
4.3.4 Test Procedure .....	44
4.3.5 Deviation from Test Standard .....	44
4.3.6 EUT Operating Conditions.....	44
4.3.7 Test Result.....	45
4.4 Conducted Output Power Measurement.....	47
4.4.1 Limits of Conducted Output Power Measurement .....	47
4.4.2 Test Setup.....	47
4.4.3 Test Instruments .....	47
4.4.4 Test Procedures.....	47
4.4.5 Deviation from Test Standard .....	47
4.4.6 EUT Operating Conditions.....	47
4.4.7 Test Results .....	48
4.5 Power Spectral Density Measurement.....	50
4.5.1 Limits of Power Spectral Density Measurement .....	50
4.5.2 Test Setup.....	50
4.5.3 Test Instruments .....	50
4.5.4 Test Procedure .....	50
4.5.5 Deviation from Test Standard .....	50

4.5.6 EUT Operating Condition .....	50
4.5.7 Test Results .....	51
4.6 Conducted Out of Band Emission Measurement.....	53
4.6.1 Limits of Conducted Out of Band Emission Measurement.....	53
4.6.2 Test Setup.....	53
4.6.3 Test Instruments .....	53
4.6.4 Test Procedure .....	53
4.6.5 Deviation from Test Standard .....	53
4.6.6 EUT Operating Condition .....	53
4.6.7 Test Results .....	53
<b>5 Pictures of Test Arrangements.....</b>	<b>58</b>
<b>Appendix – Information on the Testing Laboratories .....</b>	<b>59</b>

### Release Control Record

Issue No.	Description	Date Issued
RF171227D04-5	Original release.	Jan. 22, 2018

## 1 Certificate of Conformity

**Product:** Network Board

**Brand:** LITE-ON

**Test Model:** EZ-0762-0A31

**Sample Status:** Engineering sample

**Applicant:** Lite-On Technology Corporation

**Test Date:** Jan. 8 ~ 18, 2018

**Standards:** 47 CFR FCC Part 15, Subpart C (Section 15.247)  
ANSI C63.10: 2013

The above equipment has been tested by **Bureau Veritas Consumer Products Services (H.K.) Ltd., Taoyuan Branch**, and found compliance with the requirement of the above standards. The test record, data evaluation & Equipment Under Test (EUT) configurations represented herein are true and accurate accounts of the measurements of the sample's EMC characteristics under the conditions specified in this report.

**Prepared by :**           *Annie Chang*          , **Date:**           Jan. 22, 2018            
Annie Chang / Senior Specialist

**Approved by :**           *Rex Lai*          , **Date:**           Jan. 22, 2018            
Rex Lai / Associate Technical Manager

## 2 Summary of Test Results

47 CFR FCC Part 15, Subpart C (SECTION 15.247)			
FCC Clause	Test Item	Result	Remarks
15.207	AC Power Conducted Emission	PASS	Meet the requirement of limit. Minimum passing margin is -8.03dB at 0.46641MHz.
15.205 / 15.209 / 15.247(d)	Radiated Emissions and Band Edge Measurement	PASS	Meet the requirement of limit. Minimum passing margin is -1.07dB at 2390.00MHz.
15.247(d)	Antenna Port Emission	PASS	Meet the requirement of limit.
15.247(a)(2)	6dB bandwidth	PASS	Meet the requirement of limit.
15.247(b)	Conducted power	PASS	Meet the requirement of limit.
15.247(e)	Power Spectral Density	PASS	Meet the requirement of limit.
15.203	Antenna Requirement	Pass	No antenna connector is used.

### 2.1 Measurement Uncertainty

Where relevant, the following measurement uncertainty levels have been estimated for tests performed on the EUT as specified in CISPR 16-4-2:

Measurement	Frequency	Expanded Uncertainty (k=2) ( $\pm$ )
Conducted Emissions at mains ports	150kHz ~ 30MHz	2.77 dB
Radiated Emissions up to 1 GHz	9kHz ~ 30MHz	2.38 dB
	30MHz ~ 1000MHz	5.54 dB
Radiated Emissions above 1 GHz	Above 1GHz	5.48 dB

### 2.2 Modification Record

There were no modifications required for compliance.

### 3 General Information

#### 3.1 General Description of EUT

Product	Network Board
Brand	LITE-ON
Test Model	EZ-0762-0A31
Status of EUT	Engineering sample
Power Supply Rating	12Vdc from adapter
Modulation Type	CCK, DQPSK, DBPSK for DSSS 64QAM, 16QAM, QPSK, BPSK for OFDM
Modulation Technology	DSSS, OFDM
Transfer Rate	802.11b: 11.0/ 5.5/ 2.0/ 1.0Mbps 802.11g: 54.0/ 48.0/ 36.0/ 24.0/ 18.0/ 12.0/ 9.0/ 6.0Mbps 802.11n: up to 150Mbps
Operating Frequency	2.412 ~ 2.462GHz
Number of Channel	11 for 802.11b, 802.11g, 802.11n (20MHz), 7 for 802.11n (40MHz)
Output Power	61.944mW
Antenna Type	PCB Antenna with 2dBi gain
Antenna Connector	N/A
Accessory Device	N/A
Data Cable Supplied	N/A

**Note:**

- The EUT incorporates a SISO function. Physically, the EUT provides 1 completed transmitter and 1 receiver.

Modulation Mode	TX Function
802.11b	1TX
802.11g	1TX
802.11n (20MHz)	1TX
802.11n (40MHz)	1TX

- The above EUT information is declared by manufacturer and for more detailed features description, please refer to the manufacturer's specifications or user's manual.

### 3.2 Description of Test Modes

11 channels are provided for 802.11b, 802.11g and 802.11n (20MHz):

Channel	Frequency	Channel	Frequency
1	2412MHz	7	2442MHz
2	2417MHz	8	2447MHz
3	2422MHz	9	2452MHz
4	2427MHz	10	2457MHz
5	2432MHz	11	2462MHz
6	2437MHz		

7 channels are provided for 802.11n (40MHz):

Channel	Frequency	Channel	Frequency
3	2422MHz	7	2442MHz
4	2427MHz	8	2447MHz
5	2432MHz	9	2452MHz
6	2437MHz		



### 3.2.1 Test Mode Applicability and Tested Channel Detail

EUT CONFIGURE MODE	APPLICABLE TO				DESCRIPTION
	RE $\geq$ 1G	RE $<$ 1G	PLC	APCM	
-	√	√	√	√	-

Where RE $\geq$ 1G: Radiated Emission above 1GHz & Bandedge Measurement

RE $<$ 1G: Radiated Emission below 1GHz

PLC: Power Line Conducted Emission

APCM: Antenna Port Conducted Measurement

**NOTE:** The EUT had been pre-tested on the positioned of each 3 axis. The worst case was found when positioned on **Y-plane**.

#### Radiated Emission Test (Above 1GHz):

- Pre-Scan has been conducted to determine the worst-case mode from all possible combinations between available modulations, data rates and antenna ports (if EUT with antenna diversity architecture).
- Following channel(s) was (were) selected for the final test as listed below.

EUT CONFIGURE MODE	MODE	AVAILABLE CHANNEL	TESTED CHANNEL	MODULATION TECHNOLOGY	MODULATION TYPE	DATA RATE (Mbps)
-	802.11b	1 to 11	1, 2, 6, 10, 11	DSSS	DBPSK	1
-	802.11g	1 to 11	1, 2, 6, 10, 11	OFDM	BPSK	6
-	802.11n (20MHz)	1 to 11	1, 2, 6, 10, 11	OFDM	BPSK	6.5
-	802.11n (40MHz)	3 to 9	3, 4, 6, 8, 9	OFDM	BPSK	13.5

Note: The CH2/10/4/8 only perform the bandedge item for Radiated Emission Test (Above 1GHz).

#### Radiated Emission Test (Below 1GHz):

- Pre-Scan has been conducted to determine the worst-case mode from all possible combinations between available modulations, data rates and antenna ports (if EUT with antenna diversity architecture).
- Following channel(s) was (were) selected for the final test as listed below.

EUT CONFIGURE MODE	MODE	AVAILABLE CHANNEL	TESTED CHANNEL	MODULATION TECHNOLOGY	MODULATION TYPE	DATA RATE (Mbps)
-	802.11b	1 to 11	6	DSSS	DBPSK	1

#### Power Line Conducted Emission Test:

- Pre-Scan has been conducted to determine the worst-case mode from all possible combinations between available modulations, data rates and antenna ports (if EUT with antenna diversity architecture).
- Following channel(s) was (were) selected for the final test as listed below.

EUT CONFIGURE MODE	MODE	AVAILABLE CHANNEL	TESTED CHANNEL	MODULATION TECHNOLOGY	MODULATION TYPE	DATA RATE (Mbps)
-	802.11b	1 to 11	6	DSSS	DBPSK	1

### Antenna Port Conducted Measurement:

- This item includes all test value of each mode, but only includes spectrum plot of worst value of each mode.
- Pre-Scan has been conducted to determine the worst-case mode from all possible combinations between available modulations, data rates and antenna ports (if EUT with antenna diversity architecture).
- Following channel(s) was (were) selected for the final test as listed below.

EUT CONFIGURE MODE	MODE	AVAILABLE CHANNEL	TESTED CHANNEL	MODULATION TECHNOLOGY	MODULATION TYPE	DATA RATE (Mbps)
-	802.11b	1 to 11	1, 6, 11	DSSS	DBPSK	1
-	802.11g	1 to 11	1, 6, 11	OFDM	BPSK	6
-	802.11n (20MHz)	1 to 11	1, 6, 11	OFDM	BPSK	6.5
-	802.11n (40MHz)	3 to 9	3, 6, 9	OFDM	BPSK	13.5
Output Power						
EUT CONFIGURE MODE	MODE	AVAILABLE CHANNEL	TESTED CHANNEL	MODULATION TECHNOLOGY	MODULATION TYPE	DATA RATE (Mbps)
-	802.11b	1 to 11	1, 2, 6, 10, 11	DSSS	DBPSK	1
-	802.11g	1 to 11	1, 2, 6, 10, 11	OFDM	BPSK	6
-	802.11n (20MHz)	1 to 11	1, 2, 6, 10, 11	OFDM	BPSK	6.5
-	802.11n (40MHz)	3 to 9	3, 4, 6, 8, 9	OFDM	BPSK	13.5

### Test Condition:

APPLICABLE TO	ENVIRONMENTAL CONDITIONS	INPUT POWER	TESTED BY
RE $\geq$ 1G	21deg. C, 73%RH	120Vac, 60Hz	James Wei
RE $<$ 1G	19deg. C, 73%RH	120Vac, 60Hz	James Wei
PLC	25deg. C, 75%RH	120Vac, 60Hz	Startaly Wu
APCM	25deg. C, 76%RH	120Vac, 60Hz	Saxon Lee

### 3.3 Duty Cycle of Test Signal

If duty cycle of test signal is 100 %, duty factor is not required.  
 If duty cycle of test signal is < 98%, duty factor shall be considered.

**802.11b:** Duty cycle of test signal is 100 %

**802.11g:** Duty cycle = Duty cycle of test signal is 100 %

**802.11n (20MHz):** Duty cycle = Duty cycle of test signal is 100 %

**802.11n (40MHz):** Duty cycle =  $0.612/0.790 = 0.775$ , Duty factor =  $10 * \log( 1/0.775) = 1.10$



### 3.4 Description of Support Units

The EUT has been tested as an independent unit together with other necessary accessories or support units. The following support units or accessories were used to form a representative test configuration during the tests.

No.	Product	Brand	Model No.	Serial No.	FCC ID	Remark
A.	Adapter	Lite-On	PB-1300-3AR1	N/A	N/A	Provided by Lab

Note: All power cords of the above support units are non-shielded (1.8m).

ID	Descriptions	Qty.	Length (m)	Shielding (Yes/No)	Cores (Qty.)	Remarks
1.	DC cable	1	1.5	N	0	Supplied by client
2.	LAN cable	1	2.5	N	0	Provided by Lab

Note: The core(s) is(are) originally attached to the cable(s).

#### 3.4.1 Configuration of System under Test

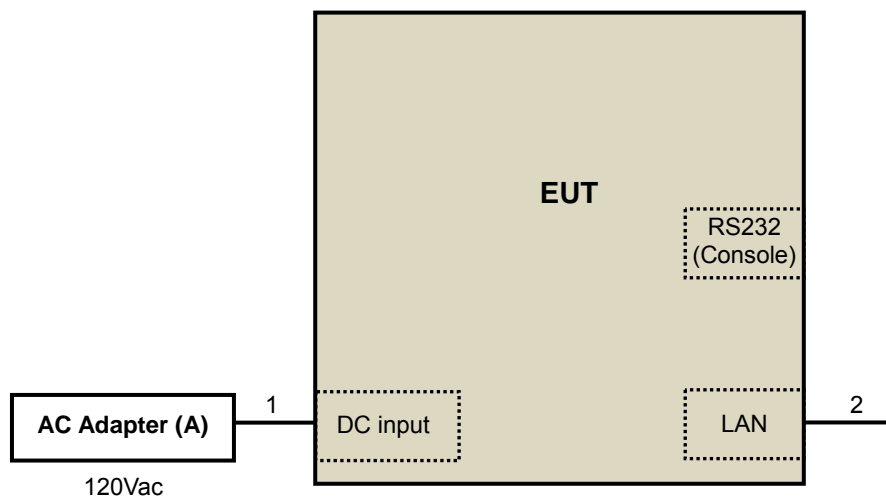

### 3.5 General Description of Applied Standards

The EUT is a RF Product. According to the specifications of the manufacturer, it must comply with the requirements of the following standards:

**FCC Part 15, Subpart C (15.247)**  
**KDB 558074 D01 DTS Meas Guidance v04**  
**ANSI C63.10-2013**

All test items have been performed and recorded as per the above standards.

## 4 Test Types and Results

### 4.1 Radiated Emission and Bandedge Measurement

#### 4.1.1 Limits of Radiated Emission and Bandedge Measurement

Radiated emissions which fall in the restricted bands must comply with the radiated emission limits specified as below table. Other emissions shall be at least 20dB below the highest level of the desired power:

Frequencies (MHz)	Field Strength (microvolts/meter)	Measurement Distance (meters)
0.009 ~ 0.490	2400/F(kHz)	300
0.490 ~ 1.705	24000/F(kHz)	30
1.705 ~ 30.0	30	30
30 ~ 88	100	3
88 ~ 216	150	3
216 ~ 960	200	3
Above 960	500	3

**NOTE:**

1. The lower limit shall apply at the transition frequencies.
2. Emission level (dBuV/m) = 20 log Emission level (uV/m).
3. For frequencies above 1000MHz, the field strength limits are based on average detector, however, the peak field strength of any emission shall not exceed the maximum permitted average limits, specified above by more than 20dB under any condition of modulation.

## 4.1.2 Test Instruments

DESCRIPTION & MANUFACTURER	MODEL NO.	SERIAL NO.	CALIBRATED DATE	CALIBRATED UNTIL
HP Preamplifier	8447D	2432A03504	Feb. 21, 2017	Feb. 20, 2018
HP Preamplifier	8449B	3008A01201	Feb. 22, 2017	Feb. 21, 2018
MITEQ Preamplifier	AMF-6F-260400-33-8P	892164	Feb. 21, 2017	Feb. 20, 2018
Agilent TEST RECEIVER	N9038A	MY51210129	Feb. 8, 2017	Feb. 7, 2018
Schwarzbeck Antenna	VULB 9168	139	Nov. 29, 2017	Nov. 28, 2018
Schwarzbeck Antenna	VHBA 9123	480	May 19, 2017	May 18, 2019
Schwarzbeck Horn Antenna	BBHA-9170	212	Dec. 1, 2017	Nov. 30, 2018
Schwarzbeck Horn Antenna	BBHA 9120-D1	D130	Dec. 1, 2017	Nov. 30, 2018
ADT. Turn Table	TT100	0306	NA	NA
ADT. Tower	AT100	0306	NA	NA
Software	Radiated_V7.6.15.9.5	NA	NA	NA
SUHNER RF cable With 4dB PAD	SF104	CABLE-CH6	Aug. 14, 2017	Aug. 13, 2018
SUHNER RF cable With 3dB PAD	SF102	Cable-CH8-3.6m	Aug. 14, 2017	Aug. 13, 2018
KEYSIGHT MIMO Powermeasurement Test set	U2021XA	U2021XA-001	May 31,2017	May 30,2018
KEYSIGHT Spectrum Analyzer	N9030A	MY54490260	Jul. 26, 2017	Jul. 25, 2018
Loop Antenna EMCI	LPA600	270	Aug. 11, 2017	Aug. 10, 2019
EMCO Horn Antenna	3115	00028257	Nov. 30, 2017	Nov. 29, 2018
Highpass filter Wainwright Instruments	WHK 3.1/18G-10SS	SN 8	NA	NA
ROHDE & SCHWARZ Spectrum Analyzer	FSV40	101042	Sep. 29, 2017	Sep. 28, 2018
Anritsu Power Sensor	MA2411B	0738404	Apr. 24, 2017	Apr. 23, 2018
Anritsu Power Meter	ML2495A	0842014	Apr. 24, 2017	Apr. 23, 2018

- NOTE:**
1. The calibration interval of the above test instruments is 12/24 months. And the calibrations are traceable to NML/ROC and NIST/USA.
  2. The horn antenna and HP preamplifier (model: 8449B) are used only for the measurement of emission frequency above 1GHz if tested.
  3. The test was performed in Chamber No. 6.
  4. The Industry Canada Reference No. IC 7450E-6.

#### 4.1.3 Test Procedures

##### **For Radiated emission below 30MHz**

- a. The EUT was placed on the top of a rotating table 0.8 meters above the ground at a 3 meter chamber room. The table was rotated 360 degrees to determine the position of the highest radiation.
- b. The EUT was set 3 meters away from the interference-receiving antenna, which was mounted on the top of a variable-height antenna tower.
- c. Parallel, Perpendicular and Ground-parallel of the antenna are set to make the measurement.
- d. For each suspected emission, the EUT was arranged to its worst case and the rotatable table was turned from 0 degrees to 360 degrees to find the maximum reading.
- e. The test-receiver system was set to Quasi-Peak Detect Function and Specified Bandwidth with Maximum Hold Mode.

##### **NOTE:**

1. The resolution bandwidth and video bandwidth of test receiver/spectrum analyzer is 9kHz at frequency below 30MHz.

##### **For Radiated emission above 30MHz**

- a. The EUT was placed on the top of a rotating table 0.8 meters (for 30MHz ~ 1GHz) / 1.5 meters (for above 1GHz) above the ground at 3 meter chamber room for test. The table was rotated 360 degrees to determine the position of the highest radiation.
- b. The EUT was set 3 meters away from the interference-receiving antenna, which was mounted on the top of a variable-height antenna tower.
- c. The height of antenna is varied from one meter to four meters above the ground to determine the maximum value of the field strength. Both horizontal and vertical polarizations of the antenna are set to make the measurement.
- d. For each suspected emission, the EUT was arranged to its worst case and then the antenna was tuned to heights from 1 meter to 4 meters and the rotatable table was turned from 0 degrees to 360 degrees to find the maximum reading.
- e. The test-receiver system was set to quasi-peak detect function and specified bandwidth with maximum hold mode when the test frequency is below 1 GHz.
- f. The test-receiver system was set to peak and average detect function and specified bandwidth with maximum hold mode when the test frequency is above 1 GHz. If the peak reading value also meets average limit, measurement with the average detector is unnecessary.

##### **Note:**

1. The resolution bandwidth and video bandwidth of test receiver/spectrum analyzer is 120kHz for Quasi-peak detection (QP) at frequency below 1GHz.
2. The resolution bandwidth of test receiver/spectrum analyzer is 1 MHz and the video bandwidth is 3 MHz for Peak detection (PK) at frequency above 1GHz.
3. The resolution bandwidth of test receiver/spectrum analyzer is 1 MHz and the video bandwidth is  $\geq 1/T$  (Duty cycle < 98%) or 3 x RBW (Duty cycle  $\geq 98\%$ ) for Average detection (AV) at frequency above 1GHz.
4. All modes of operation were investigated and the worst-case emissions are reported.

#### 4.1.4 Deviation from Test Standard

No deviation.



#### 4.1.5 Test Setup

##### For Radiated emission below 30MHz

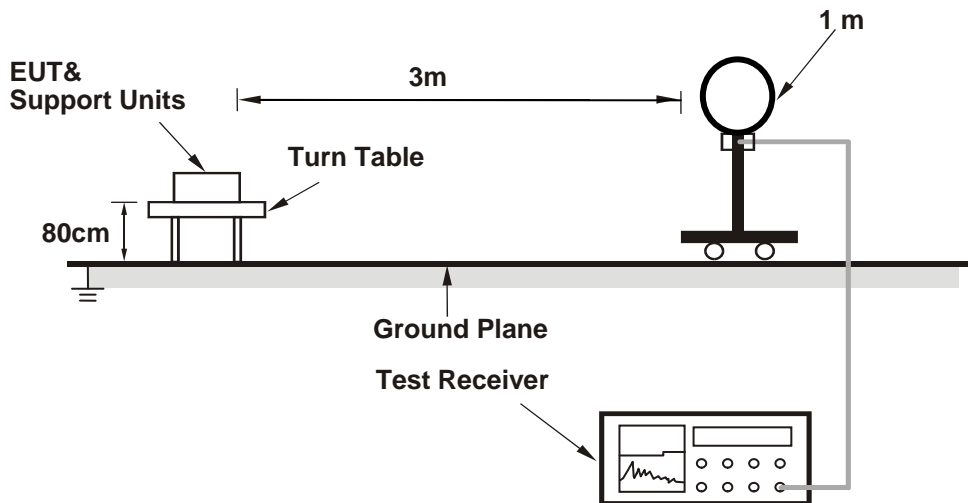

##### For Radiated emission 30MHz to 1GHz

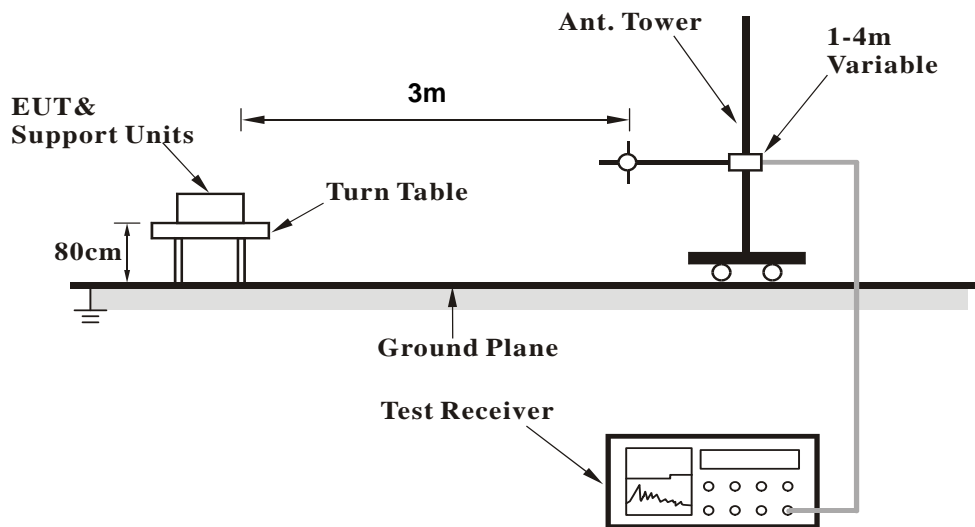

**For Radiated emission above 1GHz**

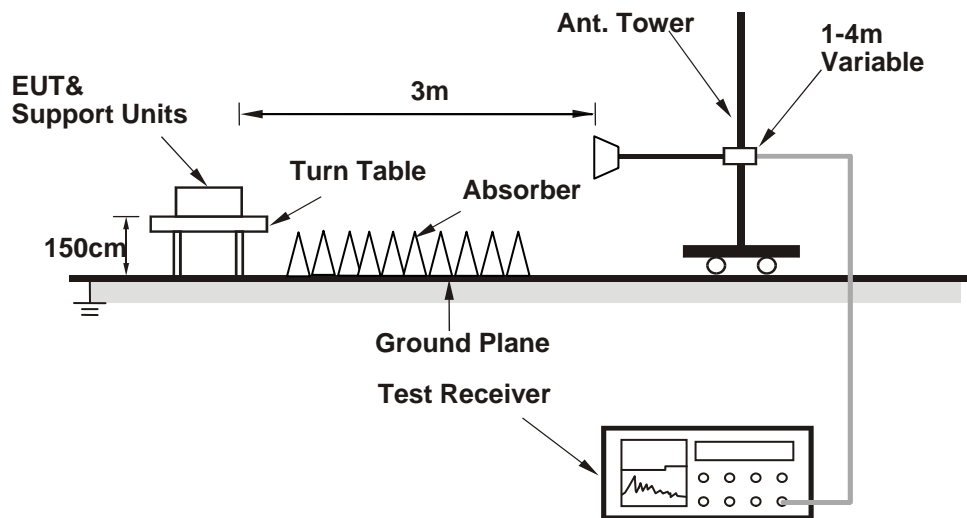

For the actual test configuration, please refer to the attached file (Test Setup Photo).

**4.1.6 EUT Operating Conditions**

- a. Connected the EUT with the Adapter.
- b. Set the EUT under transmission condition continuously at specific channel frequency.

## 4.1.7 Test Results

## ABOVE 1GHz DATA

## 802.11b

<b>CHANNEL</b>	TX Channel 1	<b>DETECTOR FUNCTION</b>	Peak (PK)
<b>FREQUENCY RANGE</b>	1GHz ~ 25GHz		Average (AV)

**ANTENNA POLARITY & TEST DISTANCE: HORIZONTAL AT 3 M**

NO.	FREQ. (MHz)	EMISSION LEVEL (dBuV/m)	LIMIT (dBuV/m)	MARGIN (dB)	ANTENNA HEIGHT (m)	TABLE ANGLE (Degree)	RAW VALUE (dBuV)	CORRECTION FACTOR (dB/m)
1	2390.00	59.10 PK	74.00	-14.90	1.00 H	229	61.41	-2.31
2	2390.00	52.77 AV	54.00	-1.23	1.00 H	229	55.08	-2.31
3	*2412.00	105.91 PK			1.00 H	229	108.08	-2.17
4	*2412.00	103.58 AV			1.00 H	229	105.75	-2.17
5	4824.00	46.41 PK	74.00	-27.59	1.16 H	262	42.25	4.16
6	4824.00	39.45 AV	54.00	-14.55	1.16 H	262	35.29	4.16

**ANTENNA POLARITY & TEST DISTANCE: VERTICAL AT 3 M**

NO.	FREQ. (MHz)	EMISSION LEVEL (dBuV/m)	LIMIT (dBuV/m)	MARGIN (dB)	ANTENNA HEIGHT (m)	TABLE ANGLE (Degree)	RAW VALUE (dBuV)	CORRECTION FACTOR (dB/m)
1	2390.00	56.58 PK	74.00	-17.42	1.27 V	162	58.89	-2.31
2	2390.00	47.86 AV	54.00	-6.14	1.27 V	162	50.17	-2.31
3	*2412.00	101.69 PK			1.27 V	162	103.86	-2.17
4	*2412.00	99.35 AV			1.27 V	162	101.52	-2.17
5	4824.00	46.17 PK	74.00	-27.83	3.36 V	85	42.01	4.16
6	4824.00	39.08 AV	54.00	-14.92	3.36 V	85	34.92	4.16

**REMARKS:**

1. Emission Level(dBuV/m) = Raw Value(dBuV) + Correction Factor(dB/m)
2. Correction Factor(dB/m) = Antenna Factor(dB/m) + Cable Factor(dB) – Pre-Amplifier Factor(dB)
3. The other emission levels were very low against the limit.
4. Margin value = Emission Level – Limit value
5. " \* ": Fundamental frequency.

<b>CHANNEL</b>	TX Channel 2	<b>DETECTOR FUNCTION</b>	Peak (PK)
<b>FREQUENCY RANGE</b>	1GHz ~ 25GHz		Average (AV)

**ANTENNA POLARITY & TEST DISTANCE: HORIZONTAL AT 3 M**

NO.	FREQ. (MHz)	EMISSION LEVEL (dBuV/m)	LIMIT (dBuV/m)	MARGIN (dB)	ANTENNA HEIGHT (m)	TABLE ANGLE (Degree)	RAW VALUE (dBuV)	CORRECTION FACTOR (dB/m)
1	2390.00	59.72 PK	74.00	-14.28	1.04 H	227	62.03	-2.31
2	<b>2390.00</b>	<b>52.93 AV</b>	<b>54.00</b>	<b>-1.07</b>	<b>1.04 H</b>	<b>227</b>	<b>55.24</b>	<b>-2.31</b>
3	*2417.00	106.53 PK			1.04 H	227	108.67	-2.14
4	*2417.00	104.19 AV			1.04 H	227	106.33	-2.14

**ANTENNA POLARITY & TEST DISTANCE: VERTICAL AT 3 M**

NO.	FREQ. (MHz)	EMISSION LEVEL (dBuV/m)	LIMIT (dBuV/m)	MARGIN (dB)	ANTENNA HEIGHT (m)	TABLE ANGLE (Degree)	RAW VALUE (dBuV)	CORRECTION FACTOR (dB/m)
1	2390.00	56.66 PK	74.00	-17.34	1.22 V	158	58.97	-2.31
2	2390.00	48.02 AV	54.00	-5.98	1.22 V	158	50.33	-2.31
3	*2417.00	101.82 PK			1.22 V	158	103.96	-2.14
4	*2417.00	99.47 AV			1.22 V	158	101.61	-2.14

**REMARKS:**

1. Emission Level(dBuV/m) = Raw Value(dBuV) + Correction Factor(dB/m)
2. Correction Factor(dB/m) = Antenna Factor(dB/m) + Cable Factor(dB) – Pre-Amplifier Factor(dB)
3. The other emission levels were very low against the limit.
4. Margin value = Emission Level – Limit value
5. " \* ": Fundamental frequency.

<b>CHANNEL</b>	TX Channel 6	<b>DETECTOR FUNCTION</b>	Peak (PK)
<b>FREQUENCY RANGE</b>	1GHz ~ 25GHz		Average (AV)

**ANTENNA POLARITY & TEST DISTANCE: HORIZONTAL AT 3 M**

NO.	FREQ. (MHz)	EMISSION LEVEL (dBuV/m)	LIMIT (dBuV/m)	MARGIN (dB)	ANTENNA HEIGHT (m)	TABLE ANGLE (Degree)	RAW VALUE (dBuV)	CORRECTION FACTOR (dB/m)
1	*2437.00	106.86 PK			1.00 H	229	108.87	-2.01
2	*2437.00	104.54 AV			1.00 H	229	106.55	-2.01
3	4874.00	48.08 PK	74.00	-25.92	1.15 H	281	43.83	4.25
4	4874.00	40.44 AV	54.00	-13.56	1.15 H	281	36.19	4.25

**ANTENNA POLARITY & TEST DISTANCE: VERTICAL AT 3 M**

NO.	FREQ. (MHz)	EMISSION LEVEL (dBuV/m)	LIMIT (dBuV/m)	MARGIN (dB)	ANTENNA HEIGHT (m)	TABLE ANGLE (Degree)	RAW VALUE (dBuV)	CORRECTION FACTOR (dB/m)
1	*2437.00	102.51 PK			1.33 V	151	104.52	-2.01
2	*2437.00	99.92 AV			1.33 V	151	101.93	-2.01
3	4874.00	46.36 PK	74.00	-27.64	3.35 V	66	42.11	4.25
4	4874.00	39.33 AV	54.00	-14.67	3.35 V	66	35.08	4.25

**REMARKS:**

1. Emission Level(dBuV/m) = Raw Value(dBuV) + Correction Factor(dB/m)
2. Correction Factor(dB/m) = Antenna Factor(dB/m) + Cable Factor(dB) – Pre-Amplifier Factor(dB)
3. The other emission levels were very low against the limit.
4. Margin value = Emission Level – Limit value
5. " \* ": Fundamental frequency.

<b>CHANNEL</b>	TX Channel 10	<b>DETECTOR FUNCTION</b>	Peak (PK)
<b>FREQUENCY RANGE</b>	1GHz ~ 25GHz		Average (AV)

**ANTENNA POLARITY & TEST DISTANCE: HORIZONTAL AT 3 M**

NO.	FREQ. (MHz)	EMISSION LEVEL (dBuV/m)	LIMIT (dBuV/m)	MARGIN (dB)	ANTENNA HEIGHT (m)	TABLE ANGLE (Degree)	RAW VALUE (dBuV)	CORRECTION FACTOR (dB/m)
1	*2457.00	105.86 PK			1.15 H	225	107.73	-1.87
2	*2457.00	103.54 AV			1.15 H	225	105.41	-1.87
3	2483.50	59.43 PK	74.00	-14.57	1.15 H	225	61.14	-1.71
4	2483.50	52.71 AV	54.00	-1.29	1.15 H	225	54.42	-1.71

**ANTENNA POLARITY & TEST DISTANCE: VERTICAL AT 3 M**

NO.	FREQ. (MHz)	EMISSION LEVEL (dBuV/m)	LIMIT (dBuV/m)	MARGIN (dB)	ANTENNA HEIGHT (m)	TABLE ANGLE (Degree)	RAW VALUE (dBuV)	CORRECTION FACTOR (dB/m)
1	*2457.00	101.96 PK			1.21 V	149	103.83	-1.87
2	*2457.00	99.88 AV			1.21 V	149	101.75	-1.87
3	2483.50	56.88 PK	74.00	-17.12	1.21 V	149	58.59	-1.71
4	2483.50	48.10 AV	54.00	-5.90	1.21 V	149	49.81	-1.71

**REMARKS:**

1. Emission Level(dBuV/m) = Raw Value(dBuV) + Correction Factor(dB/m)
2. Correction Factor(dB/m) = Antenna Factor(dB/m) + Cable Factor(dB) – Pre-Amplifier Factor(dB)
3. The other emission levels were very low against the limit.
4. Margin value = Emission Level – Limit value
5. " \* ": Fundamental frequency.

<b>CHANNEL</b>	TX Channel 11	<b>DETECTOR FUNCTION</b>	Peak (PK)
<b>FREQUENCY RANGE</b>	1GHz ~ 25GHz		Average (AV)

**ANTENNA POLARITY & TEST DISTANCE: HORIZONTAL AT 3 M**

NO.	FREQ. (MHz)	EMISSION LEVEL (dBuV/m)	LIMIT (dBuV/m)	MARGIN (dB)	ANTENNA HEIGHT (m)	TABLE ANGLE (Degree)	RAW VALUE (dBuV)	CORRECTION FACTOR (dB/m)
1	*2462.00	105.23 PK			1.19 H	229	107.08	-1.85
2	*2462.00	102.92 AV			1.19 H	229	104.77	-1.85
3	2483.50	59.82 PK	74.00	-14.18	1.19 H	229	61.53	-1.71
4	2483.50	52.92 AV	54.00	-1.08	1.19 H	229	54.63	-1.71
5	4924.00	46.48 PK	74.00	-27.52	1.18 H	259	42.18	4.30
6	4924.00	39.51 AV	54.00	-14.49	1.18 H	259	35.21	4.30

**ANTENNA POLARITY & TEST DISTANCE: VERTICAL AT 3 M**

NO.	FREQ. (MHz)	EMISSION LEVEL (dBuV/m)	LIMIT (dBuV/m)	MARGIN (dB)	ANTENNA HEIGHT (m)	TABLE ANGLE (Degree)	RAW VALUE (dBuV)	CORRECTION FACTOR (dB/m)
1	*2462.00	101.44 PK			1.22 V	157	103.29	-1.85
2	*2462.00	99.28 AV			1.22 V	157	101.13	-1.85
3	2483.50	57.04 PK	74.00	-16.96	1.22 V	157	58.75	-1.71
4	2483.50	48.32 AV	54.00	-5.68	1.22 V	157	50.03	-1.71
5	4924.00	46.18 PK	74.00	-27.82	3.41 V	88	41.88	4.30
6	4924.00	39.13 AV	54.00	-14.87	3.41 V	88	34.83	4.30

**REMARKS:**

1. Emission Level(dBuV/m) = Raw Value(dBuV) + Correction Factor(dB/m)
2. Correction Factor(dB/m) = Antenna Factor(dB/m) + Cable Factor(dB) – Pre-Amplifier Factor(dB)
3. The other emission levels were very low against the limit.
4. Margin value = Emission Level – Limit value
5. " \* ": Fundamental frequency.

**802.11g**

<b>CHANNEL</b>	TX Channel 1	<b>DETECTOR FUNCTION</b>	Peak (PK)
<b>FREQUENCY RANGE</b>	1GHz ~ 25GHz		Average (AV)

**ANTENNA POLARITY & TEST DISTANCE: HORIZONTAL AT 3 M**

NO.	FREQ. (MHz)	EMISSION LEVEL (dBuV/m)	LIMIT (dBuV/m)	MARGIN (dB)	ANTENNA HEIGHT (m)	TABLE ANGLE (Degree)	RAW VALUE (dBuV)	CORRECTION FACTOR (dB/m)
1	2390.00	69.62 PK	74.00	-4.38	1.00 H	220	71.60	-1.98
2	2390.00	52.13 AV	54.00	-1.87	1.00 H	220	54.11	-1.98
3	*2412.00	109.97 PK			1.00 H	220	112.09	-2.12
4	*2412.00	98.50 AV			1.00 H	220	100.62	-2.12
5	4824.00	44.54 PK	74.00	-29.46	1.66 H	208	40.44	4.10
6	4824.00	31.76 AV	54.00	-22.24	1.66 H	208	27.66	4.10

**ANTENNA POLARITY & TEST DISTANCE: VERTICAL AT 3 M**

NO.	FREQ. (MHz)	EMISSION LEVEL (dBuV/m)	LIMIT (dBuV/m)	MARGIN (dB)	ANTENNA HEIGHT (m)	TABLE ANGLE (Degree)	RAW VALUE (dBuV)	CORRECTION FACTOR (dB/m)
1	2390.00	65.50 PK	74.00	-8.50	1.42 V	152	67.48	-1.98
2	2390.00	47.38 AV	54.00	-6.62	1.42 V	152	49.36	-1.98
3	*2412.00	106.82 PK			1.42 V	152	108.94	-2.12
4	*2412.00	95.10 AV			1.42 V	152	97.22	-2.12
5	4824.00	42.39 PK	74.00	-31.61	1.03 V	74	38.29	4.10
6	4824.00	30.28 AV	54.00	-23.72	1.03 V	74	26.18	4.10

**REMARKS:**

1. Emission Level(dBuV/m) = Raw Value(dBuV) + Correction Factor(dB/m)
2. Correction Factor(dB/m) = Antenna Factor(dB/m) + Cable Factor(dB) – Pre-Amplifier Factor(dB)
3. The other emission levels were very low against the limit.
4. Margin value = Emission Level – Limit value
5. " \* ": Fundamental frequency.



<b>CHANNEL</b>	TX Channel 2	<b>DETECTOR FUNCTION</b>	Peak (PK)
<b>FREQUENCY RANGE</b>	1GHz ~ 25GHz		Average (AV)

**ANTENNA POLARITY & TEST DISTANCE: HORIZONTAL AT 3 M**

NO.	FREQ. (MHz)	EMISSION LEVEL (dBuV/m)	LIMIT (dBuV/m)	MARGIN (dB)	ANTENNA HEIGHT (m)	TABLE ANGLE (Degree)	RAW VALUE (dBuV)	CORRECTION FACTOR (dB/m)
1	2390.00	72.24 PK	74.00	-1.76	1.00 H	125	74.22	-1.98
2	2390.00	52.60 AV	54.00	-1.40	1.00 H	125	54.58	-1.98
3	*2417.00	110.10 PK			1.00 H	125	112.26	-2.16
4	*2417.00	98.47 AV			1.00 H	125	100.63	-2.16

**ANTENNA POLARITY & TEST DISTANCE: VERTICAL AT 3 M**

NO.	FREQ. (MHz)	EMISSION LEVEL (dBuV/m)	LIMIT (dBuV/m)	MARGIN (dB)	ANTENNA HEIGHT (m)	TABLE ANGLE (Degree)	RAW VALUE (dBuV)	CORRECTION FACTOR (dB/m)
1	2390.00	65.61 PK	74.00	-8.39	1.67 V	88	67.59	-1.98
2	2390.00	47.50 AV	54.00	-6.50	1.67 V	88	49.48	-1.98
3	*2417.00	106.86 PK			1.67 V	88	109.02	-2.16
4	*2417.00	95.25 AV			1.67 V	88	97.41	-2.16

**REMARKS:**

1. Emission Level(dBuV/m) = Raw Value(dBuV) + Correction Factor(dB/m)
2. Correction Factor(dB/m) = Antenna Factor(dB/m) + Cable Factor(dB) – Pre-Amplifier Factor(dB)
3. The other emission levels were very low against the limit.
4. Margin value = Emission Level – Limit value
5. " \* ": Fundamental frequency.

<b>CHANNEL</b>	TX Channel 6	<b>DETECTOR FUNCTION</b>	Peak (PK)
<b>FREQUENCY RANGE</b>	1GHz ~ 25GHz		Average (AV)

**ANTENNA POLARITY & TEST DISTANCE: HORIZONTAL AT 3 M**

NO.	FREQ. (MHz)	EMISSION LEVEL (dBuV/m)	LIMIT (dBuV/m)	MARGIN (dB)	ANTENNA HEIGHT (m)	TABLE ANGLE (Degree)	RAW VALUE (dBuV)	CORRECTION FACTOR (dB/m)
1	*2437.00	111.04 PK			1.00 H	220	113.32	-2.28
2	*2437.00	99.72 AV			1.00 H	220	102.00	-2.28
3	4874.00	44.91 PK	74.00	-29.09	1.58 H	201	40.69	4.22
4	4874.00	32.05 AV	54.00	-21.95	1.58 H	201	27.83	4.22

**ANTENNA POLARITY & TEST DISTANCE: VERTICAL AT 3 M**

NO.	FREQ. (MHz)	EMISSION LEVEL (dBuV/m)	LIMIT (dBuV/m)	MARGIN (dB)	ANTENNA HEIGHT (m)	TABLE ANGLE (Degree)	RAW VALUE (dBuV)	CORRECTION FACTOR (dB/m)
1	*2437.00	107.35 PK			1.44 V	157	109.63	-2.28
2	*2437.00	95.55 AV			1.44 V	157	97.83	-2.28
3	4874.00	42.84 PK	74.00	-31.16	1.00 V	66	38.62	4.22
4	4874.00	30.71 AV	54.00	-23.29	1.00 V	66	26.49	4.22

**REMARKS:**

1. Emission Level(dBuV/m) = Raw Value(dBuV) + Correction Factor(dB/m)
2. Correction Factor(dB/m) = Antenna Factor(dB/m) + Cable Factor(dB) – Pre-Amplifier Factor(dB)
3. The other emission levels were very low against the limit.
4. Margin value = Emission Level – Limit value
5. " \* ": Fundamental frequency.

<b>CHANNEL</b>	TX Channel 10	<b>DETECTOR FUNCTION</b>	Peak (PK)
<b>FREQUENCY RANGE</b>	1GHz ~ 25GHz		Average (AV)

**ANTENNA POLARITY & TEST DISTANCE: HORIZONTAL AT 3 M**

NO.	FREQ. (MHz)	EMISSION LEVEL (dBuV/m)	LIMIT (dBuV/m)	MARGIN (dB)	ANTENNA HEIGHT (m)	TABLE ANGLE (Degree)	RAW VALUE (dBuV)	CORRECTION FACTOR (dB/m)
1	*2457.00	109.64 PK			1.00 H	126	111.91	-2.27
2	*2457.00	98.19 AV			1.00 H	126	100.46	-2.27
3	2483.50	67.19 PK	74.00	-6.81	1.00 H	126	69.13	-1.94
4	2483.50	52.39 AV	54.00	-1.61	1.00 H	126	54.33	-1.94

**ANTENNA POLARITY & TEST DISTANCE: VERTICAL AT 3 M**

NO.	FREQ. (MHz)	EMISSION LEVEL (dBuV/m)	LIMIT (dBuV/m)	MARGIN (dB)	ANTENNA HEIGHT (m)	TABLE ANGLE (Degree)	RAW VALUE (dBuV)	CORRECTION FACTOR (dB/m)
1	*2457.00	106.56 PK			1.66 V	64	108.83	-2.27
2	*2457.00	94.95 AV			1.66 V	64	97.22	-2.27
3	2483.50	63.07 PK	74.00	-10.93	1.66 V	64	65.01	-1.94
4	2483.50	45.64 AV	54.00	-8.36	1.66 V	64	47.58	-1.94

**REMARKS:**

1. Emission Level(dBuV/m) = Raw Value(dBuV) + Correction Factor(dB/m)
2. Correction Factor(dB/m) = Antenna Factor(dB/m) + Cable Factor(dB) – Pre-Amplifier Factor(dB)
3. The other emission levels were very low against the limit.
4. Margin value = Emission Level – Limit value
5. " \* ": Fundamental frequency.

<b>CHANNEL</b>	TX Channel 11	<b>DETECTOR FUNCTION</b>	Peak (PK)
<b>FREQUENCY RANGE</b>	1GHz ~ 25GHz		Average (AV)

**ANTENNA POLARITY & TEST DISTANCE: HORIZONTAL AT 3 M**

NO.	FREQ. (MHz)	EMISSION LEVEL (dBuV/m)	LIMIT (dBuV/m)	MARGIN (dB)	ANTENNA HEIGHT (m)	TABLE ANGLE (Degree)	RAW VALUE (dBuV)	CORRECTION FACTOR (dB/m)
1	*2462.00	108.04 PK			1.00 H	128	110.25	-2.21
2	*2462.00	96.53 AV			1.00 H	128	98.74	-2.21
3	2483.50	67.55 PK	74.00	-6.45	1.00 H	128	69.49	-1.94
4	2483.50	52.55 AV	54.00	-1.45	1.00 H	128	54.49	-1.94
5	4924.00	44.02 PK	74.00	-29.98	1.93 H	108	39.88	4.14
6	4924.00	31.35 AV	54.00	-22.65	1.93 H	108	27.21	4.14

**ANTENNA POLARITY & TEST DISTANCE: VERTICAL AT 3 M**

NO.	FREQ. (MHz)	EMISSION LEVEL (dBuV/m)	LIMIT (dBuV/m)	MARGIN (dB)	ANTENNA HEIGHT (m)	TABLE ANGLE (Degree)	RAW VALUE (dBuV)	CORRECTION FACTOR (dB/m)
1	*2462.00	104.77 PK			1.67 V	155	106.98	-2.21
2	*2462.00	93.22 AV			1.67 V	155	95.43	-2.21
3	2483.50	63.19 PK	74.00	-10.81	1.67 V	155	65.13	-1.94
4	2483.50	45.72 AV	54.00	-8.28	1.67 V	155	47.66	-1.94
5	4924.00	41.72 PK	74.00	-32.28	1.49 V	63	37.58	4.14
6	4924.00	29.90 AV	54.00	-24.10	1.49 V	63	25.76	4.14

**REMARKS:**

1. Emission Level(dBuV/m) = Raw Value(dBuV) + Correction Factor(dB/m)
2. Correction Factor(dB/m) = Antenna Factor(dB/m) + Cable Factor(dB) – Pre-Amplifier Factor(dB)
3. The other emission levels were very low against the limit.
4. Margin value = Emission Level – Limit value
5. " \* ": Fundamental frequency.

**802.11n (20MHz)**

<b>CHANNEL</b>	TX Channel 1	<b>DETECTOR FUNCTION</b>	Peak (PK)
<b>FREQUENCY RANGE</b>	1GHz ~ 25GHz		Average (AV)

**ANTENNA POLARITY & TEST DISTANCE: HORIZONTAL AT 3 M**

NO.	FREQ. (MHz)	EMISSION LEVEL (dBuV/m)	LIMIT (dBuV/m)	MARGIN (dB)	ANTENNA HEIGHT (m)	TABLE ANGLE (Degree)	RAW VALUE (dBuV)	CORRECTION FACTOR (dB/m)
1	2390.00	72.84 PK	74.00	-1.16	1.00 H	222	74.82	-1.98
2	2390.00	52.26 AV	54.00	-1.74	1.00 H	222	54.24	-1.98
3	*2412.00	107.84 PK			1.00 H	222	109.96	-2.12
4	*2412.00	96.89 AV			1.00 H	222	99.01	-2.12
5	4824.00	44.48 PK	74.00	-29.52	1.09 H	271	40.38	4.10
6	4824.00	31.77 AV	54.00	-22.23	1.09 H	271	27.67	4.10

**ANTENNA POLARITY & TEST DISTANCE: VERTICAL AT 3 M**

NO.	FREQ. (MHz)	EMISSION LEVEL (dBuV/m)	LIMIT (dBuV/m)	MARGIN (dB)	ANTENNA HEIGHT (m)	TABLE ANGLE (Degree)	RAW VALUE (dBuV)	CORRECTION FACTOR (dB/m)
1	2390.00	69.72 PK	74.00	-4.28	1.42 V	153	71.70	-1.98
2	2390.00	48.57 AV	54.00	-5.43	1.42 V	153	50.55	-1.98
3	*2412.00	104.75 PK			1.42 V	153	106.87	-2.12
4	*2412.00	93.57 AV			1.42 V	153	95.69	-2.12
5	4824.00	42.92 PK	74.00	-31.08	1.93 V	51	38.82	4.10
6	4824.00	30.47 AV	54.00	-23.53	1.93 V	51	26.37	4.10

**REMARKS:**

1. Emission Level(dBuV/m) = Raw Value(dBuV) + Correction Factor(dB/m)
2. Correction Factor(dB/m) = Antenna Factor(dB/m) + Cable Factor(dB) – Pre-Amplifier Factor(dB)
3. The other emission levels were very low against the limit.
4. Margin value = Emission Level – Limit value
5. " \* ": Fundamental frequency.

<b>CHANNEL</b>	TX Channel 2	<b>DETECTOR FUNCTION</b>	Peak (PK)
<b>FREQUENCY RANGE</b>	1GHz ~ 25GHz		Average (AV)

**ANTENNA POLARITY & TEST DISTANCE: HORIZONTAL AT 3 M**

NO.	FREQ. (MHz)	EMISSION LEVEL (dBuV/m)	LIMIT (dBuV/m)	MARGIN (dB)	ANTENNA HEIGHT (m)	TABLE ANGLE (Degree)	RAW VALUE (dBuV)	CORRECTION FACTOR (dB/m)
1	2390.00	71.02 PK	74.00	-2.98	1.14 H	230	73.00	-1.98
2	2390.00	52.16 AV	54.00	-1.84	1.14 H	230	54.14	-1.98
3	*2417.00	108.23 PK			1.14 H	230	110.39	-2.16
4	*2417.00	98.02 AV			1.14 H	230	100.18	-2.16

**ANTENNA POLARITY & TEST DISTANCE: VERTICAL AT 3 M**

NO.	FREQ. (MHz)	EMISSION LEVEL (dBuV/m)	LIMIT (dBuV/m)	MARGIN (dB)	ANTENNA HEIGHT (m)	TABLE ANGLE (Degree)	RAW VALUE (dBuV)	CORRECTION FACTOR (dB/m)
1	2390.00	68.29 PK	74.00	-5.71	1.44 V	103	70.27	-1.98
2	2390.00	48.05 AV	54.00	-5.95	1.44 V	103	50.03	-1.98
3	*2417.00	104.95 PK			1.44 V	103	107.11	-2.16
4	*2417.00	93.33 AV			1.44 V	103	95.49	-2.16

**REMARKS:**

1. Emission Level(dBuV/m) = Raw Value(dBuV) + Correction Factor(dB/m)
2. Correction Factor(dB/m) = Antenna Factor(dB/m) + Cable Factor(dB) – Pre-Amplifier Factor(dB)
3. The other emission levels were very low against the limit.
4. Margin value = Emission Level – Limit value
5. " \* ": Fundamental frequency.

<b>CHANNEL</b>	TX Channel 6	<b>DETECTOR FUNCTION</b>	Peak (PK)
<b>FREQUENCY RANGE</b>	1GHz ~ 25GHz		Average (AV)

**ANTENNA POLARITY & TEST DISTANCE: HORIZONTAL AT 3 M**

NO.	FREQ. (MHz)	EMISSION LEVEL (dBuV/m)	LIMIT (dBuV/m)	MARGIN (dB)	ANTENNA HEIGHT (m)	TABLE ANGLE (Degree)	RAW VALUE (dBuV)	CORRECTION FACTOR (dB/m)
1	*2437.00	108.54 PK			2.05 H	225	110.82	-2.28
2	*2437.00	98.27 AV			2.05 H	225	100.55	-2.28
3	4874.00	44.71 PK	74.00	-29.29	1.15 H	263	40.49	4.22
4	4874.00	32.00 AV	54.00	-22.00	1.15 H	263	27.78	4.22

**ANTENNA POLARITY & TEST DISTANCE: VERTICAL AT 3 M**

NO.	FREQ. (MHz)	EMISSION LEVEL (dBuV/m)	LIMIT (dBuV/m)	MARGIN (dB)	ANTENNA HEIGHT (m)	TABLE ANGLE (Degree)	RAW VALUE (dBuV)	CORRECTION FACTOR (dB/m)
1	*2437.00	104.93 PK			1.82 V	159	107.21	-2.28
2	*2437.00	93.53 AV			1.82 V	159	95.81	-2.28
3	4874.00	43.11 PK	74.00	-30.89	1.99 V	83	38.89	4.22
4	4874.00	30.63 AV	54.00	-23.37	1.99 V	83	26.41	4.22

**REMARKS:**

1. Emission Level(dBuV/m) = Raw Value(dBuV) + Correction Factor(dB/m)
2. Correction Factor(dB/m) = Antenna Factor(dB/m) + Cable Factor(dB) – Pre-Amplifier Factor(dB)
3. The other emission levels were very low against the limit.
4. Margin value = Emission Level – Limit value
5. " \* ": Fundamental frequency.

<b>CHANNEL</b>	TX Channel 10	<b>DETECTOR FUNCTION</b>	Peak (PK)
<b>FREQUENCY RANGE</b>	1GHz ~ 25GHz		Average (AV)

**ANTENNA POLARITY & TEST DISTANCE: HORIZONTAL AT 3 M**

NO.	FREQ. (MHz)	EMISSION LEVEL (dBuV/m)	LIMIT (dBuV/m)	MARGIN (dB)	ANTENNA HEIGHT (m)	TABLE ANGLE (Degree)	RAW VALUE (dBuV)	CORRECTION FACTOR (dB/m)
1	*2457.00	108.82 PK			1.00 H	227	111.09	-2.27
2	*2457.00	98.09 AV			1.00 H	227	100.36	-2.27
3	2483.50	67.84 PK	74.00	-6.16	1.00 H	227	69.78	-1.94
4	2483.50	47.83 AV	54.00	-6.17	1.00 H	227	49.77	-1.94

**ANTENNA POLARITY & TEST DISTANCE: VERTICAL AT 3 M**

NO.	FREQ. (MHz)	EMISSION LEVEL (dBuV/m)	LIMIT (dBuV/m)	MARGIN (dB)	ANTENNA HEIGHT (m)	TABLE ANGLE (Degree)	RAW VALUE (dBuV)	CORRECTION FACTOR (dB/m)
1	*2457.00	105.41 PK			1.99 V	142	107.68	-2.27
2	*2457.00	93.76 AV			1.99 V	142	96.03	-2.27
3	2483.50	63.87 PK	74.00	-10.13	1.99 V	142	65.81	-1.94
4	2483.50	42.23 AV	54.00	-11.77	1.99 V	142	44.17	-1.94

**REMARKS:**

1. Emission Level(dBuV/m) = Raw Value(dBuV) + Correction Factor(dB/m)
2. Correction Factor(dB/m) = Antenna Factor(dB/m) + Cable Factor(dB) – Pre-Amplifier Factor(dB)
3. The other emission levels were very low against the limit.
4. Margin value = Emission Level – Limit value
5. " \* ": Fundamental frequency.



<b>CHANNEL</b>	TX Channel 11	<b>DETECTOR FUNCTION</b>	Peak (PK)
<b>FREQUENCY RANGE</b>	1GHz ~ 25GHz		Average (AV)

**ANTENNA POLARITY & TEST DISTANCE: HORIZONTAL AT 3 M**

NO.	FREQ. (MHz)	EMISSION LEVEL (dBuV/m)	LIMIT (dBuV/m)	MARGIN (dB)	ANTENNA HEIGHT (m)	TABLE ANGLE (Degree)	RAW VALUE (dBuV)	CORRECTION FACTOR (dB/m)
1	*2462.00	105.43 PK			1.45 H	237	107.64	-2.21
2	*2462.00	94.59 AV			1.45 H	237	96.80	-2.21
3	2483.50	70.47 PK	74.00	-3.53	1.45 H	237	72.41	-1.94
4	2483.50	52.31 AV	54.00	-1.69	1.45 H	237	54.25	-1.94
5	4924.00	44.07 PK	74.00	-29.93	1.18 H	263	39.93	4.14
6	4924.00	31.38 AV	54.00	-22.62	1.18 H	263	27.24	4.14

**ANTENNA POLARITY & TEST DISTANCE: VERTICAL AT 3 M**

NO.	FREQ. (MHz)	EMISSION LEVEL (dBuV/m)	LIMIT (dBuV/m)	MARGIN (dB)	ANTENNA HEIGHT (m)	TABLE ANGLE (Degree)	RAW VALUE (dBuV)	CORRECTION FACTOR (dB/m)
1	*2462.00	102.76 PK			1.44 V	142	104.97	-2.21
2	*2462.00	91.66 AV			1.44 V	142	93.87	-2.21
3	2483.50	67.94 PK	74.00	-6.06	1.44 V	142	69.88	-1.94
4	2483.50	45.97 AV	54.00	-8.03	1.44 V	142	47.91	-1.94
5	4924.00	42.82 PK	74.00	-31.18	1.89 V	69	38.68	4.14
6	4924.00	30.27 AV	54.00	-23.73	1.89 V	69	26.13	4.14

**REMARKS:**

1. Emission Level(dBuV/m) = Raw Value(dBuV) + Correction Factor(dB/m)
2. Correction Factor(dB/m) = Antenna Factor(dB/m) + Cable Factor(dB) – Pre-Amplifier Factor(dB)
3. The other emission levels were very low against the limit.
4. Margin value = Emission Level – Limit value
5. " \* ": Fundamental frequency.

**802.11n (40MHz)**

<b>CHANNEL</b>	TX Channel 3	<b>DETECTOR FUNCTION</b>	Peak (PK)
<b>FREQUENCY RANGE</b>	1GHz ~ 25GHz		Average (AV)

**ANTENNA POLARITY & TEST DISTANCE: HORIZONTAL AT 3 M**

NO.	FREQ. (MHz)	EMISSION LEVEL (dBuV/m)	LIMIT (dBuV/m)	MARGIN (dB)	ANTENNA HEIGHT (m)	TABLE ANGLE (Degree)	RAW VALUE (dBuV)	CORRECTION FACTOR (dB/m)
1	2390.00	68.09 PK	74.00	-5.91	1.00 H	232	70.07	-1.98
2	2390.00	52.64 AV	54.00	-1.36	1.00 H	232	54.62	-1.98
3	*2422.00	100.36 PK			1.00 H	232	102.55	-2.19
4	*2422.00	91.31 AV			1.00 H	232	93.50	-2.19
5	4844.00	43.73 PK	74.00	-30.27	2.07 H	184	39.54	4.19
6	4844.00	31.60 AV	54.00	-22.40	2.07 H	184	27.41	4.19

**ANTENNA POLARITY & TEST DISTANCE: VERTICAL AT 3 M**

NO.	FREQ. (MHz)	EMISSION LEVEL (dBuV/m)	LIMIT (dBuV/m)	MARGIN (dB)	ANTENNA HEIGHT (m)	TABLE ANGLE (Degree)	RAW VALUE (dBuV)	CORRECTION FACTOR (dB/m)
1	2390.00	62.46 PK	74.00	-11.54	1.98 V	164	64.44	-1.98
2	2390.00	47.30 AV	54.00	-6.70	1.98 V	164	49.28	-1.98
3	*2422.00	97.41 PK			1.98 V	164	99.60	-2.19
4	*2422.00	88.10 AV			1.98 V	164	90.29	-2.19
5	4844.00	41.37 PK	74.00	-32.63	1.09 V	339	37.18	4.19
6	4844.00	30.68 AV	54.00	-23.32	1.09 V	339	26.49	4.19

**REMARKS:**

1. Emission Level(dBuV/m) = Raw Value(dBuV) + Correction Factor(dB/m)
2. Correction Factor(dB/m) = Antenna Factor(dB/m) + Cable Factor(dB) – Pre-Amplifier Factor(dB)
3. The other emission levels were very low against the limit.
4. Margin value = Emission Level – Limit value
5. " \* ": Fundamental frequency.

<b>CHANNEL</b>	TX Channel 4	<b>DETECTOR FUNCTION</b>	Peak (PK)
<b>FREQUENCY RANGE</b>	1GHz ~ 25GHz		Average (AV)

**ANTENNA POLARITY & TEST DISTANCE: HORIZONTAL AT 3 M**

NO.	FREQ. (MHz)	EMISSION LEVEL (dBuV/m)	LIMIT (dBuV/m)	MARGIN (dB)	ANTENNA HEIGHT (m)	TABLE ANGLE (Degree)	RAW VALUE (dBuV)	CORRECTION FACTOR (dB/m)
1	2390.00	67.96 PK	74.00	-6.04	2.05 H	229	69.94	-1.98
2	2390.00	52.85 AV	54.00	-1.15	2.05 H	229	54.83	-1.98
3	*2427.00	102.19 PK			2.05 H	229	104.42	-2.23
4	*2427.00	93.34 AV			2.05 H	229	95.57	-2.23

**ANTENNA POLARITY & TEST DISTANCE: VERTICAL AT 3 M**

NO.	FREQ. (MHz)	EMISSION LEVEL (dBuV/m)	LIMIT (dBuV/m)	MARGIN (dB)	ANTENNA HEIGHT (m)	TABLE ANGLE (Degree)	RAW VALUE (dBuV)	CORRECTION FACTOR (dB/m)
1	2390.00	62.33 PK	74.00	-11.67	1.81 V	157	64.31	-1.98
2	2390.00	47.35 AV	54.00	-6.65	1.81 V	157	49.33	-1.98
3	*2427.00	98.95 PK			1.81 V	157	101.18	-2.23
4	*2427.00	88.11 AV			1.81 V	157	90.34	-2.23

**REMARKS:**

1. Emission Level(dBuV/m) = Raw Value(dBuV) + Correction Factor(dB/m)
2. Correction Factor(dB/m) = Antenna Factor(dB/m) + Cable Factor(dB) – Pre-Amplifier Factor(dB)
3. The other emission levels were very low against the limit.
4. Margin value = Emission Level – Limit value
5. " \* ": Fundamental frequency.

<b>CHANNEL</b>	TX Channel 6	<b>DETECTOR FUNCTION</b>	Peak (PK)
<b>FREQUENCY RANGE</b>	1GHz ~ 25GHz		Average (AV)

**ANTENNA POLARITY & TEST DISTANCE: HORIZONTAL AT 3 M**

NO.	FREQ. (MHz)	EMISSION LEVEL (dBuV/m)	LIMIT (dBuV/m)	MARGIN (dB)	ANTENNA HEIGHT (m)	TABLE ANGLE (Degree)	RAW VALUE (dBuV)	CORRECTION FACTOR (dB/m)
1	2390.00	66.99 PK	74.00	-7.01	2.04 H	232	68.97	-1.98
2	2390.00	52.33 AV	54.00	-1.67	2.04 H	232	54.31	-1.98
3	*2437.00	104.45 PK			2.04 H	232	106.73	-2.28
4	*2437.00	95.71 AV			2.04 H	232	97.99	-2.28
5	4874.00	44.40 PK	74.00	-29.60	2.28 H	103	40.18	4.22
6	4874.00	31.95 AV	54.00	-22.05	2.28 H	103	27.73	4.22

**ANTENNA POLARITY & TEST DISTANCE: VERTICAL AT 3 M**

NO.	FREQ. (MHz)	EMISSION LEVEL (dBuV/m)	LIMIT (dBuV/m)	MARGIN (dB)	ANTENNA HEIGHT (m)	TABLE ANGLE (Degree)	RAW VALUE (dBuV)	CORRECTION FACTOR (dB/m)
1	2390.00	60.30 PK	74.00	-13.70	2.29 V	151	62.28	-1.98
2	2390.00	47.09 AV	54.00	-6.91	2.29 V	151	49.07	-1.98
3	*2437.00	101.04 PK			2.29 V	151	103.32	-2.28
4	*2437.00	91.81 AV			2.29 V	151	94.09	-2.28
5	4874.00	41.77 PK	74.00	-32.23	1.00 V	8	37.55	4.22
6	4874.00	31.09 AV	54.00	-22.91	1.00 V	8	26.87	4.22

**REMARKS:**

1. Emission Level(dBuV/m) = Raw Value(dBuV) + Correction Factor(dB/m)
2. Correction Factor(dB/m) = Antenna Factor(dB/m) + Cable Factor(dB) – Pre-Amplifier Factor(dB)
3. The other emission levels were very low against the limit.
4. Margin value = Emission Level – Limit value
5. " \* ": Fundamental frequency.

<b>CHANNEL</b>	TX Channel 8	<b>DETECTOR FUNCTION</b>	Peak (PK)
<b>FREQUENCY RANGE</b>	1GHz ~ 25GHz		Average (AV)

**ANTENNA POLARITY & TEST DISTANCE: HORIZONTAL AT 3 M**

NO.	FREQ. (MHz)	EMISSION LEVEL (dBuV/m)	LIMIT (dBuV/m)	MARGIN (dB)	ANTENNA HEIGHT (m)	TABLE ANGLE (Degree)	RAW VALUE (dBuV)	CORRECTION FACTOR (dB/m)
1	*2447.00	103.76 PK			2.03 H	228	106.11	-2.35
2	*2447.00	94.77 AV			2.03 H	228	97.12	-2.35
3	2483.50	69.20 PK	74.00	-4.80	2.03 H	228	71.14	-1.94
4	2483.50	52.56 AV	54.00	-1.44	2.03 H	228	54.50	-1.94

**ANTENNA POLARITY & TEST DISTANCE: VERTICAL AT 3 M**

NO.	FREQ. (MHz)	EMISSION LEVEL (dBuV/m)	LIMIT (dBuV/m)	MARGIN (dB)	ANTENNA HEIGHT (m)	TABLE ANGLE (Degree)	RAW VALUE (dBuV)	CORRECTION FACTOR (dB/m)
1	*2447.00	100.98 PK			2.81 V	105	103.33	-2.35
2	*2447.00	89.84 AV			2.81 V	105	92.19	-2.35
3	2483.50	63.34 PK	74.00	-10.66	2.81 V	105	65.28	-1.94
4	2483.50	47.33 AV	54.00	-6.67	2.81 V	105	49.27	-1.94

**REMARKS:**

1. Emission Level(dBuV/m) = Raw Value(dBuV) + Correction Factor(dB/m)
2. Correction Factor(dB/m) = Antenna Factor(dB/m) + Cable Factor(dB) – Pre-Amplifier Factor(dB)
3. The other emission levels were very low against the limit.
4. Margin value = Emission Level – Limit value
5. " \* ": Fundamental frequency.

<b>CHANNEL</b>	TX Channel 9	<b>DETECTOR FUNCTION</b>	Peak (PK)
<b>FREQUENCY RANGE</b>	1GHz ~ 25GHz		Average (AV)

**ANTENNA POLARITY & TEST DISTANCE: HORIZONTAL AT 3 M**

NO.	FREQ. (MHz)	EMISSION LEVEL (dBuV/m)	LIMIT (dBuV/m)	MARGIN (dB)	ANTENNA HEIGHT (m)	TABLE ANGLE (Degree)	RAW VALUE (dBuV)	CORRECTION FACTOR (dB/m)
1	*2452.00	101.46 PK			2.02 H	226	103.80	-2.34
2	*2452.00	92.53 AV			2.02 H	226	94.87	-2.34
3	2483.50	67.93 PK	74.00	-6.07	2.02 H	226	69.87	-1.94
4	2483.50	52.42 AV	54.00	-1.58	2.02 H	226	54.36	-1.94
5	4904.00	44.01 PK	74.00	-29.99	2.01 H	235	39.81	4.20
6	4904.00	31.83 AV	54.00	-22.17	2.01 H	235	27.63	4.20

**ANTENNA POLARITY & TEST DISTANCE: VERTICAL AT 3 M**

NO.	FREQ. (MHz)	EMISSION LEVEL (dBuV/m)	LIMIT (dBuV/m)	MARGIN (dB)	ANTENNA HEIGHT (m)	TABLE ANGLE (Degree)	RAW VALUE (dBuV)	CORRECTION FACTOR (dB/m)
1	*2452.00	97.95 PK			1.46 V	166	100.29	-2.34
2	*2452.00	88.82 AV			1.46 V	166	91.16	-2.34
3	2483.50	61.19 PK	74.00	-12.81	1.46 V	166	63.13	-1.94
4	2483.50	47.10 AV	54.00	-6.90	1.46 V	166	49.04	-1.94
5	4904.00	41.52 PK	74.00	-32.48	1.07 V	4	37.32	4.20
6	4904.00	30.83 AV	54.00	-23.17	1.07 V	4	26.63	4.20

**REMARKS:**

1. Emission Level(dBuV/m) = Raw Value(dBuV) + Correction Factor(dB/m)
2. Correction Factor(dB/m) = Antenna Factor(dB/m) + Cable Factor(dB) – Pre-Amplifier Factor(dB)
3. The other emission levels were very low against the limit.
4. Margin value = Emission Level – Limit value
5. " \* ": Fundamental frequency.

**BELOW 1GHz WORST-CASE DATA**
**802.11b**

<b>CHANNEL</b>	TX Channel 6	<b>DETECTOR FUNCTION</b>	Quasi-Peak (QP)
<b>FREQUENCY RANGE</b>	9kHz ~ 1GHz		

**ANTENNA POLARITY & TEST DISTANCE: HORIZONTAL AT 3 M**

NO.	FREQ. (MHz)	EMISSION LEVEL (dBuV/m)	LIMIT (dBuV/m)	MARGIN (dB)	ANTENNA HEIGHT (m)	TABLE ANGLE (Degree)	RAW VALUE (dBuV)	CORRECTION FACTOR (dB/m)
1	43.39	22.14 QP	40.00	-17.86	1.00 H	360	31.19	-9.05
2	94.75	23.71 QP	43.50	-19.79	3.00 H	278	38.10	-14.39
3	454.67	26.10 QP	46.00	-19.90	1.00 H	113	29.81	-3.71
4	602.98	27.72 QP	46.00	-18.28	3.00 H	184	28.04	-0.32
5	773.17	31.50 QP	46.00	-14.50	1.00 H	245	28.18	3.32
6	863.13	32.71 QP	46.00	-13.29	2.00 H	338	28.45	4.26

**ANTENNA POLARITY & TEST DISTANCE: VERTICAL AT 3 M**

NO.	FREQ. (MHz)	EMISSION LEVEL (dBuV/m)	LIMIT (dBuV/m)	MARGIN (dB)	ANTENNA HEIGHT (m)	TABLE ANGLE (Degree)	RAW VALUE (dBuV)	CORRECTION FACTOR (dB/m)
1	43.00	31.71 QP	40.00	-8.29	1.66 V	302	40.78	-9.07
2	99.04	29.82 QP	43.50	-13.68	2.11 V	311	43.83	-14.01
3	438.61	23.77 QP	46.00	-22.23	1.02 V	330	27.76	-3.99
4	580.04	29.23 QP	46.00	-16.77	1.15 V	2	30.26	-1.03
5	868.81	33.63 QP	46.00	-12.37	2.43 V	2	29.30	4.33
6	951.11	34.35 QP	46.00	-11.65	2.04 V	270	28.38	5.97

**REMARKS:**

1. Emission Level(dBuV/m) = Raw Value(dBuV) + Correction Factor(dB/m)
2. Correction Factor(dB/m) = Antenna Factor(dB/m) + Cable Factor(dB) – Pre-Amplifier Factor(dB)
3. The other emission levels were very low against the limit.
4. Margin value = Emission Level – Limit value

## 4.2 Conducted Emission Measurement

### 4.2.1 Limits of Conducted Emission Measurement

Frequency (MHz)	Conducted Limit (dBuV)	
	Quasi-peak	Average
0.15 - 0.5	66 - 56	56 - 46
0.50 - 5.0	56	46
5.0 - 30.0	60	50

Note: 1. The lower limit shall apply at the transition frequencies.

2. The limit decreases in line with the logarithm of the frequency in the range of 0.15 to 0.50MHz.

### 4.2.2 Test Instruments

Description & Manufacturer	Model No.	Serial No.	Cal. Date	Cal. Due
ROHDE & SCHWARZ TEST RECEIVER	ESCS 30	100276	Apr. 10, 2017	Apr. 9, 2018
ROHDE & SCHWARZ Artificial Mains Network (for EUT)	ENV216	101197	May 22, 2017	May 21, 2018
LISN With Adapter (for EUT)	AD10	C10Ada-002	May 22, 2017	May 21, 2018
ROHDE & SCHWARZ Artificial Mains Network (for peripherals)	ESH3-Z5	100218	Nov. 23, 2017	Nov. 22, 2018
SCHWARZBECK Artificial Mains Network (For EUT)	NNLK8129	8129229	May 9, 2017	May 8, 2018
Software	Cond_V7.3.7.4	NA	NA	NA
RF cable (JYEBAO) With 10dB PAD	5D-FB	Cable-C10.01	Feb. 14, 2017	Feb. 13, 2018
SUHNER Terminator (For ROHDE & SCHWARZ LISN)	65BNC-5001	E1-011484	May 18, 2017	May 17, 2018
ROHDE & SCHWARZ Artificial Mains Network (For TV EUT)	ESH3-Z5	100220	Nov. 14, 2017	Nov. 13, 2018
LISN With Adapter (for TV EUT)	100220	N/A	Nov. 14, 2017	Nov. 13, 2018

Notes: 1. The calibration interval of the above test instruments is 12 months and the calibrations are traceable to NML/ROC and NIST/USA.

2. The test was performed in Shielded Room No. 10.



#### 4.2.3 Test Procedures

- The EUT was placed 0.4 meters from the conducting wall of the shielded room with EUT being connected to the power mains through a line impedance stabilization network (LISN). Other support units were connected to the power mains through another LISN. The two LISNs provide 50 ohm/ 50uH of coupling impedance for the measuring instrument.
- Both lines of the power mains connected to the EUT were checked for maximum conducted interference.
- The frequency range from 150kHz to 30MHz was searched. Emission levels under (Limit - 20dB) was not recorded.

**NOTE:** The resolution bandwidth and video bandwidth of test receiver is 9kHz for quasi-peak detection (QP) and average detection (AV) at frequency 0.15MHz-30MHz.

#### 4.2.4 Deviation from Test Standard

No deviation.

#### 4.2.5 Test Setup

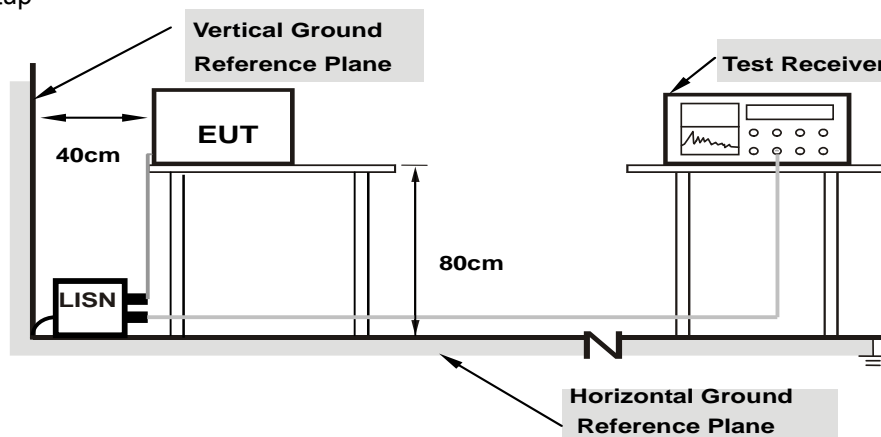

**Note:** Support units were connected to second LISN.

For the actual test configuration, please refer to the attached file (Test Setup Photo).

#### 4.2.6 EUT Operating Conditions

Same as item 4.1.6.

#### 4.2.7 Test Results

Phase	Line (L)	Detector Function	Quasi-Peak (QP) / Average (AV)
-------	----------	-------------------	--------------------------------

No	Frequency (MHz)	Correction Factor (dB)	Reading Value (dBuV)		Emission Level (dBuV)		Limit (dBuV)		Margin (dB)	
			Q.P.	AV.	Q.P.	AV.	Q.P.	AV.	Q.P.	AV.
1	0.22031	9.65	28.79	19.70	38.44	29.35	62.81	52.81	-24.37	-23.46
2	<b>0.46641</b>	<b>9.66</b>	<b>36.57</b>	<b>28.89</b>	<b>46.23</b>	<b>38.55</b>	<b>56.58</b>	<b>46.58</b>	<b>-10.35</b>	<b>-8.03</b>
3	1.93750	9.74	16.52	7.25	26.26	16.99	56.00	46.00	-29.74	-29.01
4	3.35938	9.81	19.01	6.75	28.82	16.56	56.00	46.00	-27.18	-29.44
5	11.42578	9.94	16.40	8.60	26.34	18.54	60.00	50.00	-33.66	-31.46
6	15.99609	9.97	16.28	6.65	26.25	16.62	60.00	50.00	-33.75	-33.38

#### Remarks:

1. Q.P. and AV. are abbreviations of quasi-peak and average individually.
2. The emission levels of other frequencies were very low against the limit.
3. Margin value = Emission level – Limit value
4. Correction factor = Insertion loss + Cable loss
5. Emission Level = Correction Factor + Reading Value

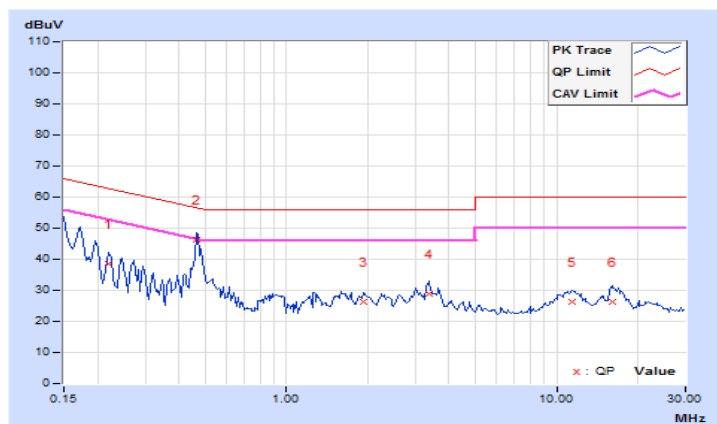

Phase	Neutral (N)	Detector Function	Quasi-Peak (QP) / Average (AV)
-------	-------------	-------------------	--------------------------------

No	Frequency (MHz)	Correction Factor (dB)	Reading Value (dBuV)		Emission Level (dBuV)		Limit (dBuV)		Margin (dB)	
			Q.P.	AV.	Q.P.	AV.	Q.P.	AV.	Q.P.	AV.
1	0.16562	9.67	26.93	19.42	36.60	29.09	65.18	55.18	-28.58	-26.09
2	0.46641	9.68	32.96	25.56	42.64	35.24	56.58	46.58	-13.94	-11.34
3	1.60156	9.73	14.72	6.15	24.45	15.88	56.00	46.00	-31.55	-30.12
4	3.63672	9.84	16.58	1.73	26.42	11.57	56.00	46.00	-29.58	-34.43
5	11.03516	9.96	14.49	6.28	24.45	16.24	60.00	50.00	-35.55	-33.76
6	16.06250	10.02	15.07	4.79	25.09	14.81	60.00	50.00	-34.91	-35.19

**Remarks:**

1. Q.P. and AV. are abbreviations of quasi-peak and average individually.
2. The emission levels of other frequencies were very low against the limit.
3. Margin value = Emission level – Limit value
4. Correction factor = Insertion loss + Cable loss
5. Emission Level = Correction Factor + Reading Value

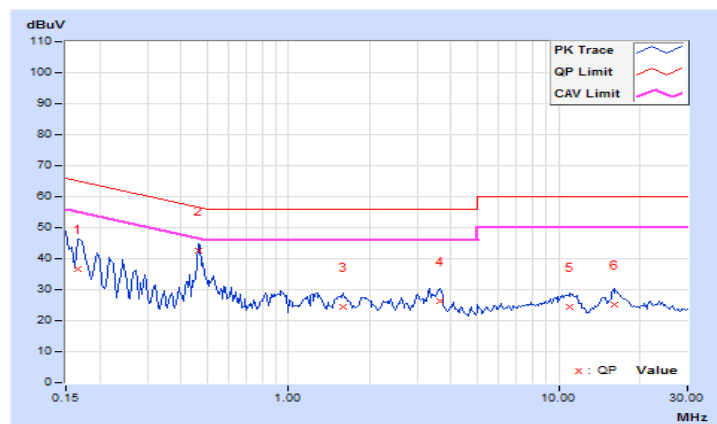

### 4.3 6dB Bandwidth Measurement

#### 4.3.1 Limits of 6dB Bandwidth Measurement

The minimum of 6dB Bandwidth Measurement is 0.5 MHz.

#### 4.3.2 Test Setup

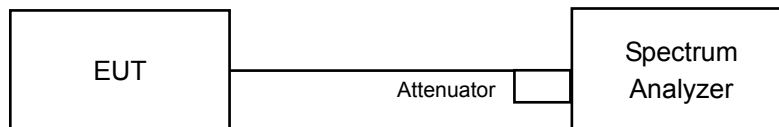

#### 4.3.3 Test Instruments

Refer to section 4.1.2 to get information of above instrument.

#### 4.3.4 Test Procedure

- a. Set resolution bandwidth (RBW) = 100kHz
- b. Set the video bandwidth (VBW)  $\geq 3 \times$  RBW, Detector = Peak.
- c. Trace mode = max hold.
- d. Sweep = auto couple.
- e. Measure the maximum width of the emission that is constrained by the frequencies associated with the two amplitude points (upper and lower) that are attenuated by 6 dB relative to the maximum level measured in the fundamental emission

#### 4.3.5 Deviation from Test Standard

No deviation.

#### 4.3.6 EUT Operating Conditions

The software provided by client to enable the EUT under transmission condition continuously at lowest, middle and highest channel frequencies individually.

#### 4.3.7 Test Result

##### 802.11b

Channel	Frequency (MHz)	6dB Bandwidth (MHz)	Minimum Limit (MHz)	Pass / Fail
1	2412	10.09	0.5	PASS
6	2437	10.11	0.5	PASS
11	2462	10.09	0.5	PASS

##### 802.11g

Channel	Frequency (MHz)	6dB Bandwidth (MHz)	Minimum Limit (MHz)	Pass / Fail
1	2412	16.39	0.5	PASS
6	2437	16.40	0.5	PASS
11	2462	16.39	0.5	PASS

##### 802.11n (20MHz)

Channel	Frequency (MHz)	6dB Bandwidth (MHz)	Minimum Limit (MHz)	Pass / Fail
1	2412	17.36	0.5	PASS
6	2437	17.59	0.5	PASS
11	2462	17.34	0.5	PASS

##### 802.11n (40MHz)

Channel	Frequency (MHz)	6dB Bandwidth (MHz)	Minimum Limit (MHz)	Pass / Fail
3	2422	35.13	0.5	PASS
6	2437	32.62	0.5	PASS
9	2452	32.70	0.5	PASS

Spectrum Plot of Worst Value

802.11b / CH6

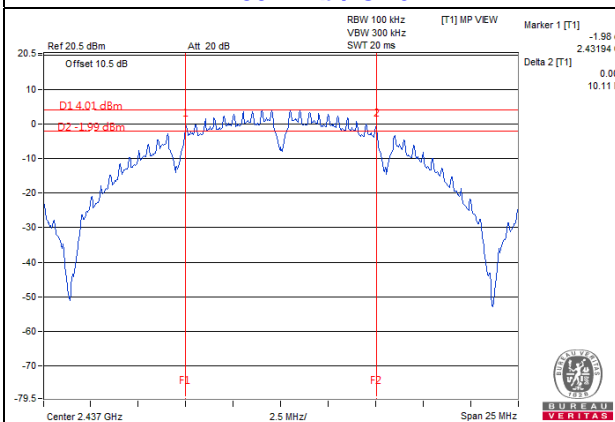

802.11g / CH6

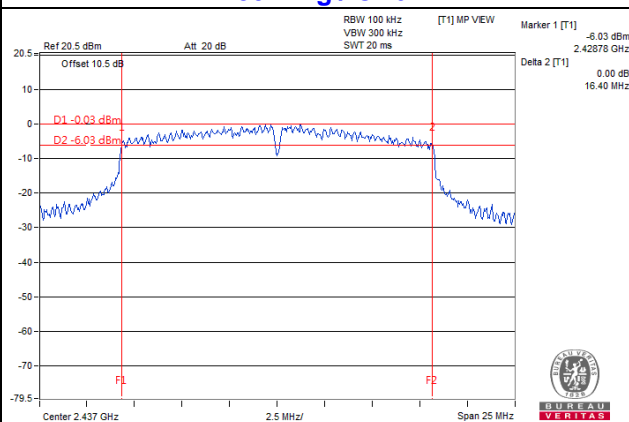

802.11n (20MHz) / CH6

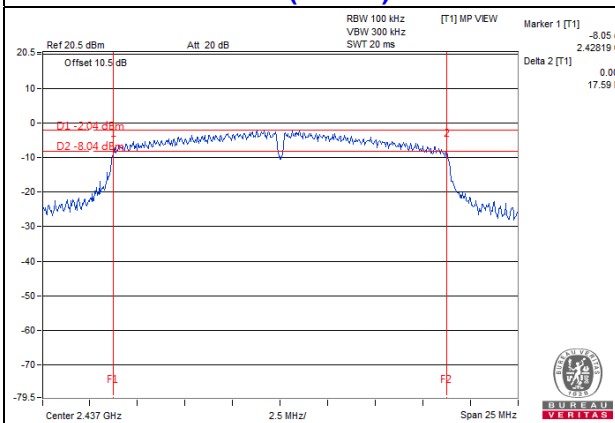

802.11n (40MHz) / CH3

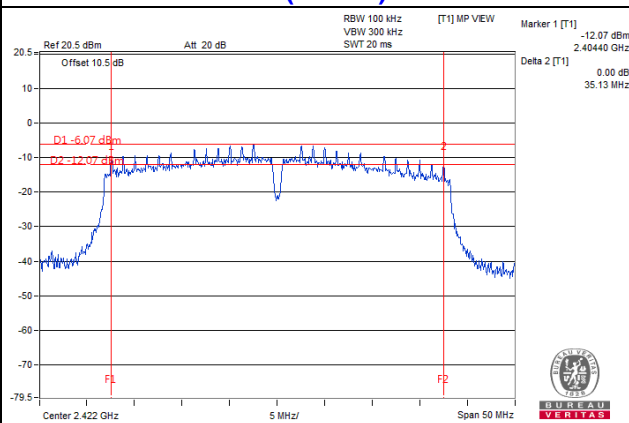

## 4.4 Conducted Output Power Measurement

### 4.4.1 Limits of Conducted Output Power Measurement

For systems using digital modulation in the 2400–2483.5 MHz bands: 1 Watt (30dBm)

### 4.4.2 Test Setup

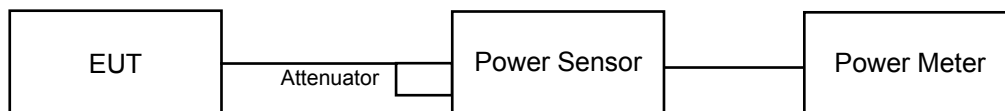

### 4.4.3 Test Instruments

Refer to section 4.1.2 to get information of above instrument.

### 4.4.4 Test Procedures

A peak power sensor was used on the output port of the EUT. A power meter was used to read the response of the peak power sensor. Record the power level.

Average power sensor was used to perform output power measurement, trigger and gating function of wide band power meter is enabled to measure max output power of TX on burst. Duty factor is not added to measured value.

### 4.4.5 Deviation from Test Standard

No deviation.

### 4.4.6 EUT Operating Conditions

Same as Item 4.3.6.

#### 4.4.7 Test Results

#### FOR PEAK POWER

##### 802.11b

Channel	Frequency (MHz)	Peak Power (mW)	Peak Power (dBm)	Limit (dBm)	Pass / Fail
1	2412	45.920	16.62	30	Pass
2	2417	46.238	16.65	30	Pass
6	2437	42.073	16.24	30	Pass
10	2457	37.497	15.74	30	Pass
11	2462	35.645	15.52	30	Pass

##### 802.11g

Channel	Frequency (MHz)	Peak Power (mW)	Peak Power (dBm)	Limit (dBm)	Pass / Fail
1	2412	40.458	16.07	30	Pass
2	2417	44.463	16.48	30	Pass
6	2437	60.395	17.81	30	Pass
10	2457	48.084	16.82	30	Pass
11	2462	29.444	14.69	30	Pass

##### 802.11n (20MHz)

Channel	Frequency (MHz)	Peak Power (mW)	Peak Power (dBm)	Limit (dBm)	Pass / Fail
1	2412	46.452	16.67	30	Pass
2	2417	61.376	17.88	30	Pass
6	2437	57.412	17.59	30	Pass
10	2457	48.865	16.89	30	Pass
11	2462	37.239	15.71	30	Pass

##### 802.11n (40MHz)

Channel	Frequency (MHz)	Peak Power (mW)	Peak Power (dBm)	Limit (dBm)	Pass / Fail
3	2422	27.669	14.42	30	Pass
4	2427	36.898	15.67	30	Pass
6	2437	<b>61.944</b>	17.92	30	Pass
8	2447	52.481	17.20	30	Pass
9	2452	51.523	17.12	30	Pass



## FOR AVERAGE POWER

### 802.11b

Channel	Frequency (MHz)	Average Power (mW)	Average Power (dBm)
1	2412	33.806	15.29
2	2417	34.277	15.35
6	2437	31.769	15.02
10	2457	27.861	14.45
11	2462	26.546	14.24

### 802.11g

Channel	Frequency (MHz)	Average Power (mW)	Average Power (dBm)
1	2412	13.213	11.21
2	2417	14.322	11.56
6	2437	21.577	13.34
10	2457	16.368	12.14
11	2462	9.376	9.72

### 802.11n (20MHz)

Channel	Frequency (MHz)	Average Power (mW)	Average Power (dBm)
1	2412	11.117	10.46
2	2417	17.100	12.33
6	2437	14.158	11.51
10	2457	12.106	10.83
11	2462	8.472	9.28

### 802.11n (40MHz)

Channel	Frequency (MHz)	Average Power (mW)	Average Power (dBm)
3	2422	5.212	7.17
4	2427	7.096	8.51
6	2437	14.028	11.47
8	2447	10.375	10.16
9	2452	10.209	10.09

## 4.5 Power Spectral Density Measurement

### 4.5.1 Limits of Power Spectral Density Measurement

The Maximum of Power Spectral Density Measurement is 8dBm.

### 4.5.2 Test Setup

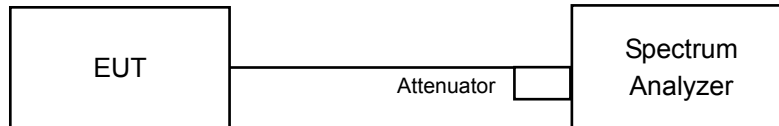

### 4.5.3 Test Instruments

Refer to section 4.1.2 to get information of above instrument.

### 4.5.4 Test Procedure

- a. Set analyzer center frequency to DTS channel center frequency.
- b. Set the span to 1.5 times the DTS bandwidth.
- c. Set the RBW to:  $3 \text{ kHz} \leq \text{RBW} \leq 100 \text{ kHz}$ .
- d. Set the VBW  $\geq 3 \times \text{RBW}$ .
- e. Detector = peak.
- f. Sweep time = auto couple.
- g. Trace mode = max hold.
- h. Allow trace to fully stabilize.
- i. Use the peak marker function to determine the maximum amplitude level within the RBW.

### 4.5.5 Deviation from Test Standard

No deviation.

### 4.5.6 EUT Operating Condition

Same as Item 4.3.6

#### 4.5.7 Test Results

##### 802.11b

Channel	Freq. (MHz)	PSD (dBm/3kHz)	Limit (dBm/3kHz)	Pass /Fail
1	2412	-9.07	8	Pass
6	2437	-10.31	8	Pass
11	2462	-10.08	8	Pass

##### 802.11g

Channel	Freq. (MHz)	PSD (dBm/3kHz)	Limit (dBm/3kHz)	Pass /Fail
1	2412	-15.31	8	Pass
6	2437	-13.07	8	Pass
11	2462	-16.17	8	Pass

##### 802.11n (20MHz)

Channel	Freq. (MHz)	PSD (dBm/3kHz)	Limit (dBm/3kHz)	Pass /Fail
1	2412	-14.55	8	Pass
6	2437	-14.34	8	Pass
11	2462	-17.03	8	Pass

##### 802.11n (40MHz)

Channel	Freq. (MHz)	PSD (dBm/3kHz)	Limit (dBm/3kHz)	Pass /Fail
3	2422	-21.84	8	Pass
6	2437	-19.01	8	Pass
9	2452	-20.70	8	Pass

### Spectrum Plot of Worst Value

#### 802.11b / CH1

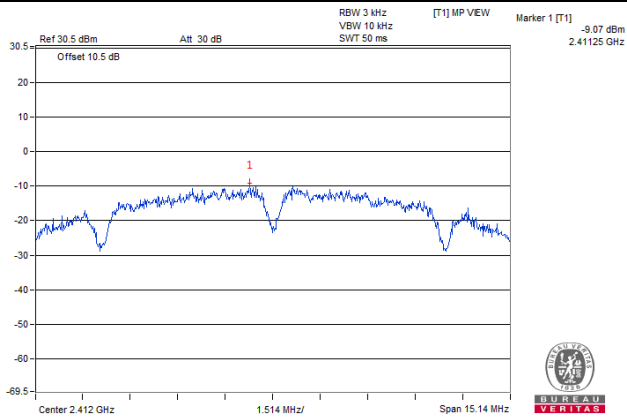

#### 802.11g / CH6

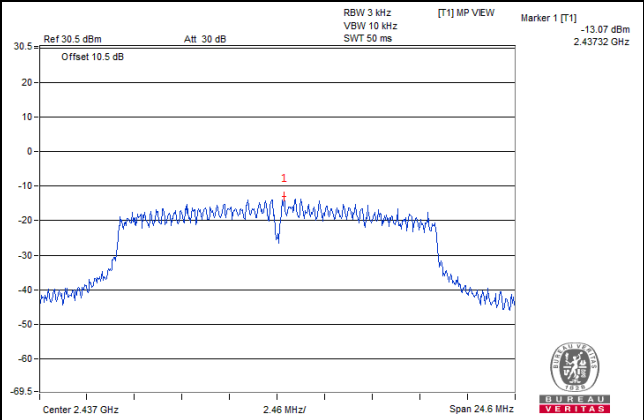

#### 802.11n (20MHz) / CH6

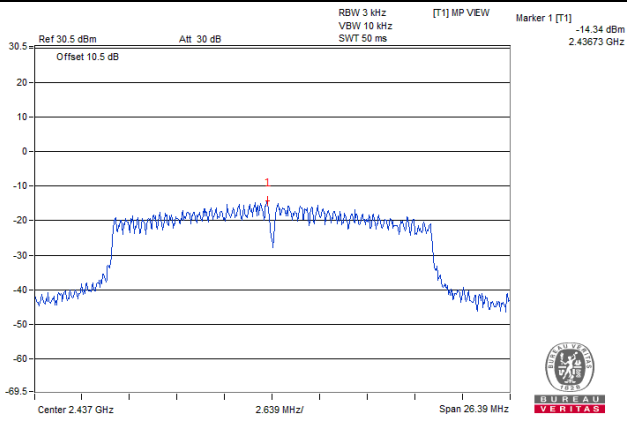

#### 802.11n (40MHz) / CH6

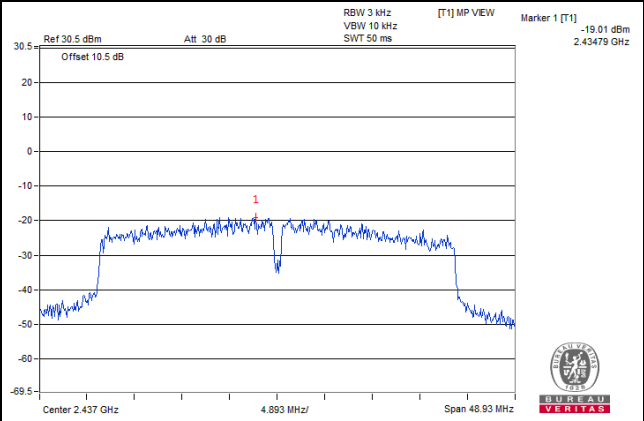

## 4.6 Conducted Out of Band Emission Measurement

### 4.6.1 Limits of Conducted Out of Band Emission Measurement

Below 20dB of the highest emission level of operating band (in 100kHz Resolution Bandwidth).

### 4.6.2 Test Setup

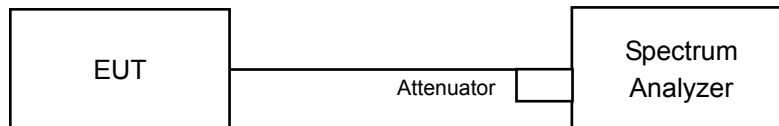

### 4.6.3 Test Instruments

Refer to section 4.1.2 to get information of above instrument.

### 4.6.4 Test Procedure

#### MEASUREMENT PROCEDURE REF

1. Set the RBW = 100 kHz.
2. Set the VBW  $\geq$  300 kHz.
3. Detector = peak.
4. Sweep time = auto couple.
5. Trace mode = max hold.
6. Allow trace to fully stabilize.
7. Use the peak marker function to determine the maximum power level in any 100 kHz band segment within the fundamental EBW.

#### MEASUREMENT PROCEDURE OOBE

1. Set RBW = 100 kHz.
2. Set VBW  $\geq$  300 kHz.
3. Detector = peak.
4. Sweep = auto couple.
5. Trace Mode = max hold.
6. Allow trace to fully stabilize.
7. Use the peak marker function to determine the maximum amplitude level.

### 4.6.5 Deviation from Test Standard

No deviation.

### 4.6.6 EUT Operating Condition

Same as Item 4.3.6

### 4.6.7 Test Results

The spectrum plots are attached on the following pages. D1 line indicates the highest level, and D2 line indicates the 20dB offset below D1. It shows compliance with the requirement.

802.11b

CH 1

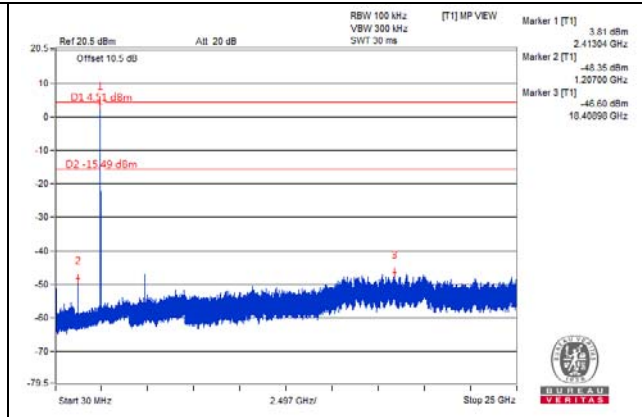
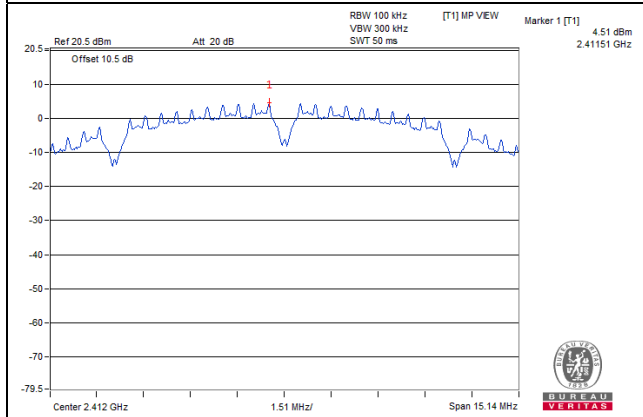

CH 6

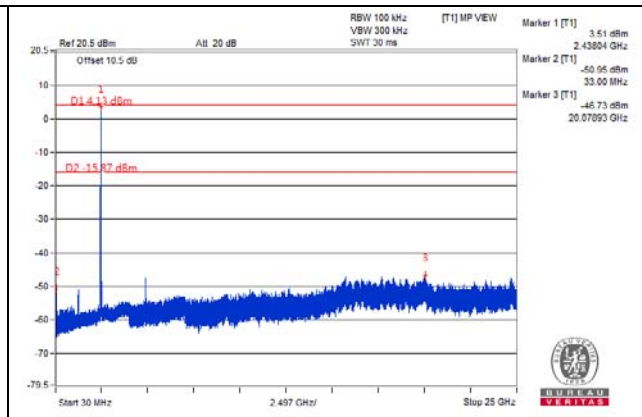
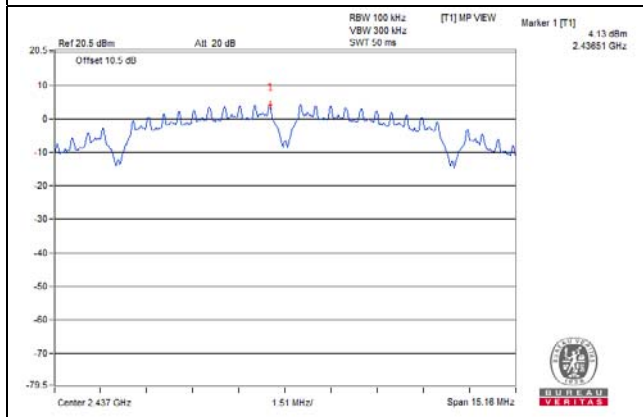

CH 11

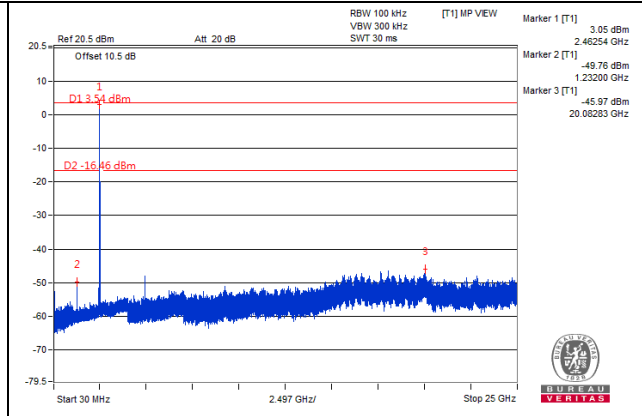
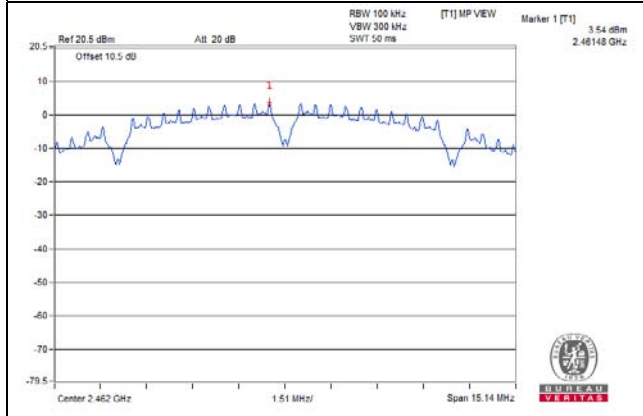

CH 1 Band edge

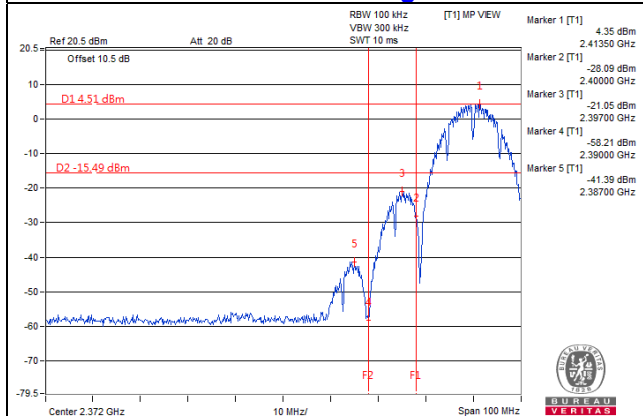

CH 11 Band edge

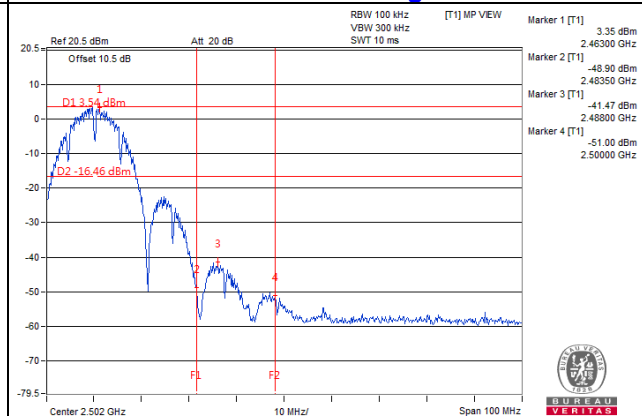

802.11g

CH 1

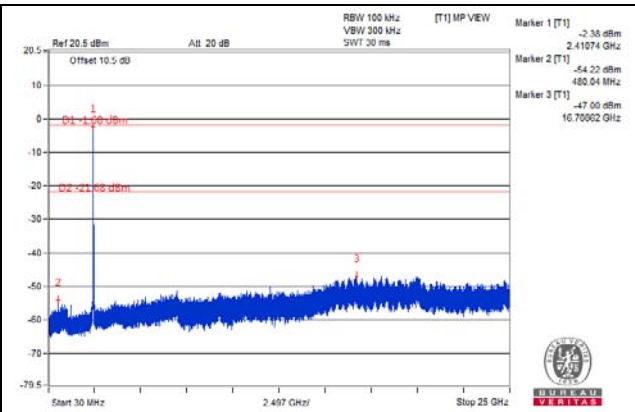
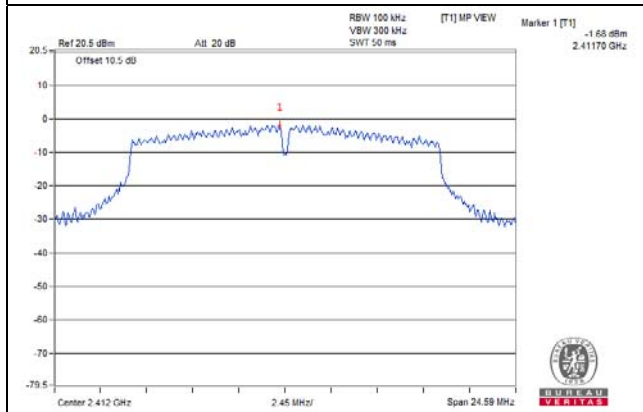

CH 6

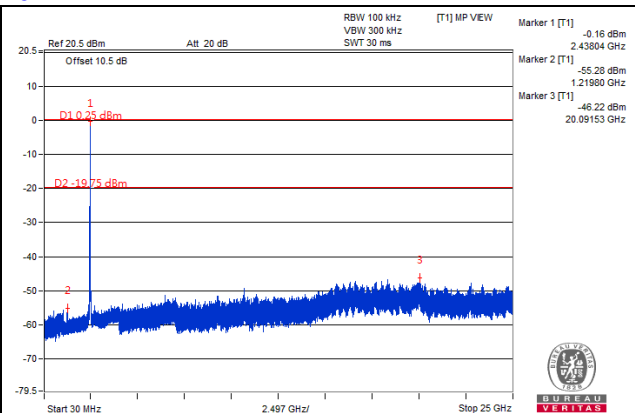
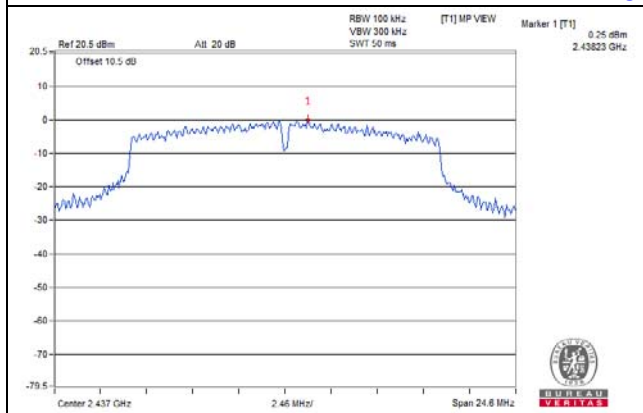

CH 11

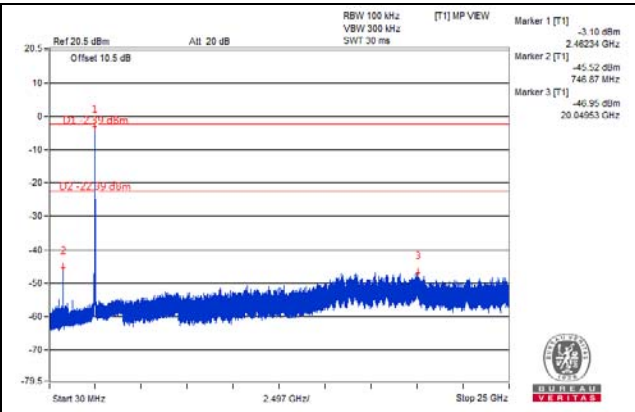
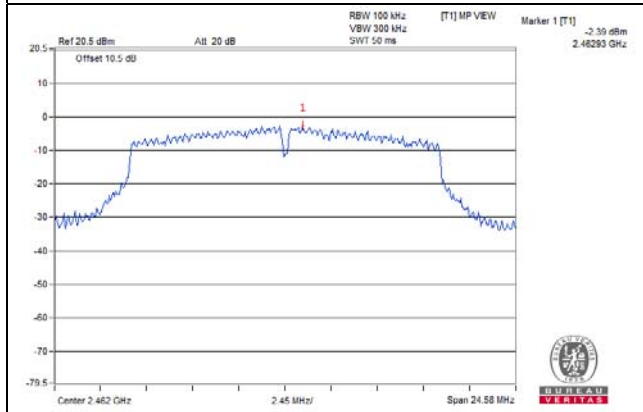

CH 1 Band edge

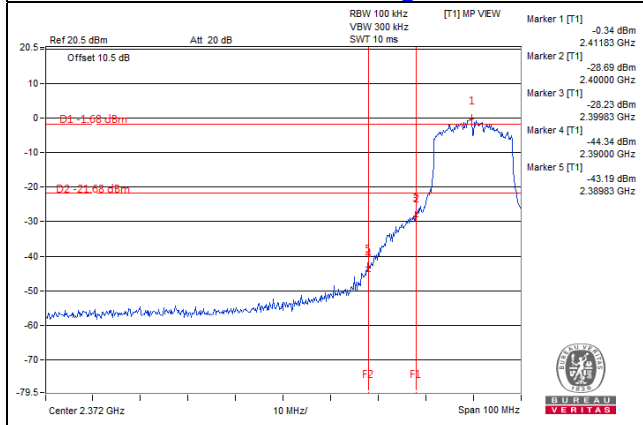

CH 11 Band edge

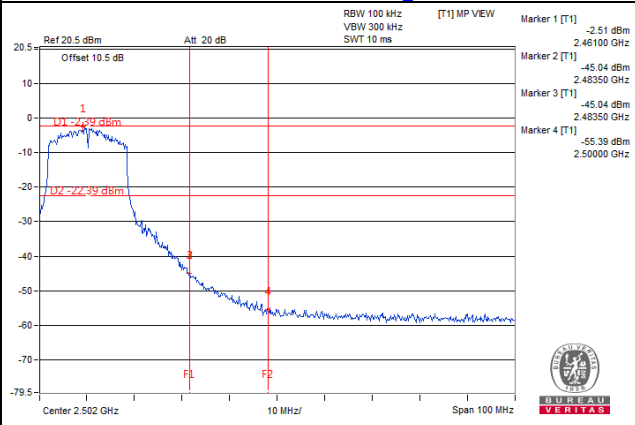

802.11n (20MHz)

CH 1

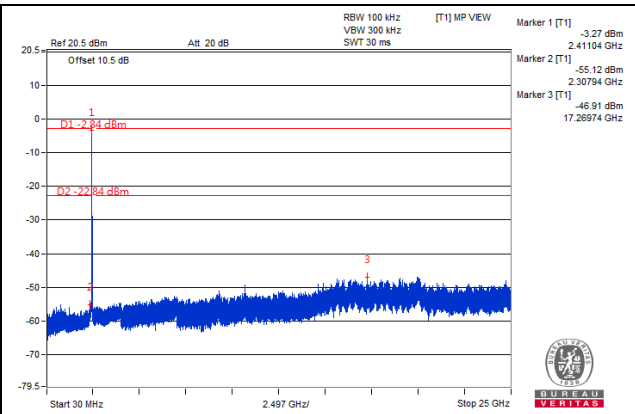
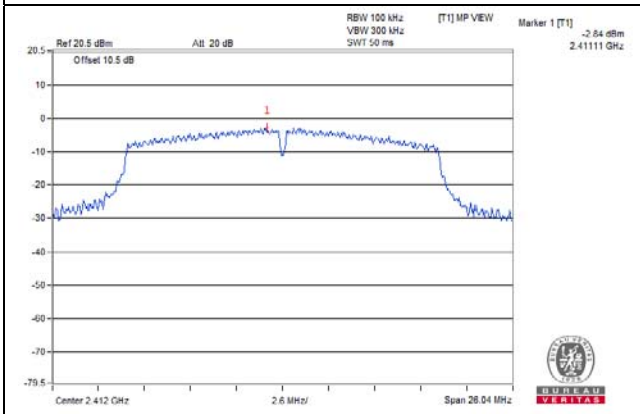

CH 6

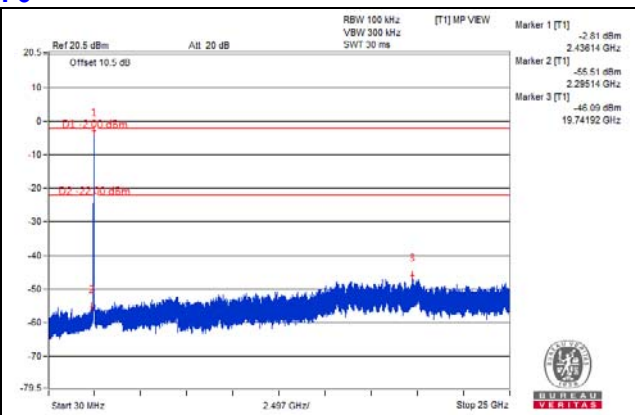
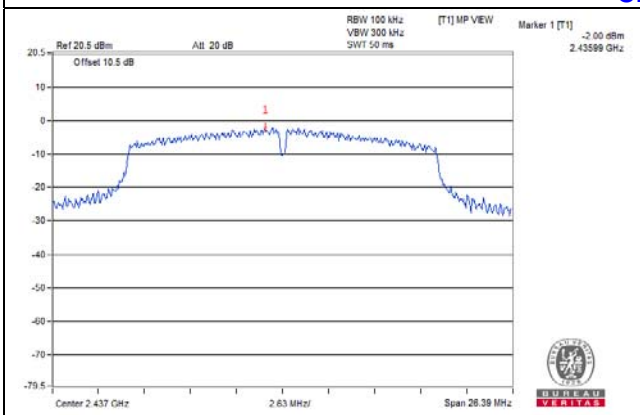

CH 11

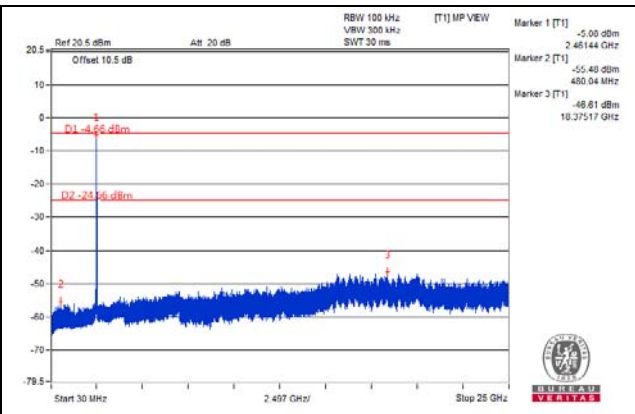
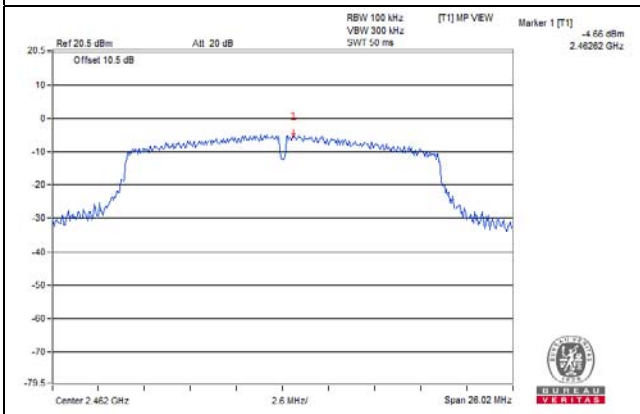

CH 1 Band edge

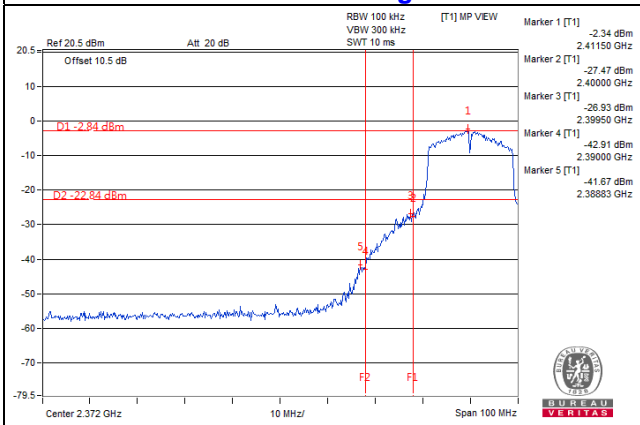

CH 11 Band edge

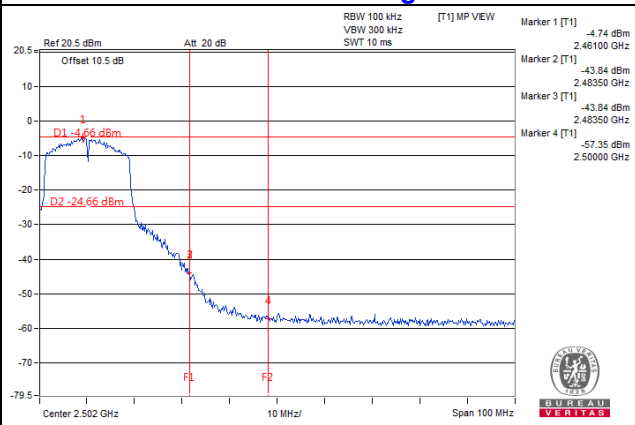



802.11n (40MHz)

CH 3

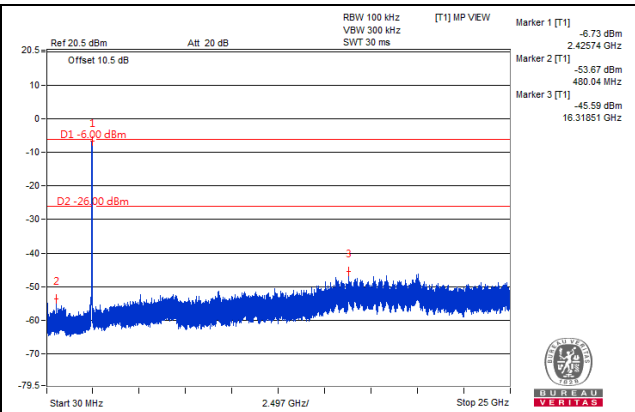
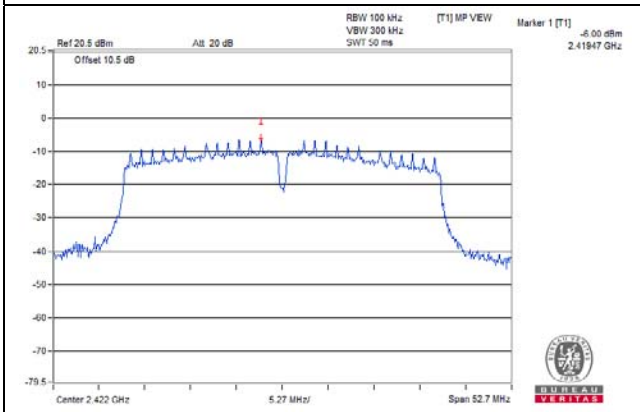

CH 6

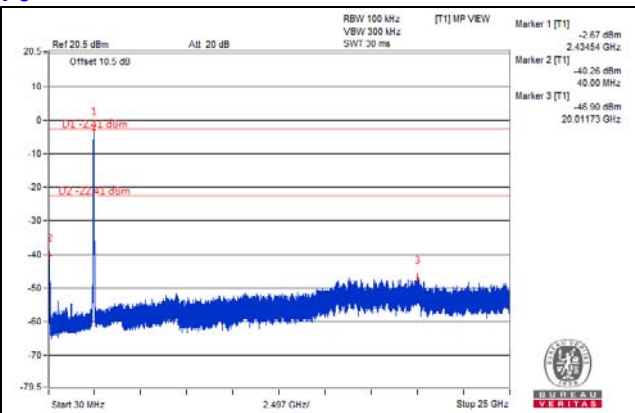
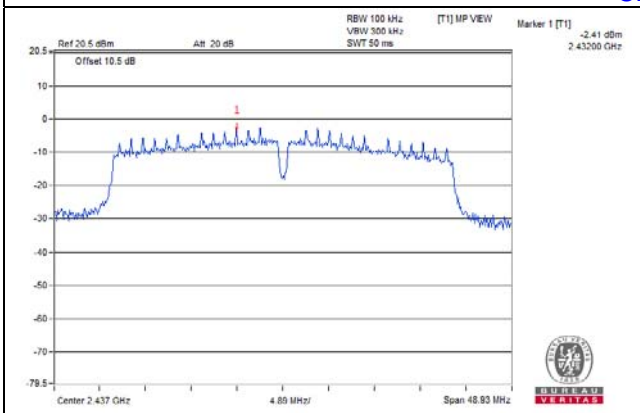

CH 9

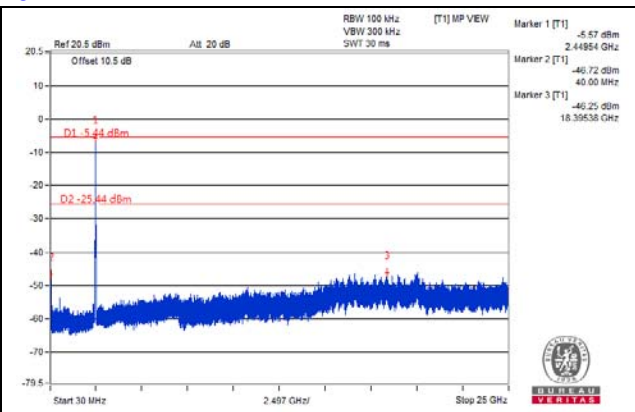
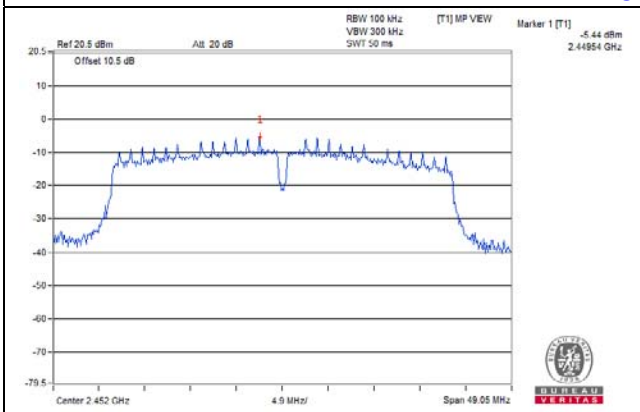

CH 3 Band edge

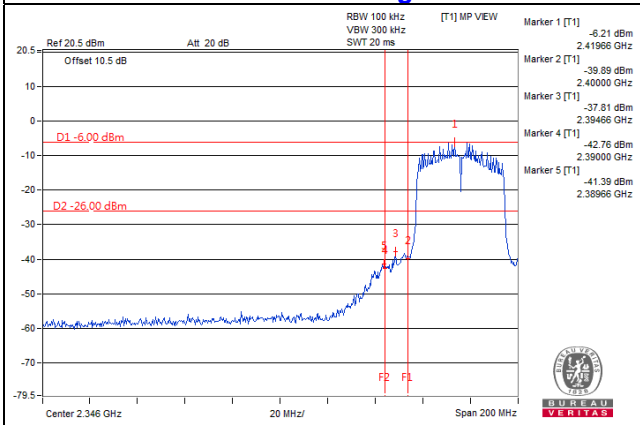

CH 9 Band edge

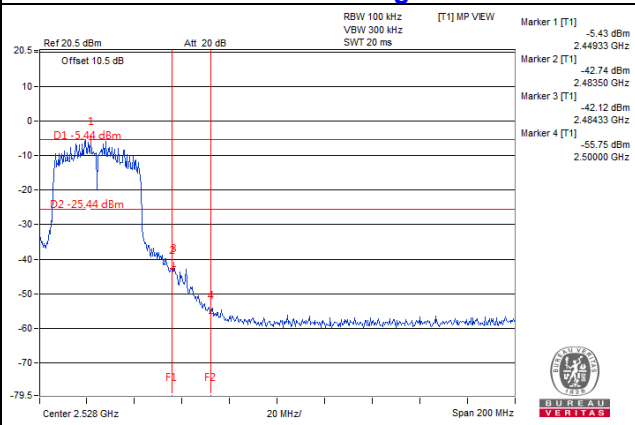

## 5 Pictures of Test Arrangements

Please refer to the attached file (Test Setup Photo).

## Appendix – Information on the Testing Laboratories

We, Bureau Veritas Consumer Products Services (H.K.) Ltd., Taoyuan Branch, were founded in 1988 to provide our best service in EMC, Radio, Telecom and Safety consultation. Our laboratories are accredited and approved according to ISO/IEC 17025.

If you have any comments, please feel free to contact us at the following:

**Linko EMC/RF Lab**

Tel: 886-2-26052180

Fax: 886-2-26051924

**Hsin Chu EMC/RF/Telecom Lab**

Tel: 886-3-6668565

Fax: 886-3-6668323

**Hwa Ya EMC/RF/Safety Lab**

Tel: 886-3-3183232

Fax: 886-3-3270892

**Email:** [service.adt@tw.bureauveritas.com](mailto:service.adt@tw.bureauveritas.com)

**Web Site:** [www.bureauveritas-adt.com](http://www.bureauveritas-adt.com)

The address and road map of all our labs can be found in our web site also.

--- END ---