



## Test Report

Product Name	WHDI Tx board
Model No	WV300A
FCC ID.	PPQ-WV300A

Applicant	LITE-ON Technology Corp.
Address	4F, No.90, Chien 1 Rd., Chung-Ho, Taipei Hsien 235, Taiwan

Date of Receipt	Sep. 16, 2011
Issue Date	Oct. 12, 2011
Report No.	119315R-RFUSP28V01
Report Version	V1.0

The test results relate only to the samples tested.

The test report shall not be reproduced except in full without the written approval of Quietek Corporation.

This report must not be used to claim product endorsement by NVLAP any agency of the U.S. Government

# Test Report Certification

Issue Date: Oct. 12, 2011

Report No.: 119315R-RFUSP28V01



**Accredited by NIST (NVLAP)**  
NVLAP Lab Code: 200533-0

Product Name	WHDI Tx board
Applicant	LITE-ON Technology Corp.
Address	4F, No.90, Chien 1 Rd., Chung-Ho, Taipei Hsien 235, Taiwan
Manufacturer	DONG GUAN G-COM COMPUTER CO., LTD.
Model No.	WV300A
EUT Rated Voltage	DC 5V (Power by AC Adapter)
EUT Test Voltage	AC 120V/60Hz
Trade Name	LITE-ON
Applicable Standard	FCC CFR Title 47 Part 15 Subpart C: 2010 ANSI C63.4: 2009
Test Result	Complied



The test results relate only to the samples tested.

The test report shall not be reproduced except in full without the written approval of Quietek Corporation.

This report must not be used to claim product endorsement by NVLAP any agency of the U.S. Government

Documented By : Joanne Lin  
( Adm. Specialist / Joanne Lin )



Tested By : Jack Hsu  
( Assistant Engineer / Jack Hsu )



Approved By : Vincent Lin  
( Manager / Vincent Lin )

## TABLE OF CONTENTS

Description	Page
<b>1. GENERAL INFORMATION .....</b>	<b>5</b>
1.1. EUT Description .....	5
1.2. Operational Description .....	6
1.3. Tested System Details .....	7
1.4. Configuration of Tested System .....	8
1.5. EUT Exercise Software .....	9
1.6. Test Facility .....	10
<b>2. Conducted Emission.....</b>	<b>11</b>
2.1. Test Equipment .....	11
2.2. Test Setup .....	11
2.3. Limits .....	12
2.4. Test Procedure .....	12
2.5. Uncertainty .....	12
2.6. Test Result of Conducted Emission.....	13
<b>3. Peak Power Output .....</b>	<b>15</b>
3.1. Test Equipment .....	15
3.2. Test Setup .....	15
3.3. Limits .....	15
3.4. Test Procedure .....	15
3.5. Uncertainty .....	15
3.6. Test Result of Peak Power Output .....	16
<b>4. Radiated Emission.....</b>	<b>18</b>
4.1. Test Equipment .....	18
4.2. Test Setup .....	19
4.3. Limits .....	20
4.4. Test Procedure .....	21
4.5. Uncertainty .....	21
4.6. Test Result of Radiated Emission.....	22
<b>5. RF antenna conducted test.....</b>	<b>29</b>
5.1. Test Equipment .....	29
5.2. Test Setup .....	29
5.3. Limits .....	29
5.4. Test Procedure .....	30
5.5. Uncertainty .....	30
5.6. Test Result of RF antenna conducted test.....	31
<b>6. Band Edge .....</b>	<b>73</b>
6.1. Test Equipment .....	73
6.2. Test Setup .....	74
6.3. Limits .....	74
6.4. Test Procedure .....	75
6.5. Uncertainty .....	75
6.6. Test Result of Band Edge .....	76

---

<b>7.</b>	<b>Occupied Bandwidth.....</b>	<b>92</b>
7.1.	Test Equipment.....	92
7.2.	Test Setup .....	92
7.3.	Limits .....	92
7.4.	Test Procedure .....	92
7.5.	Uncertainty .....	92
7.6.	Test Result of Occupied Bandwidth .....	93
<b>8.</b>	<b>Power Density .....</b>	<b>113</b>
8.1.	Test Equipment.....	113
8.2.	Test Setup .....	113
8.3.	Limits .....	113
8.4.	Test Procedure .....	113
8.5.	Uncertainty .....	113
8.6.	Test Result of Power Density .....	114
<b>9.</b>	<b>EMI Reduction Method During Compliance Testing .....</b>	<b>129</b>

Attachment 1: EUT Test Photographs

Attachment 2: EUT Detailed Photographs

## 1. GENERAL INFORMATION

### 1.1. EUT Description

Product Name	WHDI Tx board
Trade Name	LITE-ON
Model No.	WV300A
FCC ID.	PPQ-WV300A
Frequency Range	20MHz-BW: 5745-5825MHz 40MHz-BW: 5755-5795MHz
Number of Channels	20MHz-BW: 5; 40MHz-BW: 2
Maximum Data Rate	20MHz-BW: 31.5Mbps; 40MHz-BW: 63MHz
Channel Separation	20MHz-BW: 20MHz, 40MHz-BW: 40MHz
Antenna Gain	Refer to the table "Antenna List"
Antenna type	Printer on PCB
Type of Modulation	OFDM
Channel Control	Auto
Power Adapter	MFR: APD, M/N: WA-15C05FU Input: AC 100-240V, 50-60Hz, 0.5A Max Output: DC 5V, 3A Cable Out: Non-Shielded, 1.5m

#### Antenna List

No.	Manufacturer	Part No.	Peak Gain
1	Liteon	N/A	2dBi for 5.725~5.85GHz

Note: The antenna of EUT is conform to FCC 15.203

20MHz Center Working Frequency of Each Channel:

Channel	Frequency	Channel	Frequency	Channel	Frequency	Channel	Frequency
Channel 149:	5745 MHz	Channel 153:	5765 MHz	Channel 157:	5785 MHz	Channel 161:	5805 MHz
Channel 165:	5825 MHz						

40MHz Center Working Frequency of Each Channel:

Channel	Frequency	Channel	Frequency
Channel 151:	5755 MHz	Channel 159:	5795 MHz

Note:

1. This device is a WHDI Tx board with a built-in 5GHz transceiver.
2. Regarding to the operation frequency, the lowest, middle and highest frequency are selected to perform the test.
3. These tests are conducted on a sample for the purpose of demonstrating compliance of 5GHz transmitter with Part 15 Subpart C Paragraph 15.247 of spread spectrum devices.
4. The radiation measurements are performed in X, Y, Z axis positioning. Only the worst case is shown in the report.

## 1.2. Operational Description

The EUT is a Full HD Video Wireless Transmitter Module with a built-in 5GHz transceiver, together with Full HD Video Wireless Receiver Module. It has a SIMO design of five channel and one slow rate output wireless channel, which generates an upstream channel for data content transmissions.

The data modulation is OFDM, using five antennas to support 4(Transmit) \* 1(Receive) technology. The device only provided one transmitting speed 31.5Mbps in 20MHz bandwidth mode and 63Mbps in 40MHz bandwidth mode. Presents the ultimate solution for converting any High Definition (HD) system, including Full HD, into a wireless one. These add-on modules enable wireless A/V applications that fit easily into the living room and eliminate traditional A/V wiring. The perfect HD video and audio quality and the high robustness are unmatched by any other wireless technology and present a true alternative to cable. The WHDI system transmits uncompressed video and audio streams wirelessly and thus simplifies and eliminates system issues, such as: lip-sync, large buffers and other burdens like retransmissions or error propagation.

The device can transmit audio and video signal to associate equipment, device will receive signal form associate equipment when associate equipment request change operation frequency. The AMN2120 WHDITM baseband transmitter chip is the heart of the WV300A WHDI transmitter module. The AMN2120 interfaces the A/V source through the WHDI connector. The AMN2120 includes an internal microcontroller for controlling the physical level. The AMN2120 is based on MIMO technology transmitting through up to four output channels. Four digital-to-analog converters and one analog-to-digital converter are embedded within the chip. The AMN2120 internal PLL accepts an input clock frequency of 40MHz. The input frequency is multiplied and then used as an internal system clock. The AMN2120 also generates a 10 MHz reference clock, derived from 40 MHz for general use.

The AMN3110 is a fully-integrated direct conversion MIMO transmitter specifically designed for WHDI applications using OFDM modulation in 5.15-5.25GHz and 5.725~5.850GHz. The device consists of:

- Four Complete Downlink Direct Conversion Transmitters.
- One Uplink Receiver.
- Integrated Synthesizer.
- Internal DC Servo Loops.
- RSSI.
- IQ Detector.
- RF and Baseband Control Interface.
- Power Management Unit.
- 3-Wire SPI Interface.

To complete the RF front-end solution, the AMN3110 uses external PA, RF switches, RF Band Pass Filters (BPF), RF BALUNs and a few passive components.

The device antenna are use five FIFA(4TX, 1RX) and printed on PCB, for receiver function there are support one external antenna which can instead of printed antenna.

Test Mode:	Mode 1: Transmit (31.5Mbps 20MBW)
	Mode 2: Transmit (63Mbps 40MBW)

### 1.3. Tested System Details

The types for all equipment, plus descriptions of all cables used in the tested system (including inserted cards) are:

Product	Manufacturer	Model No.	Serial No.	Power Cord
1 Notebook PC	DELL	PPT	N/A	Non-Shielded, 0.8m
2 Monitor	LG	W2261VT	907YHPB07296	Non-Shielded, 1.8m
3 Microphone & Earphone	Ergotech	ET-E201	N/A	N/A
4 Modem	ACEEX	DM-1414	0102027558	Non-Shielded, 1.8m
5 DVD ROM	DELL	PD01S	N/A	N/A

Signal Cable Type	Signal cable Description
A Microphone & Earphone Cable	Non-Shielded, 1.2m
B Modem Cable	Shielded, 1.5m
C USB Cable	Shielded, 0.55m
D USB Cable	Shielded, 0.45m
E HDMI Cable	Shielded, 1.5m
F D-SUB Cable	Non-Shielded, 1.8m, with two ferrite cores bonded.

### 1.4. Configuration of Tested System

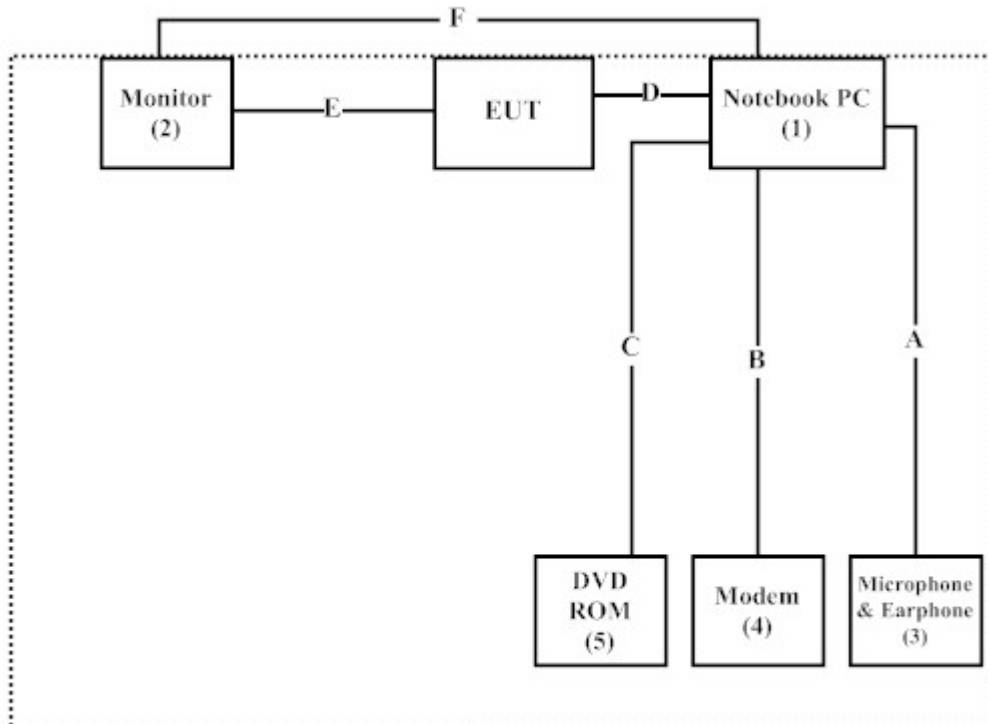



## 1.5. EUT Exercise Software

- (1) Setup the EUT as shown in Section 1.4
- (2) Execute “APPcom” program on the Notebook.
- (3) Configure the test mode, the test channel, and the data rate.
- (4) Press “OK” to start the continuous Transmit.
- (5) Verify that the EUT works properly.

**1.6. Test Facility**

Ambient conditions in the laboratory:

Items	Required (IEC 68-1)	Actual
Temperature (°C)	15-35	20-35
Humidity (%RH)	25-75	50-65
Barometric pressure (mbar)	860-1060	950-1000

The related certificate for our laboratories about the test site and management system can be downloaded from Quietek Corporation's Web Site : <http://www.quietek.com/tw/ctg/cts/accreditations.htm>

The address and introduction of Quietek Corporation's laboratories can be founded in our Web site : <http://www.quietek.com/>

Site Description: File on  
 Federal Communications Commission  
 FCC Engineering Laboratory  
 7435 Oakland Mills Road  
 Columbia, MD 21046  
 Registration Number: 92195



Accreditation on NVLAP  
 NVLAP Lab Code: 200533-0



Site Name: Quietek Corporation  
 Site Address: No.5-22, Ruishukeng Linkou Dist., New Taipei City  
 24451, Taiwan, R.O.C.  
 TEL: 886-2-8601-3788 / FAX : 886-2-8601-3789  
 E-Mail : [service@quietek.com](mailto:service@quietek.com)

FCC Accreditation Number: TW1014



## 2. Conducted Emission

### 2.1. Test Equipment

The following test equipment are used during the conducted emission test:

Item	Instrument	Manufacturer	Type No./Serial No	Last Cal.	Remark
1	Test Receiver	R & S	ESCS 30/825442/17	May, 2011	
2	L.I.S.N.	R & S	ESH3-Z5/825016/6	May, 2011	EUT
3	L.I.S.N.	Kyoritsu	KNW-407/8-1420-3	May, 2011	Peripherals
4	Pulse Limiter	R & S	ESH3-Z2	May, 2011	
5	No.1 Shielded Room			N/A	

Note: All instruments are calibrated every one year.

### 2.2. Test Setup

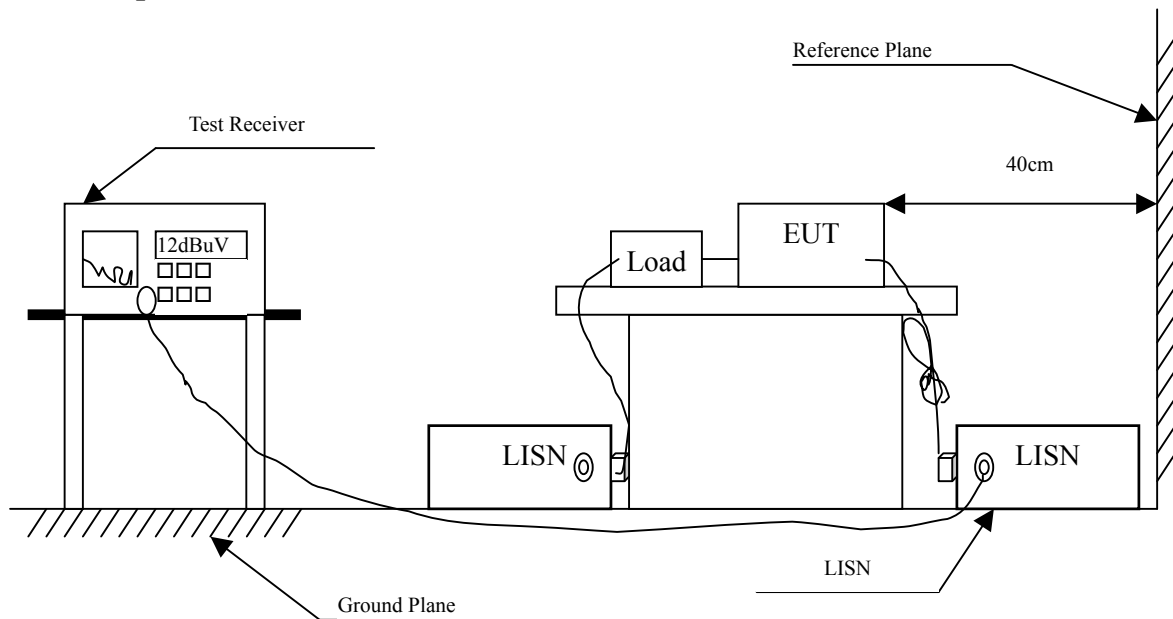

**2.3. Limits**

<b>FCC Part 15 Subpart C Paragraph 15.207 (dBuV) Limit</b>		
Frequency MHz	Limits	
	QP	AVG
0.15 - 0.50	66-56	56-46
0.50-5.0	56	46
5.0 - 30	60	50

**2.4. Test Procedure**

The EUT and simulators are connected to the main power through a line impedance stabilization network (L.I.S.N.). This provides a 50 ohm /50uH coupling impedance for the measuring equipment. The peripheral devices are also connected to the main power through a LISN that provides a 50ohm /50uH coupling impedance with 50ohm termination. (Please refers to the block diagram of the test setup and photographs.)

Both sides of A.C. line are checked for maximum conducted interference. In order to find the maximum emission, the relative positions of equipment and all of the interface cables must be changed according to ANSI C63.4: 2009 on conducted measurement.

Conducted emissions were invested over the frequency range from 0.15MHz to 30MHz using a receiver bandwidth of 9kHz.

**2.5. Uncertainty**

± 2.26 dB

## 2.6. Test Result of Conducted Emission

Product : WHDI Tx board  
 Test Item : Conducted Emission Test  
 Power Line : Line 1  
 Test Mode : Mode 2: Transmit (63Mbps 40MBW) (5755MHz)

Frequency MHz	Correct Factor dB	Reading Level dBuV	Measurement Level dBuV	Margin dB	Limit dBuV
<b>Line 1</b>					
<b>Quasi-Peak</b>					
0.205	9.703	47.980	57.683	-6.746	64.429
0.279	9.657	37.100	46.757	-15.557	62.314
0.412	9.646	35.400	45.046	-13.468	58.514
0.720	9.631	40.720	50.351	-5.649	56.000
3.720	9.700	23.960	33.660	-22.340	56.000
14.685	9.980	32.680	42.660	-17.340	60.000
<b>Average</b>					
0.205	9.703	34.540	44.243	-10.186	54.429
0.279	9.657	20.570	30.227	-22.087	52.314
0.412	9.646	24.520	34.166	-14.348	48.514
0.720	9.631	30.930	40.561	-5.439	46.000
3.720	9.700	13.250	22.950	-23.050	46.000
14.685	9.980	24.520	34.500	-15.500	50.000

Note:

1. All Reading Levels are Quasi-Peak and average value.
2. "■" means the worst emission level.
3. Measurement Level = Reading Level + Correct Factor

Product : WHDI Tx board  
 Test Item : Conducted Emission Test  
 Power Line : Line 2  
 Test Mode : Mode 2: Transmit (63Mbps 40MBW) (5755MHz)

Frequency MHz	Correct Factor dB	Reading Level dBuV	Measurement Level dBuV	Margin dB	Limit dBuV
<b>Line 2</b>					
<b>Quasi-Peak</b>					
0.185	9.727	44.960	54.688	-10.312	65.000
0.259	9.680	39.800	49.480	-13.406	62.886
0.330	9.660	43.020	52.680	-8.177	60.857
0.736	9.656	38.460	48.116	-7.884	56.000
4.935	9.700	26.460	36.160	-19.840	56.000
14.826	9.990	31.020	41.010	-18.990	60.000
<b>Average</b>					
0.185	9.727	25.760	35.488	-19.512	55.000
0.259	9.680	25.100	34.780	-18.106	52.886
0.330	9.660	31.840	41.500	-9.357	50.857
0.736	9.656	27.950	37.606	-8.394	46.000
4.935	9.700	13.720	23.420	-22.580	46.000
14.826	9.990	22.070	32.060	-17.940	50.000

Note:

1. All Reading Levels are Quasi-Peak and average value.
2. "■" means the worst emission level.
3. Measurement Level = Reading Level + Correct Factor

### 3. Peak Power Output

#### 3.1. Test Equipment

	Equipment	Manufacturer	Model No./Serial No.	Last Cal.
X	Power Meter	Anritsu	ML2495A/6K00003357	May, 2011
X	Power Sensor	Anritsu	MA2411B/0738448	Jun, 2011

Note:

1. All equipments are calibrated with traceable calibrations. Each calibration is traceable to the national or international standards.
2. The test instruments marked with “X” are used to measure the final test results.

#### 3.2. Test Setup

Conducted Measurement

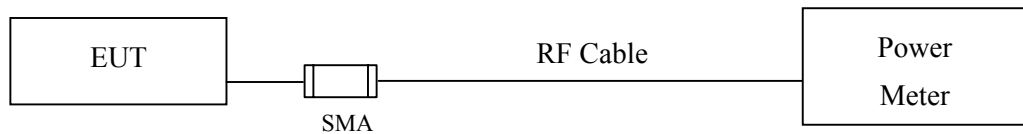

#### 3.3. Limits

The maximum peak power shall be less 1 Watt.

#### 3.4. Test Procedure

The EUT was tested according to DTS test procedure of Mar. 2005 KDB558074 for compliance to FCC 47CFR 15.247 requirements.

#### 3.5. Uncertainty

± 1.27 dB

### 3.6. Test Result of Peak Power Output

Product : WHDI Tx board  
 Test Item : Peak Power Output Data  
 Test Site : No.3 OATS  
 Test Mode : Mode 1: Transmit (31.5Mbps 20MBW)

#### CHAIN A+B+C+D

Channel	Frequency (MHz)	Data Rata (Mbps)	Chain A Power (dBm)	Chain B Power (dBm)	Chain C Power (dBm)	Chain D Power (dBm)	Chain A+B+C+D Power (dBm)	Limit (dBm)	Result
149	5745	31.5	24.02	21.66	20.17	21.29	28.04	<30dBm	Pass
157	5785	31.5	22.54	21.47	20.51	20.90	27.44	<30dBm	Pass
165	5825	31.5	21.93	20.78	20.56	21.06	27.14	<30dBm	Pass

Note: Peak Power Output Value (dBm) = 10\*LOG (Chain A (mW)+ Chain B (mW) + Chain C (mW) + Chain D (mW))



Product : WHDI Tx board  
 Test Item : Peak Power Output Data  
 Test Site : No.3 OATS  
 Test Mode : Mode 2: Transmit (63Mbps 40MBW)

**CHAIN A+B+C+D**

Channel	Frequency (MHz)	Data Rate (Mbps)	Chain A Power (dBm)	Chain B Power (dBm)	Chain C Power (dBm)	Chain D Power (dBm)	Chain A+B+C+D Power (dBm)	Limit (dBm)	Result
151	5755	63	22.72	20.54	20.00	21.07	27.23	<30dBm	Pass
159	5795	63	23.56	20.43	19.60	22.78	27.91	<30dBm	Pass

Note: Peak Power Output Value (dBm) = 10\*LOG (Chain A (mW)+ Chain B (mW)+ Chain C (mW)+ Chain D (mW))

## 4. Radiated Emission

### 4.1. Test Equipment

The following test equipment are used during the radiated emission test:

Test Site		Equipment	Manufacturer	Model No./Serial No.	Last Cal.
☒ Site # 3	X	Bilog Antenna	Schaffner Chase	CBL6112B/2673	Sep., 2011
	X	Horn Antenna	Schwarzbeck	BBHA9120D/D305	Sep., 2011
	X	Horn Antenna	Schwarzbeck	BBHA9170/208	Jul., 2011
	X	Pre-Amplifier	QTK	QTK-AMP-03 / 0003	May, 2011
	X	Pre-Amplifier	QTK	AP-180C / CHM_0906076	Sep., 2011
	X	Pre-Amplifier	MITEQ	AMF-4D-180400-45-6P/ 925975	Mar, 2011
	X	Spectrum Analyzer	Agilent	E4407B / US39440758	May, 2011
	X	Test Receiver	R & S	ESCS 30/ 825442/018	Sep., 2011
	X	Coaxial Cable	Quietek	QTK-CABLE/ CAB5	Feb., 2011
	X	Controller	Quietek	QTK-CONTROLLER/ CTRL3	N/A
	X	Coaxial Switch	Anritsu	MP59B/6200265729	N/A

- Note:
1. All equipments are calibrated with traceable calibrations. Each calibration is traceable to the national or international standards.
  2. The test instruments marked with "X" are used to measure the final test results.

## 4.2. Test Setup

### Radiated Emission Below 1GHz

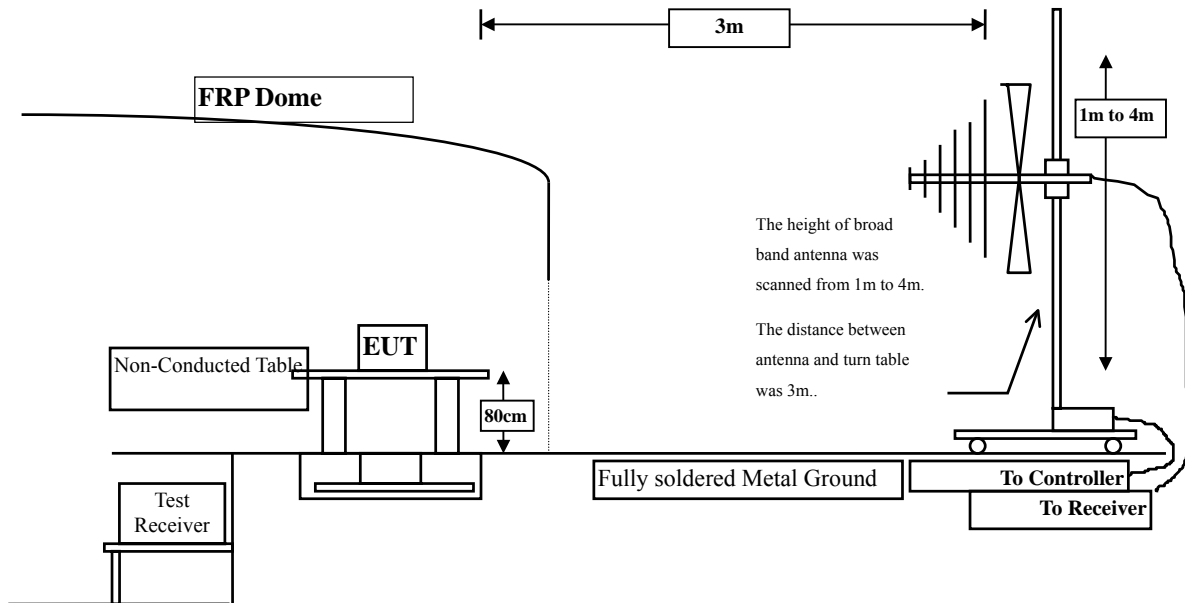

### Radiated Emission Above 1GHz

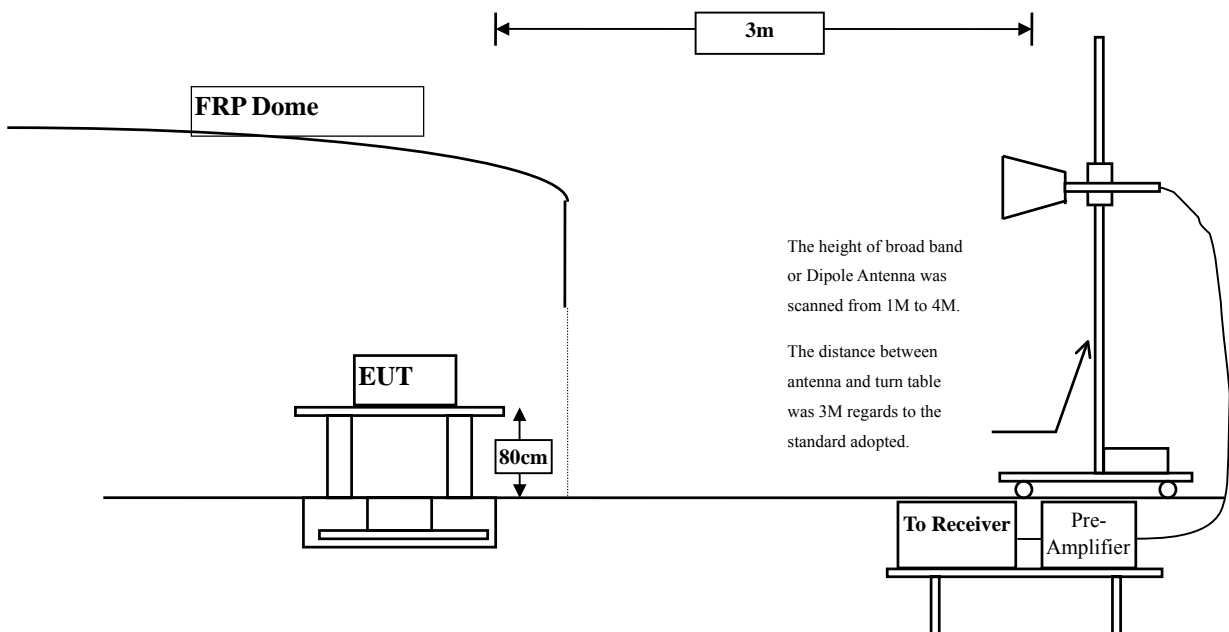

### 4.3. Limits

Emissions radiated outside of the specified frequency bands, except for harmonics, shall be attenuated by at least 20dB below the level of the fundamental or to the general radiated emission limits in paragraph 15.209, whichever is the lesser attenuation.

<b>FCC Part 15 Subpart C Paragraph 15.209(a) Limits</b>		
Frequency MHz	uV/m @3m	dBuV/m@3m
30-88	100	40
88-216	150	43.5
216-960	200	46
Above 960	500	54

Remarks: E field strength (dBuV/m) = 20 log E field strength (uV/m)

#### 4.4. Test Procedure

The EUT was setup according to ANSI C63.4, 2009 and tested according to DTS test procedure of Mar. 2005 KDB558074 for compliance to FCC 47CFR 15.247 requirements.

The EUT is placed on a turn table which is 0.8 meter above ground. The turn table is rotated 360 degrees to determine the position of the maximum emission level. The EUT was positioned such that the distance from antenna to the EUT was 3 meters.

The antenna is scanned between 1 meter and 4 meters to find out the maximum emission level. This is repeated for both horizontal and vertical polarization of the antenna. In order to find the maximum emission, all of the interface cables were manipulated according to ANSI C63.4:2009 on radiated measurement.

The resolution bandwidth below 1GHz setting on the field strength meter is 120 kHz and above 1GHz is 1MHz.

Radiated emission measurements below 1GHz are made using broadband Bilog antenna and above 1GHz are made using Horn Antennas.

The measurement is divided into the Preliminary Measurement and the Final Measurement.

The suspected frequencies are searched for in Preliminary Measurement with the measurement antenna kept pointed at the source of the emission both in azimuth and elevation, with the polarization of the antenna oriented for maximum response. The antenna is pointed at an angle towards the source of the emission, and the EUT is rotated in both height and polarization to maximize the measured emission. The emission is kept within the illumination area of the 3 dB bandwidth of the antenna.

The worst radiated emission is measured in the Open Area Test Site on the Final Measurement.

The measurement frequency range form 30MHz - 10th Harmonic of fundamental was investigated.

#### 4.5. Uncertainty

± 3.9 dB above 1GHz

± 3.8 dB below 1GHz

#### 4.6. Test Result of Radiated Emission

Product : WHDI Tx board  
 Test Item : Harmonic Radiated Emission Data  
 Test Site : No.3 OATS  
 Test Mode : Mode 1: Transmit (31.5Mbps 20MBW) (5745 MHz)

Frequency MHz	Correct Factor dB	Reading Level dBuV	Measurement Level dBuV/m	Margin dB	Limit dBuV/m
<b>Horizontal</b>					
<b>Peak Detector:</b>					
11490.000	17.106	35.500	52.607	-21.393	74.000
<b>Average Detector:</b>					
--					
<b>Vertical</b>					
<b>Peak Detector:</b>					
11490.000	18.034	41.890	59.925	-14.075	74.000
<b>Average Detector:</b>					
11490.000	18.034	33.310	51.345	-2.655	54.000

Note:

1. All Readings below 1GHz are Quasi-Peak, above 1GHz are performed with peak and/or average measurements as necessary.
2. Peak measurements: RBW = 1MHz, VBW = 3 MHz, Sweep: Auto.
3. Average measurements: RBW = 1MHz, VBW = 10 Hz, Sweep: Auto.
4. Measurement Level = Reading Level + Correct Factor.
5. Correct Factor = Antenna factor + Cable loss – Amplifier gain.
6. The average measurement was not performed when the peak measured data under the limit of average detection.
7. The emission levels of other frequencies are very lower than the limit and not show in test report.

Product : WHDI Tx board  
 Test Item : Harmonic Radiated Emission Data  
 Test Site : No.3 OATS  
 Test Mode : Mode 1: Transmit (31.5Mbps 20MBW) (5785 MHz)

Frequency MHz	Correct Factor dB	Reading Level dBuV	Measurement Level dBuV/m	Margin dB	Limit dBuV/m
<b>Horizontal</b>					
<b>Peak Detector:</b>					
11570.000	16.809	36.880	53.689	-20.311	74.000
<b>Average Detector:</b>					
--					
<b>Vertical</b>					
<b>Peak Detector:</b>					
11570.000	17.698	42.060	59.758	-14.242	11570.000
<b>Average Detector:</b>					
11570.000	17.698	31.630	49.328	-4.672	54.000

Note:

1. All Readings below 1GHz are Quasi-Peak, above 1GHz are performed with peak and/or average measurements as necessary.
2. Peak measurements: RBW = 1MHz, VBW = 3 MHz, Sweep: Auto.
3. Average measurements: RBW = 1MHz, VBW = 10 Hz, Sweep: Auto.
4. Measurement Level = Reading Level + Correct Factor.
5. Correct Factor = Antenna factor + Cable loss – Amplifier gain.
6. The average measurement was not performed when the peak measured data under the limit of average detection.
7. The emission levels of other frequencies are very lower than the limit and not show in test report.

Product : WHDI Tx board  
 Test Item : Harmonic Radiated Emission Data  
 Test Site : No.3 OATS  
 Test Mode : Mode 1: Transmit (31.5Mbps 20MBW) (5825 MHz)

Frequency MHz	Correct Factor dB	Reading Level dBUV	Measurement Level dBUV/m	Margin dB	Limit dBUV/m
<b>Horizontal</b>					
<b>Peak Detector:</b>					
11650.000	16.158	35.810	51.968	-22.032	74.000
<b>Average Detector:</b>					
--					
<b>Vertical</b>					
<b>Peak Detector:</b>					
11650.000	17.274	40.540	57.815	-16.186	74.000
<b>Average Detector:</b>					
11650.000	17.274	34.530	51.805	-2.195	54.000

Note:

1. All Readings below 1GHz are Quasi-Peak, above 1GHz are performed with peak and/or average measurements as necessary.
2. Peak measurements: RBW = 1MHz, VBW = 3 MHz, Sweep: Auto.
3. Average measurements: RBW = 1MHz, VBW = 10 Hz, Sweep: Auto.
4. Measurement Level = Reading Level + Correct Factor.
5. Correct Factor = Antenna factor + Cable loss – Amplifier gain.
6. The average measurement was not performed when the peak measured data under the limit of average detection.
7. The emission levels of other frequencies are very lower than the limit and not show in test report.



Product : WHDI Tx board  
 Test Item : Harmonic Radiated Emission Data  
 Test Site : No.3 OATS  
 Test Mode : Mode 2: Transmit (63Mbps 40MBW) (5755MHz)

Frequency MHz	Correct Factor dB	Reading Level dBuV	Measurement Level dBuV/m	Margin dB	Limit dBuV/m
<b>Horizontal</b>					
<b>Peak Detector:</b>					
11510.000	17.124	36.080	53.204	-20.796	74.000
<b>Average Detector:</b>					
--					
<b>Vertical</b>					
<b>Peak Detector:</b>					
11510.000	18.081	40.980	59.061	-14.939	74.000
<b>Average Detector:</b>					
11510.000	18.081	34.110	52.191	-1.809	54.000

Note:

1. All Readings below 1GHz are Quasi-Peak, above 1GHz are performed with peak and/or average measurements as necessary.
2. Peak measurements: RBW = 1MHz, VBW = 3 MHz, Sweep: Auto.
3. Average measurements: RBW = 1MHz, VBW = 10 Hz, Sweep: Auto.
4. Measurement Level = Reading Level + Correct Factor.
5. Correct Factor = Antenna factor + Cable loss – Amplifier gain.
6. The average measurement was not performed when the peak measured data under the limit of average detection.
7. The emission levels of other frequencies are very lower than the limit and not show in test report.

Product : WHDI Tx board  
 Test Item : Harmonic Radiated Emission Data  
 Test Site : No.3 OATS  
 Test Mode : Mode 2: Transmit (63Mbps 40MBW) (5795 MHz)

Frequency MHz	Correct Factor dB	Reading Level dBuV	Measurement Level dBuV/m	Margin dB	Limit dBuV/m
<b>Horizontal</b>					
<b>Peak Detector:</b>					
11590.000	16.701	35.780	52.480	-21.520	74.000
<b>Average Detector:</b>					
--					
<b>Vertical</b>					
<b>Peak Detector:</b>					
11590.000	17.567	40.770	58.336	-15.664	74.000
<b>Average Detector:</b>					
11590.000	17.567	32.920	50.486	-3.514	54.000

Note:

1. All Readings below 1GHz are Quasi-Peak, above 1GHz are performed with peak and/or average measurements as necessary.
2. Peak measurements: RBW = 1MHz, VBW = 3 MHz, Sweep: Auto.
3. Average measurements: RBW = 1MHz, VBW = 10 Hz, Sweep: Auto.
4. Measurement Level = Reading Level + Correct Factor.
5. Correct Factor = Antenna factor + Cable loss – Amplifier gain.
6. The average measurement was not performed when the peak measured data under the limit of average detection.
7. The emission levels of other frequencies are very lower than the limit and not show in test report.

Product : WHDI Tx board  
 Test Item : General Radiated Emission Data  
 Test Site : No.3 OATS  
 Test Mode : Mode 1: Transmit (31.5Mbps 20MBW) (5745MHz)

Frequency MHz	Correct Factor dB	Reading Level dBuV	Measurement Level dBuV/m	Margin dB	Limit dBuV/m
<b>Horizontal</b>					
111.480	-7.914	37.827	29.913	-13.587	43.500
258.920	-5.050	37.505	32.455	-13.545	46.000
398.600	-2.268	40.016	37.748	-8.252	46.000
662.440	2.084	30.282	32.366	-13.634	46.000
800.180	5.141	27.893	33.034	-12.966	46.000
930.160	7.187	26.923	34.110	-11.890	46.000
<b>Vertical</b>					
115.360	-2.630	37.393	34.763	-8.737	43.500
256.980	-7.573	36.961	29.388	-16.612	46.000
398.600	-4.678	37.511	32.833	-13.167	46.000
499.480	-0.852	35.514	34.662	-11.338	46.000
697.360	1.311	28.935	30.246	-15.754	46.000
796.300	2.831	37.759	40.590	-5.410	46.000

Note:

1. All Readings below 1GHz are Quasi-Peak, above 1GHz are performed with peak and/or average measurements as necessary.
2. Peak measurements: RBW = 1MHz, VBW = 3 MHz, Sweep: Auto.
3. Average measurements: RBW = 1MHz, VBW = 10 Hz, Sweep: Auto.
4. Measurement Level = Reading Level + Correct Factor.
5. Correct Factor = Antenna factor + Cable loss – Amplifier gain.
6. The average measurement was not performed when the peak measured data under the limit of average detection.
7. The emission levels of other frequencies are very lower than the limit and not show in test report.

Product : WHDI Tx board  
 Test Item : General Radiated Emission Data  
 Test Site : No.3 OATS  
 Test Mode : Mode 2: Transmit (63Mbps 40MBW) (5755MHz)

Frequency MHz	Correct Factor dB	Reading Level dBuV	Measurement Level dBuV/m	Margin dB	Limit dBuV/m
<b>Horizontal</b>					
113.420	-8.339	37.401	29.062	-14.438	43.500
398.600	-2.268	36.446	34.178	-11.822	46.000
530.520	1.873	30.161	32.034	-13.966	46.000
695.420	3.438	29.956	33.394	-12.606	46.000
800.180	5.141	28.033	33.174	-12.826	46.000
930.160	7.187	26.453	33.640	-12.360	46.000
<b>Vertical</b>					
109.540	-7.488	41.304	33.816	-9.684	43.500
258.920	-5.050	36.055	31.005	-14.995	46.000
400.540	-2.276	36.183	33.907	-12.093	46.000
497.540	-0.273	34.458	34.185	-11.815	46.000
800.180	5.141	31.818	36.959	-9.041	46.000
875.840	5.271	31.135	36.406	-9.594	46.000

Note:

1. All Readings below 1GHz are Quasi-Peak, above 1GHz are performed with peak and/or average measurements as necessary.
2. Peak measurements: RBW = 1MHz, VBW = 3 MHz, Sweep: Auto.
3. Average measurements: RBW = 1MHz, VBW = 10 Hz, Sweep: Auto.
4. Measurement Level = Reading Level + Correct Factor.
5. Correct Factor = Antenna factor + Cable loss – Amplifier gain.
6. The average measurement was not performed when the peak measured data under the limit of average detection.
7. The emission levels of other frequencies are very lower than the limit and not show in test report.

**5. RF antenna conducted test**

**5.1. Test Equipment**

	Equipment	Manufacturer	Model No./Serial No.	Last Cal.
X	Spectrum Analyzer	R&S	FSP40 / 100170	Jun, 2011
	Spectrum Analyzer	Agilent	E4407B / US39440758	Jun, 2011
X	Spectrum Analyzer	Agilent	N9010A / MY48030495	Apr., 2011

- Note:
1. All equipments are calibrated with traceable calibrations. Each calibration is traceable to the national or international standards.
  2. The test instruments marked with “X” are used to measure the final test results.

**5.2. Test Setup**

**RF antenna Conducted Measurement:**

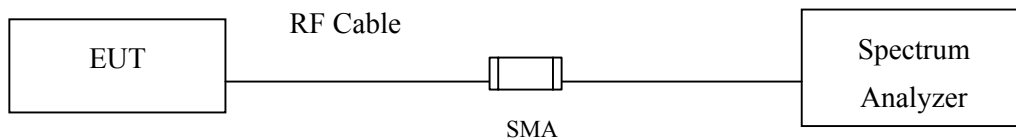

**5.3. Limits**

In any 100 kHz bandwidth outside the frequency band in which the spread spectrum intentional radiator is operating, the radio frequency power that is produced by the intentional radiator shall be at least 20 dB below that in the 100 kHz bandwidth within the band that contains the highest level of the desired power, based on either an RF conducted or a radiated measurement. Attenuation below the general limits specified in Section 15.209(a) is not required. In addition, radiated emissions which fall in the restricted bands, as defined in Section 15.205(a), must also comply with the radiated emission limits specified in Section 15.209(a) (see Section 15.205(c)).

#### 5.4. Test Procedure

The EUT was tested according to DTS test procedure of Mar. 2005 KDB558074 for compliance to FCC 47CFR 15.247 requirements.

Set RBW = 100 kHz, Set VBW > RBW, scan up through 10th harmonic.

#### 5.5. Uncertainty

The measurement uncertainty

Conducted is defined as  $\pm 1.27\text{dB}$

**5.6. Test Result of RF antenna conducted test**

Product : WHDI Tx board  
 Test Item : RF Antenna Conducted Spurious  
 Test Site : No.3 OATS  
 Test Mode : Mode 1: Transmit (31.5Mbps 20MBW)

**Channel 149 (5745MHz) 30MHz -40GHz-Chain A**

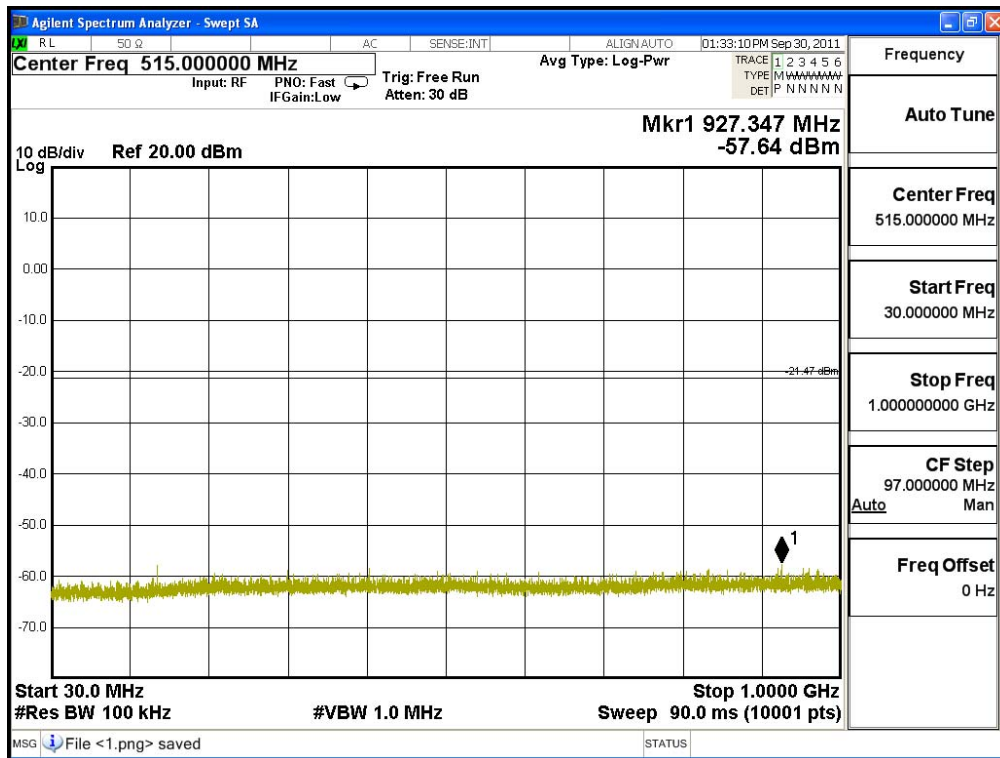

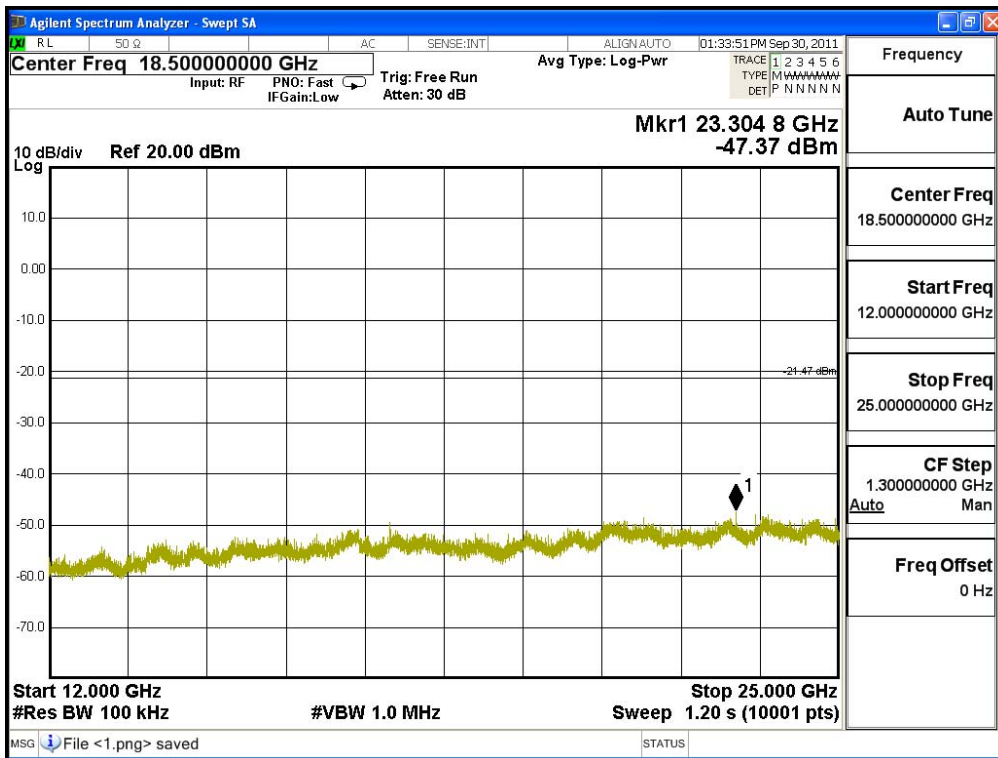
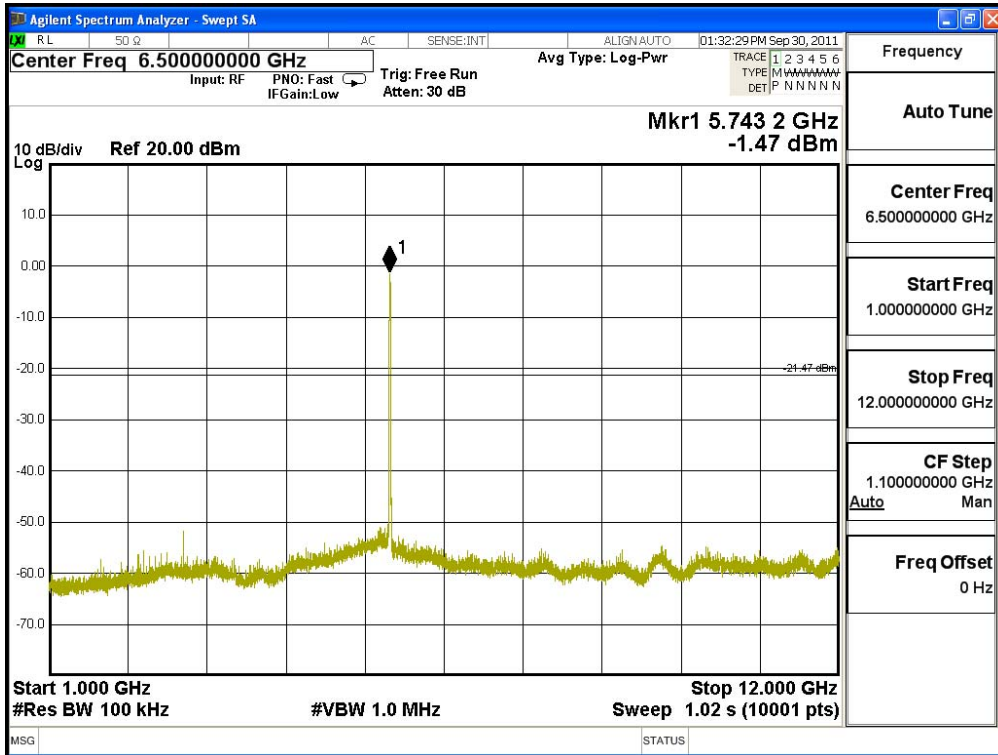



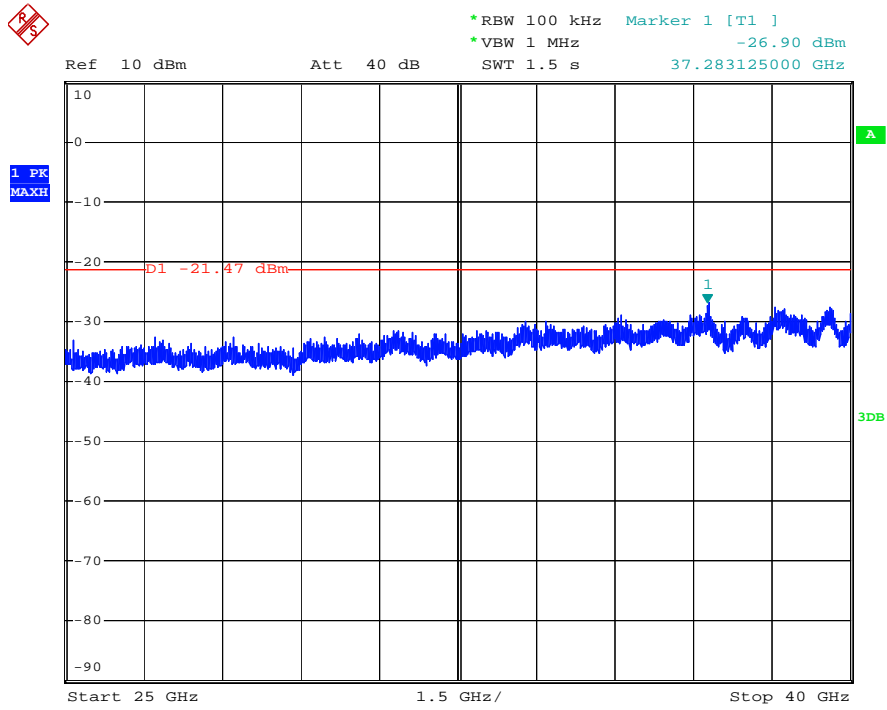

5190B-2

Date: 6.OCT.2011 03:20:27

**Channel 157 (5785MHz) 30MHz -40GHz-Chain A**

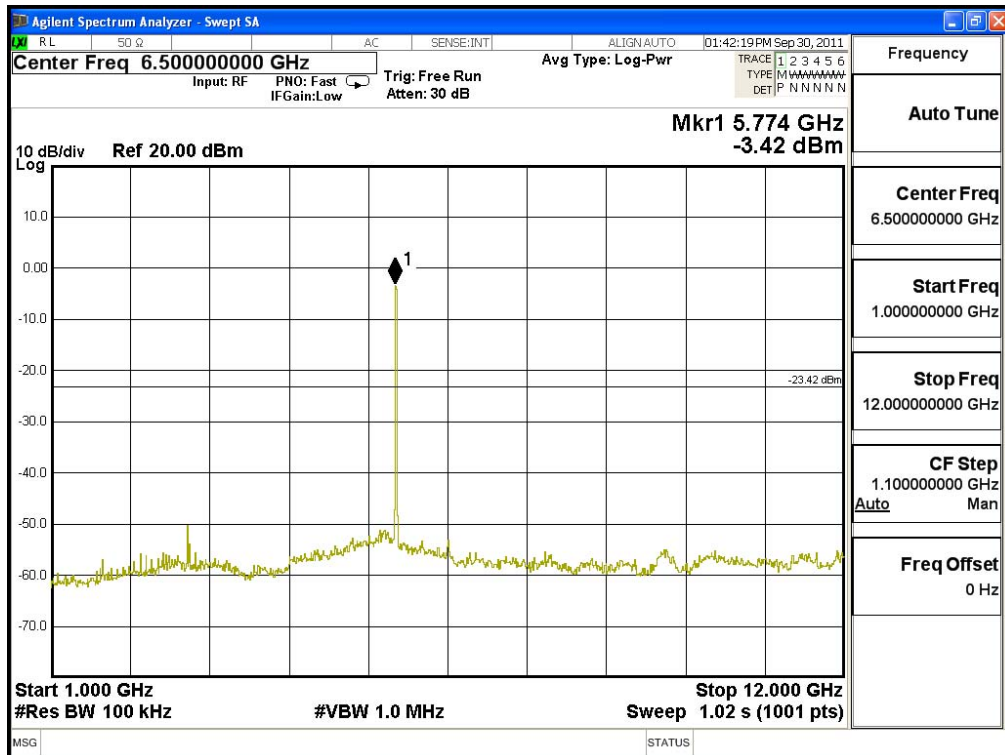
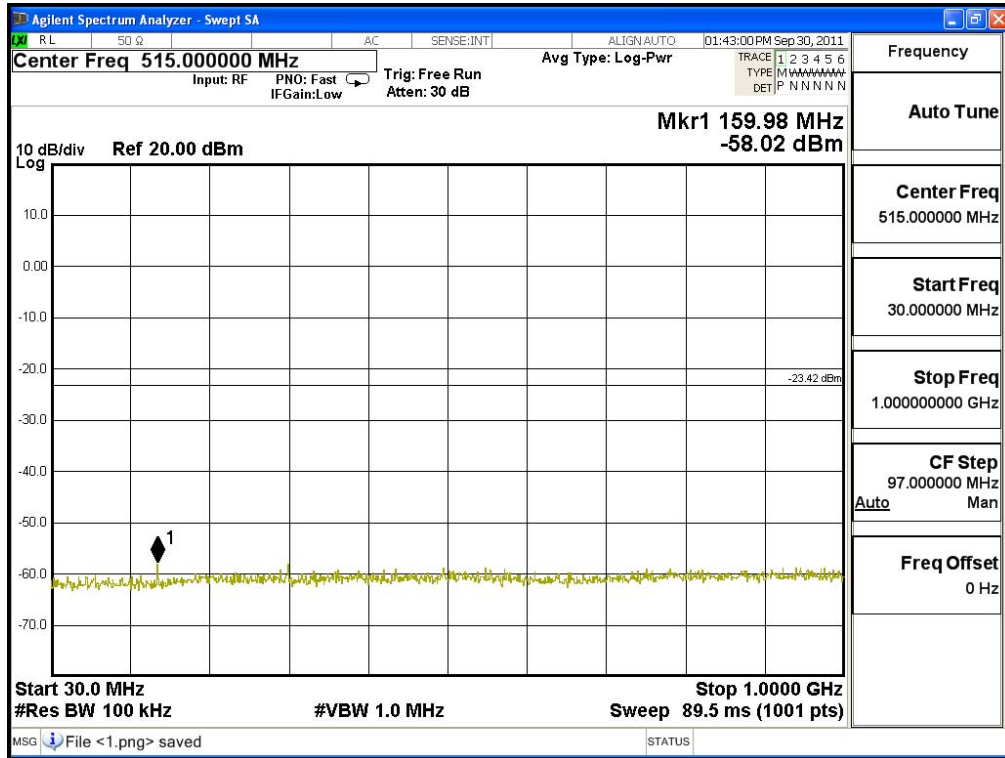

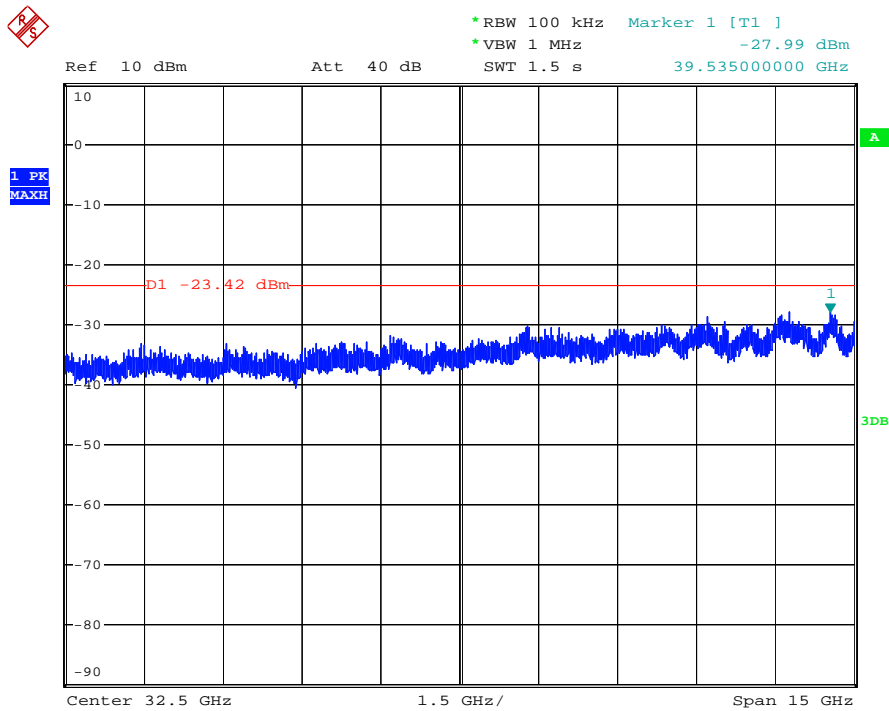
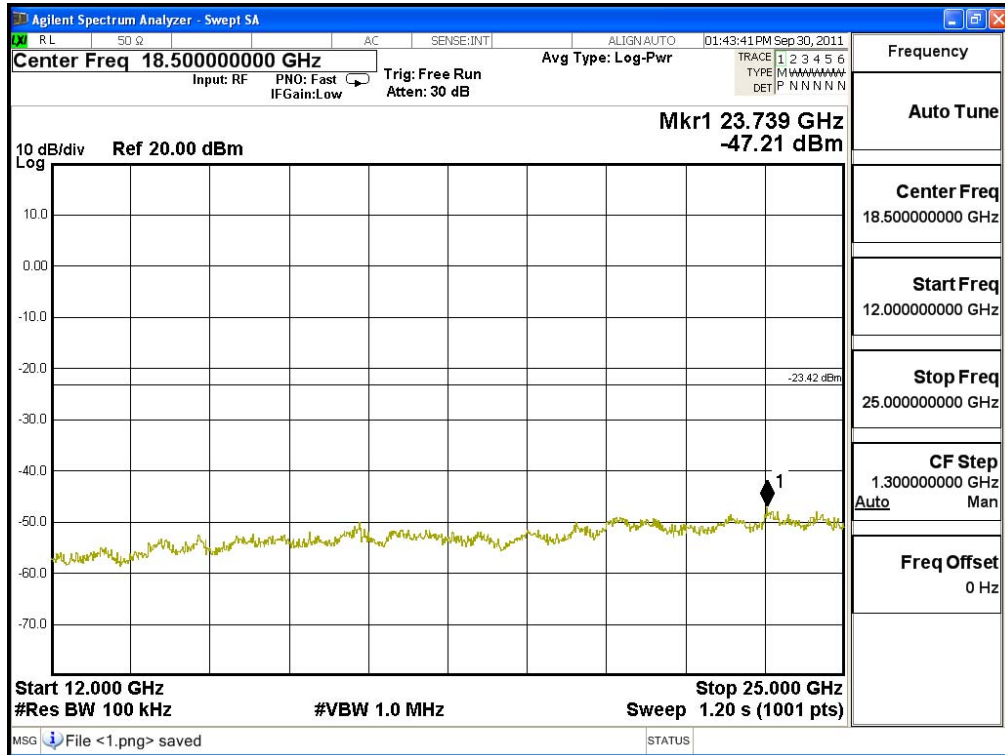

5190B-2

Date: 6.OCT.2011 03:29:16

**Channel 165 (5825MHz) 30MHz -40GHz-Chain A**

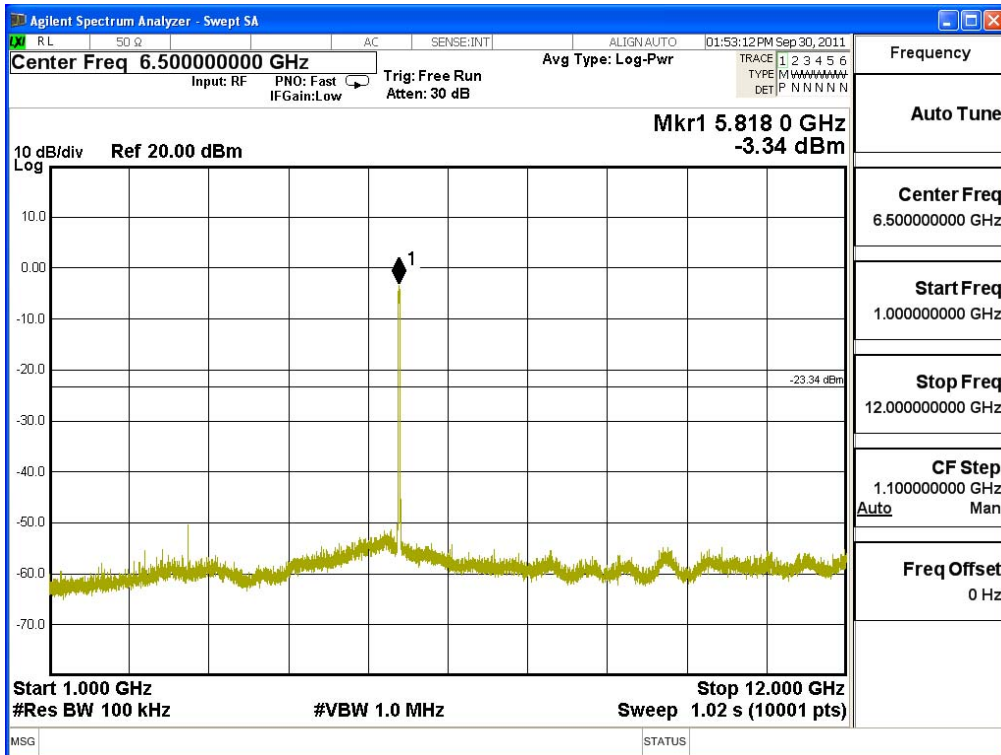
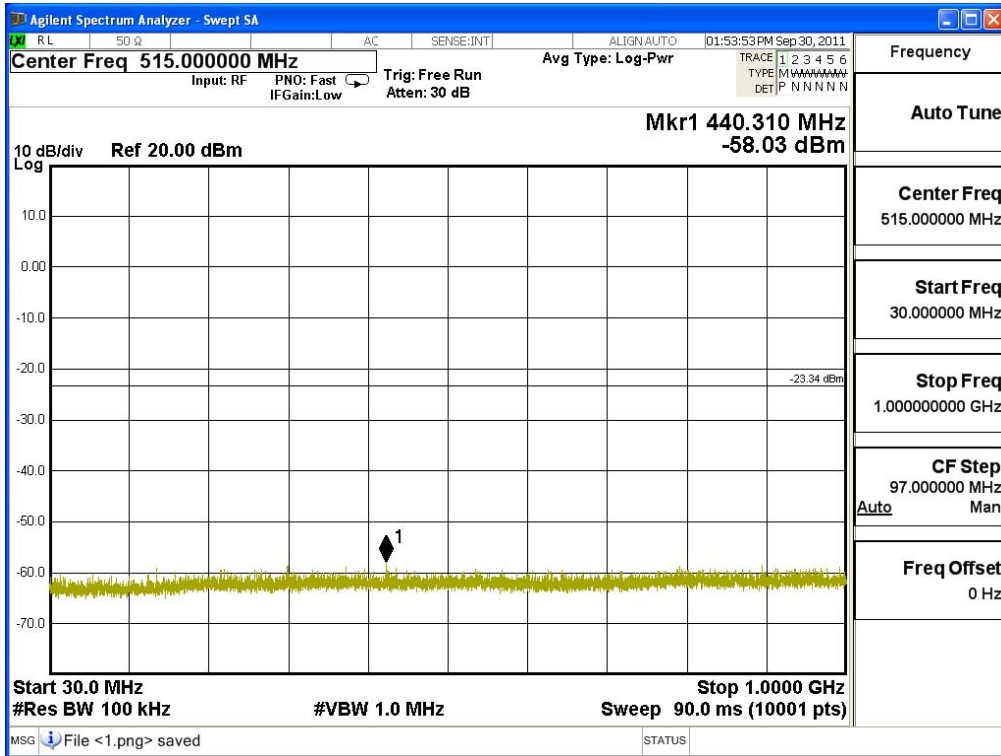

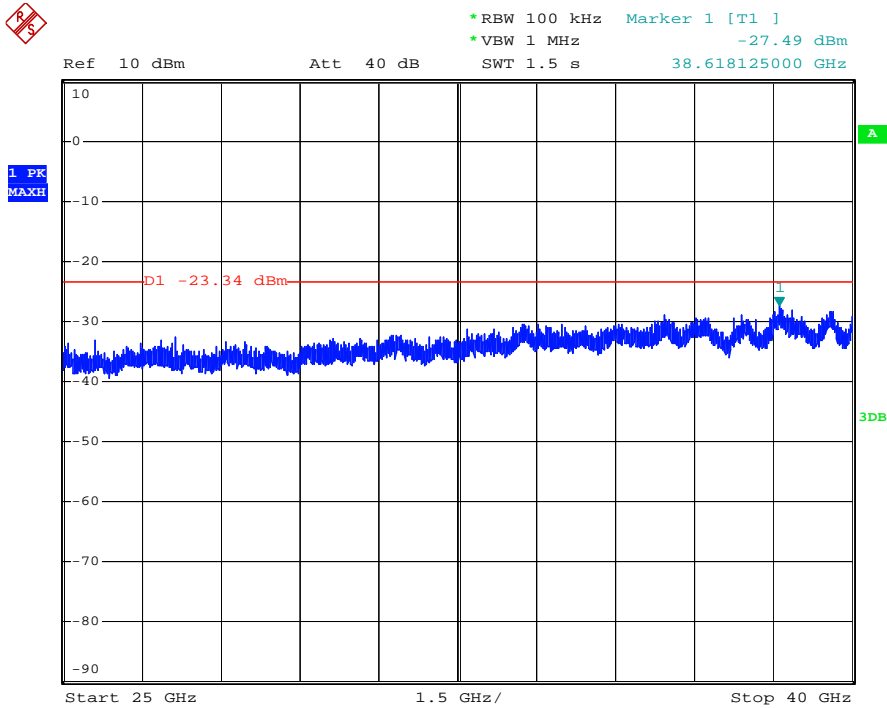
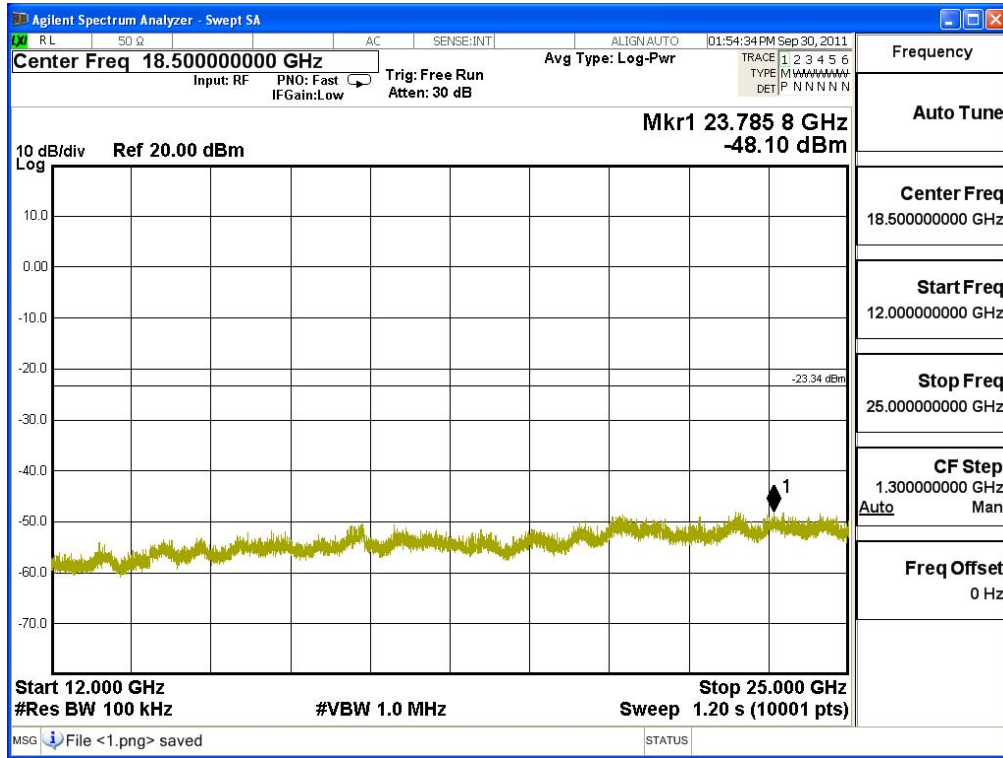

5190B-2

Date: 6.OCT.2011 03:32:39

**Channel 149 (5745MHz) 30MHz -40GHz-Chain B**

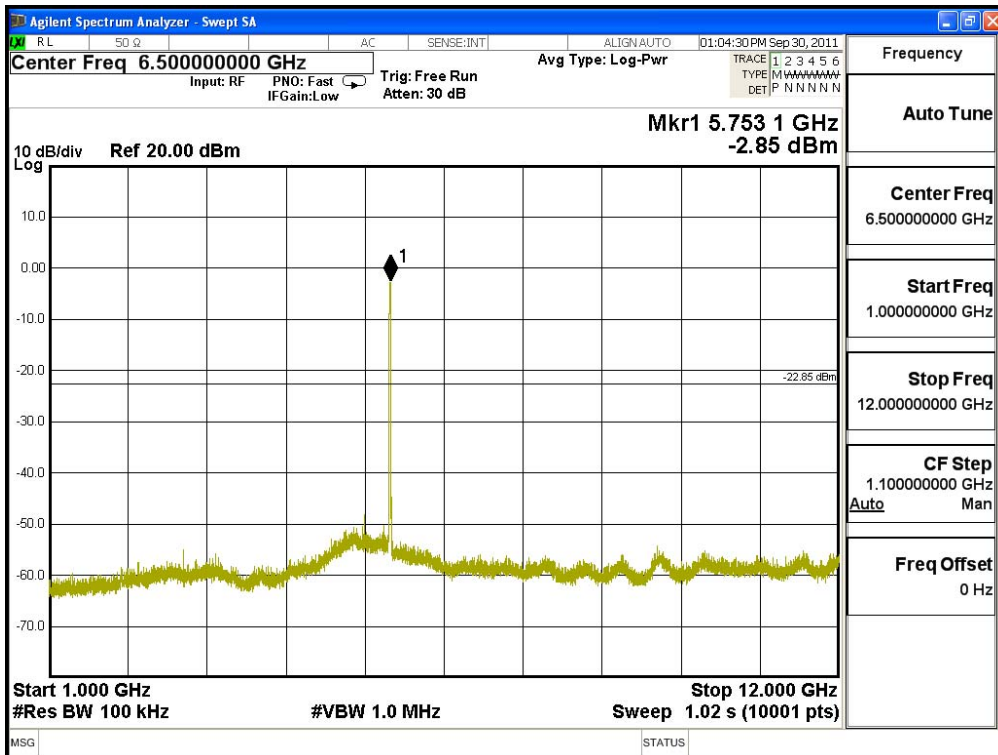
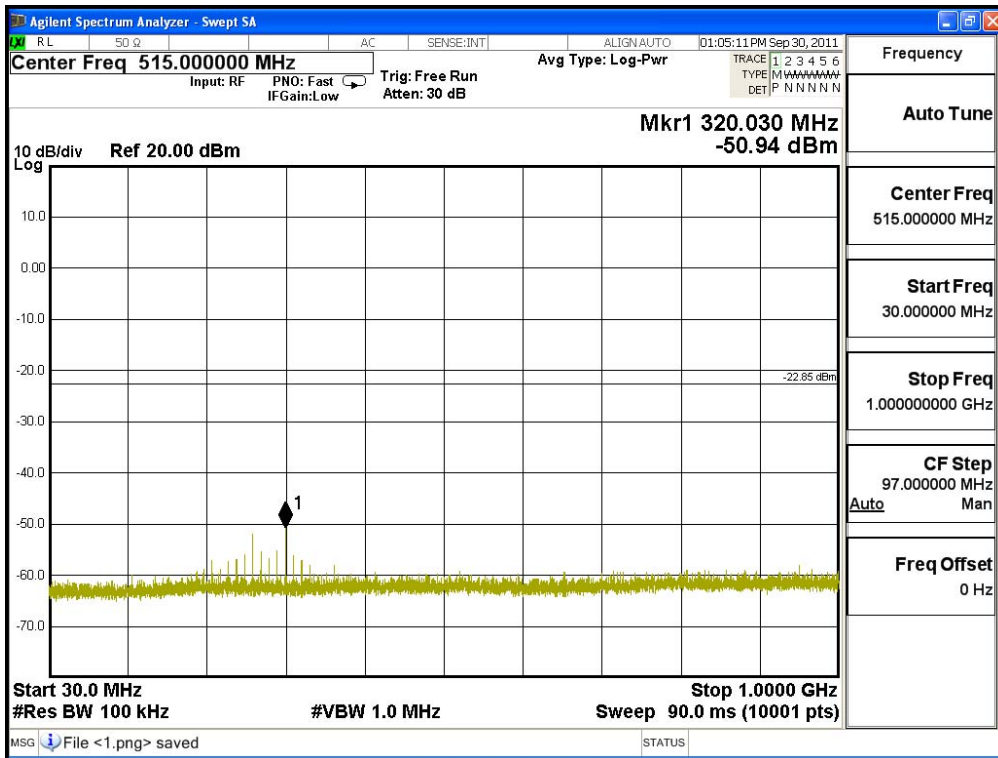

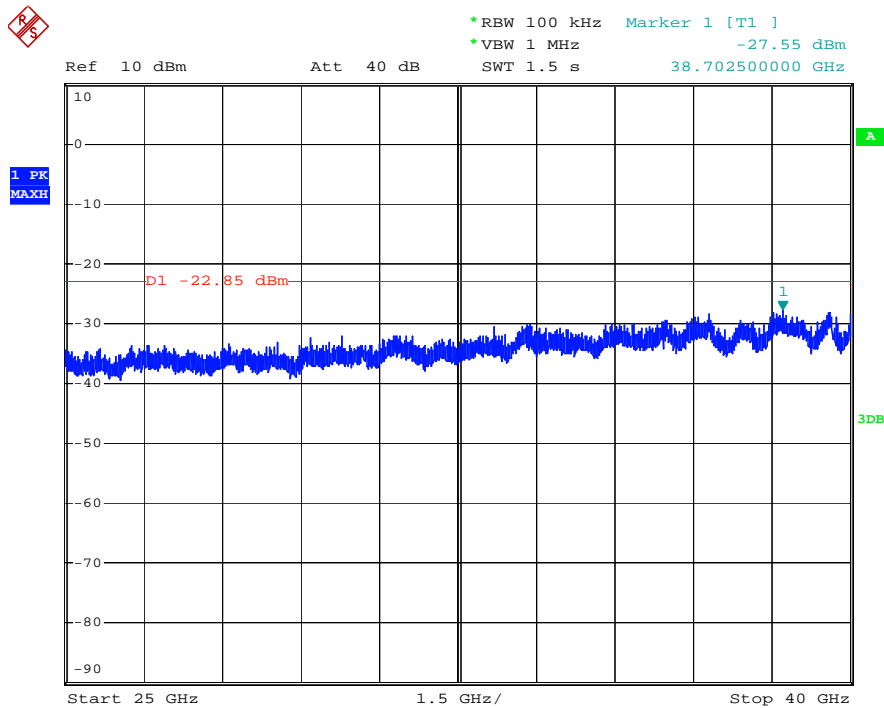
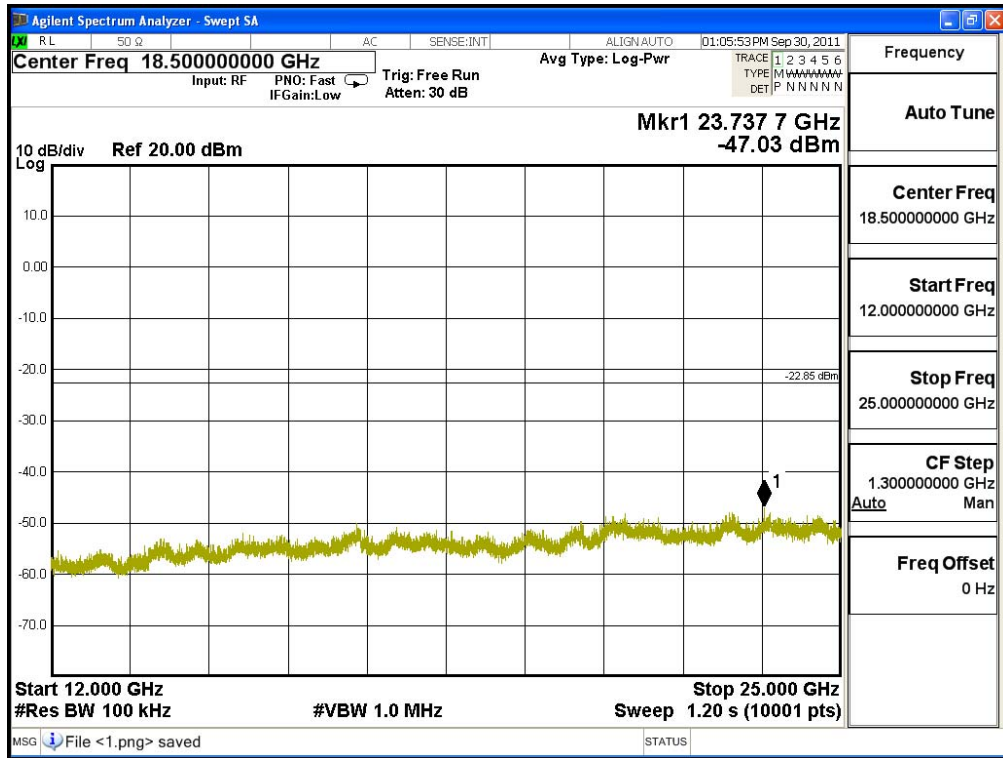

5190B-2

Date: 6.OCT.2011 03:26:10

**Channel 157 (5785MHz) 30MHz -40GHz-Chain B**

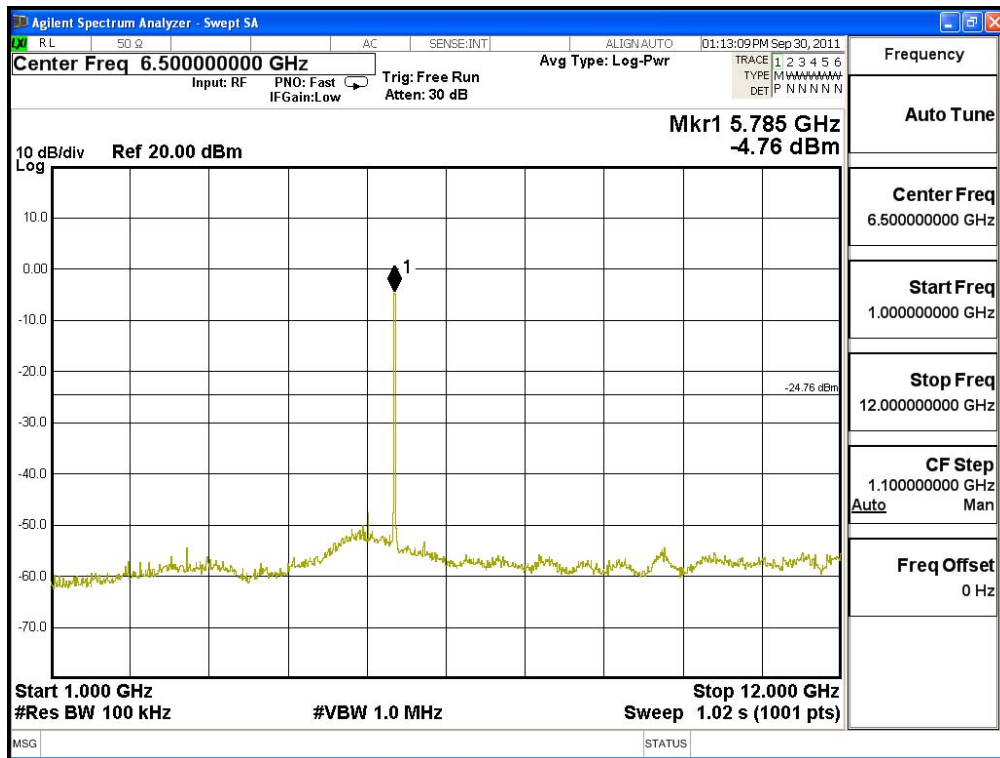
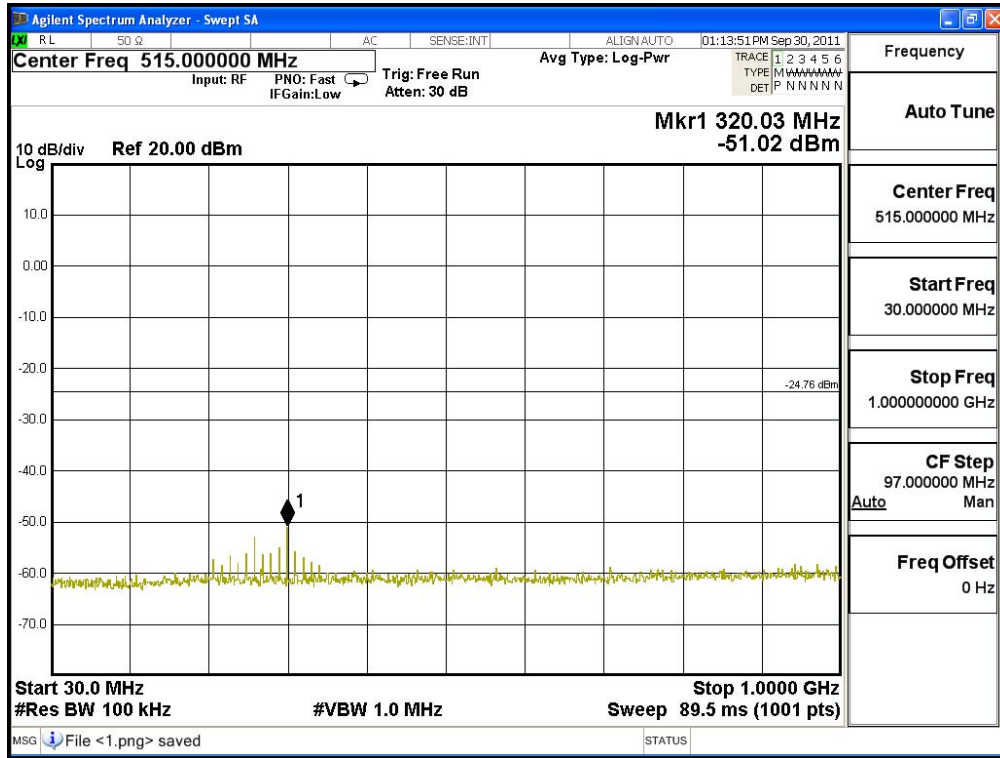



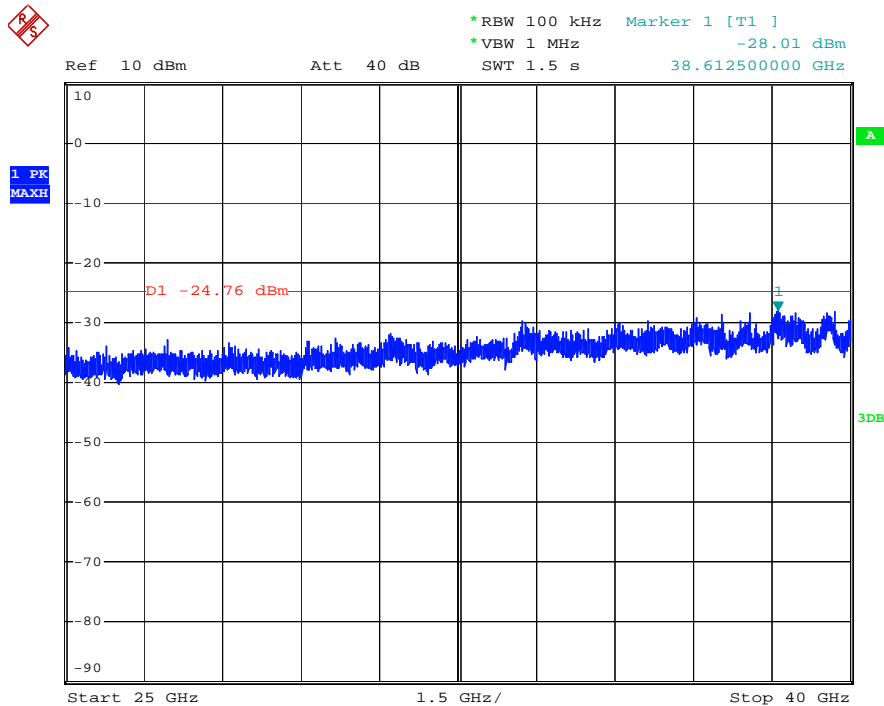
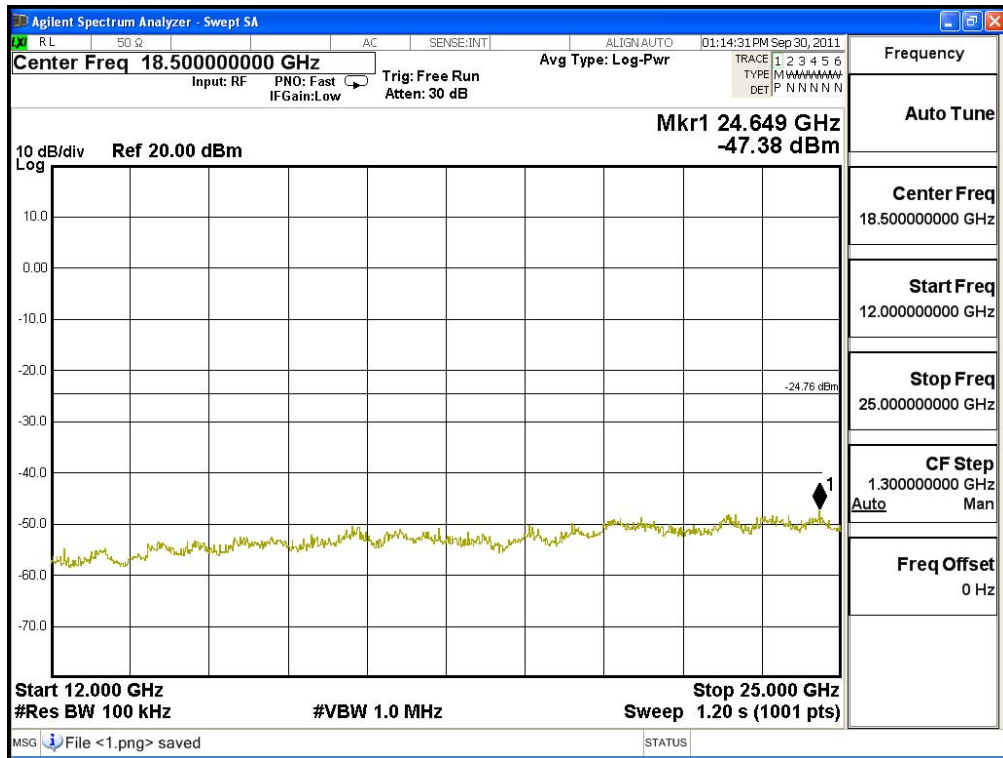

5190B-2

Date: 6.OCT.2011 03:30:08

**Channel 165 (5825MHz) 30MHz -20GHz-Chain B**

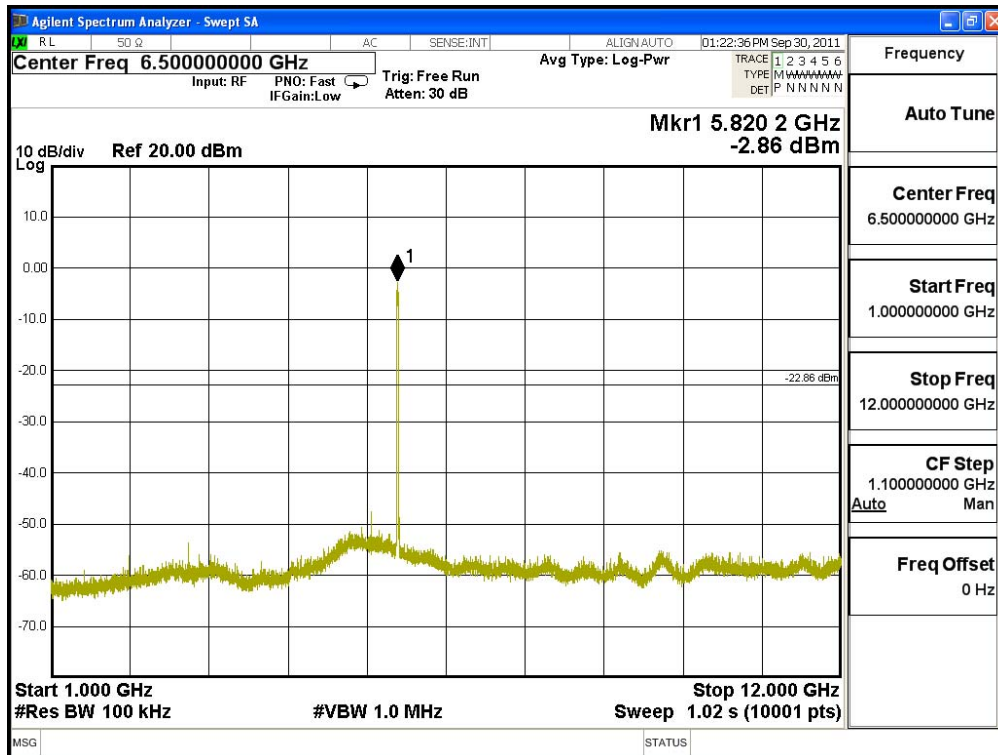
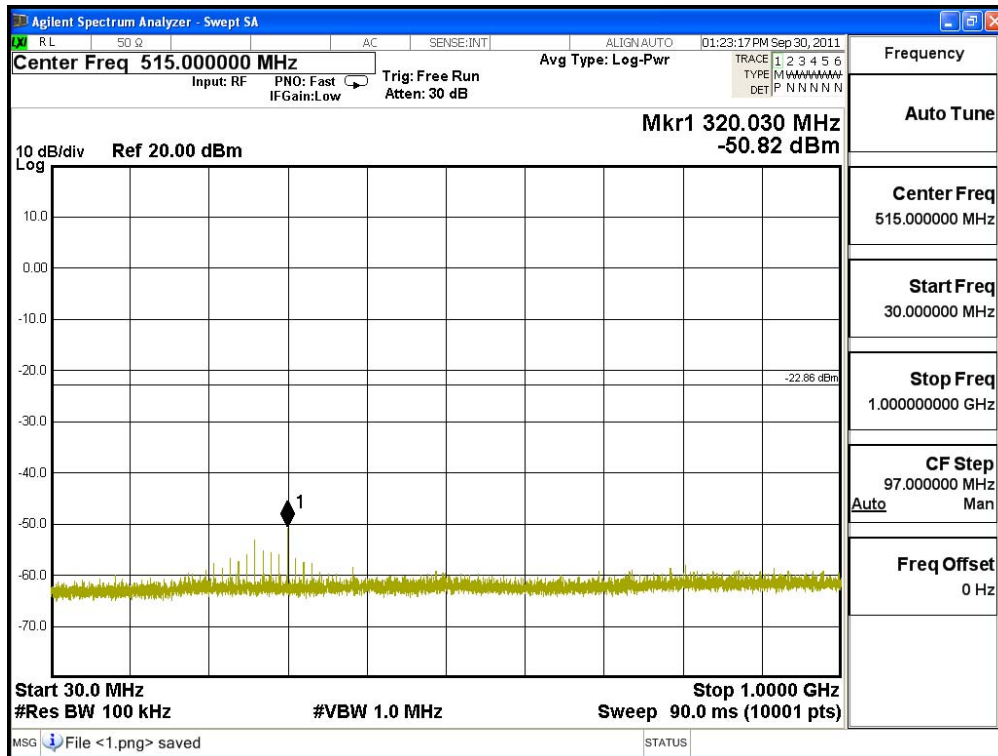

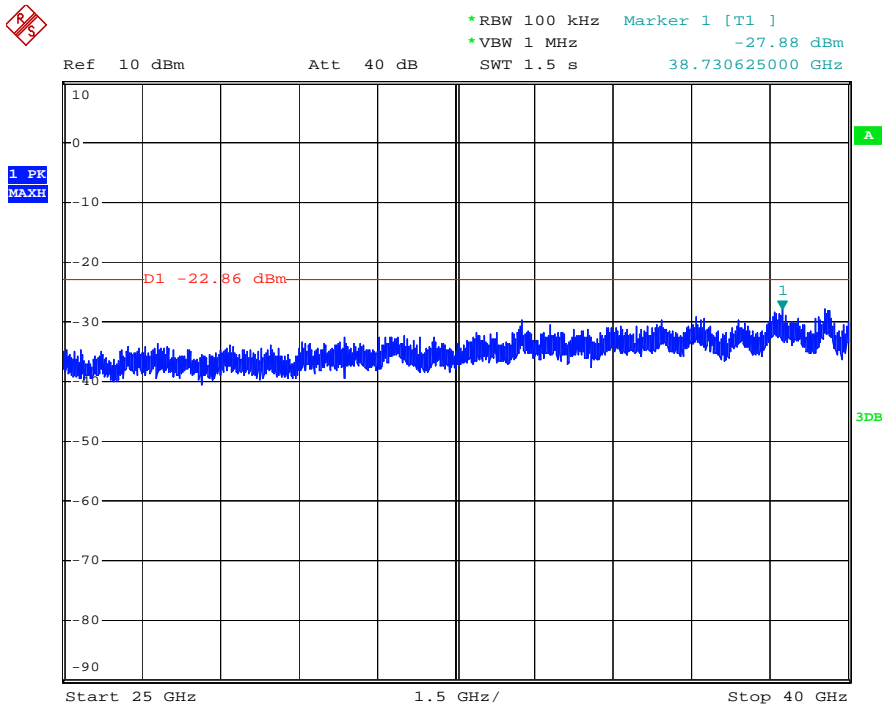
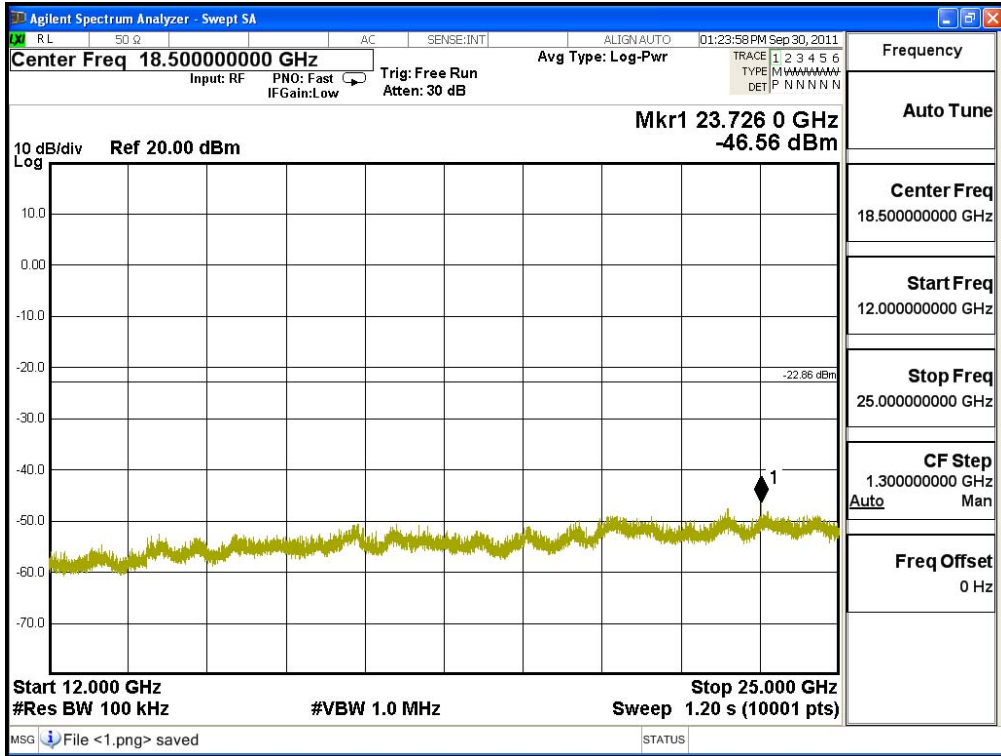

5190B-2

Date: 6.OCT.2011 03:34:40

**Channel 149 (5745MHz) 30MHz -40GHz-Chain C**

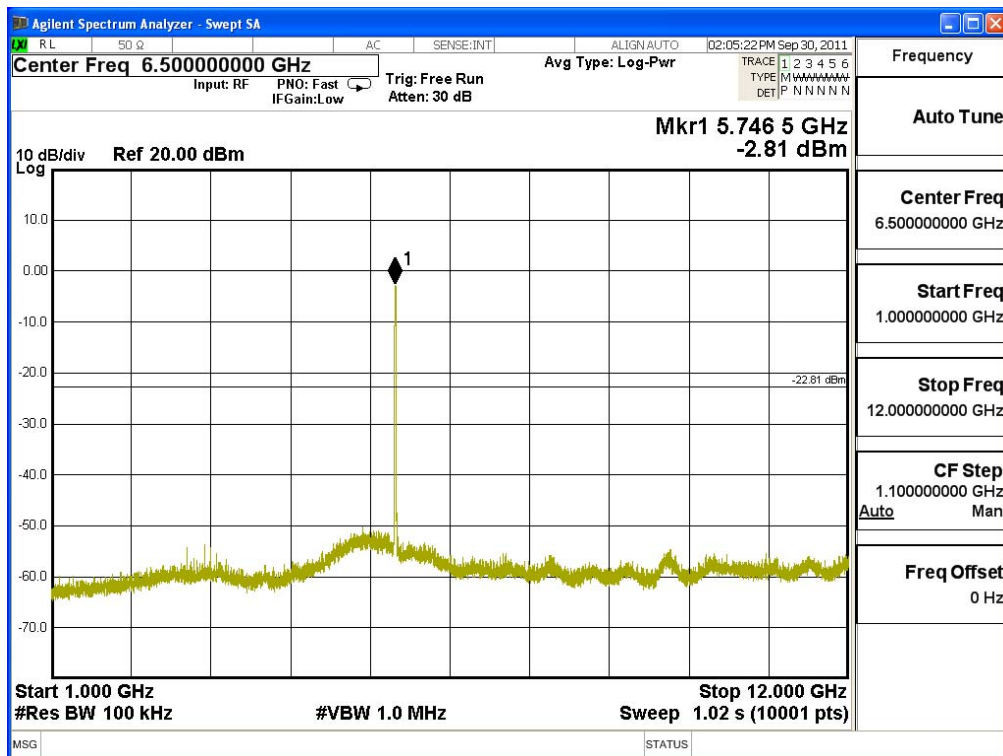
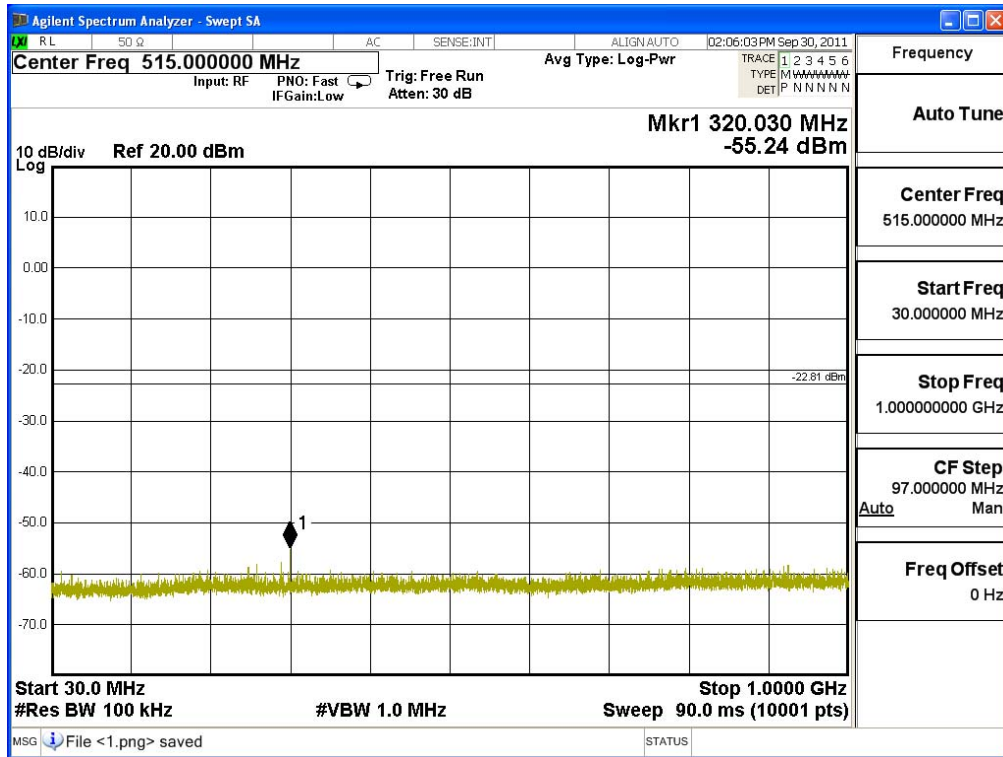

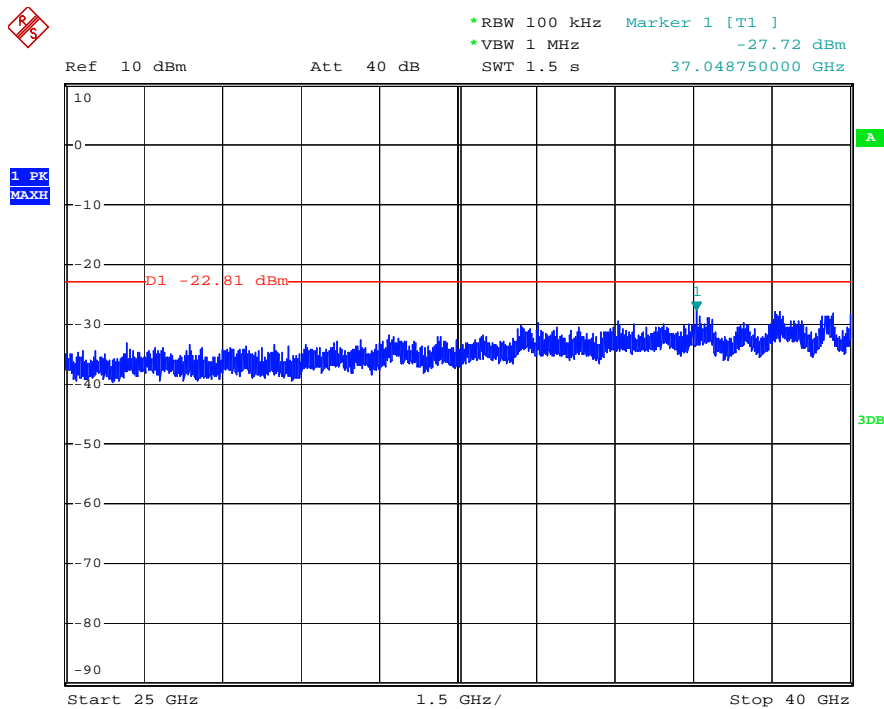
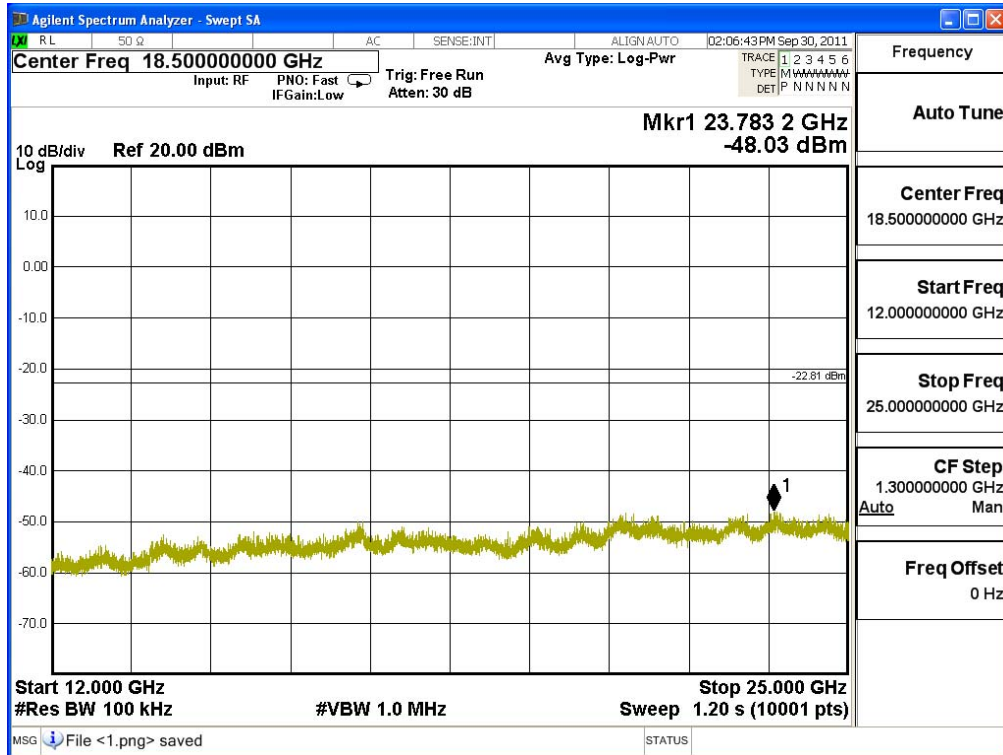

5190B-2

Date: 6.OCT.2011 03:27:11

**Channel 157 (5785MHz) 30MHz -40GHz-Chain C**

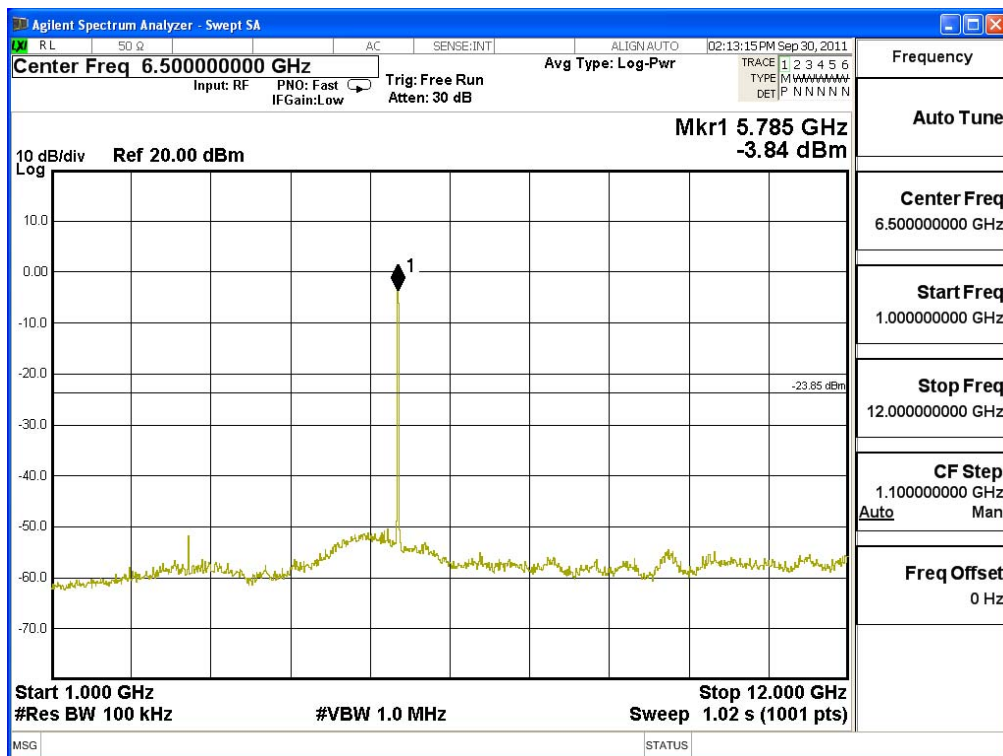
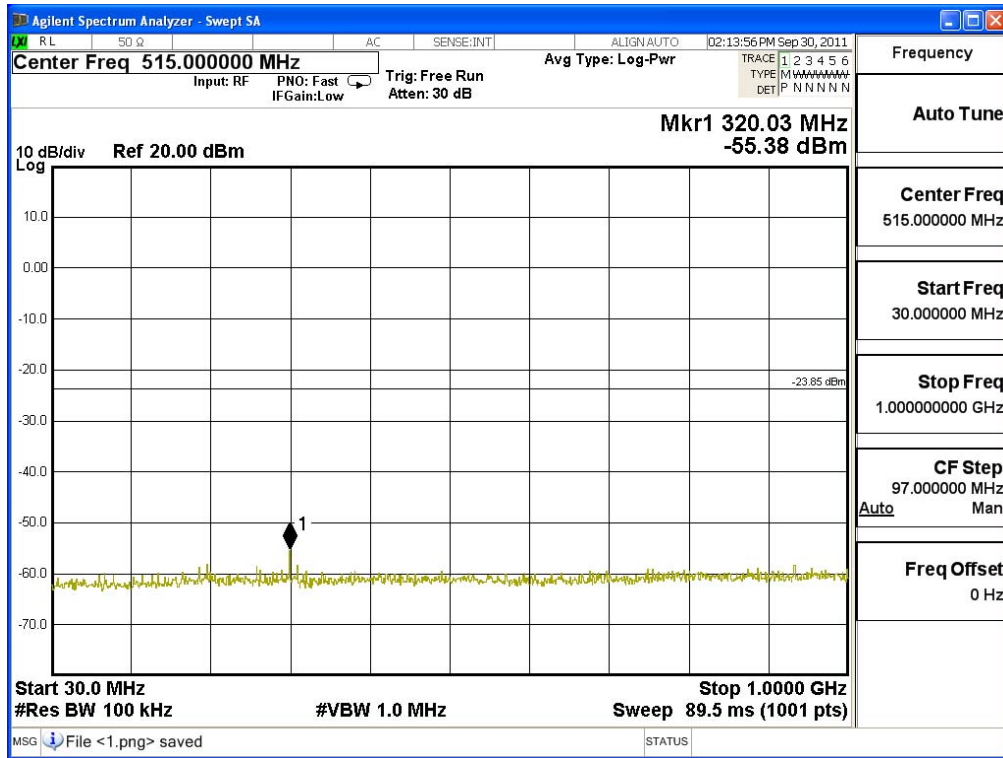

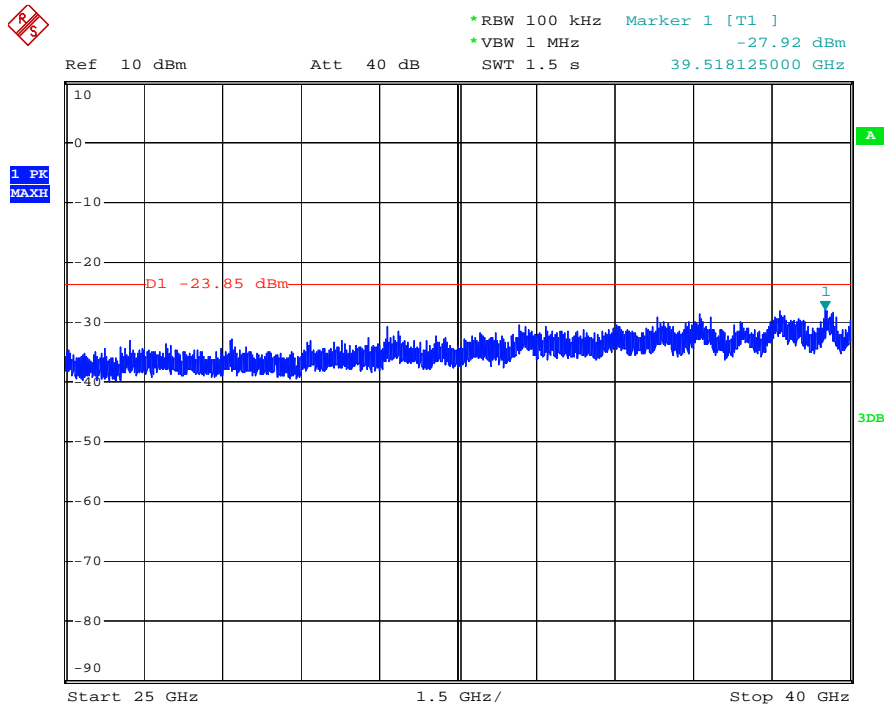
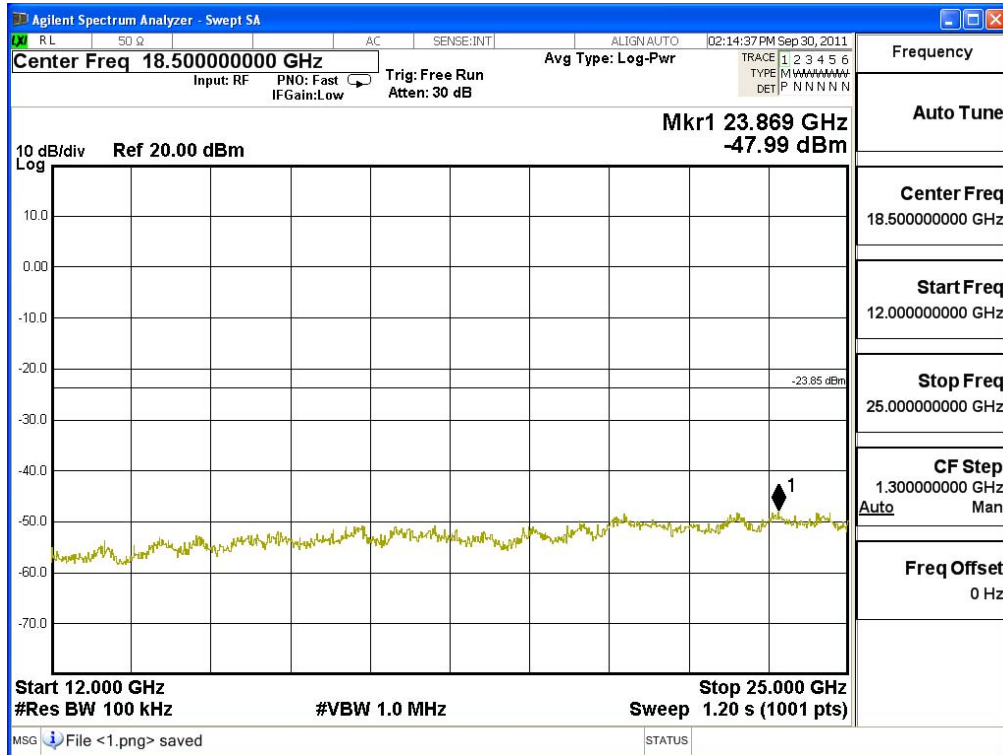

5190B-2

Date: 6.OCT.2011 03:31:03

**Channel 165 (5825MHz) 30MHz -40GHz-Chain C**

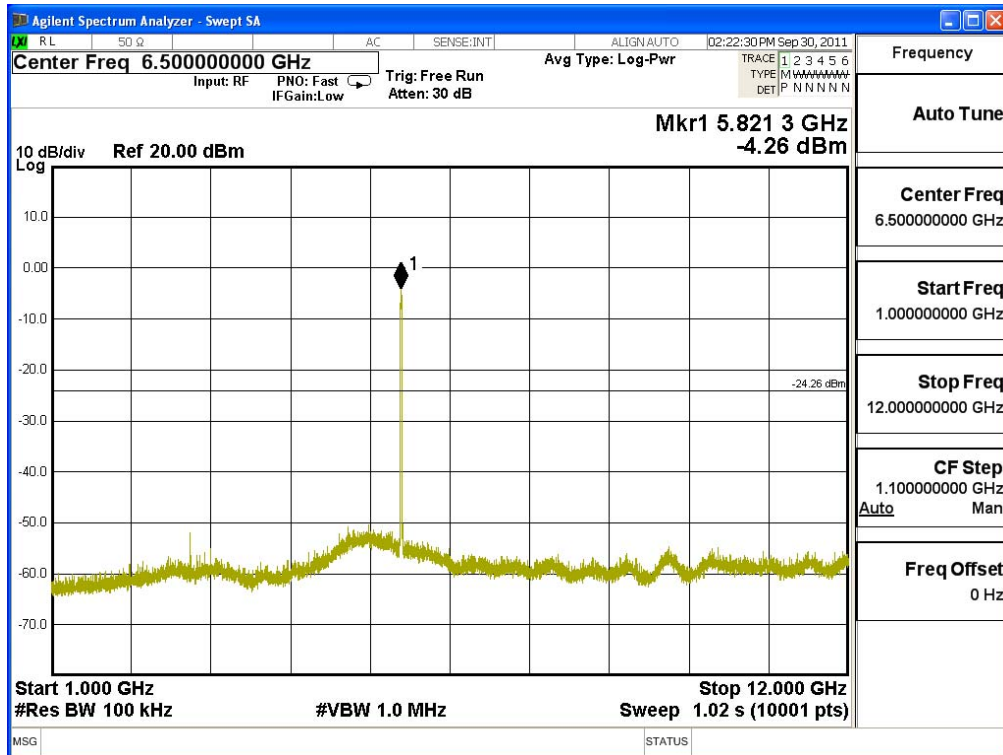
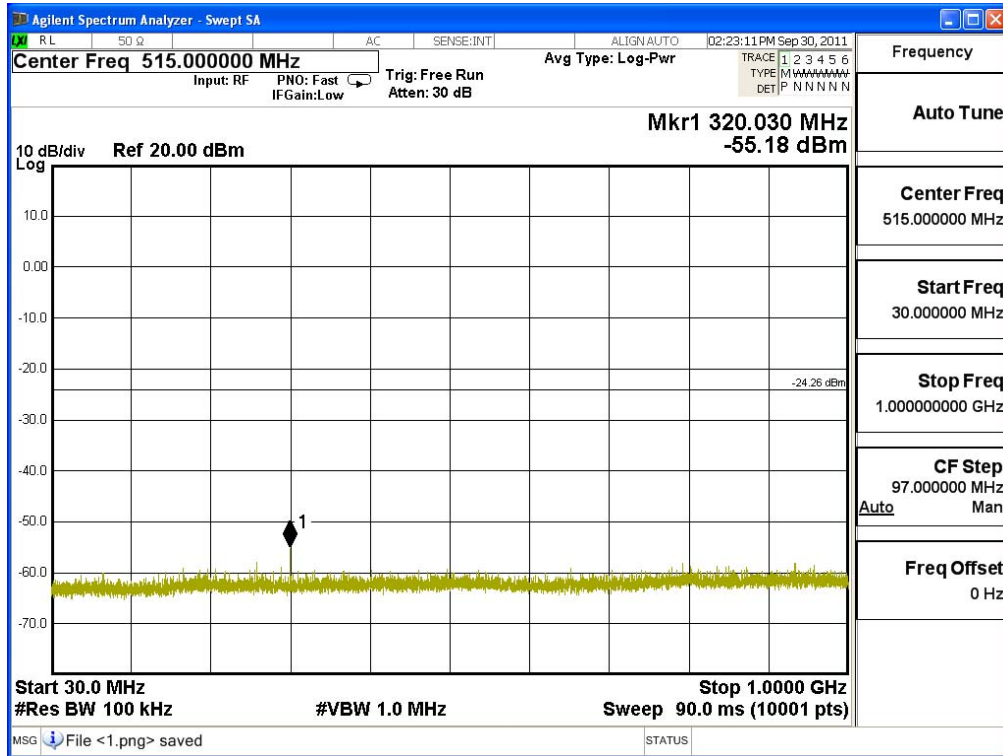



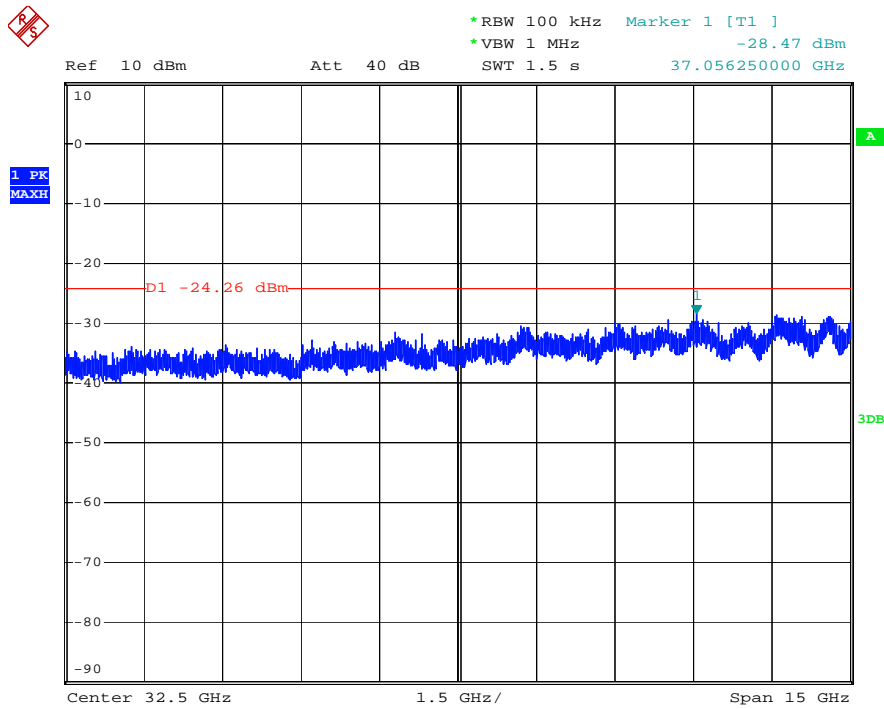
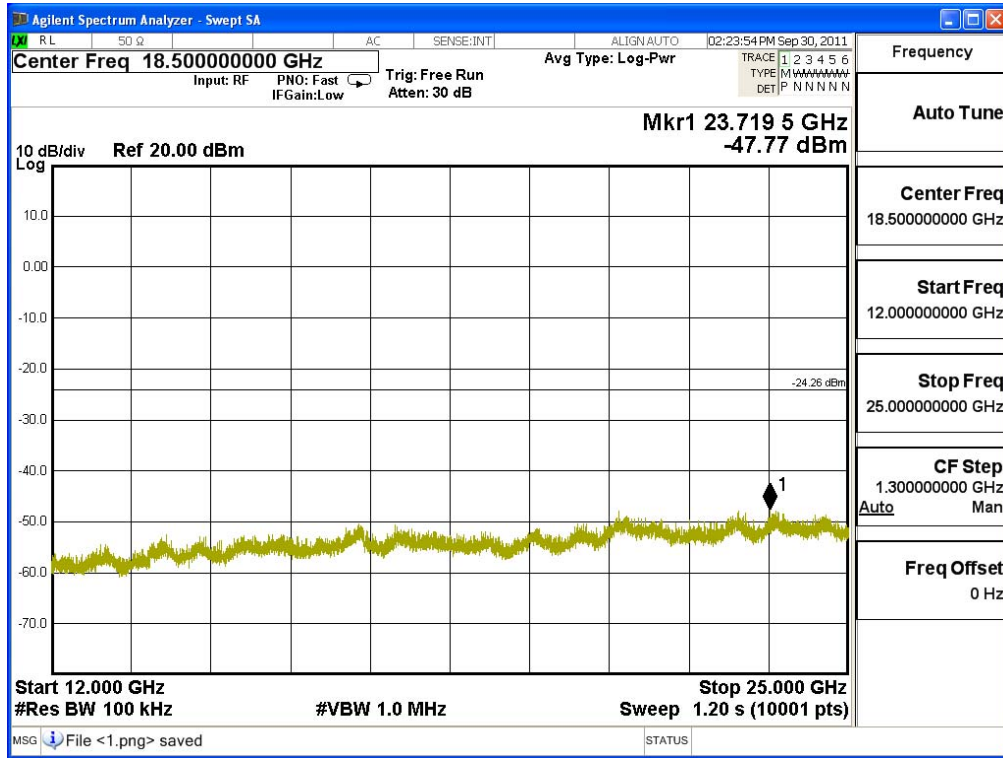

5190B-2

Date: 6.OCT.2011 03:35:14

**Channel 149 (5745MHz) 30MHz -40GHz-Chain D**

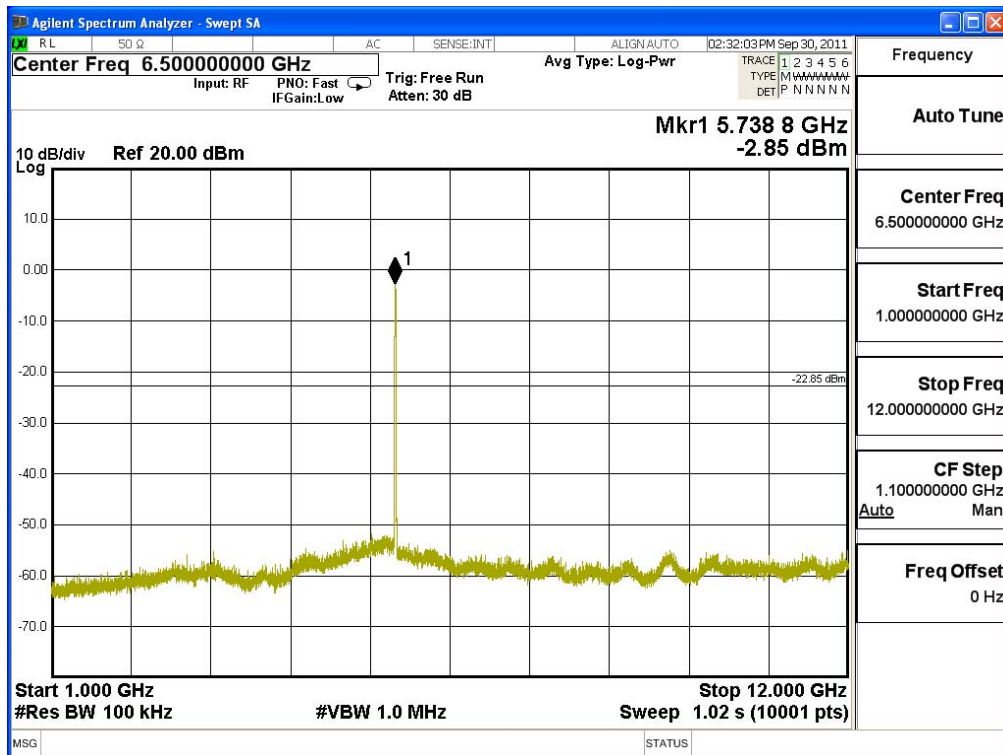
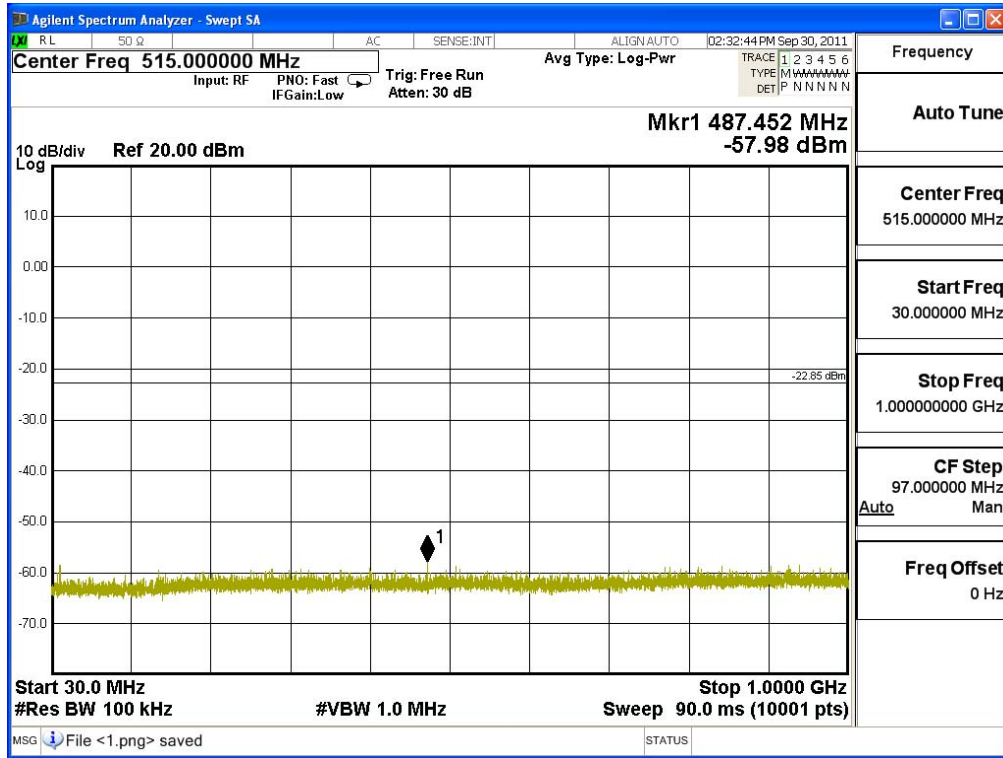

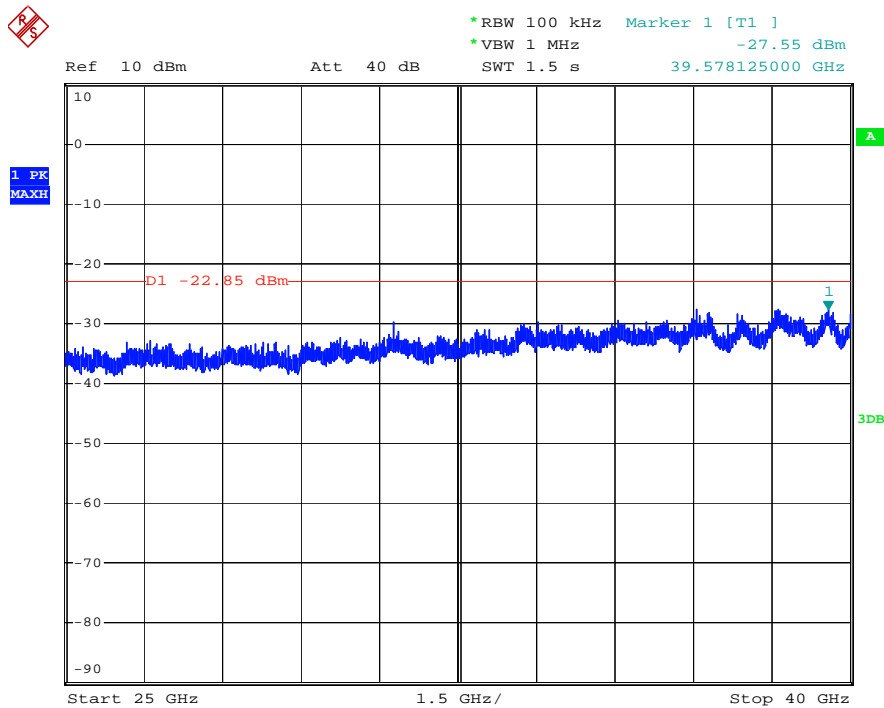
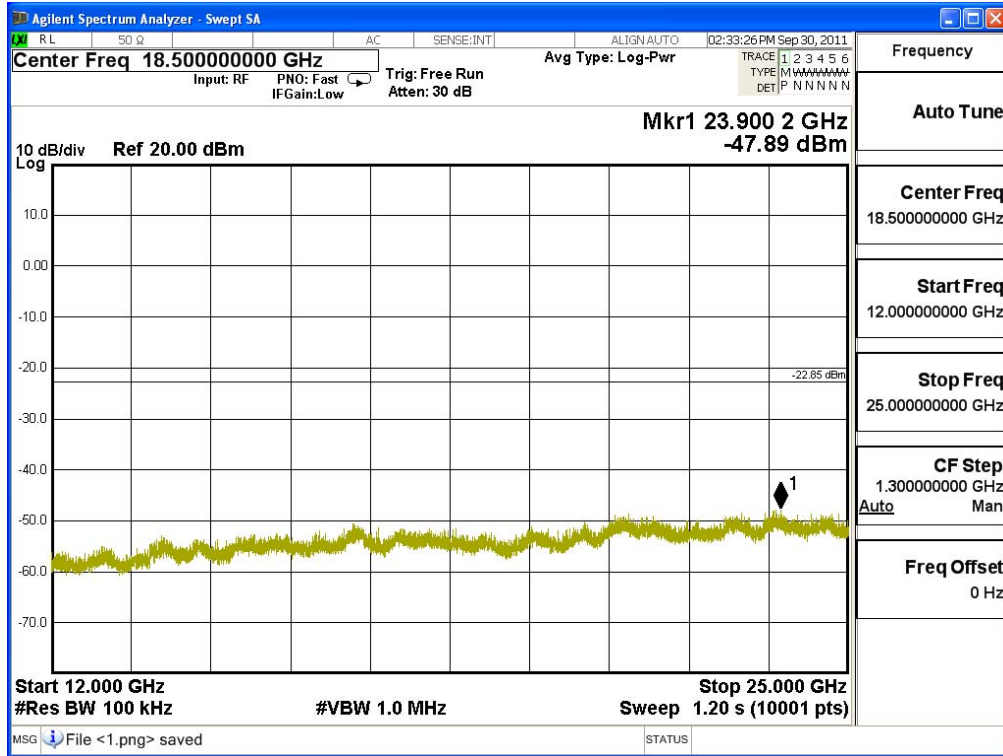

5190B-2

Date: 6.OCT.2011 03:27:47