



Non BeamForming U-NII-7

Modulation Type	Data Rate	Setting	Channel	Frequency (MHz)	Measured value of each antenna port (dBm)		Total conducted power (dBm)	Total conducted power (mW)	Antenna Gain (dBi)	Total E.I.R.P (dBm)	Total E.I.R.P (mW)	E.I.R.P Limit (dBm)
					ANT 3	ANT 4						
11ax HE20	NSS1-MCS0	7	117	6535	7.14	7.31	10.24	10.559	4.50	14.74	29.76	30.00
11ax HE20	NSS1-MCS0	7	153	6715	6.97	6.89	9.94	9.864	4.50	14.44	27.80	30.00
11ax HE20	NSS1-MCS0	7	181	6855	7.01	6.87	9.95	9.887	4.50	14.45	27.87	30.00
11ax HE40	NSS1-MCS0	10.5	123	6565	10.21	10.05	13.14	20.611	4.50	17.64	58.09	30.00
11ax HE40	NSS1-MCS0	10.5	155	6725	10.13	10.03	13.09	20.373	4.50	17.59	57.42	30.00
11ax HE40	NSS1-MCS0	10.5	179	6845	10.11	10.08	13.11	20.442	4.50	17.61	57.61	30.00
11ax HE80	NSS1-MCS0	13	135	6625	12.75	12.66	15.72	37.287	4.50	20.22	105.09	30.00
11ax HE80	NSS1-MCS0	13	151	6705	12.91	12.51	15.72	37.367	4.50	20.22	105.32	30.00
11ax HE80	NSS1-MCS0	13	167	6785	12.63	12.51	15.58	36.147	4.50	20.08	101.88	30.00
11ax HE160	NSS1-MCS0	15.5	143	6665	15.91	15.01	18.49	70.690	4.50	22.99	199.23	30.00

Non BeamForming U-NII-8

Modulation Type	Data Rate	Setting	Channel	Frequency (MHz)	Measured value of each antenna port (dBm)		Total conducted power (dBm)	Total conducted power (mW)	Antenna Gain (dBi)	Total E.I.R.P (dBm)	Total E.I.R.P (mW)	E.I.R.P Limit (dBm)
					ANT 3	ANT 4						
11ax HE20	NSS1-MCS0	7.5	189	6895	7.18	7.31	10.26	10.607	4.00	14.26	26.64	30.00
11ax HE20	NSS1-MCS0	7	213	7015	7.49	7.31	10.41	10.993	4.00	14.41	27.61	30.00
11ax HE20	NSS1-MCS0	7.5	229	7095	8.10	7.93	11.03	12.665	4.00	15.03	31.81	30.00
11ax HE20	NSS1-MCS0	7.5	233	7115	7.95	7.86	10.92	12.347	4.00	14.92	31.01	30.00
11ax HE40	NSS1-MCS0	11	195	6925	10.63	10.31	13.48	22.301	4.00	17.48	56.02	30.00
11ax HE40	NSS1-MCS0	10.5	211	7005	10.37	10.18	13.29	21.312	4.00	17.29	53.53	30.00
11ax HE40	NSS1-MCS0	11	227	7085	10.82	10.90	13.87	24.381	4.00	17.87	61.24	30.00
11ax HE80	NSS1-MCS0	13.5	199	6945	13.22	13.14	16.19	41.596	4.00	20.19	104.48	30.00
11ax HE80	NSS1-MCS0	13.5	215	7025	12.96	13.24	16.11	40.856	4.00	20.11	102.63	30.00
11ax HE160	NSS1-MCS0	15.5	207	6985	15.90	15.68	18.80	75.887	4.00	22.80	190.62	30.00



Non BeamForming

Maximum Conducted Output Power (Within 6425-6525MHz band)

RF Output Power(dBm)

Setting	Modulation Type	Data Rate	Frequency (MHz)	W/O Duty Factor Measured value of each antenna port (dBm)		W/O duty factor Total power (dBm)	Duty Factor (dB)	With duty factor Total power (dBm)	Antenna Gain (dBi)	With duty factor EIRP (dBm)	EIRP Limit (dBm)
				ANT 3	ANT 4						
10.5	11ax HE40	NSS1-MCS0	6525	6.92	6.67	9.81	0.40	10.21	4.50	14.71	30.00
13	11ax HE80	NSS1-MCS0	6545	9.40	9.33	12.38	0.40	12.78	4.50	17.28	30.00
15.5	11ax HE160	NSS1-MCS0	6505	12.43	12.52	15.49	0.44	15.93	4.50	20.43	30.00

Maximum Conducted Output Power (Extends across 6525MHz band)

RF Output Power(dBm)

Setting	Modulation Type	Data Rate	Frequency (MHz)	W/O Duty Factor Measured value of each antenna port (dBm)		W/O duty factor Total power (dBm)	Duty Factor (dB)	With duty factor Total power (dBm)	Antenna Gain (dBi)	With duty factor EIRP (dBm)	EIRP Limit (dBm)
				ANT 3	ANT 4						
10.5	11ax HE40	NSS1-MCS0	6525	6.88	6.82	9.86	0.40	10.26	4.50	14.76	30.00
13	11ax HE80	NSS1-MCS0	6545	9.11	9.18	12.16	0.40	12.56	4.50	17.06	30.00
15.5	11ax HE160	NSS1-MCS0	6505	12.37	12.74	15.57	0.44	16.01	4.50	20.51	30.00



Non BeamForming

Maximum Conducted Output Power (Within 6525-6875MHz band)											
RF Output Power(dBm)											
Setting	Modulation Type	Data Rate	Frequency (MHz)	W/O Duty Factor Measured value of each antenna port (dBm)		W/O duty factor Total power (dBm)	Duty Factor (dB)	With duty factor Total power (dBm)	Antenna Gain (dBi)	With duty factor EIRP (dBm)	EIRP Limit (dBm)
				ANT 3	ANT 4						
8	11ax HE20	NSS1-MCS0	6875	4.16	3.78	6.98	0.71	7.69	4.50	12.19	30.00
10.5	11ax HE40	NSS1-MCS0	6885	6.95	6.80	9.89	0.40	10.29	4.50	14.79	30.00
13	11ax HE80	NSS1-MCS0	6865	9.61	9.05	12.35	0.40	12.75	4.50	17.25	30.00
16	11ax HE160	NSS1-MCS0	6825	12.76	12.60	15.69	0.44	16.13	4.50	20.63	30.00

Maximum Conducted Output Power (Extends across 6875MHz band)											
RF Output Power(dBm)											
Setting	Modulation Type	Data Rate	Frequency (MHz)	W/O Duty Factor Measured value of each antenna port (dBm)		W/O duty factor Total power (dBm)	Duty Factor (dB)	With duty factor Total power (dBm)	Antenna Gain (dBi)	With duty factor EIRP (dBm)	EIRP Limit (dBm)
				ANT 3	ANT 4						
8	11ax HE20	NSS1-MCS0	6875	3.95	3.78	6.88	0.71	7.59	4.00	11.59	30.00
10.5	11ax HE40	NSS1-MCS0	6885	6.57	6.77	9.68	0.40	10.08	4.00	14.08	30.00
13	11ax HE80	NSS1-MCS0	6865	9.16	9.07	12.13	0.40	12.53	4.00	16.53	30.00
16	11ax HE160	NSS1-MCS0	6825	12.67	12.19	15.45	0.44	15.89	4.00	19.89	30.00



BeamForming U-NII-5

Modulation Type	Data Rate	Setting	Channel	Frequency (MHz)	Measured value of each antenna port (dBm)		Total conducted power (dBm)	Total conducted power (mW)	Antenna Gain (dBi)	Total E.I.R.P (dBm)	Total E.I.R.P (mW)	E.I.R.P Limit (dBm)
					ANT 3	ANT 4						
11ax HE20	NSS1-MCS0	8	33	6115	4.77	5.42	8.12	6.483	7.31	15.43	34.89	30.00
11ax HE20	NSS1-MCS0	8	61	6255	5.12	5.24	8.19	6.593	7.31	15.50	35.49	30.00
11ax HE20	NSS1-MCS0	7	93	6415	3.67	4.53	7.13	5.166	7.31	14.44	27.81	30.00
11ax HE40	NSS1-MCS0	12	35	6125	8.44	8.76	11.61	14.499	7.31	18.92	78.04	30.00
11ax HE40	NSS1-MCS0	11	59	6245	7.15	8.24	10.74	11.856	7.31	18.05	63.82	30.00
11ax HE40	NSS1-MCS0	10	91	6405	6.61	7.43	10.05	10.115	7.31	17.36	54.45	30.00
11ax HE80	NSS1-MCS0	14	39	6145	10.44	10.82	13.64	23.144	7.31	20.95	124.58	30.00
11ax HE80	NSS1-MCS0	14	55	6225	10.90	10.39	13.66	23.242	7.31	20.97	125.11	30.00
11ax HE80	NSS1-MCS0	14	87	6305	10.94	10.57	13.77	23.819	7.31	21.08	128.21	30.00
11ax HE160	NSS1-MCS0	16	47	6185	12.95	13.31	16.14	41.153	7.31	23.45	221.51	30.00
11ax HE160	NSS1-MCS0	16	79	6345	12.78	13.21	16.01	39.908	7.31	23.32	214.81	30.00

BeamForming U-NII-6

Modulation Type	Data Rate	Setting	Channel	Frequency (MHz)	Measured value of each antenna port (dBm)		Total conducted power (dBm)	Total conducted power (mW)	Antenna Gain (dBi)	Total E.I.R.P (dBm)	Total E.I.R.P (mW)	E.I.R.P Limit (dBm)
					ANT 3	ANT 4						
11ax HE20	NSS1-MCS0	7	97	6435	3.52	4.31	6.94	4.947	7.31	14.25	26.63	30.00
11ax HE20	NSS1-MCS0	8	105	6475	4.53	5.55	8.08	6.427	7.31	15.39	34.60	30.00
11ax HE20	NSS1-MCS0	7	113	6515	3.61	4.36	7.01	5.025	7.31	14.32	27.05	30.00
11ax HE40	NSS1-MCS0	10	99	6445	6.34	7.45	9.94	9.864	7.31	17.25	53.10	30.00
11ax HE40	NSS1-MCS0	11	107	6485	7.71	8.38	11.07	12.789	7.31	18.38	68.84	30.00
11ax HE80	NSS1-MCS0	13	103	6465	9.63	9.87	12.76	18.888	7.31	20.07	101.67	30.00



BeamForming U-NII-7

Modulation Type	Data Rate	Setting	Channel	Frequency (MHz)	Measured value of each antenna port (dBm)		Total conducted power (dBm)	Total conducted power (mW)	Antenna Gain (dBi)	Total E.I.R.P (dBm)	Total E.I.R.P (mW)	E.I.R.P Limit (dBm)
					ANT 3	ANT 4						
11ax HE20	NSS1-MCS0	7	117	6535	3.67	4.54	7.14	5.173	7.51	14.65	29.15	30.00
11ax HE20	NSS1-MCS0	8	153	6715	4.52	5.12	7.84	6.082	7.51	15.35	34.28	30.00
11ax HE20	NSS1-MCS0	8	181	6885	4.45	5.11	7.80	6.030	7.51	15.31	33.98	30.00
11ax HE40	NSS1-MCS0	11	123	6565	7.54	8.06	10.82	12.073	7.51	18.33	68.05	30.00
11ax HE40	NSS1-MCS0	11	155	6725	7.69	7.53	10.62	11.537	7.51	18.13	65.03	30.00
11ax HE40	NSS1-MCS0	11	179	6845	7.67	8.44	11.08	12.830	7.51	18.59	72.32	30.00
11ax HE80	NSS1-MCS0	13	135	6625	9.76	9.76	12.77	18.925	7.51	20.28	106.67	30.00
11ax HE80	NSS1-MCS0	14	151	6705	10.82	10.84	13.84	24.212	7.51	21.35	136.47	30.00
11ax HE80	NSS1-MCS0	14	167	6785	10.64	10.62	13.64	23.122	7.51	21.15	130.33	30.00
11ax HE160	NSS1-MCS0	16	143	6665	12.71	12.77	15.75	37.587	7.51	23.26	211.86	30.00

BeamForming U-NII-8

Modulation Type	Data Rate	Setting	Channel	Frequency (MHz)	Measured value of each antenna port (dBm)		Total conducted power (dBm)	Total conducted power (mW)	Antenna Gain (dBi)	Total E.I.R.P (dBm)	Total E.I.R.P (mW)	E.I.R.P Limit (dBm)
					ANT 3	ANT 4						
11ax HE20	NSS1-MCS0	9	189	6895	5.47	6.12	8.82	7.616	6.86	15.68	36.96	30.00
11ax HE20	NSS1-MCS0	8	213	7015	5.32	5.47	8.41	6.928	6.86	15.27	33.62	30.00
11ax HE20	NSS1-MCS0	8	229	7095	5.12	4.87	8.01	6.320	6.86	14.87	30.67	30.00
11ax HE20	NSS1-MCS0	8	233	7115	5.16	5.27	8.23	6.646	6.86	15.09	32.25	30.00
11ax HE40	NSS1-MCS0	12	195	6925	8.71	8.84	11.79	15.086	6.86	18.65	73.21	30.00
11ax HE40	NSS1-MCS0	11	211	7005	7.62	7.98	10.81	12.062	6.86	17.67	58.53	30.00
11ax HE40	NSS1-MCS0	11	227	7085	7.79	7.93	10.87	12.220	6.86	17.73	59.30	30.00
11ax HE80	NSS1-MCS0	14	199	6945	10.65	10.71	13.69	23.391	6.86	20.55	113.51	30.00
11ax HE80	NSS1-MCS0	14	215	7025	10.72	10.89	13.82	24.078	6.86	20.68	116.85	30.00
11ax HE160	NSS1-MCS0	16	207	6985	12.88	13.26	16.08	40.592	6.86	22.94	196.99	30.00



BeamForming

Maximum Conducted Output Power (Within 6425-6525MHz band)

RF Output Power(dBm)

Setting	Modulation Type	Data Rate	Frequency (MHz)	W/O Duty Factor Measured value of each antenna port (dBm)		W/O duty factor Total power (dBm)	Duty Factor (dB)	With duty factor Total power (dBm)	Antenna Gain (dBi)	With duty factor EIRP (dBm)	EIRP Limit (dBm)
				ANT 3	ANT 4						
10	11ax HE40	NSS1-MCS0	6525	3.32	3.86	6.61	0.42	7.03	7.31	14.34	30.00
13	11ax HE80	NSS1-MCS0	6545	5.39	6.02	8.73	0.48	9.21	7.31	16.52	30.00
16	11ax HE160	NSS1-MCS0	6505	9.18	9.54	12.37	0.45	12.82	7.31	20.13	30.00

Maximum Conducted Output Power (Extends across 6525MHz band)

RF Output Power(dBm)

Setting	Modulation Type	Data Rate	Frequency (MHz)	W/O Duty Factor Measured value of each antenna port (dBm)		W/O duty factor Total power (dBm)	Duty Factor (dB)	With duty factor Total power (dBm)	Antenna Gain (dBi)	With duty factor EIRP (dBm)	EIRP Limit (dBm)
				ANT 3	ANT 4						
10	11ax HE40	NSS1-MCS0	6525	3.33	3.93	6.65	0.42	7.07	7.51	14.58	30.00
13	11ax HE80	NSS1-MCS0	6545	5.14	5.83	8.51	0.48	8.99	7.51	16.50	30.00
16	11ax HE160	NSS1-MCS0	6505	9.02	9.68	12.37	0.45	12.82	7.51	20.33	30.00



BeamForming

Maximum Conducted Output Power (Within 6525-6875MHz band)												
RF Output Power(dBm)												
Setting	Modulation Type	Data Rate	Frequency (MHz)	W/O Duty Factor Measured value of each antenna port (dBm)		W/O duty factor Total power (dBm)	Duty Factor (dB)	With duty factor Total power (dBm)	Antenna Gain (dBi)	With duty factor EIRP (dBm)	EIRP Limit (dBm)	
				ANT 3	ANT 4							
8	11ax HE20	NSS1-MCS0	6875	1.39	1.24	4.33	0.41	4.74	7.51	12.25	30.00	
11	11ax HE40	NSS1-MCS0	6885	3.68	3.80	6.75	0.42	7.17	7.51	14.68	30.00	
14	11ax HE80	NSS1-MCS0	6865	6.40	6.96	9.70	0.48	10.18	7.51	17.69	30.00	
16	11ax HE160	NSS1-MCS0	6825	9.11	9.41	12.27	0.45	12.72	7.51	20.23	30.00	

Maximum Conducted Output Power (Extends across 6875MHz band)												
RF Output Power(dBm)												
Setting	Modulation Type	Data Rate	Frequency (MHz)	W/O Duty Factor Measured value of each antenna port (dBm)		W/O duty factor Total power (dBm)	Duty Factor (dB)	With duty factor Total power (dBm)	Antenna Gain (dBi)	With duty factor EIRP (dBm)	EIRP Limit (dBm)	
				ANT 3	ANT 4							
8	11ax HE20	NSS1-MCS0	6875	1.31	1.12	4.23	0.41	4.64	6.86	11.50	30.00	
11	11ax HE40	NSS1-MCS0	6885	3.64	3.65	6.66	0.42	7.08	6.86	13.94	30.00	
14	11ax HE80	NSS1-MCS0	6865	6.29	6.53	9.42	0.48	9.90	6.86	16.76	30.00	
16	11ax HE160	NSS1-MCS0	6825	8.58	8.80	11.70	0.45	12.15	6.86	19.01	30.00	



Within 6425-6525MHz band Straddle Channel
Non BeamForming
ANT 3
Modulation Type: 802.11ax HE40 (14.6Mbps)
CH115



Modulation Type: 802.11ax HE80 (30.6Mbps)
CH119



Modulation Type: 802.11ax HE160 (61.3Mbps)
CH111





Within 6425-6525MHz band Straddle Channel
Non BeamForming
ANT 4
Modulation Type: 802.11ax HE40 (14.6Mbps)
CH115



Modulation Type: 802.11ax HE80 (30.6Mbps)
CH119



Modulation Type: 802.11ax HE160 (61.3Mbps)
CH111





Extends across 6525MHz band Straddle Channel
Non BeamForming
ANT 3
Modulation Type: 802.11ax HE40 (14.6Mbps)
CH115

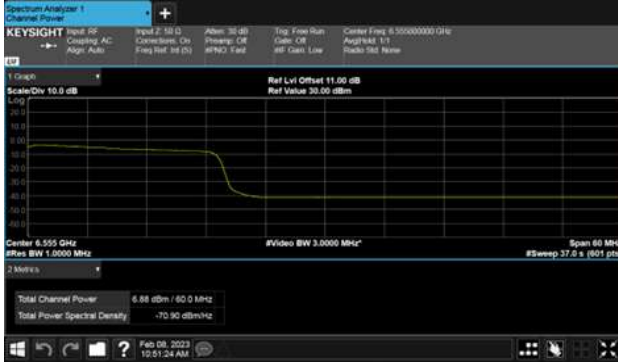

Modulation Type: 802.11ax HE80 (30.6Mbps)
CH119



Modulation Type: 802.11ax HE160 (61.3Mbps)
CH111

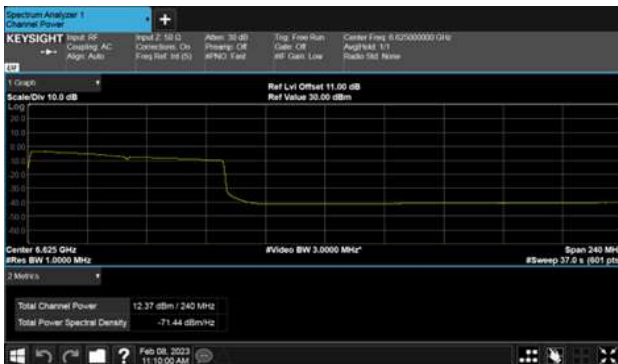



Extends across 6525MHz band Straddle Channel
Non BeamForming
ANT 4
Modulation Type: 802.11ax HE40 (14.6Mbps)
CH115

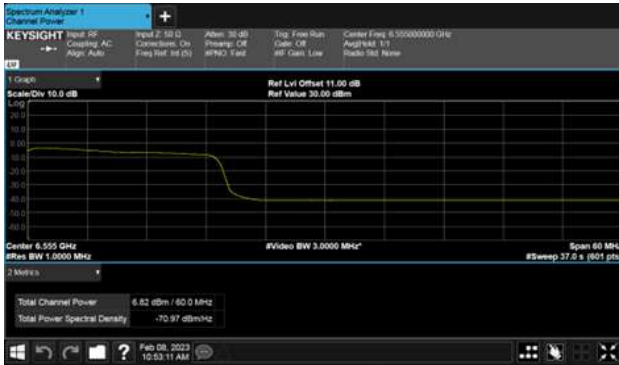

Modulation Type: 802.11ax HE80 (30.6Mbps)
CH119



Modulation Type: 802.11ax HE160 (61.3Mbps)
CH111





Within 6525-6875MHz band Straddle Channel
Non BeamForming
ANT 3
Modulation Type: 802.11ax HE20 (7.3Mbps)
CH185

Modulation Type: 802.11ax HE160 (61.3Mbps)
CH175



Modulation Type: 802.11ax HE40 (14.6Mbps)
CH187



Modulation Type: 802.11ax HE80 (30.6Mbps)
CH183





Within 6525-6875MHz band Straddle Channel
Non BeamForming
ANT 4
Modulation Type: 802.11ax HE20 (7.3Mbps)
CH185

Modulation Type: 802.11ax HE160 (61.3Mbps)
CH175

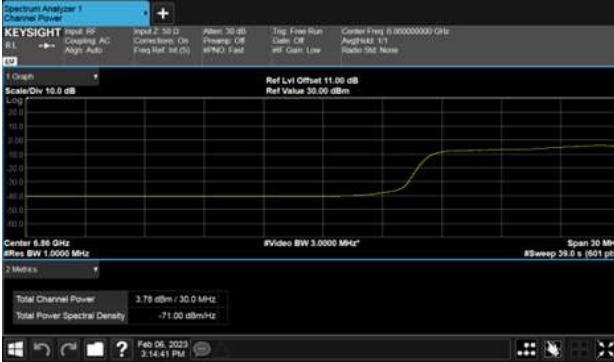

Modulation Type: 802.11ax HE40 (14.6Mbps)
CH187



Modulation Type: 802.11ax HE80 (30.6Mbps)
CH183





Extends across 6875MHz band

Non BeamForming

ANT 3

Modulation Type: 802.11ax HE20 (7.3Mbps)
CH185

Modulation Type: 802.11ax HE160 (61.3Mbps)
CH175



Modulation Type: 802.11ax HE40 (14.6Mbps)
CH187



Modulation Type: 802.11ax HE80 (30.6Mbps)
CH183





Extends across 6875MHz band

Non BeamForming

ANT 4

Modulation Type: 802.11ax HE20 (7.3Mbps)
CH185

Modulation Type: 802.11ax HE160 (61.3Mbps)
CH175

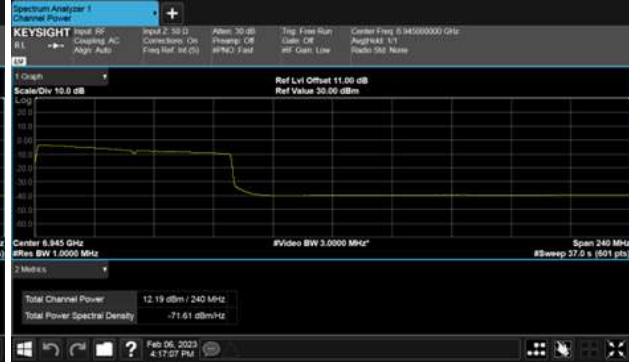
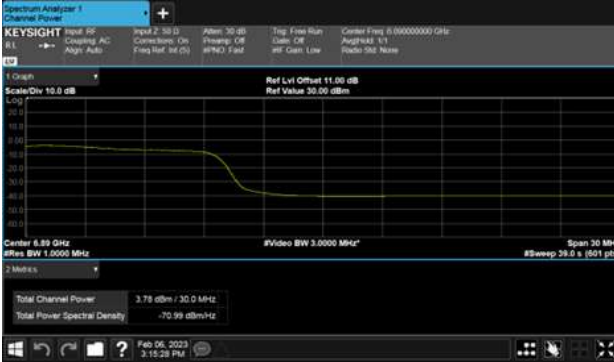

Modulation Type: 802.11ax HE40 (14.6Mbps)
CH187

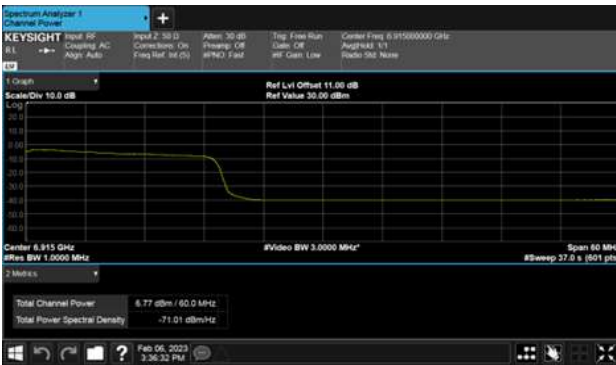

Modulation Type: 802.11ax HE80 (30.6Mbps)
CH183





Within 6425-6525MHz band Straddle Channel
BeamForming
ANT 3
Modulation Type: 802.11ax HE40 (14.6Mbps)
CH115



Modulation Type: 802.11ax HE80 (30.6Mbps)
CH119



Modulation Type: 802.11ax HE160 (61.3Mbps)
CH111





Within 6425-6525MHz band Straddle Channel
BeamForming
ANT 4
Modulation Type: 802.11ax HE40 (14.6Mbps)
CH115



Modulation Type: 802.11ax HE80 (30.6Mbps)
CH119



Modulation Type: 802.11ax HE160 (61.3Mbps)
CH111





Extends across 6525MHz band Straddle Channel

BeamForming

ANT 3

Modulation Type: 802.11ax HE40 (14.6Mbps)

CH115

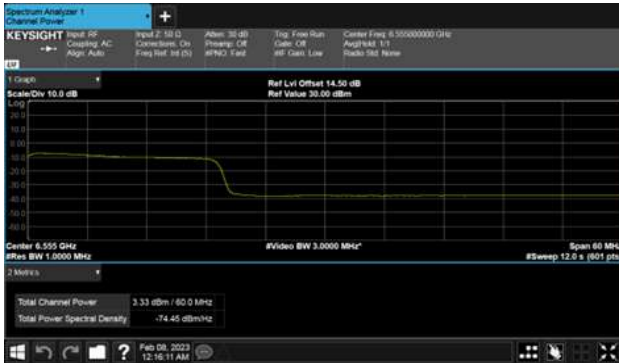

Modulation Type: 802.11ax HE80 (30.6Mbps)

CH119



Modulation Type: 802.11ax HE160 (61.3Mbps)

CH111





Extends across 6525MHz band Straddle Channel
BeamForming
ANT 4
Modulation Type: 802.11ax HE40 (14.6Mbps)
CH115



Modulation Type: 802.11ax HE80 (30.6Mbps)
CH119



Modulation Type: 802.11ax HE160 (61.3Mbps)
CH111





Within 6525-6875MHz band Straddle Channel
BeamForming
ANT 4
Modulation Type: 802.11ax HE20 (7.3Mbps)
CH185

Modulation Type: 802.11ax HE160 (61.3Mbps)
CH175

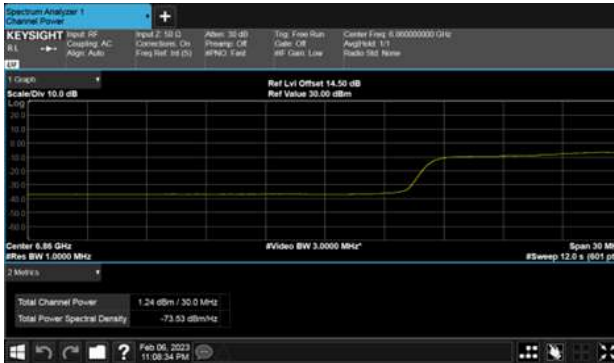

Modulation Type: 802.11ax HE40 (14.6Mbps)
CH187



Modulation Type: 802.11ax HE80 (30.6Mbps)
CH183





Extends across 6875MHz band

BeamForming

ANT 3

Modulation Type: 802.11ax HE20 (7.3Mbps)
CH185

Modulation Type: 802.11ax HE160 (61.3Mbps)
CH175

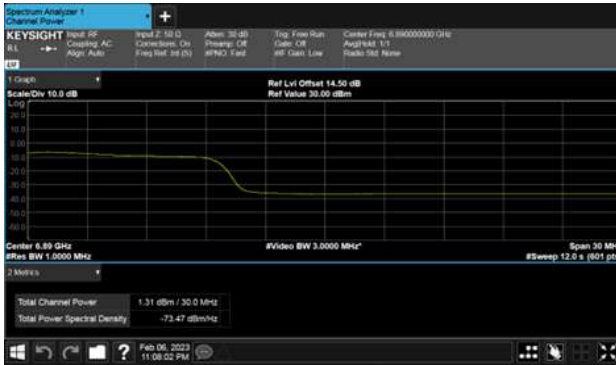

Modulation Type: 802.11ax HE40 (14.6Mbps)
CH187

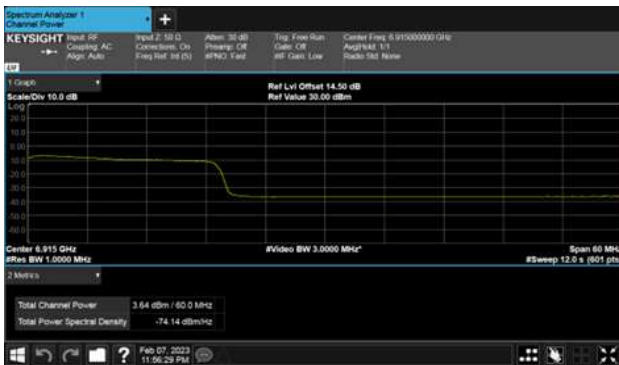

Modulation Type: 802.11ax HE80 (30.6Mbps)
CH183





Extends across 6875MHz band

BeamForming

ANT 4

Modulation Type: 802.11ax HE20 (7.3Mbps)
CH185

Modulation Type: 802.11ax HE160 (61.3Mbps)
CH175

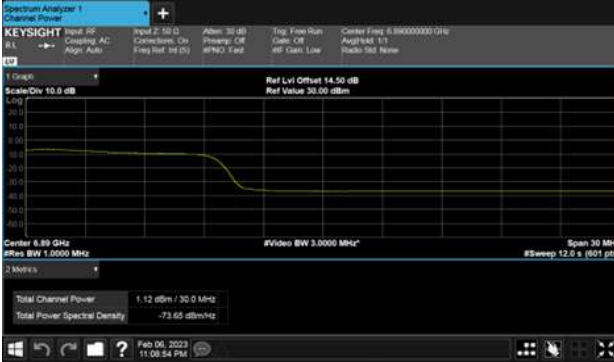

Modulation Type: 802.11ax HE40 (14.6Mbps)
CH187



Modulation Type: 802.11ax HE80 (30.6Mbps)
CH183





10. Peak Power Spectral Density (E.I.R.P.)

10.1. Test Limit

Frequency Band		Limit
<input checked="" type="checkbox"/>	5.925~6.425GHz	
Operating Mode		
<input type="checkbox"/>	For standard power access point and fixed client device :	e.i.r.p PSD < 23 dBm/MHz.
<input checked="" type="checkbox"/>	For indoor access point :	e.i.r.p PSD < 5 dBm/MHz.
<input type="checkbox"/>	For subordinate device control of an indoor access point :	e.i.r.p PSD < 5 dBm/MHz.
<input type="checkbox"/>	For client device control of a standard power access point:	e.i.r.p PSD < 17 dBm/MHz.
<input type="checkbox"/>	For client device control of an indoor access point:	e.i.r.p PSD < -1 dBm/MHz.
<input checked="" type="checkbox"/>	6.425-6.525 GHz	
Operating Mode		
<input checked="" type="checkbox"/>	For indoor access point	e.i.r.p PSD < 5 dBm/MHz.
<input type="checkbox"/>	For client device control of an indoor access point ::	e.i.r.p PSD < -1 dBm/MHz.
<input checked="" type="checkbox"/>	6.525~6.875 GHz	
Operating Mode		
<input type="checkbox"/>	For standard power access point and fixed client device :	e.i.r.p PSD < 23 dBm/MHz.
<input checked="" type="checkbox"/>	For indoor access point :	e.i.r.p PSD < 5 dBm/MHz.
<input type="checkbox"/>	For subordinate device control of an indoor access point :	e.i.r.p PSD < 5 dBm/MHz.
<input type="checkbox"/>	For client device control of a standard power access point:	e.i.r.p PSD < 17 dBm/MHz.
<input type="checkbox"/>	For client device control of an indoor access point:	e.i.r.p PSD < -1 dBm/MHz.
<input checked="" type="checkbox"/>	6.875-7.125 GHz	
Operating Mode		
<input checked="" type="checkbox"/>	For indoor access point	e.i.r.p PSD < 5 dBm/MHz.
<input type="checkbox"/>	For client device control of an indoor access point ::	e.i.r.p PSD < -1 dBm/MHz.



10.2. Test Procedure

Reference to KDB789033 D02 General UNII Test Procedures New Rules v02r01

10.3. Test Setup Layout

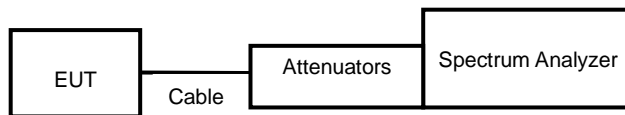



10.4. Test Result and Data

Non BeamForming U-NII-5

Modulation Type	Data Rate	Channel	Frequency (MHz)	Measured value of each antenna port (dBm/MHz)		W/O duty factor Total PSD (dBm/MHz)	Duty Cycle CF(dB)	Antenna Gain (dBi)	Total Corr'd EIRP PSD (dBm/MHz)	E.I.R.P PSD Limit (dBm/MHz)
				ANT 3	ANT 4					
11ax HE20	NSS1-MCS0	33	6115	-3.41	-3.56	-0.47	0.71	4.50	4.74	5.00
11ax HE20	NSS1-MCS0	61	6255	-3.74	-3.58	-0.65	0.71	4.50	4.56	5.00
11ax HE20	NSS1-MCS0	93	6415	-3.65	-3.37	-0.50	0.71	4.50	4.71	5.00
11ax HE40	NSS1-MCS0	35	6125	-2.96	-3.38	-0.15	0.40	4.50	4.75	5.00
11ax HE40	NSS1-MCS0	59	6245	-3.17	-3.28	-0.21	0.40	4.50	4.69	5.00
11ax HE40	NSS1-MCS0	91	6405	-3.03	-3.55	-0.27	0.40	4.50	4.63	5.00
11ax HE80	NSS1-MCS0	39	6145	-2.88	-3.17	-0.01	0.40	4.50	4.89	5.00
11ax HE80	NSS1-MCS0	55	6225	-3.15	-3.34	-0.23	0.40	4.50	4.67	5.00
11ax HE80	NSS1-MCS0	87	6385	-2.60	-3.42	0.02	0.40	4.50	4.92	5.00
11ax HE160	NSS1-MCS0	47	6185	-3.41	-3.26	-0.32	0.44	4.50	4.62	5.00
11ax HE160	NSS1-MCS0	79	6345	-3.03	-2.97	0.01	0.44	4.50	4.95	5.00

Non BeamForming U-NII-6

Modulation Type	Data Rate	Channel	Frequency (MHz)	Measured value of each antenna port (dBm/MHz)		W/O duty factor Total PSD (dBm/MHz)	Duty Cycle CF(dB)	Antenna Gain (dBi)	Total Corr'd EIRP PSD (dBm/MHz)	E.I.R.P PSD Limit (dBm/MHz)
				ANT 3	ANT 4					
11ax HE20	NSS1-MCS0	97	6435	-3.69	-3.56	-0.61	0.71	4.50	4.60	5.00
11ax HE20	NSS1-MCS0	105	6475	-3.40	-3.14	-0.26	0.71	4.50	4.95	5.00
11ax HE20	NSS1-MCS0	113	6515	-3.40	-3.33	-0.35	0.71	4.50	4.86	5.00
11ax HE40	NSS1-MCS0	99	6445	-3.08	-3.17	-0.12	0.40	4.50	4.78	5.00
11ax HE40	NSS1-MCS0	107	6485	-3.19	-3.41	-0.29	0.40	4.50	4.61	5.00
11ax HE80	NSS1-MCS0	103	6465	-3.10	-3.12	-0.10	0.40	4.50	4.80	5.00



Non BeamForming U-NII-7

Modulation Type	Data Rate	Channel	Frequency (MHz)	Measured value of each antenna port (dBm/MHz)		W/O duty factor Total PSD (dBm/MHz)	Duty Cycle CF(dB)	Antenna Gain (dBi)	Total Corr'd EIRP PSD (dBm/MHz)	E.I.R.P PSD Limit (dBm/MHz)
				ANT 3	ANT 4					
11ax HE20	NSS1-MCS0	117	6535	-3.33	-3.29	-0.30	0.71	4.50	4.91	5.00
11ax HE20	NSS1-MCS0	153	6715	-3.42	-3.90	-0.64	0.71	4.50	4.57	5.00
11ax HE20	NSS1-MCS0	181	6855	-2.94	-3.65	-0.27	0.71	4.50	4.94	5.00
11ax HE40	NSS1-MCS0	123	6565	-3.06	-3.10	-0.07	0.40	4.50	4.83	5.00
11ax HE40	NSS1-MCS0	155	6725	-2.93	-3.67	-0.27	0.40	4.50	4.63	5.00
11ax HE40	NSS1-MCS0	179	6845	-2.55	-3.70	-0.08	0.40	4.50	4.82	5.00
11ax HE80	NSS1-MCS0	135	6625	-3.28	-3.08	-0.17	0.40	4.50	4.73	5.00
11ax HE80	NSS1-MCS0	151	6705	-2.90	-3.59	-0.22	0.40	4.50	4.68	5.00
11ax HE80	NSS1-MCS0	167	6785	-3.15	-3.43	-0.28	0.40	4.50	4.62	5.00
11ax HE160	NSS1-MCS0	143	6665	-2.55	-3.42	0.05	0.40	4.50	4.95	5.00

Non BeamForming U-NII-8

Modulation Type	Data Rate	Channel	Frequency (MHz)	Measured value of each antenna port (dBm/MHz)		W/O duty factor Total PSD (dBm/MHz)	Duty Cycle CF(dB)	Antenna Gain (dBi)	Total Corr'd EIRP PSD (dBm/MHz)	E.I.R.P PSD Limit (dBm/MHz)
				ANT 3	ANT 4					
11ax HE20	NSS1-MCS0	189	6895	-3.23	-3.15	-0.18	0.71	4.00	4.53	5.00
11ax HE20	NSS1-MCS0	213	7015	-3.12	-3.02	-0.06	0.71	4.00	4.65	5.00
11ax HE20	NSS1-MCS0	229	7095	-2.91	-2.96	0.08	0.71	4.00	4.79	5.00
11ax HE20	NSS1-MCS0	233	7115	-2.63	-3.14	0.14	0.71	4.00	4.85	5.00
11ax HE40	NSS1-MCS0	195	6925	-2.49	-2.61	0.46	0.40	4.00	4.86	5.00
11ax HE40	NSS1-MCS0	211	7005	-2.74	-2.88	0.20	0.40	4.00	4.60	5.00
11ax HE40	NSS1-MCS0	227	7085	-2.68	-2.54	0.40	0.40	4.00	4.80	5.00
11ax HE80	NSS1-MCS0	199	6945	-2.52	-2.50	0.50	0.40	4.00	4.90	5.00
11ax HE80	NSS1-MCS0	215	7025	-2.58	-2.45	0.49	0.40	4.00	4.89	5.00
11ax HE160	NSS1-MCS0	207	6985	-2.41	-2.51	0.55	0.44	4.00	4.99	5.00



Non BeamForming

Maximum Conducted PSD (Within 6425-6525MHz band)

Modulation Type	Data Rate	Frequency (MHz)	W/O Duty Factor Measured value of each antenna port (dBm/MHz)		W/O duty factor Total PSD (dBm/MHz)	Duty Factor (dB)	Antenna Gain (dBi)	Total Corr'd EIRP PSD (dBm/MHz)	E.I.R.P PSD Limit (dBm/MHz)
			ANT 3	ANT 4					
11ax HE40	NSS1-MCS0	6525	-3.20	-3.58	-0.38	0.40	4.50	4.52	5.00
11ax HE80	NSS1-MCS0	6545	-3.20	-3.42	-0.29	0.40	4.50	4.61	5.00
11ax HE160	NSS1-MCS0	6505	-3.08	-3.10	-0.08	0.44	4.50	4.86	5.00

Maximum Conducted PSD (Extends across 6525MHz band)

Modulation Type	Data Rate	Frequency (MHz)	W/O Duty Factor Measured value of each antenna port (dBm/MHz)		W/O duty factor Total PSD (dBm/MHz)	Duty Factor (dB)	Antenna Gain (dBi)	Total Corr'd EIRP PSD (dBm/MHz)	E.I.R.P PSD Limit (dBm/MHz)
			ANT 3	ANT 4					
11ax HE40	NSS1-MCS0	6525	-3.28	-3.36	-0.31	0.40	4.50	4.59	5.00
11ax HE80	NSS1-MCS0	6545	-3.36	-3.29	-0.32	0.40	4.50	4.58	5.00
11ax HE160	NSS1-MCS0	6505	-3.31	-2.72	0.00	0.44	4.50	4.94	5.00



Non BeamForming

Maximum Conducted PSD (Within 6525-6875MHz band)

Modulation Type	Data Rate	Frequency (MHz)	W/O Duty Factor Measured value of each antenna port (dBm/MHz)		W/O duty factor Total PSD (dBm/MHz)	Duty Factor (dB)	Antenna Gain (dBi)	Total Corr'd EIRP PSD (dBm/MHz)	E.I.R.P PSD Limit (dBm/MHz)
			ANT 3	ANT 4					
11ax HE20	NSS1-MCS0	6875	-3.28	-3.71	-0.48	0.71	4.50	4.73	5.00
11ax HE40	NSS1-MCS0	6885	-3.26	-3.42	-0.33	0.40	4.50	4.57	5.00
11ax HE80	NSS1-MCS0	6865	-3.05	-3.55	-0.28	0.40	4.50	4.62	5.00
11ax HE160	NSS1-MCS0	6825	-2.67	-3.39	0.00	0.44	4.50	4.94	5.00

Maximum Conducted PSD (Extends across 6875MHz band)

Modulation Type	Data Rate	Frequency (MHz)	W/O Duty Factor Measured value of each antenna port (dBm/MHz)		W/O duty factor Total PSD (dBm/MHz)	Duty Factor (dB)	Antenna Gain (dBi)	Total Corr'd EIRP PSD (dBm/MHz)	E.I.R.P PSD Limit (dBm/MHz)
			ANT 3	ANT 4					
11ax HE20	NSS1-MCS0	6875	-3.37	-3.55	-0.45	0.71	4.00	4.26	5.00
11ax HE40	NSS1-MCS0	6885	-3.38	-3.34	-0.35	0.40	4.00	4.05	5.00
11ax HE80	NSS1-MCS0	6865	-3.04	-3.44	-0.22	0.40	4.00	4.18	5.00
11ax HE160	NSS1-MCS0	6825	-2.71	-3.33	0.00	0.44	4.00	4.44	5.00



BeamForming U-NII-5

Modulation Type	Data Rate	Channel	Frequency (MHz)	Measured value of each antenna port (dBm/MHz)		W/O duty factor Total PSD (dBm/MHz)	Duty Cycle CF(dB)	Antenna Gain (dBi)	Total Corr'd EIRP PSD (dBm/MHz)	E.I.R.P PSD Limit (dBm/MHz)
				ANT 3	ANT 4					
11ax HE20	NSS1-MCS0	33	6115	-6.12	-5.80	-2.95	0.41	7.31	4.77	5.00
11ax HE20	NSS1-MCS0	61	6255	-6.03	-5.76	-2.89	0.41	7.31	4.83	5.00
11ax HE20	NSS1-MCS0	93	6415	-6.68	-6.50	-3.58	0.41	7.31	4.14	5.00
11ax HE40	NSS1-MCS0	35	6125	-6.69	-5.25	-2.90	0.42	7.31	4.83	5.00
11ax HE40	NSS1-MCS0	59	6245	-6.73	-5.55	-3.09	0.42	7.31	4.64	5.00
11ax HE40	NSS1-MCS0	91	6405	-7.12	-6.19	-3.62	0.42	7.31	4.11	5.00
11ax HE80	NSS1-MCS0	39	6145	-6.71	-5.53	-3.07	0.48	7.31	4.72	5.00
11ax HE80	NSS1-MCS0	55	6225	-6.12	-5.64	-2.86	0.48	7.31	4.93	5.00
11ax HE80	NSS1-MCS0	87	6305	-6.20	-6.02	-3.10	0.48	7.31	4.69	5.00
11ax HE160	NSS1-MCS0	47	6185	-6.58	-5.58	-3.04	0.45	7.31	4.72	5.00
11ax HE160	NSS1-MCS0	79	6345	-6.23	-5.96	-3.08	0.45	7.31	4.68	5.00

BeamForming U-NII-6

Modulation Type	Data Rate	Channel	Frequency (MHz)	Measured value of each antenna port (dBm/MHz)		W/O duty factor Total PSD (dBm/MHz)	Duty Cycle CF(dB)	Antenna Gain (dBi)	Total Corr'd EIRP PSD (dBm/MHz)	E.I.R.P PSD Limit (dBm/MHz)
				ANT 3	ANT 4					
11ax HE20	NSS1-MCS0	97	6435	-6.71	-6.65	-3.67	0.41	7.31	4.05	5.00
11ax HE20	NSS1-MCS0	105	6475	-5.97	-5.75	-2.85	0.41	7.31	4.87	5.00
11ax HE20	NSS1-MCS0	113	6515	-6.65	-6.54	-3.58	0.41	7.31	4.14	5.00
11ax HE40	NSS1-MCS0	99	6445	-7.19	-6.24	-3.68	0.42	7.31	4.05	5.00
11ax HE40	NSS1-MCS0	107	6485	-6.12	-5.57	-2.83	0.42	7.31	4.90	5.00
11ax HE80	NSS1-MCS0	103	6465	-7.14	-6.43	-3.76	0.48	7.31	4.03	5.00



BeamForming U-NII-7

Modulation Type	Data Rate	Channel	Frequency (MHz)	Measured value of each antenna port (dBm/MHz)		W/O duty factor Total PSD (dBm/MHz)	Duty Cycle CF(dB)	Antenna Gain (dBi)	Total Corr'd EIRP PSD (dBm/MHz)	E.I.R.P PSD Limit (dBm/MHz)
				ANT 3	ANT 4					
11ax HE20	NSS1-MCS0	117	6535	-6.68	-6.61	-3.63	0.41	7.51	4.29	5.00
11ax HE20	NSS1-MCS0	153	6715	-6.80	-6.10	-3.43	0.41	7.51	4.49	5.00
11ax HE20	NSS1-MCS0	181	6885	-6.05	-6.13	-3.08	0.41	7.51	4.84	5.00
11ax HE40	NSS1-MCS0	123	6565	-6.48	-6.10	-3.28	0.42	7.51	4.65	5.00
11ax HE40	NSS1-MCS0	155	6725	-6.69	-6.83	-3.75	0.42	7.51	4.18	5.00
11ax HE40	NSS1-MCS0	179	6845	-6.53	-5.54	-3.00	0.42	7.51	4.93	5.00
11ax HE80	NSS1-MCS0	135	6625	-7.32	-6.69	-3.98	0.48	7.51	4.01	5.00
11ax HE80	NSS1-MCS0	151	6705	-6.22	-6.15	-3.18	0.48	7.51	4.81	5.00
11ax HE80	NSS1-MCS0	167	6785	-6.15	-5.91	-3.02	0.48	7.51	4.97	5.00
11ax HE160	NSS1-MCS0	143	6665	-6.37	-6.34	-3.34	0.45	7.51	4.62	5.00

BeamForming U-NII-8

Modulation Type	Data Rate	Channel	Frequency (MHz)	Measured value of each antenna port (dBm/MHz)		W/O duty factor Total PSD (dBm/MHz)	Duty Cycle CF(dB)	Antenna Gain (dBi)	Total Corr'd EIRP PSD (dBm/MHz)	E.I.R.P PSD Limit (dBm/MHz)
				ANT 3	ANT 4					
11ax HE20	NSS1-MCS0	189	6895	-5.31	-5.55	-2.42	0.41	6.86	4.85	5.00
11ax HE20	NSS1-MCS0	213	7015	-5.46	-5.48	-2.46	0.41	6.86	4.81	5.00
11ax HE20	NSS1-MCS0	229	7095	-5.55	-5.67	-2.60	0.41	6.86	4.67	5.00
11ax HE20	NSS1-MCS0	233	7115	-5.61	-5.80	-2.69	0.41	6.86	4.58	5.00
11ax HE40	NSS1-MCS0	195	6925	-5.68	-5.49	-2.57	0.42	6.86	4.71	5.00
11ax HE40	NSS1-MCS0	211	7005	-6.11	-6.11	-3.10	0.42	6.86	4.18	5.00
11ax HE40	NSS1-MCS0	227	7085	-6.00	-6.07	-3.03	0.42	6.86	4.25	5.00
11ax HE80	NSS1-MCS0	199	6945	-6.16	-5.78	-2.96	0.48	6.86	4.38	5.00
11ax HE80	NSS1-MCS0	215	7025	-5.61	-5.42	-2.50	0.48	6.86	4.84	5.00
11ax HE160	NSS1-MCS0	207	6985	-6.01	-5.97	-2.98	0.45	6.86	4.33	5.00



BeamForming

Maximum Conducted PSD (Within 6425-6525MHz band)

Modulation Type	Data Rate	Frequency (MHz)	W/O Duty Factor Measured value of each antenna port (dBm/MHz)		W/O duty factor Total PSD (dBm/MHz)	Duty Factor (dB)	Antenna Gain (dBi)	Total Corr'd EIRP PSD (dBm/MHz)	E.I.R.P PSD Limit (dBm/MHz)
			ANT 3	ANT 4					
11ax HE40	NSS1-MCS0	6525	-7.07	-6.48	-3.75	0.42	7.31	3.98	5.00
11ax HE80	NSS1-MCS0	6545	-7.19	-6.73	-3.94	0.48	7.31	3.85	5.00
11ax HE160	NSS1-MCS0	6505	-6.41	-5.99	-3.18	0.45	7.31	4.58	5.00

Maximum Conducted PSD (Extends across 6525MHz band)

Modulation Type	Data Rate	Frequency (MHz)	W/O Duty Factor Measured value of each antenna port (dBm/MHz)		W/O duty factor Total PSD (dBm/MHz)	Duty Factor (dB)	Antenna Gain (dBi)	Total Corr'd EIRP PSD (dBm/MHz)	E.I.R.P PSD Limit (dBm/MHz)
			ANT 3	ANT 4					
11ax HE40	NSS1-MCS0	6525	-7.11	-6.39	-3.72	0.42	7.51	4.21	5.00
11ax HE80	NSS1-MCS0	6545	-7.39	-6.63	-3.98	0.48	7.51	4.01	5.00
11ax HE160	NSS1-MCS0	6505	-6.23	-5.82	-3.01	0.45	7.51	4.95	5.00



BeamForming

Maximum Conducted PSD (Within 6525-6875MHz band)

Modulation Type	Data Rate	Frequency (MHz)	W/O Duty Factor Measured value of each antenna port (dBm/MHz)		W/O duty factor Total PSD (dBm/MHz)	Duty Factor (dB)	Antenna Gain (dBi)	Total Corr'd EIRP PSD (dBm/MHz)	E.I.R.P PSD Limit (dBm/MHz)
			ANT 3	ANT 4					
11ax HE20	NSS1-MCS0	6875	-6.21	-6.36	-3.27	0.41	7.51	4.65	5.00
11ax HE40	NSS1-MCS0	6885	-6.71	-6.62	-3.66	0.42	7.51	4.27	5.00
11ax HE80	NSS1-MCS0	6865	-6.36	-5.75	-3.04	0.48	7.51	4.95	5.00
11ax HE160	NSS1-MCS0	6825	-6.74	-6.08	-3.38	0.45	7.51	4.58	5.00

Maximum Conducted PSD (Extends across 6875MHz band)

Modulation Type	Data Rate	Frequency (MHz)	W/O Duty Factor Measured value of each antenna port (dBm/MHz)		W/O duty factor Total PSD (dBm/MHz)	Duty Factor (dB)	Antenna Gain (dBi)	Total Corr'd EIRP PSD (dBm/MHz)	E.I.R.P PSD Limit (dBm/MHz)
			ANT 3	ANT 4					
11ax HE20	NSS1-MCS0	6875	-6.07	-6.41	-3.23	0.41	6.86	4.04	5.00
11ax HE40	NSS1-MCS0	6885	-6.69	-6.66	-3.66	0.42	6.86	3.62	5.00
11ax HE80	NSS1-MCS0	6865	-6.43	-5.98	-3.19	0.48	6.86	4.15	5.00
11ax HE160	NSS1-MCS0	6825	-6.68	-6.30	-3.47	0.45	6.86	3.84	5.00



U-NII-5

Non BeamForming

ANT 3

Modulation Type: 802.11ax HE20 (7.3Mbps)

CH33

Modulation Type: 802.11ax HE40 (14.6Mbps)

CH35

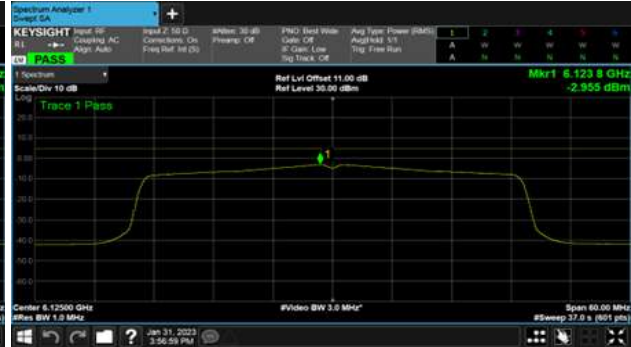
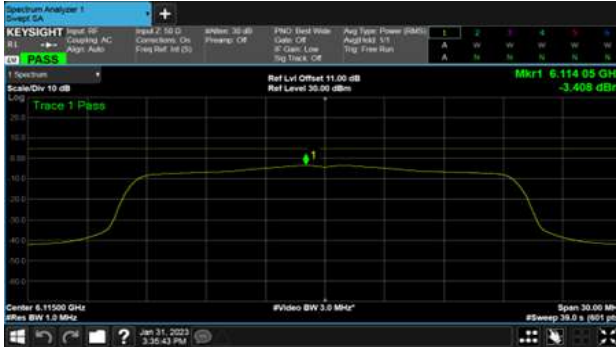

CH61

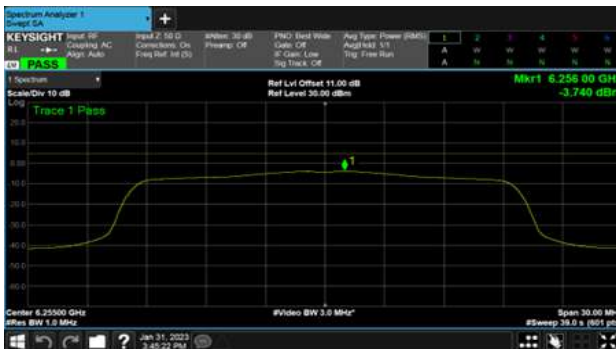

CH59

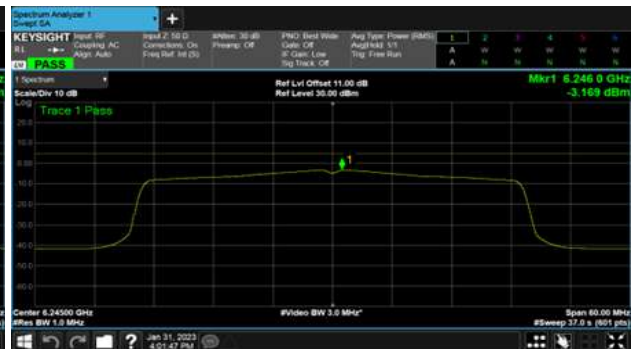

CH93

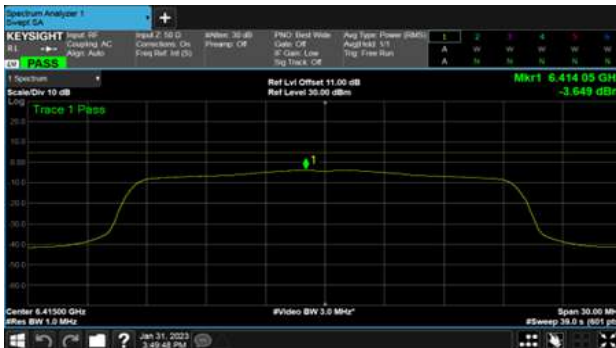

CH91





U-NII-5

Non BeamForming

ANT 3

Modulation Type: 802.11ax HE80 (30.6Mbps)
CH39

Modulation Type: 802.11ax HE160 (61.3Mbps)
CH47

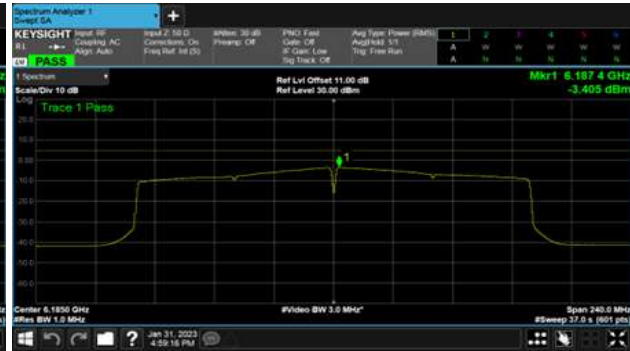
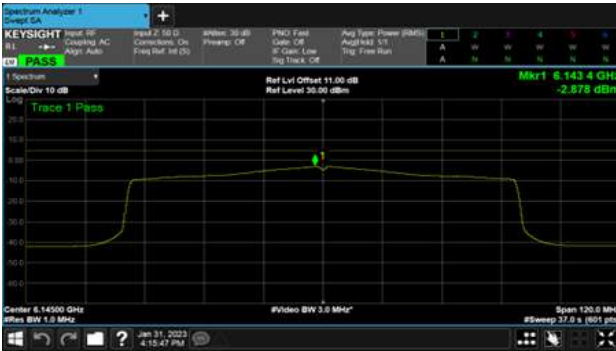

CH55

CH79

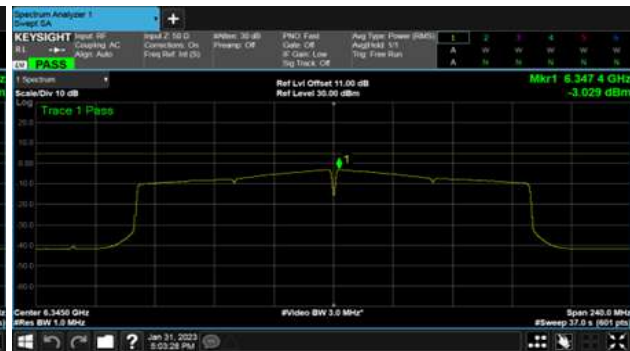
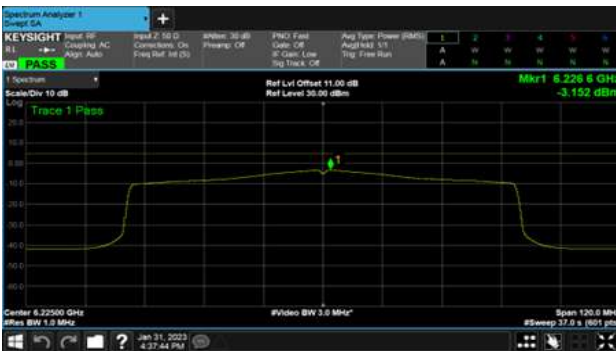

CH87

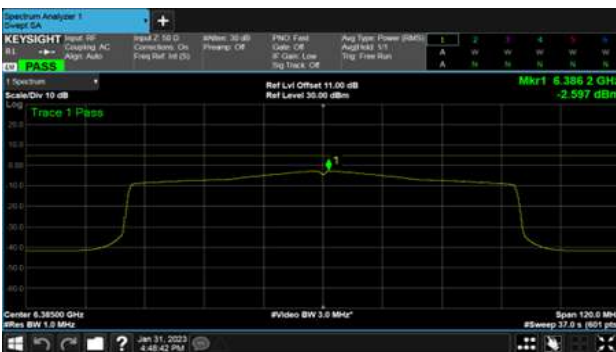



U-NII-5

Non BeamForming

ANT 4

Modulation Type: 802.11ax HE20 (7.3Mbps)

CH33

Modulation Type: 802.11ax HE40 (14.6Mbps)

CH35

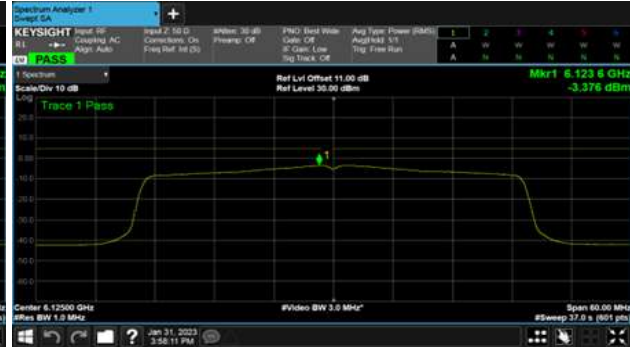
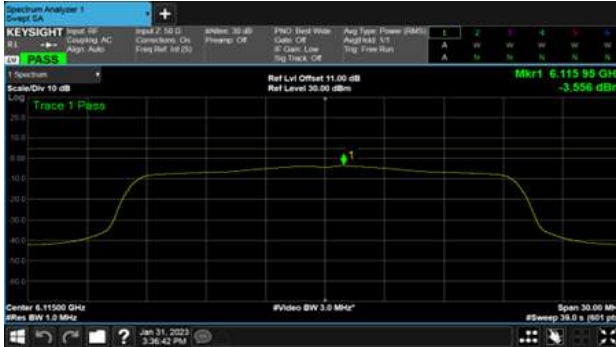

CH61



CH59

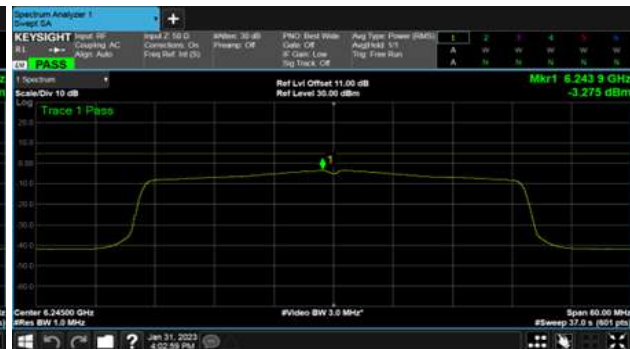

CH93

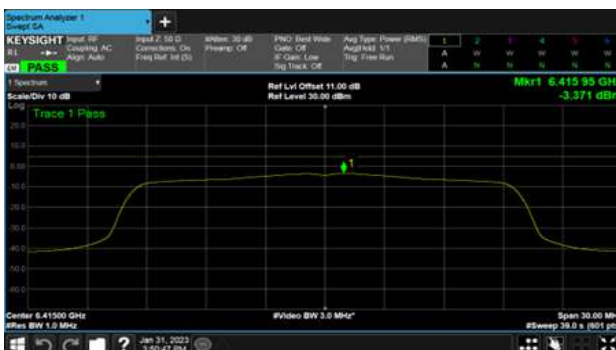

CH91

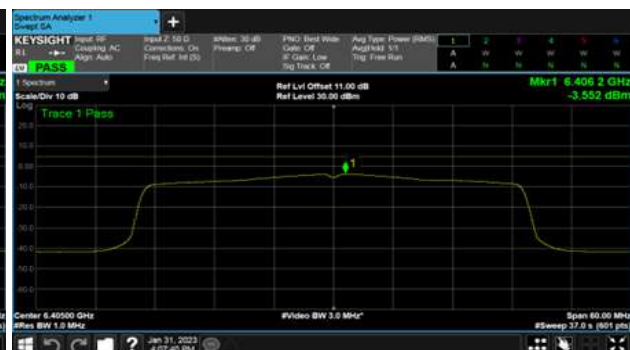



U-NII-5

Non BeamForming

ANT 4

Modulation Type: 802.11ax HE80 (30.6Mbps)
CH39

Modulation Type: 802.11ax HE160 (61.3Mbps)
CH47

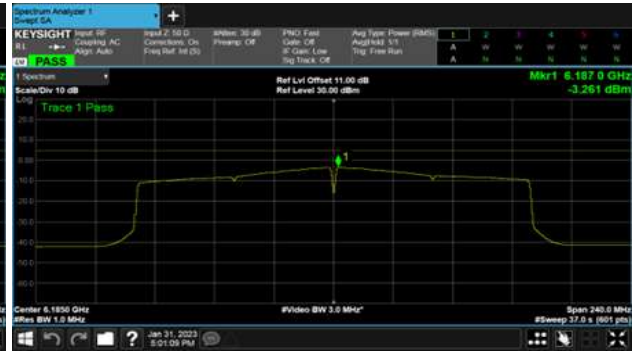
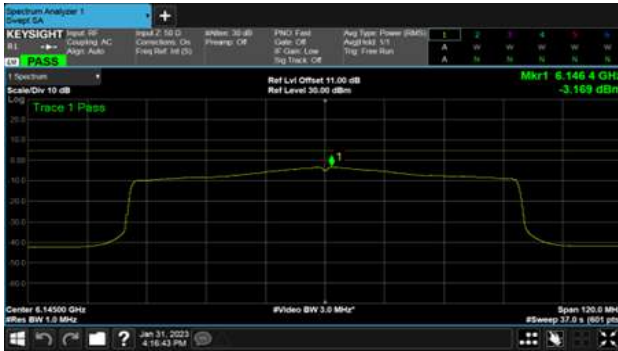

CH55

CH79

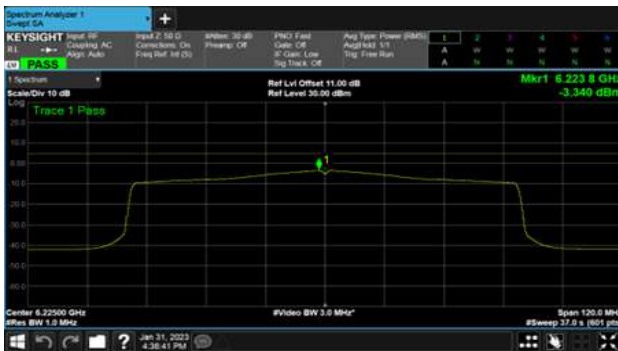

CH87

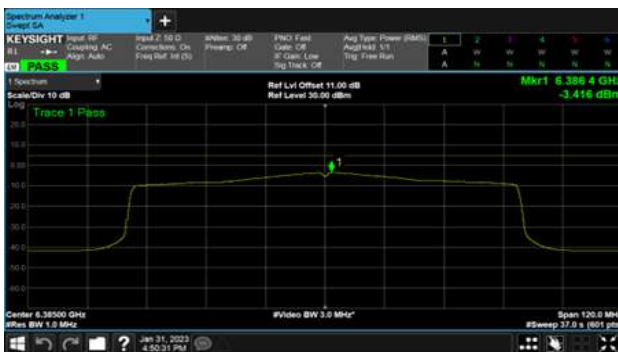



U-NII-6

Non BeamForming

ANT 3

Modulation Type: 802.11ax HE20 (7.3Mbps)

CH97

Modulation Type: 802.11ax HE40 (14.6Mbps)

CH99

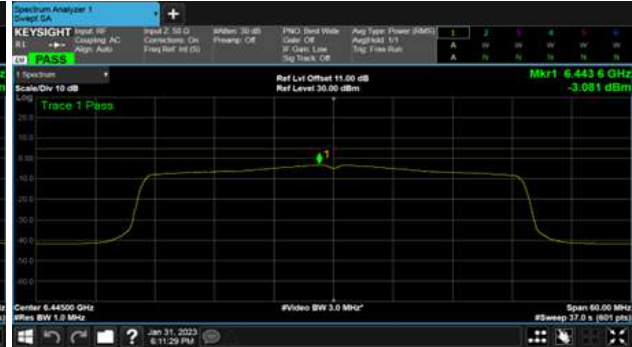
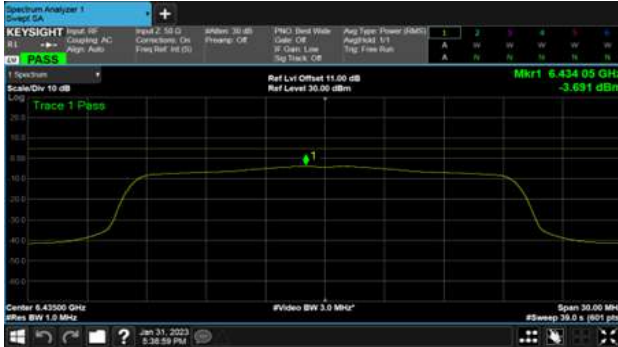

CH105

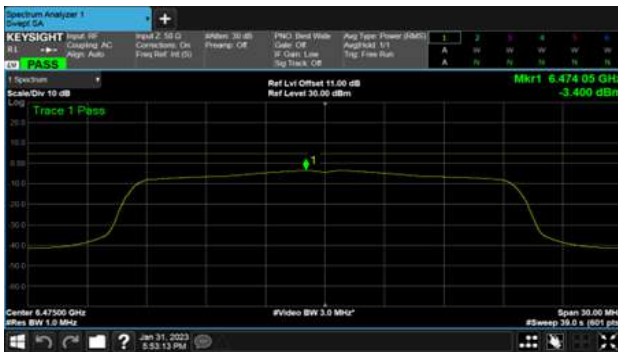

CH107

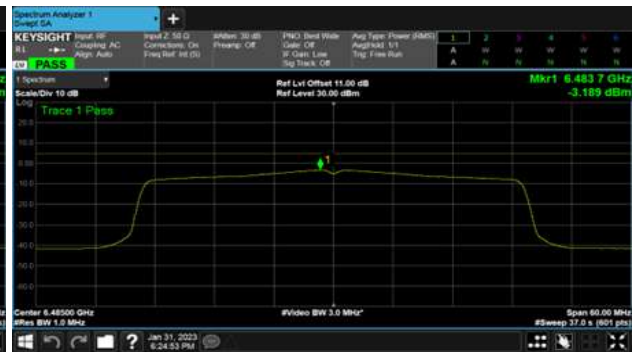

CH113

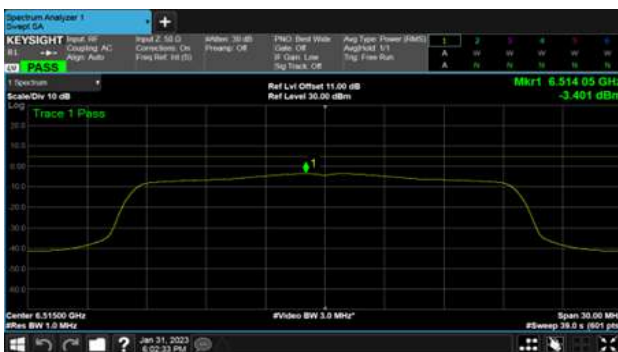



U-NII-6
Non BeamForming
ANT 3
Modulation Type: 802.11ax HE80 (30.6Mbps)
CH103





U-NII-6

Non BeamForming

ANT 4

Modulation Type: 802.11ax HE20 (7.3Mbps)

CH97

Modulation Type: 802.11ax HE40 (14.6Mbps)

CH99

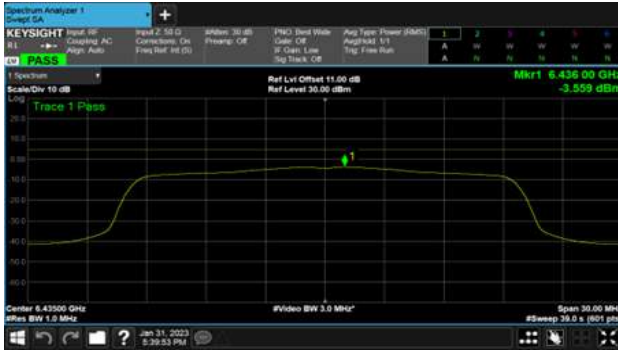

CH105

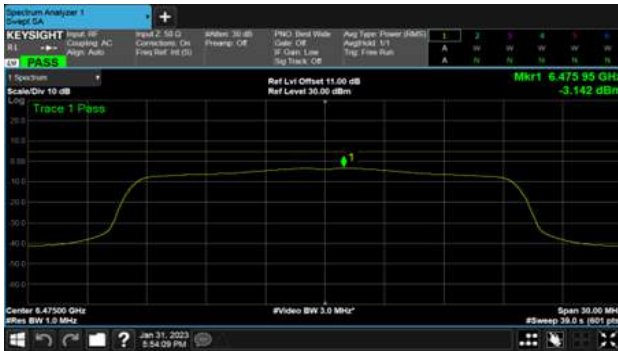

CH107

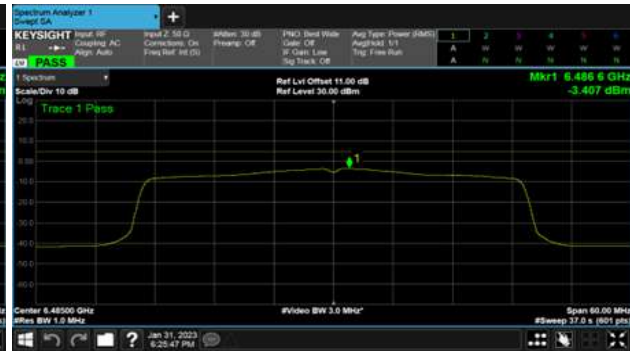

CH113

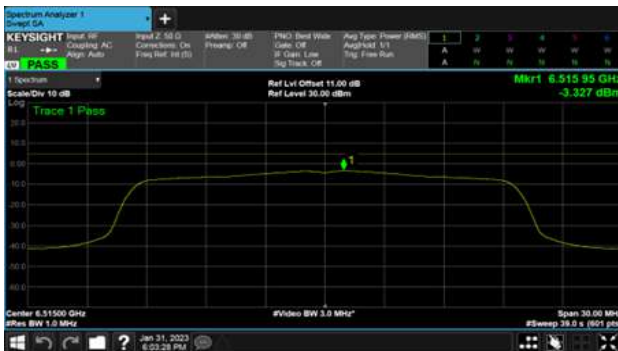



U-NII-6
Non BeamForming
ANT 4
Modulation Type: 802.11ax HE80 (30.6Mbps)
CH103

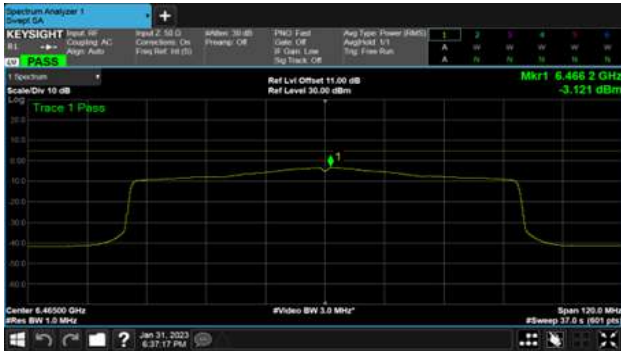



Within 6425-6525MHz band Straddle Channel
Non BeamForming
ANT 3
Modulation Type: 802.11ax HE40 (14.6Mbps)
CH115



Modulation Type: 802.11ax HE80 (30.6Mbps)
CH119



Modulation Type: 802.11ax HE160 (61.3Mbps)
CH111





Within 6425-6525MHz band Straddle Channel
Non BeamForming
ANT 4
Modulation Type: 802.11ax HE40 (14.6Mbps)
CH115



Modulation Type: 802.11ax HE80 (30.6Mbps)
CH119



Modulation Type: 802.11ax HE160 (61.3Mbps)
CH111





U-NII-7

Non BeamForming

ANT 3

Modulation Type: 802.11ax HE20 (7.3Mbps)

CH117

Modulation Type: 802.11ax HE40 (14.6Mbps)

CH123

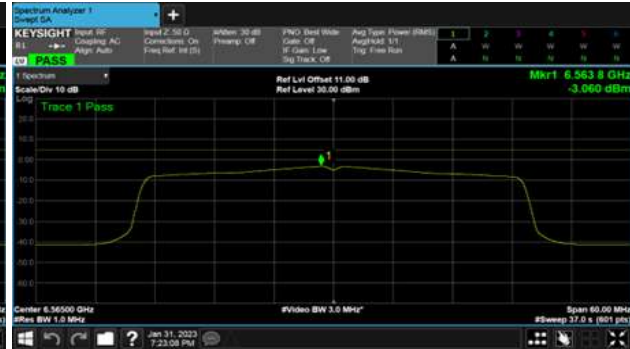
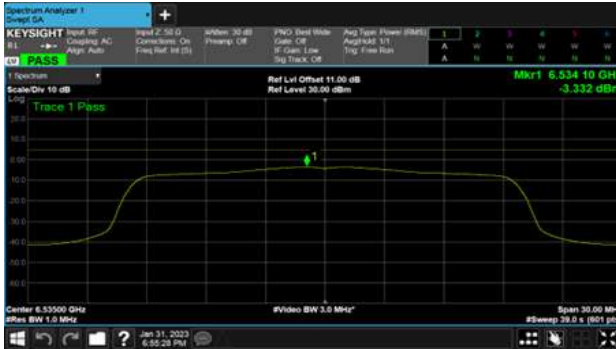

CH153

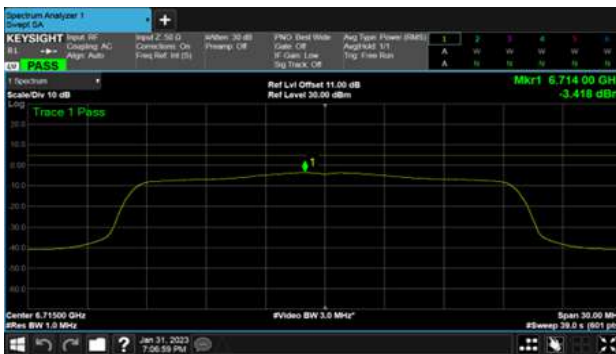

CH155

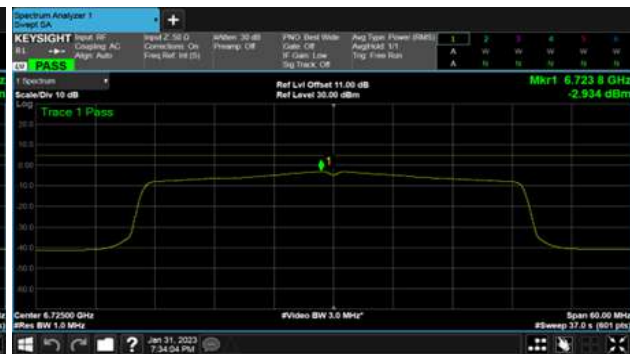

CH181

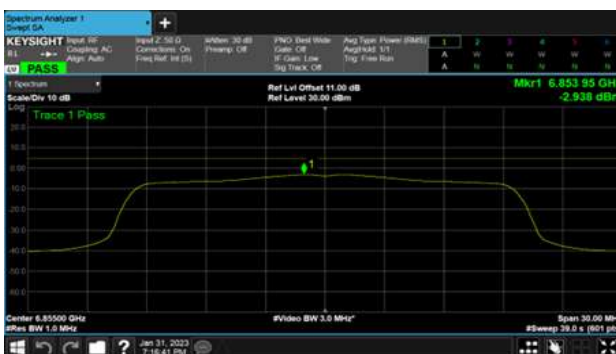

CH179

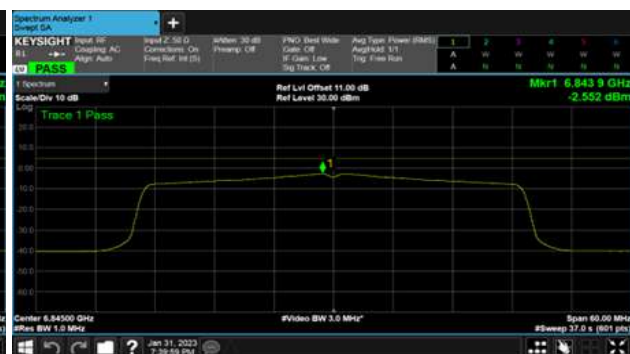



U-NII-7

Non BeamForming

ANT 3

Modulation Type: 802.11ax HE80 (30.6Mbps)
CH135

Modulation Type: 802.11ax HE160 (61.3Mbps)
CH143

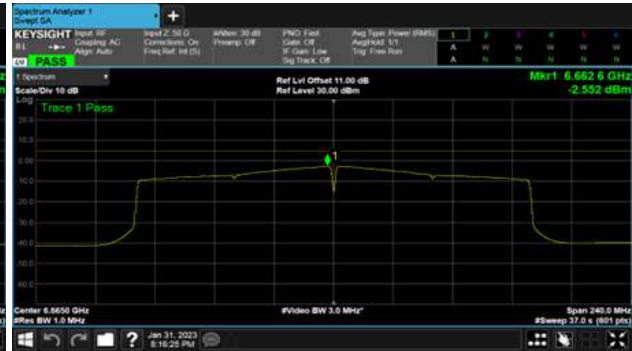
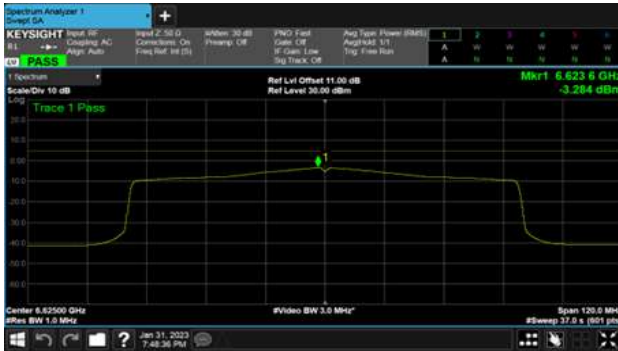

CH151

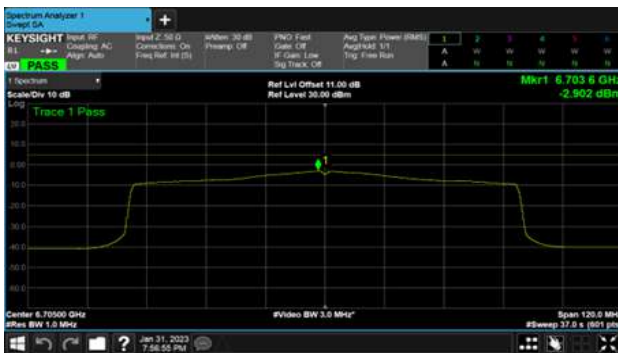

CH167

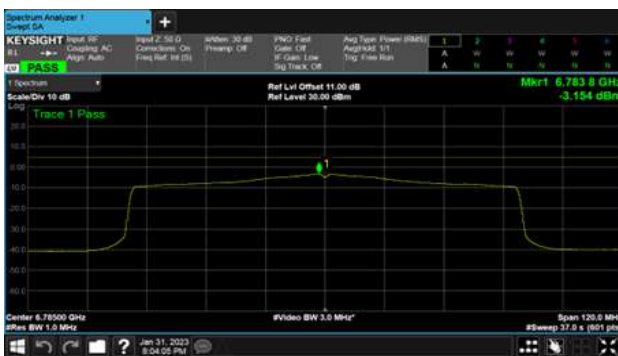



U-NII-7

Non BeamForming

ANT 4

Modulation Type: 802.11ax HE20 (7.3Mbps)

CH117

Modulation Type: 802.11ax HE40 (14.6Mbps)

CH123

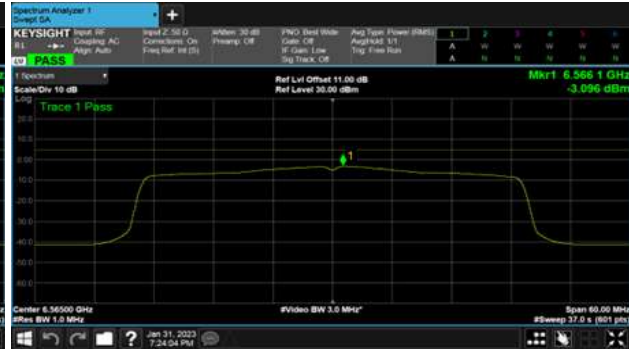
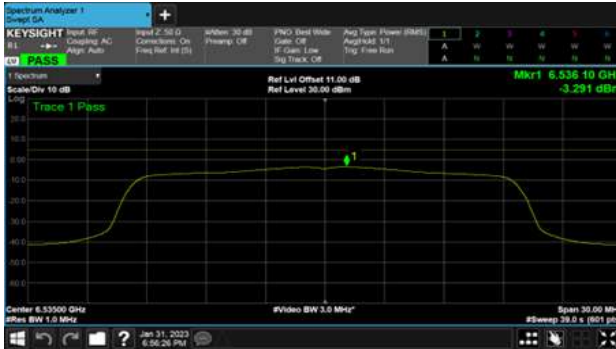

CH153

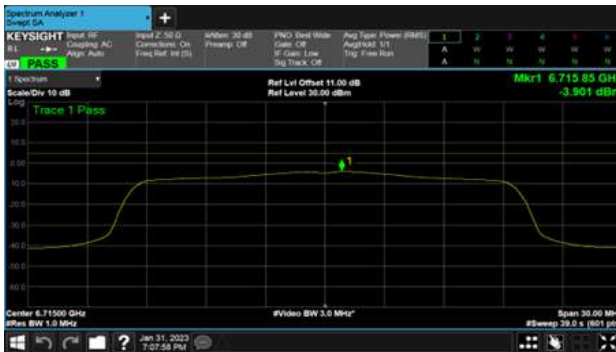

CH155



CH181

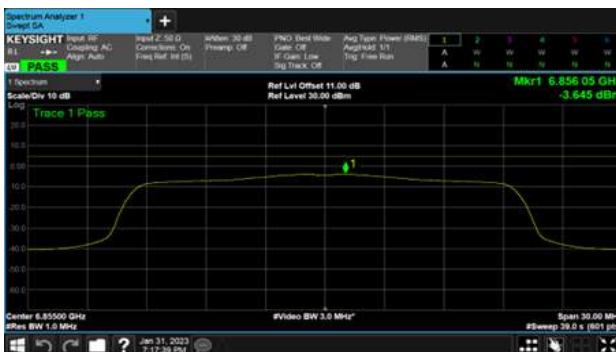

CH179

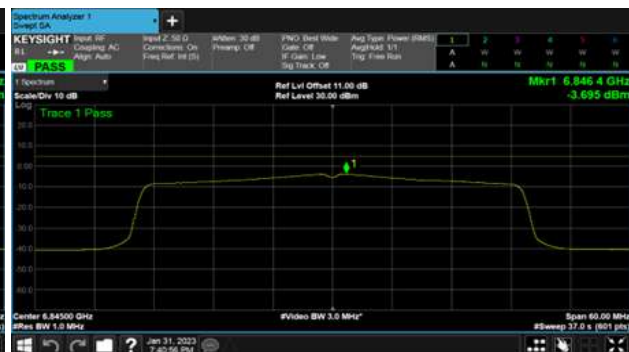



U-NII-7

Non BeamForming

ANT 4

Modulation Type: 802.11ax HE80 (30.6Mbps)
CH135

Modulation Type: 802.11ax HE160 (61.3Mbps)
CH143

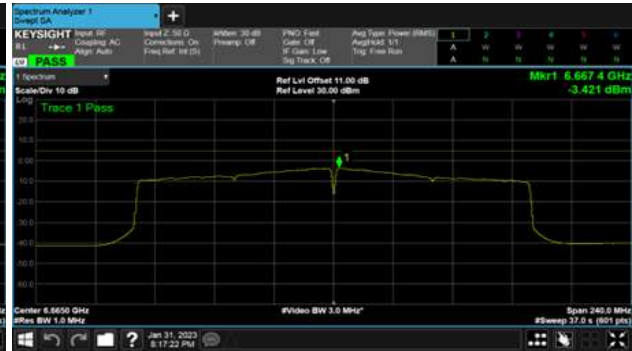
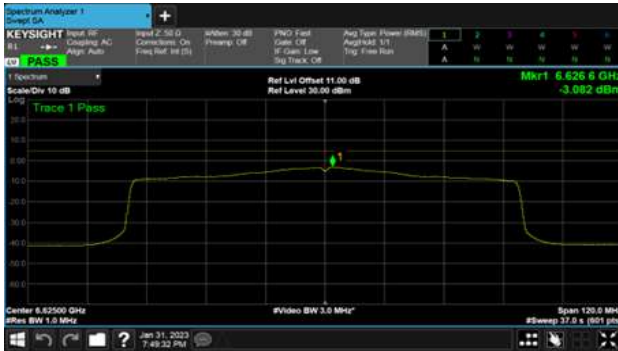

CH151

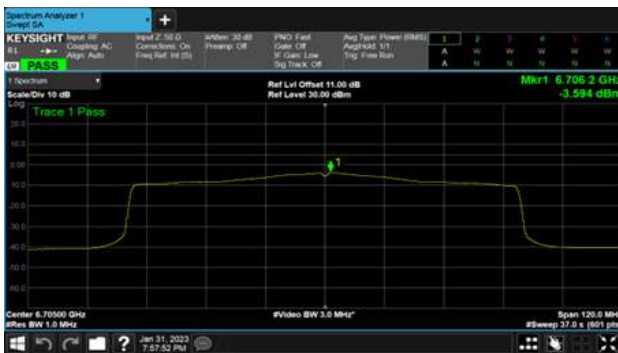

CH167

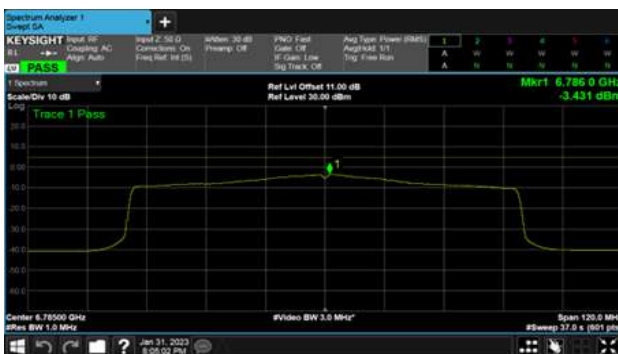



Extends across 6525MHz band

Non BeamForming

ANT 3

Modulation Type: 802.11ax HE40 (14.6Mbps)

CH115

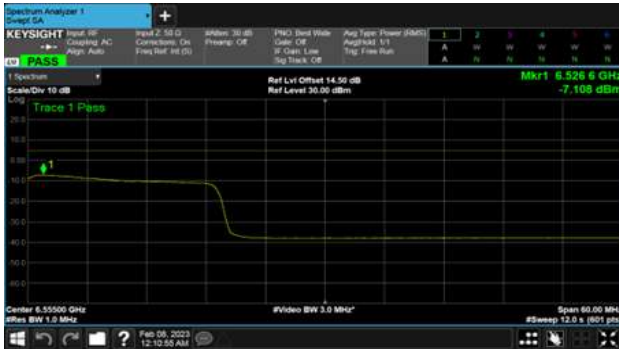

Modulation Type: 802.11ax HE80 (30.6Mbps)

CH119



Modulation Type: 802.11ax HE160 (61.3Mbps)

CH111





Extends across 6525MHz band

Non BeamForming

ANT 4

Modulation Type: 802.11ax HE40 (14.6Mbps)

CH115

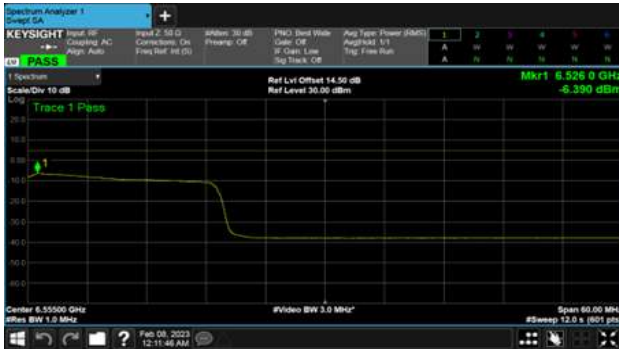

Modulation Type: 802.11ax HE80 (30.6Mbps)

CH119



Modulation Type: 802.11ax HE160 (61.3Mbps)

CH111





Within 6525-6875MHz band

Non BeamForming

ANT 3

Modulation Type: 802.11ax HE20 (7.3Mbps)
CH185

Modulation Type: 802.11ax HE160 (61.3Mbps)
CH175

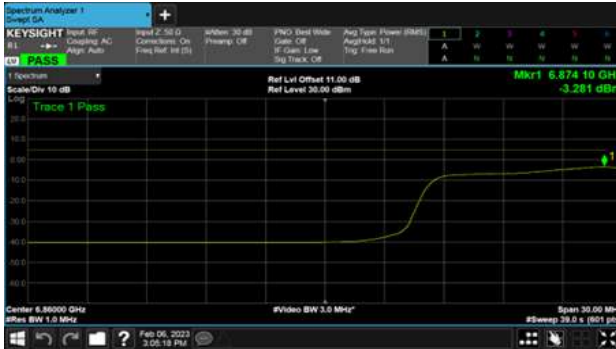

Modulation Type: 802.11ax HE40 (14.6Mbps)
CH187



Modulation Type: 802.11ax HE80 (30.6Mbps)
CH183





Within 6525-6875MHz band

Non BeamForming

ANT 4

Modulation Type: 802.11ax HE20 (7.3Mbps)
CH185

Modulation Type: 802.11ax HE160 (61.3Mbps)
CH175

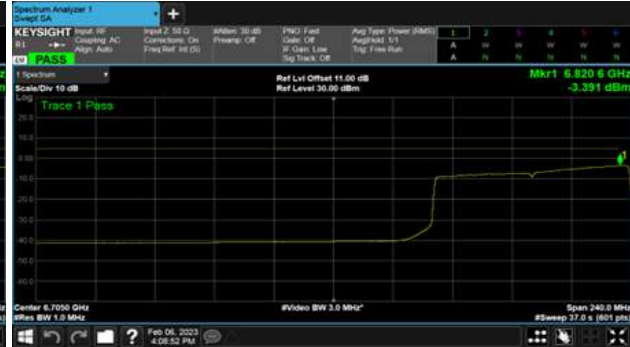
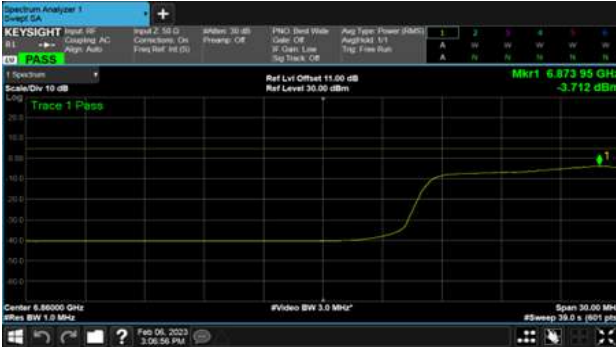

Modulation Type: 802.11ax HE40 (14.6Mbps)
CH187



Modulation Type: 802.11ax HE80 (30.6Mbps)
CH183





U-NII-8

Non BeamForming

ANT 3

Modulation Type: 802.11ax HE20 (7.3Mbps)

CH189

Modulation Type: 802.11ax HE20 (7.3Mbps)

CH233

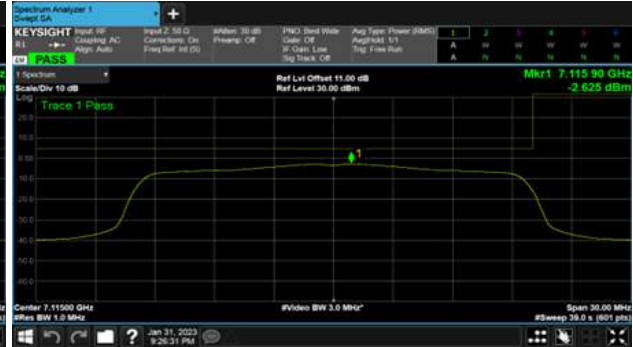
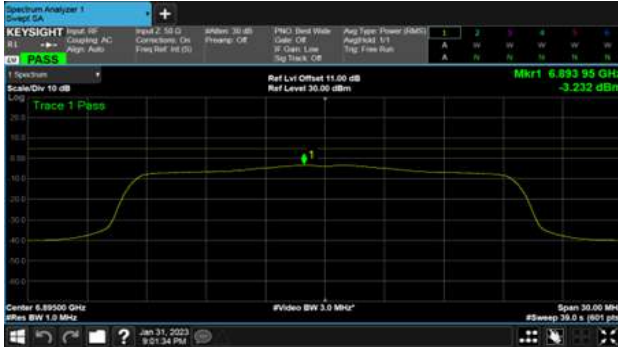

CH213

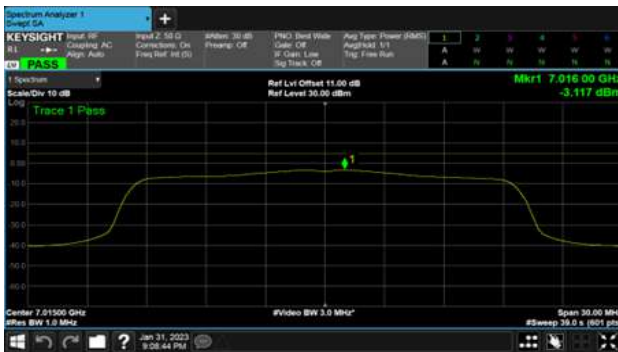

CH229

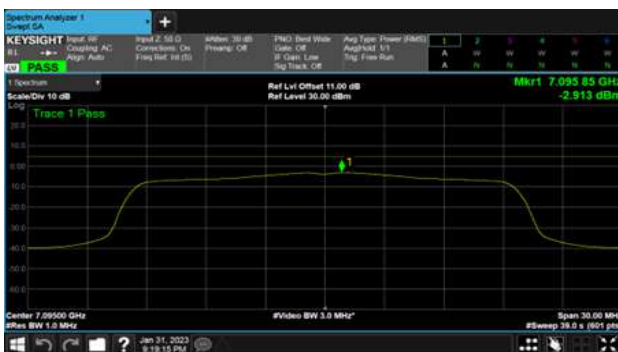



U-NII-8

Non BeamForming

ANT 3

Modulation Type: 802.11ax HE40 (14.6Mbps)
CH195

Modulation Type: 802.11ax HE80 (30.6Mbps)
CH199

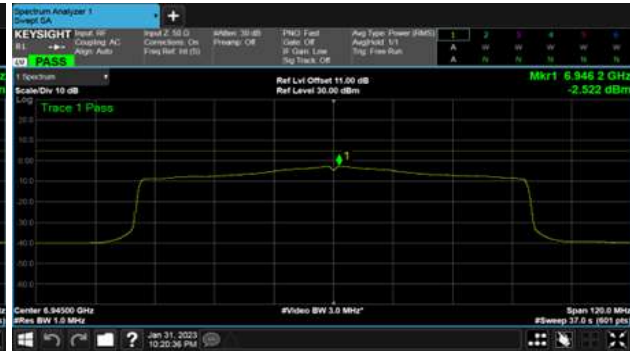
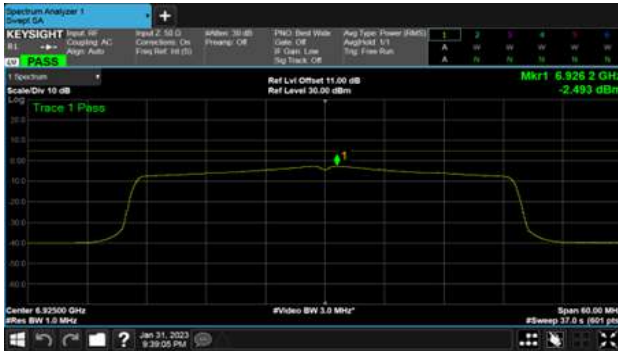

CH211

CH215

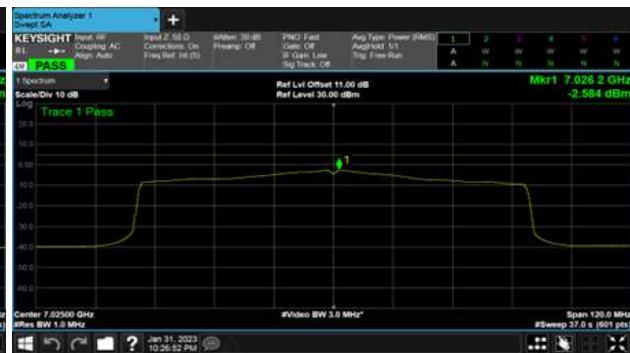

CH227

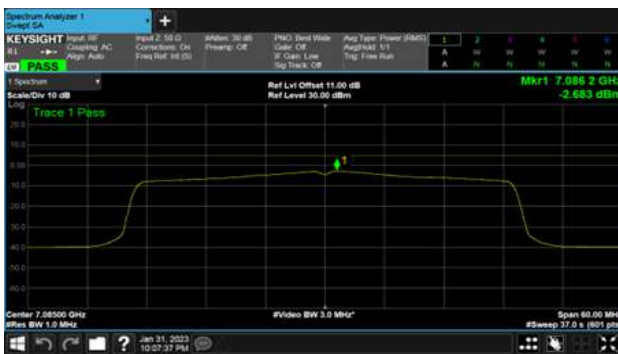



U-NII-8

Non BeamForming

ANT 3

Modulation Type: 802.11ax HE160 (61.3Mbps)

CH207

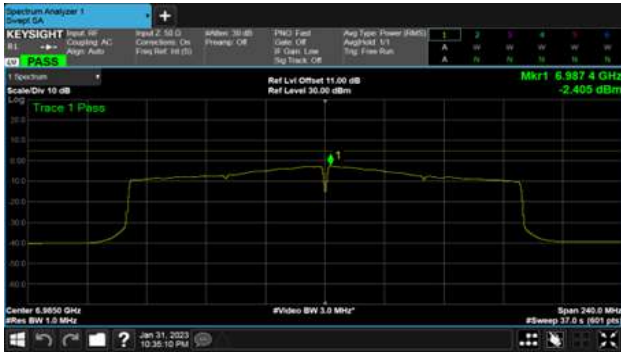



U-NII-8

Non BeamForming

ANT 4

Modulation Type: 802.11ax HE20 (7.3Mbps)

CH189

Modulation Type: 802.11ax HE20 (7.3Mbps)

CH233

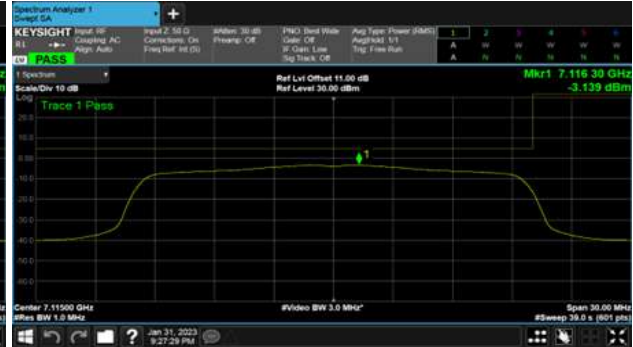
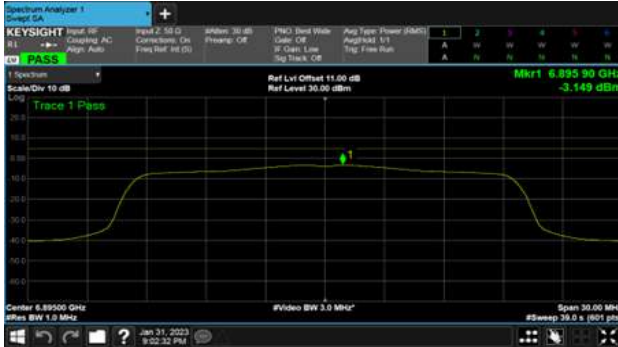

CH213

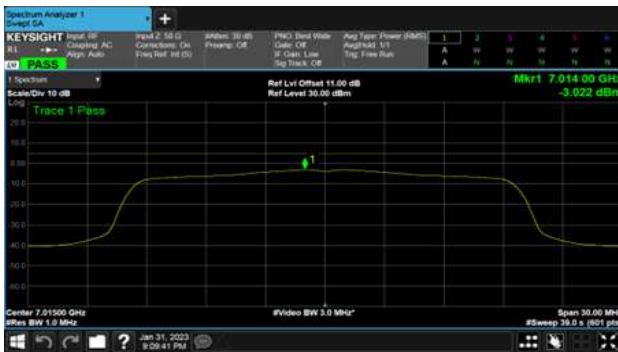

CH229

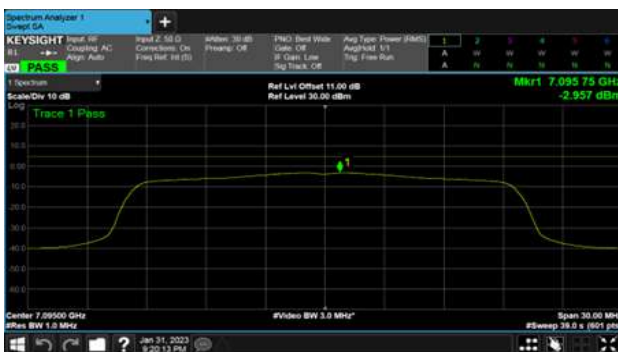



U-NII-8

Non BeamForming

ANT 4

Modulation Type: 802.11ax HE40 (14.6Mbps)
CH195

Modulation Type: 802.11ax HE80 (30.6Mbps)
CH199

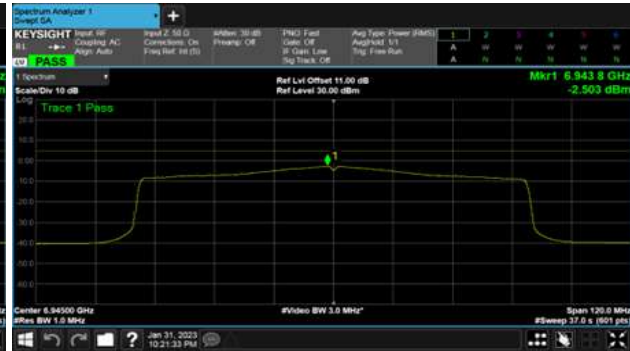
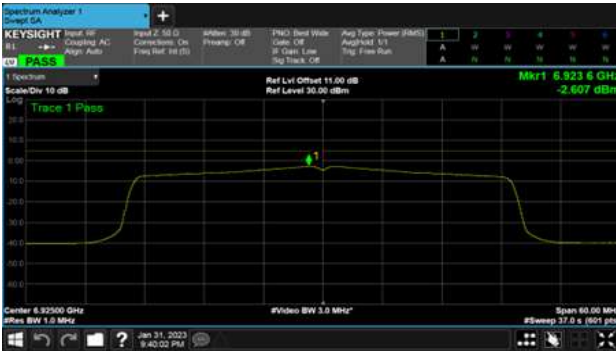

CH211

CH215

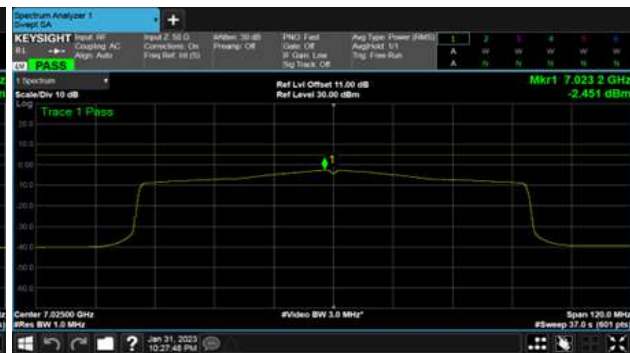
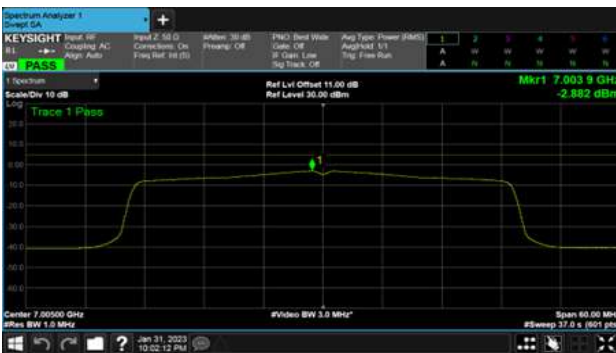

CH227

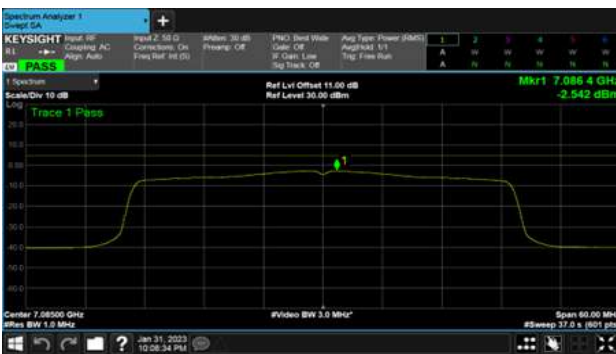



U-NII-8
Non BeamForming
ANT 4
Modulation Type: 802.11ax HE160 (61.3Mbps)
CH207

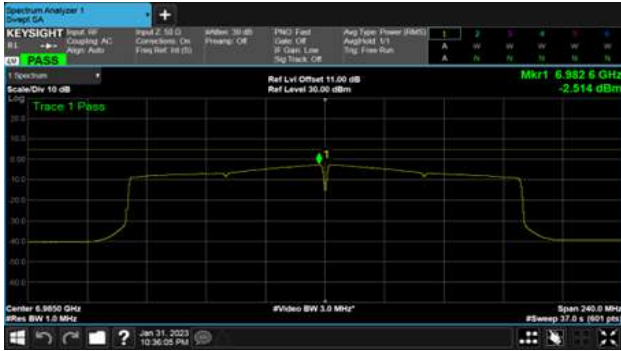



Extends across 6875MHz band

Non BeamForming

ANT 3

Modulation Type: 802.11ax HE20 (7.3Mbps)
CH185

Modulation Type: 802.11ax HE160 (61.3Mbps)
CH175

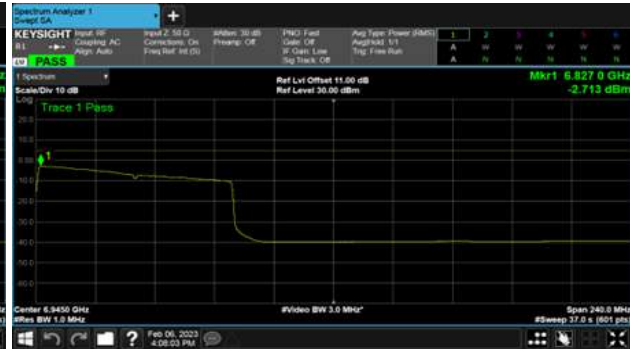
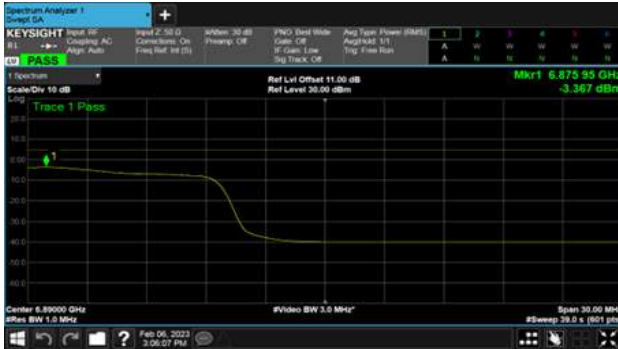

Modulation Type: 802.11ax HE40 (14.6Mbps)
CH187

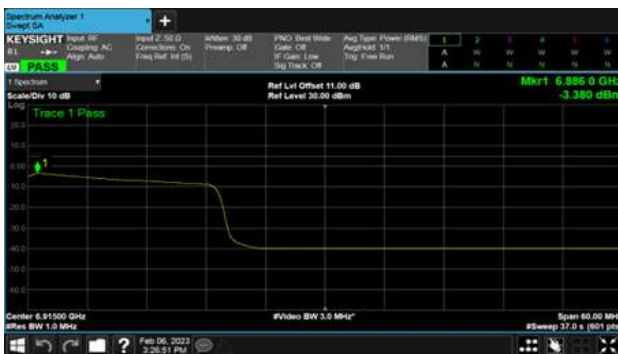

Modulation Type: 802.11ax HE80 (30.6Mbps)
CH183

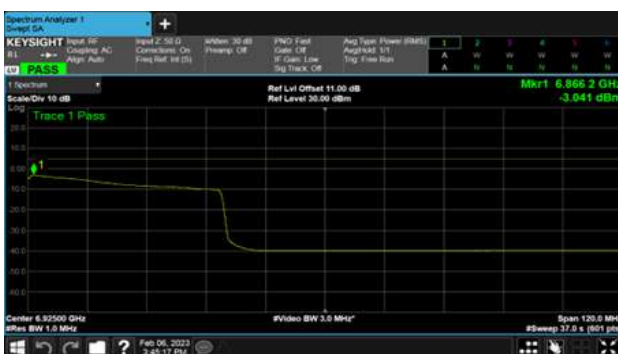



Extends across 6875MHz band

Non BeamForming

ANT 4

Modulation Type: 802.11ax HE20 (7.3Mbps)
CH185

Modulation Type: 802.11ax HE160 (61.3Mbps)
CH175

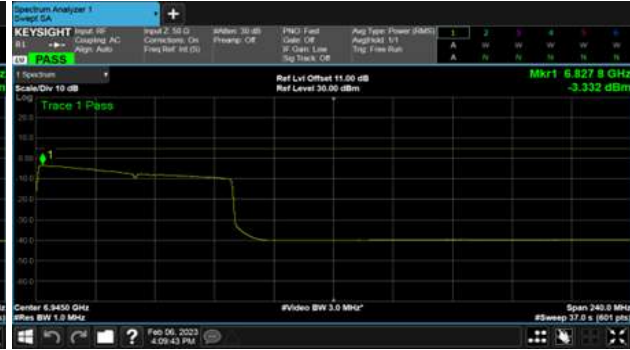
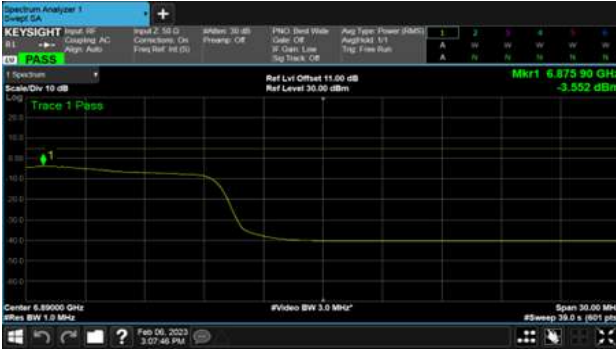

Modulation Type: 802.11ax HE40 (14.6Mbps)
CH187

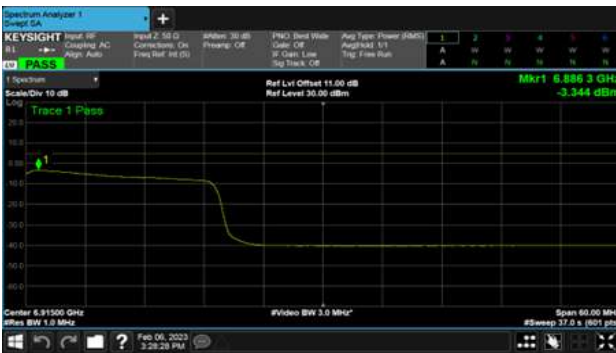

Modulation Type: 802.11ax HE80 (30.6Mbps)
CH183

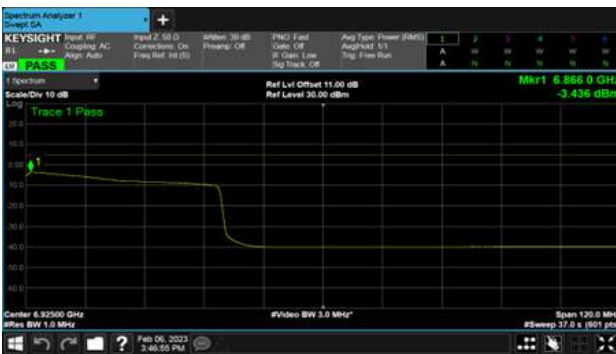



U-NII-5

BeamForming

ANT 3

Modulation Type: 802.11ax HE20 (7.3Mbps)

CH33

Modulation Type: 802.11ax HE40 (14.6Mbps)

CH35

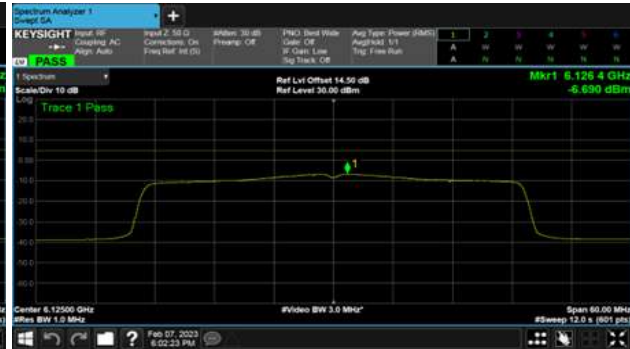
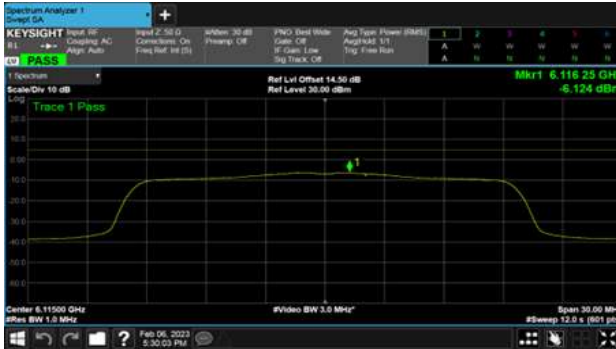

CH61

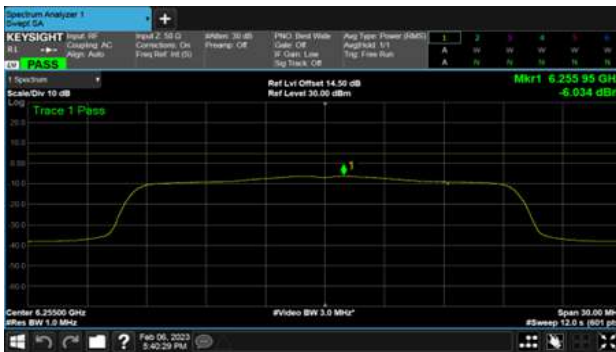

CH59

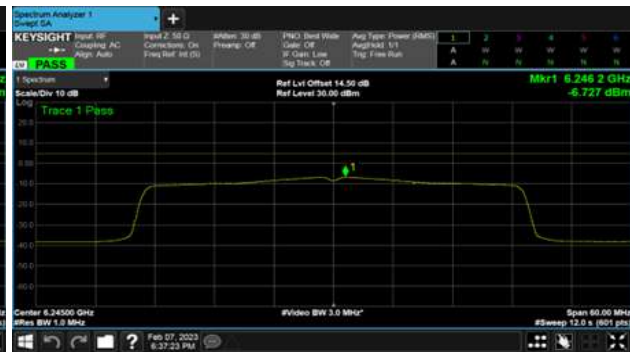

CH93

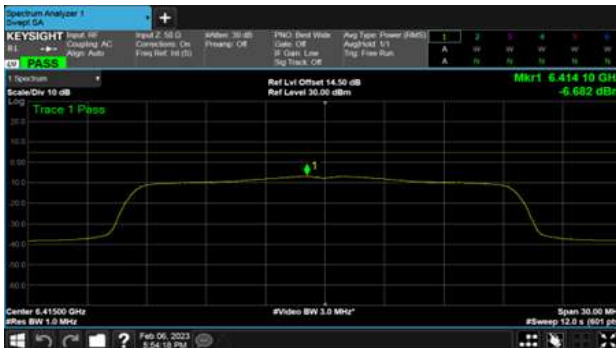

CH91

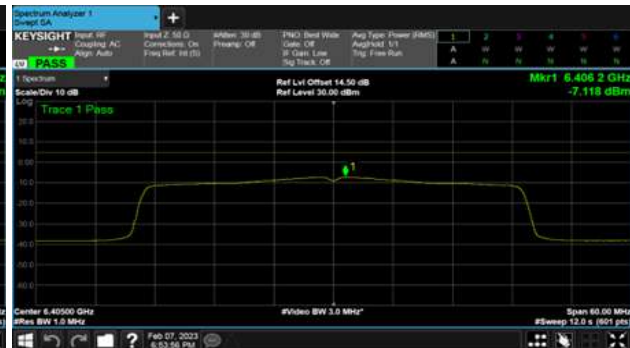



U-NII-5

BeamForming

ANT 3

Modulation Type: 802.11ax HE80 (30.6Mbps)
CH39

Modulation Type: 802.11ax HE160 (61.3Mbps)
CH47

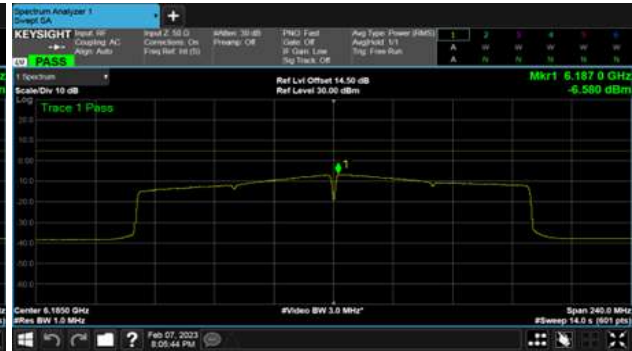
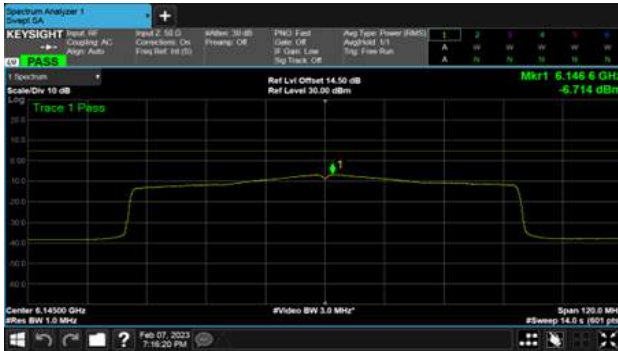

CH55

CH79

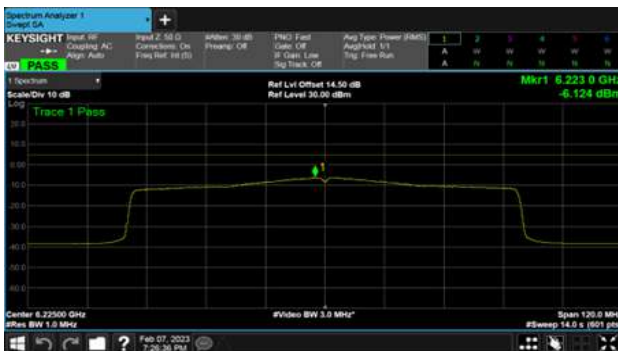

CH87

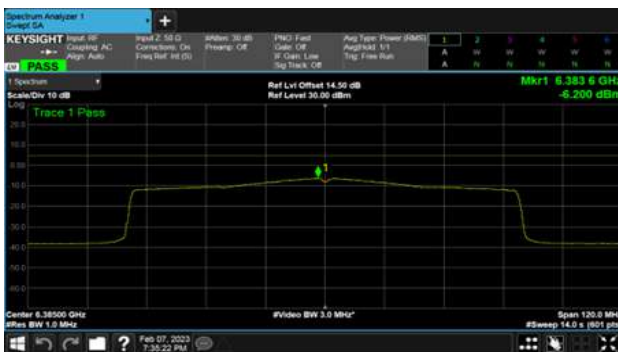



U-NII-5

BeamForming

ANT 4

Modulation Type: 802.11ax HE20 (7.3Mbps)

CH33

Modulation Type: 802.11ax HE40 (14.6Mbps)

CH35

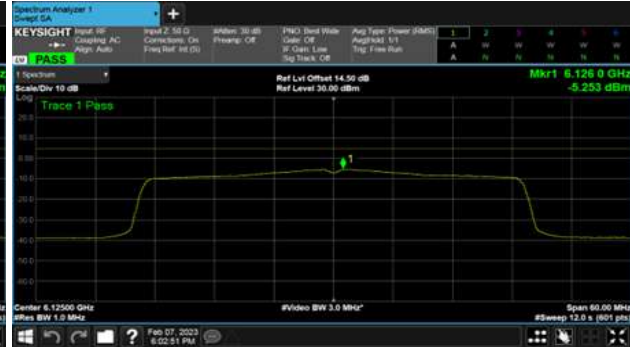
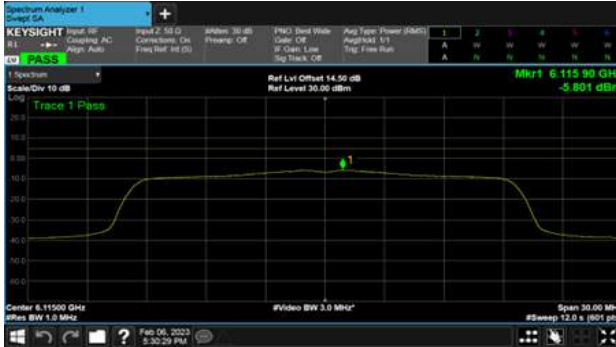

CH61

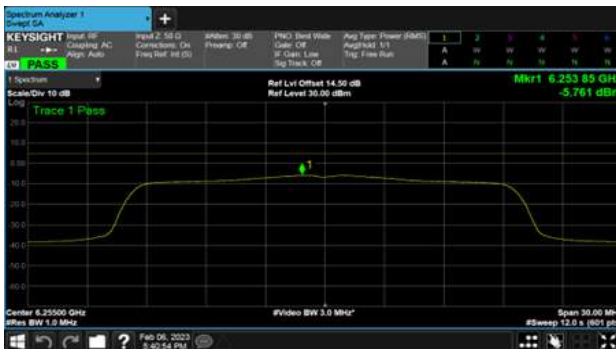

CH59

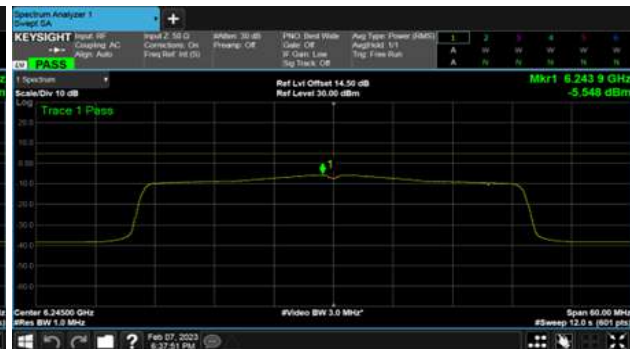

CH93

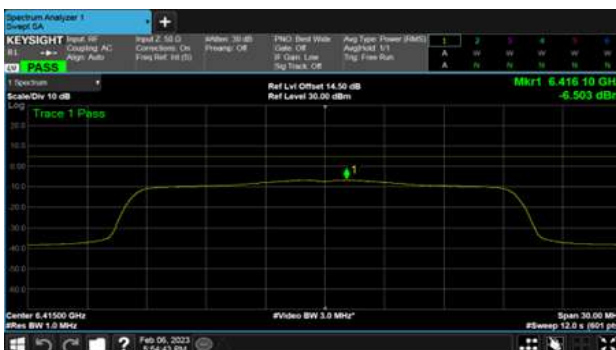

CH91





U-NII-5

BeamForming

ANT 4

Modulation Type: 802.11ax HE80 (30.6Mbps)
CH39

Modulation Type: 802.11ax HE160 (61.3Mbps)
CH47

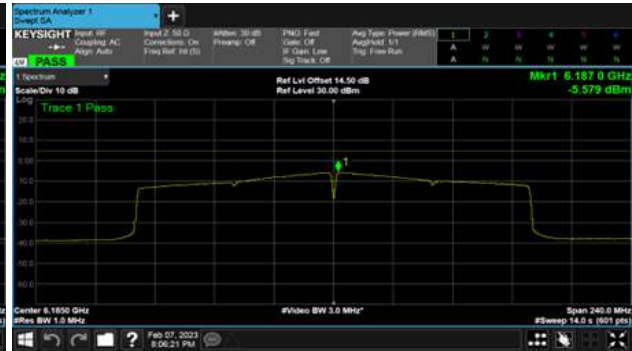
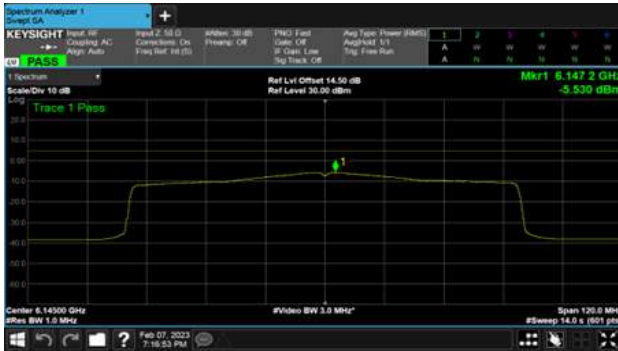

CH55

CH79

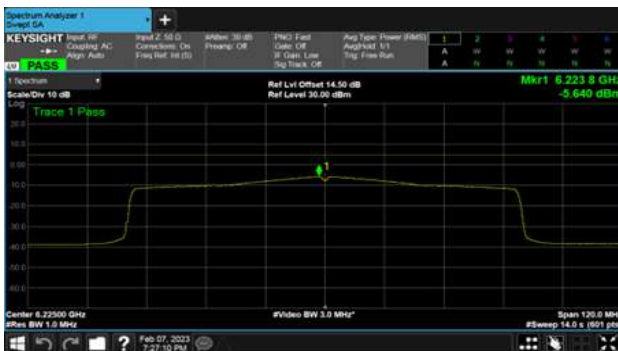

CH87





U-NII-6

BeamForming

ANT 3

Modulation Type: 802.11ax HE20 (7.3Mbps)

CH97

Modulation Type: 802.11ax HE40 (14.6Mbps)

CH99

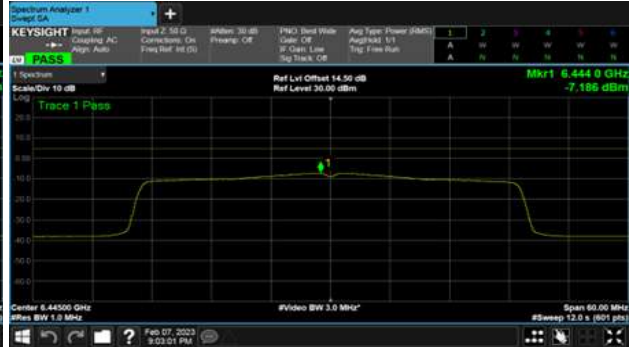
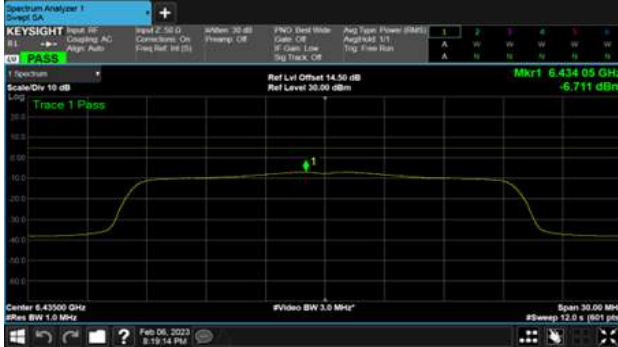

CH105

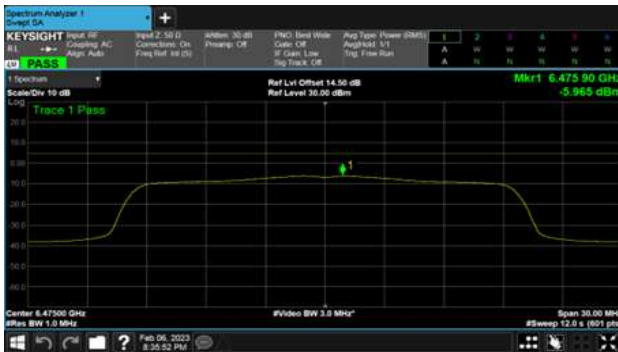

CH107

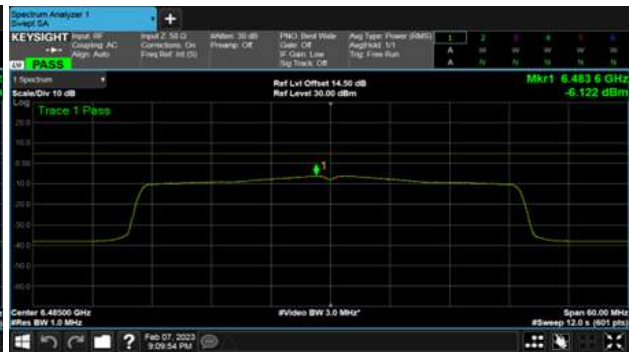

CH113

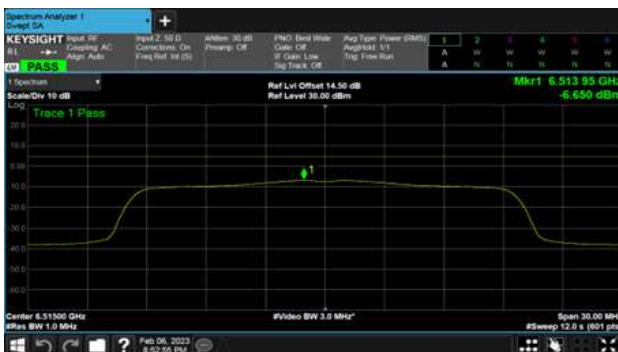



U-NII-6

BeamForming

ANT 3

Modulation Type: 802.11ax HE80 (30.6Mbps)

CH103

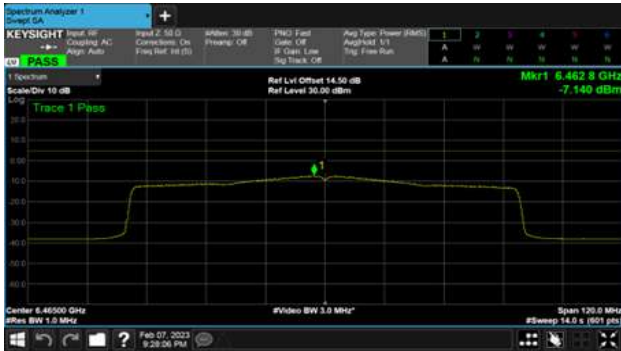



U-NII-6

BeamForming

ANT 4

Modulation Type: 802.11ax HE20 (7.3Mbps)

CH97

Modulation Type: 802.11ax HE40 (14.6Mbps)

CH99

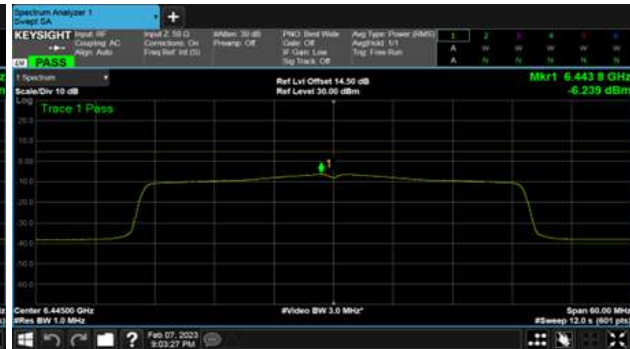
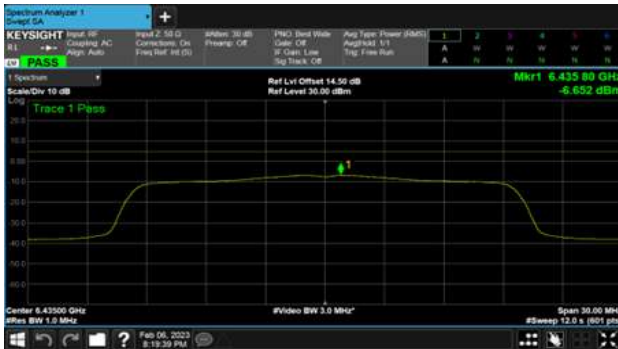

CH105

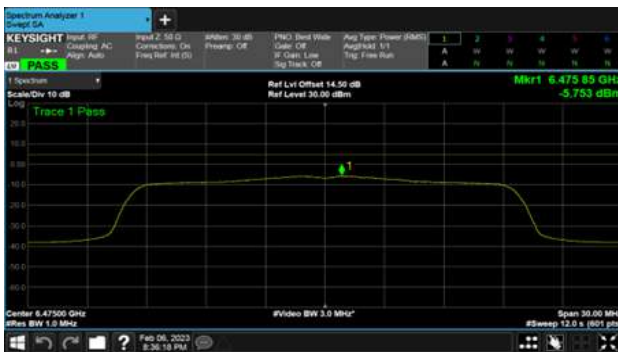

CH107

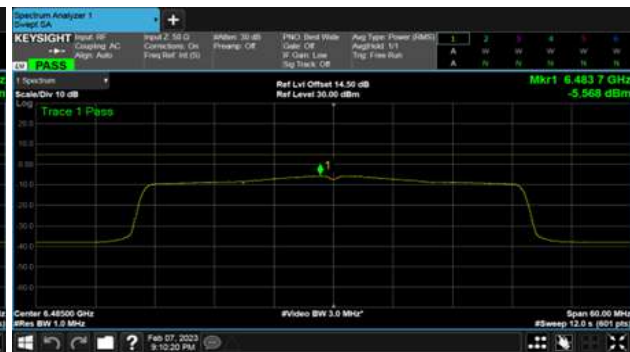

CH113





U-NII-6

BeamForming

ANT 4

Modulation Type: 802.11ax HE80 (30.6Mbps)

CH103

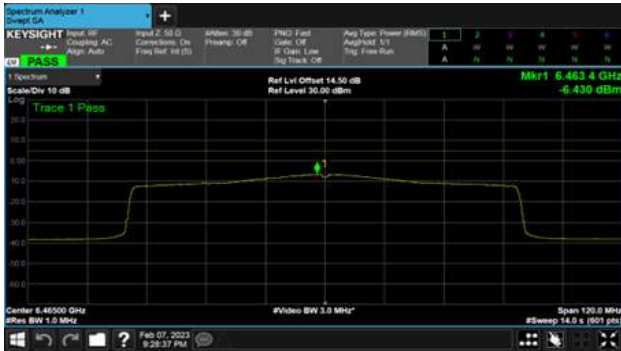



Within 6425-6525MHz band Straddle Channel
BeamForming
ANT 3
Modulation Type: 802.11ax HE40 (14.6Mbps)
CH115



Modulation Type: 802.11ax HE80 (30.6Mbps)
CH119



Modulation Type: 802.11ax HE160 (61.3Mbps)
CH111





Within 6425-6525MHz band Straddle Channel
BeamForming
ANT 4
Modulation Type: 802.11ax HE40 (14.6Mbps)
CH115



Modulation Type: 802.11ax HE80 (30.6Mbps)
CH119



Modulation Type: 802.11ax HE160 (61.3Mbps)
CH111





U-NII-7

BeamForming

ANT 3

Modulation Type: 802.11ax HE20 (7.3Mbps)

CH117

Modulation Type: 802.11ax HE40 (14.6Mbps)

CH123

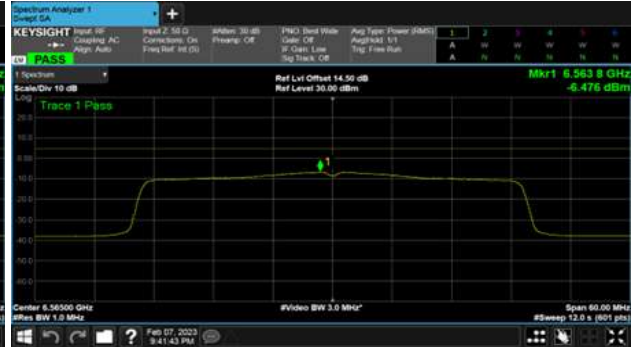
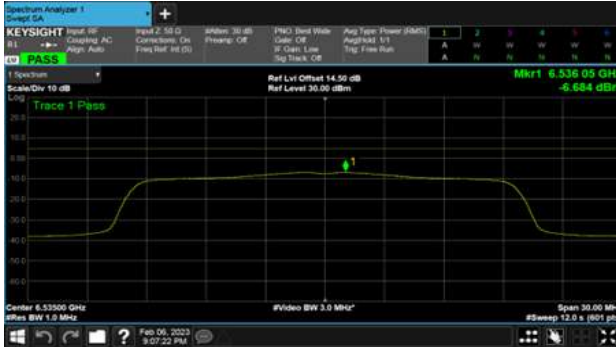

CH153

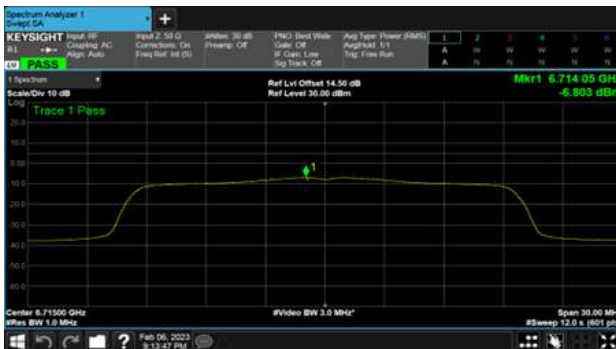

CH155



CH181

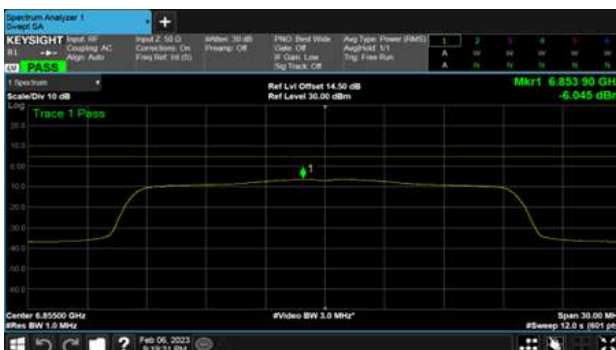

CH179

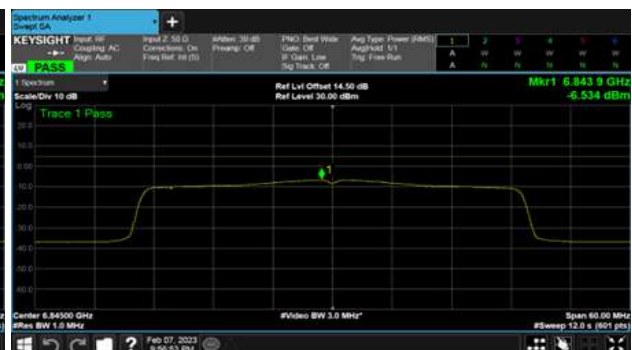



U-NII-7

BeamForming

ANT 3

Modulation Type: 802.11ax HE80 (30.6Mbps)
CH135

Modulation Type: 802.11ax HE160 (61.3Mbps)
CH143

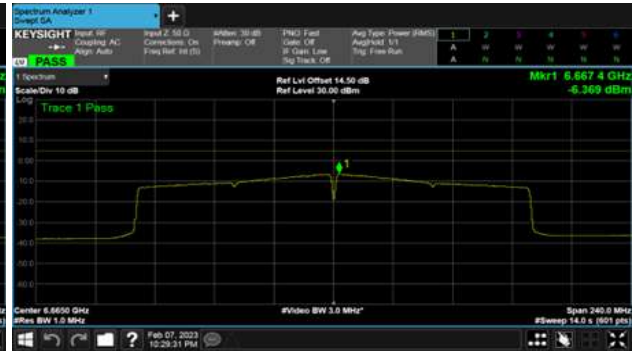
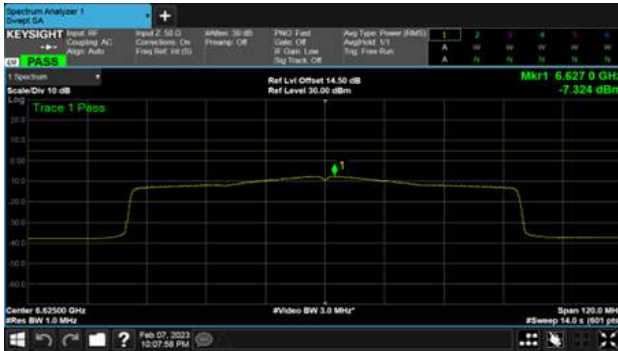

CH151



CH167

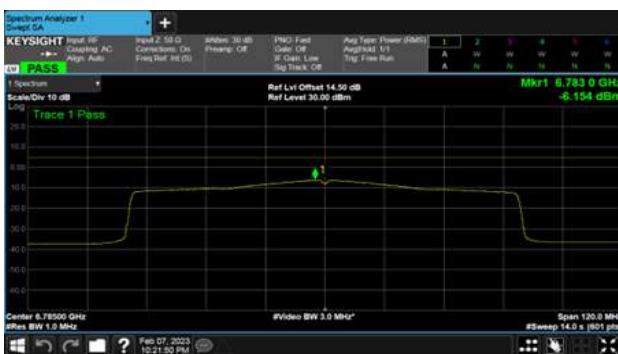



U-NII-7

BeamForming

ANT 4

Modulation Type: 802.11ax HE80 (30.6Mbps)
CH135

Modulation Type: 802.11ax HE160 (61.3Mbps)
CH143

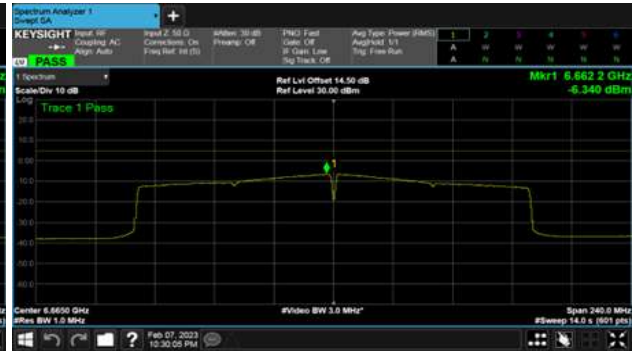
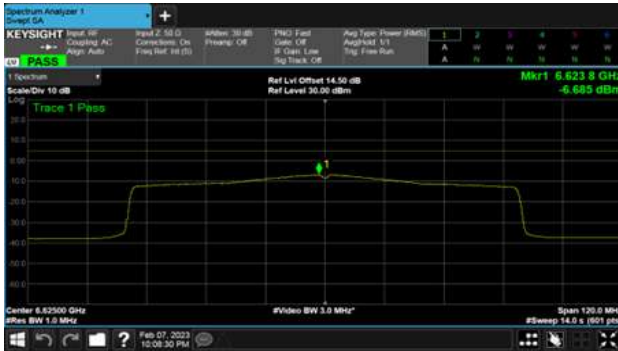

CH151

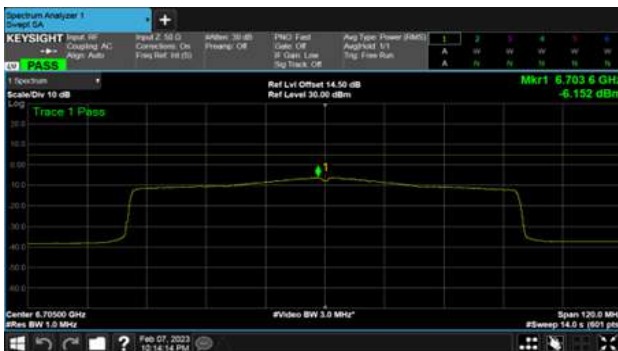

CH167

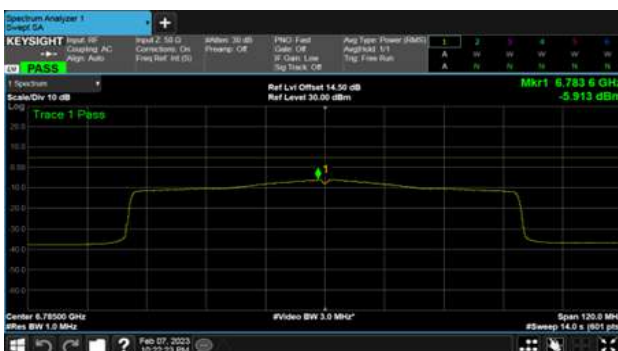



Extends across 6525MHz band

BeamForming

ANT 3

Modulation Type: 802.11ax HE40 (14.6Mbps)

CH115



Modulation Type: 802.11ax HE80 (30.6Mbps)

CH119



Modulation Type: 802.11ax HE160 (61.3Mbps)

CH111





Extends across 6525MHz band

BeamForming

ANT 4

Modulation Type: 802.11ax HE40 (14.6Mbps)

CH115

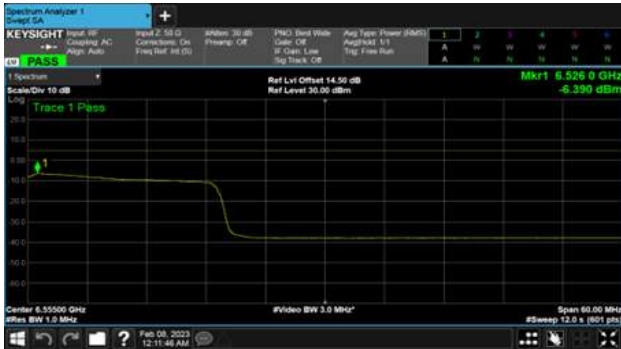

Modulation Type: 802.11ax HE80 (30.6Mbps)

CH119



Modulation Type: 802.11ax HE160 (61.3Mbps)

CH111





Within 6525-6875MHz band

BeamForming

ANT 3

Modulation Type: 802.11ax HE20 (7.3Mbps)
CH185

Modulation Type: 802.11ax HE160 (61.3Mbps)
CH175

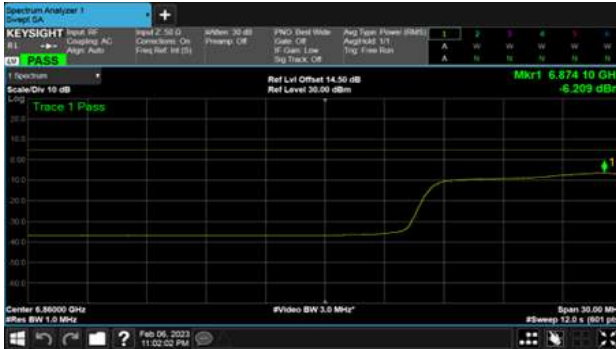

Modulation Type: 802.11ax HE40 (14.6Mbps)
CH187

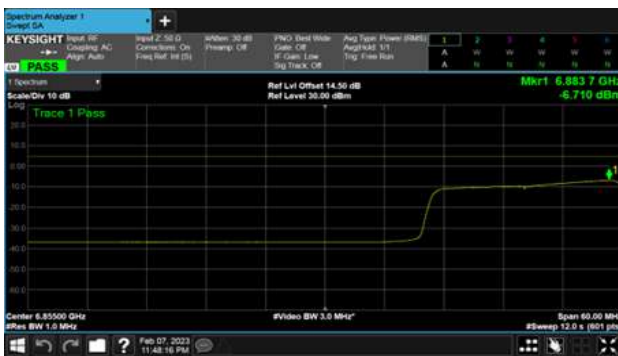

Modulation Type: 802.11ax HE80 (30.6Mbps)
CH183





Within 6525-6875MHz band

BeamForming

ANT 4

Modulation Type: 802.11ax HE20 (7.3Mbps)
CH185

Modulation Type: 802.11ax HE160 (61.3Mbps)
CH175

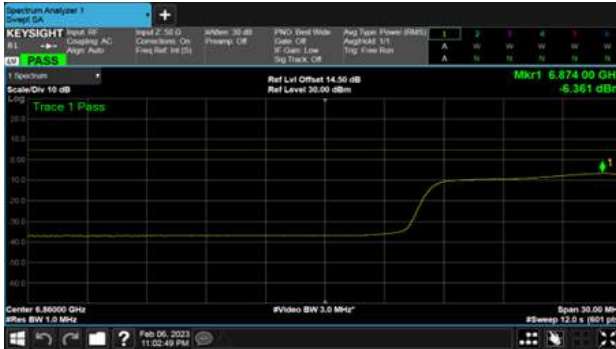

Modulation Type: 802.11ax HE40 (14.6Mbps)
CH187

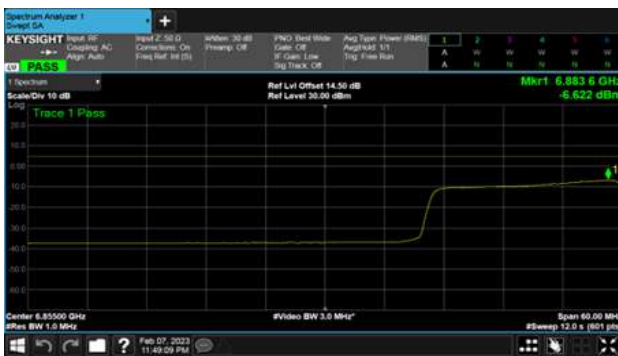

Modulation Type: 802.11ax HE80 (30.6Mbps)
CH183





U-NII-8

BeamForming

ANT 3

Modulation Type: 802.11ax HE20 (7.3Mbps)
CH189

Modulation Type: 802.11ax HE20 (7.3Mbps)
CH233

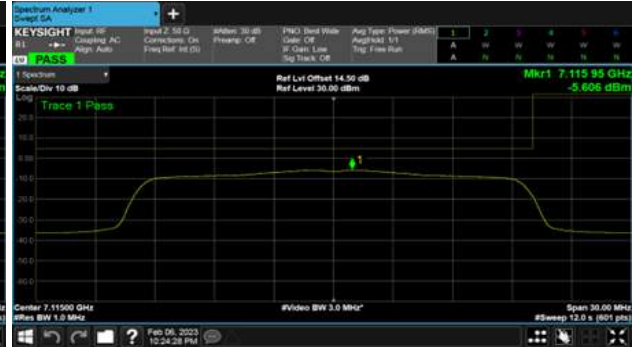
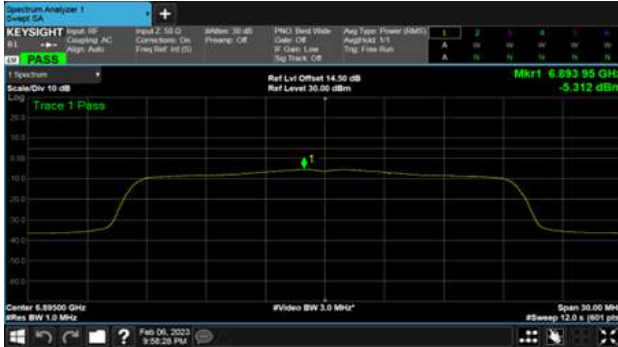

CH213

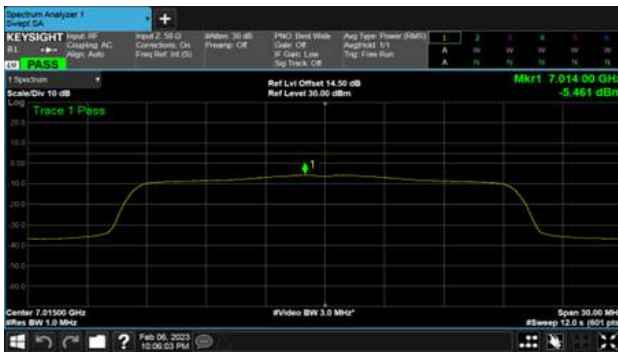

CH229

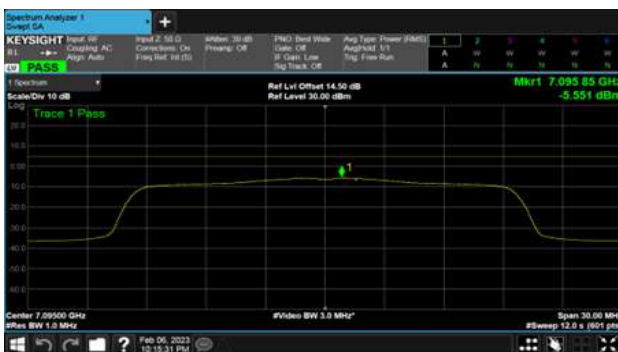



U-NII-8

BeamForming

ANT 3

Modulation Type: 802.11ax HE40 (14.6Mbps)
CH195

Modulation Type: 802.11ax HE80 (30.6Mbps)
CH199

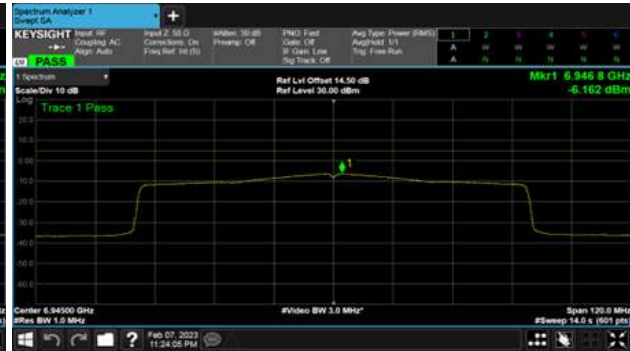
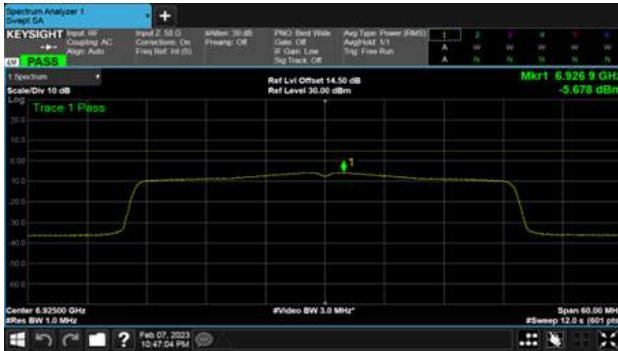

CH211



CH215

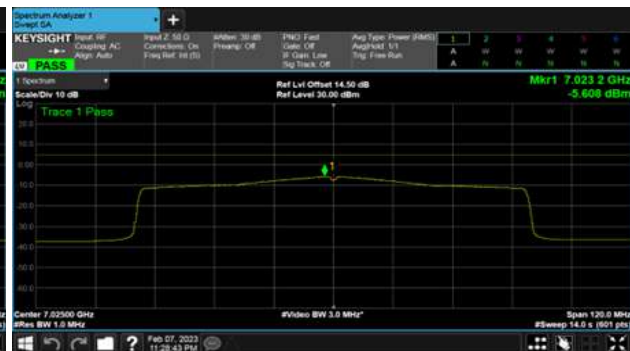

CH227

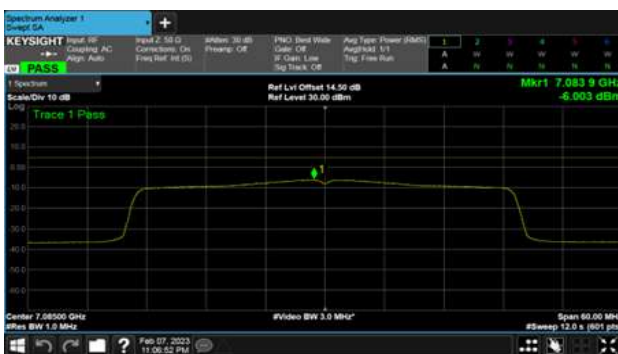



U-NII-8

BeamForming

ANT 3

Modulation Type: 802.11ax HE160 (61.3Mbps)

CH207

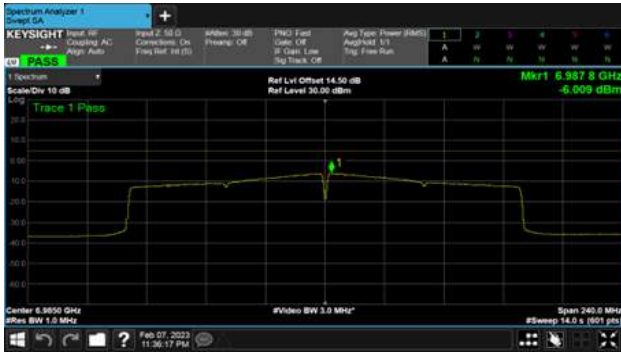



U-NII-8

BeamForming

ANT 4

Modulation Type: 802.11ax HE20 (7.3Mbps)

CH189

Modulation Type: 802.11ax HE20 (7.3Mbps)

CH233

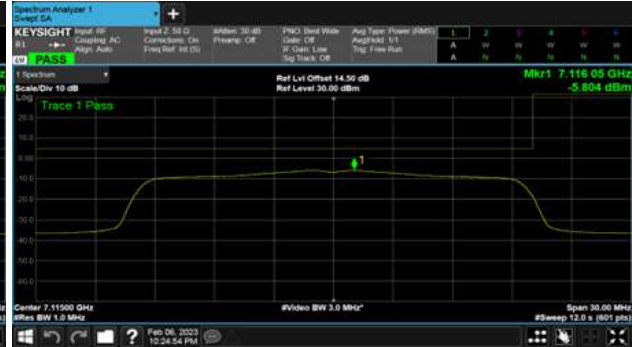
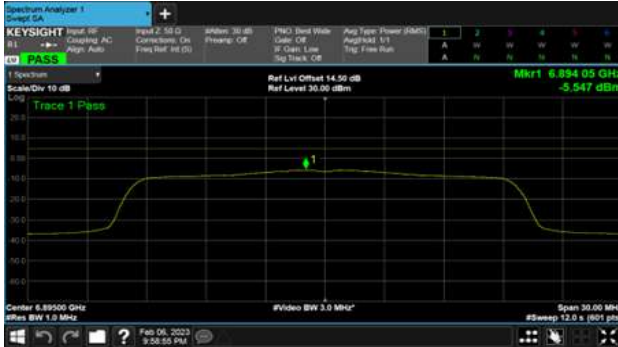

CH213



CH229





U-NII-8
BeamForming
ANT 4
Modulation Type: 802.11ax HE160 (61.3Mbps)
CH207

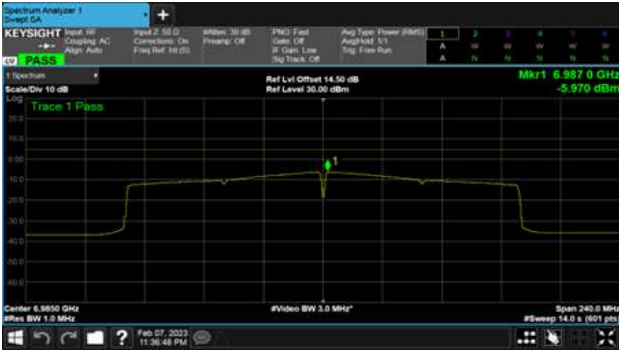



Extends across 6875MHz band

BeamForming

ANT 3

Modulation Type: 802.11ax HE20 (7.3Mbps)
CH185

Modulation Type: 802.11ax HE160 (61.3Mbps)
CH175

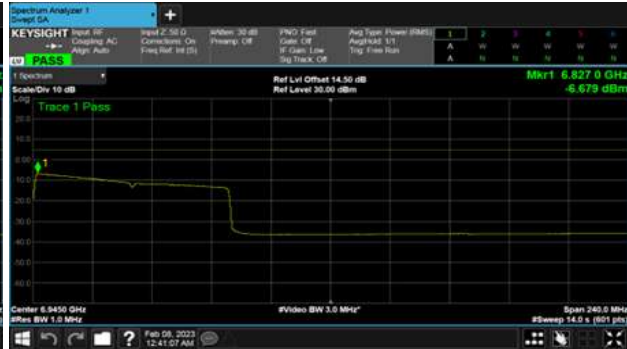
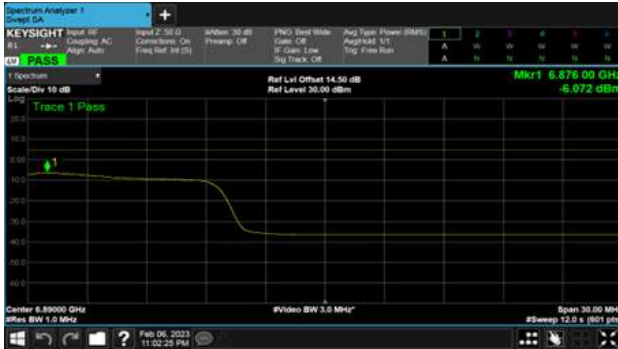

Modulation Type: 802.11ax HE40 (14.6Mbps)
CH187

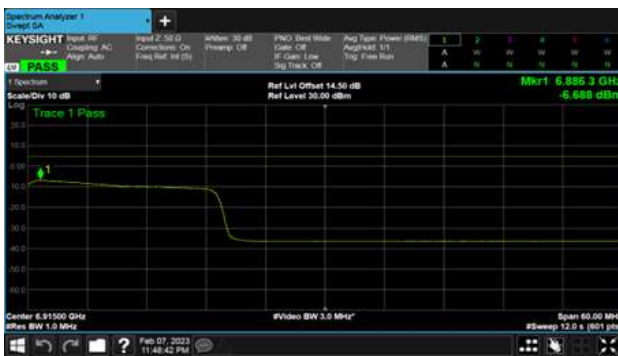

Modulation Type: 802.11ax HE80 (30.6Mbps)
CH183





Extends across 6875MHz band

BeamForming

ANT 4

Modulation Type: 802.11ax HE20 (7.3Mbps)
CH185

Modulation Type: 802.11ax HE160 (61.3Mbps)
CH175

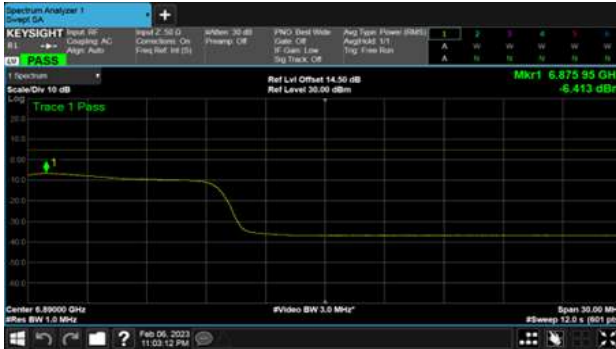

Modulation Type: 802.11ax HE40 (14.6Mbps)
CH187

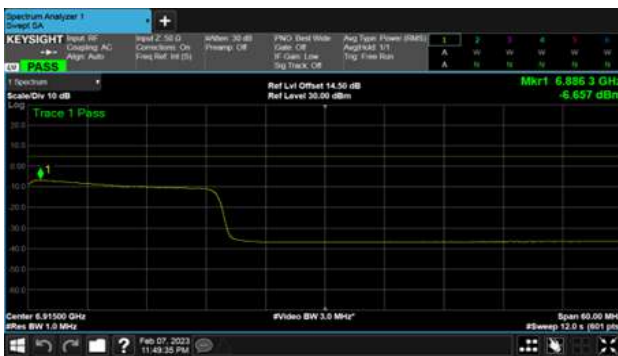

Modulation Type: 802.11ax HE80 (30.6Mbps)
CH183





11. Contention Based Protocoleak

11.1. Test Limit

EUT can detect an AWGN signal with 90% (or better) level of certainty.

11.2. Test Procedure

Reference to KDB 987594 D02 U-NII 6 GHz EMC Measurement v01

11.3. Test Setup Layout

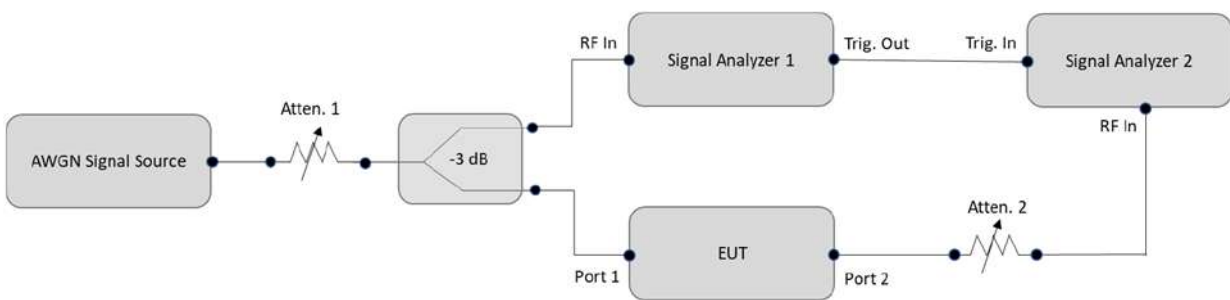



11.4. Test Result and Data

Device Type :		at the antenna connector			Threshold Level (dBm)
UNII Band	U-NII 5	Anttenna Gain :	4.5	dBi	-57.5
	U-NII 6	Anttenna Gain :	4.1	dBi	-57.9
	U-NII 7	Anttenna Gain :	4.5	dBi	-57.5
	U-NII 8	Anttenna Gain :	4.0	dBi	-58.0



Operation Band	Channel Bandwidth (MHz)	Channel Number	Channel Frequency (MHz)	AWGN Signal Frequency (MHz)	Measured Detection level (dBm)	EUT Status	Pass/Fail		
U-NII 5	20MHz	33	6115	6115	-75.09	Ceased	PASS		
					-76	Minimal			
					-77	Normal			
	160MHz	47	6185	6110	6110	-75.89	Ceased	PASS	
						-77	Minimal		
						-78	Normal		
				6185	6185	6185	-69.66	Ceased	PASS
							-70	Minimal	
							-71	Normal	
				6260	6260	6260	-77.72	Ceased	PASS
							-78	Minimal	
							-79	Normal	

Operation Band	Channel Bandwidth (MHz)	Channel Number	Channel Frequency (MHz)	AWGN Signal Frequency (MHz)	Measured Detection level (dBm)	EUT Status	Pass/Fail		
U-NII 6	20MHz	97	6435	6435	-79.6	Ceased	PASS		
					-80	Minimal			
					-81	Normal			
	160M	111	6505	6430	6430	-77.54	Ceased	PASS	
						-78	Minimal		
						-79	Normal		
				6505	6505	6505	-68.24	Ceased	PASS
							-69	Minimal	
							-70	Normal	
				6580	6580	6580	-77.75	Ceased	PASS
							-78	Minimal	
							-79	Normal	



Operation Band	Channel Bandwidth (MHz)	Channel Number	Channel Frequency (MHz)	AWGN Signal Frequency (MHz)	Measured Detection level (dBm)	EUT Status	Pass/Fail	
U-NII 7	20MHz	153	6715	6715	-71.35	Ceased	PASS	
					-72	Minimal		
					-73	Normal		
	160MHz	143	6665	6590	6590	-71.57	Ceased	PASS
						-72	Minimal	
						-73	Normal	
				6665	6665	-71.79	Ceased	PASS
						-72	Minimal	
						-73	Normal	
				6740	6740	-74.22	Ceased	PASS
						-75	Minimal	
						-76	Normal	

Lowest Interference (AWGN) Level Check

Operation Band	Channel Bandwidth (MHz)	Channel Number	Channel Frequency (MHz)	AWGN Signal Frequency (MHz)	Measured Detection level (dBm)	EUT Status	Pass/Fail	
U-NII 8	20MHz	213	7015	7015	-73.78	Ceased	PASS	
					-74	Minimal		
					-75	Normal		
	160MHz	207	6985	6910	6910	-73.02	Ceased	PASS
						-74	Minimal	
						-75	Normal	
				6985	6985	-70.28	Ceased	PASS
						-71	Minimal	
						-72	Normal	
				7060	7060	-76.73	Ceased	PASS
						-77	Minimal	
						-78	Normal	



Operation Band	Channel Bandwidth (MHz)	The Incumbent Signal (AWGN) Level (dBm)	Channel Number	Channel Frequency (MHz)	Test Result					
					AWGN Signal Frequency (MHz)	Measured Detection level (dBm)	Number of Times	Detection Rate	Limit	Pass/Fail
U-NII 5	20MHz	-75.09	33	6115	6115	-75.09	10	100.00%	90%	Pass
	160MHz	-75.89	47	6185	6110	-75.89	10	100.00%	90%	Pass
		-69.66			6185	-69.66	10	100.00%	90%	Pass
		-77.72			6260	-77.72	10	90.00%	90%	Pass

Operation Band	Channel Bandwidth (MHz)	The Incumbent Signal (AWGN) Level (dBm)	Channel Number	Channel Frequency (MHz)	Test Result					
					AWGN Signal Frequency (MHz)	Measured Detection level (dBm)	Number of Times	Detection Rate	Limit	Pass/Fail
U-NII 6	20MHz	-79.6	97	6435	6435	-79.6	10	100.00%	90%	Pass
	160MHz	-77.54	111	6505	6430	-77.54	10	100.00%	90%	Pass
		-68.24			6505	-68.24	10	90.00%	90%	Pass
		-77.75			6580	-77.75	10	90.00%	90%	Pass

Operation Band	Channel Bandwidth (MHz)	The Incumbent Signal (AWGN) Level (dBm)	Channel Number	Channel Frequency (MHz)	Test Result					
					AWGN Signal Frequency (MHz)	Measured Detection level (dBm)	Number of Times	Detection Rate	Limit	Pass/Fail
U-NII 7	20MHz	-71.35	153	6715	6715	-71.35	10	100.00%	90%	Pass
	160MHz	-71.57	143	6665	6590	-71.57	10	90.00%	90%	Pass
		-71.79			6665	-71.79	10	100.00%	90%	Pass
		-74.22			6740	-74.22	10	90.00%	90%	Pass

Operation Band	Channel Bandwidth (MHz)	The Incumbent Signal (AWGN) Level (dBm)	Channel Number	Channel Frequency (MHz)	Test Result					
					AWGN Signal Frequency (MHz)	Measured Detection level (dBm)	Number of Times	Detection Rate	Limit	Pass/Fail
U-NII 8	20MHz	-73.78	213	7015	7015	-73.78	10	100.00%	90%	Pass
	160MHz	-73.02	207	6985	6910	-73.02	10	100.00%	90%	Pass
		-70.28			6985	-70.28	10	90.00%	90%	Pass
		-76.73			7060	-76.73	10	90.00%	90%	Pass



Contention Based Protocol Threshold Level Verify Plot on U-NII 5

Frequency (MHz): :CH 33 6115 MHz (20M)

Frequency (MHz): :CH 33 6115 MHz (20M)

Measured Detection level

Test result is pass due to no transmission occur

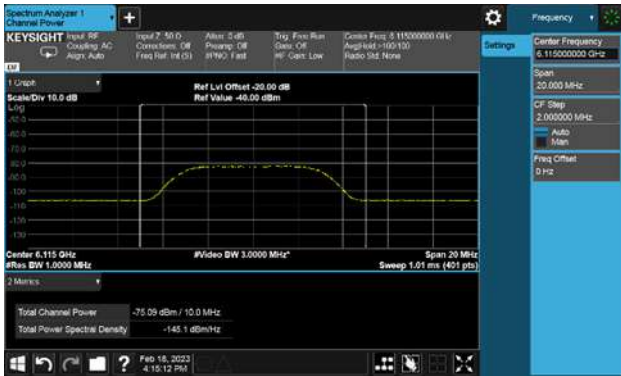

Frequency (MHz): CH 47 6110 MHz (160M)

Frequency (MHz): CH 47 6110 MHz (160M)

Measured Detection level

Test result is pass due to no transmission occur





Frequency (MHz): CH 47 6185 MHz (160M)

Measured Detection level



Frequency (MHz): CH 47 6185 MHz (160M)

Test result is pass due to no transmission occur



Frequency (MHz): CH 47 6260 MHz (160M)

Measured Detection level

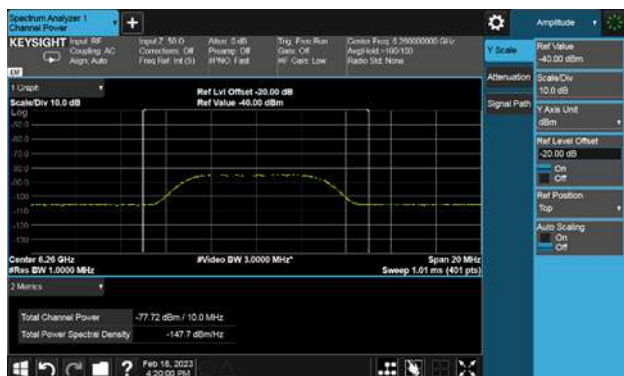

Frequency (MHz): CH 47 6260 MHz (160M)

Test result is pass due to no transmission occur





Contention Based Protocol Threshold Level Verify Plot on U-NII 6

Frequency (MHz): CH 97 6435 MHz (20M)

Frequency (MHz): CH 97 6435 MHz (20M)

Measured Detection level

Test result is pass due to no transmission occur



Frequency (MHz): CH 111 6430 MHz (160M)

Frequency (MHz): CH 111 6430 MHz (160M)

Measured Detection level

Test result is pass due to no transmission occur

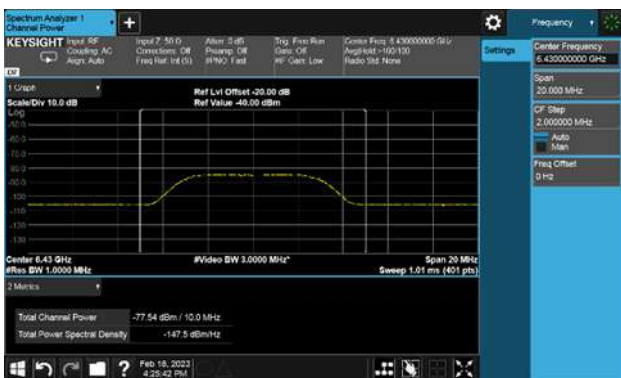



Frequency (MHz): CH 111 6505 MHz (160M)

Measured Detection level



requency (MHz): CH 111 6505 MHz (160M)

Test result is pass due to no transmission occur



Frequency (MHz): CH 111 6580 MHz (160M)

Measured Detection level



requency (MHz): CH 111 6580 MHz (160M)

Test result is pass due to no transmission occur





Contention Based Protocol Threshold Level Verify Plot on U-NII 7

Frequency (MHz): CH 153 6715 MHz (20M)

Frequency (MHz): CH 153 6715 MHz (20M)

Measured Detection level

Test result is pass due to no transmission occur

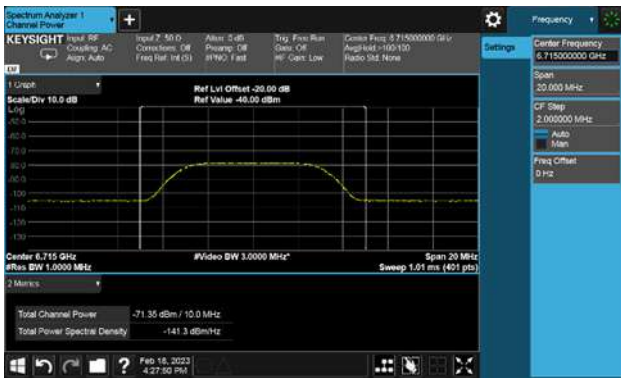

Frequency (MHz): CH 143 6590 MHz (160M)

Frequency (MHz): CH 143 6590 MHz (160M)

Measured Detection level

Test result is pass due to no transmission occur

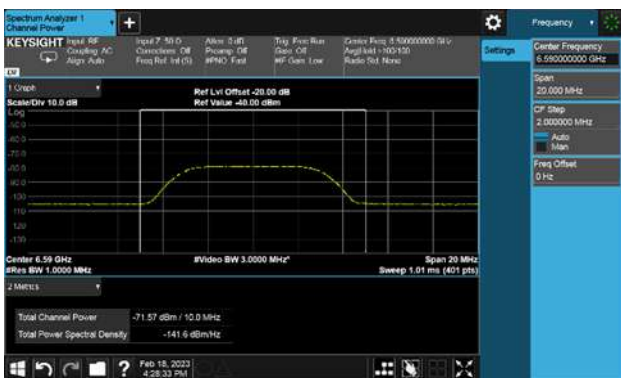



Frequency (MHz): CH 143 6665 MHz (160M)

Measured Detection level

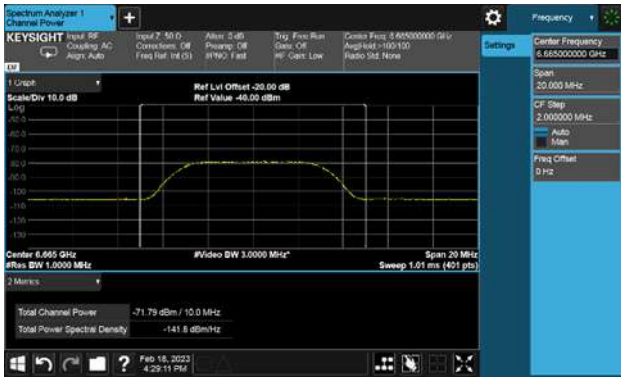

Frequency (MHz): CH 143 6665 MHz (160M)

Test result is pass due to no transmission occur



Frequency (MHz): CH 143 6740 MHz (160M)

Measured Detection level



Frequency (MHz): CH 143 6740 MHz (160M)

Test result is pass due to no transmission occur





Contention Based Protocol Threshold Level Verify Plot on U-NII 8

Frequency (MHz): CH 213 7015 MHz (20M)

Frequency (MHz): CH 213 7015MHz (20M)

Measured Detection level

Test result is pass due to no transmission occur



Frequency (MHz): CH 207 6910 MHz (160M)

Frequency (MHz): CH 207 6910MHz (160M)

Measured Detection level

Test result is pass due to no transmission occur

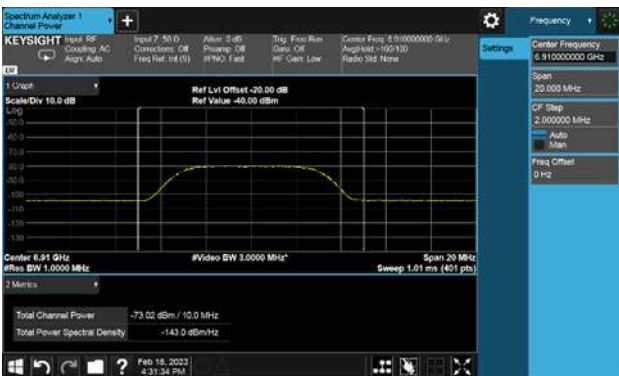



Frequency (MHz): CH 207 6985 MHz (160M)

Measured Detection level



Frequency (MHz): CH 207 6985MHz (160M)

Test result is pass due to no transmission occur



Frequency (MHz): CH 207 7060 MHz (160M)

Measured Detection level



Frequency (MHz): CH 207 7060MHz (160M)

Test result is pass due to no transmission occur





12. Indoor AP identification broadcast beacon

12.1. Statement of indoor AP identification broadcast beacon

This EUT operates as LPI AP, and the operation power will not exceed the regulatory limit. This EUT meets the requirement of "Indoor AP identification broadcast beacon". Please refer to the operation description for detailed information..