



FCC RADIO TEST REPORT

Applicant : LITE-ON Technology Corp.
Address : Bldg. C, 90, Chien 1 Rd., Chung-Ho, New Taipei City, 23585, Taiwan
Equipment : Indoor Wi-Fi 6 Access Point
Model No. : WPX8324-BT
Trade Name : LITEON
FCC ID : PPQ-WPX8324BT

I HEREBY CERTIFY THAT :

The sample was received on Oct 12, 2023 and the testing was completed on Oct. 13, 2023 at CerpPASS Technology Corp. The test result refers exclusively to the test presented test model / sample. Without written approval of CerpPASS Technology Corp., the test report shall not be reproduced except in full.

Approved by:

Mark Liao / Supervisor

Laboratory Accreditation:

CerpPASS Technology Corporation Test Laboratory





CONTENTS

- 1. Summary of Test Procedure and Test Results 5
 - 1.1. Applicable Standards5
- 2. Test Configuration of Equipment under Test 6
 - 2.1. Feature of Equipment under Test.....6
 - 2.2. Carrier Frequency of Channels 7
 - 2.3. Test Mode and Test Software8
 - 2.4. Description of Test System..... 10
 - 2.5. General Information of Test..... 12
 - 2.6. Measurement Uncertainty 13
- 3. Test Equipment and Ancillaries Used for Tests 14
- 4. Antenna Requirements 16
 - 4.1. Standard Applicable 16
 - 4.2. Antenna Construction and Directional Gain..... 16
- 5. Test of AC Power Line Conducted Emission 17
 - 5.1. Test Limit 17
 - 5.2. Test Procedures 17
 - 5.3. Typical Test Setup 18
 - 5.4. Test Result and Data..... 19
 - 5.5. Test Photographs 23
- 6. Test of Spurious Emission (Radiated)..... 24
 - 6.1. Test Limit 24
 - 6.2. Test Procedures 25
 - 6.3. Typical Test Setup 26
 - 6.4. Test Result and Data (9kHz ~ 30MHz)..... 27
 - 6.5. Test Result and Data (30MHz ~ 1GHz) 27
 - 6.6. Test Result and Data (1GHz ~ 40GHz)..... 31
 - 6.7. Restricted Bands of Operation 91
 - 6.8. Test Photographs (30MHz ~ 1GHz) 92
 - 6.9. Test Photographs (1GHz ~ 40GHz) 94
- 7. On Time, Duty Cycle and Measurement methods 97
 - 7.1. Test Limit 97
 - 7.2. Test Procedure 97
 - 7.3. Test Setup Layout 97
 - 7.4. Test Result and Data..... 97
 - 7.5. Measurement Methods 97
- 8. 6dB Bandwidth & 99% Occupied Bandwidth 101
 - 8.1. Test Limit 101
 - 8.2. Test Procedure 101
 - 8.3. Test Setup Layout 101
 - 8.4. Test Result and Data..... 102
- 9. 26dB Bandwidth & 99% Occupied Bandwidth 120
 - 9.1. Test Limit 120



- 9.2. Test Procedure 120
- 9.3. Test Setup Layout 120
- 9.4. Test Result and Data 121
- 10. Average Power 139
 - 10.1. Test Limit 139
 - 10.2. Test Procedure 140
 - 10.3. Test Setup Layout 140
 - 10.4. Test Result and Data 141
- 11. Power Spectral Density 144
 - 11.1. Test Limit 144
 - 11.2. Test Procedure 144
 - 11.3. Test Setup Layout 144
 - 11.4. Test Result and Data 145
- 12. Radio Frequency Exposure 163
 - 12.1. Applicable Standards 163
 - 12.2. EUT Specification 163
 - 12.3. Maximum Permissible Exposure 164



1. Summary of Test Procedure and Test Results

1.1. Applicable Standards

ANSI C63.10:2013

FCC Rules and Regulations Part 15 Subpart E §15.407

KDB 789033

FCC Rule	Description of Test	Result
15.203	Antenna Requirement	PASS
15.207(a)	AC Power Line Conducted Emission	PASS
15.407(b) 15.209	Radiated Spurious Emission	PASS
15.407(a)	26 dB & Occupied Bandwidth	PASS
15.407	6 dB Bandwidth	PASS
15.407 (a) & (a)(3)	Average Power	PASS
15.407(a)	Power Spectral Density	PASS
2.1091	Radio Frequency Exposure	PASS

*The lab has reduced the uncertainty risk factor from test equipment, environment and staff technicians which according to the standard on contract. Therefore, the test result will only be determined by standard requirement, measurement uncertainty evaluation is not considered.

The difference is list below:

1. WPX8324-BT is WRX8324(FCC ID:PPQ-WPX8324) Remove TPM & USB components, software disable Bluetooth & remove Bluetooth antenna.
2. Remove PoE optical coupling Component

After engineering evaluation, the following item need to Retest:

1. AC Power Line Conducted Emission
2. LF(Below 1GHz) Radiated Spurious Emission

Refer to original report for other test categories. Test report number: 22090062-TRFCC04



2. Test Configuration of Equipment under Test

2.1. Feature of Equipment under Test

Operation Frequency Range	802.11b/g/n(TurboQAM)/ax: 2400-2483.5MHz 802.11a/n/ac/ax: 5150-5250MHz, 5725-5850MHz
Center Frequency Range	802.11b/g/n(TurboQAM)/ax: 2412-2462MHz 802.11a/n/ac/ax: 5180-5240MHz, 5745-5825MHz
Modulation Type	2.4GHz: 802.11b: CCK, DQPSK, DBPSK 802.11g/n: BPSK, QPSK, 16QAM, 64QAM, 256QAM(TurboQAM) 802.11ax: BPSK, QPSK, 16QAM, 64QAM, 256QAM, 1024QAM 5GHz: 802.11n/a: BPSK, QPSK, 16QAM, 64QAM 802.11ac: BPSK, QPSK, 16QAM, 64QAM, 256QAM 802.11ax: BPSK, QPSK, 16QAM, 64QAM, 256QAM,1024QAM
Modulation Technology	DSSS, OFDM, OFDMA
Data Rate	2.4GHz: 802.11b: 1, 2, 5.5, 11Mbps 802.11g: 6, 9, 12, 18, 24, 36, 48, 54Mbps 802.11n: MCS0 – MCS15, HT20/40 MCS0 – MCS9, VHT20/40(TurboQAM) 802.11ax: MCS0 – MCS11,HE20/40 5GHz: 802.11a: 6, 9, 12, 18, 24, 36, 48, 54Mbps 802.11n: MCS0 – MCS15, HT20/40 802.11ac: MCS0 – MCS9, VHT20/40/80 802.11ax: MCS0 – MCS11, HE20/40/80
Antenna Type	PIFA Antenna
Antenna Gain	2400-2500MHz: ANT 1: 3.96dBi, ANT 2: 3.52dBi 5150-5250MHz: ANT 1: 4.76dBi, ANT 2: 4.37dBi 5725-5850MHz: ANT 1: 4.73dBi, ANT 2: 3.72dBi

Note:

1. WLAN 2.4G 802.11n Support TurboQAM.
2. EUT support TPC Function.
3. EUT support AP Master Mode.
4. 802.11ax support beamforming Function.
5. EUT Indoor access point
6. For more details, please refer to the User's manual of the EUT.

The differences between all model numbers as follow:

Model No.	Difference
WPX8324-BT	with PoE & Without PoE

Note: After engineering evaluation, Without PoE for worst case and for presentation of report data



2.2. Carrier Frequency of Channels

Band: 5150MHz-5250MHz

802.11a, 802.11n HT20, 802.11ac VHT20, 802.11ax HE20

Channel	Frequency(MHz)	Channel	Frequency(MHz)
*36	5180	44	5220
*40	5200	*48	5240

802.11n HT40, 802.11ac VHT40, 802.11ax HE40

Channel	Frequency(MHz)	Channel	Frequency(MHz)
*38	5190	*46	5230

802.11ac VHT80 , 802.11ax HE80

Channel	Frequency(MHz)
*42	5210

Band: 5725MHz-5850MHz

802.11a, 802.11n HT20, 802.11ac VHT20, 802.11ax HE20

Channel	Frequency(MHz)	Channel	Frequency(MHz)
*149	5745	161	5805
153	5765	*165	5825
*157	5785		

802.11n HT40, 802.11ac VHT40, 802.11ax HE40

Channel	Frequency(MHz)	Channel	Frequency(MHz)
*151	5755	*159	5795

802.11ac VHT80, 802.11ax HE80

Channel	Frequency(MHz)
*155	5775

Note: Channels remarked * are selected to perform test.



2.3. Test Mode and Test Software

- a. During testing, the interface cables and equipment positions were varied according to ANSI C63.10.
- b. The complete test system included remote workstation and EUT for RF test. The remote workstation included Notebook.
- c. An executive program, " QSPR V 5.0-00198" under Windows OS system was executed to transmit and receive data via WLAN. (Non BeamForming)
- d. An executive program, " wl command" under Windows OS system was executed to transmit and receive data via WLAN. (BeamForming)
- e. The following test modes were performed for the test:

For 22090062-TRFCC04

Radiation Emissions (1GHz ~ 40GHz)	
Test Mode	Operating Description
1	802.11a (6Mbps) ,Power from Adapter ,Non BeamForming
2	802.11ax HE20 (7.3Mbps) ,Power from Adapter ,Non BeamForming
3	802.11ax HE40 (14.6Mbps) ,Power from Adapter ,Non BeamForming
4	802.11ax HE80 (30.6Mbps) ,Power from Adapter ,Non BeamForming
5	802.11ax HE20 (7.3Mbps) ,Power from Adapter, BeamForming
6	802.11ax HE40 (14.6Mbps) ,Power from Adapter, BeamForming
7	802.11ax HE80 (30.6Mbps) ,Power from Adapter, BeamForming

caused "Test Mode 1~7" generated the worst case, they were reported as the final data.

Note:For Radiated Spurious Emission(1GHz ~ 40GHz),AC 120V / 60Hz is worst case.

For retest data

Conducted Emissions from the AC mains power ports	
Test Mode	Operating Description
1	802.11a (6Mbps) ,Power from Adapter ,Non BeamForming
2	802.11ax HE20 (7.3Mbps) ,Power from Adapter ,Non BeamForming
3	802.11ax HE40 (14.6Mbps) ,Power from Adapter ,Non BeamForming
4	802.11ax HE80 (30.6Mbps) ,Power from Adapter ,Non BeamForming
5	802.11ax HE20 (7.3Mbps) ,Power from Adapter, BeamForming
6	802.11ax HE40 (14.6Mbps) ,Power from Adapter, BeamForming
7	802.11ax HE80 (30.6Mbps) ,Power from Adapter, BeamForming

caused "Test Mode 3,6" generated the worst case, it was reported as the final data.

Radiation Emissions (BELOW 1GHz)	
Test Mode	Operating Description
1	802.11a (6Mbps) ,Power from Adapter ,Non BeamForming
2	802.11ax HE20 (7.3Mbps) ,Power from Adapter ,Non BeamForming
3	802.11ax HE40 (14.6Mbps) ,Power from Adapter ,Non BeamForming
4	802.11ax HE80 (30.6Mbps) ,Power from Adapter ,Non BeamForming
5	802.11ax HE20 (7.3Mbps) ,Power from Adapter, BeamForming
6	802.11ax HE40 (14.6Mbps) ,Power from Adapter, BeamForming
7	802.11ax HE80 (30.6Mbps) ,Power from Adapter, BeamForming

caused "Test Mode 3,6" generated the worst case, it was reported as the final data.

Note:1. There are two kinds of test voltage: AC 120V / 60Hz and AC 240V / 60Hz.

For AC Power Line Conducted Emission, & Radiation Emissions (BELOW 1GHz)
AC 240V / 60Hz is worst case.



The EUT incorporates a MIMO function

Modulation Type	TX CONFIGURATION
802.11a	2TX
802.11n HT20	2TX
802.11n HT40	2TX
802.11ac VHT20	2TX
802.11ac VHT40	2TX
802.11ac VHT80	2TX
802.11ax HE20	2TX
802.11ax HE40	2TX
802.11ax HE80	2TX



2.4. Description of Test System

For 22090062-TRFCC04

Non BeamForming

RF Conducted				
Equipment	Brand	Model	Length/Type	Power cord/Length/Type
Notebook	DELL	P23T001	N/A	Adapter / 1.8m / NS
RJ45 Cable * 2	TE CONNECTIVITY	CAT5E	1.2m / NS	N/A
POE	CERIO	S53VG	N/A	N/A
Radiated Emissions				
Equipment	Brand	Model	Length/Type	Power cord/Length/Type
Adaptor	APD	WB-18D12R	1.8m / NS	N/A
Notebook	ASUS	P2430U	N/A	Adapter / 1.8m / NS
RJ45 Cable	N/A	N/A	15m / NS	N/A
POE	CERIO	S53VG	N/A	N/A

BeamForming

RF Conducted				
Equipment	Brand	Model	Length/Type	Power cord/Length/Type
Notebook	Lenovo	S1GL2W	N/A	Adapter / 1.8m / NS
Notebook	Lenovo	S1GL2W	N/A	Adapter / 1.8m / NS
RJ45 Cable * 3	TE CONNECTIVITY	CAT5E	1.2m / NS	N/A
POE	CERIO	S53VG	N/A	N/A
Adapter	APD	WB-18D12R	N/A	N/A
Radiated Emissions				
Equipment	Brand	Model	Length/Type	Power cord/Length/Type
Adapter	APD	WB-18D12R	1.8m / NS	N/A
Notebook	ASUS	P2430U	N/A	Adapter / 1.8m / NS
RJ45 Cable	N/A	N/A	15m / NS	N/A
POE	CERIO	S53VG	N/A	N/A
Notebook	Lenovo	S1GL2W	N/A	Adapter / 1.8m / NS
RJ45 Cable*2	TE CONNECTIVITY	CAT5E	1.2m / NS	N/A



For Retest data
Non BeamForming

Radiated Emissions				
Equipment	Brand	Model	Length/Type	Power cord/Length/Type
Notebook	ASUS	P2430U	N/A	Adapter / 1.8m / NS
Power Cord	Powersync	TPCMRN0006	1.2m / NS	N/A
RJ45 Cable	TE CONNECTIVITY	CAT5E	1.2m / NS	N/A
RJ45 Cable	TE CONNECTIVITY	CAT5E	15m / NS	N/A
POE	Cambium Networks	NET-P60-56IN	N/A	N/A
Adapter	Asian Power Devicers Inc.	WB-18D12R	1.8m / NS	N/A
AC Power Line Conducted Emission				
Equipment	Brand	Model	Length/Type	Power cord/Length/Type
Notebook	ASUS	P2430U	N/A	Adapter / 1.8m / NS
RJ45 Cable*2	TE CONNECTIVITY	CAT5E	1.2m / NS	N/A
Power Cord	Powersync	TPCMRN0006	1.2m / NS	N/A
POE	Cambium Networks	NET-P60-56IN	N/A	N/A
Adapter	Asian Power Devicers Inc.	WB-18D12R	1.8m / NS	N/A

BeamForming

Radiated Emissions				
Equipment	Brand	Model	Length/Type	Power cord/Length/Type
Notebook	ASUS	P2430U	N/A	Adapter / 1.8m / NS
Notebook	DELL	Latitude E5470	N/A	Adapter / 1.8m / NS
RJ45 Cable	TE CONNECTIVITY	CAT5E	1.2m / NS	N/A
Power Cord	Powersync	TPCMRN0006	1.2m / NS	N/A
RJ45 Cable	TE CONNECTIVITY	CAT5E	15m / NS	N/A
POE	Cambium Networks	NET-P60-56IN	N/A	N/A
Adapter	Asian Power Devicers Inc.	WB-18D12R	1.8m / NS	N/A
AC Power Line Conducted Emission				
Equipment	Brand	Model	Length/Type	Power cord/Length/Type
Notebook	ASUS	P2430U	N/A	Adapter / 1.8m / NS
RJ45 Cable*3	TE CONNECTIVITY	CAT5E	1.2m / NS	N/A
Notebook	DELL	Latitude E5470	N/A	Adapter / 1.8m / NS
Power Cord	Powersync	TPCMRN0006	1.2m / NS	N/A
POE	Cambium Networks	NET-P60-56IN	N/A	N/A
Adapter	Asian Power Devicers Inc.	WB-18D12R	1.8m / NS	N/A

**2.5. General Information of Test**

Test Site	Cerpass Technology Corporation Test Laboratory Address: No.10, Ln. 2, Lianfu St., Luzhu Dist., Taoyuan City 33848, Taiwan (R.O.C.) Tel:+886-3-3226-888 Fax:+886-3-3226-881	
	FCC	TW1439, TW1079
	IC	4934E-1, 4934E-2
	VCCI	T-2205 for Telecommunication test C-4663 for Conducted emission test R-4218 for Radiated emission test G-10812, G-10813 for radiated disturbance above 1GHz
Frequency Range Investigated:	Conducted: from 150kHz to 30 MHz Radiation: from 30 MHz to 40,000MHz	
Test Distance:	The test distance of radiated emission from antenna to EUT is 3 M.	

For 22090062-TRFCC04
Non BeamForming

Test Item	Test Site	Test period	Environmental Conditions	Tested By
RF Conducted	RFCON01-NK	2022/10/13~2022/10/24	24~27.1°C / 42~59%	Dian Chen
Radiated Emissions	3M02-NK	2022/10/13~2022/10/14	24°C / 39~43%	Leon Huang

BeamForming

Test Item	Test Site	Test period	Environmental Conditions	Tested By
RF Conducted	RFCON01-NK	2022/10/17~2022/11/9	24~26.3°C / 49~62%	Dian Chen
Radiated Emissions	3M02-NK	2022/10/19~2022/10/28	20~24°C / 35~48%	Leon Huang

For Retest data

Test Item	Test Site	Test period	Environmental Conditions	Tested By
Radiated Emissions	3M02-NK	2023/10/13	22°C / 44%	Leon Haung
AC Power Line Conducted Emission	CON02-NK	2023/10/13	24°C / 59%	Leon Haung



2.6. Measurement Uncertainty

ISO/IEC 17025 requires that an estimate of the measurement uncertainties associated with the emissions test results be included in the report. The measurement uncertainties given below are based on a 95% confidence level (based on a coverage factor (k=2))

For 22090062-TRFCC04

Measurement Item	Uncertainty
Radiated Spurious Emission(1GHz~40GHz)	±6.8dB
6dB Bandwidth	±4.4%
26dB Bandwidth	±4.4%
Occupied Bandwidth	±4.4%
Peak Output Power(Conducted Power Meter)	±1.1dB
Power Spectral Density	±1.8dB
Duty Cycle	±1.2%
Frequency Stability	±0.21KHz

For Retest data

Measurement Item	Uncertainty
AC Power Line Conduction(150K~30MHz)	±3.28dB
Radiated Spurious Emission(9KHz~30MHz)	±3.5dB
Radiated Spurious Emission(30MHz~1GHz)	±5.1dB



3. Test Equipment and Ancillaries Used for Tests

For 22090062-TRFCC04

Test Item	Radiated Emissions				
Test Site	Semi Anechoic Room(3M02-NK)				
Instrument	Manufacturer	Model No	Serial No	Calibration Date	Valid Date
Bilog Antenna	Schwarzbeck	VULB9168	275	2021/11/05	2022/11/04
Active Loop Antenna	EMCO	6507	40855	2022/05/25	2023/05/24
Horn Antenna	EMCO	3115	31589	2022/04/26	2023/04/25
Horn Antenna	EMCO	3116	31970	2022/03/18	2023/03/17
Double Ridged Guide Horn Antenna	RF SPAN	DRH18-E	210309A18-ES	2022/08/24	2023/08/23
EMI Receiver	ROHDE & SCHWARZ	ESCI	101423	2022/07/05	2023/07/04
Spectrum Analyzer	ROHDE & SCHWARZ	FSV 40-N	101329	2022/07/20	2023/07/19
Preamplifier	Agilent	8449B	3008A01954	2022/03/17	2023/03/16
Preamplifier	EMC INSTRUMENTS	EMC184045	980065	2021/11/16	2022/11/15
Preamplifier	EM Electronics corp.	EM330	60660	2022/04/08	2023/04/07
Cable-6m(9k~300M)	NA	EMC5D-BM-BM-6	130605	2022/09/06	2023/09/05
Cable-3in1(30M-1G)	HARBOUR INDUSTRIES	LL142	CCE1315	2022/03/21	2023/03/20
Cable-0.5m(30M-40G)	HUBER SUHNER	SUCOFLEX 102	28420/2	2022/4/9	2023/4/8
Cable-3m(30M-40G)	HUBER SUHNER	SUCOFLEX 102	MY2608/2	2022/4/9	2023/4/8
Cable-0.5m(1G-40G)	Rapidtek	40GHZ 50CM	38MS-38MS50314	2022/4/9	2023/4/8
Cable-3m(1G-40G)	Rapidtek	40GHZ 300CM	38MS-38MS300314	2022/4/9	2023/4/8
Cable-0.5m(1G-40G)	HUBER SUHNER	SUCOFLEX 104	805443/4	2022/01/11	2023/01/10
Cable-3m(1G-40G)	HUBER SUHNER	SUCOFLEX 104	805796/4	2022/01/11	2023/01/10
Cable-8m(1G-26.5G)	WOKEN	WCBA-WCA203S M	CCE1374	2022/04/25	2023/04/24
E3	AUDIX	v8.2014-8-6	RK-000529	NA	NA

Test Item	RF Conducted				
Test Site	RFCON01-NK				
Instrument	Manufacturer	Model No	Serial No	Calibration Date	Valid Date
CAX Signal Analyzer	KEYSIGHT	N9000B	MY57100339	2022/01/10	2023/01/09
Power Meter	Anritsu	ML2495A	1224005	2022/04/12	2023/04/11
Power Sensor	Anritsu	MA2411B	1207295	2022/04/12	2023/04/11
Attenuator	KEYSIGHT	8491B	MY39250703	2022/04/12	2023/04/11



For Retest data

Test Item	Radiated Emissions				
Test Site	Semi Anechoic Room(3M02-NK)				
Instrument	Manufacturer	Model No	Serial No	Calibration Date	Valid Date
Bilog Antenna	Schwarzbeck	VULB9168	275	2022/11/18	2023/11/17
Active Loop Antenna	Schwarzbeck	FMZB 1513	414	2023/02/03	2024/02/02
Horn Antenna	EMCO	3115	31589	2023/03/23	2024/03/22
Horn Antenna	EMCO	3116	31970	2023/03/03	2024/03/02
EMI Receiver	ROHDE & SCHWARZ	ESCI	101423	2023/07/05	2024/07/04
Spectrum Analyzer	ROHDE & SCHWARZ	FSP 40	100047	2023/02/24	2024/02/23
Preamplifier	Agilent	8449B	3008A01954	2023/03/08	2024/03/07
Preamplifier	EMC INSTRUMENTS	EMC184045	980065	2022/11/11	2023/11/10
Preamplifier	EM Electronics corp.	EM330	60659	2023/03/10	2024/03/09
Cable-6m(9k~300M)	NA	EMC5D-BM-BM-6	130606	2023/03/13	2024/03/12
Cable-3in1(30M-1G)	HARBOUR INDUSTRIES	LL142	CCE1315	2023/02/25	2024/02/24
Cable-0.5m(1G-40G)	HUBER SUHNER	SUCOFLEX 104	805443/4	2023/03/07	2024/03/06
Cable-3m(1G-40G)	HUBER SUHNER	SUCOFLEX 104	805796/4	2023/03/07	2024/03/06
Cable-8m(1G-26.5G)	WOKEN	WCBA-WCA203S M	CCE1374	2023/03/07	2024/03/06
Cable-1m(1G-40G)	HUBER SUHNER	HUBER SUHNER / SF102	552450	2023/06/08	2024/06/07
Cable-3m(1G-40G)	HUBER SUHNER	HUBER SUHNER / SF102	552451	2023/06/08	2024/06/07
E3	AUDIX	v8.2014-8-6	RK-000529	NA	NA

Test Item	AC Power Line Conducted Emission				
Test Site	CON02-NK				
Instrument	Manufacturer	Model No	Serial No	Calibration Date	Valid Date
EMI Receiver	ROHDE & SCHWARZ	ESCI	101423	2023/07/05	2024/07/04
TWO-LINE V-NETWORK	ROHDE & SCHWARZ	ENV216	102185	2023/08/29	2024/08/28
Cable-4m(9k-3G)	EMEC	RG-223	18274M	2023/07/31	2024/07/30
E3	AUDIX	v8.2014-8-6	RK-000531	NA	NA



4. Antenna Requirements

4.1. Standard Applicable

For intentional device, according to FCC 47 CFR Section 15.203, an intentional radiator shall be designed to ensure that no antenna other than that furnished by the responsible party shall be used with the device.

And according to FCC 47 CFR Section 15.407 (a), if transmitting antennas of directional gain greater than 6dBi are used, the power shall be reduced by the amount in dB that the directional gain of the antenna exceeds 6dBi.

4.2. Antenna Construction and Directional Gain

Antenna Type	PIFA Antenna
Antenna Gain	5150-5250MHz: ANT 1: 4.76dBi, ANT 2: 4.37dBi 5725-5850MHz: ANT 1: 4.73dBi, ANT 2: 3.72dBi

(Non-Beamforming)

5150MHz -5250MHz
For Power directional gain= $G_{ant} = 4.76$ (dBi)
For PSD directional gain = $10 \log[(10^{G^1/20} + 10^{G^2/20} + \dots + 10^{G^N/20})^2 / N_{ANT}] = 7.58$ (dBi)
5725MHz -5850MHz
For Power directional gain= $G_{ant} = 4.73$ (dBi)
For PSD directional gain = $10 \log[(10^{G^1/20} + 10^{G^2/20} + \dots + 10^{G^N/20})^2 / N_{ANT}] = 7.25$ (dBi)

*MIMO type: Cyclic Delay Diversity (CDD) mode.

(Beamforming)

5150MHz -5250MHz
For Power directional gain= $10 \log[(10^{G^1/20} + 10^{G^2/20} + \dots + 10^{G^N/20})^2 / N_{ANT}] = 7.58$ (dBi)
For PSD directional gain = $10 \log[(10^{G^1/20} + 10^{G^2/20} + \dots + 10^{G^N/20})^2 / N_{ANT}] = 7.58$ (dBi)
5725MHz -5850MHz
For Power directional gain= $10 \log[(10^{G^1/20} + 10^{G^2/20} + \dots + 10^{G^N/20})^2 / N_{ANT}] = 7.25$ (dBi)
For PSD directional gain = $10 \log[(10^{G^1/20} + 10^{G^2/20} + \dots + 10^{G^N/20})^2 / N_{ANT}] = 7.25$ (dBi)



5. Test of AC Power Line Conducted Emission

5.1. Test Limit

Conducted Emissions were measured from 150 kHz to 30 MHz with a bandwidth of 9 KHz, according to the methods defined in ANSI C63.10-2013. The EUT was placed on a nonmetallic stand in a shielded room 0.8 meters above the ground plane. The interface cables and equipment positioning were varied within limits of reasonable applications to determine the position produced maximum conducted emissions.

Frequency (MHz)	Quasi Peak (dB μ V)	Average (dB μ V)
0.15 – 0.5	66-56*	56-46*
0.5 – 5.0	56	46
5.0 – 30.0	60	50

*Decreases with the logarithm of the frequency.

5.2. Test Procedures

- The EUT was placed 0.4 meter from the conducting wall of the shielding room was kept at least 80 centimeters from any other grounded conducting surface.
- Connect EUT to the power mains through a line impedance stabilization network (LISN).
- All the support units are connecting to the other LISN.
- The LISN provides 50 ohm coupling impedance for the measuring instrument.
- The FCC states that a 50 ohm, 50 micro-Henry LISN should be used.
- Both sides of AC line were checked for maximum conducted interference.
- The frequency range from 150 kHz to 30 MHz was searched.
- Set the test-receiver system to Peak Detect Function and Specified Bandwidth with Maximum Hold Mode.



5.3. Typical Test Setup

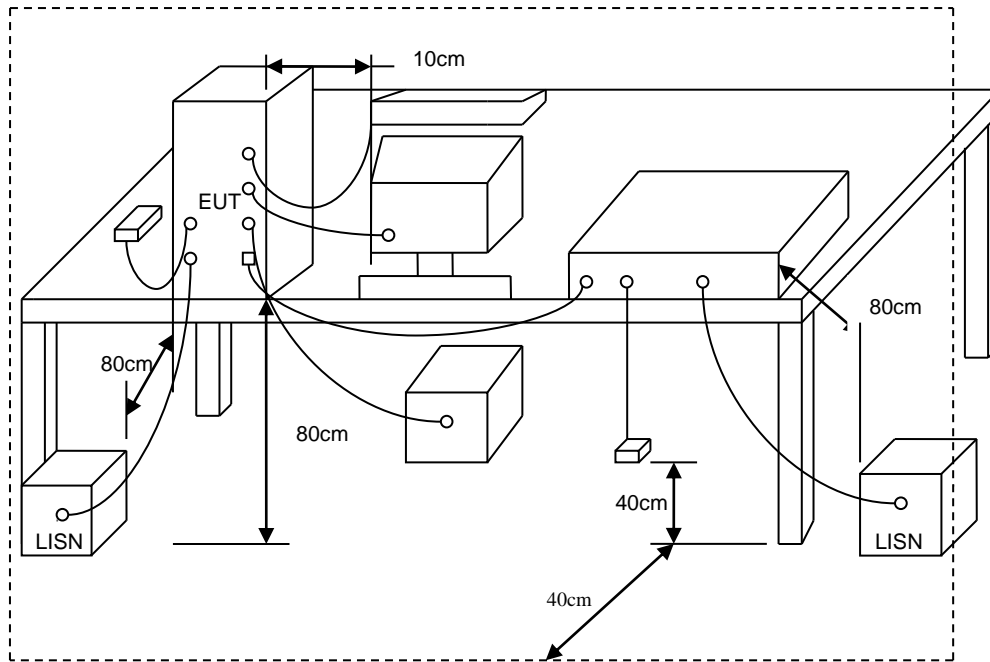



5.4. Test Result and Data

For Retest data
Non BeamForming

Power	: DC 12V From adapter (240V/60Hz)	Pol/Phase	: LINE
Test Mode	: Mode 3, CH46		

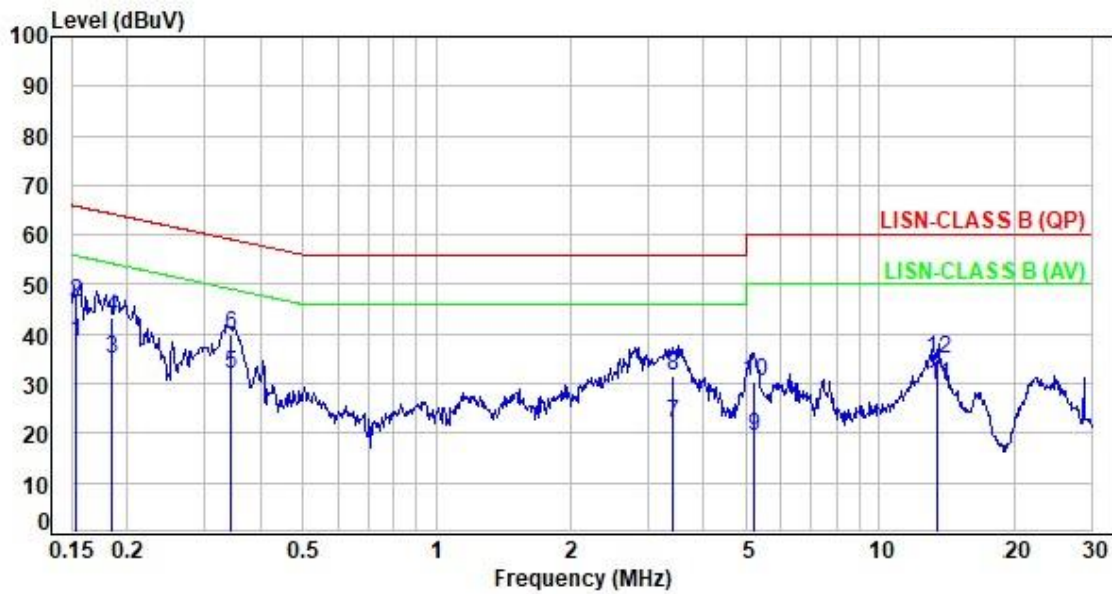

No.	Frequency (MHz)	Factor (dB)	Reading (dBuV)	Level (dBuV)	Limit (dBuV)	Margin (dB)	Detector	P/F
1	0.15	9.66	28.83	38.49	55.78	-17.29	Average	P
2	0.15	9.66	36.77	46.43	65.78	-19.35	QP	P
3	0.18	9.65	25.37	35.02	54.28	-19.26	Average	P
4	0.18	9.65	33.87	43.52	64.28	-20.76	QP	P
5	0.34	9.66	22.36	32.02	49.15	-17.13	Average	P
6	0.34	9.66	30.23	39.89	59.15	-19.26	QP	P
7	3.42	9.70	12.30	22.00	46.00	-24.00	Average	P
8	3.42	9.70	21.92	31.62	56.00	-24.38	QP	P
9	5.21	9.74	9.83	19.57	50.00	-30.43	Average	P
10	5.21	9.74	20.54	30.28	60.00	-29.72	QP	P
11	13.56	9.88	19.60	29.48	50.00	-20.52	Average	P
12	13.56	9.88	24.97	34.85	60.00	-25.15	QP	P

Note: Level=Reading+Factor
Margin=Level-Limit
Factor=(LISN or ISN or Current Probe)Factor + Cable Loss



For Retest data
Non BeamForming

Power	: DC 12V From adapter (240V/60Hz)	Pol/Phase	: NEUTRAL
Test Mode	: Mode 3, CH46		:

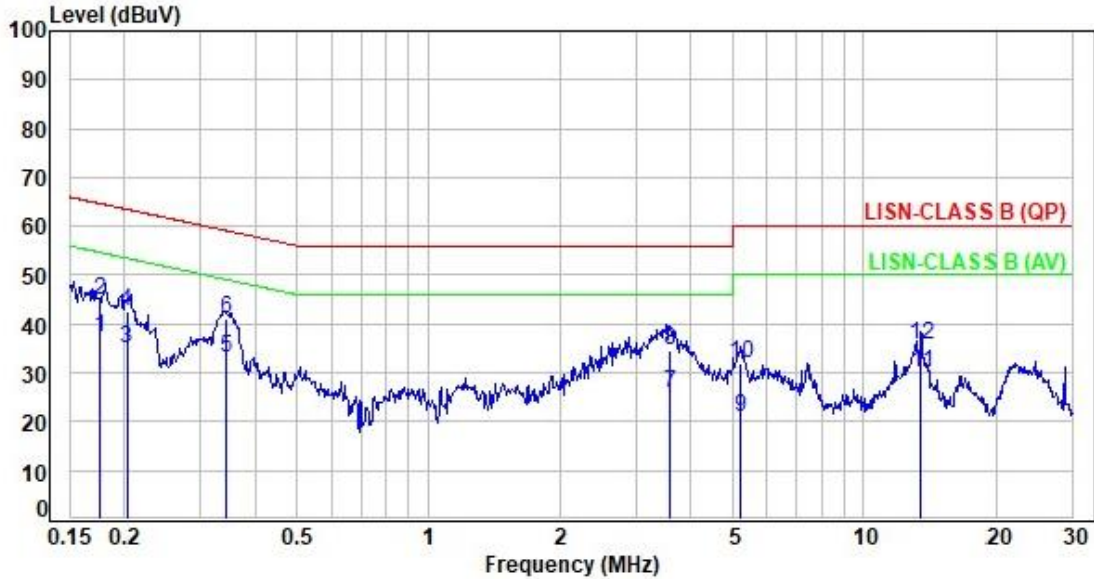

No.	Frequency (MHz)	Factor (dB)	Reading (dBuV)	Level (dBuV)	Limit (dBuV)	Margin (dB)	Detector	P/F
1	0.18	9.58	27.70	37.28	54.66	-17.38	Average	P
2	0.18	9.58	35.28	44.86	64.66	-19.80	QP	P
3	0.20	9.59	25.27	34.86	53.49	-18.63	Average	P
4	0.20	9.59	32.88	42.47	63.49	-21.02	QP	P
5	0.34	9.58	23.48	33.06	49.14	-16.08	Average	P
6	0.34	9.58	31.51	41.09	59.14	-18.05	QP	P
7	3.57	9.68	16.22	25.90	46.00	-20.10	Average	P
8	3.57	9.68	24.90	34.58	56.00	-21.42	QP	P
9	5.23	9.72	11.06	20.78	50.00	-29.22	Average	P
10	5.23	9.72	22.39	32.11	60.00	-27.89	QP	P
11	13.56	9.88	20.30	30.18	50.00	-19.82	Average	P
12	13.56	9.88	25.90	35.78	60.00	-24.22	QP	P

Note: Level=Reading+Factor
Margin=Level-Limit
Factor=(LISN or ISN or Current Probe)Factor + Cable Loss



For Retest data
BeamForming

Power	: DC 12V From adapter (240V/60Hz)	Pol/Phase	: LINE
Test Mode	: Mode 6, CH46		:

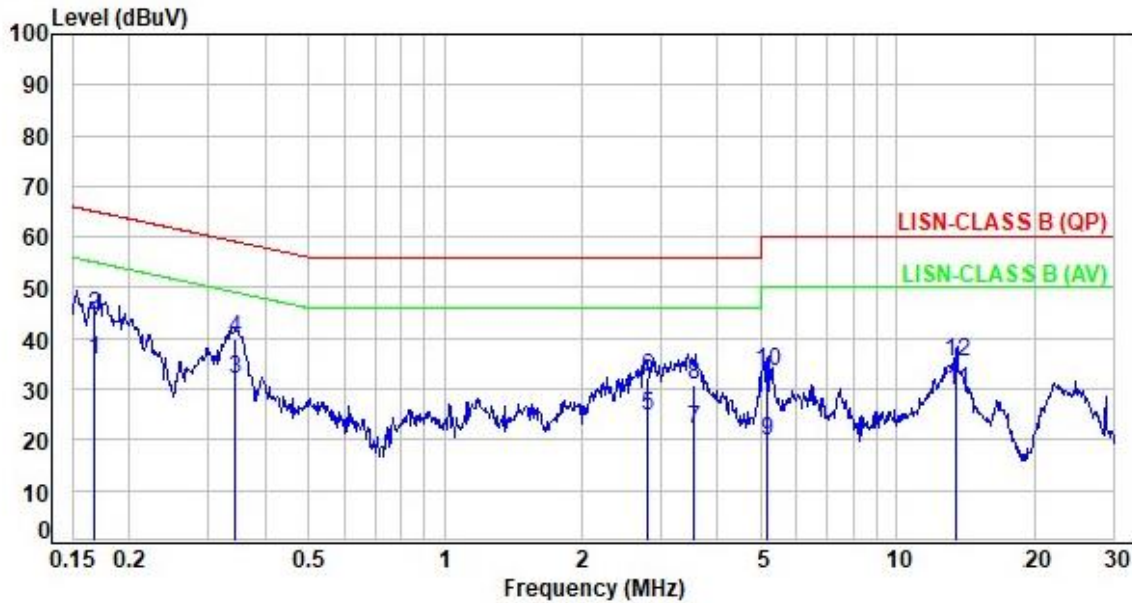

No.	Frequency (MHz)	Factor (dB)	Reading (dBuV)	Level (dBuV)	Limit (dBuV)	Margin (dB)	Detector	P/F
1	0.17	9.65	26.17	35.82	55.06	-19.24	Average	P
2	0.17	9.65	34.99	44.64	65.06	-20.42	QP	P
3	0.34	9.66	22.42	32.08	49.15	-17.07	Average	P
4	0.34	9.66	30.30	39.96	59.15	-19.19	QP	P
5	2.82	9.71	14.91	24.62	46.00	-21.38	Average	P
6	2.82	9.71	22.79	32.50	56.00	-23.50	QP	P
7	3.56	9.71	12.25	21.96	46.00	-24.04	Average	P
8	3.56	9.71	21.26	30.97	56.00	-25.03	QP	P
9	5.15	9.74	10.01	19.75	50.00	-30.25	Average	P
10	5.15	9.74	23.69	33.43	60.00	-26.57	QP	P
11	13.56	9.88	19.87	29.75	50.00	-20.25	Average	P
12	13.56	9.88	25.44	35.32	60.00	-24.68	QP	P

Note: Level=Reading+Factor
Margin=Level-Limit
Factor=(LISN or ISN or Current Probe)Factor + Cable Loss



For Retest data
BeamForming

Power	: DC 12V From adapter (240V/60Hz)	Pol/Phase	: NEUTRAL
Test Mode	: Mode 6, CH46		:

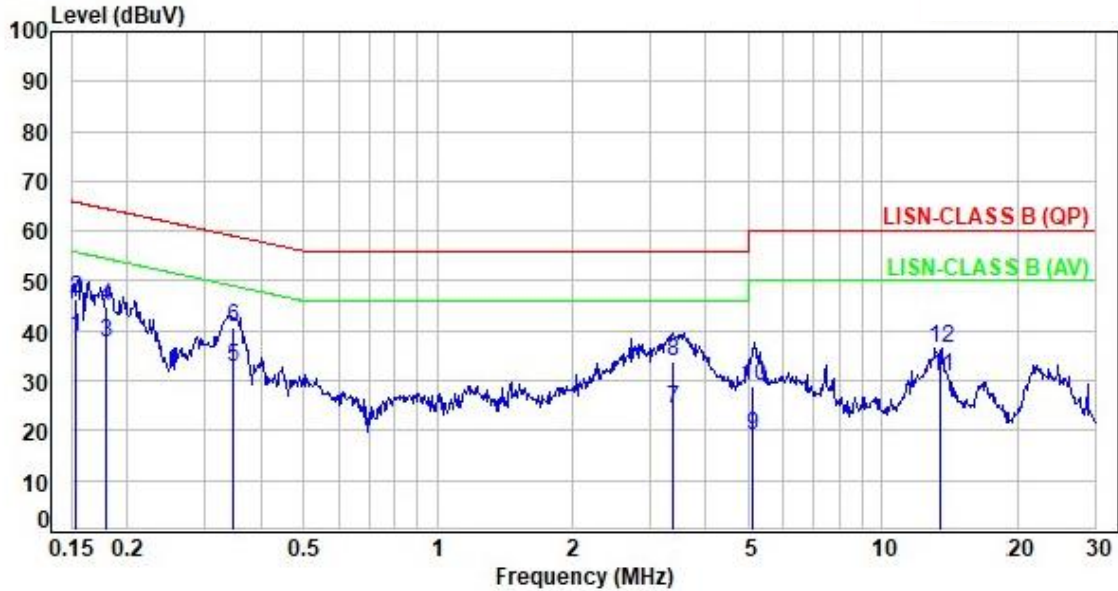

No.	Frequency (MHz)	Factor (dB)	Reading (dBuV)	Level (dBuV)	Limit (dBuV)	Margin (dB)	Detector	P/F
1	0.15	9.56	29.16	38.72	55.78	-17.06	Average	P
2	0.15	9.56	36.97	46.53	65.78	-19.25	QP	P
3	0.18	9.58	27.92	37.50	54.54	-17.04	Average	P
4	0.18	9.58	35.12	44.70	64.54	-19.84	QP	P
5	0.35	9.58	23.18	32.76	49.04	-16.28	Average	P
6	0.35	9.58	31.16	40.74	59.04	-18.30	QP	P
7	3.38	9.67	14.57	24.24	46.00	-21.76	Average	P
8	3.38	9.67	24.33	34.00	56.00	-22.00	QP	P
9	5.11	9.72	9.30	19.02	50.00	-30.98	Average	P
10	5.11	9.72	19.01	28.73	60.00	-31.27	QP	P
11	13.56	9.88	20.88	30.76	50.00	-19.24	Average	P
12	13.56	9.88	26.63	36.51	60.00	-23.49	QP	P

Note: Level=Reading+Factor
Margin=Level-Limit
Factor=(LISN or ISN or Current Probe)Factor + Cable Loss



6. Test of Spurious Emission (Radiated)

6.1. Test Limit

Undesirable emission limits. Except as shown in paragraph (b)(7) of this section, the maximum emissions outside of the frequency bands of operation shall be attenuated in accordance with the following limits:

- (1) For transmitters operating in the 5.15-5.25 GHz band: All emissions outside of the 5.15-5.35 GHz band shall not exceed an e.i.r.p. of -27 dBm/MHz.
- (2) For transmitters operating in the 5.25-5.35 GHz band: All emissions outside of the 5.15-5.35 GHz band shall not exceed an e.i.r.p. of -27 dBm/MHz.
- (3) For transmitters operating in the 5.47-5.725 GHz band: All emissions outside of the 5.47-5.725 GHz band shall not exceed an e.i.r.p. of -27 dBm/MHz.
- (4) For transmitters operating in the 5.725-5.85 GHz band:
All emissions shall be limited to a level of -27 dBm/MHz at 75 MHz or more above or below the band edge increasing linearly to 10 dBm/MHz at 25 MHz above or below the band edge, and from 25MHz above or below the band edge increasing linearly to a level of 15.6 dBm/MHz at 5 MHz above or below the band edge, and from 5 MHz above or below the band edge increasing linearly to a level of 27dBm/MHz at the band edge.
- (5) The emission measurements shall be performed using a minimum resolution bandwidth of 1 MHz. A lower resolution bandwidth may be employed near the band edge, when necessary, provided the measured energy is integrated to show the total power over 1 MHz.
- (6) Unwanted emissions below 1 GHz must comply with the general field strength limits set forth in §15.209. Further, any U-NII devices using an AC power line are required to comply also with the conducted limits set forth in §15.207.
- (7) The provisions of §15.205 apply to intentional radiators operating under this section.
- (8) When measuring the emission limits, the nominal carrier frequency shall be adjusted as close to the upper and lower frequency band edges as the design of the equipment permits.



6.2. Test Procedures

- a. The EUT was placed on a rotatable table top 0.8 meter above ground.
- b. The EUT was set 3 meters from the interference receiving antenna which was mounted on the top of a variable height antenna tower.
- c. The table was rotated 360 degrees to determine the position of the highest radiation.
- d. The antenna is a broadband antenna and its height is varied between one meter and four meters above ground to find the maximum value of the field strength both horizontal polarization and vertical polarization of the antenna are set to make the measurement.
- e. For each suspected emission the EUT was arranged to its worst case and then tune the antenna tower (from 1 M to 4 M) and turn table (from 0 degree to 360 degrees) to find the maximum reading.
- f. Set the test-receiver system to Peak or CISPR quasi-peak Detect Function and specified bandwidth with Maximum Hold Mode.
- g. If the emission level of the EUT in peak mode was 3 dB lower than the limit specified, then testing will be stopped and peak values of EUT will be reported, otherwise, the emissions which do not have 3 dB margin will be repeated one by one using the quasi-peak method and reported.
- h. For testing above 1GHz, the emission level of the EUT in peak mode was 20dB lower than average limit (that means the emission level in peak mode also complies with the limit in average mode), then testing will be stopped and peak values of EUT will be reported, otherwise, the emissions will be measured in average mode again and reported.
- i. "Cone of radiation" has been considered to be 3dB bandwidth of the measurement antenna.

Note:

- 1.The supporting fixture shall permit orientation of the EUT in each of three orthogonal axis positions such that emissions from the EUT are maximized.
(Y-AXIS is the worst.)
- 2.Due to the test software function limit the operation band setting(200dBuV/m). There's no corresponding limitation in the actual test item.



6.3. Typical Test Setup

Below 30MHz test setup

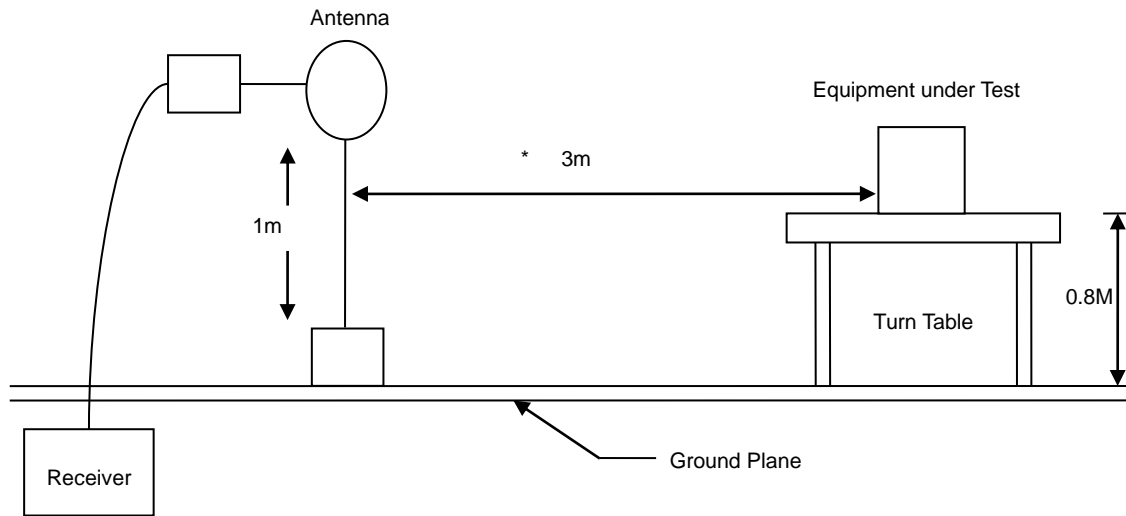

30MHz- 1GHz Test Setup

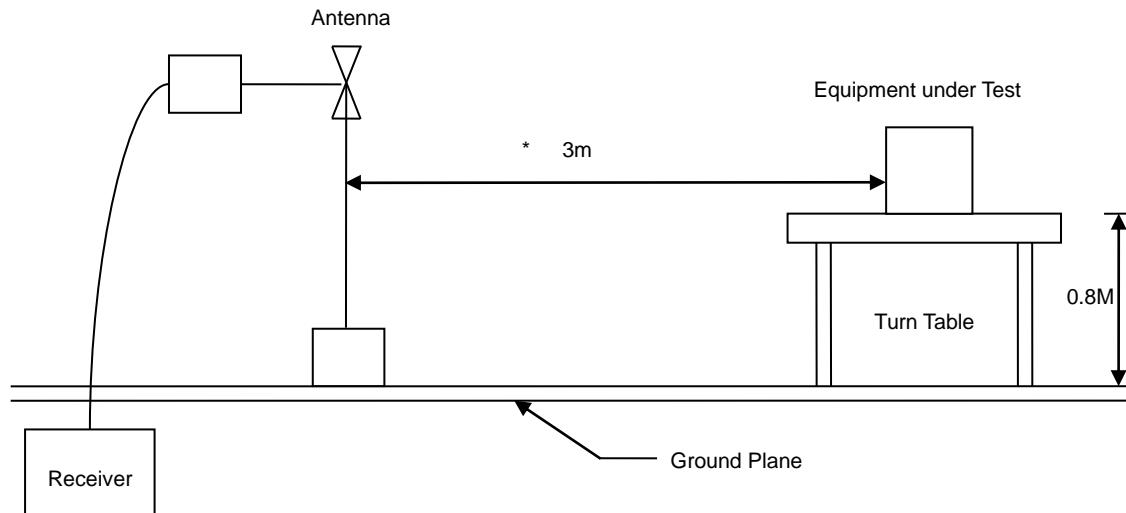

Above 1GHz Test Setup

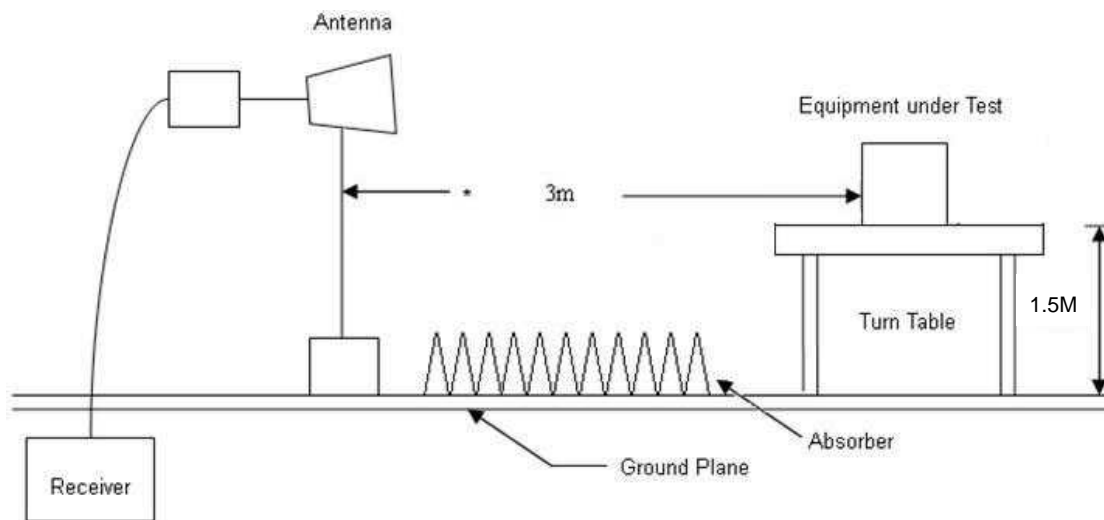



6.4. Test Result and Data (9kHz ~ 30MHz)

The 9kHz - 30MHz spurious emission is under limit 20dB more.

6.5. Test Result and Data (30MHz ~ 1GHz)

For Retest data
Non BeamForming

Power	:	DC 12V From adapter (240V/60Hz)	Pol/Phase	:	VERTICAL
Test Mode	:	Mode 3, CH46		:	

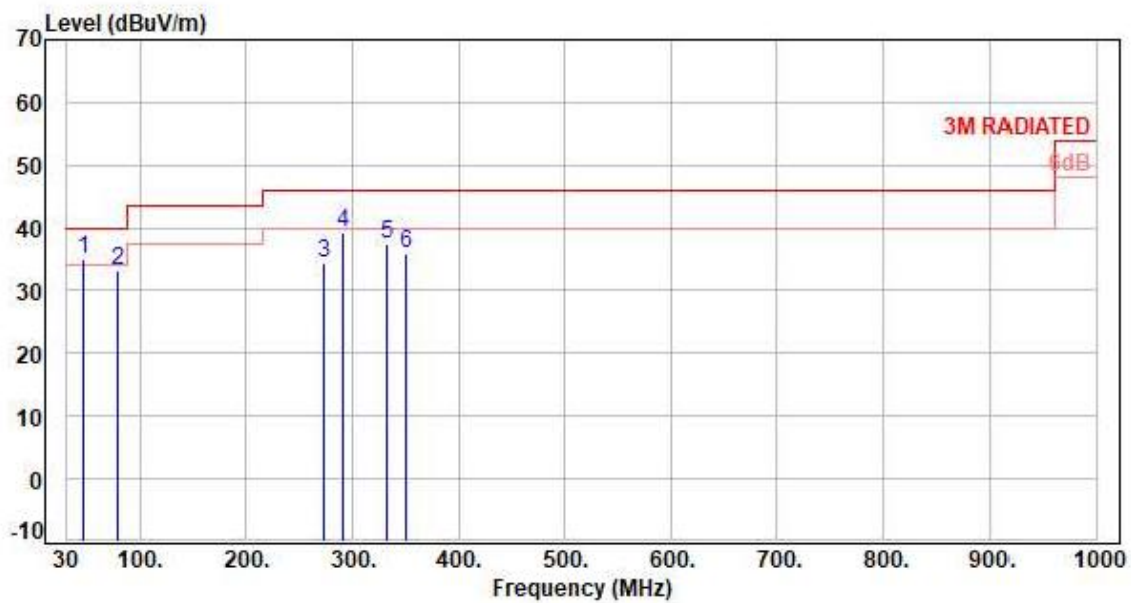

No.	Frequency (MHz)	Factor (dB)	Reading (dBuV)	Level (dBuV/m)	Limit (dBuV/m)	Margin (dB)	Detector	Height (cm)	Azimuth (deg)	P/F
1	47.46	-9.61	44.76	35.15	40.00	-4.85	Peak	400	360	P
2	78.50	-14.37	47.71	33.34	40.00	-6.66	Peak	400	360	P
3	272.50	-10.12	44.38	34.26	46.00	-11.74	Peak	400	360	P
4	291.90	-9.48	48.62	39.14	46.00	-6.86	Peak	400	360	P
5	332.64	-8.24	45.62	37.38	46.00	-8.62	Peak	400	360	P
6	350.10	-7.96	43.93	35.97	46.00	-10.03	Peak	400	360	P

Note: Level=Reading+Factor
Margin=Level-Limit
Factor=Antenna Factor + cable loss - Amplifier Factor



For Retest data
Non BeamForming

Power	: DC 12V From adapter (240V/60Hz)	Pol/Phase	: HORIZONTAL
Test Mode	: Mode 3, CH46		:

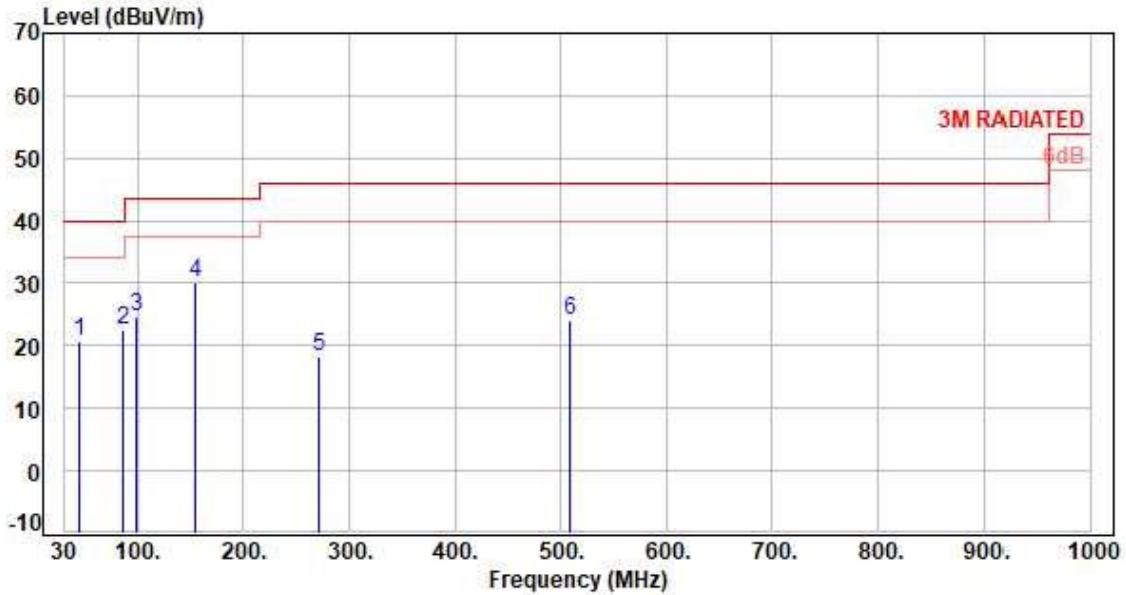

No.	Frequency (MHz)	Factor (dB)	Reading (dBuV)	Level (dBuV/m)	Limit (dBuV/m)	Margin (dB)	Detector	Height (cm)	Azimuth (deg)	P/F
1	45.52	-9.33	30.00	20.67	40.00	-19.33	Peak	400	0	P
2	86.26	-15.96	38.62	22.66	40.00	-17.34	Peak	400	0	P
3	97.90	-15.12	39.83	24.71	43.50	-18.79	Peak	400	0	P
4	154.16	-9.86	40.00	30.14	43.50	-13.36	Peak	400	0	P
5	270.56	-10.25	28.67	18.42	46.00	-27.58	Peak	400	0	P
6	509.18	-3.87	27.81	23.94	46.00	-22.06	Peak	400	0	P

Note: Level=Reading+Factor
Margin=Level-Limit
Factor=Antenna Factor + cable loss - Amplifier Factor



For Retest data
BeamForming

Power	: DC 12V From adapter (240V/60Hz)	Pol/Phase	: VERTICAL
Test Mode	: Mode 6, CH46		:

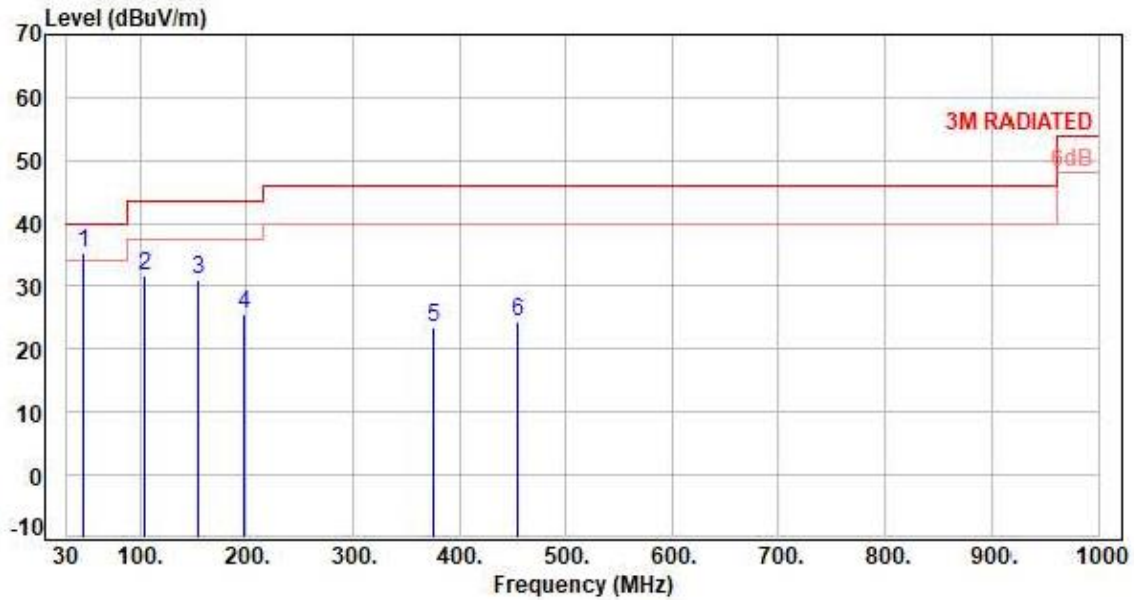

No.	Frequency (MHz)	Factor (dB)	Reading (dBuV)	Level (dBuV/m)	Limit (dBuV/m)	Margin (dB)	Detector	Height (cm)	Azimuth (deg)	P/F
1	47.46	-9.61	44.91	35.30	40.00	-4.70	Peak	400	0	P
2	103.72	-14.12	45.94	31.82	43.50	-11.68	Peak	400	0	P
3	155.13	-9.73	40.88	31.15	43.50	-12.35	Peak	400	0	P
4	196.84	-13.12	38.71	25.59	43.50	-17.91	Peak	400	0	P
5	375.32	-7.09	30.45	23.36	46.00	-22.64	Peak	400	0	P
6	454.86	-4.63	28.93	24.30	46.00	-21.70	Peak	400	0	P

Note: Level=Reading+Factor
Margin=Level-Limit
Factor=Antenna Factor + cable loss - Amplifier Factor



For Retest data
BeamForming

Power	: DC 12V From adapter (240V/60Hz)	Pol/Phase	: HORIZONTAL
Test Mode	: Mode 6, CH46		:

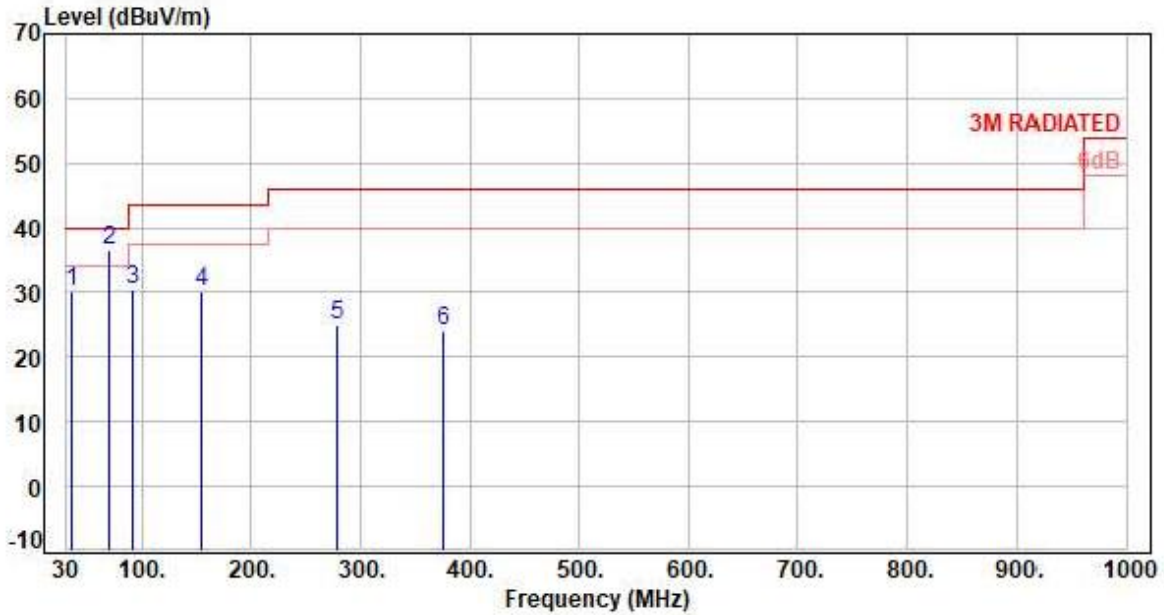

No.	Frequency (MHz)	Factor (dB)	Reading (dBuV)	Level (dBuV/m)	Limit (dBuV/m)	Margin (dB)	Detector	Height (cm)	Azimuth (deg)	P/F
1	35.82	-11.23	41.51	30.28	40.00	-9.72	Peak	400	0	P
2	70.74	-12.52	49.01	36.49	40.00	-3.51	Peak	400	0	P
3	92.08	-15.91	46.36	30.45	43.50	-13.05	Peak	400	0	P
4	155.13	-9.73	40.00	30.27	43.50	-13.23	Peak	400	0	P
5	278.32	-9.90	34.98	25.08	46.00	-20.92	Peak	400	0	P
6	375.32	-7.09	31.24	24.15	46.00	-21.85	Peak	400	0	P

Note: Level=Reading+Factor
Margin=Level-Limit
Factor=Antenna Factor + cable loss - Amplifier Factor



6.6. Test Result and Data (1GHz ~ 40GHz)

For 22090062-TRFCC04
Non BeamForming

Power	: DC 12V From adapter (120V/60Hz)	Pol/Phase	: VERTICAL
Test Mode	: Mode 1, Band 1, CH36		

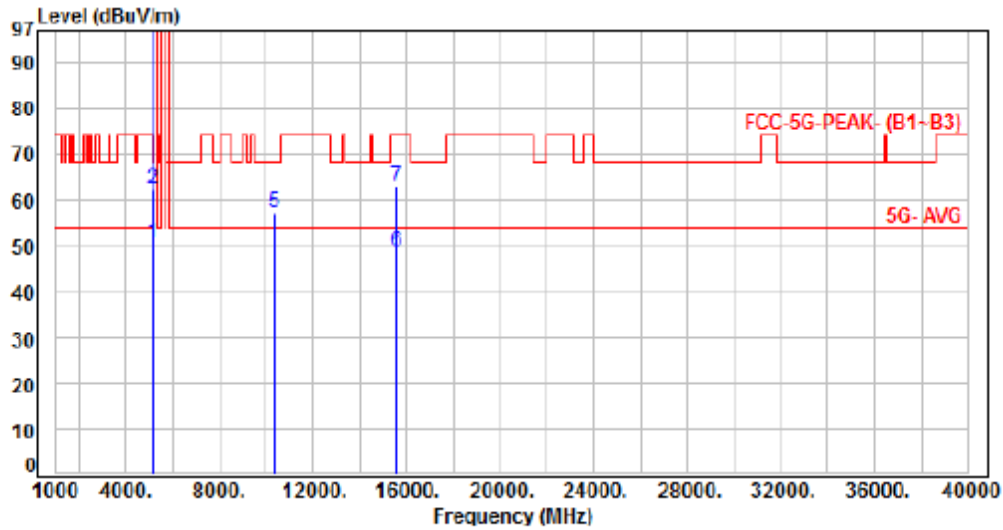

No.	Frequency (MHz)	Factor (dB)	Reading (dBuV)	Level (dBuV/m)	Limit (dBuV/m)	Margin (dB)	Detector	Height (cm)	Azimuth (deg)	P/F
1	5150.00	6.21	44.17	50.38	54.00	-3.62	Average	193	339	P
2	5150.00	6.21	55.98	62.19	74.00	-11.81	Peak	193	339	P
3	5180.00	6.35	100.62	106.97	200.00	-93.03	Average	193	339	P
4	5180.00	6.35	110.67	117.02	200.00	-82.98	Peak	193	339	P
5	10360.00	13.59	43.55	57.14	68.20	-11.06	Peak	100	37	P
6	15540.00	17.41	31.43	48.84	54.00	-5.16	Average	100	133	P
7	15540.00	17.41	45.63	63.04	74.00	-10.96	Peak	100	133	P

Note: Level=Reading+Factor
Margin=Level-Limit
Factor=Antenna Factor + cable loss - Amplifier Factor



For 22090062-TRFCC04

Non BeamForming

Power	: DC 12V From adapter (120V/60Hz)	Pol/Phase	: HORIZONTAL
Test Mode	: Mode 1, Band 1, CH36		:

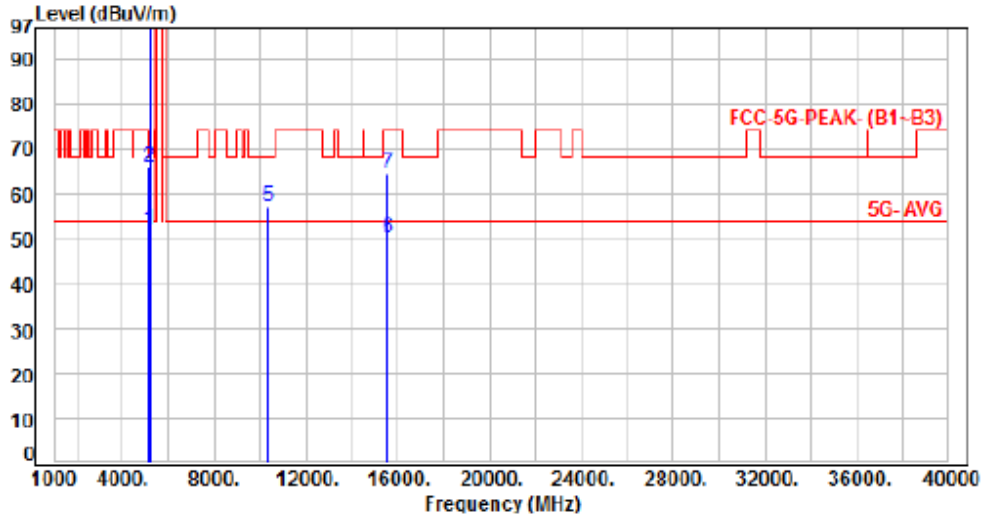

No.	Frequency (MHz)	Factor (dB)	Reading (dBuV)	Level (dBuV/m)	Limit (dBuV/m)	Margin (dB)	Detector	Height (cm)	Azimuth (deg)	P/F
1	5150.00	6.21	45.91	52.12	54.00	-1.88	Average	318	72	P
2	5150.00	6.21	59.77	65.98	74.00	-8.02	Peak	318	72	P
3	5180.00	6.35	100.09	106.44	200.00	-93.56	Average	318	72	P
4	5180.00	6.35	109.57	115.92	200.00	-84.08	Peak	318	72	P
5	10360.00	13.59	43.68	57.27	68.20	-10.93	Peak	100	311	P
6	15540.00	17.41	32.87	50.28	54.00	-3.72	Average	207	136	P
7	15540.00	17.41	47.06	64.47	74.00	-9.53	Peak	207	136	P

Note: Level=Reading+Factor
Margin=Level-Limit
Factor=Antenna Factor + cable loss - Amplifier Factor



For 22090062-TRFCC04

Non BeamForming

Power	: DC 12V From adapter (120V/60Hz)	Pol/Phase	: VERTICAL
Test Mode	: Mode 1, Band 1, CH40		:

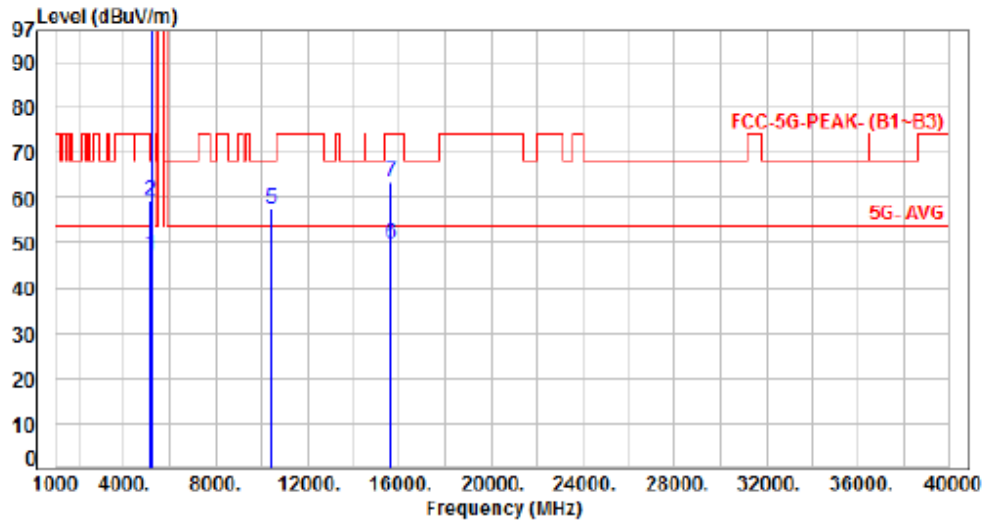

No.	Frequency (MHz)	Factor (dB)	Reading (dBuV)	Level (dBuV/m)	Limit (dBuV/m)	Margin (dB)	Detector	Height (cm)	Azimuth (deg)	P/F
1	5150.00	6.21	41.14	47.35	54.00	-6.65	Average	246	337	P
2	5150.00	6.21	53.27	59.48	74.00	-14.52	Peak	246	337	P
3	5200.00	6.44	101.38	107.82	200.00	-92.18	Average	246	337	P
4	5200.00	6.44	110.85	117.29	200.00	-82.71	Peak	246	337	P
5	10400.00	13.67	43.81	57.46	68.20	-10.72	Peak	100	77	P
6	15600.00	17.03	32.65	49.68	54.00	-4.32	Average	100	132	P
7	15600.00	17.03	46.30	63.33	74.00	-10.67	Peak	100	132	P

Note: Level=Reading+Factor
Margin=Level-Limit
Factor=Antenna Factor + cable loss - Amplifier Factor



For 22090062-TRFCC04

Non BeamForming

Power	: DC 12V From adapter (120V/60Hz)	Pol/Phase	: HORIZONTAL
Test Mode	: Mode 1, Band 1, CH40		

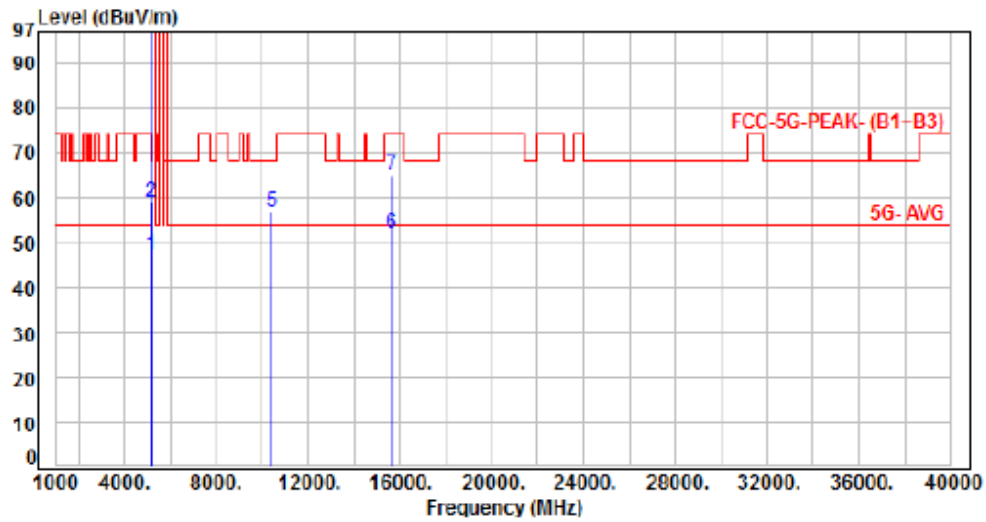

No.	Frequency (MHz)	Factor (dB)	Reading (dBuV)	Level (dBuV/m)	Limit (dBuV/m)	Margin (dB)	Detector	Height (cm)	Azimuth (deg)	P/F
1	5150.00	6.21	41.10	47.31	54.00	-6.69	Average	170	327	P
2	5150.00	6.21	52.84	59.05	74.00	-14.95	Peak	170	327	P
3	5200.00	6.44	100.45	106.89	200.00	-93.11	Average	170	327	P
4	5200.00	6.44	109.85	116.29	200.00	-83.71	Peak	170	327	P
5	10400.00	13.67	43.06	56.73	68.20	-11.47	Peak	100	63	P
6	15600.00	17.03	34.98	52.01	54.00	-1.99	Average	173	104	P
7	15600.00	17.03	47.99	65.02	74.00	-8.98	Peak	173	104	P

Note: Level=Reading+Factor
Margin=Level-Limit
Factor=Antenna Factor + cable loss - Amplifier Factor



For 22090062-TRFCC04

Non BeamForming

Power	: DC 12V From adapter (120V/60Hz)	Pol/Phase	: VERTICAL
Test Mode	: Mode 1, Band 1, CH48		:

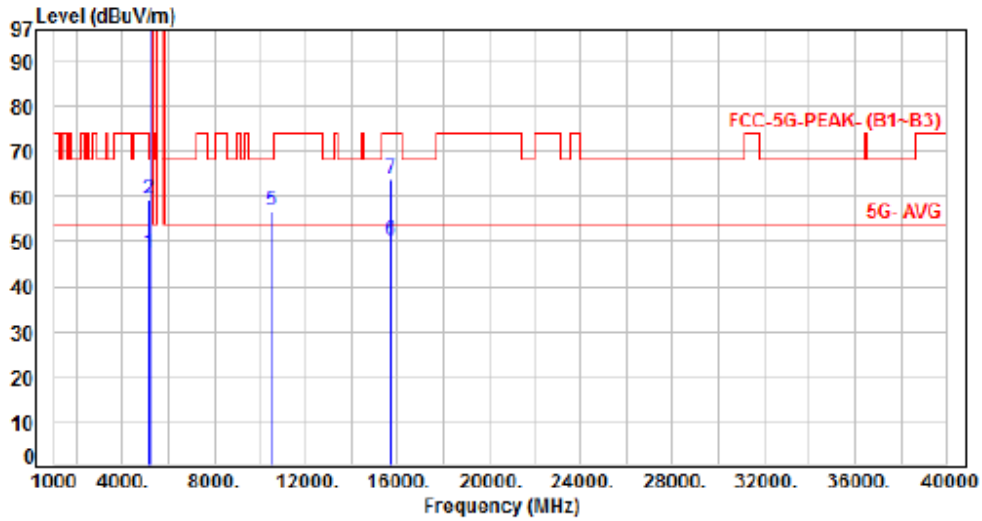

No.	Frequency (MHz)	Factor (dB)	Reading (dBuV)	Level (dBuV/m)	Limit (dBuV/m)	Margin (dB)	Detector	Height (cm)	Azimuth (deg)	P/F
1	5150.00	6.21	40.92	47.13	54.00	-6.87	Average	243	338	P
2	5150.00	6.21	53.27	59.48	74.00	-14.52	Peak	243	338	P
3	5240.00	6.40	101.04	108.24	200.00	-91.76	Average	243	338	P
4	5240.00	6.40	111.48	117.88	200.00	-82.12	Peak	243	338	P
5	10480.00	13.79	43.13	56.92	68.20	-11.28	Peak	100	48	P
6	15720.00	16.80	33.22	50.02	54.00	-3.98	Average	100	130	P
7	15720.00	16.80	47.00	63.80	74.00	-10.20	Peak	100	130	P

Note: Level=Reading+Factor
 Margin=Level-Limit
 Factor=Antenna Factor + cable loss - Amplifier Factor



For 22090062-TRFCC04

Non BeamForming

Power	: DC 12V From adapter (120V/60Hz)	Pol/Phase	: HORIZONTAL
Test Mode	: Mode 1, Band 1, CH48		

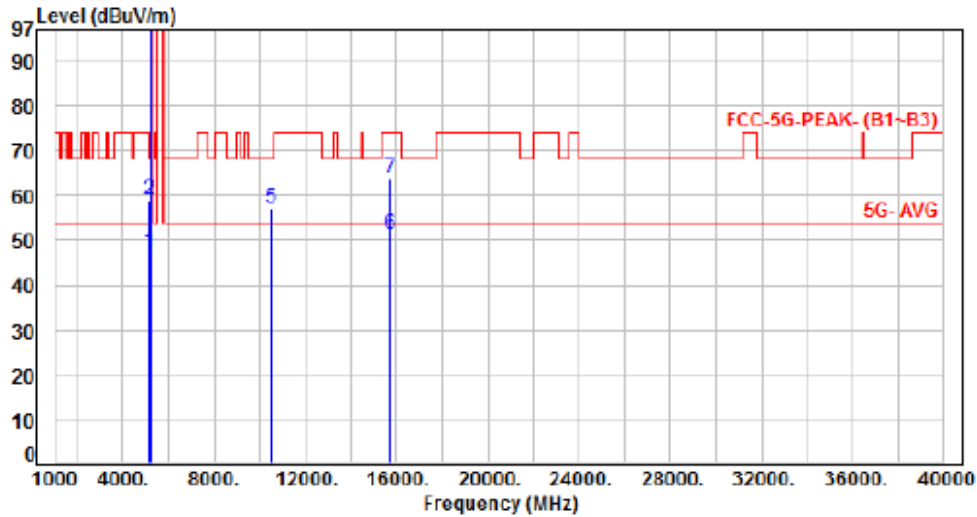

No.	Frequency (MHz)	Factor (dB)	Reading (dBUV)	Level (dBUV/m)	Limit (dBUV/m)	Margin (dB)	Detector	Height (cm)	Azimuth (deg)	P/F
1	5150.00	6.21	41.01	47.22	54.00	-6.78	Average	200	327	P
2	5150.00	6.21	52.66	58.87	74.00	-15.13	Peak	200	327	P
3	5240.00	6.40	101.20	107.60	200.00	-92.32	Average	200	327	P
4	5240.00	6.40	111.54	117.94	200.00	-82.06	Peak	200	327	P
5	10480.00	13.79	43.44	57.23	68.20	-10.97	Peak	100	33	P
6	15720.00	16.80	34.38	51.18	54.00	-2.82	Average	100	222	P
7	15720.00	16.80	47.12	63.92	74.00	-10.08	Peak	100	222	P

Note: Level=Reading+Factor
Margin=Level-Limit
Factor=Antenna Factor + cable loss - Amplifier Factor



For 22090062-TRFCC04

Non BeamForming

Power	: DC 12V From adapter (120V/60Hz)	Pol/Phase	: VERTICAL
Test Mode	: Mode 2, Band 1, CH36		

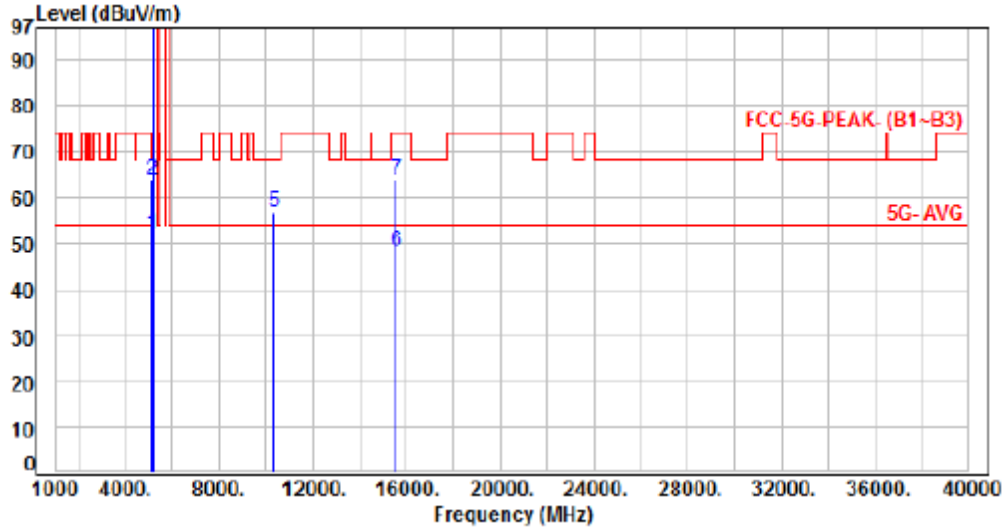

No.	Frequency (MHz)	Factor (dB)	Reading (dBuV)	Level (dBuV/m)	Limit (dBuV/m)	Margin (dB)	Detector	Height (cm)	Azimuth (deg)	P/F
1	5150.00	6.21	45.90	52.11	54.00	-1.89	Average	206	340	P
2	5150.00	6.21	57.53	63.74	74.00	-10.26	Peak	206	340	P
3	5180.00	6.35	99.24	105.59	200.00	-94.41	Average	206	340	P
4	5180.00	6.35	112.30	118.65	200.00	-81.35	Peak	206	340	P
5	10360.00	13.59	43.28	56.87	68.20	-11.33	Peak	100	51	P
6	15540.00	17.41	31.05	48.46	54.00	-5.54	Average	331	120	P
7	15540.00	17.41	46.57	63.98	74.00	-10.02	Peak	331	120	P

Note: Level=Reading+Factor
 Margin=Level-Limit
 Factor=Antenna Factor + cable loss - Amplifier Factor



For 22090062-TRFCC04

Non BeamForming

Power	: DC 12V From adapter (120V/60Hz)	Pol/Phase	: HORIZONTAL
Test Mode	: Mode 2, Band 1, CH36		

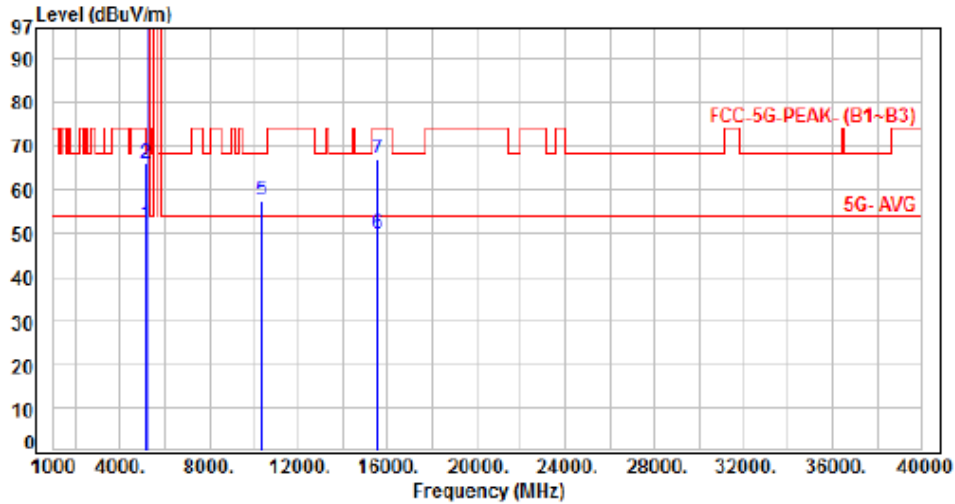

No.	Frequency (MHz)	Factor (dB)	Reading (dBuV)	Level (dBuV/m)	Limit (dBuV/m)	Margin (dB)	Detector	Height (cm)	Azimuth (deg)	P/F
1	5150.00	6.21	45.94	52.15	54.00	-1.85	Average	203	342	P
2	5150.00	6.21	59.95	66.16	74.00	-7.84	Peak	203	342	P
3	5180.00	6.35	99.70	106.05	200.00	-93.95	Average	203	342	P
4	5180.00	6.35	113.30	119.65	200.00	-80.35	Peak	203	342	P
5	10360.00	13.59	43.98	57.57	68.20	-10.63	Peak	100	67	P
6	15540.00	17.41	32.25	49.66	54.00	-4.34	Average	197	137	P
7	15540.00	17.41	49.55	66.96	74.00	-7.04	Peak	197	137	P

Note: Level=Reading+Factor
Margin=Level-Limit
Factor=Antenna Factor + cable loss - Amplifier Factor



For 22090062-TRFCC04

Non BeamForming

Power	: DC 12V From adapter (120V/60Hz)	Pol/Phase	: VERTICAL
Test Mode	: Mode 2, Band 1, CH40		:

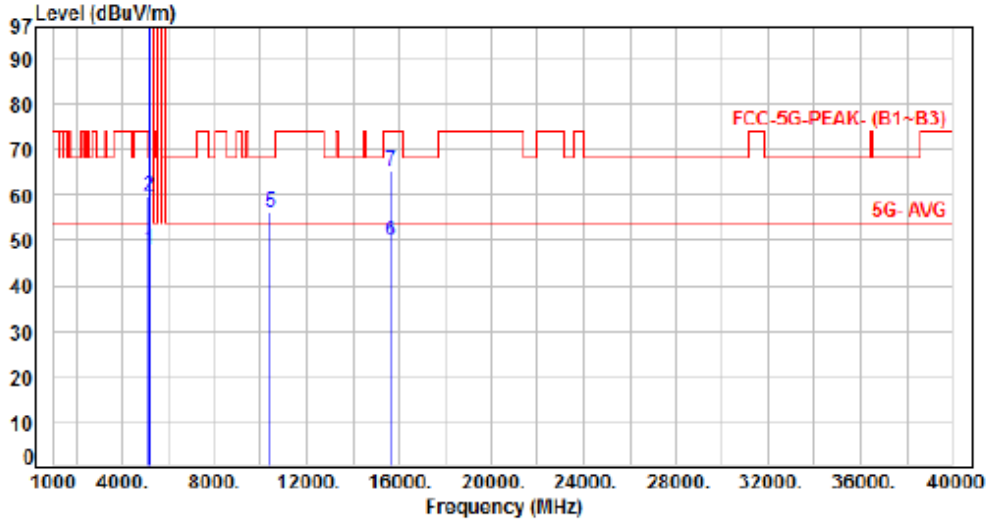

No.	Frequency (MHz)	Factor (dB)	Reading (dBuV)	Level (dBuV/m)	Limit (dBuV/m)	Margin (dB)	Detector	Height (cm)	Azimuth (deg)	P/F
1	5150.00	6.21	41.77	47.98	54.00	-6.02	Average	232	339	P
2	5150.00	6.21	53.36	59.57	74.00	-14.43	Peak	232	339	P
3	5200.00	6.44	100.36	106.80	200.00	-93.20	Average	232	339	P
4	5200.00	6.44	113.39	119.83	200.00	-80.17	Peak	232	339	P
5	10400.00	13.67	42.28	55.95	68.20	-12.25	Peak	100	128	P
6	15600.00	17.03	32.85	49.88	54.00	-4.12	Average	101	125	P
7	15600.00	17.03	48.34	65.37	74.00	-8.63	Peak	101	125	P

Note: Level=Reading+Factor
Margin=Level-Limit
Factor=Antenna Factor + cable loss - Amplifier Factor



For 22090062-TRFCC04

Non BeamForming

Power	: DC 12V From adapter (120V/60Hz)	Pol/Phase	: HORIZONTAL
Test Mode	: Mode 2, Band 1, CH40		:

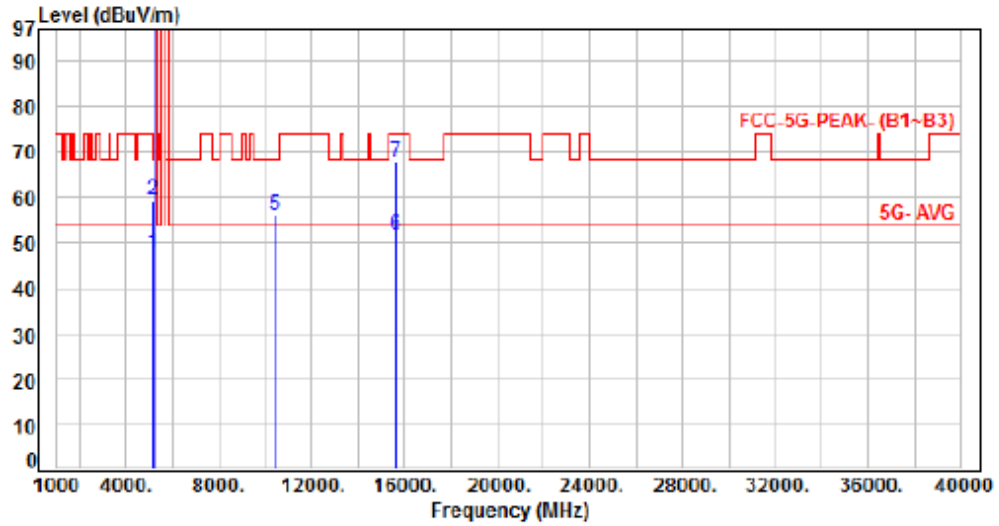

No.	Frequency (MHz)	Factor (dB)	Reading (dBuV)	Level (dBuV/m)	Limit (dBuV/m)	Margin (dB)	Detector	Height (cm)	Azimuth (deg)	P/F
1	5150.00	6.21	41.30	47.51	54.00	-6.49	Average	150	322	P
2	5150.00	6.21	53.13	59.34	74.00	-14.66	Peak	150	322	P
3	5200.00	6.44	100.77	107.21	200.00	-92.79	Average	150	322	P
4	5200.00	6.44	113.53	119.97	200.00	-80.03	Peak	150	322	P
5	10400.00	13.67	42.39	56.06	68.20	-12.14	Peak	100	83	P
6	15600.00	17.03	34.67	51.70	54.00	-2.30	Average	102	105	P
7	15600.00	17.03	50.93	67.96	74.00	-6.04	Peak	102	105	P

Note: Level=Reading+factor
Margin=Level-Limit
Factor=Antenna Factor + cable loss - Amplifier Factor



For 22090062-TRFCC04

Non BeamForming

Power	: DC 12V From adapter (120V/60Hz)	Pol/Phase	: VERTICAL
Test Mode	: Mode 2, Band 1, CH48		

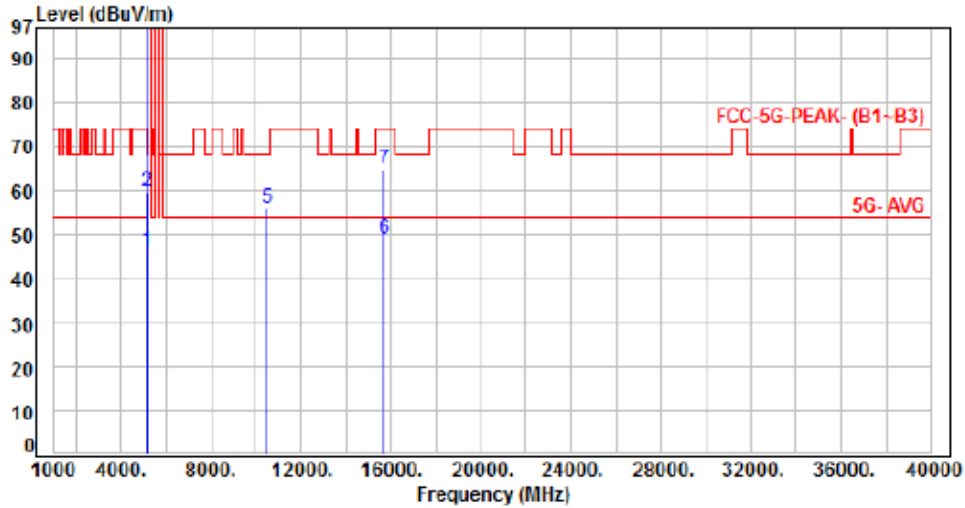

No.	Frequency (MHz)	Factor (dB)	Reading (dBuV)	Level (dBuV/m)	Limit (dBuV/m)	Margin (dB)	Detector	Height (cm)	Azimuth (deg)	P/F
1	5150.00	6.21	40.17	46.38	54.00	-7.62	Average	334	339	P
2	5150.00	6.21	53.42	59.63	74.00	-14.37	Peak	334	339	P
3	5240.00	6.40	100.24	106.64	200.00	-93.36	Average	334	339	P
4	5240.00	6.40	113.51	119.91	200.00	-80.09	Peak	334	339	P
5	10480.00	13.79	42.41	56.20	68.20	-12.00	Peak	100	68	P
6	15720.00	16.80	32.17	48.97	54.00	-5.03	Average	102	129	P
7	15720.00	16.80	48.21	65.01	74.00	-8.99	Peak	102	129	P

Note: Level=Reading+Factor
Margin=Level-Limit
Factor=Antenna Factor + cable loss - Amplifier Factor



For 22090062-TRFCC04

Non BeamForming

Power	: DC 12V From adapter (120V/60Hz)	Pol/Phase	: HORIZONTAL
Test Mode	: Mode 2, Band 1, CH48		

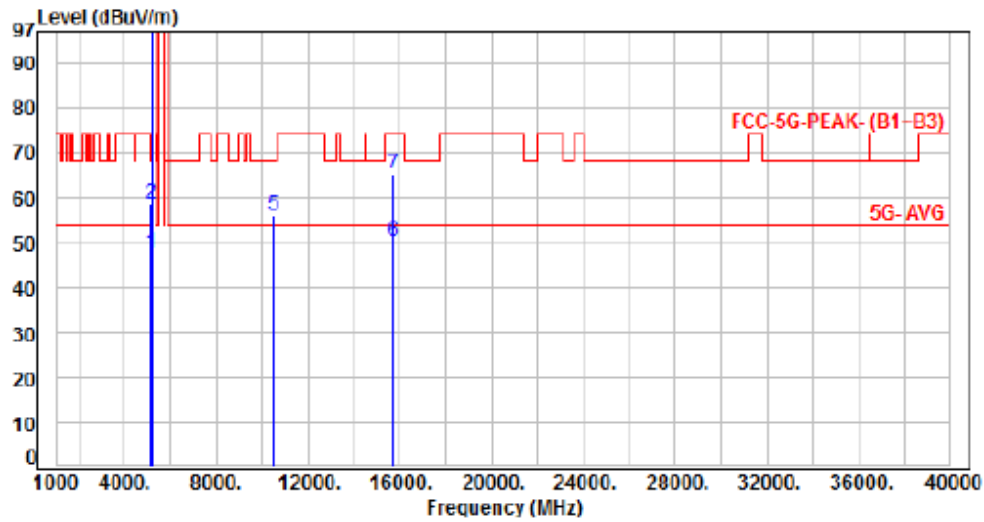

No.	Frequency (MHz)	Factor (dB)	Reading (dBuV)	Level (dBuV/m)	Limit (dBuV/m)	Margin (dB)	Detector	Height (cm)	Azimuth (deg)	P/F
1	5150.00	6.21	41.27	47.48	54.00	-6.52	Average	120	320	P
2	5150.00	6.21	52.56	58.77	74.00	-15.23	Peak	120	320	P
3	5240.00	6.40	100.66	107.06	200.00	-92.94	Average	120	320	P
4	5240.00	6.40	113.79	120.19	200.00	-79.81	Peak	120	320	P
5	10480.00	13.79	42.33	56.12	68.20	-12.08	Peak	100	94	P
6	15720.00	16.80	33.41	50.21	54.00	-3.79	Average	100	222	P
7	15720.00	16.80	48.45	65.25	74.00	-8.75	Peak	100	222	P

Note: Level=Reading+Factor
Margin=Level-Limit
Factor=Antenna Factor + cable loss - Amplifier Factor



For 22090062-TRFCC04

Non BeamForming

Power	: DC 12V From adapter (120V/60Hz)	Pol/Phase	: VERTICAL
Test Mode	: Mode 3, Band 1, CH38		

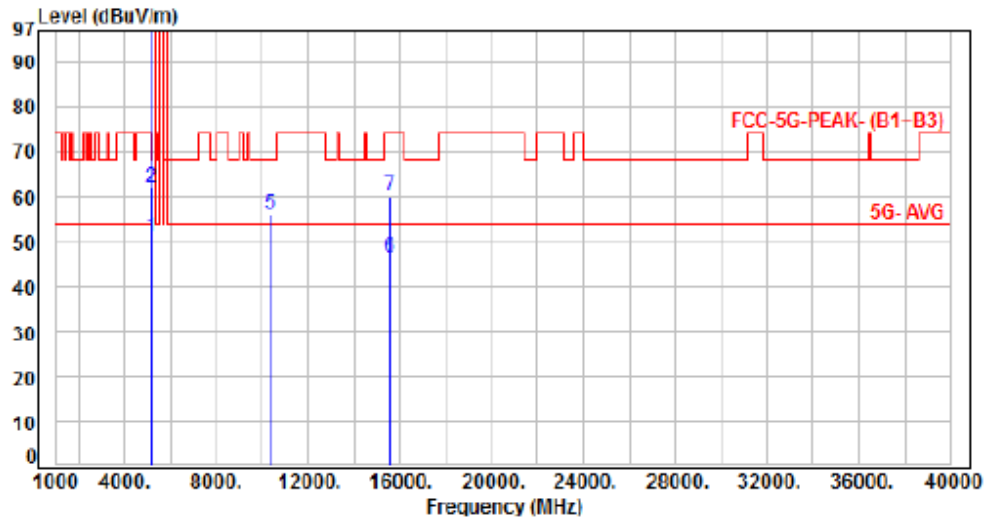

No.	Frequency (MHz)	Factor (dB)	Reading (dBuV)	Level (dBuV/m)	Limit (dBuV/m)	Margin (dB)	Detector	Height (cm)	Azimuth (deg)	P/F
1	5150.00	6.21	44.65	50.86	54.00	-3.14	Average	218	339	P
2	5150.00	6.21	55.92	62.13	74.00	-11.87	Peak	218	339	P
3	5190.00	6.40	95.09	101.49	200.00	-98.51	Average	218	339	P
4	5190.00	6.40	108.38	114.78	200.00	-85.22	Peak	218	339	P
5	10380.00	13.64	42.31	55.95	68.20	-12.25	Peak	100	89	P
6	15570.00	17.22	29.40	46.62	54.00	-7.38	Average	100	312	P
7	15570.00	17.22	43.02	60.24	74.00	-13.76	Peak	100	312	P

Note: Level=Reading+Factor
Margin=Level-Limit
Factor=Antenna Factor + cable loss - Amplifier Factor



For 22090062-TRFCC04

Non BeamForming

Power	: DC 12V From adapter (120V/60Hz)	Pol/Phase	: HORIZONTAL
Test Mode	: Mode 3, Band 1, CH38		

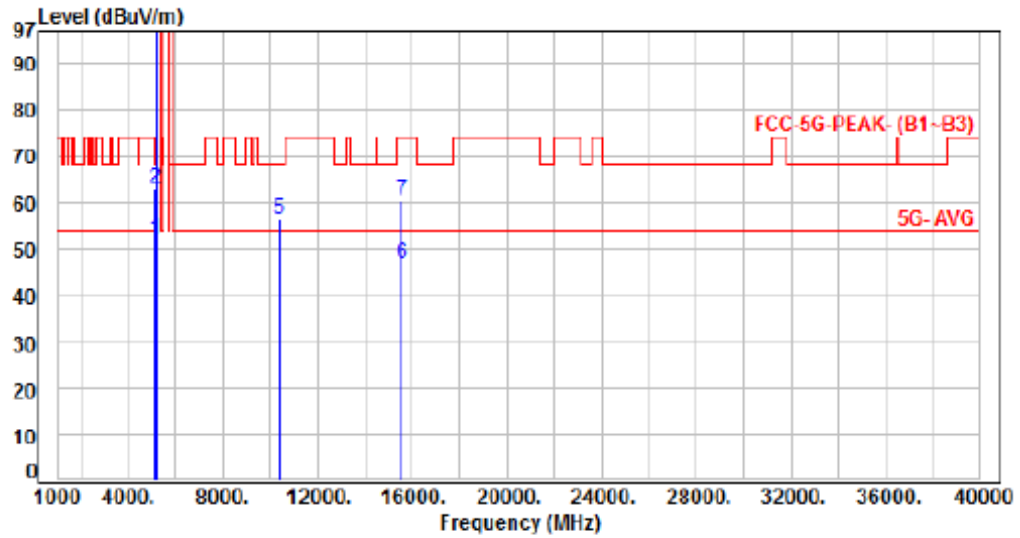

No.	Frequency (MHz)	Factor (dB)	Reading (dBuV)	Level (dBuV/m)	Limit (dBuV/m)	Margin (dB)	Detector	Height (cm)	Azimuth (deg)	P/F
1	5150.00	6.21	45.80	52.01	54.00	-1.99	Average	186	326	P
2	5150.00	6.21	56.89	63.10	74.00	-10.90	Peak	186	326	P
3	5190.00	6.40	94.63	101.03	200.00	-98.97	Average	186	326	P
4	5190.00	6.40	108.40	114.80	200.00	-85.20	Peak	186	326	P
5	10380.00	13.64	42.88	56.52	68.20	-11.68	Peak	100	63	P
6	15570.00	17.22	29.56	46.78	54.00	-7.22	Average	100	303	P
7	15570.00	17.22	43.19	60.41	74.00	-13.59	Peak	100	303	P

Note: Level=Reading+Factor
Margin=Level-Limit
Factor=Antenna Factor + cable loss - Amplifier Factor



For 22090062-TRFCC04

Non BeamForming

Power	: DC 12V From adapter (120V/60Hz)	Pol/Phase	: VERTICAL
Test Mode	: Mode 3, Band 1, CH46		:

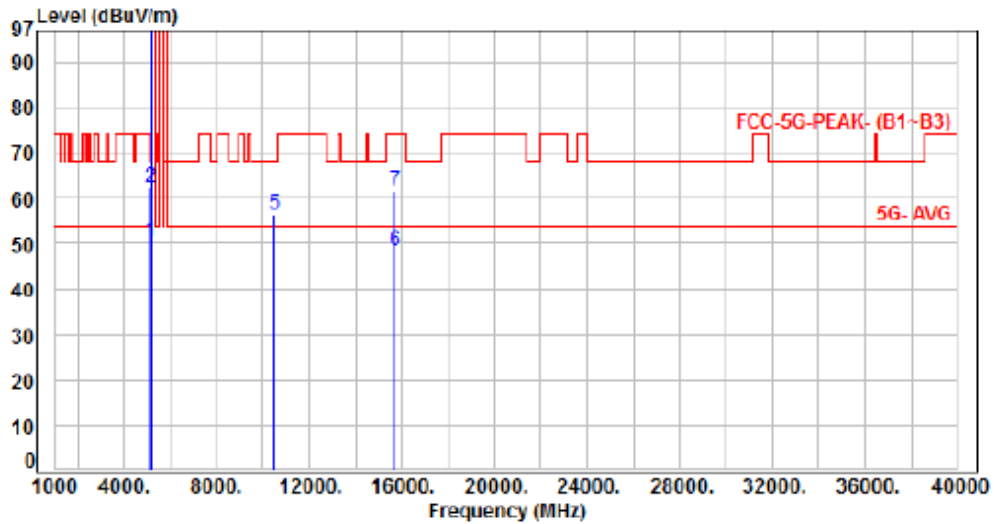

No.	Frequency (MHz)	Factor (dB)	Reading (dBuV)	Level (dBuV/m)	Limit (dBuV/m)	Margin (dB)	Detector	Height (cm)	Azimuth (deg)	P/F
1	5150.00	6.21	44.23	50.44	54.00	-3.56	Average	241	341	P
2	5150.00	6.21	56.18	62.39	74.00	-11.61	Peak	241	341	P
3	5230.00	6.42	99.68	106.10	200.00	-93.90	Average	241	341	P
4	5230.00	6.42	112.92	119.34	200.00	-80.66	Peak	241	341	P
5	10460.00	13.76	42.59	56.35	68.20	-11.85	Peak	100	51	P
6	15690.00	16.91	31.24	48.15	54.00	-5.85	Average	100	131	P
7	15690.00	16.91	44.73	61.64	74.00	-12.36	Peak	100	131	P

Note: Level=Reading+Factor
 Margin=Level-Limit
 Factor=Antenna Factor + cable loss - Amplifier Factor



For 22090062-TRFCC04

Non BeamForming

Power	: DC 12V From adapter (120V/60Hz)	Pol/Phase	: HORIZONTAL
Test Mode	: Mode 3, Band 1, CH46		:

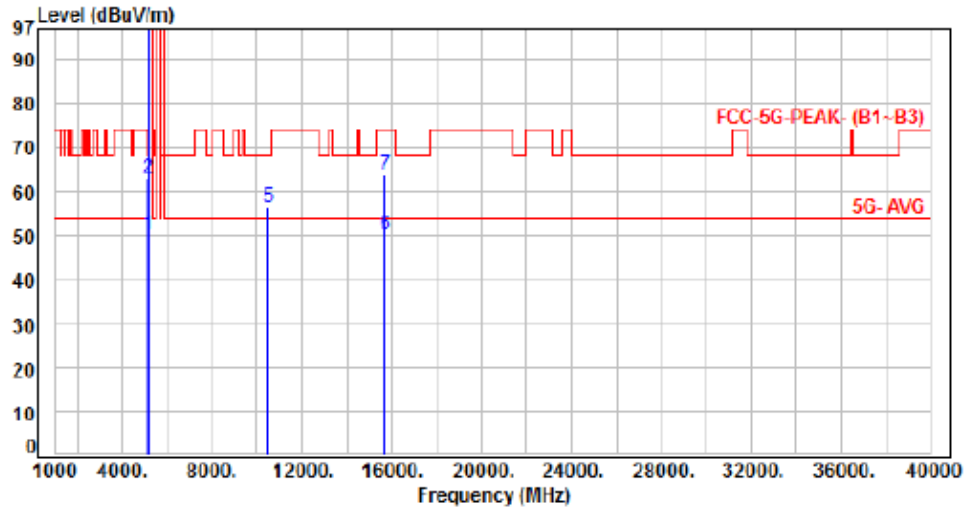

No.	Frequency (MHz)	Factor (dB)	Reading (dBuV)	Level (dBuV/m)	Limit (dBuV/m)	Margin (dB)	Detector	Height (cm)	Azimuth (deg)	P/F
1	5150.00	6.21	44.07	50.28	54.00	-3.72	Average	174	325	P
2	5150.00	6.21	57.01	63.22	74.00	-10.78	Peak	174	325	P
3	5230.00	6.42	98.44	104.86	200.00	-95.14	Average	174	325	P
4	5230.00	6.42	111.62	118.04	200.00	-81.96	Peak	174	325	P
5	10460.00	13.76	42.75	56.51	68.20	-11.69	Peak	100	59	P
6	15690.00	16.91	33.22	50.13	54.00	-3.87	Average	179	242	P
7	15690.00	16.91	46.79	63.70	74.00	-10.30	Peak	179	242	P

Note: Level=Reading+Factor
 Margin=Level-Limit
 Factor=Antenna Factor + cable loss - Amplifier Factor



For 22090062-TRFCC04

Non BeamForming

Power	: DC 12V From adapter (120V/60Hz)	Pol/Phase	: VERTICAL
Test Mode	: Mode 4, Band 1, CH42		:

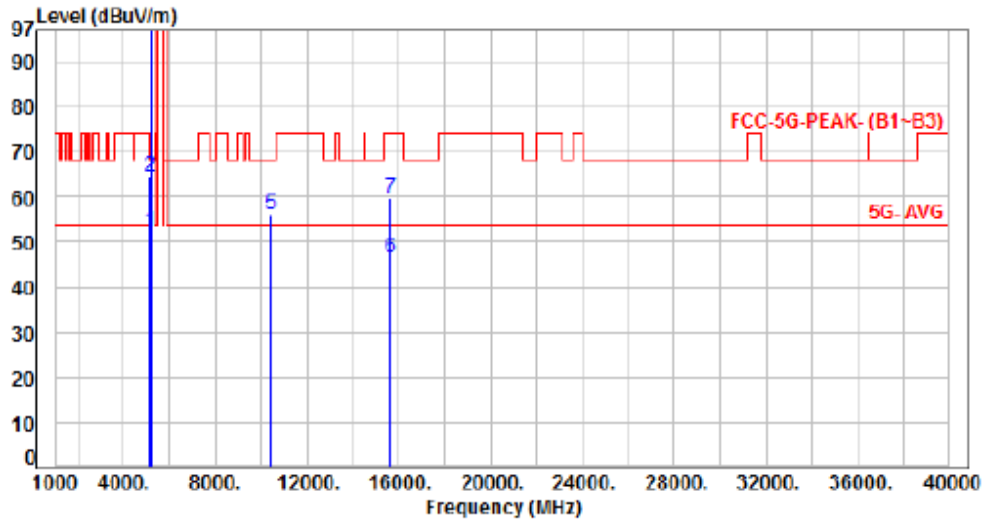

No.	Frequency (MHz)	Factor (dB)	Reading (dBuV)	Level (dBuV/m)	Limit (dBuV/m)	Margin (dB)	Detector	Height (cm)	Azimuth (deg)	P/F
1	5150.00	6.21	46.33	52.54	54.00	-1.46	Average	244	338	P
2	5150.00	6.21	58.50	64.71	74.00	-9.29	Peak	244	338	P
3	5210.00	6.44	92.91	99.35	200.00	-100.65	Average	244	338	P
4	5210.00	6.44	105.01	111.45	200.00	-88.55	Peak	244	338	P
5	10420.00	13.70	42.50	56.20	68.20	-12.00	Peak	100	23	P
6	15630.00	16.98	29.61	46.59	54.00	-7.41	Average	100	316	P
7	15630.00	16.98	42.63	59.61	74.00	-14.39	Peak	100	316	P

Note: Level=Reading+Factor
Margin=Level-Limit
Factor=Antenna Factor + cable loss - Amplifier Factor



For 22090062-TRFCC04

Non BeamForming

Power	: DC 12V From adapter (120V/60Hz)	Pol/Phase	: HORIZONTAL
Test Mode	: Mode 4, Band 1, CH42		

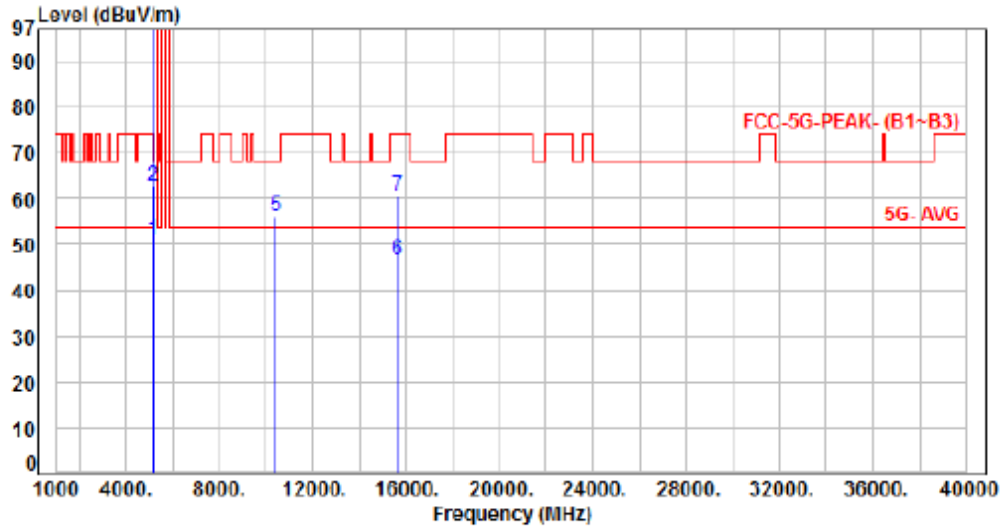

No.	Frequency (MHz)	Factor (dB)	Reading (dBuV)	Level (dBuV/m)	Limit (dBuV/m)	Margin (dB)	Detector	Height (cm)	Azimuth (deg)	P/F
1	5150.00	6.21	44.69	50.90	54.00	-3.10	Average	194	322	P
2	5150.00	6.21	56.36	62.57	74.00	-11.43	Peak	194	322	P
3	5210.00	6.44	91.74	98.18	200.00	-101.82	Average	194	322	P
4	5210.00	6.44	104.27	110.71	200.00	-89.29	Peak	194	322	P
5	10420.00	13.70	42.48	56.18	68.20	-12.02	Peak	100	77	P
6	15630.00	16.98	29.60	46.58	54.00	-7.42	Average	100	224	P
7	15630.00	16.98	43.67	60.65	74.00	-13.35	Peak	100	224	P

Note: Level=Reading+Factor
Margin=Level-Limit
Factor=Antenna Factor + cable loss - Amplifier Factor



For 22090062-TRFCC04

Non BeamForming

Power	: DC 12V From adapter (120V/60Hz)	Pol/Phase	: VERTICAL
Test Mode	: Mode 1, Band 4, CH149		:

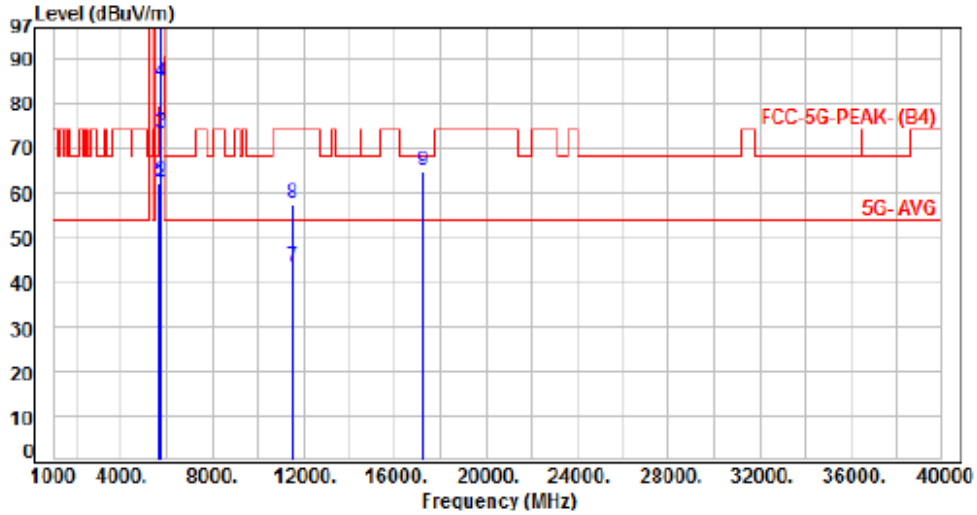

No.	Frequency (MHz)	Factor (dB)	Reading (dBUV)	Level (dBUV/m)	Limit (dBUV/m)	Margin (dB)	Detector	Height (cm)	Azimuth (deg)	P/F
1	5650.00	6.72	55.13	61.85	68.20	-6.35	Peak	205	325	P
2	5700.00	6.86	55.42	62.28	105.20	-42.92	Peak	205	325	P
3	5720.00	6.87	66.42	73.29	110.80	-37.51	Peak	205	325	P
4	5725.00	6.88	78.08	84.96	122.20	-37.24	Peak	205	325	P
5	5745.00	6.89	100.25	107.14	200.00	-92.86	Average	205	325	P
6	5745.00	6.89	110.12	117.01	200.00	-82.99	Peak	205	325	P
7	11490.00	15.37	28.32	43.69	54.00	-10.31	Average	100	138	P
8	11490.00	15.37	42.15	57.52	74.00	-16.48	Peak	100	138	P
9	17235.00	21.48	43.32	64.80	68.20	-3.40	Peak	100	54	P

Note: Level=Reading+Factor
 Margin=Level-Limit
 Factor=Antenna Factor + cable loss - Amplifier Factor



For 22090062-TRFCC04

Non BeamForming

Power	: DC 12V From adapter (120V/60Hz)	Pol/Phase	: HORIZONTAL
Test Mode	: Mode 1, Band 4, CH149		

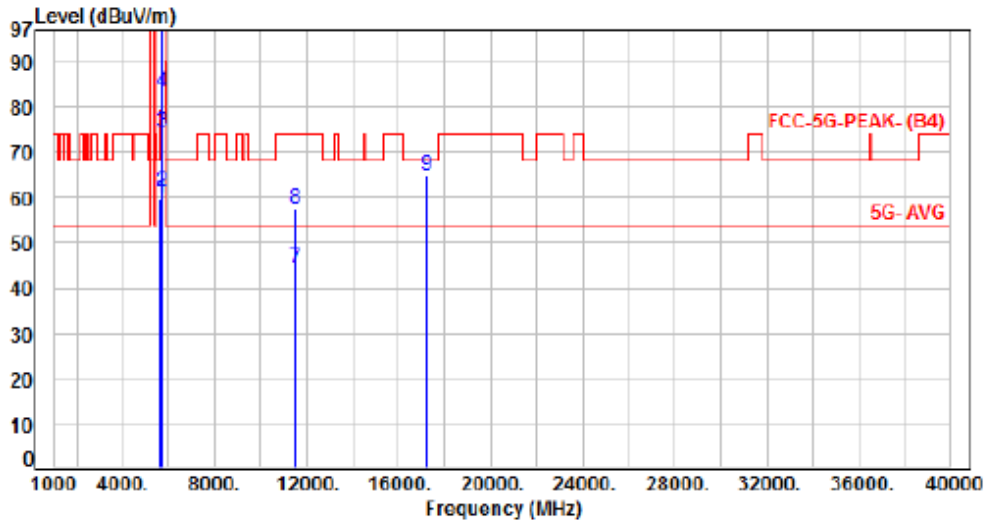

No.	Frequency (MHz)	Factor (dB)	Reading (dBuV)	Level (dBuV/m)	Limit (dBuV/m)	Margin (dB)	Detector	Height (cm)	Azimuth (deg)	P/F
1	5650.00	6.72	53.12	59.84	68.20	-8.36	Peak	176	63	P
2	5700.00	6.86	54.28	61.14	105.20	-44.06	Peak	176	63	P
3	5720.00	6.87	67.55	74.42	110.00	-36.38	Peak	176	63	P
4	5725.00	6.88	76.64	83.52	122.20	-38.68	Peak	176	63	P
5	5745.00	6.89	100.95	107.84	200.00	-92.16	Average	176	63	P
6	5745.00	6.89	110.73	117.62	200.00	-82.38	Peak	176	63	P
7	11490.00	15.37	28.73	44.10	54.00	-9.90	Average	100	48	P
8	11490.00	15.37	42.33	57.70	74.00	-16.30	Peak	100	48	P
9	17235.00	21.48	43.55	65.03	68.20	-3.17	Peak	100	295	P

Note: Level=Reading+Factor
 Margin=Level-Limit
 Factor=Antenna Factor + cable loss - Amplifier Factor



For 22090062-TRFCC04

Non BeamForming

Power	: DC 12V From adapter (120V/60Hz)	Pol/Phase	: VERTICAL
Test Mode	: Mode 1, Band 4, CH157		

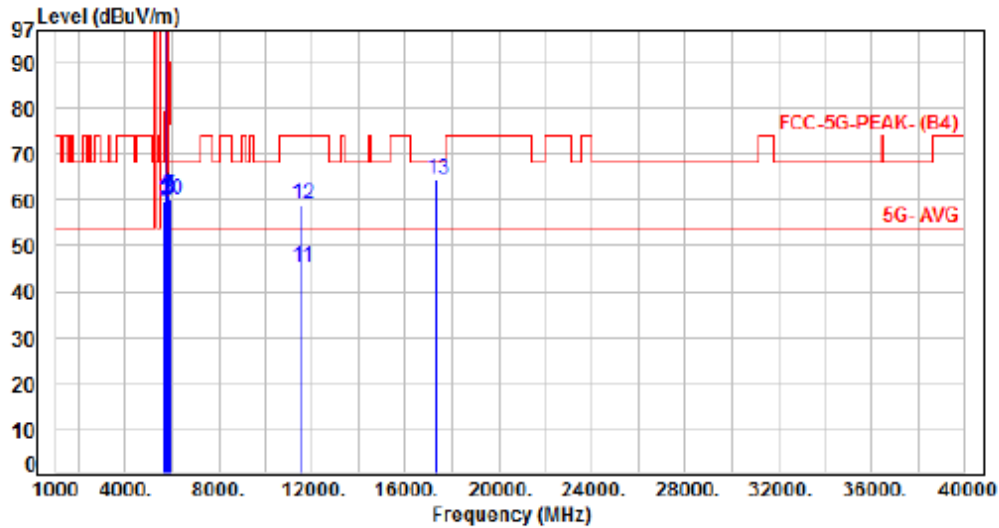

No.	Frequency (MHz)	Factor (dB)	Reading (dBuV)	Level (dBuV/m)	Limit (dBuV/m)	Margin (dB)	Detector	Height (cm)	Azimuth (deg)	P/F
1	5650.00	6.72	52.85	59.57	68.20	-8.63	Peak	248	321	P
2	5700.00	6.86	52.79	59.65	105.20	-45.55	Peak	248	321	P
3	5720.00	6.87	53.40	60.27	110.80	-50.53	Peak	248	321	P
4	5725.00	6.88	54.59	61.47	122.20	-60.73	Peak	248	321	P
5	5785.00	6.91	99.24	106.15	200.00	-93.85	Average	248	321	P
6	5785.00	6.91	108.93	115.84	200.00	-84.16	Peak	248	321	P
7	5850.00	6.86	54.00	60.86	122.20	-61.34	Peak	248	321	P
8	5855.00	6.90	53.12	60.02	110.80	-50.78	Peak	248	321	P
9	5875.00	7.03	53.39	60.42	105.20	-44.78	Peak	248	321	P
10	5925.00	7.22	53.01	60.23	68.20	-7.97	Peak	248	321	P
11	11570.00	15.62	29.73	45.35	54.00	-8.65	Average	100	112	P
12	11570.00	15.62	43.31	58.93	74.00	-15.07	Peak	100	112	P
13	17355.00	22.00	42.61	64.61	68.20	-3.59	Peak	100	86	P

Note: Level=Reading+Factor
Margin=Level-Limit
Factor=Antenna Factor + cable loss - Amplifier Factor



For 22090062-TRFCC04

Non BeamForming

Power	: DC 12V From adapter (120V/60Hz)	Pol/Phase	: HORIZONTAL
Test Mode	: Mode 1, Band 4, CH157		

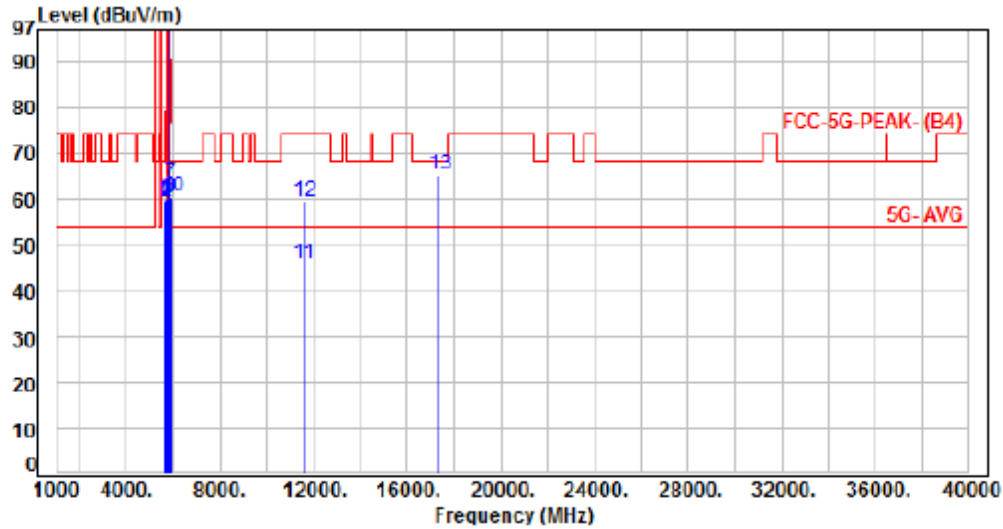

No.	Frequency (MHz)	Factor (dB)	Reading (dBuV)	Level (dBuV/m)	Limit (dBuV/m)	Margin (dB)	Detector	Height (cm)	Azimuth (deg)	P/F
1	5650.00	6.72	52.86	59.58	68.20	-8.62	Peak	100	272	P
2	5700.00	6.86	52.68	59.54	105.20	-45.66	Peak	100	272	P
3	5720.00	6.87	53.01	59.88	110.80	-50.92	Peak	100	272	P
4	5725.00	6.88	53.22	60.10	122.20	-62.10	Peak	100	272	P
5	5785.00	6.91	99.46	106.37	200.00	-93.63	Average	100	272	P
6	5785.00	6.91	109.23	116.14	200.00	-83.86	Peak	100	272	P
7	5850.00	6.86	56.48	63.34	122.20	-58.86	Peak	100	272	P
8	5855.00	6.90	53.62	60.52	110.80	-50.28	Peak	100	272	P
9	5875.00	7.03	53.21	60.24	105.20	-44.96	Peak	100	272	P
10	5925.00	7.22	53.12	60.34	68.20	-7.86	Peak	100	272	P
11	11570.00	15.62	30.11	45.73	54.00	-8.27	Average	100	183	P
12	11570.00	15.62	43.85	59.47	74.00	-14.53	Peak	100	183	P
13	17355.00	22.00	43.27	65.27	68.20	-2.93	Peak	100	91	P

Note: Level=Reading+Factor

Margin=Level-Limit

Factor=Antenna Factor + cable loss - Amplifier Factor



For 22090062-TRFCC04

Non BeamForming

Power	: DC 12V From adapter (120V/60Hz)	Pol/Phase	: VERTICAL
Test Mode	: Mode 1, Band 4, CH165		

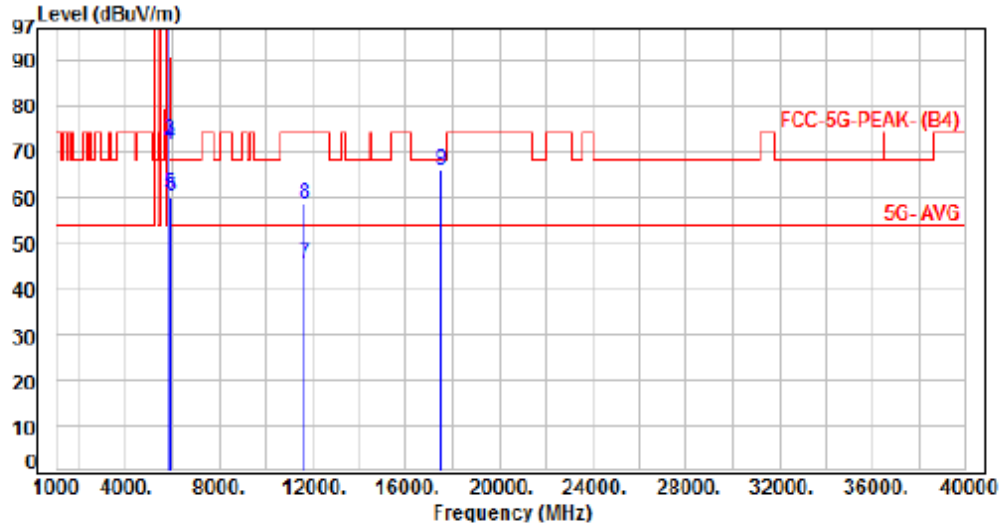

No.	Frequency (MHz)	Factor (dB)	Reading (dBuV)	Level (dBuV/m)	Limit (dBuV/m)	Margin (dB)	Detector	Height (cm)	Azimuth (deg)	P/F
1	5825.00	6.89	99.58	106.47	200.00	-93.53	Average	100	324	P
2	5825.00	6.89	109.77	116.66	200.00	-83.34	Peak	100	324	P
3	5850.00	6.86	65.68	72.54	122.20	-49.66	Peak	100	324	P
4	5855.00	6.90	64.75	71.65	110.80	-39.15	Peak	100	324	P
5	5875.00	7.03	53.75	60.78	105.20	-44.42	Peak	100	324	P
6	5925.00	7.22	53.07	60.29	68.20	-7.91	Peak	100	324	P
7	11650.00	15.79	29.57	45.36	54.00	-8.64	Average	100	131	P
8	11650.00	15.79	42.90	58.69	74.00	-15.31	Peak	100	131	P
9	17475.00	22.00	43.04	65.04	68.20	-2.36	Peak	100	84	P

Note: Level=Reading+Factor
Margin=Level-Limit
Factor=Antenna Factor + cable loss - Amplifier Factor



For 22090062-TRFCC04

Non BeamForming

Power	: DC 12V From adapter (120V/60Hz)	Pol/Phase	: HORIZONTAL
Test Mode	: Mode 1, Band 4, CH165		

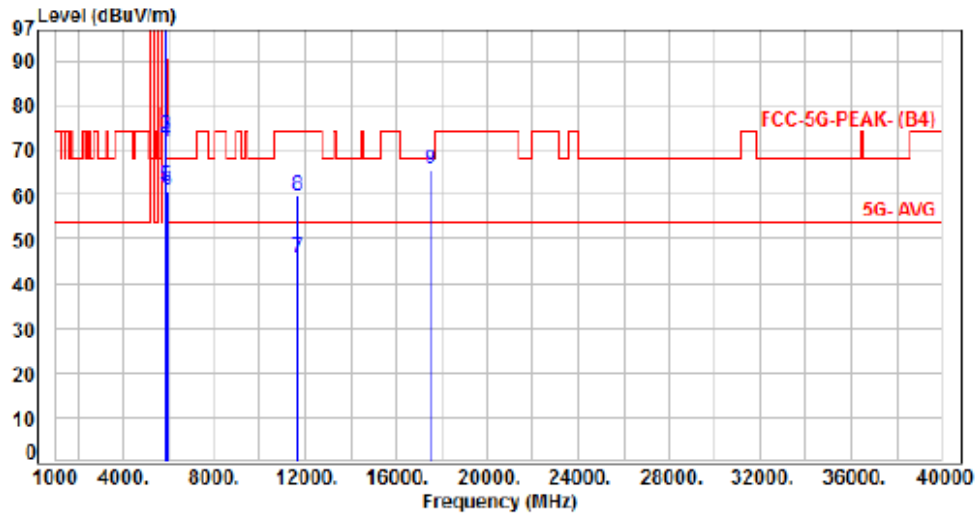

No.	Frequency (MHz)	Factor (dB)	Reading (dBuV)	Level (dBuV/m)	Limit (dBuV/m)	Margin (dB)	Detector	Height (cm)	Azimuth (deg)	P/F
1	5825.00	6.89	100.71	107.60	200.00	-92.40	Average	185	293	P
2	5825.00	6.89	110.82	117.71	200.00	-82.29	Peak	185	293	P
3	5850.00	6.86	66.40	73.26	122.20	-48.94	Peak	185	293	P
4	5855.00	6.90	65.06	71.96	110.80	-38.84	Peak	185	293	P
5	5875.00	7.03	55.00	62.11	105.20	-43.09	Peak	185	293	P
6	5925.00	7.22	53.64	60.86	68.20	-7.34	Peak	185	293	P
7	11650.00	15.79	30.03	45.82	54.00	-8.18	Average	100	188	P
8	11650.00	15.79	43.95	59.74	74.00	-14.26	Peak	100	188	P
9	17475.00	22.80	42.78	65.58	68.20	-2.62	Peak	100	97	P

Note: Level=Reading+Factor
Margin=Level-Limit
Factor=Antenna Factor + cable loss - Amplifier Factor



For 22090062-TRFCC04

Non BeamForming

Power	: DC 12V From adapter (120V/60Hz)	Pol/Phase	: VERTICAL
Test Mode	: Mode 2, Band 4, CH149		:

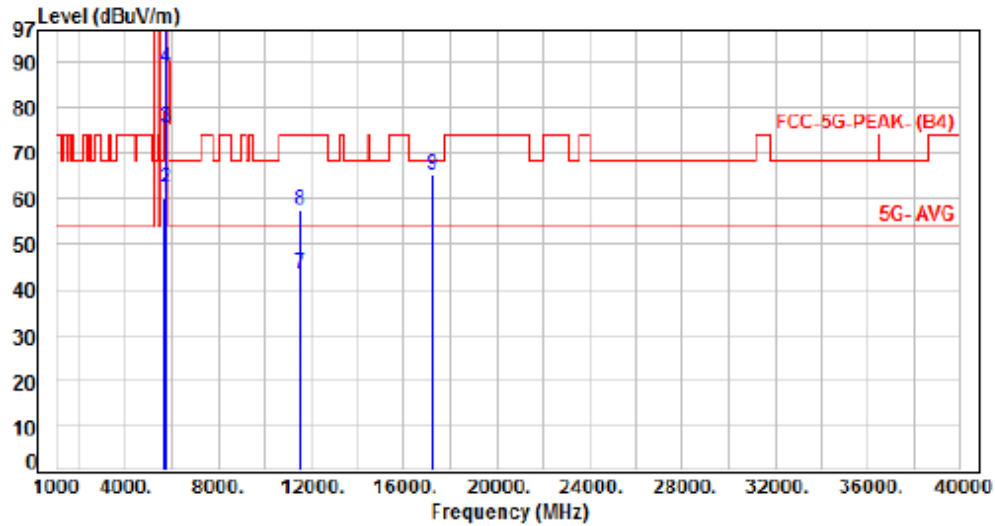

No.	Frequency (MHz)	Factor (dB)	Reading (dBuV)	Level (dBuV/m)	Limit (dBuV/m)	Margin (dB)	Detector	Height (cm)	Azimuth (deg)	P/F
1	5650.00	6.72	53.48	60.20	68.20	-8.00	Peak	244	321	P
2	5700.00	6.06	55.51	62.37	105.20	-42.83	Peak	244	321	P
3	5720.00	6.87	68.73	75.60	110.80	-35.20	Peak	244	321	P
4	5725.00	6.88	81.85	88.73	122.20	-33.47	Peak	244	321	P
5	5745.00	6.89	98.77	105.66	200.00	-94.34	Average	244	321	P
6	5745.00	6.89	112.20	119.09	200.00	-80.91	Peak	244	321	P
7	11490.00	15.37	28.01	43.38	54.00	-10.62	Average	100	69	P
8	11490.00	15.37	42.33	57.70	74.00	-16.30	Peak	100	69	P
9	17235.00	21.48	43.67	65.15	68.20	-3.05	Peak	100	297	P

Note: Level=Reading+Factor

Margin=Level-Limit

Factor=Antenna Factor + cable loss - Amplifier Factor



For 22090062-TRFCC04

Non BeamForming

Power	: DC 12V From adapter (120V/60Hz)	Pol/Phase	: HORIZONTAL
Test Mode	: Mode 2, Band 4, CH149		

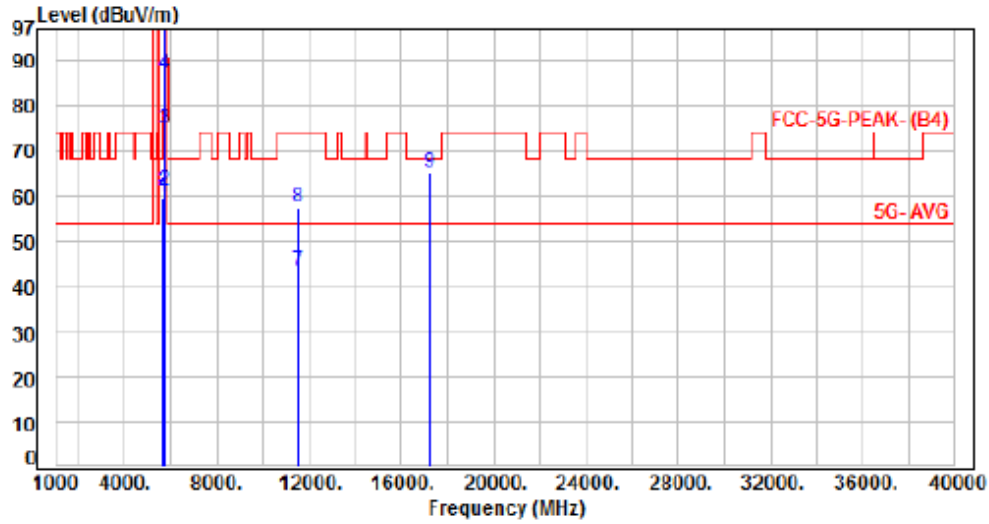

No.	Frequency (MHz)	Factor (dB)	Reading (dBuV)	Level (dBuV/m)	Limit (dBuV/m)	Margin (dB)	Detector	Height (cm)	Azimuth (deg)	P/F
1	5650.00	6.72	53.20	59.92	68.20	-8.28	Peak	221	281	P
2	5700.00	6.66	54.38	61.24	105.20	-43.96	Peak	221	281	P
3	5720.00	6.87	68.02	74.89	110.80	-35.91	Peak	221	281	P
4	5725.00	6.88	80.10	86.98	122.20	-35.22	Peak	221	281	P
5	5745.00	6.89	98.62	105.51	200.00	-94.49	Average	221	281	P
6	5745.00	6.89	111.90	118.79	200.00	-81.21	Peak	221	281	P
7	11490.00	15.37	28.02	43.39	54.00	-10.61	Average	100	59	P
8	11490.00	15.37	42.09	57.46	74.00	-16.54	Peak	100	59	P
9	17235.00	21.46	43.63	65.11	68.20	-3.09	Peak	100	341	P

Note: Level=Reading+Factor
Margin=Level-Limit
Factor=Antenna Factor + cable loss - Amplifier Factor



For 22090062-TRFCC04

Non BeamForming

Power	: DC 12V From adapter (120V/60Hz)	Pol/Phase	: VERTICAL
Test Mode	: Mode 2, Band 4, CH157		

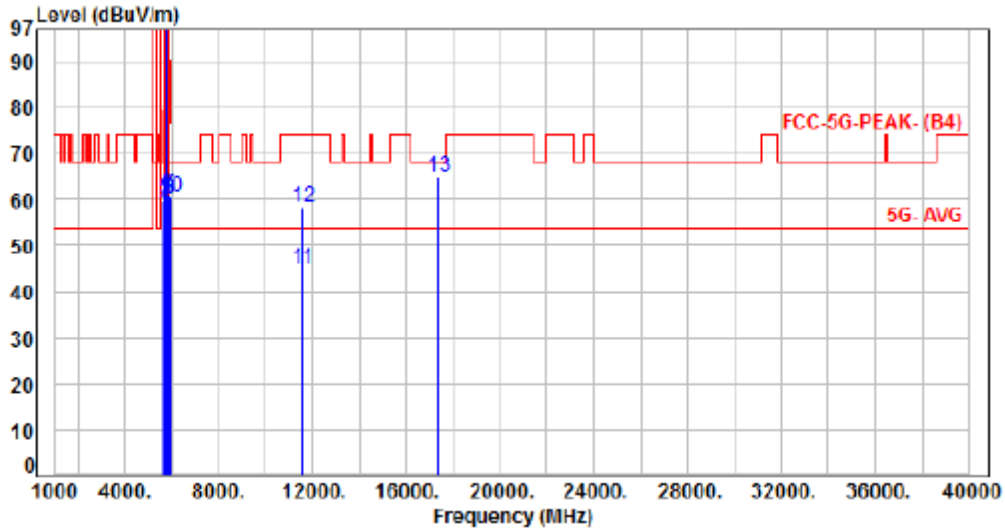

No.	Frequency (MHz)	Factor (dB)	Reading (dBuV)	Level (dBuV/m)	Limit (dBuV/m)	Margin (dB)	Detector	Height (cm)	Azimuth (deg)	P/F
1	5650.00	6.72	53.11	59.83	68.20	-8.37	Peak	108	315	P
2	5700.00	6.86	52.64	59.50	105.20	-45.70	Peak	108	315	P
3	5720.00	6.87	53.26	60.13	110.80	-50.67	Peak	108	315	P
4	5725.00	6.88	54.36	61.24	122.20	-60.96	Peak	108	315	P
5	5785.00	6.91	98.24	105.15	200.00	-94.85	Average	108	315	P
6	5785.00	6.91	111.70	118.61	200.00	-81.39	Peak	108	315	P
7	5850.00	6.86	54.34	61.20	122.20	-61.00	Peak	108	315	P
8	5855.00	6.90	53.35	60.25	110.80	-50.55	Peak	108	315	P
9	5875.00	7.03	53.14	60.17	105.20	-45.03	Peak	108	315	P
10	5925.00	7.22	53.41	60.63	68.20	-7.57	Peak	108	315	P
11	11570.00	15.62	29.42	45.04	54.00	-8.96	Average	100	89	P
12	11570.00	15.62	42.74	58.36	74.00	-15.64	Peak	100	89	P
13	17355.00	22.00	42.98	64.98	68.20	-3.22	Peak	100	306	P

Note: Level=Reading+Factor
Margin=Level-Limit
Factor=Antenna Factor + cable loss - Amplifier Factor



For 22090062-TRFCC04

Non BeamForming

Power	: DC 12V From adapter (120V/60Hz)	Pol/Phase	: HORIZONTAL
Test Mode	: Mode 2, Band 4, CH157		

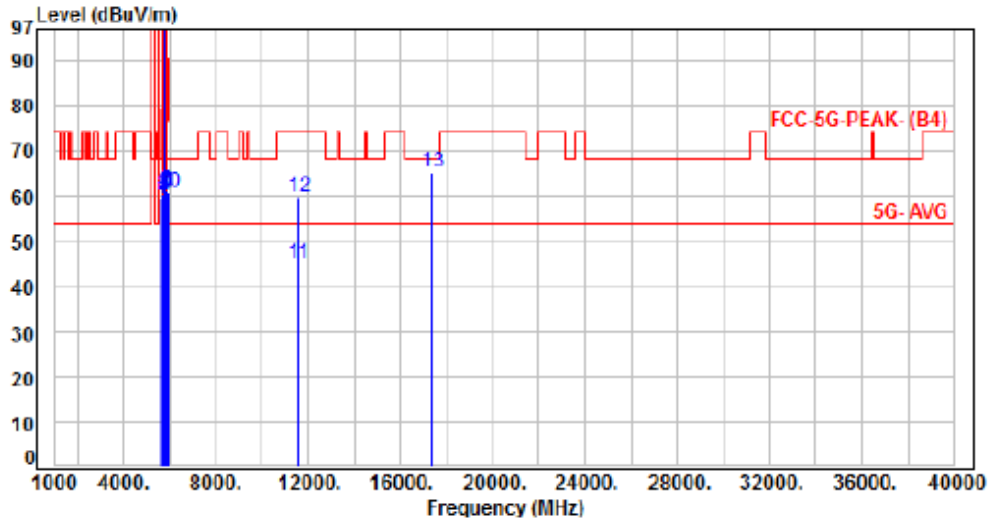

No.	Frequency (MHz)	Factor (dB)	Reading (dBuV)	Level (dBuV/m)	Limit (dBuV/m)	Margin (dB)	Detector	Height (cm)	Azimuth (deg)	P/F
1	5650.00	6.72	52.82	59.54	68.20	-8.66	Peak	205	275	P
2	5700.00	6.86	53.09	59.95	105.20	-45.25	Peak	205	275	P
3	5720.00	6.87	53.78	60.65	110.80	-50.15	Peak	205	275	P
4	5725.00	6.88	53.21	60.09	122.20	-62.11	Peak	205	275	P
5	5785.00	6.91	98.61	105.52	200.00	-94.48	Average	205	275	P
6	5785.00	6.91	112.19	119.10	200.00	-80.90	Peak	205	275	P
7	5850.00	6.86	53.90	60.76	122.20	-61.44	Peak	205	275	P
8	5855.00	6.90	54.17	61.07	110.80	-49.73	Peak	205	275	P
9	5875.00	7.03	53.60	60.63	105.20	-44.57	Peak	205	275	P
10	5925.00	7.22	53.81	61.03	68.20	-7.17	Peak	205	275	P
11	11570.00	15.62	29.29	44.91	54.00	-9.09	Average	100	81	P
12	11570.00	15.62	44.00	59.62	74.00	-14.38	Peak	100	81	P
13	17355.00	22.00	43.19	65.19	68.20	-3.01	Peak	100	216	P

Note: Level=Reading+Factor
Margin=Level-Limit
Factor=Antenna Factor + cable loss - Amplifier Factor



For 22090062-TRFCC04

Non BeamForming

Power	: DC 12V From adapter (120V/60Hz)	Pol/Phase	: VERTICAL
Test Mode	: Mode 2, Band 4, CH165		

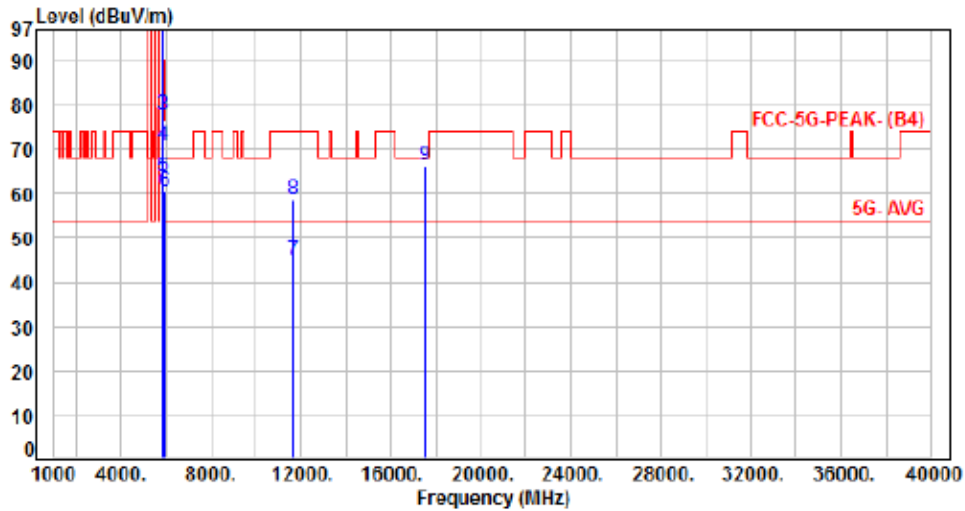

No.	Frequency (MHz)	Factor (dB)	Reading (dBuV)	Level (dBuV/m)	Limit (dBuV/m)	Margin (dB)	Detector	Height (cm)	Azimuth (deg)	P/F
1	5825.00	6.89	98.91	105.80	200.00	-94.20	Average	102	317	P
2	5825.00	6.89	111.89	118.78	200.00	-81.22	Peak	102	317	P
3	5850.00	6.86	70.97	77.83	122.20	-44.37	Peak	102	317	P
4	5855.00	6.90	63.89	70.79	110.00	-40.01	Peak	102	317	P
5	5875.00	7.03	56.64	63.67	105.20	-41.53	Peak	102	317	P
6	5925.00	7.22	53.40	60.62	68.20	-7.58	Peak	102	317	P
7	11650.00	15.79	29.32	45.11	54.00	-8.89	Average	100	88	P
8	11650.00	15.79	42.93	58.72	74.00	-15.28	Peak	100	88	P
9	17475.00	22.80	43.54	66.34	68.20	-1.86	Peak	100	199	P

Note: Level=Reading+Factor
Margin=Level-Limit
Factor=Antenna Factor + cable loss - Amplifier Factor



For 22090062-TRFCC04

Non BeamForming

Power	: DC 12V From adapter (120V/60Hz)	Pol/Phase	: HORIZONTAL
Test Mode	: Mode 2, Band 4, CH165		

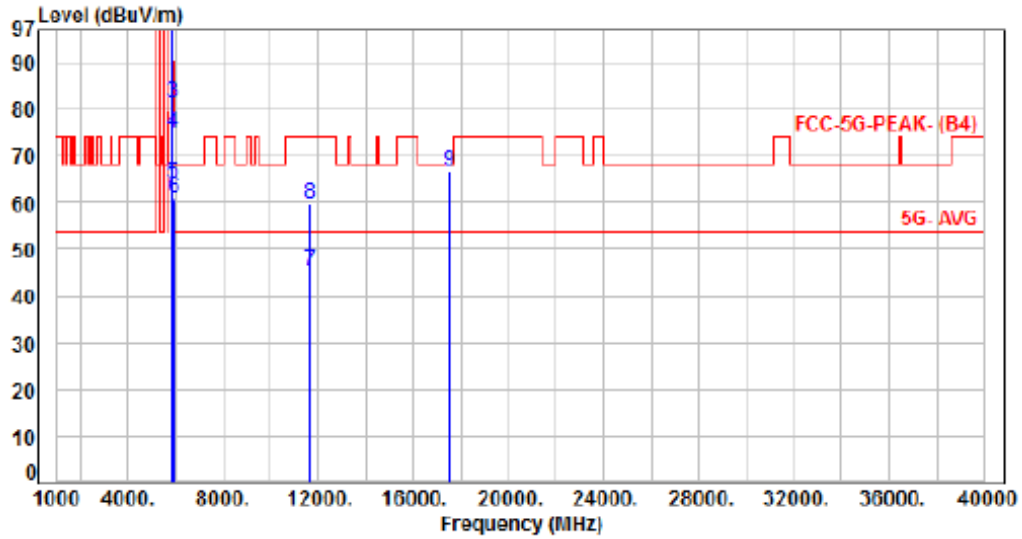

No.	Frequency (MHz)	Factor (dB)	Reading (dBuV)	Level (dBuV/m)	Limit (dBuV/m)	Margin (dB)	Detector	Height (cm)	Azimuth (deg)	P/F
1	5825.00	6.89	100.01	106.90	200.00	-93.10	Average	224	292	P
2	5825.00	6.89	113.36	120.25	200.00	-79.75	Peak	224	292	P
3	5850.00	6.86	74.50	81.36	122.20	-40.84	Peak	224	292	P
4	5855.00	6.90	67.81	74.71	110.80	-36.09	Peak	224	292	P
5	5875.00	7.03	57.04	64.07	105.20	-41.13	Peak	224	292	P
6	5925.00	7.22	53.72	60.94	68.20	-7.26	Peak	224	292	P
7	11650.00	15.79	29.70	45.49	54.00	-8.51	Average	100	167	P
8	11650.00	15.79	43.80	59.59	74.00	-14.41	Peak	100	167	P
9	17475.00	22.80	43.87	66.67	68.20	-1.53	Peak	100	77	P

Note: Level=Reading+Factor
Margin=Level-Limit
Factor=Antenna Factor + cable loss - Amplifier Factor



For 22090062-TRFCC04

Non BeamForming

Power	: DC 12V From adapter (120V/60Hz)	Pol/Phase	: VERTICAL
Test Mode	: Mode 3, Band 4, CH151		:

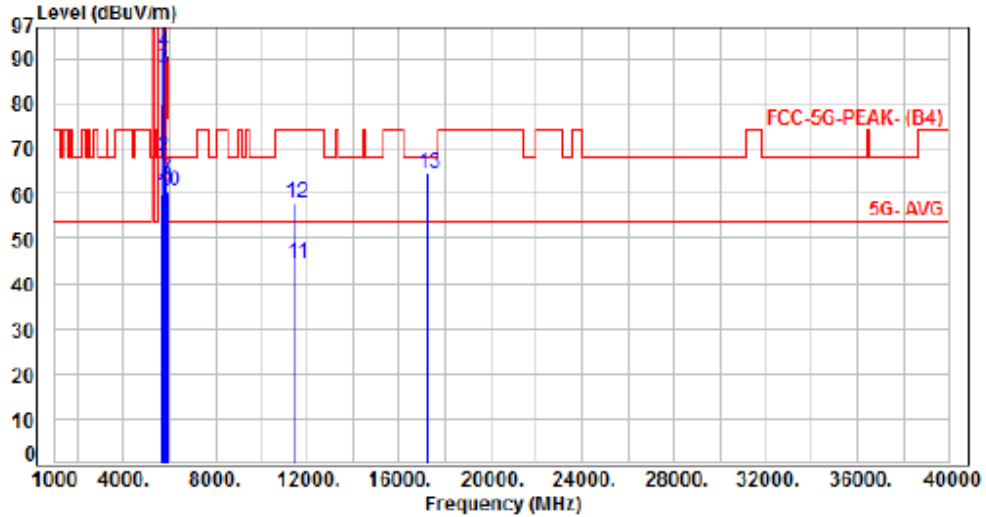

No.	Frequency (MHz)	Factor (dB)	Reading (dBuV)	Level (dBuV/m)	Limit (dBuV/m)	Margin (dB)	Detector	Height (cm)	Azimuth (deg)	P/F
1	5650.00	6.72	53.02	59.74	68.20	-8.46	Peak	100	316	P
2	5700.00	6.86	61.42	68.28	105.20	-36.92	Peak	100	316	P
3	5720.00	6.87	80.93	87.80	110.80	-23.00	Peak	100	316	P
4	5725.00	6.88	84.50	91.38	122.20	-30.82	Peak	100	316	P
5	5755.00	6.89	95.88	102.77	200.00	-97.23	Average	100	316	P
6	5755.00	6.89	108.17	115.06	200.00	-84.94	Peak	100	316	P
7	5850.00	6.86	56.05	62.91	122.20	-59.29	Peak	100	316	P
8	5855.00	6.90	54.78	61.68	110.80	-49.12	Peak	100	316	P
9	5875.00	7.03	53.62	60.65	105.20	-44.55	Peak	100	316	P
10	5925.00	7.22	53.32	60.54	68.20	-7.66	Peak	100	316	P
11	11510.00	15.44	29.21	44.65	54.00	-9.35	Average	100	63	P
12	11510.00	15.44	42.47	57.91	74.00	-16.09	Peak	100	63	P
13	17265.00	21.58	43.07	64.65	68.20	-3.55	Peak	100	298	P

Note: Level=Reading+Factor
Margin=Level-Limit
Factor=Antenna Factor + cable loss - Amplifier Factor



For 22090062-TRFCC04

Non BeamForming

Power	: DC 12V From adapter (120V/60Hz)	Pol/Phase	: HORIZONTAL
Test Mode	: Mode 3, Band 4, CH151		

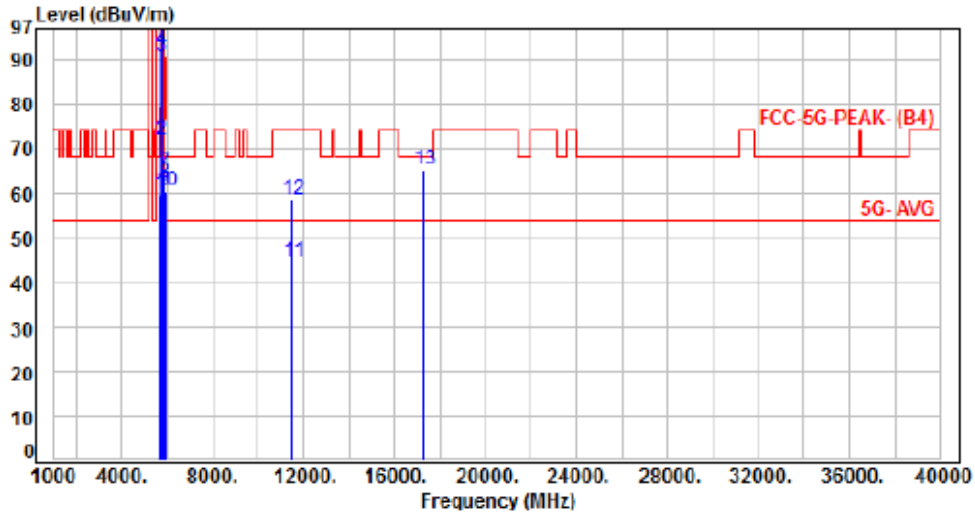

No.	Frequency (MHz)	Factor (dB)	Reading (dBuV)	Level (dBuV/m)	Limit (dBuV/m)	Margin (dB)	Detector	Height (cm)	Azimuth (deg)	P/F
1	5650.00	6.72	52.97	59.69	68.20	-8.51	Peak	242	62	P
2	5700.00	6.86	65.21	72.07	105.20	-33.13	Peak	242	62	P
3	5720.00	6.87	83.83	90.70	110.80	-20.10	Peak	242	62	P
4	5725.00	6.88	85.37	92.25	122.20	-29.95	Peak	242	62	P
5	5755.00	6.89	98.33	105.22	200.00	-94.78	Average	242	62	P
6	5755.00	6.89	110.46	117.35	200.00	-82.65	Peak	242	62	P
7	5850.00	6.86	57.86	64.72	122.20	-57.48	Peak	242	62	P
8	5855.00	6.90	55.36	62.26	110.80	-48.54	Peak	242	62	P
9	5875.00	7.03	53.55	60.58	105.20	-44.62	Peak	242	62	P
10	5925.00	7.22	53.13	60.35	68.20	-7.85	Peak	242	62	P
11	11510.00	15.44	29.19	44.63	54.00	-9.37	Average	100	28	P
12	11510.00	15.44	43.15	58.59	74.00	-15.41	Peak	100	28	P
13	17265.00	21.58	43.62	65.20	68.20	-3.00	Peak	100	258	P

Note: Level=Reading+Factor
Margin=Level-Limit
Factor=Antenna Factor + cable loss - Amplifier Factor



For 22090062-TRFCC04

Non BeamForming

Power	: DC 12V From adapter (120V/60Hz)	Pol/Phase	: VERTICAL
Test Mode	: Mode 3, Band 4, CH159		:

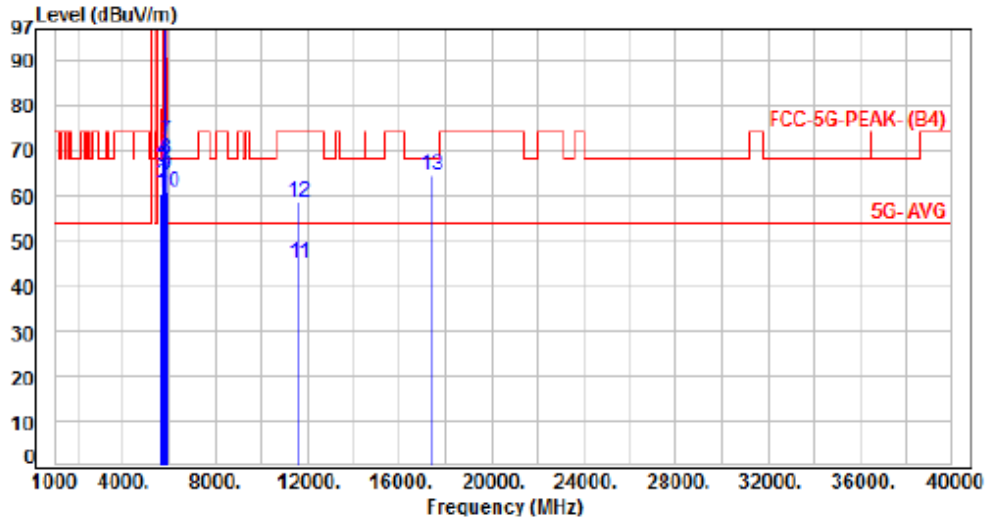

No.	Frequency (MHz)	Factor (dB)	Reading (dBuV)	Level (dBuV/m)	Limit (dBuV/m)	Margin (dB)	Detector	Height (cm)	Azimuth (deg)	P/F
1	5650.00	6.72	53.75	60.47	68.20	-7.73	Peak	226	319	P
2	5700.00	6.86	55.69	62.55	105.20	-42.65	Peak	226	319	P
3	5720.00	6.87	59.38	66.25	110.80	-44.55	Peak	226	319	P
4	5725.00	6.88	60.92	67.80	122.20	-54.40	Peak	226	319	P
5	5795.00	6.92	96.40	103.32	200.00	-96.68	Average	226	319	P
6	5795.00	6.92	109.01	115.93	200.00	-84.07	Peak	226	319	P
7	5850.00	6.86	65.49	72.35	122.20	-49.85	Peak	226	319	P
8	5855.00	6.90	61.32	68.22	110.80	-42.58	Peak	226	319	P
9	5875.00	7.03	57.47	64.50	105.20	-40.70	Peak	226	319	P
10	5925.00	7.22	53.69	60.91	68.20	-7.29	Peak	226	319	P
11	11590.00	15.67	29.14	44.81	54.00	-9.19	Average	100	79	P
12	11590.00	15.67	43.09	58.76	74.00	-15.24	Peak	100	79	P
13	17385.00	22.15	42.58	64.73	68.20	-3.47	Peak	100	213	P

Note: Level=Reading+Factor
Margin=Level-Limit
Factor=Antenna Factor + cable loss - Amplifier Factor



For 22090062-TRFCC04

Non BeamForming

Power	: DC 12V From adapter (120V/60Hz)	Pol/Phase	: HORIZONTAL
Test Mode	: Mode 3, Band 4, CH159		

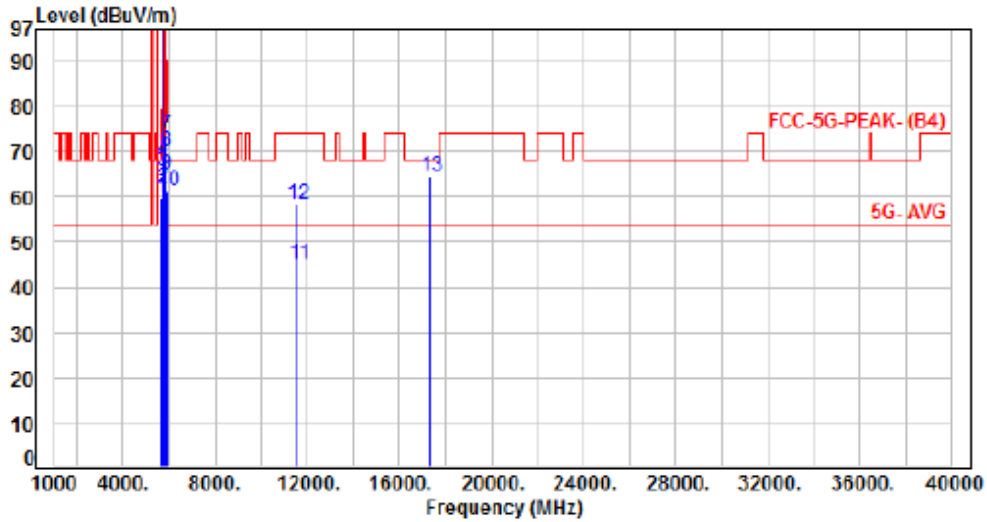

No.	Frequency (MHz)	Factor (dB)	Reading (dBuV)	Level (dBuV/m)	Limit (dBuV/m)	Margin (dB)	Detector	Height (cm)	Azimuth (deg)	P/F
1	5650.00	6.72	53.13	59.85	68.20	-8.35	Peak	179	284	P
2	5700.00	6.86	54.92	61.78	105.20	-43.42	Peak	179	284	P
3	5720.00	6.87	58.73	65.60	110.80	-45.20	Peak	179	284	P
4	5725.00	6.88	61.21	68.09	122.20	-54.11	Peak	179	284	P
5	5795.00	6.92	97.01	103.93	200.00	-96.07	Average	179	284	P
6	5795.00	6.92	109.52	116.44	200.00	-83.56	Peak	179	284	P
7	5850.00	6.86	67.07	73.93	122.20	-48.27	Peak	179	284	P
8	5855.00	6.90	63.16	70.06	110.80	-40.74	Peak	179	284	P
9	5875.00	7.03	58.07	65.10	105.20	-40.10	Peak	179	284	P
10	5925.00	7.22	53.99	61.21	68.20	-6.99	Peak	179	284	P
11	11590.00	15.67	29.26	44.93	54.00	-9.07	Average	100	32	P
12	11590.00	15.67	42.46	58.13	74.00	-15.87	Peak	100	32	P
13	17385.00	22.15	42.55	64.70	68.20	-3.50	Peak	100	297	P

Note: Level=Reading+Factor
Margin=Level-Limit
Factor=Antenna Factor + cable loss - Amplifier Factor



For 22090062-TRFCC04

Non BeamForming

Power	: DC 12V From adapter (120V/60Hz)	Pol/Phase	: VERTICAL
Test Mode	: Mode 4, Band 4, CH155		

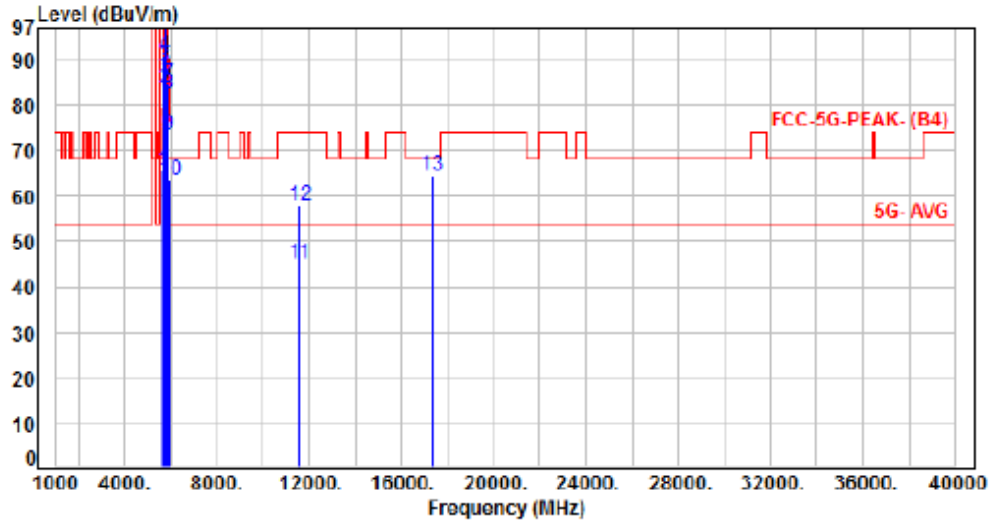

No.	Frequency (MHz)	Factor (dB)	Reading (dBuV)	Level (dBuV/m)	Limit (dBuV/m)	Margin (dB)	Detector	Height (cm)	Azimuth (deg)	P/F
1	5650.00	6.72	59.04	65.76	68.20	-2.44	Peak	242	321	P
2	5700.00	6.86	76.96	83.82	105.20	-21.38	Peak	242	321	P
3	5720.00	6.87	81.77	88.64	110.00	-22.16	Peak	242	321	P
4	5725.00	6.88	84.17	91.05	122.20	-31.15	Peak	242	321	P
5	5775.00	6.90	94.78	101.68	200.00	-98.32	Average	242	321	P
6	5775.00	6.90	107.54	114.44	200.00	-85.56	Peak	242	321	P
7	5850.00	6.86	78.12	84.98	122.20	-37.22	Peak	242	321	P
8	5855.00	6.90	75.56	82.46	110.80	-28.34	Peak	242	321	P
9	5875.00	7.03	66.36	73.39	105.20	-31.81	Peak	242	321	P
10	5925.00	7.22	56.39	63.61	68.20	-4.59	Peak	242	321	P
11	11550.00	15.56	29.36	44.92	54.00	-9.08	Average	100	56	P
12	11550.00	15.56	42.49	58.05	74.00	-15.95	Peak	100	56	P
13	17325.00	21.84	42.82	64.66	68.20	-3.54	Peak	100	251	P

Note: Level=Reading+Factor
Margin=Level-Limit
Factor=Antenna Factor + cable loss - Amplifier Factor



For 22090062-TRFCC04

Non BeamForming

Power	: DC 12V From adapter (120V/60Hz)	Pol/Phase	: HORIZONTAL
Test Mode	: Mode 4, Band 4, CH155		:

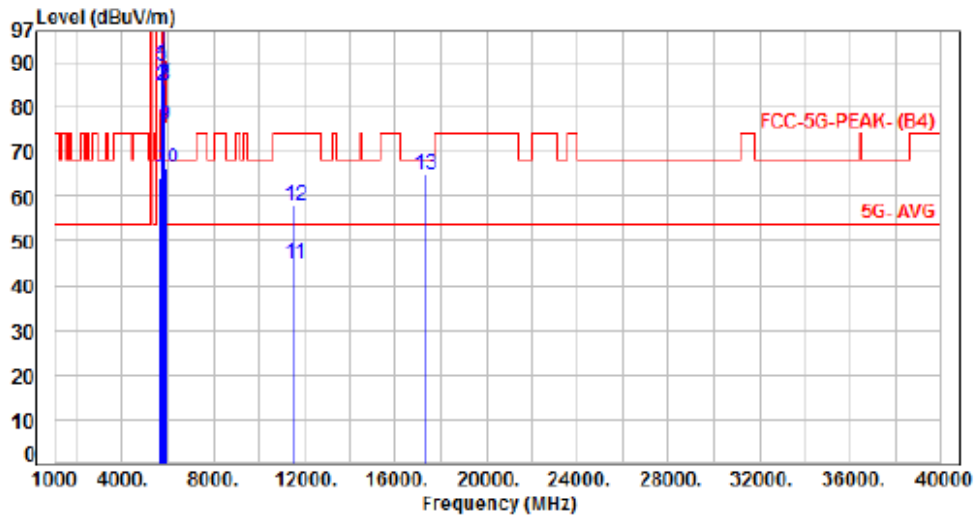

No.	Frequency (MHz)	Factor (dB)	Reading (dBUV)	Level (dBUV/m)	Limit (dBUV/m)	Margin (dB)	Detector	Height (cm)	Azimuth (deg)	P/F
1	5650.00	6.72	57.41	64.13	68.20	-4.07	Peak	100	284	P
2	5700.00	6.86	77.85	84.71	105.20	-20.49	Peak	100	284	P
3	5720.00	6.87	82.31	89.18	110.80	-21.62	Peak	100	284	P
4	5725.00	6.88	83.26	90.14	122.20	-32.06	Peak	100	284	P
5	5775.00	6.90	94.64	101.54	200.00	-98.46	Average	100	284	P
6	5775.00	6.90	106.97	113.87	200.00	-86.13	Peak	100	284	P
7	5850.00	6.86	78.33	85.19	122.20	-37.01	Peak	100	284	P
8	5855.00	6.90	77.97	84.87	110.80	-25.93	Peak	100	284	P
9	5875.00	7.03	68.79	75.82	105.20	-29.38	Peak	100	284	P
10	5925.00	7.22	59.19	66.41	68.20	-1.79	Peak	100	284	P
11	11550.00	15.56	29.30	44.86	54.00	-9.14	Average	100	73	P
12	11550.00	15.56	42.52	58.08	74.00	-15.92	Peak	100	73	P
13	17325.00	21.64	43.24	65.08	68.20	-3.12	Peak	100	224	P

Note: Level=Reading+Factor

Margin=Level-Limit

Factor=Antenna Factor + cable loss - Amplifier Factor



For 22090062-TRFCC04

BeamForming

Power	: DC 12V From adapter (120V/60Hz)	Pol/Phase	: VERTICAL
Test Mode	: Mode 5, Band 1, CH36		:

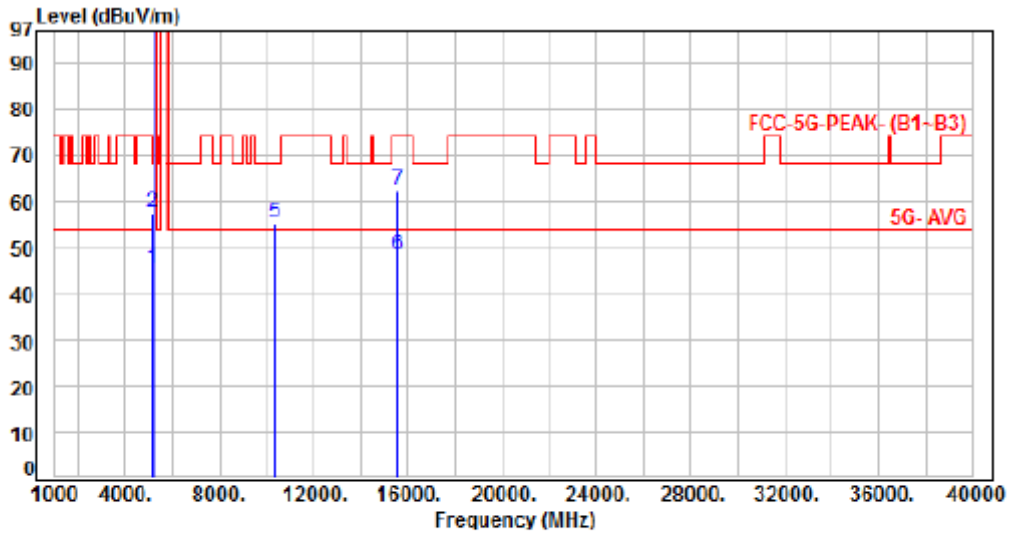

No.	Frequency (MHz)	Factor (dB)	Reading (dBuV)	Level (dBuV/m)	Limit (dBuV/m)	Margin (dB)	Detector	Height (cm)	Azimuth (deg)	P/F
1	5150.00	5.11	40.40	45.51	54.00	-8.49	Average	248	331	P
2	5150.00	5.11	52.48	57.59	74.00	-16.41	Peak	248	331	P
3	5180.00	5.13	92.87	98.00	200.00	-102.00	Average	248	331	P
4	5180.00	5.13	106.50	111.63	200.00	-88.37	Peak	248	331	P
5	10360.00	12.85	42.31	55.16	68.20	-13.04	Peak	100	307	P
6	15540.00	19.43	28.98	48.41	54.00	-5.59	Average	100	211	P
7	15540.00	19.43	42.00	62.23	74.00	-11.77	Peak	100	211	P

Note: Level=Reading+Factor
Margin=Level-Limit
Factor=Antenna Factor + cable loss - Amplifier Factor



For 22090062-TRFCC04

BeamForming

Power	: DC 12V From adapter (120V/60Hz)	Pol/Phase	: HORIZONTAL
Test Mode	: Mode 5, Band 1, CH36		

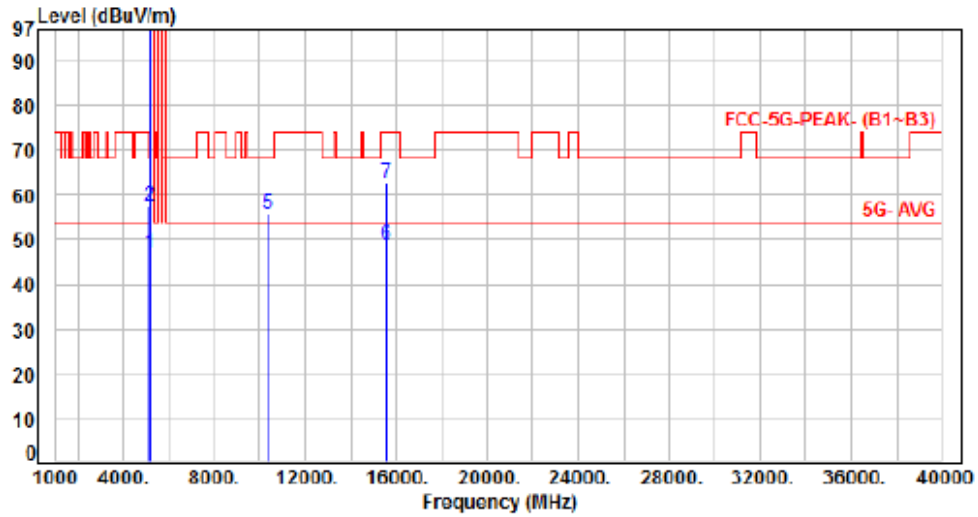

No.	Frequency (MHz)	Factor (dB)	Reading (dBuV)	Level (dBuV/m)	Limit (dBuV/m)	Margin (dB)	Detector	Height (cm)	Azimuth (deg)	P/F
1	5150.00	5.11	41.59	46.70	54.00	-7.30	Average	280	316	P
2	5150.00	5.11	52.29	57.40	74.00	-16.60	Peak	280	316	P
3	5180.00	5.13	92.40	97.53	200.00	-102.47	Average	280	316	P
4	5180.00	5.13	104.91	110.04	200.00	-89.96	Peak	280	316	P
5	10360.00	12.85	42.88	55.73	68.20	-12.47	Peak	100	333	P
6	15540.00	19.43	29.11	48.54	54.00	-5.46	Average	100	54	P
7	15540.00	19.43	43.23	62.66	74.00	-11.34	Peak	100	54	P

Note: Level=Reading+Factor
Margin=Level-Limit
Factor=Antenna Factor + cable loss - Amplifier Factor



For 22090062-TRFCC04

BeamForming

Power	:	DC 12V From adapter (120V/60Hz)	Pol/Phase	:	VERTICAL
Test Mode	:	Mode 5, Band 1, CH40		:	

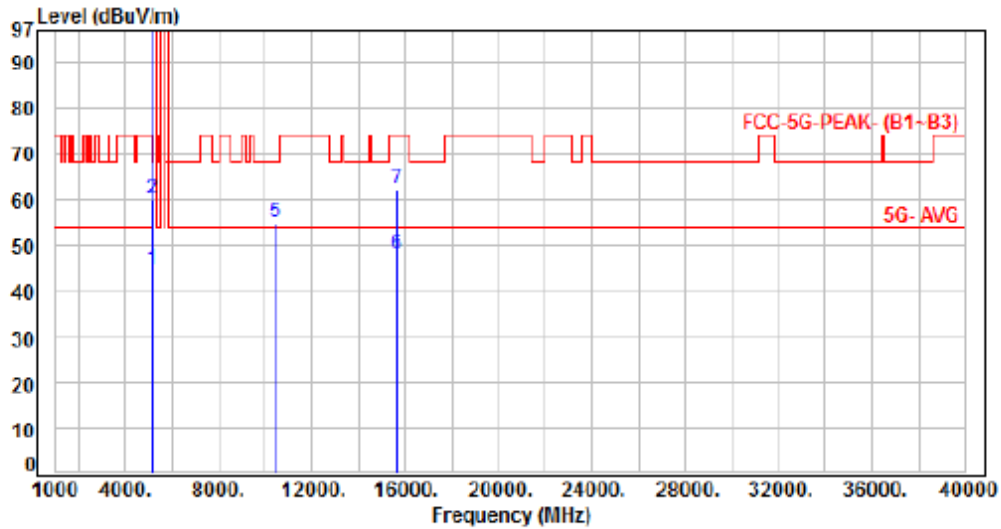

No.	Frequency (MHz)	Factor (dB)	Reading (dBuV)	Level (dBuV/m)	Limit (dBuV/m)	Margin (dB)	Detector	Height (cm)	Azimuth (deg)	P/F
1	5150.00	5.11	39.69	44.80	54.00	-9.20	Average	274	336	P
2	5150.00	5.11	55.08	60.19	74.00	-13.81	Peak	274	336	P
3	5200.00	5.14	92.72	97.86	200.00	-102.14	Average	274	336	P
4	5200.00	5.14	105.25	110.39	200.00	-89.61	Peak	274	336	P
5	10400.00	12.97	41.99	54.96	68.20	-13.24	Peak	100	85	P
6	15600.00	19.23	28.75	47.98	54.00	-6.02	Average	100	322	P
7	15600.00	19.23	43.11	62.34	74.00	-11.66	Peak	100	322	P

Note: Level=Reading+Factor
Margin=Level-Limit
Factor=Antenna Factor + cable loss - Amplifier Factor



For 22090062-TRFCC04

BeamForming

Power	: DC 12V From adapter (120V/60Hz)	Pol/Phase	: HORIZONTAL
Test Mode	: Mode 5, Band 1, CH40		

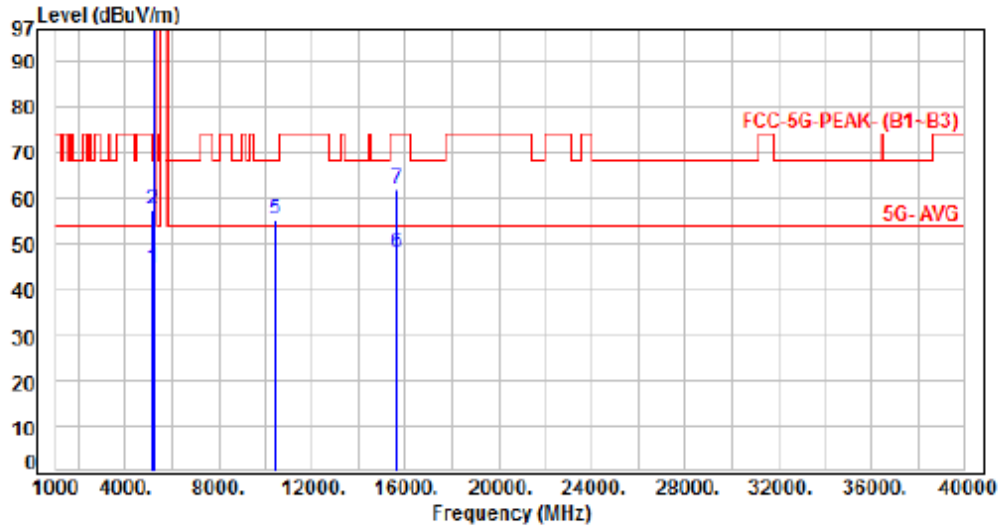

No.	Frequency (MHz)	Factor (dB)	Reading (dBuV)	Level (dBuV/m)	Limit (dBuV/m)	Margin (dB)	Detector	Height (cm)	Azimuth (deg)	P/F
1	5150.00	5.11	39.36	44.47	54.00	-9.53	Average	336	66	P
2	5150.00	5.11	52.46	57.57	74.00	-16.43	Peak	336	66	P
3	5200.00	5.14	93.84	98.98	200.00	-101.02	Average	336	66	P
4	5200.00	5.14	107.05	112.19	200.00	-87.81	Peak	336	66	P
5	10400.00	12.97	42.49	55.46	68.20	-12.74	Peak	100	308	P
6	15600.00	19.23	28.80	48.03	54.00	-5.97	Average	100	79	P
7	15600.00	19.23	42.58	61.81	74.00	-12.19	Peak	100	79	P

Note: Level=Reading+Factor
Margin=Level-Limit
Factor=Antenna Factor + cable loss - Amplifier Factor



For 22090062-TRFCC04

BeamForming

Power	: DC 12V From adapter (120V/60Hz)	Pol/Phase	: VERTICAL
Test Mode	: Mode 5, Band 1, CH48		:

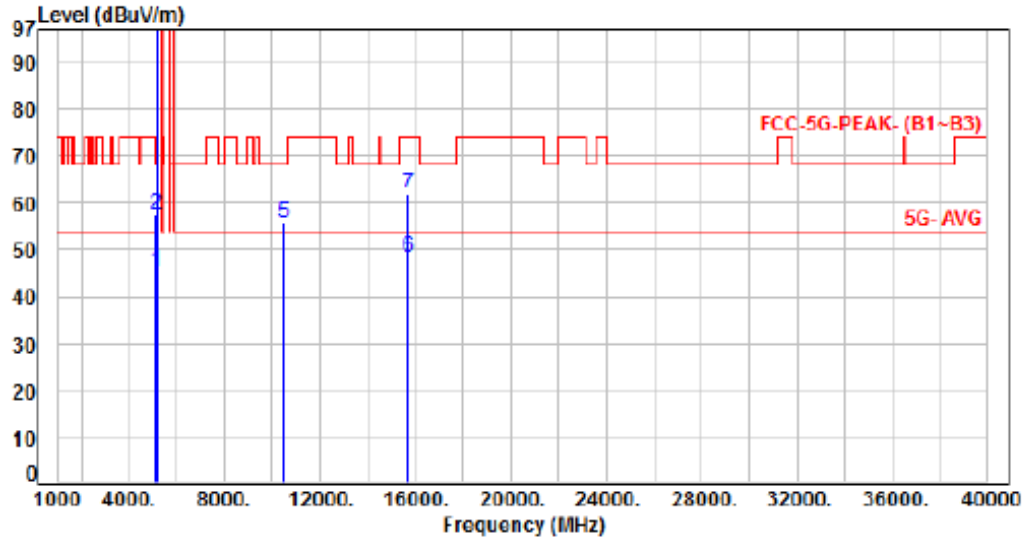

No.	Frequency (MHz)	Factor (dB)	Reading (dBuV)	Level (dBuV/m)	Limit (dBuV/m)	Margin (dB)	Detector	Height (cm)	Azimuth (deg)	P/F
1	5150.00	5.11	40.13	45.24	54.00	-8.76	Average	274	334	P
2	5150.00	5.11	52.26	57.37	74.00	-16.63	Peak	274	334	P
3	5240.00	5.10	91.92	97.02	200.00	-102.98	Average	274	334	P
4	5240.00	5.10	104.49	109.59	200.00	-90.41	Peak	274	334	P
5	10480.00	13.09	42.77	55.86	68.20	-12.34	Peak	100	116	P
6	15720.00	19.14	29.03	48.17	54.00	-5.83	Average	100	330	P
7	15720.00	19.14	42.67	61.81	74.00	-12.19	Peak	100	330	P

Note: Level=Reading+Factor
Margin=Level-Limit
Factor=Antenna Factor + cable loss - Amplifier Factor



For 22090062-TRFCC04

BeamForming

Power	: DC 12V From adapter (120V/60Hz)	Pol/Phase	: HORIZONTAL
Test Mode	: Mode 5, Band 1, CH48		

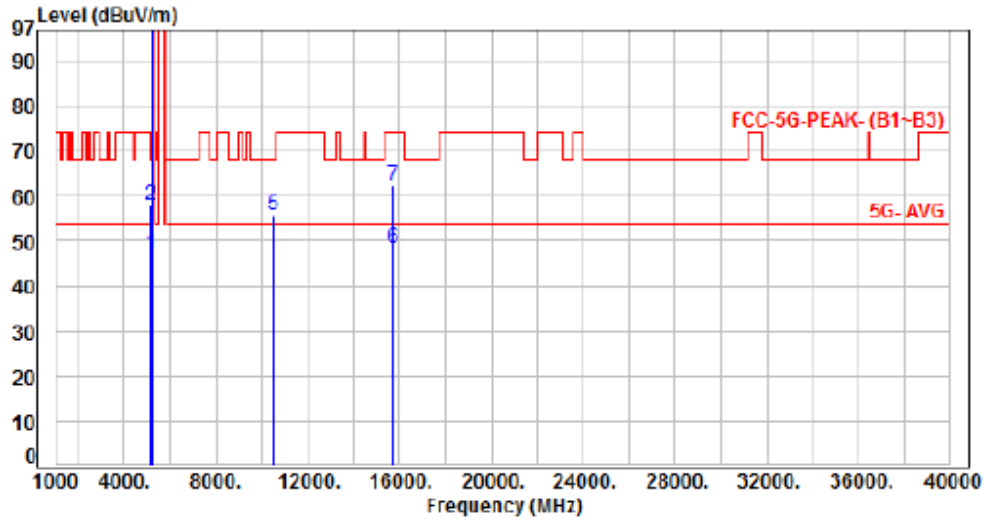

No.	Frequency (MHz)	Factor (dB)	Reading (dBuV)	Level (dBuV/m)	Limit (dBuV/m)	Margin (dB)	Detector	Height (cm)	Azimuth (deg)	P/F
1	5150.00	5.11	42.16	47.27	54.00	-6.73	Average	367	61	P
2	5150.00	5.11	52.65	57.77	74.00	-16.23	Peak	367	61	P
3	5240.00	5.10	92.00	97.10	200.00	-102.90	Average	367	61	P
4	5240.00	5.10	104.57	109.67	200.00	-90.33	Peak	367	61	P
5	10480.00	13.09	42.77	55.86	68.20	-12.34	Peak	100	79	P
6	15720.00	19.14	29.03	48.17	54.00	-5.83	Average	100	134	P
7	15720.00	19.14	43.36	62.50	74.00	-11.50	Peak	100	134	P

Note: Level=Reading+Factor
 Margin=Level-Limit
 Factor=Antenna Factor + cable loss - Amplifier Factor



For 22090062-TRFCC04

BeamForming

Power	:	DC 12V From adapter (120V/60Hz)	Pol/Phase	:	VERTICAL
Test Mode	:	Mode 6, Band 1, CH38		:	

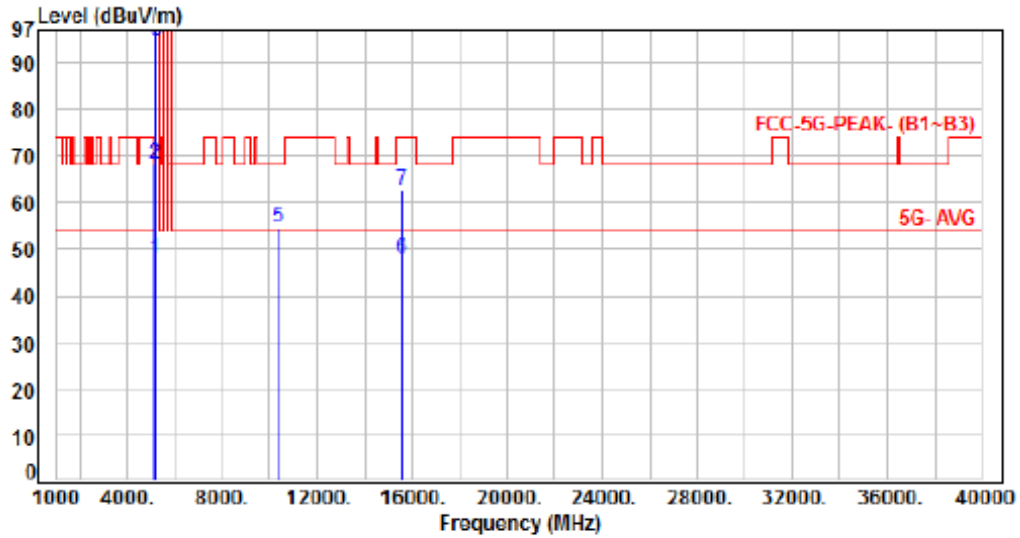

No.	Frequency (MHz)	Factor (dB)	Reading (dBuV)	Level (dBuV/m)	Limit (dBuV/m)	Margin (dB)	Detector	Height (cm)	Azimuth (deg)	P/F
1	5150.00	5.11	42.92	48.03	54.00	-5.97	Average	260	332	P
2	5150.00	5.11	63.15	68.26	74.00	-5.74	Peak	260	332	P
3	5190.00	5.14	89.63	94.77	200.00	-105.23	Average	260	332	P
4	5190.00	5.14	101.65	106.79	200.00	-93.21	Peak	260	332	P
5	10380.00	12.92	41.73	54.65	68.20	-13.55	Peak	100	55	P
6	15570.00	19.33	28.80	48.13	54.00	-5.87	Average	100	264	P
7	15570.00	19.33	43.22	62.55	74.00	-11.45	Peak	100	264	P

Note: Level=Reading+Factor
Margin=Level-Limit
Factor=Antenna Factor + cable loss - Amplifier Factor



For 22090062-TRFCC04

BeamForming

Power	: DC 12V From adapter (120V/60Hz)	Pol/Phase	: HORIZONTAL
Test Mode	: Mode 6, Band 1, CH38		

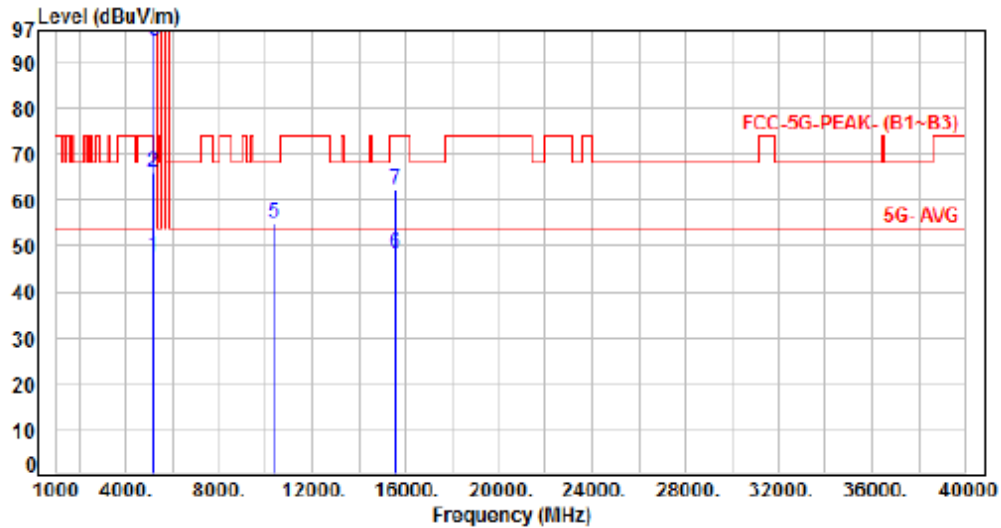

No.	Frequency (MHz)	Factor (dB)	Reading (dBuV)	Level (dBuV/m)	Limit (dBuV/m)	Margin (dB)	Detector	Height (cm)	Azimuth (deg)	P/F
1	5150.00	5.11	42.44	47.55	54.00	-6.45	Average	376	74	P
2	5150.00	5.11	60.87	65.98	74.00	-8.02	Peak	376	74	P
3	5190.00	5.14	89.76	94.90	200.00	-105.10	Average	376	74	P
4	5190.00	5.14	102.59	107.73	200.00	-92.27	Peak	376	74	P
5	10380.00	12.92	42.10	55.02	68.20	-13.18	Peak	100	91	P
6	15570.00	19.33	28.95	48.28	54.00	-5.72	Average	100	331	P
7	15570.00	19.33	43.17	62.50	74.00	-11.50	Peak	100	331	P

Note: Level=Reading+Factor
 Margin=Level-Limit
 Factor=Antenna Factor + cable loss - Amplifier Factor



For 22090062-TRFCC04

BeamForming

Power	:	DC 12V From adapter (120V/60Hz)	Pol/Phase	:	VERTICAL
Test Mode	:	Mode 6, Band 1, CH46		:	

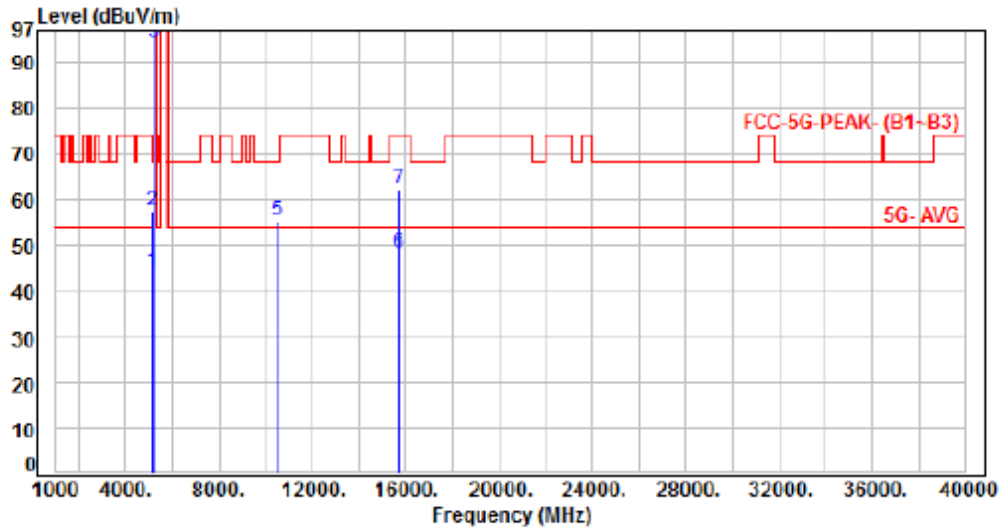

No.	Frequency (MHz)	Factor (dB)	Reading (dBuV)	Level (dBuV/m)	Limit (dBuV/m)	Margin (dB)	Detector	Height (cm)	Azimuth (deg)	P/F
1	5150.00	5.11	39.26	44.37	54.00	-9.63	Average	100	302	P
2	5150.00	5.11	52.27	57.38	74.00	-16.62	Peak	100	302	P
3	5230.00	5.12	89.16	94.28	200.00	-105.72	Average	100	302	P
4	5230.00	5.12	101.15	106.27	200.00	-93.73	Peak	100	302	P
5	10460.00	13.06	42.38	55.44	68.20	-12.76	Peak	100	48	P
6	15690.00	19.11	29.12	48.23	54.00	-5.77	Average	100	294	P
7	15690.00	19.11	43.16	62.27	74.00	-11.73	Peak	100	294	P

Note: Level=Reading+Factor
Margin=Level-Limit
Factor=Antenna Factor + cable loss - Amplifier Factor



For 22090062-TRFCC04

BeamForming

Power	: DC 12V From adapter (120V/60Hz)	Pol/Phase	: HORIZONTAL
Test Mode	: Mode 6, Band 1, CH46		

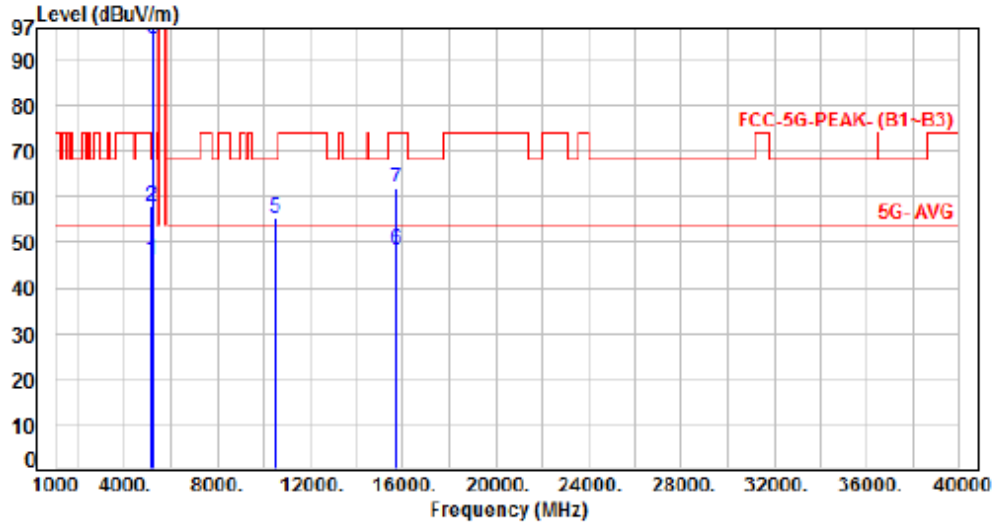

No.	Frequency (MHz)	Factor (dB)	Reading (dBuV)	Level (dBuV/m)	Limit (dBuV/m)	Margin (dB)	Detector	Height (cm)	Azimuth (deg)	P/F
1	5150.00	5.11	41.13	46.24	54.00	-7.76	Average	392	84	P
2	5150.00	5.11	52.87	57.98	74.00	-16.02	Peak	392	84	P
3	5230.00	5.12	89.49	94.61	200.00	-105.39	Average	392	84	P
4	5230.00	5.12	102.43	107.55	200.00	-92.45	Peak	392	84	P
5	10460.00	13.06	42.23	55.29	68.20	-12.91	Peak	100	92	P
6	15690.00	19.11	29.11	48.22	54.00	-5.78	Average	100	319	P
7	15690.00	19.11	42.90	62.01	74.00	-11.99	Peak	100	319	P

Note: Level=Reading+Factor
 Margin=Level-Limit
 Factor=Antenna Factor + cable loss - Amplifier Factor



For 22090062-TRFCC04

BeamForming

Power	: DC 12V From adapter (120V/60Hz)	Pol/Phase	: VERTICAL
Test Mode	: Mode 7, Band 1, CH42		

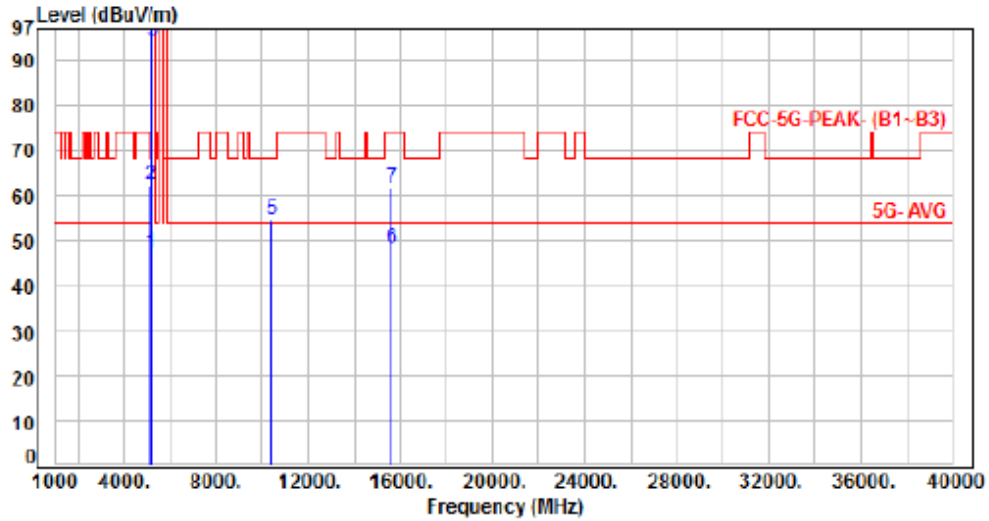

No.	Frequency (MHz)	Factor (dB)	Reading (dBuV)	Level (dBuV/m)	Limit (dBuV/m)	Margin (dB)	Detector	Height (cm)	Azimuth (deg)	P/F
1	5150.00	5.11	42.03	47.14	54.00	-6.86	Average	210	331	P
2	5150.00	5.11	57.32	62.43	74.00	-11.57	Peak	210	331	P
3	5210.00	5.14	89.25	94.39	200.00	-105.61	Average	210	331	P
4	5210.00	5.14	101.51	106.65	200.00	-93.35	Peak	210	331	P
5	10420.00	13.00	41.54	54.54	68.20	-13.66	Peak	100	77	P
6	15630.00	19.18	29.08	48.26	54.00	-5.74	Average	100	297	P
7	15630.00	19.18	42.47	61.65	74.00	-12.35	Peak	100	297	P

Note: Level=Reading+Factor
 Margin=Level-Limit
 Factor=Antenna Factor + cable loss - Amplifier Factor



For 22090062-TRFCC04

BeamForming

Power	: DC 12V From adapter (120V/60Hz)	Pol/Phase	: HORIZONTAL
Test Mode	: Mode 7, Band 1, CH42		

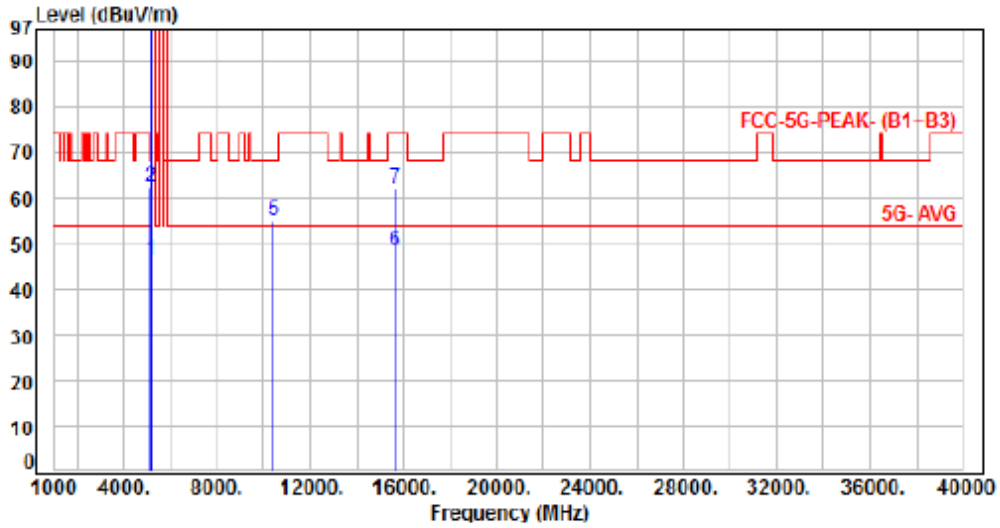

No.	Frequency (MHz)	Factor (dB)	Reading (dBUV)	Level (dBUV/m)	Limit (dBUV/m)	Margin (dB)	Detector	Height (cm)	Azimuth (deg)	P/F
1	5150.00	5.11	41.51	46.62	54.00	-7.38	Average	400	68	P
2	5150.00	5.11	57.32	62.43	74.00	-11.57	Peak	400	68	P
3	5210.00	5.14	93.33	98.47	200.00	-101.53	Average	400	68	P
4	5210.00	5.14	101.45	106.59	200.00	-93.41	Peak	400	68	P
5	10420.00	13.00	41.85	54.85	68.20	-13.35	Peak	100	86	P
6	15630.00	19.18	28.96	48.14	54.00	-5.86	Average	100	188	P
7	15630.00	19.18	42.84	62.02	74.00	-11.98	Peak	100	188	P

Note: Level=Reading+Factor
Margin=Level-Limit
Factor=Antenna Factor + cable loss - Amplifier Factor



For 22090062-TRFCC04

BeamForming

Power	:	DC 12V From adapter (120V/60Hz)	Pol/Phase	:	VERTICAL
Test Mode	:	Mode 5, Band 4, CH149		:	

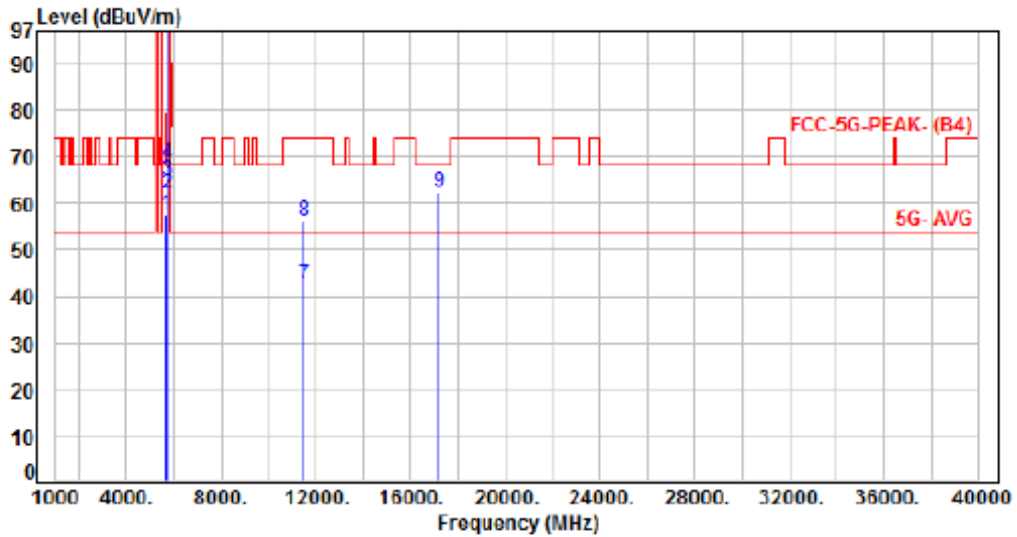

No.	Frequency (MHz)	Factor (dB)	Reading (dBuV)	Level (dBuV/m)	Limit (dBuV/m)	Margin (dB)	Detector	Height (cm)	Azimuth (deg)	P/F
1	5650.00	6.12	51.49	57.61	68.20	-10.59	Peak	109	311	P
2	5700.00	6.56	55.46	62.02	105.20	-43.18	Peak	109	311	P
3	5720.00	6.61	58.41	65.02	110.00	-45.78	Peak	109	311	P
4	5725.00	6.63	62.15	68.78	122.20	-53.42	Peak	109	311	P
5	5745.00	6.68	89.54	96.22	200.00	-103.78	Average	109	311	P
6	5745.00	6.68	102.68	109.36	200.00	-90.64	Peak	109	311	P
7	11490.00	15.21	27.03	42.24	54.00	-11.76	Average	100	42	P
8	11490.00	15.21	40.91	56.12	74.00	-17.88	Peak	100	42	P
9	17235.00	19.01	42.55	62.46	68.20	-5.74	Peak	100	299	P

Note: Level=Reading+Factor
Margin=Level-Limit
Factor=Antenna Factor + cable loss - Amplifier Factor