



# FCC RADIO TEST REPORT

Applicant : LITE-ON Technology Corp

---

Address : Bldg. C, 90, Chien 1 Rd., Chung-Ho, New Taipei City,  
23585, Taiwan

---

Equipment : Access Point

---

Model No. : WPX8324, WRX8324, WPA-2

---

Trade Name : LITEON, PoEWit

---

FCC ID : PPQ-WPX8324

---

## I HEREBY CERTIFY THAT :

The sample was received on Oct. 03, 2022 and the testing was completed on Oct. 24, 2022 at CerpPASS Technology Corp. The test result refers exclusively to the test presented test model / sample. Without written approval of CerpPASS Technology Corp., the test report shall not be reproduced except in full.

Approved by:

Mark Liao / Supervisor

Laboratory Accreditation:

CerpPASS Technology Corporation Test Laboratory





CONTENTS

- 1. **Summary of Test Procedure and Test Results .....5**
  - 1.1 Applicable Standards .....5
- 2. **Test Configuration of Equipment under Test .....6**
  - 2.1 Feature of Equipment under Test.....6
  - 2.2 Carrier Frequency of Channes.....8
  - 2.3 Test Mode & Test Software .....9
  - 2.4 Description of Test System.....10
  - 2.5 General Information of Test.....11
  - 2.6 Measurement Uncertainty .....12
- 3. **Test Equipment and Ancillaries Used for Tests .....13**
- 4. **Antenna Requirements.....15**
  - 4.1 Standard Applicable .....15
  - 4.2 Antenna Construction and Directional Gain.....15
- 5. **Frequency Hopping System Requirements .....16**
  - 5.1 Frequency Hopping Requirement .....16
  - 5.2 EUT Hopping System.....17
  - 5.3 Pseudorandom Frequency Hopping Sequence .....17
- 6. **Test of AC Power Line Conducted Emission .....18**
  - 6.1 Test Limit .....18
  - 6.2 Test Procedures .....18
  - 6.3 Typical Test Setup .....19
  - 6.4 Test Result and Data .....20
  - 6.5 Test Photographs .....22
- 7. **Test of Radiated Spurious Emission.....24**
  - 7.1 Test Limit .....24
  - 7.2 Test Procedures.....25
  - 7.3 Typical Test Setup .....26
  - 7.4 Test Result and Data (9kHz ~ 30MHz) .....27
  - 7.5 Test Result and Data (30MHz ~ 1GHz) .....27
  - 7.6 Test Result and Data (1GHz ~ 25GHz).....29
  - 7.7 Restricted Bands of Operation .....41
  - 7.8 Test Photographs (30MHz ~ 1GHz).....42
  - 7.9 Test Photographs (1GHz ~ 25GHz) .....43
- 8. **Test of Conducted Spurious Emission .....45**
  - 8.1 Test Limit .....45
  - 8.2 Test Procedure .....45
  - 8.3 Test Setup Layout .....45
  - 8.4 Test Result and Data .....45
- 9. **20dB Bandwidth Measurement Data .....53**
  - 9.1 Test Limit .....53
  - 9.2 Test Procedures .....53
  - 9.3 Test Setup Layout .....53



9.4 Test Result and Data .....53

**10. Carrier Frequency Separation .....56**

10.1 Test Limit .....56

10.2 Test Procedures .....56

10.3 Test Setup Layout .....56

10.4 Test Result and Data .....56

**11. Dwell Time on each channel .....59**

11.1 Test Limit .....59

11.2 Test Procedures .....59

11.3 Test Setup Layout .....59

11.4 Test Result and Data .....60

**12. Number of Hopping Channels .....63**

12.1 Test Limit .....63

12.2 Test Procedures .....63

12.3 Test Setup Layout .....63

12.4 Test Result and Data .....63

**13. Maximum Average Output Power .....65**

13.1 Test Limit .....65

13.2 Test Procedures .....65

13.3 Test Setup Layout .....65

13.4 Test Result and Data .....65

**14. Radio Frequency Exposure .....66**

14.1 Applicable Standards .....66

14.2 EUT Specification.....66

14.3 Result .....66





# 1. Summary of Test Procedure and Test Results

## 1.1 Applicable Standards

**ANSI C63.10:2013**

**FCC Rules and Regulations Part 15 Subpart C §15.247**

| FCC Rule         | Description of Test                      | Result |
|------------------|--|--------|
| 15.203           | . Antenna Requirement                    | PASS   |
| 15.247(a)(1)     | .Pseudorandom Frequency Hopping Sequence | PASS   |
| 15.207           | . AC Power Line Conducted Emission       | PASS   |
| 15.209<br>15.205 | . Radiated Spurious Emission             | PASS   |
| 15.247(d)        | . Conducted Spurious Emission            | PASS   |
| 15.247(a)(1)     | . Channel Carrier Frequencies Separation | PASS   |
| 15.247(a)(1)     | . 20dB Bandwidth                         | PASS   |
| 15.247(a)(1)     | . Dwell Time                             | PASS   |
| 15.247(b)        | . Number of Hopping Channels             | PASS   |
| 15.247(b)        | . Output Power                           | PASS   |
| 2.1091           | . Radio Frequency Exposure               | PASS   |

\* The lab has reduced the uncertainty risk factor from test equipment, environment and staff technicians which according to the standard on contract. Therefore, the test result will only be determined by standard requirement.

\*This EUT has been also tested and compiled with the requirement of FCC Part 15, Subpart B, recorded in a separate test report(22090062-TEFV01).



## 2. Test Configuration of Equipment under Test

### 2.1 Feature of Equipment under Test

|                           |   |
|---------------------------|---|
| Operation Frequency Range | BT / BLE: 2400-2483.5MHz<br>802.11b/g/n(TurboQAM)/ax: 2400-2483.5MHz<br>802.11a/n/ac/ax: 5150-5250MHz, 5725-5850MHz   |
| Center Frequency Range    | BT / BLE: 2402-2480MHz<br>802.11b/g/n(TurboQAM)/ax: 2412-2462MHz<br>802.11a/n/ac/ax: 5180-5240MHz, 5745-5825MHz   |
| Modulation Type           | BT: GFSK, $\pi/4$ -DQPSK, 8DPSK<br>BLE: GFSK<br>WLAN:<br>2.4GHz:<br>802.11b: CCK, DQPSK, DBPSK<br>802.11g/n: BPSK, QPSK, 16QAM, 64QAM, 256QAM(TurboQAM)<br>802.11ax: BPSK, QPSK, 16QAM, 64QAM, 256QAM, 1024QAM<br>5GHz:<br>802.11n/a: BPSK, QPSK, 16QAM, 64QAM<br>802.11ac: BPSK, QPSK, 16QAM, 64QAM, 256QAM<br>802.11ax: BPSK, QPSK, 16QAM, 64QAM, 256QAM,1024QAM  |
| Modulation Technology     | DSSS, OFDM, FHSS, DTS, OFDMA  |
| Data Rate                 | BT:<br>GFSK: 1Mbps, $\pi/4$ -DQPSK: 2Mbps, 8DPSK: 3Mbps<br>BLE:<br>GFSK: 1Mbps, 2Mbps<br>WLAN:<br>2.4GHz:<br>802.11b: 1, 2, 5.5, 11Mbps<br>802.11g: 6, 9, 12, 18, 24, 36, 48, 54Mbps<br>802.11n: MCS0 – MCS15, HT20/40<br>MCS0 – MCS9, VHT20/40(TurboQAM)<br>802.11ax: MCS0 – MCS11,HE20/40<br>5GHz:<br>802.11a: 6, 9, 12, 18, 24, 36, 48, 54Mbps<br>802.11n: MCS0 – MCS15, HT20/40<br>802.11ac: MCS0 – MCS9, VHT20/40/80<br>802.11ax: MCS0 – MCS11, HE20/40/80 |
| Antenna Type              | For BT / BLE:PCB Antenna<br>For WLAN:PIFA Antenna   |
| Antenna Gain              | For BT / BLE:<br>2400-2500MHz: ANT 3:2.55dBi<br>For WLAN:<br>2400-2500MHz: ANT 1: 3.96dBi, ANT 2: 3.52dBi<br>5150-5250MHz: ANT 1: 4.76dBi, ANT 2: 4.37dBi<br>5725-5850MHz: ANT 1: 4.73dBi, ANT 2: 3.72dBi   |

Note:

1. WLAN 2.4G 802.11n Support TurboQAM.
2. EUT support TPC Function.
3. Wifi 2.4G+BT and wifi 5G+BT can simultaneously transmission.
4. EUT support AP Master Mode.
5. 802.11ax support beamforming Function.
6. EUT Indoor access point
7. For more details, please refer to the User's manual of the EUT.



The differences between all model numbers as follow:

| Model No. | Difference | Trade Name |
|-----------|------------|------------|
| WPX8324   | With PoE   | LITEON     |
| WRX8324   | W/O PoE    | LITEON     |
| WPA-2     | With PoE   | PoEWit     |

Note: After engineering evaluation,WRX8324 for worst case and for presentation of report data



## 2.2 Carrier Frequency of Channes

| Channel    | Frequency (MHz) | Channel    | Frequency (MHz) | Channel | Frequency (MHz) | Channel    | Frequency (MHz) |
|------------|-----------------|------------|-----------------|---------|-----------------|------------|-----------------|
| <b>*00</b> | <b>2402</b>     | 20         | 2422            | 40      | 2442            | 60         | 2462            |
| 01         | 2403            | 21         | 2423            | 41      | 2443            | 61         | 2463            |
| 02         | 2404            | 22         | 2424            | 42      | 2444            | 62         | 2464            |
| 03         | 2405            | 23         | 2425            | 43      | 2445            | 63         | 2465            |
| 04         | 2406            | 24         | 2426            | 44      | 2446            | 64         | 2466            |
| 05         | 2407            | 25         | 2427            | 45      | 2447            | 65         | 2467            |
| 06         | 2408            | 26         | 2428            | 46      | 2448            | 66         | 2468            |
| 07         | 2409            | 27         | 2429            | 47      | 2449            | 67         | 2469            |
| 08         | 2410            | 28         | 2430            | 48      | 2450            | 68         | 2470            |
| 09         | 2411            | 29         | 2431            | 49      | 2451            | 69         | 2471            |
| 10         | 2412            | 30         | 2432            | 50      | 2452            | 70         | 2472            |
| 11         | 2413            | 31         | 2433            | 51      | 2453            | 71         | 2473            |
| 12         | 2414            | 32         | 2434            | 52      | 2454            | 72         | 2474            |
| 13         | 2415            | 33         | 2435            | 53      | 2455            | 73         | 2475            |
| 14         | 2416            | 34         | 2436            | 54      | 2456            | 74         | 2476            |
| 15         | 2417            | 35         | 2437            | 55      | 2457            | 75         | 2477            |
| 16         | 2418            | 36         | 2438            | 56      | 2458            | 76         | 2478            |
| 17         | 2419            | 37         | 2439            | 57      | 2459            | 77         | 2479            |
| 18         | 2420            | 38         | 2440            | 58      | 2460            | <b>*78</b> | <b>2480</b>     |
| 19         | 2421            | <b>*39</b> | <b>2441</b>     | 59      | 2461            | ---        | ---             |

Note: Channels remarked \* are selected to perform test.





### 2.3 Test Mode & Test Software

- a. During testing, the interface cables and equipment positions were varied according to ANSI C63.10
- b. The complete test system included Notebook and EUT for RF test.
- c. An executive program, " QRCT ver. 4.0.00193.0" under Windows OS system was executed to transmit and receive data via Bluetooth.
- d. The following test modes were performed for the test:

| Conducted Emissions from the AC mains power ports                                       |  |
|---|--|
| Test Mode   | Operating Description                        |
| 1   | GFSK (1Mbps) , Power from Adapter,           |
| 2   | $\pi/4$ -DQPSK (2Mbps) , Power from Adapter, |
| 3   | 8DPSK (3Mbps) , Power from Adapter,          |
| caused "Test Mode 1" generated the worst case, it was reported as the final data.       |  |
| Radiation Emissions (BELOW 1GHz)  |  |
| Test Mode   | Operating Description                        |
| 1   | GFSK (1Mbps) , Power from Adapter,           |
| 2   | $\pi/4$ -DQPSK (2Mbps) , Power from Adapter, |
| 3   | 8DPSK (3Mbps) , Power from Adapter,          |
| caused "Test Mode 1" generated the worst case, it was reported as the final data.       |  |
| Radiation Emissions (1GHz ~ 25GHz)  |  |
| Test Mode   | Operating Description                        |
| 1   | GFSK (1Mbps) , Power from Adapter,           |
| 2   | $\pi/4$ -DQPSK (2Mbps) , Power from Adapter, |
| 3   | 8DPSK (3Mbps) , Power from Adapter,          |
| caused "Test Mode 1, 3" generated the worst case, they were reported as the final data. |  |

Note:1. There are two kinds of test voltage: AC 120V / 60Hz and AC 240V / 60Hz.  
 For AC Power Line Conducted Emission, & Radiation Emissions (BELOW 1GHz)  
 AC 240V / 60Hz is worst case.  
 For Radiated Spurious Emission(1GHz ~ 40GHz), AC 120V / 60Hz is worst case.

| Modulation Type | TX CONFIGURATION |
|-----------------|------------------|
| GFSK            | 1TX              |
| $\pi/4$ -DQPSK  | 1TX              |
| 8DPSK           | 1TX              |



### 2.4 Description of Test System

| RF Conducted                     |                 |           |             |                        |
|----------------------------------|-----------------|-----------|-------------|------------------------|
| Equipment                        | Brand           | Model     | Length/Type | Power cord/Length/Type |
| Notebook                         | DELL            | P23T001   | N/A         | Adapter / 1.8m / NS    |
| RJ45 Cable * 2                   | TE CONNECTIVITY | CAT5E     | 1.2m / NS   | N/A                    |
| POE                              | CERIO           | S53VG     | N/A         | N/A                    |
| Radiated Emissions               |                 |           |             |                        |
| Equipment                        | Brand           | Model     | Length/Type | Power cord/Length/Type |
| Adapter                          | APD             | WB-18D12R | 1.8m / NS   | N/A                    |
| Notebook                         | ASUS            | P2430U    | N/A         | Adapter / 1.8m / NS    |
| RJ45 Cable                       | N/A             | N/A       | 15m / NS    | N/A                    |
| POE                              | CERIO           | S53VG     | N/A         | N/A                    |
| AC Power Line Conducted Emission |                 |           |             |                        |
| Equipment                        | Brand           | Model     | Length/Type | Power cord/Length/Type |
| Adapter                          | APD             | WB-18D12R | 1.8m / NS   | N/A                    |
| Notebook                         | DELL            | P23T001   | N/A         | Adapter / 1.8m / NS    |
| RJ45 Cable                       | TE CONNECTIVITY | CAT5E     | 1.2m / NS   | N/A                    |
| POE                              | CERIO           | S53VG     | N/A         | N/A                    |

**2.5 General Information of Test**

|                               |  |  |
|-------------------------------|--|--|
| Test Site                     | <b>Cerpass Technology Corporation Test Laboratory</b><br>Address: No.10, Ln. 2, Lianfu St., Luzhu Dist., Taoyuan City 33848, Taiwan (R.O.C.)<br>Tel:+886-3-3226-888<br>Fax:+886-3-3226-881 |  |
|                               | FCC  | TW1439, TW1079   |
|                               | IC   | 4934E-1, 4934E-2   |
|                               | VCCI   | T-2205 for Telecommunication test<br>C-4663 for Conducted emission test<br>R-4218 for Radiated emission test<br>G-10812, G-10813 for radiated disturbance above 1GHz |
| Frequency Range Investigated: | Conducted: from 150kHz to 30 MHz<br>Radiation: from 30 MHz to 25,000MHz  |  |
| Test Distance:                | The test distance of radiated emission from antenna to EUT is 3 M.   |  |

| Test Item                        | Test Site  | Test period           | Environmental Conditions | Tested By  |
|----------------------------------|------------|-----------------------|--------------------------|------------|
| RF Conducted                     | RFCON01-NK | 2022/10/13~2022/10/24 | 24~27.1°C /<br>42~59%    | Dian Chen  |
| Radiated Emissions               | 3M02-NK    | 2022/10/11~2022/10/13 | 24~25°C /<br>34~39%      | Leon Huang |
| AC Power Line Conducted Emission | CON01-NK   | 2022/10/21            | 25°C / 56%               | Leon Huang |



## 2.6 Measurement Uncertainty

ISO/IEC 17025 requires that an estimate of the measurement uncertainties associated with the emissions test results be included in the report. The measurement uncertainties given below are based on a 95% confidence level (based on a coverage factor (k=2))

| Measurement Item                         | Uncertainty |
|--|-------------|
| AC Power Line Conduction(150K~30MHz)     | ±3.12dB     |
| Radiated Spurious Emission(9KHz~30MHz)   | ±3.4dB      |
| Radiated Spurious Emission(30MHz~1GHz)   | ±5.7dB      |
| Radiated Spurious Emission(1GHz~25GHz)   | ±6.8dB      |
| Conducted Spurious Emission              | ±1.8dB      |
| 6dB Bandwidth                            | ±4.4%       |
| 20dB Bandwidth                           | ±4.4%       |
| Occupied Bandwidth                       | ±4.4%       |
| Peak Output Power(Conducted Power Meter) | ±1.1dB      |
| Dwell Time / Deactivation Time           | ±1.2%       |
| Power Spectral Density                   | ±1.8dB      |
| Duty Cycle                               | ±1.2%       |



### 3. Test Equipment and Ancillaries Used for Tests

| Test Item                        | Radiated Emissions          |               |                 |                  |            |
|----------------------------------|-----------------------------|---------------|-----------------|------------------|------------|
| Test Site                        | Semi Anechoic Room(3M02-NK) |               |                 |                  |            |
| Instrument                       | Manufacturer                | Model No      | Serial No       | Calibration Date | Valid Date |
| Bilog Antenna                    | Schwarzbeck                 | VULB9168      | 275             | 2021/11/05       | 2022/11/04 |
| Active Loop Antenna              | EMCO                        | 6507          | 40855           | 2022/05/25       | 2023/05/24 |
| Horn Antenna                     | EMCO                        | 3115          | 31589           | 2022/04/26       | 2023/04/25 |
| Horn Antenna                     | EMCO                        | 3116          | 31970           | 2022/03/18       | 2023/03/17 |
| Double Ridged Guide Horn Antenna | RF SPAN                     | DRH18-E       | 210309A18-ES    | 2022/08/24       | 2023/08/23 |
| EMI Receiver                     | ROHDE & SCHWARZ             | ESCI          | 101423          | 2022/07/05       | 2023/07/04 |
| Spectrum Analyzer                | ROHDE & SCHWARZ             | FSV 40-N      | 101329          | 2022/07/20       | 2023/07/19 |
| Preamplifier                     | Agilent                     | 8449B         | 3008A01954      | 2022/03/17       | 2023/03/16 |
| Preamplifier                     | EMC INSTRUMENTS             | EMC184045     | 980065          | 2021/11/16       | 2022/11/15 |
| Preamplifier                     | EM Electronics corp.        | EM330         | 60660           | 2022/04/08       | 2023/04/07 |
| Cable-6m(9k~300M)                | NA                          | EMC5D-BM-BM-6 | 130605          | 2022/09/06       | 2023/09/05 |
| Cable-3in1(30M-1G)               | HARBOUR INDUSTRIES          | LL142         | CCE1315         | 2022/03/21       | 2023/03/20 |
| Cable-0.5m(30M-40G)              | HUBER SUHNER                | SUCOFLEX 102  | 28420/2         | 2022/4/9         | 2023/4/8   |
| Cable-3m(30M-40G)                | HUBER SUHNER                | SUCOFLEX 102  | MY2608/2        | 2022/4/9         | 2023/4/8   |
| Cable-0.5m(1G-40G)               | Rapidtek                    | 40GHZ 50CM    | 38MS-38MS50314  | 2022/4/9         | 2023/4/8   |
| Cable-3m(1G-40G)                 | Rapidtek                    | 40GHZ 300CM   | 38MS-38MS300314 | 2022/4/9         | 2023/4/8   |
| Cable-0.5m(1G-40G)               | HUBER SUHNER                | SUCOFLEX 104  | 805443/4        | 2022/01/11       | 2023/01/10 |
| Cable-3m(1G-40G)                 | HUBER SUHNER                | SUCOFLEX 104  | 805796/4        | 2022/01/11       | 2023/01/10 |
| Cable-8m(1G-26.5G)               | WOKEN                       | WCBA-WCA203SM | CCE1374         | 2022/04/25       | 2023/04/24 |
| E3                               | AUDIX                       | v8.2014-8-6   | RK-000529       | NA               | NA         |

| Test Item           | RF Conducted |          |            |                  |            |
|---------------------|--------------|----------|------------|------------------|------------|
| Test Site           | RFCON01-NK   |          |            |                  |            |
| Instrument          | Manufacturer | Model No | Serial No  | Calibration Date | Valid Date |
| CAX Signal Analyzer | KEYSIGHT     | N9000B   | MY57100339 | 2022/01/10       | 2023/01/09 |
| Power Meter         | Anritsu      | ML2495A  | 1224005    | 2022/04/12       | 2023/04/11 |
| Power Sensor        | Anritsu      | MA2411B  | 1207295    | 2022/04/12       | 2023/04/11 |
| Attenuator          | KEYSIGHT     | 8491B    | MY39250703 | 2022/04/12       | 2023/04/11 |



| Test Item                            | AC Power Line Conducted Emission |               |           |                  |            |
|--------------------------------------|----------------------------------|---------------|-----------|------------------|------------|
| Test Site                            | CON01-NK                         |               |           |                  |            |
| Instrument                           | Manufacturer                     | Model No      | Serial No | Calibration Date | Valid Date |
| EMI Receiver                         | ROHDE & SCHWARZ                  | ESCI          | 101200    | 2022/08/22       | 2023/08/21 |
| Line Impedance Stabilization Network | Schwarzbeck                      | NSLK 8127     | 8127-740  | 2022/08/21       | 2023/08/20 |
| Pulse Limiter                        | ROHDE & SCHWARZ                  | ESH3-Z2       | 101934    | 2022/03/21       | 2023/03/20 |
| Cable-6m(9k~300M)                    | NA                               | EMC5D-BM-BM-6 | 130606    | 2022/03/21       | 2023/03/20 |
| E3                                   | AUDIX                            | v8.2014-8-6   | RK-000531 | NA               | NA         |



## 4. Antenna Requirements

### 4.1 Standard Applicable

For intentional device, according to FCC 47 CFR Section 15.203, an intentional radiator shall be designed to ensure that no antenna other than that furnished by the responsible party shall be used with the device.

And according to FCC 47 CFR Section 15.247 (b), if transmitting antennas of directional gain greater than 6dBi are used, the power shall be reduced by the amount in dB that the directional gain of the antenna exceeds 6dBi.

### 4.2 Antenna Construction and Directional Gain

|              |             |
|--------------|-------------|
| Antenna Type | PCB Antenna |
| Antenna Gain | 2.55 dBi    |



## 5. Frequency Hopping System Requirements

### 5.1 Frequency Hopping Requirement

According to FCC Part 15.247(a)(1), The system shall hop to channel frequencies that are selected at the system hopping rate from a pseudo randomly ordered list of hopping frequencies. Each frequency must be used equally on the average by each transmitter. The system receivers shall have input bandwidths that match the hopping channel bandwidths of their corresponding transmitters and shall shift frequencies in synchronization with the transmitted signals.

(g) Frequency hopping spread spectrum systems are not required to employ all available hopping channels during each transmission. However, the system, consisting of both the transmitter and the receiver, must be designed to comply with all of the regulations in this section should the transmitter be presented with a continuous data (or information) stream. In addition, a system employing short transmission bursts must comply with the definition of a frequency hopping system and must distribute its transmissions over the minimum number of hopping channels specified in this section.

(h) The incorporation of intelligence within a frequency hopping spread spectrum system that permits the system to recognize other users within the spectrum band so that it individually and independently chooses and adapts its hopsets to avoid hopping on occupied channels is permitted. The coordination of frequency hopping systems in any other manner for the express purpose of avoiding the simultaneous occupancy of individual hopping frequencies by multiple transmitters is not permitted.





### 5.2 EUT Hopping System

This transmitter device is frequency hopping device, and complies with FCC part 15.247 rule.

This device uses Bluetooth radio which operates in 2400-2483.5 MHz band. Bluetooth uses a radio technology called frequency-hopping spread spectrum, which chops up the data being sent and transmits chunks of it on up to 79 bands (1 MHz each; centred from 2402 to 2480MHz) in the range 2,400-2,483.5 MHz. The transmitter switches hop frequencies 1,600 times per second to assure a high degree of data security. All Bluetooth devices participating in a given piconet are synchronized to the frequency-hopping channel for the piconet. The frequency hopping sequence is determined by the master's device address and the phase of the hopping sequence (the frequency to hop at a specific time) is determined by the master's internal clock. Therefore, all slaves in a piconet must know the master's device address and must synchronize their clocks with the master's clock.

Adaptive Frequency Hopping (AFH) was introduced in the Bluetooth specification to provide an effective way for a Bluetooth radio to counteract normal interference. AFH identifies "bad" channels, where either other wireless devices are interfering with the Bluetooth signal or the Bluetooth signal is interfering with another device. The AFH-enabled Bluetooth device will then communicate with other devices within its piconet to share details of any identified bad channels. The devices will then switch to alternative available "good" channels, away from the areas of interference, thus having no impact on the bandwidth used.

### 5.3 Pseudorandom Frequency Hopping Sequence

Pseudorandom Frequency Hopping Sequence Table as below:

Channel number:

|    |    |    |    |    |    |    |    |    |    |
|----|----|----|----|----|----|----|----|----|----|
| 37 | 47 | 76 | 54 | 63 | 8  | 63 | 36 | 25 | 54 |
| 53 | 48 | 15 | 51 | 45 | 29 | 62 | 37 | 60 | 60 |
| 25 | 28 | 48 | 14 | 60 | 65 | 36 | 78 | 22 | 58 |
| 7  | 6  | 35 | 50 | 12 | 0  | 73 | 20 | 69 | 73 |

The system receiver have input bandwidths that match the hopping channel bandwidths of their corresponding transmitters and shift frequencies in synchronization with the transmitted signals.



## 6. Test of AC Power Line Conducted Emission

### 6.1 Test Limit

Conducted Emissions were measured from 150 kHz to 30 MHz with a bandwidth of 9 KHz, according to the methods defined in ANSI C63.10-2013. The EUT was placed on a nonmetallic stand in a shielded room 0.8 meters above the ground plane. The interface cables and equipment positioning were varied within limits of reasonable applications to determine the position produced maximum conducted emissions.

| Frequency (MHz) | Quasi Peak (dB $\mu$ V) | Average (dB $\mu$ V) |
|-----------------|-------------------------|----------------------|
| 0.15 – 0.5      | 66-56*                  | 56-46*               |
| 0.5 – 5.0       | 56                      | 46                   |
| 5.0 – 30.0      | 60                      | 50                   |

\*Decreases with the logarithm of the frequency.

### 6.2 Test Procedures

- a. The EUT was placed 0.4 meter from the conducting wall of the shielding room was kept at least 80 centimeters from any other grounded conducting surface.
- b. Connect EUT to the power mains through a line impedance stabilization network (LISN).
- c. All the support units are connecting to the other LISN.
- d. The LISN provides 50 ohm coupling impedance for the measuring instrument.
- e. The FCC states that a 50 ohm, 50 micro-Henry LISN should be used.
- f. Both sides of AC line were checked for maximum conducted interference.
- g. The frequency range from 150 kHz to 30 MHz was searched.
- h. Set the test-receiver system to Peak Detect Function and Specified Bandwidth with Maximum Hold Mode.



### 6.3 Typical Test Setup

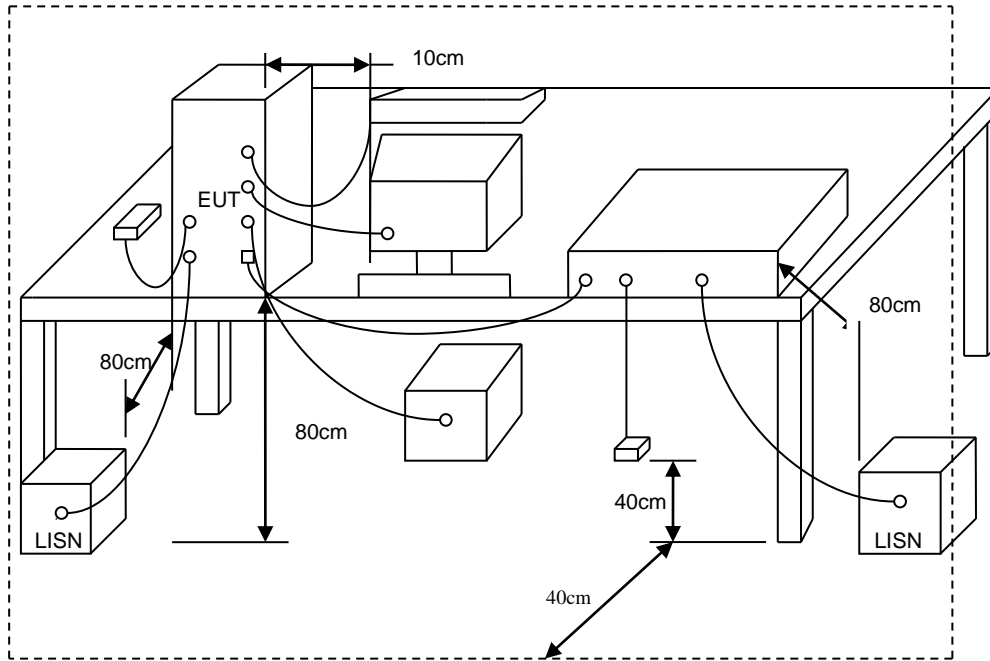



### 6.4 Test Result and Data

|           |                                   |           |        |
|-----------|-----------------------------------|-----------|--------|
| Power     | : DC 12V From adapter (240V/60Hz) | Pol/Phase | : LINE |
| Test Mode | : Mode 1                          |           |        |

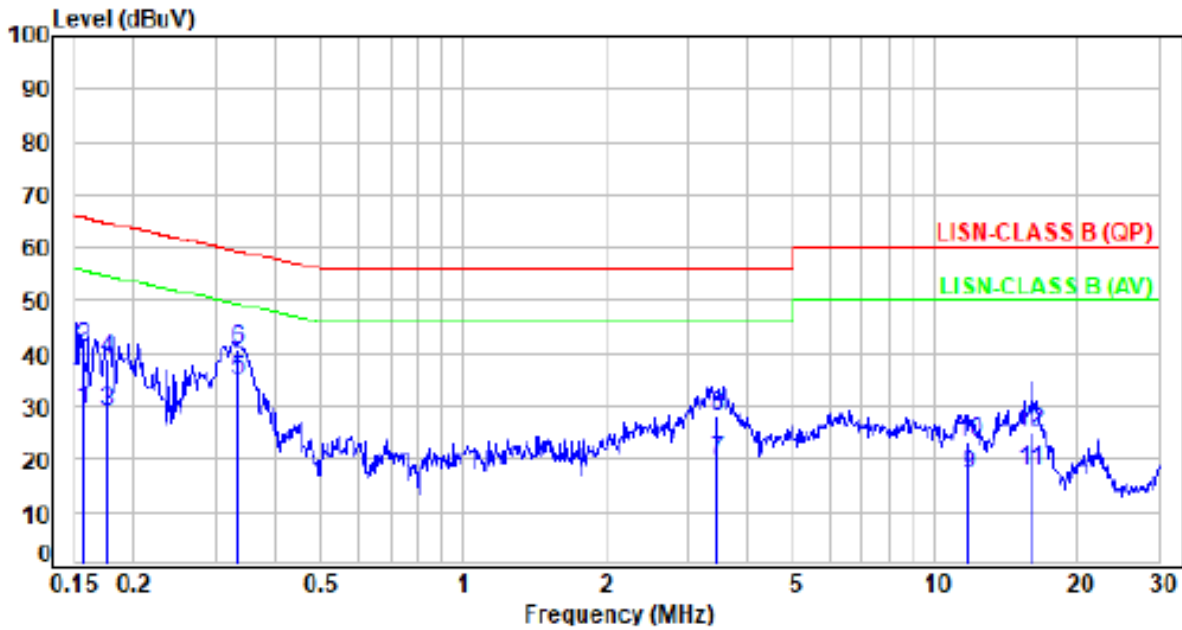

| No. | Frequency (MHz) | Factor (dB) | Reading (dBuV) | Level (dBuV) | Limit (dBuV) | Margin (dB) | Detector | P/F |
|-----|-----------------|-------------|----------------|--------------|--------------|-------------|----------|-----|
| 1   | 0.16            | 9.89        | 19.25          | 29.14        | 55.66        | -26.52      | Average  | P   |
| 2   | 0.16            | 9.89        | 31.16          | 41.05        | 65.66        | -24.61      | QP       | P   |
| 3   | 0.18            | 9.89        | 18.92          | 28.81        | 54.68        | -25.87      | Average  | P   |
| 4   | 0.18            | 9.89        | 28.97          | 38.86        | 64.68        | -25.82      | QP       | P   |
| 5   | 0.33            | 9.90        | 25.15          | 35.05        | 49.34        | -14.29      | Average  | P   |
| 6   | 0.33            | 9.90        | 30.77          | 40.67        | 59.34        | -18.67      | QP       | P   |
| 7   | 3.44            | 9.84        | 9.78           | 19.62        | 46.00        | -26.38      | Average  | P   |
| 8   | 3.44            | 9.84        | 18.43          | 28.27        | 56.00        | -27.73      | QP       | P   |
| 9   | 11.83           | 9.91        | 7.13           | 17.04        | 50.00        | -32.96      | Average  | P   |
| 10  | 11.83           | 9.91        | 13.38          | 23.29        | 60.00        | -36.71      | QP       | P   |
| 11  | 15.89           | 9.96        | 7.98           | 17.94        | 50.00        | -32.06      | Average  | P   |
| 12  | 15.89           | 9.96        | 15.00          | 24.96        | 60.00        | -35.04      | QP       | P   |

Note: Level=Reading+Factor  
Margin=Level-Limit  
Factor=(LISN or ISN or Current Probe)Factor + Cable Loss



|           |                                   |           |           |
|-----------|-----------------------------------|-----------|-----------|
| Power     | : DC 12V From adapter (240V/60Hz) | Pol/Phase | : NEUTRAL |
| Test Mode | : Mode 1                          |           |           |

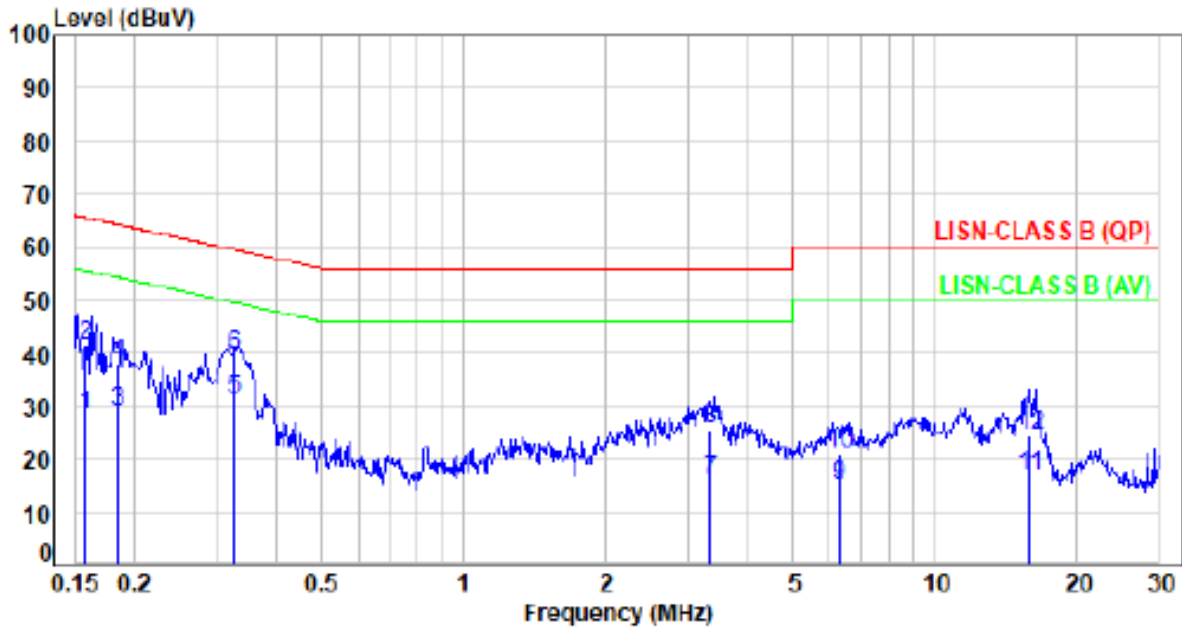

| No. | Frequency (MHz) | Factor (dB) | Reading (dBuV) | Level (dBuV) | Limit (dBuV) | Margin (dB) | Detector | P/F |
|-----|-----------------|-------------|----------------|--------------|--------------|-------------|----------|-----|
| 1   | 0.16            | 9.90        | 18.35          | 28.25        | 55.57        | -27.32      | Average  | P   |
| 2   | 0.16            | 9.90        | 31.37          | 41.27        | 65.57        | -24.30      | QP       | P   |
| 3   | 0.19            | 9.90        | 18.82          | 28.72        | 54.23        | -25.51      | Average  | P   |
| 4   | 0.19            | 9.90        | 28.18          | 38.08        | 64.23        | -26.15      | QP       | P   |
| 5   | 0.33            | 9.90        | 21.13          | 31.03        | 49.54        | -18.51      | Average  | P   |
| 6   | 0.33            | 9.90        | 29.70          | 39.60        | 59.54        | -19.94      | QP       | P   |
| 7   | 3.33            | 9.84        | 6.18           | 16.02        | 46.00        | -29.98      | Average  | P   |
| 8   | 3.33            | 9.84        | 15.71          | 25.55        | 56.00        | -30.45      | QP       | P   |
| 9   | 6.27            | 9.85        | 4.84           | 14.69        | 50.00        | -35.31      | Average  | P   |
| 10  | 6.27            | 9.85        | 11.25          | 21.10        | 60.00        | -38.90      | QP       | P   |
| 11  | 15.94           | 9.96        | 6.93           | 16.89        | 50.00        | -33.11      | Average  | P   |
| 12  | 15.94           | 9.96        | 14.21          | 24.17        | 60.00        | -35.83      | QP       | P   |

Note: Level=Reading+Factor  
 Margin=Level-Limit  
 Factor=(LISN or ISN or Current Probe)Factor + Cable Loss



## 7. Test of Radiated Spurious Emission

### 7.1 Test Limit

In any 100kHz bandwidth outside the frequency band in which the spread spectrum or digitally modulated intentional radiator is operating, the radio frequency power that is produced by the intentional radiator shall be at least 20dB below that in the 100kHz bandwidth within the band that contains the highest level of the desired power, based on either an RF conducted or a radiated measurement. If the transmitter measurement is based on the maximum conducted output power, the attenuation required under this paragraph shall be 30dB instead of 20dB. In addition, radiated emissions which fall in section 15.205(a) the restricted bands must also comply with the radiated emission limit specified in section 15.209(a).

| Frequency (MHz) | Field Strength (microvolt/meter) | Measurement Distance (meters) |
|-----------------|----------------------------------|-------------------------------|
| 0.009 ~ 0.490   | 2400/F(kHz)                      | 300                           |
| 0.490 ~ 1.705   | 24000/F(kHz)                     | 30                            |
| 1.705 ~ 30.0    | 30                               | 30                            |
| 30 ~ 88         | 100                              | 3                             |
| 88 ~ 216        | 150                              | 3                             |
| 216 ~ 960       | 200                              | 3                             |
| Above 960       | 500                              | 3                             |



## 7.2 Test Procedures

- a. The EUT was placed on a rotatable table top 0.8 meter above ground.
- b. The EUT was set 3 meters from the interference receiving antenna which was mounted on the top of a variable height antenna tower.
- c. The table was rotated 360 degrees to determine the position of the highest radiation.
- d. The antenna is a broadband antenna and its height is varied between one meter and four meters above ground to find the maximum value of the field strength both horizontal polarization and vertical polarization of the antenna are set to make the measurement.
- e. For each suspected emission the EUT was arranged to its worst case and then tune the antenna tower (from 1 M to 4 M) and turn table (from 0 degree to 360 degrees) to find the maximum reading.
- f. Set the test-receiver system to Peak or CISPR quasi-peak Detect Function and specified bandwidth with Maximum Hold Mode.
- g. If the emission level of the EUT in peak mode was 3 dB lower than the limit specified, then testing will be stopped and peak values of EUT will be reported, otherwise, the emissions which do not have 3 dB margin will be repeated one by one using the quasi-peak method and reported.
- h. For testing above 1GHz, the emission level of the EUT in peak mode was 20dB lower than average limit (that means the emission level in peak mode also complies with the limit in average mode), then testing will be stopped and peak values of EUT will be reported, otherwise, the emissions will be measured in average mode again and reported.
- i. "Cone of radiation" has been considered to be 3dB bandwidth of the measurement antenna.

Note:

1. The supporting fixture shall permit orientation of the EUT in each of three orthogonal axis positions such that emissions from the EUT are maximized.  
(Y-AXIS is the worst.)
2. Due to the test software function limit the operation band setting(200dBuV/m).  
There's no corresponding limitation in the actual test item.



### 7.3 Typical Test Setup

Below 30MHz test setup

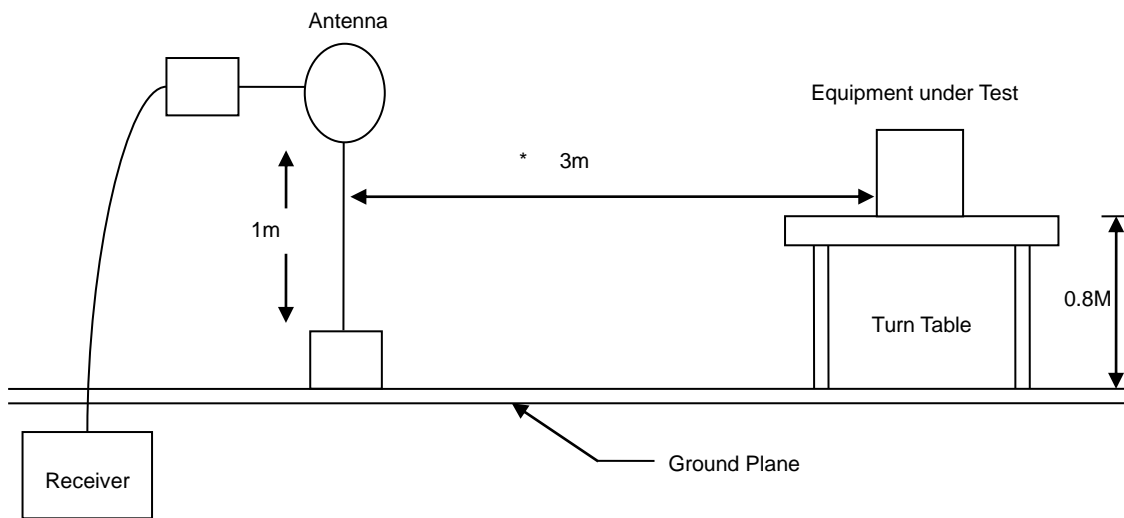

30MHz- 1GHz Test Setup

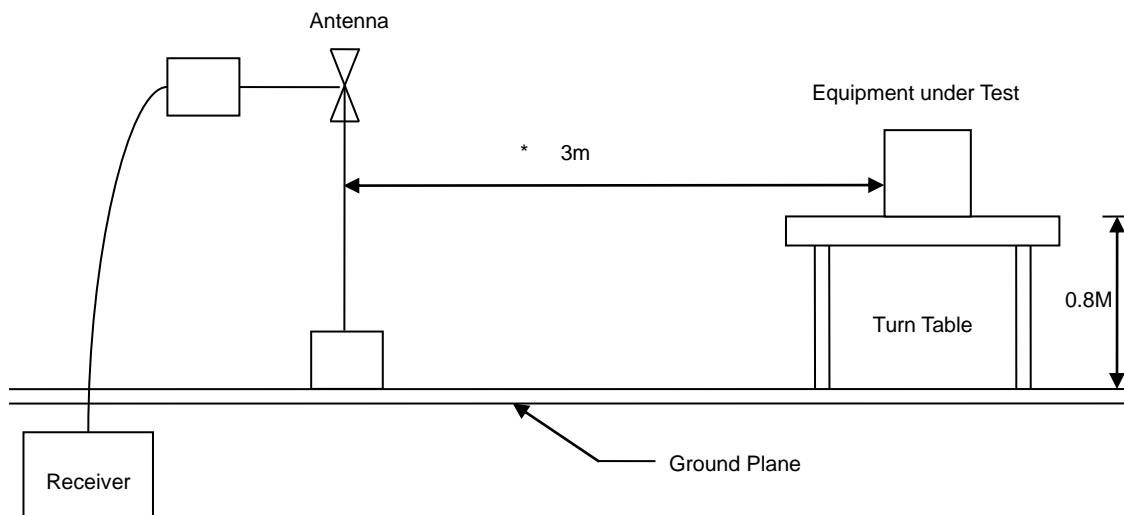

Above 1GHz Test Setup

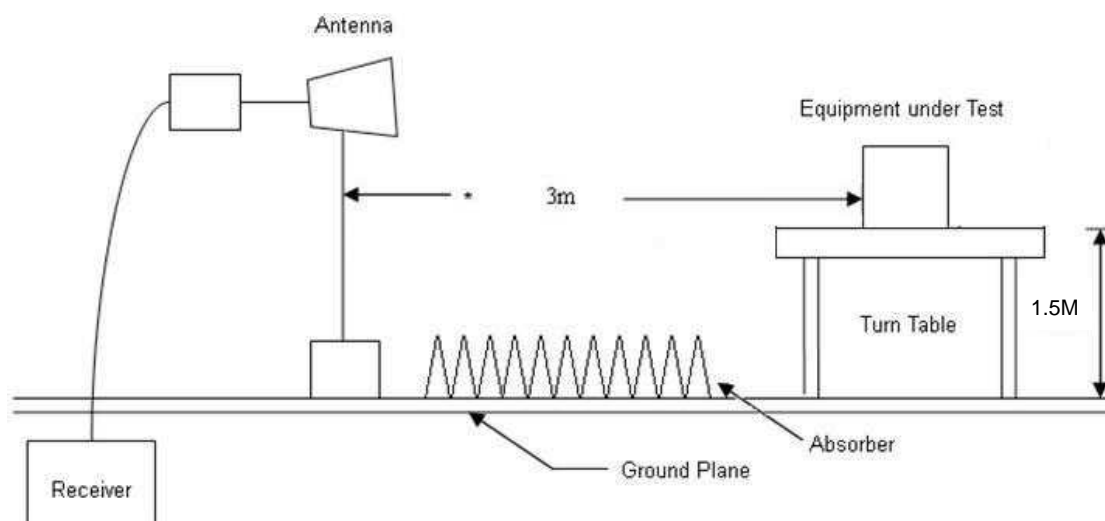





### 7.4 Test Result and Data (9kHz ~ 30MHz)

The 9kHz-30MHz spurious emission is under limit 20dB more.

### 7.5 Test Result and Data (30MHz ~ 1GHz)

|           |                                   |           |            |
|-----------|-----------------------------------|-----------|------------|
| Power     | : DC 12V From adapter (240V/60Hz) | Pol/Phase | : VERTICAL |
| Test Mode | : Mode 1                          |           | :          |

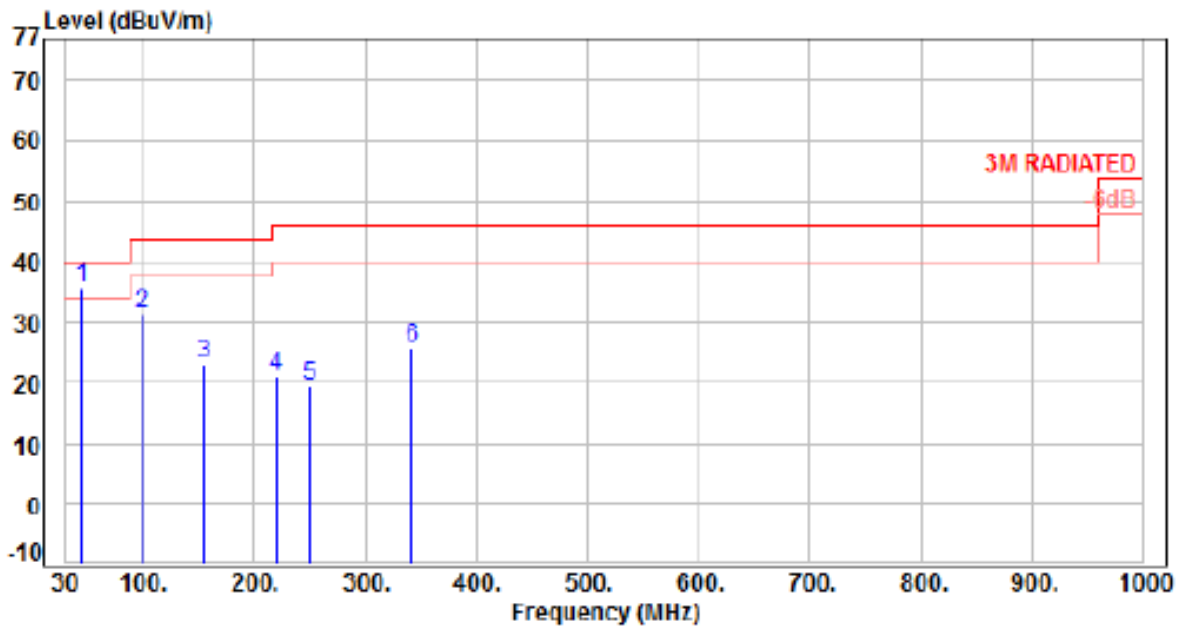

| No. | Frequency (MHz) | Factor (dB) | Reading (dBuV) | Level (dBuV/m) | Limit (dBuV/m) | Margin (dB) | Detector | Height (cm) | Azimuth (deg) | P/F |
|-----|-----------------|-------------|----------------|----------------|----------------|-------------|----------|-------------|---------------|-----|
| 1   | 45.52           | -11.12      | 46.68          | 35.56          | 40.00          | -4.44       | Peak     | 400         | 360           | P   |
| 2   | 97.90           | -15.93      | 47.23          | 31.30          | 43.50          | -12.20      | Peak     | 400         | 360           | P   |
| 3   | 154.16          | -11.31      | 34.31          | 23.00          | 43.50          | -20.50      | Peak     | 400         | 360           | P   |
| 4   | 220.12          | -14.03      | 34.97          | 20.94          | 46.00          | -25.06      | Peak     | 400         | 360           | P   |
| 5   | 249.22          | -12.06      | 31.39          | 19.33          | 46.00          | -26.67      | Peak     | 400         | 360           | P   |
| 6   | 342.34          | -9.29       | 34.89          | 25.60          | 46.00          | -20.40      | Peak     | 400         | 360           | P   |

Note: Level=Reading+Factor  
Margin=Level-Limit  
Factor=Antenna Factor + cable loss - Amplifier Factor



|           |                                   |           |              |
|-----------|-----------------------------------|-----------|--------------|
| Power     | : DC 12V From adapter (240V/60Hz) | Pol/Phase | : HORIZONTAL |
| Test Mode | : Mode 1                          |           | :            |

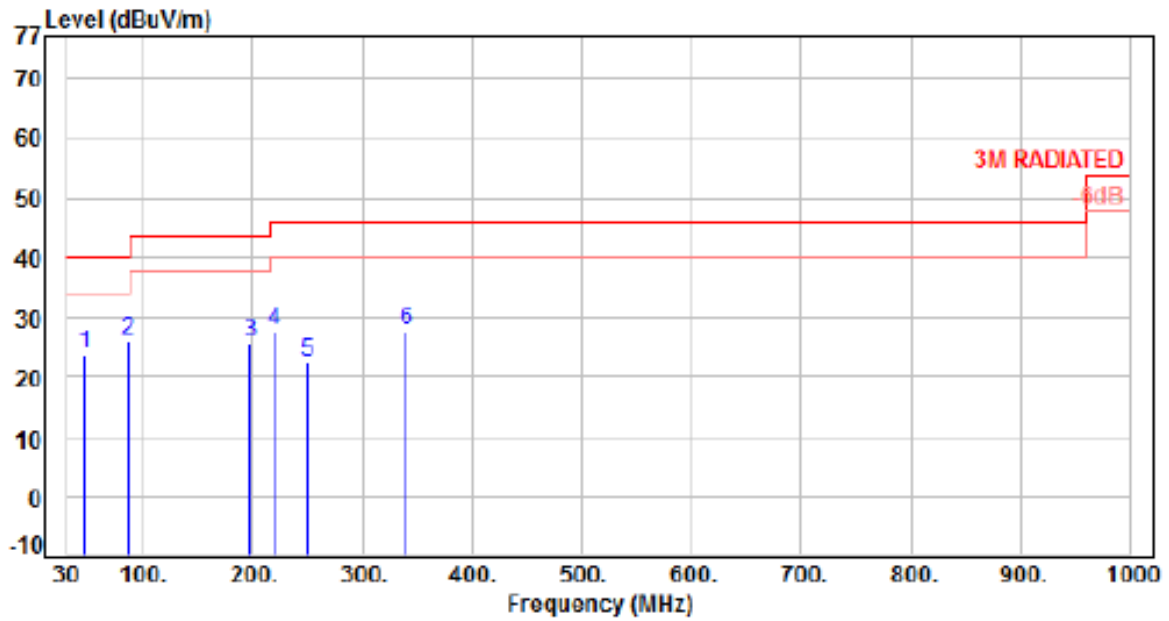

| No. | Frequency (MHz) | Factor (dB) | Reading (dBuV) | Level (dBuV/m) | Limit (dBuV/m) | Margin (dB) | Detector | Height (cm) | Azimuth (deg) | P/F |
|-----|-----------------|-------------|----------------|----------------|----------------|-------------|----------|-------------|---------------|-----|
| 1   | 47.46           | -10.98      | 34.57          | 23.59          | 40.00          | -16.41      | Peak     | 400         | 360           | P   |
| 2   | 86.26           | -16.93      | 42.94          | 26.01          | 40.00          | -13.99      | Peak     | 400         | 360           | P   |
| 3   | 196.84          | -13.12      | 38.83          | 25.71          | 43.50          | -17.79      | Peak     | 400         | 360           | P   |
| 4   | 220.12          | -14.03      | 41.81          | 27.78          | 46.00          | -18.22      | Peak     | 400         | 360           | P   |
| 5   | 249.22          | -12.06      | 34.32          | 22.26          | 46.00          | -23.74      | Peak     | 400         | 360           | P   |
| 6   | 340.40          | -9.29       | 36.85          | 27.57          | 46.00          | -18.43      | Peak     | 400         | 360           | P   |

Note: Level=Reading+Factor

Margin=Level-Limit

Factor=Antenna Factor + cable loss - Amplifier Factor



### 7.6 Test Result and Data (1GHz ~ 25GHz)

|           |                                   |           |            |
|-----------|-----------------------------------|-----------|------------|
| Power     | : DC 12V From adapter (240V/60Hz) | Pol/Phase | : VERTICAL |
| Test Mode | : Mode 1, CH00                    |           |            |

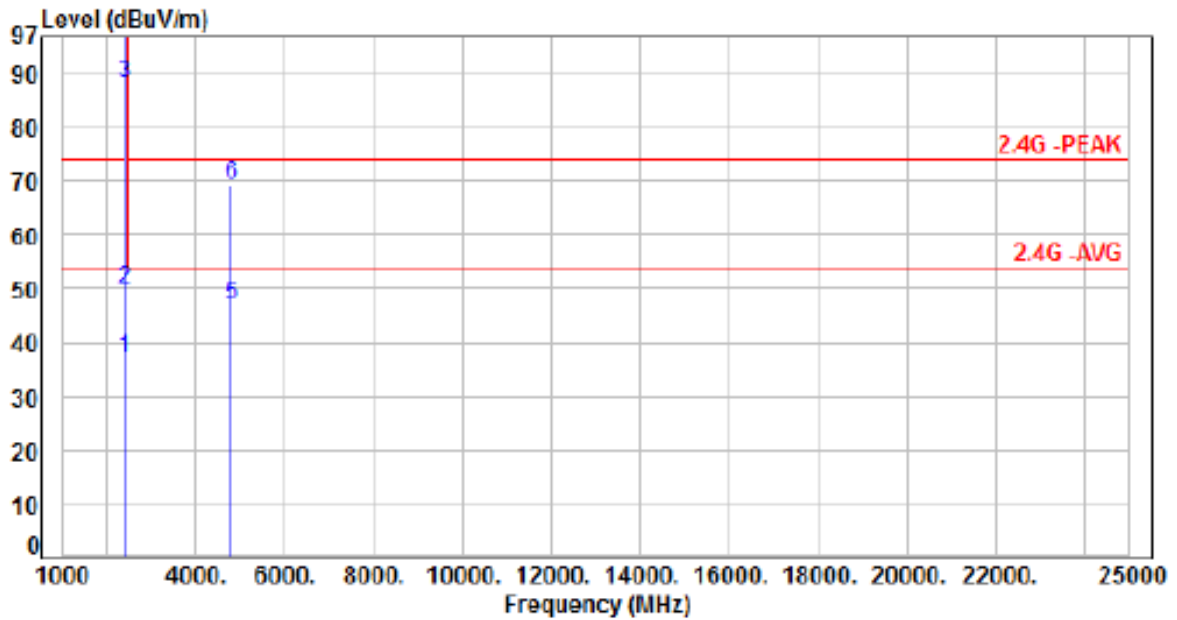

| No. | Frequency (MHz) | Factor (dB) | Reading (dBuV) | Level (dBuV/m) | Limit (dBuV/m) | Margin (dB) | Detector | Height (cm) | Azimuth (deg) | P/F |
|-----|-----------------|-------------|----------------|----------------|----------------|-------------|----------|-------------|---------------|-----|
| 1   | 2390.00         | -3.88       | 40.63          | 36.75          | 54.00          | -17.25      | Average  | 121         | 353           | P   |
| 2   | 2390.00         | -3.88       | 53.79          | 49.91          | 74.00          | -24.09      | Peak     | 121         | 353           | P   |
| 3   | 2402.00         | -3.91       | 92.17          | 88.26          | 200.00         | -111.74     | Average  | 121         | 353           | P   |
| 4   | 2402.00         | -3.91       | 114.67         | 110.76         | 200.00         | -89.24      | Peak     | 121         | 353           | P   |
| 5   | 4804.00         | 4.37        | 42.52          | 46.89          | 54.00          | -7.11       | Average  | 126         | 13            | P   |
| 6   | 4804.00         | 4.37        | 65.02          | 69.39          | 74.00          | -4.61       | Peak     | 126         | 13            | P   |

Note: Level=Reading+Factor  
Margin=Level-Limit  
Factor=Antenna Factor + cable loss - Amplifier Factor



|           |                                   |           |              |
|-----------|-----------------------------------|-----------|--------------|
| Power     | : DC 12V From adapter (240V/60Hz) | Pol/Phase | : HORIZONTAL |
| Test Mode | : Mode 1, CH00                    |           | :            |

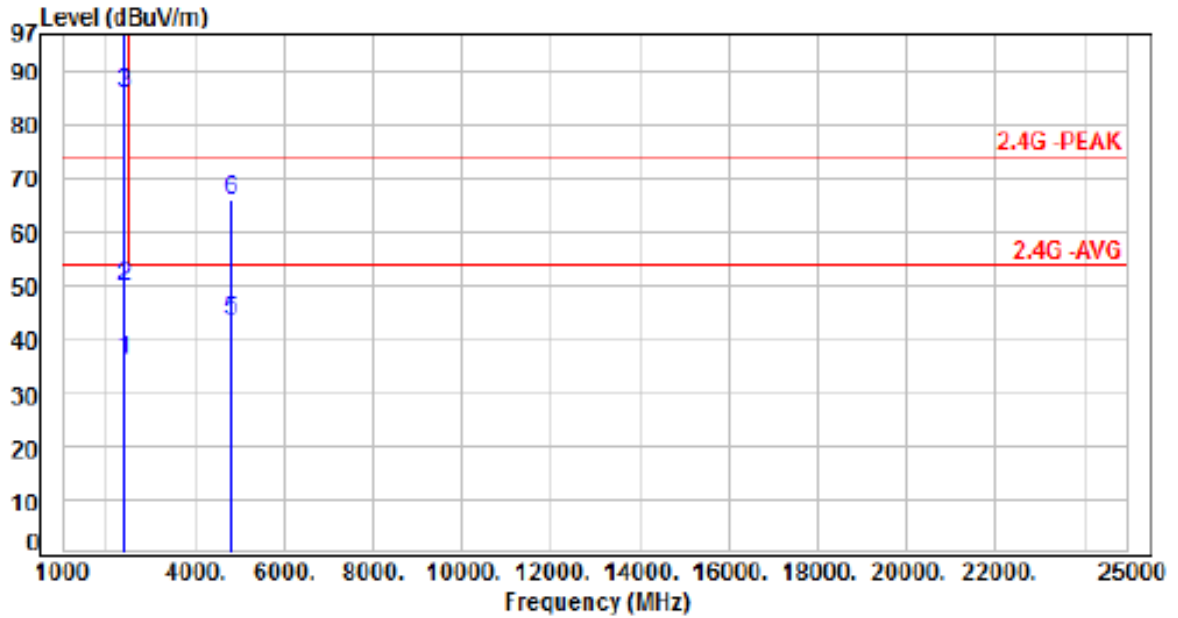

| No. | Frequency (MHz) | Factor (dB) | Reading (dBuV) | Level (dBuV/m) | Limit (dBuV/m) | Margin (dB) | Detector | Height (cm) | Azimuth (deg) | P/F |
|-----|-----------------|-------------|----------------|----------------|----------------|-------------|----------|-------------|---------------|-----|
| 1   | 2390.00         | -3.88       | 40.16          | 36.28          | 54.00          | -17.72      | Average  | 346         | 346           | P   |
| 2   | 2390.00         | -3.88       | 53.65          | 49.77          | 74.00          | -24.23      | Peak     | 346         | 346           | P   |
| 3   | 2402.00         | -3.91       | 89.75          | 85.84          | 200.00         | -114.16     | Average  | 346         | 346           | P   |
| 4   | 2402.00         | -3.91       | 112.25         | 108.34         | 200.00         | -91.66      | Peak     | 346         | 346           | P   |
| 5   | 4804.00         | 4.37        | 39.11          | 43.48          | 54.00          | -10.52      | Average  | 370         | 180           | P   |
| 6   | 4804.00         | 4.37        | 61.61          | 65.98          | 74.00          | -8.02       | Peak     | 370         | 180           | P   |

Note: Level=Reading+Factor  
Margin=Level-Limit  
Factor=Antenna Factor + cable loss - Amplifier Factor



|           |                                     |           |            |
|-----------|-------------------------------------|-----------|------------|
| Power     | : A DC 12V From adapter (240V/60Hz) | Pol/Phase | : VERTICAL |
| Test Mode | : Mode 1, CH39                      |           | :          |

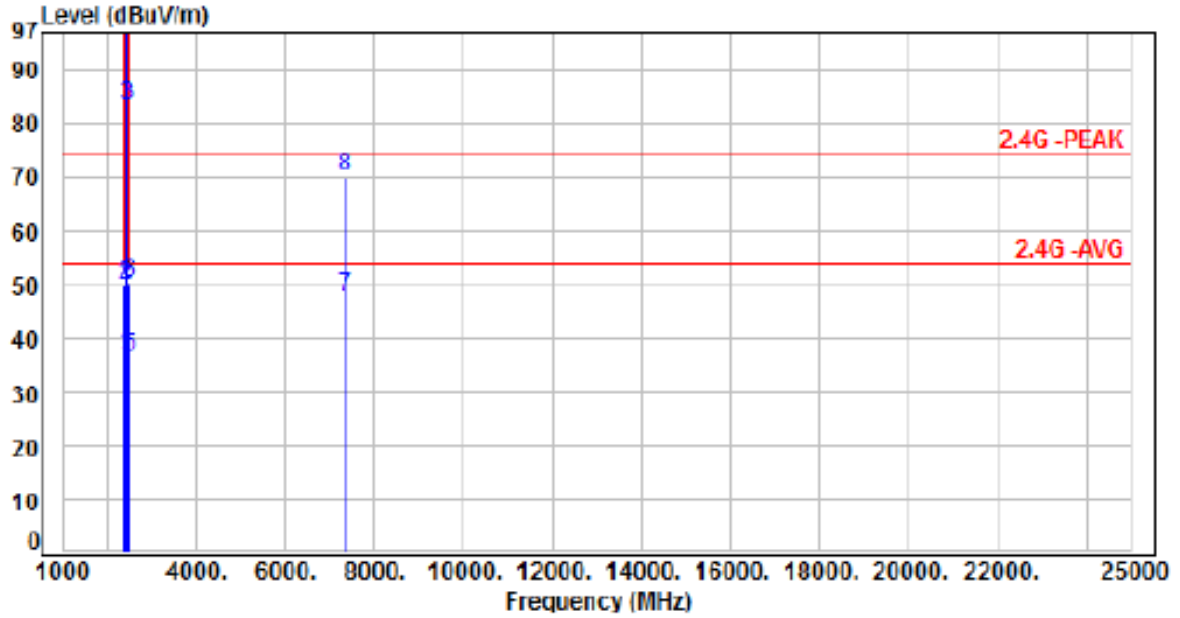

| No. | Frequency (MHz) | Factor (dB) | Reading (dBuV) | Level (dBuV/m) | Limit (dBuV/m) | Margin (dB) | Detector | Height (cm) | Azimuth (deg) | P/F |
|-----|-----------------|-------------|----------------|----------------|----------------|-------------|----------|-------------|---------------|-----|
| 1   | 2390.00         | -3.88       | 40.71          | 36.83          | 54.00          | -17.17      | Average  | 100         | 2             | P   |
| 2   | 2390.00         | -3.88       | 53.76          | 49.88          | 74.00          | -24.12      | Peak     | 100         | 2             | P   |
| 3   | 2441.00         | -3.94       | 87.24          | 83.30          | 200.00         | -116.70     | Average  | 100         | 2             | P   |
| 4   | 2441.00         | -3.94       | 109.74         | 105.80         | 200.00         | -94.20      | Peak     | 100         | 2             | P   |
| 5   | 2483.50         | -3.99       | 40.34          | 36.35          | 54.00          | -17.65      | Average  | 100         | 2             | P   |
| 6   | 2483.50         | -3.99       | 54.16          | 50.17          | 74.00          | -23.83      | Peak     | 100         | 2             | P   |
| 7   | 7323.00         | 10.83       | 36.59          | 47.42          | 54.00          | -6.58       | Average  | 100         | 295           | P   |
| 8   | 7323.00         | 10.83       | 59.09          | 69.92          | 74.00          | -4.08       | Peak     | 100         | 295           | P   |

Note: Level=Reading+Factor  
Margin=Level-Limit  
Factor=Antenna Factor + cable loss - Amplifier Factor



|           |   |                                 |           |   |            |
|-----------|---|---------------------------------|-----------|---|------------|
| Power     | : | DC 12V From adapter (240V/60Hz) | Pol/Phase | : | HORIZONTAL |
| Test Mode | : | Mode 1, CH39                    |           | : |            |

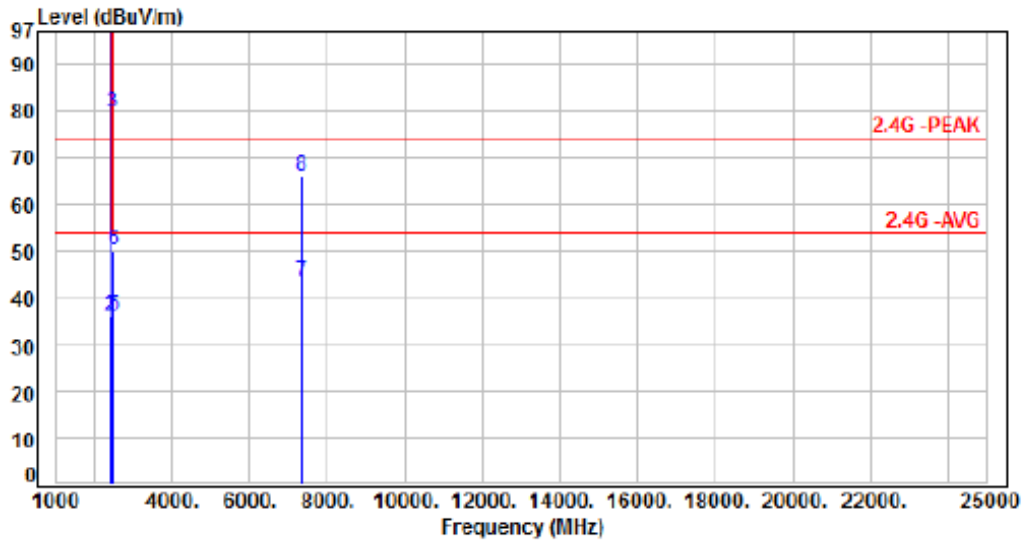

| No. | Frequency (MHz) | Factor (dB) | Reading (dBuV) | Level (dBuV/m) | Limit (dBuV/m) | Margin (dB) | Detector | Height (cm) | Azimuth (deg) | P/F |
|-----|-----------------|-------------|----------------|----------------|----------------|-------------|----------|-------------|---------------|-----|
| 1   | 2390.00         | -3.88       | 40.05          | 36.17          | 54.00          | -17.83      | Average  | 379         | 360           | P   |
| 2   | 2390.00         | -3.88       | 40.05          | 36.17          | 74.00          | -37.83      | Peak     | 379         | 360           | P   |
| 3   | 2441.00         | -3.94       | 83.52          | 79.58          | 200.00         | -120.42     | Average  | 379         | 360           | P   |
| 4   | 2441.00         | -3.94       | 105.02         | 102.08         | 200.00         | -97.92      | Peak     | 379         | 360           | P   |
| 5   | 2483.50         | -3.99       | 40.05          | 36.06          | 54.00          | -17.94      | Average  | 379         | 360           | P   |
| 6   | 2483.50         | -3.99       | 54.08          | 50.09          | 74.00          | -23.91      | Peak     | 379         | 360           | P   |
| 7   | 7323.00         | 10.83       | 32.80          | 43.63          | 54.00          | -10.37      | Average  | 399         | 199           | P   |
| 8   | 7323.00         | 10.83       | 55.30          | 66.13          | 74.00          | -7.87       | Peak     | 399         | 199           | P   |

Note: Level=Reading+Factor  
Margin=Level-Limit  
Factor=Antenna Factor + cable loss - Amplifier Factor



|           |                                   |           |            |
|-----------|-----------------------------------|-----------|------------|
| Power     | : DC 12V From adapter (240V/60Hz) | Pol/Phase | : VERTICAL |
| Test Mode | : Mode 1, CH78                    |           | :          |

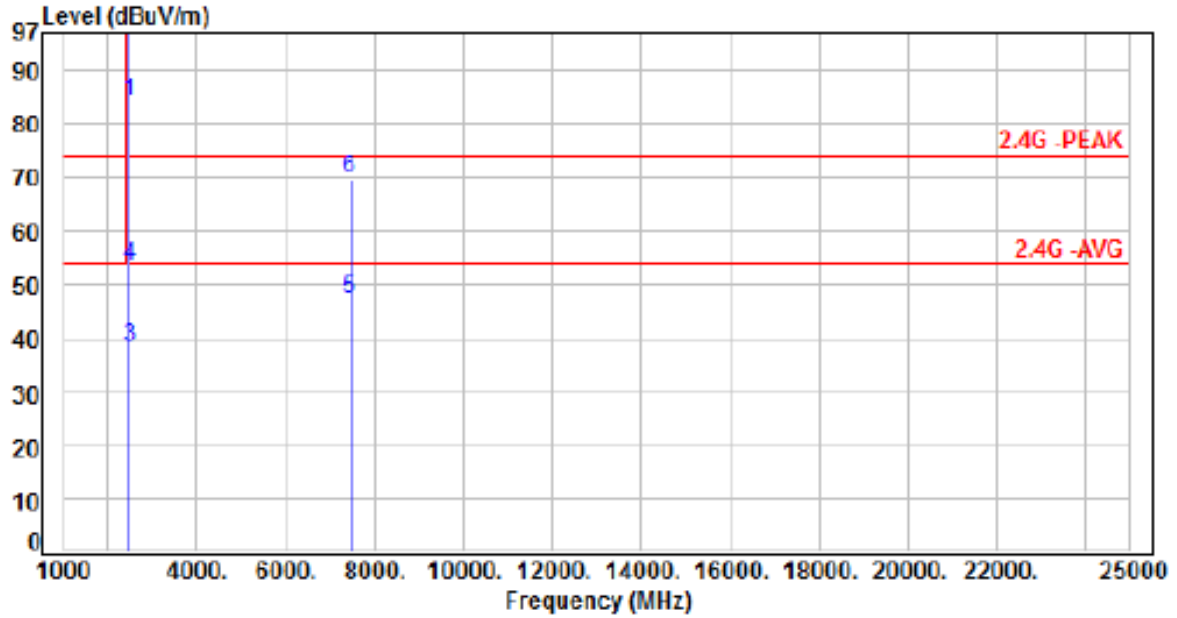

| No. | Frequency (MHz) | Factor (dB) | Reading (dBuV) | Level (dBuV/m) | Limit (dBuV/m) | Margin (dB) | Detector | Height (cm) | Azimuth (deg) | P/F |
|-----|-----------------|-------------|----------------|----------------|----------------|-------------|----------|-------------|---------------|-----|
| 1   | 2480.00         | -3.98       | 88.02          | 84.04          | 200.00         | -115.96     | Average  | 172         | 339           | P   |
| 2   | 2480.00         | -3.98       | 110.52         | 106.54         | 200.00         | -93.46      | Peak     | 172         | 339           | P   |
| 3   | 2483.50         | -3.99       | 42.42          | 38.43          | 54.00          | -15.57      | Average  | 172         | 339           | P   |
| 4   | 2483.50         | -3.99       | 57.57          | 53.58          | 74.00          | -20.42      | Peak     | 172         | 339           | P   |
| 5   | 7440.00         | 10.82       | 36.22          | 47.04          | 54.00          | -6.96       | Average  | 112         | 74            | P   |
| 6   | 7440.00         | 10.82       | 58.72          | 69.54          | 74.00          | -4.46       | Peak     | 112         | 74            | P   |

Note: Level=Reading+Factor  
Margin=Level-Limit  
Factor=Antenna Factor + cable loss - Amplifier Factor



|           |   |                                 |           |   |            |
|-----------|---|---------------------------------|-----------|---|------------|
| Power     | : | DC 12V From adapter (240V/60Hz) | Pol/Phase | : | HORIZONTAL |
| Test Mode | : | Mode 1, CH78                    |           | : |            |

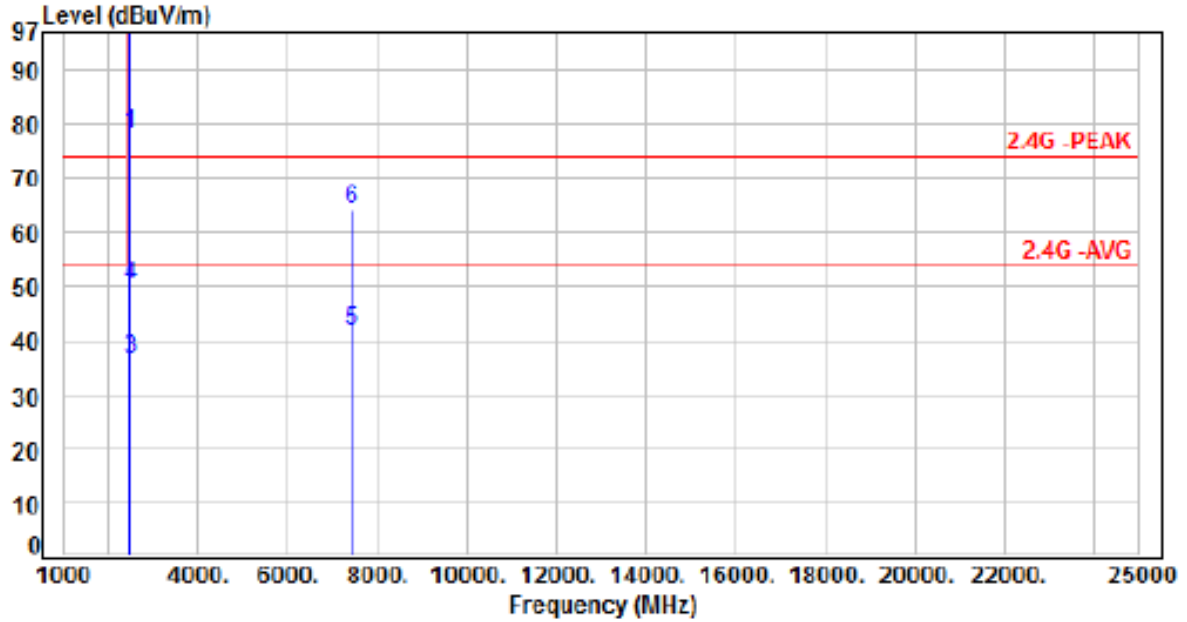

| No. | Frequency (MHz) | Factor (dB) | Reading (dBUV) | Level (dBUV/m) | Limit (dBUV/m) | Margin (dB) | Detector | Height (cm) | Azimuth (deg) | P/F |
|-----|-----------------|-------------|----------------|----------------|----------------|-------------|----------|-------------|---------------|-----|
| 1   | 2480.00         | -3.98       | 82.28          | 78.30          | 200.00         | -121.70     | Average  | 117         | 217           | P   |
| 2   | 2480.00         | -3.98       | 104.78         | 100.80         | 200.00         | -99.20      | Peak     | 117         | 217           | P   |
| 3   | 2483.50         | -3.99       | 40.61          | 36.62          | 54.00          | -17.38      | Average  | 117         | 217           | P   |
| 4   | 2483.50         | -3.99       | 54.05          | 50.06          | 74.00          | -23.94      | Peak     | 117         | 217           | P   |
| 5   | 7440.00         | 10.82       | 30.96          | 41.78          | 54.00          | -12.22      | Average  | 386         | 207           | P   |
| 6   | 7440.00         | 10.82       | 53.46          | 64.28          | 74.00          | -9.72       | Peak     | 386         | 207           | P   |

Note: Level=Reading+Factor  
Margin=Level-Limit  
Factor=Antenna Factor + cable loss - Amplifier Factor





|           |                                   |           |            |
|-----------|-----------------------------------|-----------|------------|
| Power     | : DC 12V From adapter (240V/60Hz) | Pol/Phase | : VERTICAL |
| Test Mode | : Mode 3, CH00                    |           | :          |

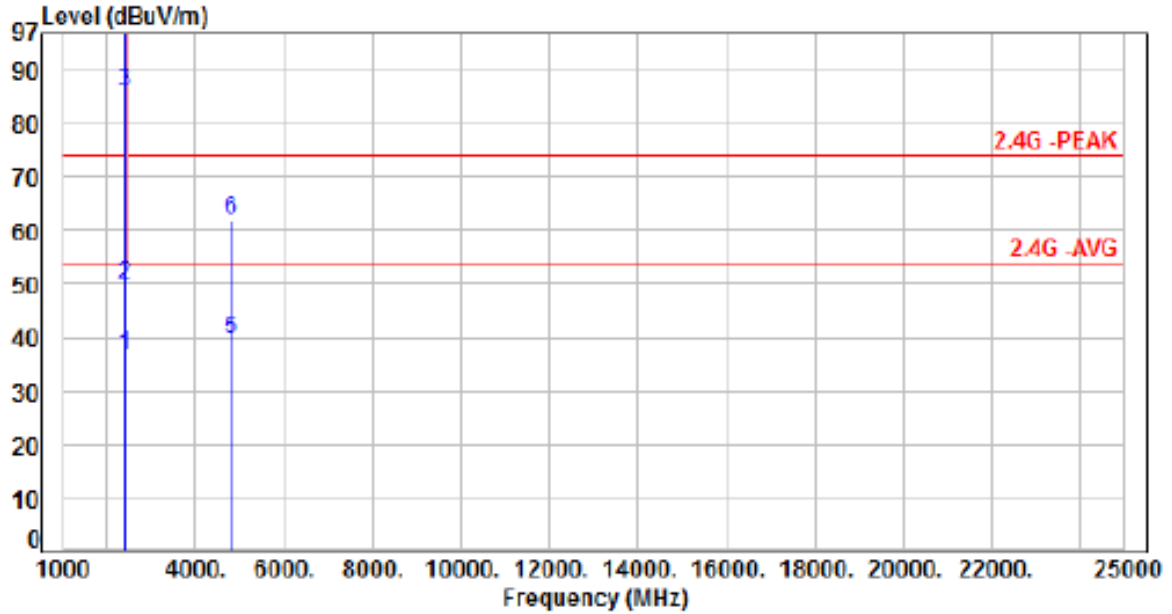

| No. | Frequency (MHz) | Factor (dB) | Reading (dBuV) | Level (dBuV/m) | Limit (dBuV/m) | Margin (dB) | Detector | Height (cm) | Azimuth (deg) | P/F |
|-----|-----------------|-------------|----------------|----------------|----------------|-------------|----------|-------------|---------------|-----|
| 1   | 2390.00         | -3.88       | 40.35          | 36.47          | 54.00          | -17.53      | Average  | 122         | 353           | P   |
| 2   | 2390.00         | -3.88       | 53.49          | 49.61          | 74.00          | -24.39      | Peak     | 122         | 353           | P   |
| 3   | 2402.00         | -3.91       | 89.67          | 85.76          | 200.00         | -114.24     | Average  | 122         | 353           | P   |
| 4   | 2402.00         | -3.91       | 112.17         | 108.26         | 200.00         | -91.74      | Peak     | 122         | 353           | P   |
| 5   | 4804.00         | 4.37        | 35.12          | 39.49          | 54.00          | -14.51      | Average  | 130         | 15            | P   |
| 6   | 4804.00         | 4.37        | 57.62          | 61.99          | 74.00          | -12.01      | Peak     | 130         | 15            | P   |

Note: Level=Reading+Factor  
 Margin=Level-Limit  
 Factor=Antenna Factor + cable loss - Amplifier Factor



|           |   |                                 |           |   |            |
|-----------|---|---------------------------------|-----------|---|------------|
| Power     | : | DC 12V From adapter (240V/60Hz) | Pol/Phase | : | HORIZONTAL |
| Test Mode | : | Mode 3, CH00                    |           | : |            |

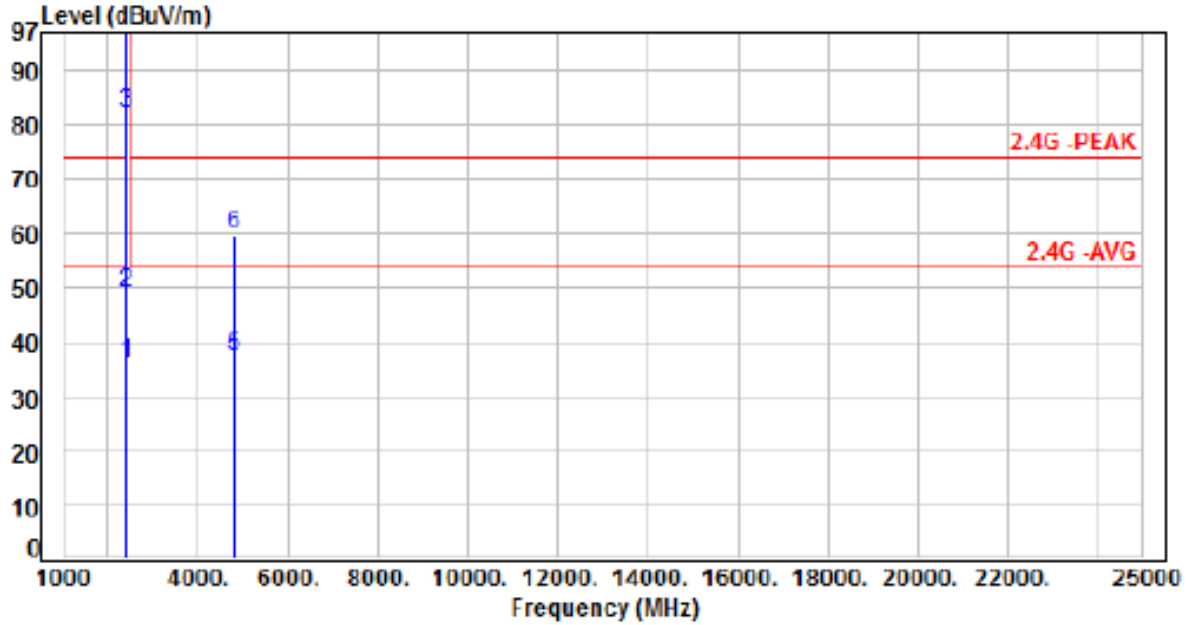

| No. | Frequency (MHz) | Factor (dB) | Reading (dBuV) | Level (dBuV/m) | Limit (dBuV/m) | Margin (dB) | Detector | Height (cm) | Azimuth (deg) | P/F |
|-----|-----------------|-------------|----------------|----------------|----------------|-------------|----------|-------------|---------------|-----|
| 1   | 2390.00         | -3.88       | 39.99          | 36.11          | 54.00          | -17.89      | Average  | 346         | 344           | P   |
| 2   | 2390.00         | -3.88       | 53.11          | 49.23          | 74.00          | -24.77      | Peak     | 346         | 344           | P   |
| 3   | 2402.00         | -3.91       | 86.12          | 82.21          | 200.00         | -117.79     | Average  | 346         | 344           | P   |
| 4   | 2402.00         | -3.91       | 108.62         | 104.71         | 200.00         | -95.29      | Peak     | 346         | 344           | P   |
| 5   | 4804.00         | 4.37        | 32.91          | 37.28          | 54.00          | -16.72      | Average  | 400         | 198           | P   |
| 6   | 4804.00         | 4.37        | 55.41          | 59.78          | 74.00          | -14.22      | Peak     | 400         | 198           | P   |

Note: Level=Reading+Factor  
Margin=Level-Limit  
Factor=Antenna Factor + cable loss - Amplifier Factor



|           |                                   |           |            |
|-----------|-----------------------------------|-----------|------------|
| Power     | : DC 12V From adapter (240V/60Hz) | Pol/Phase | : VERTICAL |
| Test Mode | : Mode 3, CH39                    |           | :          |

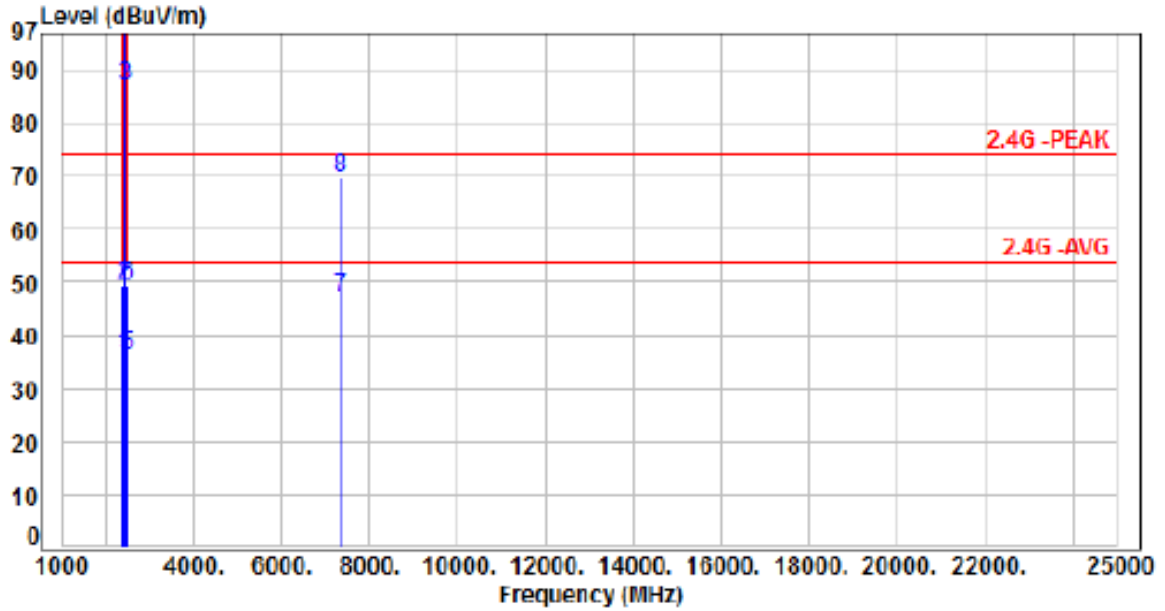

| No. | Frequency (MHz) | Factor (dB) | Reading (dBUV) | Level (dBUV/m) | Limit (dBUV/m) | Margin (dB) | Detector | Height (cm) | Azimuth (deg) | P/F |
|-----|-----------------|-------------|----------------|----------------|----------------|-------------|----------|-------------|---------------|-----|
| 1   | 2390.00         | -3.88       | 40.02          | 36.14          | 54.00          | -17.86      | Average  | 100         | 2             | P   |
| 2   | 2390.00         | -3.88       | 53.13          | 49.25          | 74.00          | -24.75      | Peak     | 100         | 2             | P   |
| 3   | 2441.00         | -3.94       | 90.83          | 86.89          | 200.00         | -113.11     | Average  | 100         | 2             | P   |
| 4   | 2441.00         | -3.94       | 113.33         | 109.39         | 200.00         | -90.61      | Peak     | 100         | 2             | P   |
| 5   | 2483.50         | -3.99       | 40.01          | 36.02          | 54.00          | -17.98      | Average  | 100         | 2             | P   |
| 6   | 2483.50         | -3.99       | 53.27          | 49.28          | 74.00          | -24.72      | Peak     | 100         | 2             | P   |
| 7   | 7323.00         | 10.83       | 36.20          | 47.03          | 54.00          | -6.97       | Average  | 107         | 292           | P   |
| 8   | 7323.00         | 10.83       | 58.70          | 69.53          | 74.00          | -4.47       | Peak     | 107         | 292           | P   |

Note: Level=Reading+Factor  
 Margin=Level-Limit  
 Factor=Antenna Factor + cable loss - Amplifier Factor



|           |   |                                 |           |   |            |
|-----------|---|---------------------------------|-----------|---|------------|
| Power     | : | DC 12V From adapter (240V/60Hz) | Pol/Phase | : | HORIZONTAL |
| Test Mode | : | Mode 3, CH39                    |           | : |            |

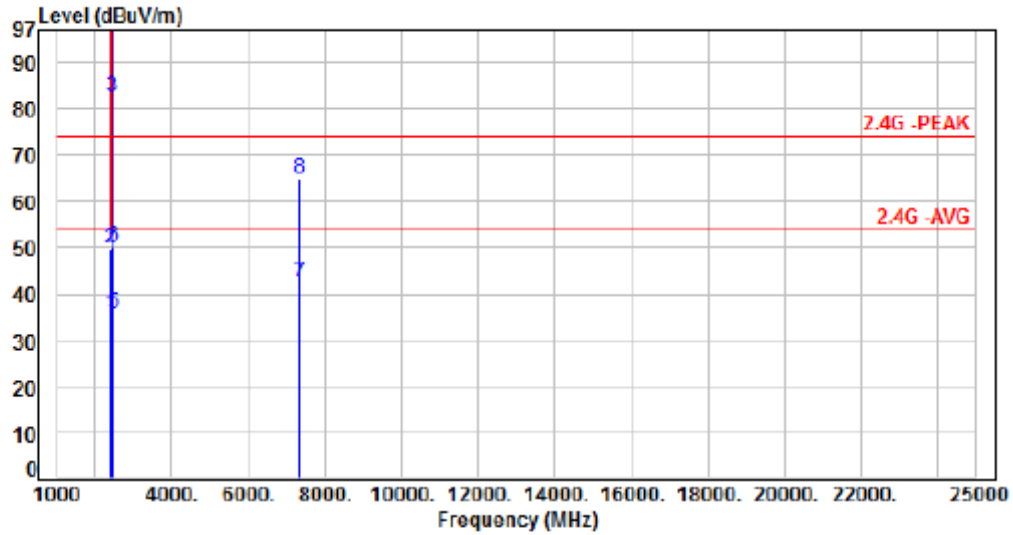

| No. | Frequency (MHz) | Factor (dB) | Reading (dBuV) | Level (dBuV/m) | Limit (dBuV/m) | Margin (dB) | Detector | Height (cm) | Azimuth (deg) | P/F |
|-----|-----------------|-------------|----------------|----------------|----------------|-------------|----------|-------------|---------------|-----|
| 1   | 2390.00         | -3.88       | 39.65          | 35.77          | 54.00          | -18.23      | Average  | 379         | 338           | P   |
| 2   | 2390.00         | -3.88       | 53.85          | 49.97          | 74.00          | -24.03      | Peak     | 379         | 338           | P   |
| 3   | 2441.00         | -3.94       | 86.41          | 82.47          | 200.00         | -117.53     | Average  | 379         | 338           | P   |
| 4   | 2441.00         | -3.94       | 108.91         | 104.97         | 200.00         | -95.03      | Peak     | 379         | 338           | P   |
| 5   | 2483.50         | -3.99       | 39.64          | 35.65          | 54.00          | -18.35      | Average  | 379         | 338           | P   |
| 6   | 2483.50         | -3.99       | 54.28          | 50.29          | 74.00          | -23.71      | Peak     | 379         | 338           | P   |
| 7   | 7323.00         | 10.83       | 31.47          | 42.30          | 54.00          | -11.70      | Average  | 399         | 199           | P   |
| 8   | 7323.00         | 10.83       | 53.97          | 64.80          | 74.00          | -9.20       | Peak     | 399         | 199           | P   |

Note: Level=Reading+Factor  
 Margin=Level-Limit  
 Factor=Antenna Factor + cable loss - Amplifier Factor



|           |                                   |           |            |
|-----------|-----------------------------------|-----------|------------|
| Power     | : DC 12V From adapter (240V/60Hz) | Pol/Phase | : VERTICAL |
| Test Mode | : Mode 3, CH78                    |           | :          |

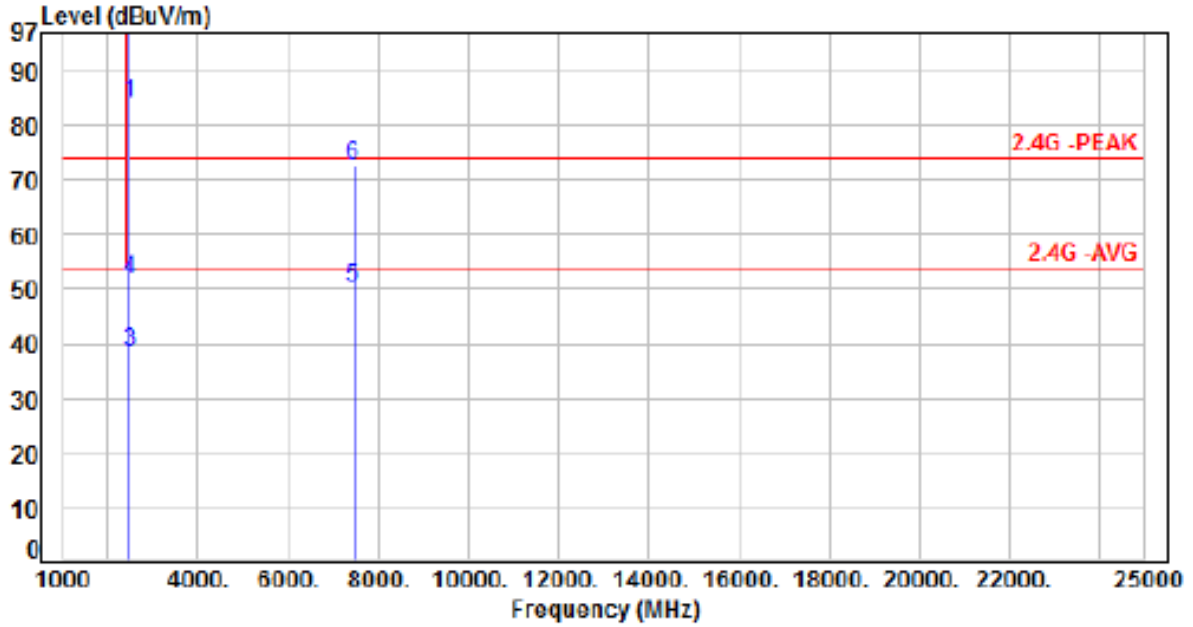

| No. | Frequency (MHz) | Factor (dB) | Reading (dBUV) | Level (dBUV/m) | Limit (dBUV/m) | Margin (dB) | Detector | Height (cm) | Azimuth (deg) | P/F |
|-----|-----------------|-------------|----------------|----------------|----------------|-------------|----------|-------------|---------------|-----|
| 1   | 2480.00         | -3.98       | 88.23          | 84.25          | 200.00         | -115.75     | Average  | 100         | 360           | P   |
| 2   | 2480.00         | -3.98       | 110.73         | 106.75         | 200.00         | -93.25      | Peak     | 100         | 360           | P   |
| 3   | 2483.50         | -3.99       | 42.24          | 36.25          | 54.00          | -15.75      | Average  | 100         | 360           | P   |
| 4   | 2483.50         | -3.99       | 55.79          | 51.80          | 74.00          | -22.20      | Peak     | 100         | 360           | P   |
| 5   | 7440.00         | 10.82       | 39.39          | 50.21          | 54.00          | -3.79       | Average  | 118         | 75            | P   |
| 6   | 7440.00         | 10.82       | 61.89          | 72.71          | 74.00          | -1.29       | Peak     | 118         | 75            | P   |

Note: Level=Reading+Factor

Margin=Level-Limit

Factor=Antenna Factor + cable loss - Amplifier Factor



|           |                                   |           |              |
|-----------|-----------------------------------|-----------|--------------|
| Power     | : DC 12V From adapter (240V/60Hz) | Pol/Phase | : HORIZONTAL |
| Test Mode | : Mode 3, CH78                    |           |              |

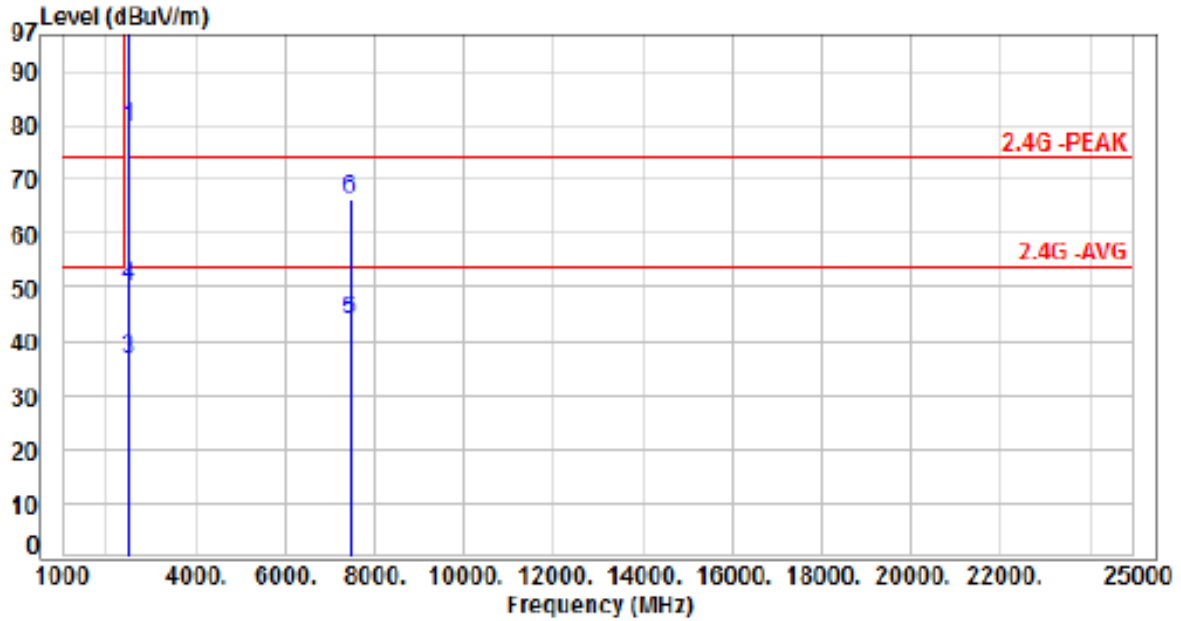

| No. | Frequency (MHz) | Factor (dB) | Reading (dBuV) | Level (dBuV/m) | Limit (dBuV/m) | Margin (dB) | Detector | Height (cm) | Azimuth (deg) | P/F |
|-----|-----------------|-------------|----------------|----------------|----------------|-------------|----------|-------------|---------------|-----|
| 1   | 2480.00         | -3.98       | 83.61          | 79.63          | 200.00         | -120.37     | Average  | 115         | 217           | P   |
| 2   | 2480.00         | -3.98       | 106.11         | 102.13         | 200.00         | -97.87      | Peak     | 115         | 217           | P   |
| 3   | 2483.50         | -3.99       | 40.55          | 36.56          | 54.00          | -17.44      | Average  | 115         | 217           | P   |
| 4   | 2483.50         | -3.99       | 54.11          | 50.12          | 74.00          | -23.88      | Peak     | 115         | 217           | P   |
| 5   | 7440.00         | 10.82       | 33.21          | 44.03          | 54.00          | -9.97       | Average  | 386         | 198           | P   |
| 6   | 7440.00         | 10.82       | 55.71          | 66.53          | 74.00          | -7.47       | Peak     | 386         | 198           | P   |

Note: Level=Reading+Factor  
Margin=Level-Limit  
Factor=Antenna Factor + cable loss - Amplifier Factor



### 7.7 Restricted Bands of Operation

Only spurious emissions are permitted in any of the frequency bands listed below:

| MHz                 | MHz                   | MHz             | GHz             |
|---------------------|-----------------------|-----------------|-----------------|
| 0.09000 – 0.11000   | 16.42000 – 16.42300   | 399.9 – 410.0   | 4.500 – 5.250   |
| 0.49500 – 0.505**   | 16.69475 – 16.69525   | 608.0 – 614.0   | 5.350 – 5.460   |
| 2.17350 – 2.19050   | 16.80425 – 16.80475   | 960.0 – 1240.0  | 7.250 – 7.750   |
| 4.12500 – 4.12800   | 25.50000 – 25.67000   | 1300.0 – 1427.0 | 8.025 – 8.500   |
| 4.17725 – 4.17775   | 37.50000 – 38.25000   | 1435.0 – 1626.5 | 9.000 – 9.200   |
| 4.20725 – 4.20775   | 73.00000 – 74.60000   | 1645.5 – 1646.5 | 9.300 – 9.500   |
| 6.21500 – 6.21800   | 74.80000 – 75.20000   | 1660.0 – 1710.0 | 10.600 – 12.700 |
| 6.26775 – 6.26825   | 108.00000 – 121.94000 | 1718.8 – 1722.2 | 13.250 – 13.400 |
| 6.31175 – 6.31225   | 123.00000 – 138.00000 | 2200.0 – 2300.0 | 14.470 – 14.500 |
| 8.29100 – 8.29400   | 149.90000 – 150.05000 | 2310.0 – 2390.0 | 15.350 – 16.200 |
| 8.36200 – 8.36600   | 156.52475 – 156.52525 | 2483.5 – 2500.0 | 17.700 – 21.400 |
| 8.37625 – 8.38675   | 156.70000 – 156.90000 | 2655.0 – 2900.0 | 22.010 – 23.120 |
| 8.41425 – 8.41475   | 162.01250 – 167.17000 | 3260.0 – 3267.0 | 23.600 – 24.000 |
| 12.29000 – 12.29300 | 167.72000 – 173.20000 | 3332.0 – 3339.0 | 31.200 – 31.800 |
| 12.51975 – 12.52025 | 240.00000 – 285.00000 | 3345.8 – 3358.0 | 36.430 – 36.500 |
| 12.57675 – 12.57725 | 322.00000 – 335.40000 | 3600.0 – 4400.0 | Above 38.6      |
| 13.36000 – 13.41000 |                       |                 |                 |

\*\* : Until February 1, 1999, this restricted band shall be 0.490-0.510 MHz



## 8. Test of Conducted Spurious Emission

### 8.1 Test Limit

According to the methods defined in ANSI C63.10-2013 Section 7.8.8  
Below  $-30\text{dB}$  of the highest emission level of operating band (in 100kHz Resolution Bandwidth).

### 8.2 Test Procedure

According to the methods defined in ANSI C63.10-2013

- a. The transmitter output was connected to the spectrum analyzer via a low loss cable.
- b. Set RBW of spectrum analyzer to 100 KHz and VBW of spectrum analyzer to 300 KHz with convenient frequency span including 100 KHz bandwidth from band edge.
- c. The band edges was measured and recorded.

### 8.3 Test Setup Layout

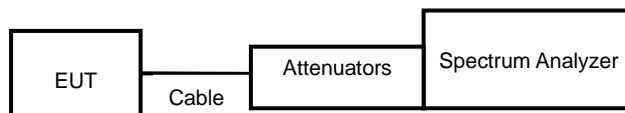

### 8.4 Test Result and Data

Note: Test plots refer to the following pages.





Modulation Type: GFSK (1Mbps)  
Channel: 00

Modulation Type: GFSK (1Mbps)  
Channel: 39

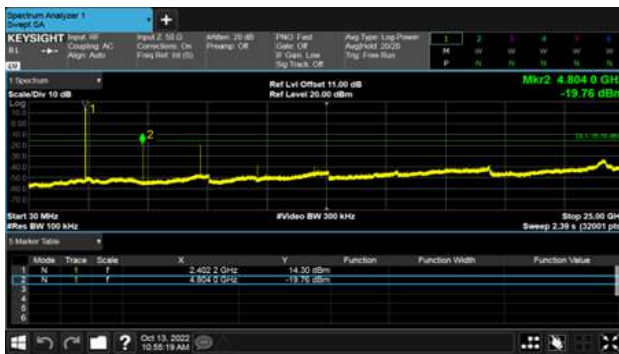
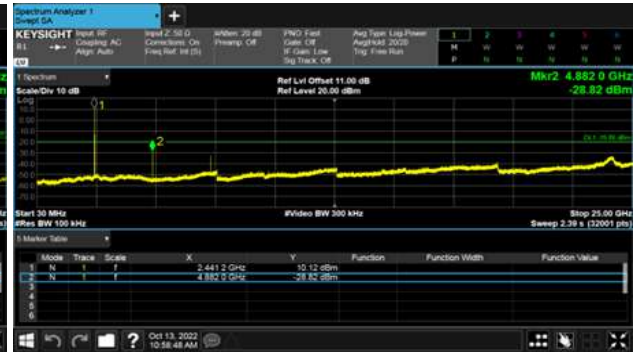
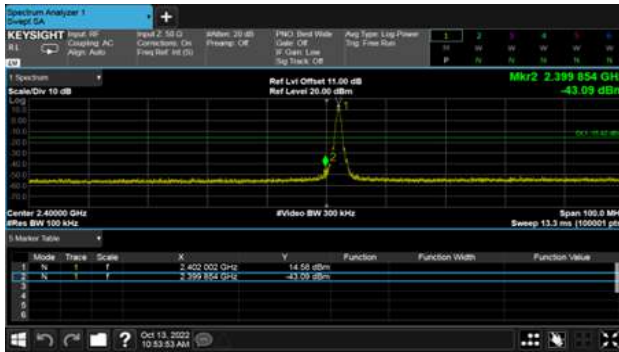



Modulation Type: GFSK (1Mbps)  
Channel: 78

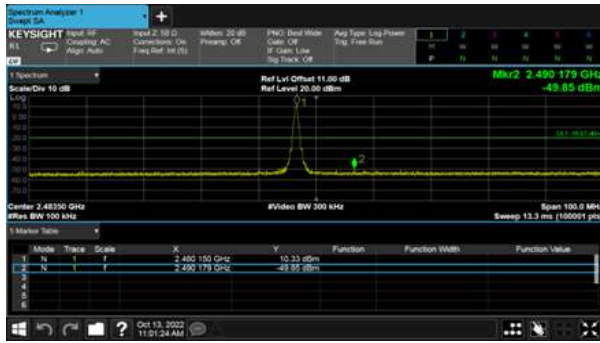

Modulation Type:  $\pi/4$ -DQPSK (2Mbps)  
Channel: 00

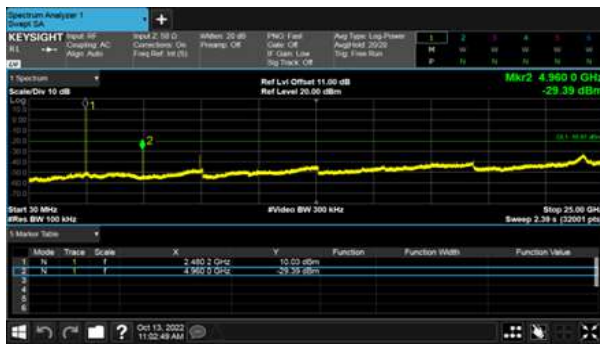
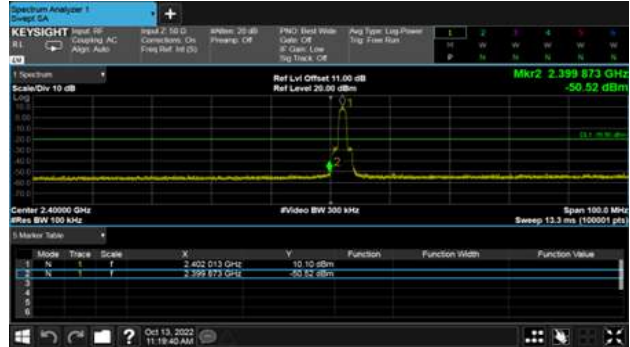



Modulation Type:  $\pi/4$ -DQPSK (2Mbps)  
Channel: 39



Modulation Type:  $\pi/4$ -DQPSK (2Mbps)  
Channel: 78

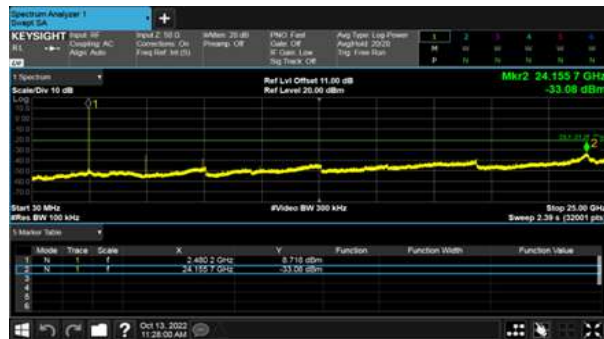
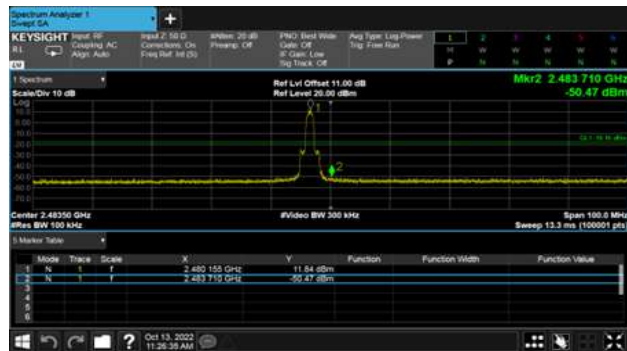



Modulation Type: 8DPSK (3Mbps)  
Channel: 00

Modulation Type: 8DPSK (3Mbps)  
Channel: 39

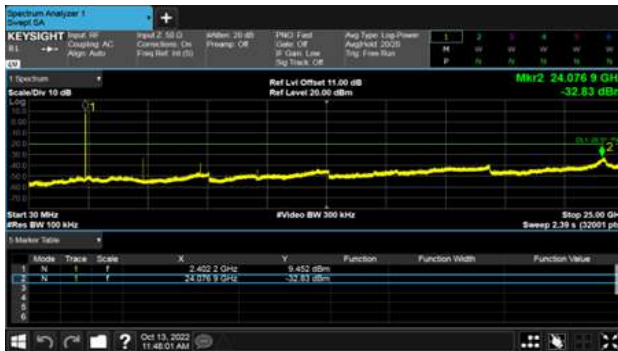
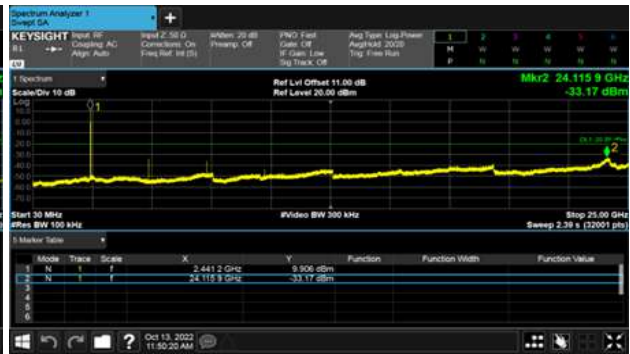
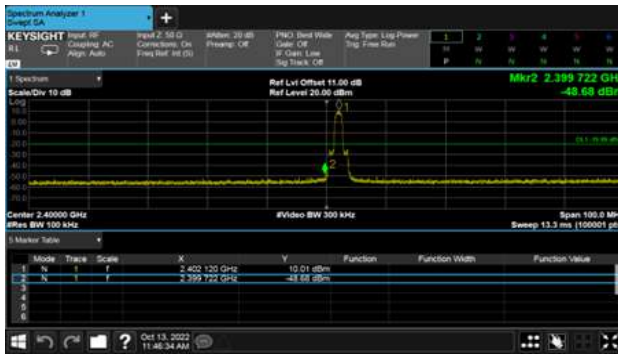



Modulation Type: 8DPSK (3Mbps)  
Channel: 78

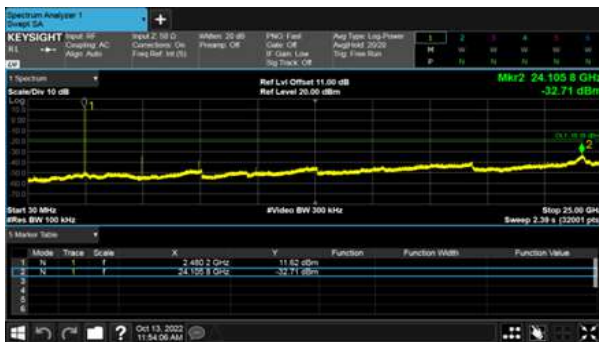
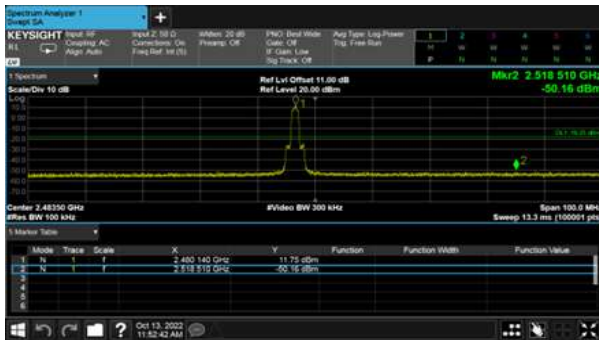



Hopping Mode: Modulation Type: GFSK



Modulation Type:  $\pi/4$ -DQPSK

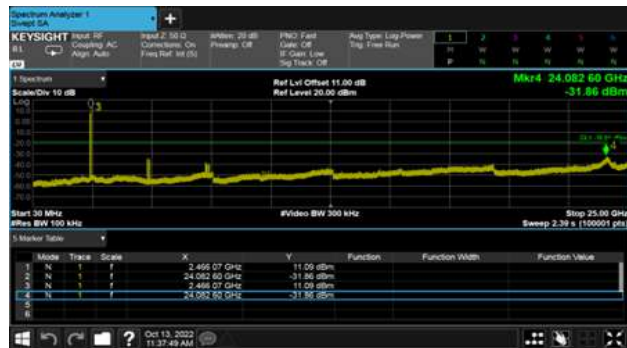
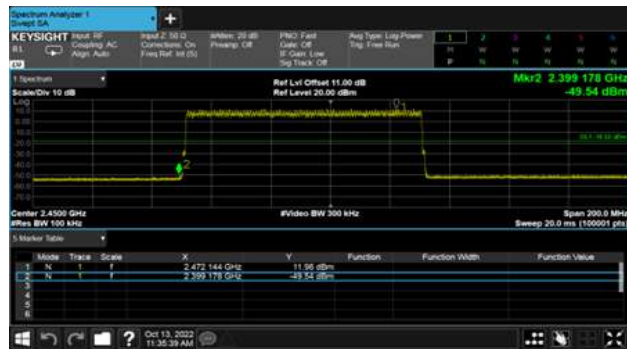



Modulation Type: 8DPSK





## 9. 20dB Bandwidth Measurement Data

### 9.1 Test Limit

For reference data.

### 9.2 Test Procedures

According to the methods defined in ANSI C63.10-2013 Section 6.9

- a. The transmitter output was connected to the spectrum analyzer.
- b. Set RBW of spectrum analyzer to 1% to 5% of the 20dB Bandwidth and VBW to approximately three times RBW.
- c. The 20 dB bandwidth is defined as the total spectrum the power of which is higher than peak power minus 20 dB.

### 9.3 Test Setup Layout

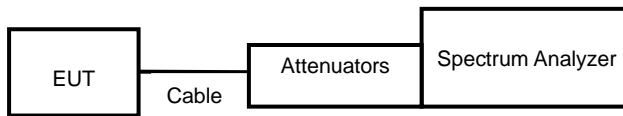

### 9.4 Test Result and Data

| Modulation Type | Channel | Frequency (MHz) | 20dB Bandwidth (MHz) | 2/3 20dB Bandwidth (MHz) |
|-----------------|---------|-----------------|----------------------|--------------------------|
| GFSK            | 0       | 2402            | 0.936                | 0.624                    |
|                 | 39      | 2441            | 0.939                | 0.626                    |
|                 | 78      | 2480            | 0.943                | 0.629                    |
| $\pi/4$ -DQPSK  | 0       | 2402            | 1.315                | 0.877                    |
|                 | 39      | 2441            | 1.315                | 0.877                    |
|                 | 78      | 2480            | 1.313                | 0.875                    |
| 8DPSK           | 0       | 2402            | 1.307                | 0.871                    |
|                 | 39      | 2441            | 1.307                | 0.871                    |
|                 | 78      | 2480            | 1.305                | 0.870                    |





Modulation Type: GFSK (1Mbps)  
Channel: 00



Modulation Type:  $\pi/4$ -DQPSK (2Mbps)  
Channel: 00



CH39



CH39



CH78



CH78





Modulation Type: 8DPSK (3Mbps)  
Channel: 00



CH39



CH78





## 10. Carrier Frequency Separation

### 10.1 Test Limit

Frequency hopping systems shall have hopping channel carrier frequencies separated by a minimum of 25 kHz or the 20 dB bandwidth of the hopping channel, whichever is greater. Alternatively, frequency hopping systems operating in the 2400–2483.5 MHz band may have hopping channel carrier frequencies that are separated by 25 kHz or two-thirds of the 20 dB bandwidth of the hopping channel, whichever is greater, provided the systems operate with an output power no greater than 125 mW.

### 10.2 Test Procedures

According to the methods defined in ANSI C63.10-2013 Section 7.8.2

- a. The transmitter output was connected to the spectrum analyzer.
- b. Set RBW of spectrum analyzer to 300 KHz and VBW to 1000 KHz.
- c. By using the MaxHold function record the separation of two adjacent channels.
- d. Measure the frequency difference of these two adjacent channels.

### 10.3 Test Setup Layout

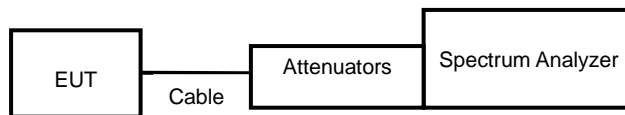

### 10.4 Test Result and Data

| Modulation Type | Channel | Frequency (MHz) | Channel Separation (MHz) | Limit (MHz) |
|-----------------|---------|-----------------|--------------------------|-------------|
| GFSK            | 0       | 2402            | 1.002                    | 0.624       |
|                 | 39      | 2441            | 1.002                    | 0.626       |
|                 | 78      | 2480            | 1.002                    | 0.629       |
| π/4-DQPSK       | 0       | 2402            | 1.002                    | 0.877       |
|                 | 39      | 2441            | 1.002                    | 0.877       |
|                 | 78      | 2480            | 1.002                    | 0.875       |
| 8DPSK           | 0       | 2402            | 1.002                    | 0.871       |
|                 | 39      | 2441            | 1.002                    | 0.871       |
|                 | 78      | 2480            | 1.002                    | 0.870       |



Modulation Type: GFSK (1Mbps)  
Channel: 00

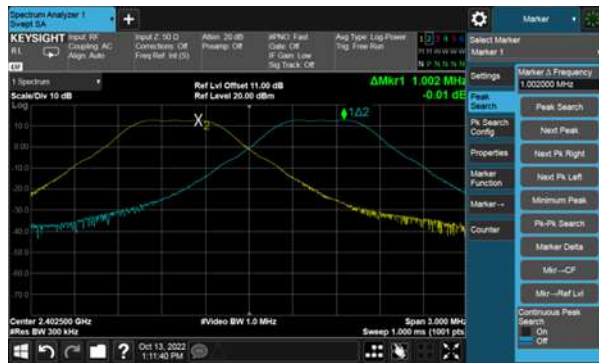

Modulation Type:  $\pi/4$ -DQPSK (2Mbps)  
Channel: 00

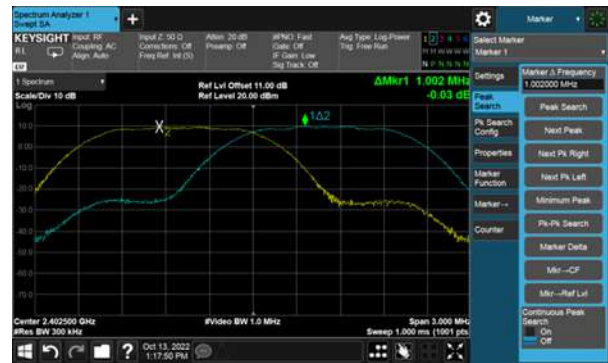

CH39

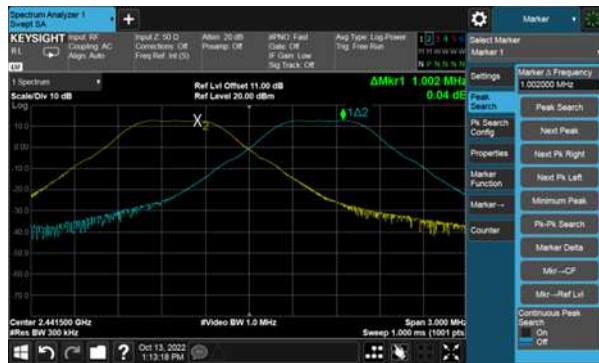

CH39

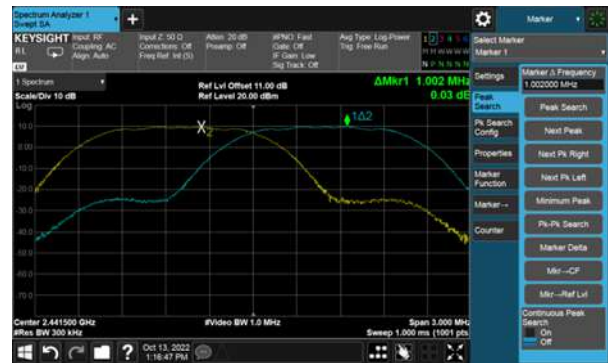

CH78

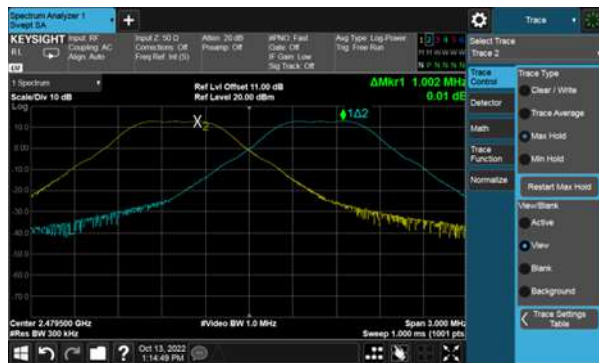

CH78





Modulation Type: 8DPSK (3Mbps)  
Channel: 00



CH39

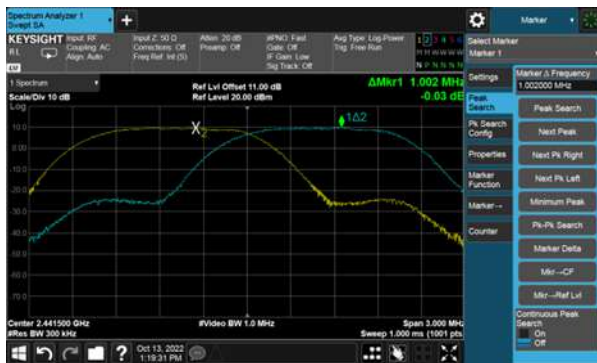

CH78

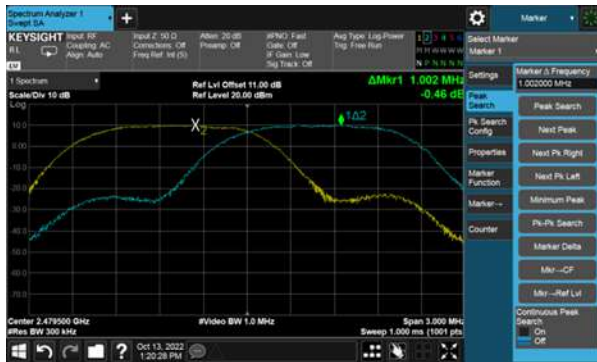



## 11. Dwell Time on each channel

### 11.1 Test Limit

The average time of occupancy on any channel shall not be greater than 0.4 seconds within a period of 0.4 seconds multiplied by the number of hopping channels employed.

### 11.2 Test Procedures

According to the methods defined in ANSI C63.10-2013 Section 7.8.4

1. The transmitter output was connected to the spectrum analyzer.
2. Adjust the center frequency to measure frequency, then set zero span mode.
3. Set RBW of spectrum analyzer to 300KHz and VBW to 1MHz.
4. Measure the time duration of one transmission on the measured frequency.

### 11.3 Test Setup Layout

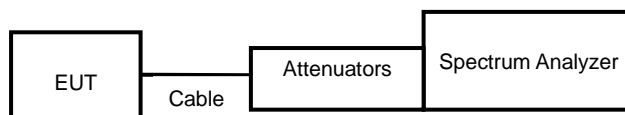



### 11.4 Test Result and Data

| Modulation Type    | Frequency (MHz) | Length of transmission time (ms) | Number of transmission in a 31.6 (79 Hopping*0.4) | Dwell Time (ms) | Limit (ms) |
|--------------------|-----------------|----------------------------------|---|-----------------|------------|
| GFSK-DH1           | 2402            | 0.406                            | 320.00  | 129.92          | 400        |
| GFSK-DH3           | 2402            | 1.664                            | 160.00  | 266.24          | 400        |
| GFSK-DH5           | 2402            | 2.912                            | 106.67  | 310.61          | 400        |
| $\pi/4$ -DQPSK-DH1 | 2402            | 0.402                            | 320.00  | 128.64          | 400        |
| $\pi/4$ -DQPSK-DH3 | 2402            | 1.658                            | 160.00  | 265.28          | 400        |
| $\pi/4$ -DQPSK-DH5 | 2402            | 2.908                            | 106.67  | 310.19          | 400        |
| 8DPSK-DH1          | 2402            | 0.402                            | 320.00  | 128.64          | 400        |
| 8DPSK-DH3          | 2402            | 1.658                            | 160.00  | 265.28          | 400        |
| 8DPSK-DH5          | 2402            | 2.912                            | 106.67  | 310.61          | 400        |

| Modulation Type | Frequency (MHz) | Length of transmission time (ms) | Number of transmission in a 8 (20 Hopping*0.4) | Dwell Time (ms) | Limit (ms) |
|-----------------|-----------------|----------------------------------|--|-----------------|------------|
| AFH-DH1         | 2402-2421       | 0.402                            | 160.00   | 64.32           | 400        |
| AFH-DH3         | 2402-2421       | 1.658                            | 80.00  | 132.64          | 400        |
| AFH-DH5         | 2402-2421       | 2.912                            | 53.33  | 155.30          | 400        |



Modulation Type: GFSK-DH1  
Channel: 00



Modulation Type:  $\pi/4$ -DQPSK-DH1  
Channel: 00



Modulation Type: GFSK-DH3  
Channel: 00



Modulation Type:  $\pi/4$ -DQPSK-DH3  
Channel: 00



Modulation Type: GFSK-DH5  
Channel: 00



Modulation Type:  $\pi/4$ -DQPSK-DH5  
Channel: 00







Modulation Type: 8DPSK-DH1  
Channel: 00



Modulation Type: AFH (DH1)



Modulation Type: 8DPSK-DH3  
Channel: 00



Modulation Type: AFH (DH3)



Modulation Type: 8DPSK-DH5  
Channel: 00



Modulation Type: AFH (DH5)





## 12. Number of Hopping Channels

### 12.1 Test Limit

Frequency hopping systems in the 2400 ~ 2483.5 MHz band shall use at least 15 channels.

### 12.2 Test Procedures

According to the methods defined in ANSI C63.10-2013 Section 7.8.3

- a. The transmitter output was connected to the spectrum analyzer.
- b. 2. Set RBW of spectrum analyzer to 100 KHz and VBW to 300 KHz.
- c. 3. Set the MaxHold function, and then keep the EUT in hopping mode. Record all the signals from each channel until each one has been record.

### 12.3 Test Setup Layout

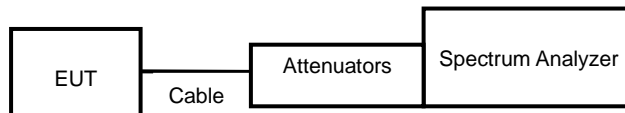

### 12.4 Test Result and Data

| Modulation Type | Hopping Channels |
|-----------------|------------------|
| GFSK            | 79               |
| $\pi/4$ -DQPSK  | 79               |
| 8DPSK           | 79               |



Modulation Type: GFSK (1Mbps)



Modulation Type:  $\pi/4$ -DQPSK (2Mbps)



Modulation Type: 8DPSK (3Mbps)





## 13. Maximum Average Output Power

### 13.1 Test Limit

The Maximum Average Output Power Measurement is 30dBm.

### 13.2 Test Procedures

According to the methods defined in ANSI C63.10-2013 Section 7.8.5

The antenna port( RF output )of the EUT was connected to the input( RF input )of a power meter.

Power was read directly from the meter and cable loss connection was added to the reading to obtain power at the EUT antenna terminal. The EUT Output Power was set to maximum to produce the worse case test result.

### 13.3 Test Setup Layout

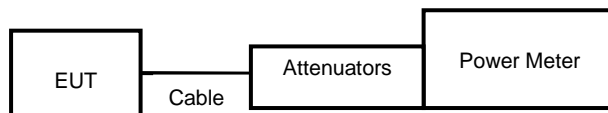

### 13.4 Test Result and Data

| Modulation Type | Channel | Frequency (MHz) | AV Output Power (dBm) | AV Output Power (mW) |
|-----------------|---------|-----------------|-----------------------|----------------------|
| GFSK            | 0       | 2402            | 14.84                 | 30.479               |
|                 | 39      | 2441            | 8.83                  | 7.638                |
|                 | 78      | 2480            | 8.87                  | 7.709                |
| $\pi/4$ -DQPSK  | 0       | 2402            | 11.10                 | 12.882               |
|                 | 39      | 2441            | 10.90                 | 12.303               |
|                 | 78      | 2480            | 10.91                 | 12.331               |
| 8DPSK           | 0       | 2402            | 11.11                 | 12.912               |
|                 | 39      | 2441            | 10.91                 | 12.331               |
|                 | 78      | 2480            | 10.93                 | 12.388               |

#### AFH Mode

| Modulation Type | Channel | Frequency (MHz) | AV Output Power (dBm) | AV Output Power (mW) |
|-----------------|---------|-----------------|-----------------------|----------------------|
| GFSK            | 0-19    | 2402-2421       | 14.81                 | 30.269               |
| $\pi/4$ -DQPSK  | 0-19    | 2402-2421       | 11.11                 | 12.912               |
| 8DPSK           | 0-19    | 2402-2421       | 11.09                 | 12.853               |