

FCC RADIO TEST REPORT

FCC 47 CFR PART 15 SUBPART E

Test Standard **FCC Part 15.407**
FCC ID **PPQ-WP8331**
Product name **802.11ac Dual Band PoE Access Point**

**Brand name /
Model No.**

Model No.	Brand name
C-100	MOJO WatchGuard
WP8331	LITE-ON
AP200	WatchGuard

Test Result **Pass**

The test Result was tested by Compliance Certification Services Inc. The test data, data evaluation, test procedures, and equipment configurations shown in this report were given in ANSI C63.10: 2013 and compliance standards.

The test results of this report relate only to the tested sample (EUT) identified in this report.

The test Report of full or partial shall not copy. Without written approval of CCS. Inc.

The sample selected for test was production product and was provided by manufacturer.



Approved by:

Reviewed by:

Sam Chuang

Zeus Chen

Sam Chuang
Manager

Zeus Chen
Supervisor

Revision History

Rev.	Issue Date	Revisions	Revised By
00	November 22, 2016	Initial Issue	Angel Cheng
01	December 10, 2016	P6. Addressed calculations of the directional antenna gains. P32, Addressed calculations of the directional antenna gains P35, Addressed calculations of the directional antenna gains	Angel Cheng

Table of contents

1. GENERAL INFORMATION	4
1.1 EUT INFORMATION.....	4
1.2 EUT CHANNEL INFORMATION	5
1.3 ANTENNA INFORMATION	6
1.4 MEASUREMENT UNCERTAINTY.....	7
1.5 FACILITIES AND TEST LOCATION	8
1.6 INSTRUMENT CALIBRATION	8
1.7 SUPPORT AND EUT ACCESSORIES EQUIPMENT	9
1.9 TABLE OF ACCREDITATIONS AND LISTINGS	9
2. TEST SUMMERY	10
3. DESCRIPTION OF TEST MODES	11
3.1 THE WORST MODE OF OPERATING CONDITION	11
3.2 THE WORST MODE OF MEASUREMENT	12
3.3 EUT DUTY CYCLE.....	13
4. TEST RESULT	14
4.1 AC POWER LINE CONDUCTED EMISSION	14
4.2 26DB BANDWIDTH, 6DB BANDWIDTH AND OCCUPIED BANDWIDTH(99%).....	17
4.3 OUTPUT POWER MEASUREMENT	32
4.4 POWER SPECTRAL DENSITY	35
4.5 RADIATION BANEDGE AND SPURIOUS EMISSION	50
4.6 FREQUENCY STABILITY	122
APPENDIX 1 - PHOTOGRAPHS OF EUT	

1. GENERAL INFORMATION

1.1 EUT INFORMATION

Applicant	Lite-On Technology Corp. Bldg. C, 90, Chien 1 Road, Chung Ho, New Taipei City 23585, Taiwan, R.O.C																																																										
Equipment	802.11ac Dual Band PoE Access Point																																																										
Brand name / Model No.	Model No.	Brand name																																																									
	C-100	MOJO																																																									
	WP8331	WatchGuard																																																									
	AP200	LITE-ON																																																									
Model Discrepancy	All the specification and layout are identical except they come with different model numbers for marketing purposes.																																																										
EUT Functions	IEEE 802.11abgn+ac+BT																																																										
Received Date	Nov 2, 2016																																																										
Date of Test	Nov 5 ~ 17, 2016																																																										
Output Power	<table border="1"> <thead> <tr> <th>Band</th> <th>Mode</th> <th>Frequency Range (MHz)</th> <th>Output Power (dBm)</th> <th>Output Power (w)</th> </tr> </thead> <tbody> <tr> <td rowspan="6">U-NII-1</td> <td>IEEE 802.11a</td> <td>5180 ~ 5240</td> <td>25.60</td> <td>0.3631</td> </tr> <tr> <td>IEEE 802.11n HT 20 MHz</td> <td>5180 ~ 5240</td> <td>25.07</td> <td>0.3214</td> </tr> <tr> <td>IEEE 802.11n HT 40 MHz</td> <td>5190 ~ 5230</td> <td>24.64</td> <td>0.2911</td> </tr> <tr> <td>IEEE 802.11ac VHT 20 MHz</td> <td>5180 ~ 5240</td> <td>24.97</td> <td>0.3141</td> </tr> <tr> <td>IEEE 802.11ac VHT 40 MHz</td> <td>5190 ~ 5230</td> <td>25.07</td> <td>0.3214</td> </tr> <tr> <td>IEEE 802.11ac VHT 80 MHz</td> <td>5210</td> <td>20.88</td> <td>0.1225</td> </tr> <tr> <td rowspan="6">U-NII-3</td> <td>IEEE 802.11a</td> <td>5745 ~ 5825</td> <td>25.02</td> <td>0.3177</td> </tr> <tr> <td>IEEE 802.11n HT 20 MHz</td> <td>5745 ~ 5825</td> <td>24.80</td> <td>0.3020</td> </tr> <tr> <td>IEEE 802.11n HT 40 MHz</td> <td>5755 ~ 5795</td> <td>24.12</td> <td>0.2582</td> </tr> <tr> <td>IEEE 802.11ac VHT 20 MHz</td> <td>5745 ~ 5825</td> <td>24.80</td> <td>0.3020</td> </tr> <tr> <td>IEEE 802.11ac VHT 40 MHz</td> <td>5755 ~ 5795</td> <td>24.03</td> <td>0.2529</td> </tr> <tr> <td>IEEE 802.11ac VHT 80 MHz</td> <td>5775</td> <td>20.53</td> <td>0.1130</td> </tr> </tbody> </table>				Band	Mode	Frequency Range (MHz)	Output Power (dBm)	Output Power (w)	U-NII-1	IEEE 802.11a	5180 ~ 5240	25.60	0.3631	IEEE 802.11n HT 20 MHz	5180 ~ 5240	25.07	0.3214	IEEE 802.11n HT 40 MHz	5190 ~ 5230	24.64	0.2911	IEEE 802.11ac VHT 20 MHz	5180 ~ 5240	24.97	0.3141	IEEE 802.11ac VHT 40 MHz	5190 ~ 5230	25.07	0.3214	IEEE 802.11ac VHT 80 MHz	5210	20.88	0.1225	U-NII-3	IEEE 802.11a	5745 ~ 5825	25.02	0.3177	IEEE 802.11n HT 20 MHz	5745 ~ 5825	24.80	0.3020	IEEE 802.11n HT 40 MHz	5755 ~ 5795	24.12	0.2582	IEEE 802.11ac VHT 20 MHz	5745 ~ 5825	24.80	0.3020	IEEE 802.11ac VHT 40 MHz	5755 ~ 5795	24.03	0.2529	IEEE 802.11ac VHT 80 MHz	5775	20.53	0.1130
Band	Mode	Frequency Range (MHz)	Output Power (dBm)	Output Power (w)																																																							
U-NII-1	IEEE 802.11a	5180 ~ 5240	25.60	0.3631																																																							
	IEEE 802.11n HT 20 MHz	5180 ~ 5240	25.07	0.3214																																																							
	IEEE 802.11n HT 40 MHz	5190 ~ 5230	24.64	0.2911																																																							
	IEEE 802.11ac VHT 20 MHz	5180 ~ 5240	24.97	0.3141																																																							
	IEEE 802.11ac VHT 40 MHz	5190 ~ 5230	25.07	0.3214																																																							
	IEEE 802.11ac VHT 80 MHz	5210	20.88	0.1225																																																							
U-NII-3	IEEE 802.11a	5745 ~ 5825	25.02	0.3177																																																							
	IEEE 802.11n HT 20 MHz	5745 ~ 5825	24.80	0.3020																																																							
	IEEE 802.11n HT 40 MHz	5755 ~ 5795	24.12	0.2582																																																							
	IEEE 802.11ac VHT 20 MHz	5745 ~ 5825	24.80	0.3020																																																							
	IEEE 802.11ac VHT 40 MHz	5755 ~ 5795	24.03	0.2529																																																							
	IEEE 802.11ac VHT 80 MHz	5775	20.53	0.1130																																																							
Power Operation	<input checked="" type="checkbox"/> AC 120V/60Hz <input checked="" type="checkbox"/> Adapter(Not for sale) <input checked="" type="checkbox"/> PoE(Not for sale) <input type="checkbox"/> DC Type : <input type="checkbox"/> Battery <input type="checkbox"/> DC Power Supply <input type="checkbox"/> External DC adapter																																																										

Remark:

All listed models are using an identical RF module with the only differences on number of key buttons mounted for additional functions.

Due to similarity of RF product constructions of given model series, only dedicated model as described in test report with the most complexity constructions was selected for testing and record.

1.2 EUT CHANNEL INFORMATION

Frequency Range	IEEE 802.11a	5180 ~ 5240 MHz
	IEEE 802.11n HT 20 MHz	5180 ~ 5240 MHz
	IEEE 802.11n HT 40 MHz	5190 ~ 5230 MHz
	IEEE 802.11ac VHT 20 MHz	5180 ~ 5240 MHz
	IEEE 802.11ac VHT 40 MHz	5190 ~ 5230 MHz
	IEEE 802.11ac VHT 80 MHz	5210 MHz
	IEEE 802.11a	5745 ~ 5825 MHz
	IEEE 802.11n HT 20 MHz	5745 ~ 5825 MHz
	IEEE 802.11n HT 40 MHz	5755 ~ 5795 MHz
	IEEE 802.11ac VHT 20 MHz	5745 ~ 5825 MHz
	IEEE 802.11ac VHT 40 MHz	5755 ~ 5795 MHz
	IEEE 802.11ac VHT 80 MHz	5775 MHz
Modulation Type	1. IEEE 802.11a mode: OFDM 2. IEEE 802.11n HT 20 MHz mode: OFDM 3. IEEE 802.11n HT 40 MHz mode: OFDM 4. IEEE 802.11ac VHT 20 MHz mode: OFDM 5. IEEE 802.11ac VHT 40 MHz mode: OFDM 5. IEEE 802.11ac VHT 80 MHz mode: OFDM	

Remark:

Refer as ANSI 63.10:2013 clause 5.6.1 Table 4 for test channels

Number of frequencies to be tested		
Frequency range in which device operates	Number of frequencies	Location in frequency range of operation
<input type="checkbox"/> 1 MHz or less	1	Middle
<input type="checkbox"/> 1 MHz to 10 MHz	2	1 near top and 1 near bottom
<input checked="" type="checkbox"/> More than 10 MHz	3	1 near top, 1 near middle, and 1 near bottom

1.3 ANTENNA INFORMATION

Antenna Category	<input checked="" type="checkbox"/> Integral: antenna permanently attached <input type="checkbox"/> External dedicated antennas <input type="checkbox"/> External Unique antenna connector
Antenna Type	<input checked="" type="checkbox"/> PIFA <input type="checkbox"/> PCB for <input type="checkbox"/> Dipole <input type="checkbox"/> Printed <input type="checkbox"/> Coils
Antenna Gain	1. 5150-5250MHz <input checked="" type="checkbox"/> Ant 1: 3.8 (dBi) <input checked="" type="checkbox"/> Ant 2: 5.0 (dBi) 2. 5725-5850MHz <input checked="" type="checkbox"/> Ant 1: 5.1 (dBi) <input checked="" type="checkbox"/> Ant 2: 4.1 (dBi)
Power Directional gain	1. 5150-5250MHz : 4.44 dBi 2. 5725-5850MHz : 4.63 dBi
PSD Directional gain	1. 5150-5250MHz : 7.45 dBi 2. 5725-5850MHz : 7.64 dBi

Remark :

For UNII-1(5150-5250MHz):

1. Power Directional gain= $10\log(((10^{(Ant1/10)}+10^{(Ant2/10)})/2))=10\log(((10^{(3.8/10)}+10^{(5/10)})/2))=4.44$ dBi

2. Power Density Directional gain= $10\log(((10^{(Ant1/10)}+10^{(Ant2/10)})/2))+10\log(N_{Tx}/N_{Ss})$

= $10\log(((10^{(3.8/10)}+10^{(5/10)})/2))+10\log(2/1)=7.45$ dBi

For UNII-3(5725-5850MHz):

1. Power Directional gain= $10\log(((10^{(Ant1/10)}+10^{(Ant2/10)})/2))=10\log(((10^{(5.1/10)}+10^{(4.1/10)})/2))=4.63$ dBi

2. Power Density Directional gain= $10\log(((10^{(Ant1/10)}+10^{(Ant2/10)})/2))+10\log(N_{Tx}/N_{Ss})$

= $10\log(((10^{(5.1/10)}+10^{(4.1/10)})/2))+10\log(2/1)=7.64$ dBi

1.4 MEASUREMENT UNCERTAINTY

PARAMETER	UNCERTAINTY
AC Powerline Conducted Emission	+/- 1.2575
Emission bandwidth, 20dB bandwidth	+/- 1.4003
RF output power, conducted	+/- 1.1372
Power density, conducted	+/- 1.4003
3M Semi Anechoic Chamber / 30M~200M	+/- 4.0138
3M Semi Anechoic Chamber / 200M~1000M	+/- 3.9483
3M Semi Anechoic Chamber / 1G~8G	+/- 2.5975
3M Semi Anechoic Chamber / 8G~18G	+/- 2.6112
3M Semi Anechoic Chamber / 18G~26G	+/- 2.7389
3M Semi Anechoic Chamber / 26G~40G	+/- 2.9683
3M Semi Anechoic Chamber / 40G~60G	+/- 1.8509
3M Semi Anechoic Chamber / 60G~75G	+/- 1.9869
3M Semi Anechoic Chamber / 75G~110G	+/- 2.9651
3M Semi Anechoic Chamber / 110G~170G	+/- 2.7807
3M Semi Anechoic Chamber / 170G~220G	+/- 3.6437
3M Semi Anechoic Chamber / 220G~325G	+/- 4.2982

Remark:

1. This uncertainty represents an expanded uncertainty expressed at approximately the 95% confidence level using a coverage factor of $k=2$
2. ISO/IEC 17025 requires that an estimate of the measurement uncertainties associated with the emissions test results be included in the report.

1.5 FACILITIES AND TEST LOCATION

All measurement facilities used to collect the measurement data are located at No.11, Wugong 6th Rd., Wugu Dist., New Taipei City 24891, Taiwan. (R.O.C.)

Test site	Test Engineer	Remark
AC Conduction Room	Anderson Kuo	
Radiation	Dennis Li	
RF Conducted	Ian Tu	

Remark: The sites are constructed in conformance with the requirements of ANSI C63.7, ANSI C63.4 and CISPR Publication 22.

1.6 INSTRUMENT CALIBRATION

RF Conducted Test Site				
Equipment	Manufacturer	Model	S/N	Cal Due
Spectrum Analyzer 10Hz-40GHz	R&S	FSV 40	101073	07/31/2017

3M 966 Chamber Test Site				
Equipment	Manufacturer	Model	S/N	Cal Due
Spectrum Analyzer	Agilent	E4446A	US42510252	12/07/2016
Loop Ant	COM-POWER	AL-130	121051	02/24/2017
Bilog Antenna	Sunol Sciences	JB3	A030105	07/02/2017
Pre-Amplifier	EMEC	EM330	60609	06/07/2017
Horn Antenna	ETC	MCTD 1209	DRH13M02003	09/01/2017
Pre-Amplifier	MITEQ	AMF-6F-260400-40-8P	985646	01/13/2017
Horn Antenna	EMCO	3116	26370	01/14/2017
Antenna Tower	CCS	CC-A-1F	N/A	N.C.R
Controller	CCS	CC-C-1F	N/A	N.C.R
Turn Table	CCS	CC-T-1F	N/A	N.C.R

AC Conducted Emissions Test Site				
Equipment	Manufacturer	Model	S/N	Cal Due
LISN	R&S	ENV216	101054	05/10/2017
Receiver	R&S	ESCI	101073	08/19/2017

Remark: Each piece of equipment is scheduled for calibration once a year.

1.7 SUPPORT AND EUT ACCESSORIES EQUIPMENT



EUT Accessories Equipment					
No.	Equipment	Brand	Model	Series No.	FCC ID
1	Adapter	APD	WB-18D-12FU	N/A	N/A
2	PoE	I.T.E	PW130	N/A	N/A

Support Equipment					
No.	Equipment	Brand	Model	Series No.	FCC ID
1	Notebook	ASUS	A&J	N/A	PD9WM3945ABG
2	Notebook	ASUS	K45V	N/A	PPD-AR5B225

1.8 Test methodology and applied standards

The test methodology, setups and results comply with all requirements in accordance with ANSI C63.10:2013, FCC Part 2, FCC Part 15.407, KDB 662911 D01 v02r01, KDB 789033 D02 v01r03, KDB 644545 D03 v01.

1.9 TABLE OF ACCREDITATIONS AND LISTINGS

Country	Agency	Scope of Accreditation	Logo
USA	FCC	3M Semi Anechoic Chamber (FCC MRA: TW1039) to perform FCC Part 15 measurements	 FCC MRA: TW1039
Canada	Industry Canada	3M Semi Anechoic Chamber (IC 2324G-1 / IC 2324G-2) to perform	 IC 2324G-1 IC 2324G-2

2. TEST SUMMERY

FCC Standard Sec.	Chapter	Test Item	Result
15.203	1.2	Antenna Requirement	Pass
15.207	4.1	AC Conducted Emission	Pass
15.403(i)	4.2	26dB Bandwidth	Pass
15.403(i)	4.2	6dB Bandwidth	Pass
15.403(i)	4.2	Occupied Bandwidth (99%)	Pass
15.407(a)	4.3	Output Power Measurement	Pass
15.407(a)	4.4	Power Spectral Density	Pass
15.407(b)	4.5	Radiation Band Edge	Pass
15.407(b)	4.5	Radiation Spurious Emission	Pass
15.407(g)	4.6	Frequency Stability	Pass

3. DESCRIPTION OF TEST MODES

3.1 THE WORST MODE OF OPERATING CONDITION

<p>Operation mode</p>	<ol style="list-style-type: none"> 1. IEEE 802.11a mode: 6Mbps 2. IEEE 802.11n HT 20 MHz mode: MCS0 3. IEEE 802.11n HT 40 MHz mode: MCS0 4. IEEE 802.11ac VHT 20 MHz mode: MCS0 5. IEEE 802.11ac VHT 40 MHz mode: MCS0 5. IEEE 802.11ac VHT 80 MHz mode: MCS0 																																										
<p>Operating Frequency Range & Number of Channels</p>	<table border="1"> <thead> <tr> <th></th> <th>Mode</th> <th>Frequency Range (MHz)</th> <th>Number of Channels</th> </tr> </thead> <tbody> <tr> <td rowspan="6">U-NII-1</td> <td>IEEE 802.11a</td> <td>5180 ~ 5240</td> <td>4 Channels</td> </tr> <tr> <td>IEEE 802.11n HT 20 MHz</td> <td>5180 ~ 5240</td> <td>4 Channels</td> </tr> <tr> <td>IEEE 802.11n HT 40 MHz</td> <td>5190 ~ 5230</td> <td>2 Channels</td> </tr> <tr> <td>IEEE 802.11ac VHT 20 MHz</td> <td>5180 ~ 5240</td> <td>4 Channels</td> </tr> <tr> <td>IEEE 802.11ac VHT 40 MHz</td> <td>5190 ~ 5230</td> <td>2 Channels</td> </tr> <tr> <td>IEEE 802.11ac VHT 80 MHz</td> <td>5210</td> <td>1 Channels</td> </tr> <tr> <td rowspan="6">U-NII-3</td> <td>IEEE 802.11a</td> <td>5745 ~ 5825</td> <td>5 Channels</td> </tr> <tr> <td>IEEE 802.11n HT 20 MHz</td> <td>5745 ~ 5825</td> <td>5 Channels</td> </tr> <tr> <td>IEEE 802.11n HT 40 MHz</td> <td>5755 ~ 5795</td> <td>2 Channels</td> </tr> <tr> <td>IEEE 802.11ac VHT 20 MHz</td> <td>5745 ~ 5825</td> <td>5 Channels</td> </tr> <tr> <td>IEEE 802.11ac VHT 40 MHz</td> <td>5755 ~ 5795</td> <td>2 Channels</td> </tr> <tr> <td>IEEE 802.11ac VHT 80 MHz</td> <td>5775</td> <td>1 Channels</td> </tr> </tbody> </table>		Mode	Frequency Range (MHz)	Number of Channels	U-NII-1	IEEE 802.11a	5180 ~ 5240	4 Channels	IEEE 802.11n HT 20 MHz	5180 ~ 5240	4 Channels	IEEE 802.11n HT 40 MHz	5190 ~ 5230	2 Channels	IEEE 802.11ac VHT 20 MHz	5180 ~ 5240	4 Channels	IEEE 802.11ac VHT 40 MHz	5190 ~ 5230	2 Channels	IEEE 802.11ac VHT 80 MHz	5210	1 Channels	U-NII-3	IEEE 802.11a	5745 ~ 5825	5 Channels	IEEE 802.11n HT 20 MHz	5745 ~ 5825	5 Channels	IEEE 802.11n HT 40 MHz	5755 ~ 5795	2 Channels	IEEE 802.11ac VHT 20 MHz	5745 ~ 5825	5 Channels	IEEE 802.11ac VHT 40 MHz	5755 ~ 5795	2 Channels	IEEE 802.11ac VHT 80 MHz	5775	1 Channels
	Mode	Frequency Range (MHz)	Number of Channels																																								
U-NII-1	IEEE 802.11a	5180 ~ 5240	4 Channels																																								
	IEEE 802.11n HT 20 MHz	5180 ~ 5240	4 Channels																																								
	IEEE 802.11n HT 40 MHz	5190 ~ 5230	2 Channels																																								
	IEEE 802.11ac VHT 20 MHz	5180 ~ 5240	4 Channels																																								
	IEEE 802.11ac VHT 40 MHz	5190 ~ 5230	2 Channels																																								
	IEEE 802.11ac VHT 80 MHz	5210	1 Channels																																								
U-NII-3	IEEE 802.11a	5745 ~ 5825	5 Channels																																								
	IEEE 802.11n HT 20 MHz	5745 ~ 5825	5 Channels																																								
	IEEE 802.11n HT 40 MHz	5755 ~ 5795	2 Channels																																								
	IEEE 802.11ac VHT 20 MHz	5745 ~ 5825	5 Channels																																								
	IEEE 802.11ac VHT 40 MHz	5755 ~ 5795	2 Channels																																								
	IEEE 802.11ac VHT 80 MHz	5775	1 Channels																																								

Remark:

1. EUT pre-scanned data rate of output power for each mode, the worst data rate were recorded in this report.
2. Covered modes are test reduction modes. The output powers on the covered modes are equal to or less than the mode referenced and use the same module
3. The mode IEEE 802.11ac VHT20 and VHT40 are only different in control messages with IEEE 802.11n HT20 and HT40, and have same power setting. Therefore, the highest power(IEEE 802.11n HT20 and HT40) were test conducted and radiated measurement and recorded in this report.

3.2 THE WORST MODE OF MEASUREMENT

AC Power Line Conducted Emission	
Test Condition	AC Power line conducted emission for line and neutral
Voltage/Hz	120V/60Hz
Test Mode	Mode 1:EUT power by AC adapter Mode 2:EUT power by PoE adapter via LAN cable
Worst Mode	<input checked="" type="checkbox"/> Mode 1 <input type="checkbox"/> Mode 2 <input type="checkbox"/> Mode 3 <input type="checkbox"/> Mode 4

Radiated Emission Measurement Above 1G	
Test Condition	Band edge, Emission for Unwanted and Fundamental
Voltage/Hz	120V/60Hz
Test Mode	Mode 1:EUT power by AC adapter Mode 2:EUT power by PoE adapter via LAN cable
Worst Mode	<input checked="" type="checkbox"/> Mode 1 <input type="checkbox"/> Mode 2 <input type="checkbox"/> Mode 3 <input type="checkbox"/> Mode 4
Worst Position	<input type="checkbox"/> Placed in fixed position. <input type="checkbox"/> Placed in fixed position at X-Plane (E2-Plane) <input checked="" type="checkbox"/> Placed in fixed position at Y-Plane (E1-Plane) <input type="checkbox"/> Placed in fixed position at Z-Plane (H-Plane)
Worst Polarity	<input type="checkbox"/> Horizontal <input checked="" type="checkbox"/> Vertical

Radiated Emission Measurement Below 1G	
Test Condition	Radiated Emission Below 1G
Voltage/Hz	120V/60Hz
Test Mode	Mode 1:EUT power by AC adapter Mode 2:EUT power by PoE adapter via LAN cable
Worst Mode	<input checked="" type="checkbox"/> Mode 1 <input checked="" type="checkbox"/> Mode 2 <input type="checkbox"/> Mode 3 <input type="checkbox"/> Mode 4

Remark:

1. The worst mode was record in this test report.
2. EUT pre-scanned in three axis, X, Y, Z and two polarity, Horizontal and Vertical for radiated measurement. The worst case were recorded in this report.
3. For below 1G AC power line conducted emission and radiation emission were performed the EUT transmit at the highest output power channel as worse case.
4. EUT power supply had two ways (Adapter and PoE, both not for sale),that EUT pre-scanned two power supply at Radiated below 1G, and the worst case was Adapter mode. Therefore EUT used adapter mode for Radiated measurement above 1G and Conduction below 1G in test report.

3.3 EUT DUTY CYCLE

Duty Cycle				
Configuration	TX ON (ms)	TX ALL (ms)	Duty Cycle (%)	Duty Factor(dB)
802.11a	2.11	2.15	98.14	0.08
802.11n HT20	5.02	5.08	98.82	0.05
802.11n HT40	2.47	2.53	97.63	0.10
802.11ac VHT80	1.19	1.23	96.75	0.14

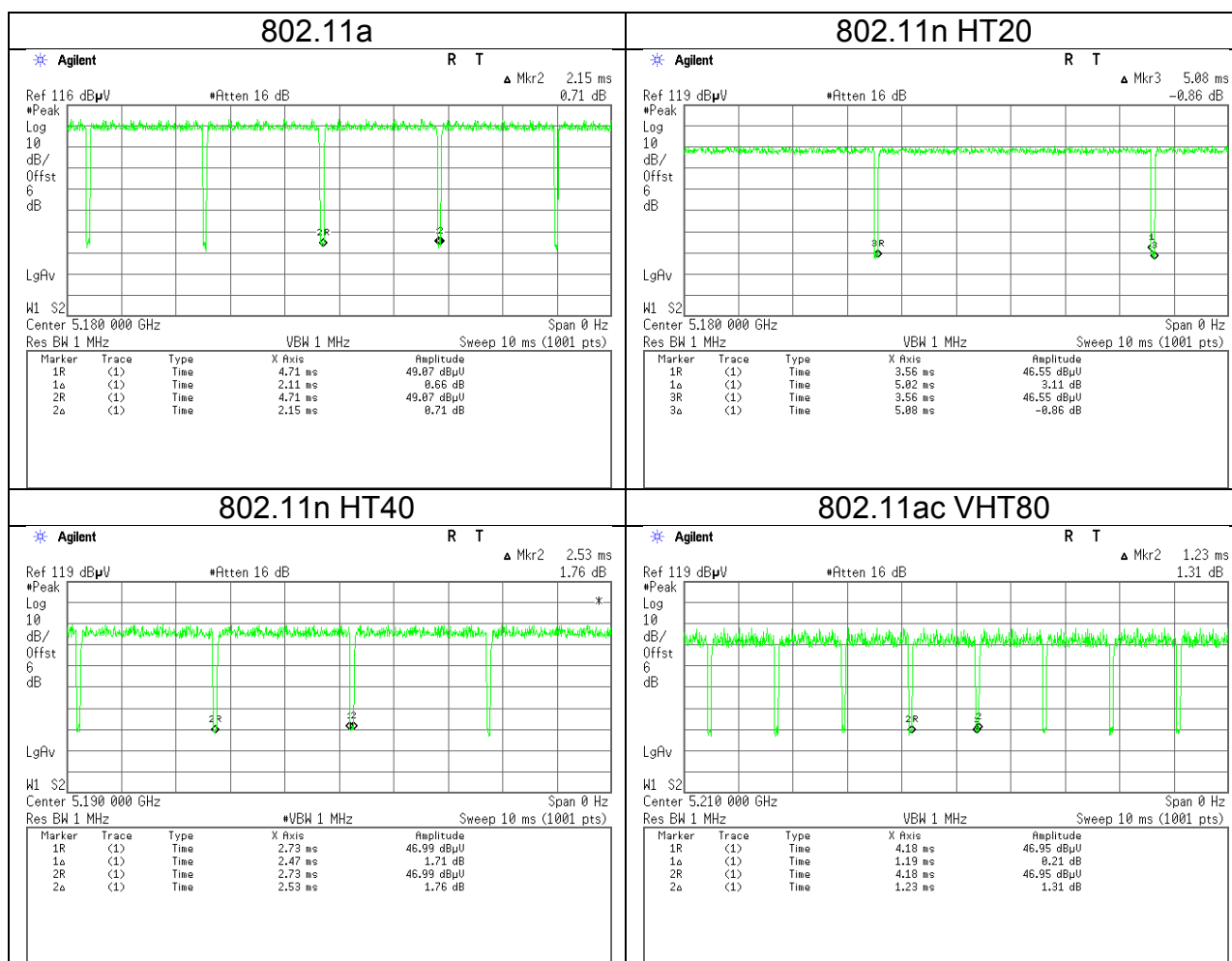

4. TEST RESULT

4.1 AC POWER LINE CONDUCTED EMISSION

4.1.1 Test Limit

According to §15.207(a),

Frequency Range (MHz)	Limits(dBμV)	
	Quasi-peak	Average
0.15 to 0.50	66 to 56*	56 to 46*
0.50 to 5	56	46
5 to 30	60	50

* Decreases with the logarithm of the frequency.

4.1.2 Test Procedure

Test method Refer as ANSI 63.10:2013 clause 6.2,

1. The EUT was placed on a non-conducted table, which is 0.8m above horizontal ground plane and 0.4m above vertical ground plane.
2. EUT connected to the line impedance stabilization network (LISN)
3. Receiver set RBW of 9kHz and Detector Peak, and note as quasi-peak and average.
4. Maximum procedure was performed on the six highest emissions to ensure EUT compliance.
5. Recorded Line for Neutral and Line.

4.1.3 Test Setup

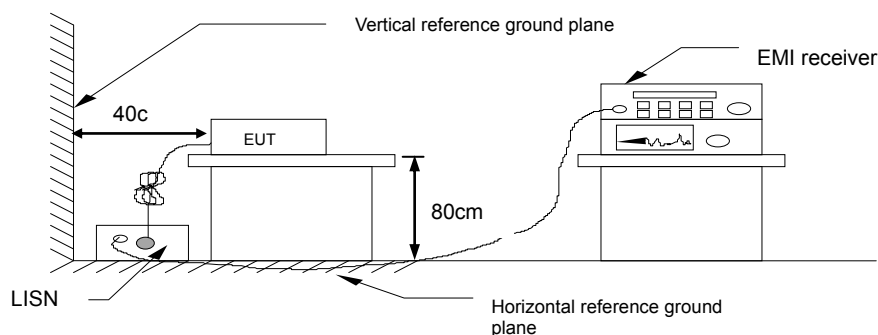

4.1.4 Test Result

Pass.

Test Data

Test Mode	Mode 1	Temp/Hum	24(°C)/ 50%RH
Test Voltage	120Vac / 60Hz	Test Date	Nov 15, 2016
Phase	Line	Test Engineer	Anderson Kuo

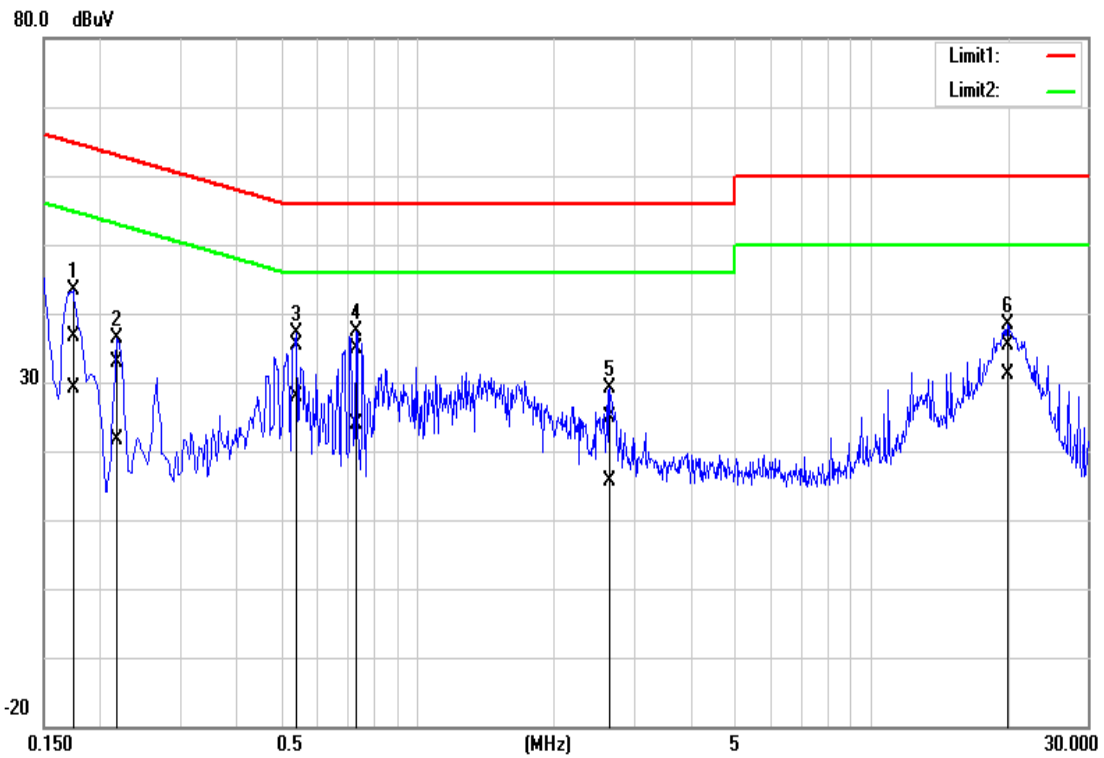

Frequency (MHz)	Quasi Peak reading (dBuV)	Average reading (dBuV)	Correction factor (dB)	Quasi Peak result (dBuV)	Average result (dBuV)	Quasi Peak limit (dBuV)	Average limit (dBuV)	Quasi Peak margin (dB)	Average margin (dB)	Remark
0.1740	26.94	19.54	9.71	36.65	29.25	64.77	54.77	-28.12	-25.52	Pass
0.2180	23.07	12.03	9.70	32.77	21.73	62.89	52.89	-30.12	-31.16	Pass
0.5420	25.69	18.17	9.70	35.39	27.87	56.00	46.00	-20.61	-18.13	Pass
0.7340	25.28	14.15	9.71	34.99	23.86	56.00	46.00	-21.01	-22.14	Pass
2.6500	15.05	5.81	9.73	24.78	15.54	56.00	46.00	-31.22	-30.46	Pass
20.0420	25.59	21.23	9.88	35.47	31.11	60.00	50.00	-24.53	-18.89	Pass

Test Mode	Mode 1	Temp/Hum	27(°C)/ 53%RH
Test Voltage	120Vac / 60Hz	Test Date	Nov 15, 2016
Phase	Neutral	Test Engineer	Anderson Kuo

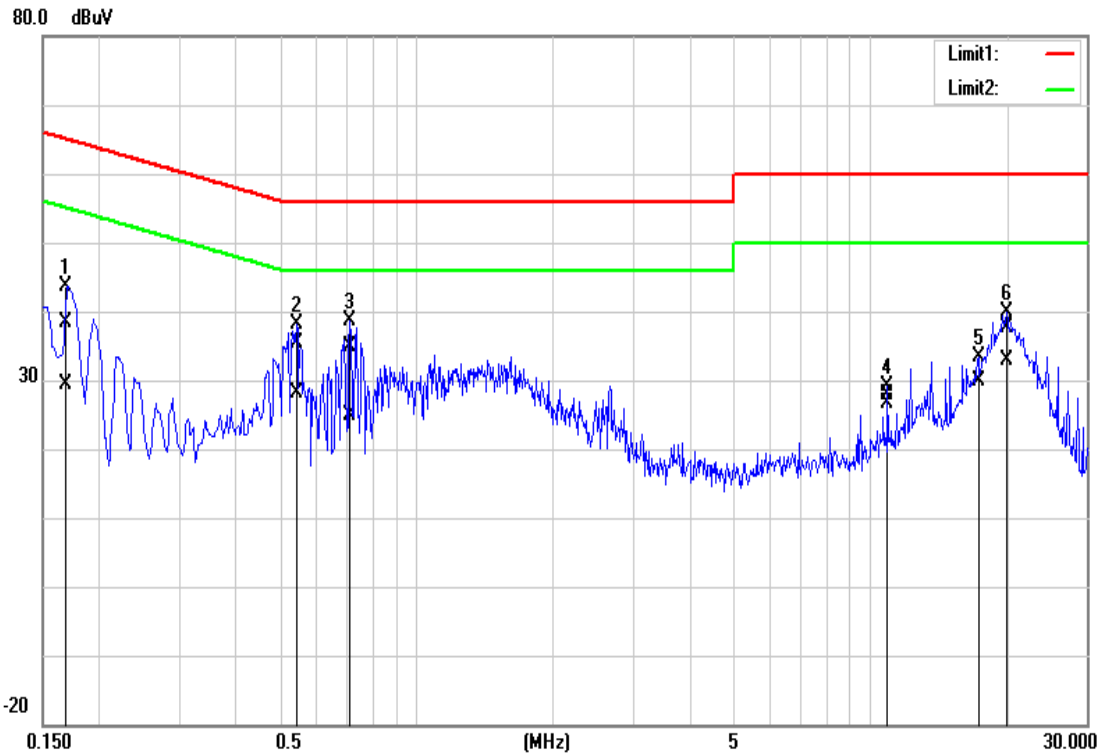

Frequency (MHz)	Quasi Peak reading (dBuV)	Average reading (dBuV)	Correction factor (dB)	Quasi Peak result (dBuV)	Average result (dBuV)	Quasi Peak limit (dBuV)	Average limit (dBuV)	Quasi Peak margin (dB)	Average margin (dB)	Remark
0.1700	28.71	19.63	9.78	38.49	29.41	64.96	54.96	-26.47	-25.55	Pass
0.5460	25.50	18.25	9.76	35.26	28.01	56.00	46.00	-20.74	-17.99	Pass
0.7140	25.10	15.05	9.76	34.86	24.81	56.00	46.00	-21.14	-21.19	Pass
10.9100	17.92	16.69	10.04	27.96	26.73	60.00	50.00	-32.04	-23.27	Pass
17.3780	23.16	19.61	10.20	33.36	29.81	60.00	50.00	-26.64	-20.19	Pass
20.0500	27.43	22.58	10.27	37.70	32.85	60.00	50.00	-22.30	-17.15	Pass

4.2 26DB BANDWIDTH, 6DB BANDWIDTH AND OCCUPIED BANDWIDTH(99%)

4.2.1 Test Limit

26 dB Bandwidth : For reporting purposes only.

6 dB Bandwidth : Least 500kHz.

Occupied Bandwidth(99%) : For reporting purposes only.

4.2.2 Test Procedure

Test method Refer as KDB 789033 D02 v01r03 Section C, D, and ANSI 63.10:2013 clause 6.9.2,

1. The EUT RF output connected to the spectrum analyzer by RF cable.
2. Setting maximum power transmit of EUT
3. UNII-1, SA set RBW = 300kHz, VBW = 1MHz and Detector = Peak, to measurement 26 dB Bandwidth and 99% Bandwidth
4. UNII-3, SA set RBW = 100kHz, VBW = 300kHz and Detector = Peak, to measurement 26 dB Bandwidth and 99% Bandwidth
5. Measure and record the result of 6 dB Bandwidth and 99% Bandwidth. in the test report.

4.2.3 Test Setup



4.2.4 Test Result

UNII-1 5150-5250 MHz					
Test mode: IEEE 802.11a mode					
Channel	Frequency (MHz)	Chain 0 OBW(99%) (MHz)	Chain 1 OBW(99%) (MHz)	Chain 0 26dB BW (MHz)	Chain 1 26dB BW (MHz)
Low	5180	17.2214	16.8596	27.5326	25.2174
Mid	5220	17.0043	16.8596	23.9130	24.2029
High	5240	17.0767	16.8596	24.7826	24.8551
Test mode: IEEE 802.11n HT20 mode					
Channel	Frequency (MHz)	Chain 0 OBW(99%) (MHz)	Chain 1 OBW(99%) (MHz)	Chain 0 26dB BW (MHz)	Chain 1 26dB BW (MHz)
Low	5180	18.3068	18.1620	27.8986	28.5507
Mid	5220	18.3068	18.1620	29.1350	28.6232
High	5240	18.2344	18.1620	27.7536	28.6232
Test mode: IEEE 802.11n HT40 mode					
Channel	Frequency (MHz)	Chain 0 OBW(99%) (MHz)	Chain 1 OBW(99%) (MHz)	Chain 0 26dB BW (MHz)	Chain 1 26dB BW (MHz)
Low	5190	37.6266	37.3950	48.0000	46.6090
High	5230	37.9739	37.7420	61.2170	59.1300
Test mode: IEEE 802.11ac VHT80 mode					
Channel	Frequency (MHz)	Chain 0 OBW(99%) (MHz)	Chain 1 OBW(99%) (MHz)	Chain 0 26dB BW (MHz)	Chain 1 26dB BW (MHz)
Mid	5210	76.8740	76.6425	91.1300	89.7390

UNII-3 5725-5825MHz					
Test mode: IEEE 802.11a mode					
Channel	Frequency (MHz)	Chain 0 OBW(99%) (MHz)	Chain 1 OBW(99%) (MHz)	Chain 0 6dB BW (MHz)	Chain 1 6dB BW (MHz)
Low	5745	16.6714	16.8451	16.4348	16.4348
Mid	5785	16.6714	16.9753	16.3913	16.3913
High	5825	16.6280	16.7583	16.3913	16.3913
Test mode: IEEE 802.11n HT20 mode					
Channel	Frequency (MHz)	Chain 0 OBW(99%) (MHz)	Chain 1 OBW(99%) (MHz)	Chain 0 6dB BW (MHz)	Chain 1 6dB BW (MHz)
Low	5745	17.8437	17.8871	17.6522	17.6522
Mid	5785	17.8437	18.0173	17.6522	17.6090
High	5825	17.7568	17.9305	17.6088	17.6088
Test mode: IEEE 802.11n HT40 mode					
Channel	Frequency (MHz)	Chain 0 OBW(99%) (MHz)	Chain 1 OBW(99%) (MHz)	Chain 0 6dB BW (MHz)	Chain 1 6dB BW (MHz)
Low	5755	36.2373	36.3531	36.2900	36.4060
High	5795	36.3531	36.3531	36.4060	36.4060
Test mode: IEEE 802.11ac VHT80 mode					
Channel	Frequency (MHz)	Chain 0 OBW(99%) (MHz)	Chain 1 OBW(99%) (MHz)	Chain 0 6dB BW (MHz)	Chain 1 6dB BW (MHz)
Mid	5775	75.7163	75.7163	76.7540	76.0580

Test Data

UNII-1 IEEE 802.11a mode- chain 0

Low CH

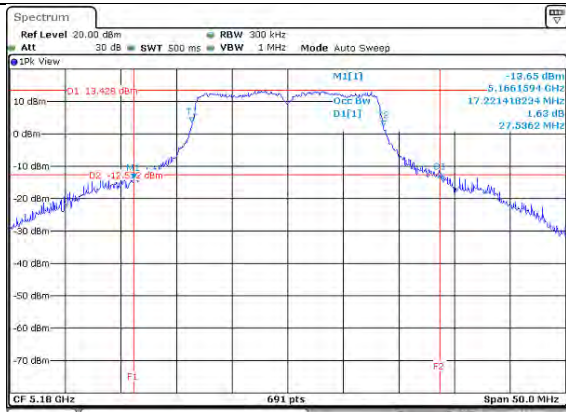

Mid CH

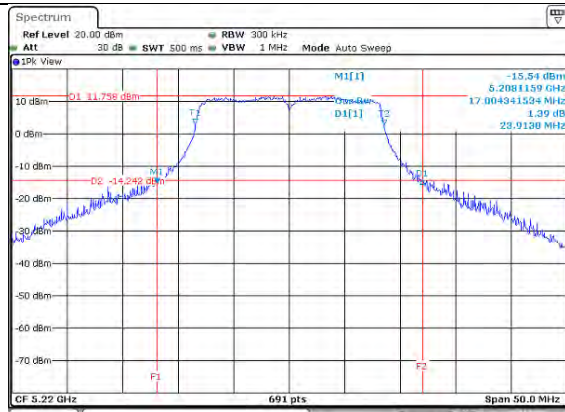

High CH

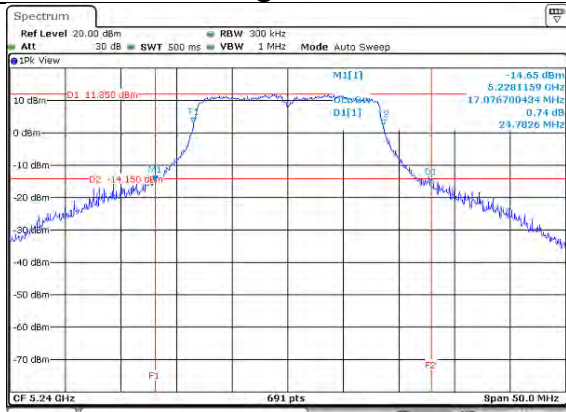

UNII-1 IEEE 802.11a mode- chain 1

Low CH

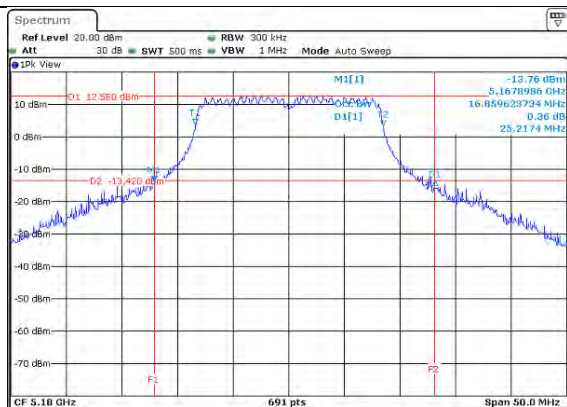

Mid CH

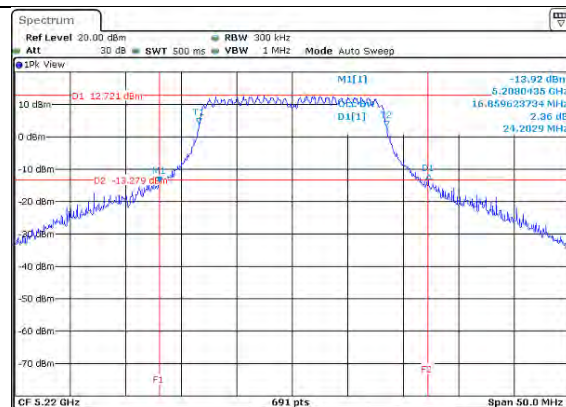

High CH

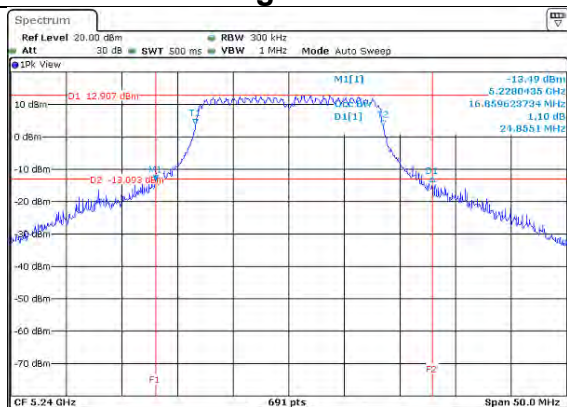

UNII-1 IEEE 802.11n HT20 mode- chain 0

Low CH

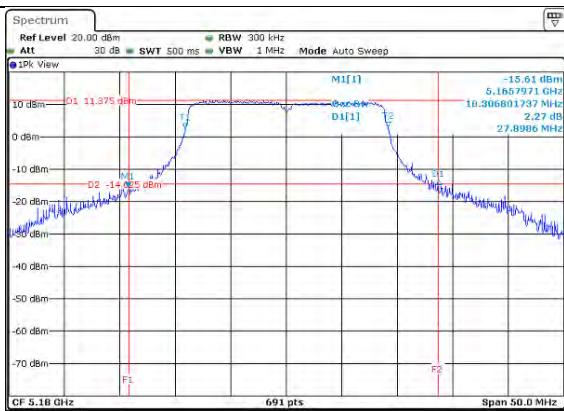

Mid CH

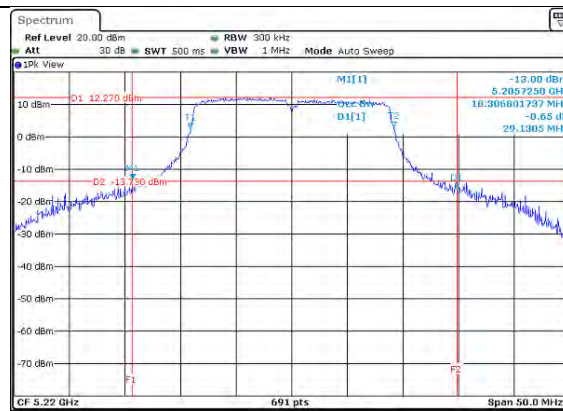

High CH

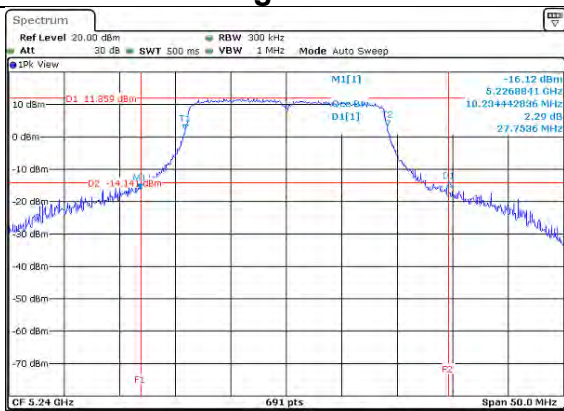

UNII-1 IEEE 802.11n HT20 mode- chain 1

Low CH

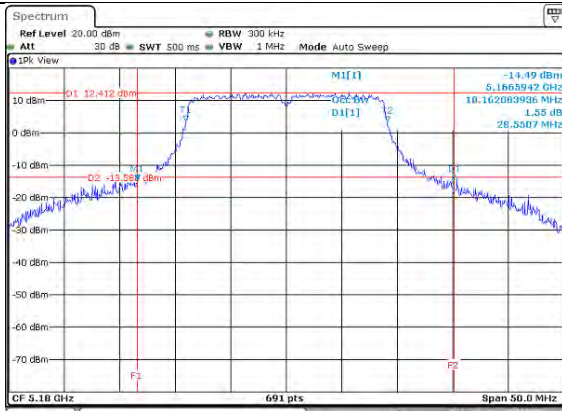

Mid CH

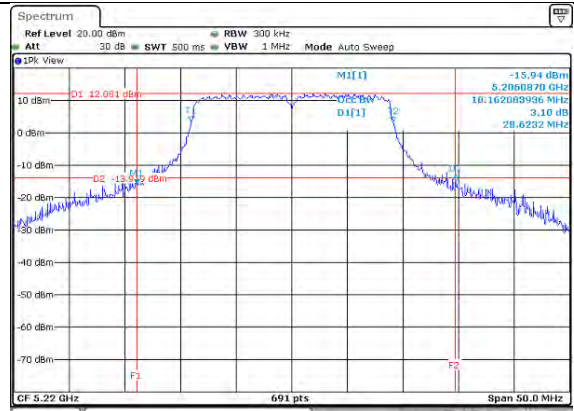

High CH

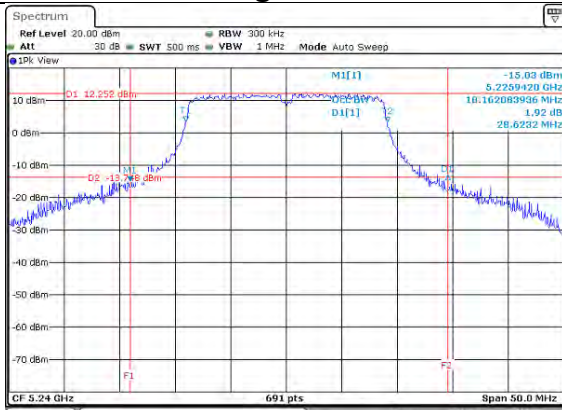

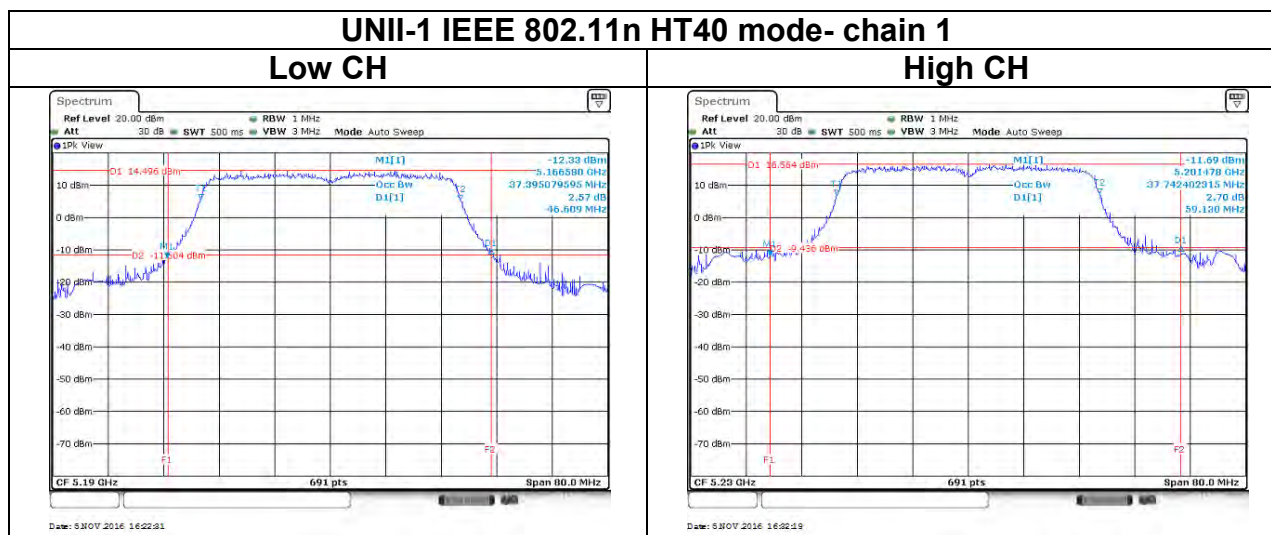
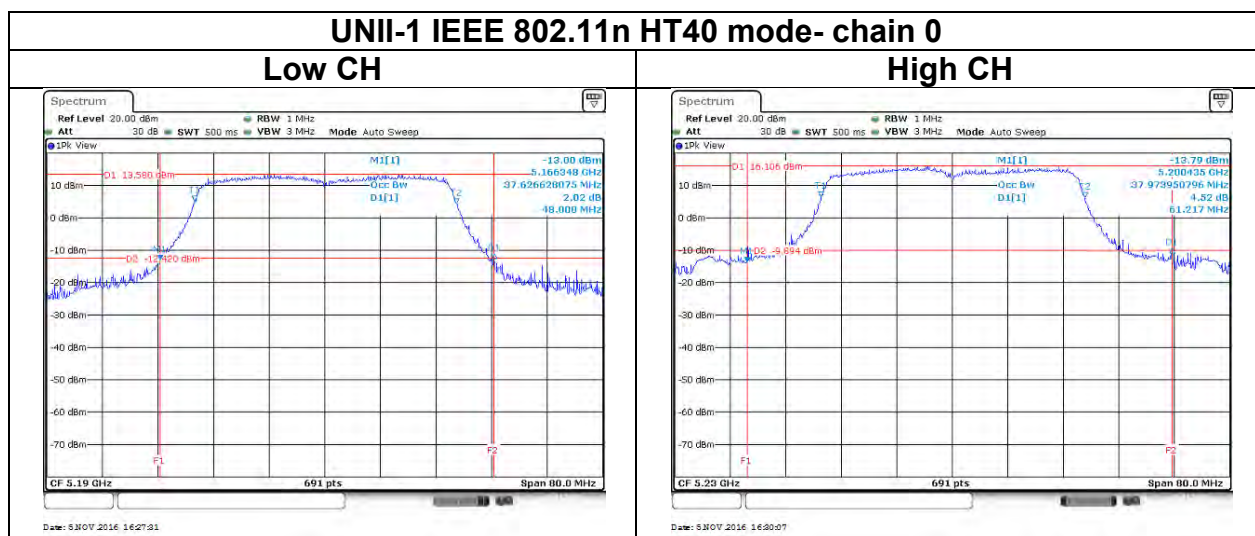

UNII-1 IEEE 802.11ac VHT80 mode- chain 0

Mid CH

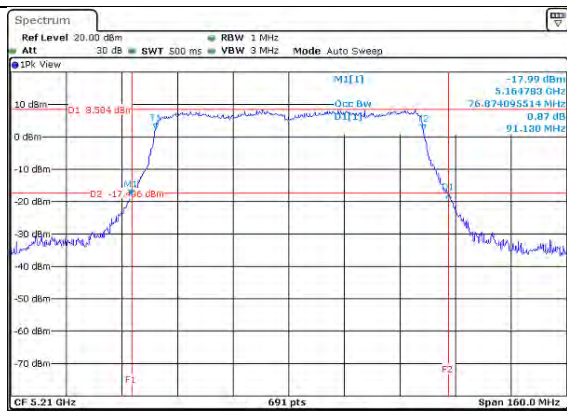

UNII-1 IEEE 802.11ac VHT80 mode- chain 1

Mid CH

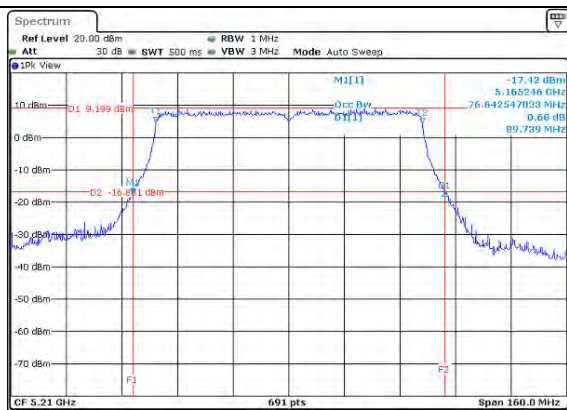

Test Data

UNII-3 IEEE 802.11a mode- chain 0

Low CH

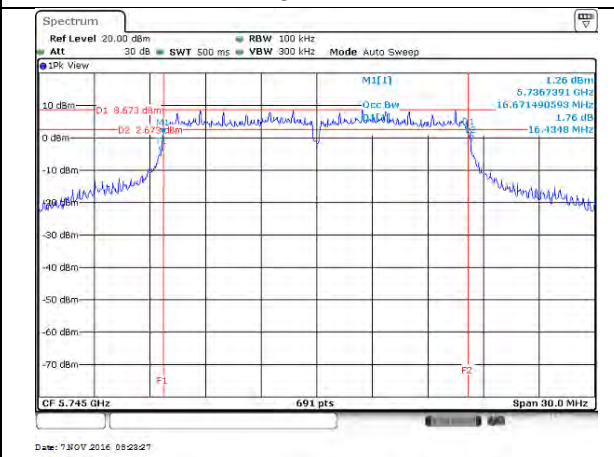

Mid CH

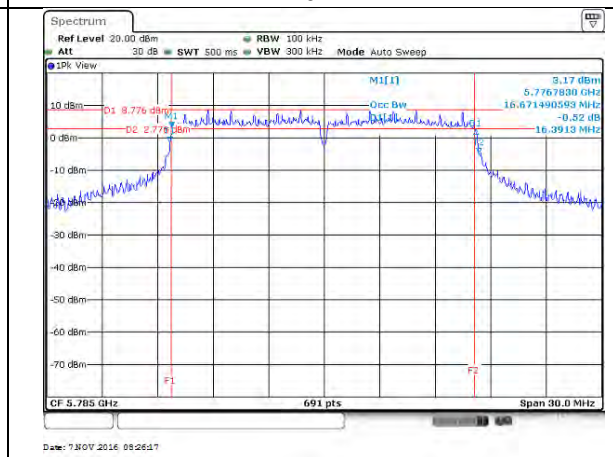

High CH

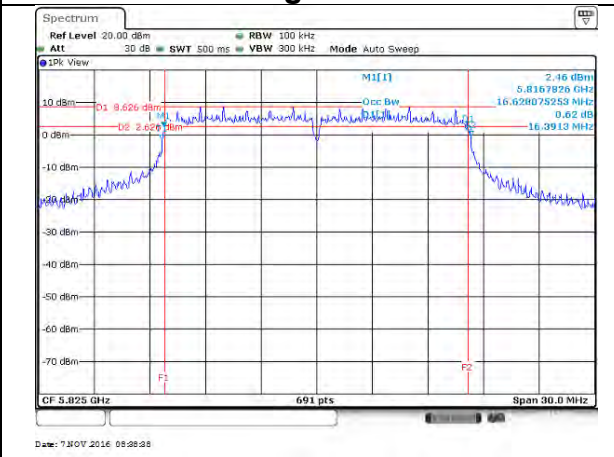

UNII-3 IEEE 802.11a mode- chain 1

Low CH

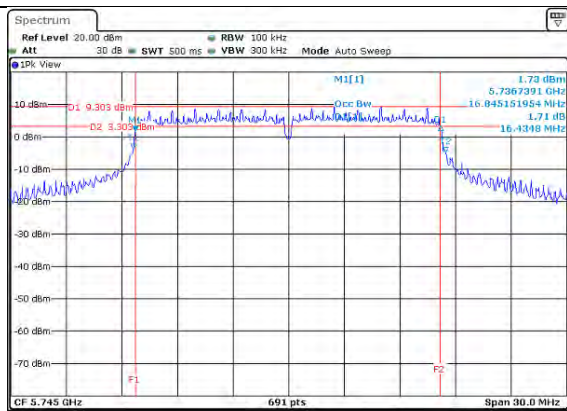

Mid CH

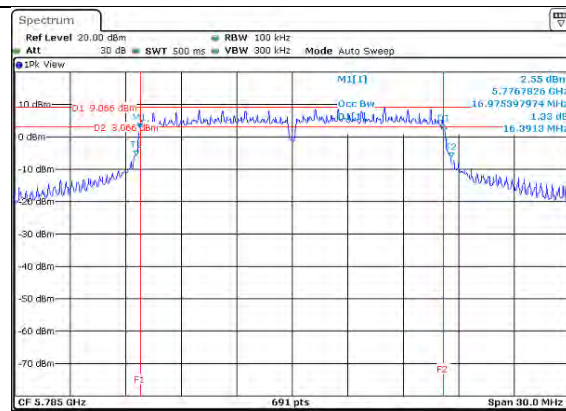

High CH

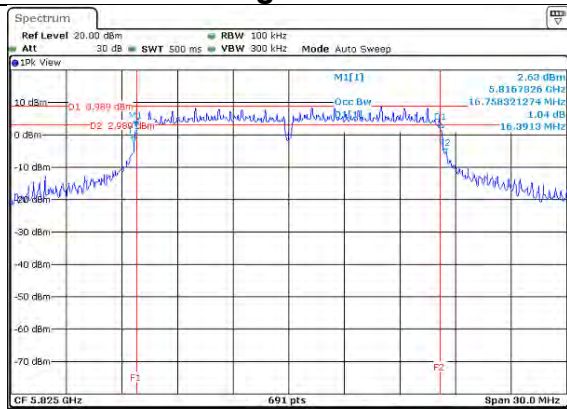

UNII-3 IEEE 802.11n HT20 mode- chain 0

Low CH

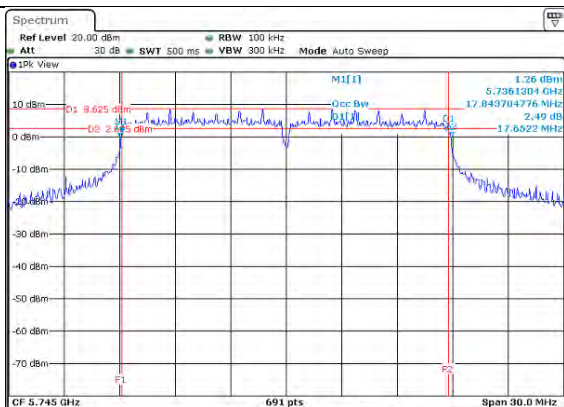

Mid CH

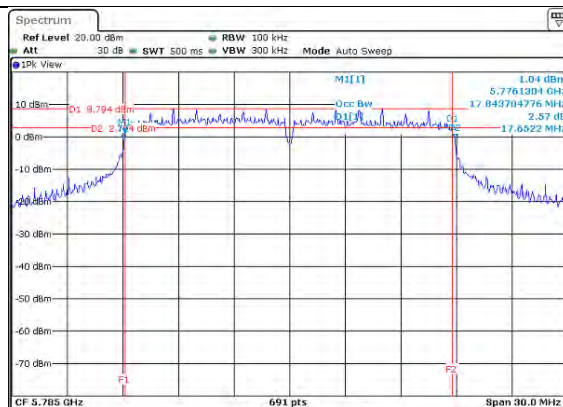

High CH

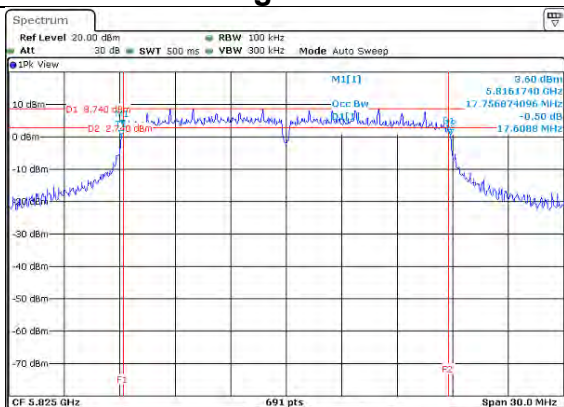

UNII-3 IEEE 802.11n HT20 mode- chain 1

Low CH

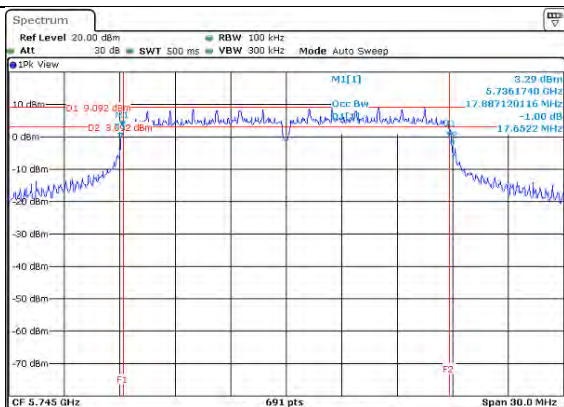

Mid CH

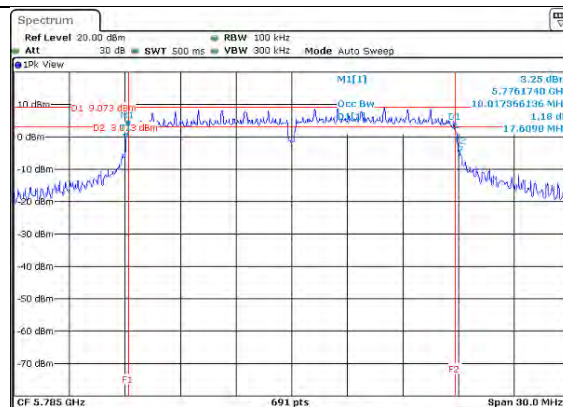

High CH

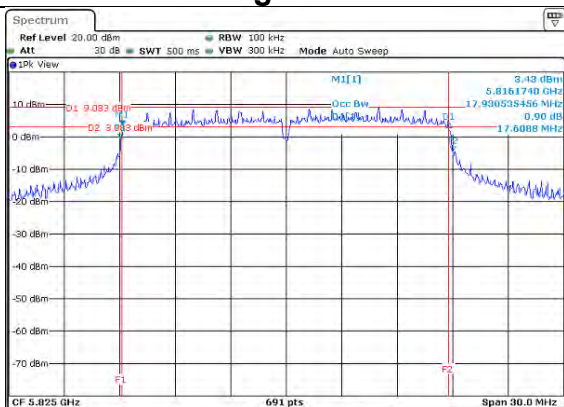

UNII-3 IEEE 802.11n HT40 mode- chain 0

Low CH



High CH

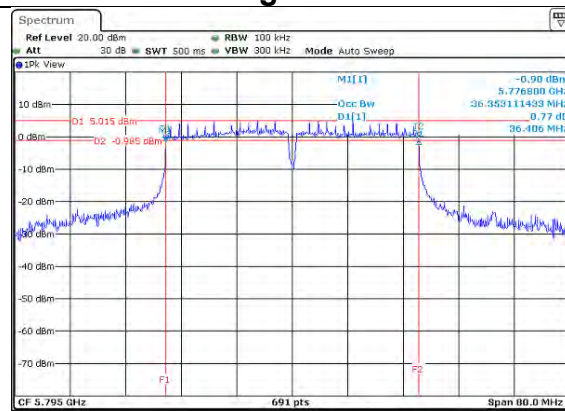

UNII-3 IEEE 802.11n HT40 mode- chain 1

Low CH

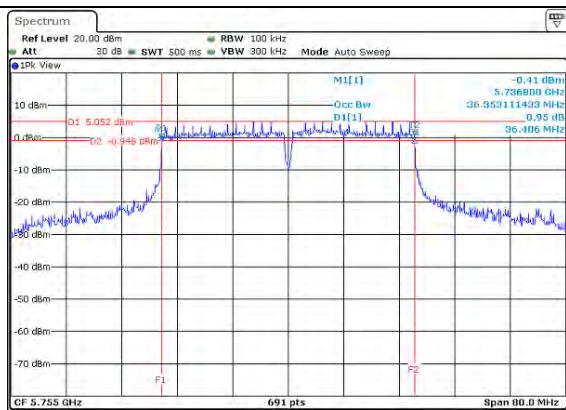

High CH

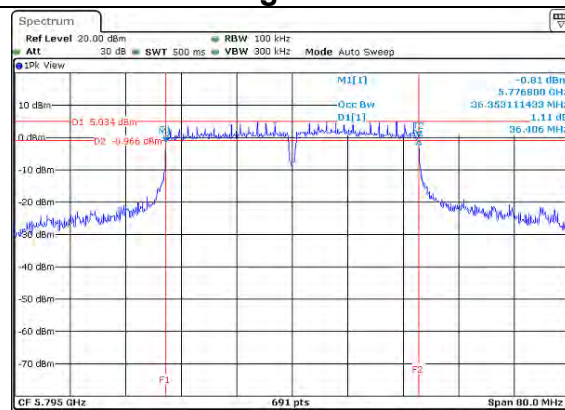

UNII-3 IEEE 802.11ac VHT80 mode- chain 0

Mid CH

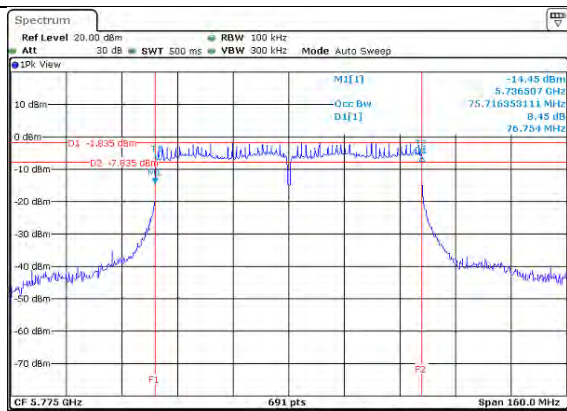

UNII-3 IEEE 802.11ac VHT80 mode- chain 1

Mid CH

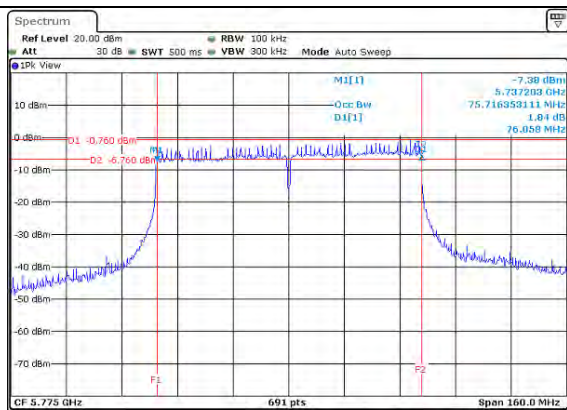

4.3 OUTPUT POWER MEASUREMENT

4.3.1 Test Limit

According to §15.407 (a)(1) and 15.407(a)(3)

UNII-1 :

For an indoor access point operating in the band 5.15-5.25 GHz, the maximum conducted output power over the frequency band of operation shall not exceed 1 W provided the maximum antenna gain does not exceed 6 dBi. In addition, the maximum power spectral density shall not exceed 17 dBm in any 1 megahertz band. If transmitting antennas of directional gain greater than 6 dBi are used, both the maximum conducted output power and the maximum power spectral density shall be reduced by the amount in dB that the directional gain of the antenna exceeds 6 dBi.

UNII-3:

For the band 5.725-5.85 GHz, the maximum conducted output power over the frequency band of operation shall not exceed 1 W. In addition, the maximum power spectral density shall not exceed 30 dBm in any 500-kHz band. If transmitting antennas of directional gain greater than 6 dBi are used, both the maximum conducted output power and the maximum power spectral density shall be reduced by the amount in dB that the directional gain of the antenna exceeds 6 dBi.

*Directional gain(DG) reference Page 6 for calculations.

UNII-1 Limit	<input checked="" type="checkbox"/> Antenna not exceed 6 dBi : 30dBm <input type="checkbox"/> Antenna with DG greater than 6 dBi : [Limit = 30 – (DG – 6)]
UNII-3 Limit	<input checked="" type="checkbox"/> Antenna not exceed 6 dBi : 30dBm <input type="checkbox"/> Antenna with DG greater than 6 dBi : [Limit = 30 – (DG – 6)]

4.3.2 Test Procedure

Test method Refer as KDB 789033 D02 v01r02, Section E.3.b.

1. The EUT RF output connected to the power meter by RF cable.
2. Setting maximum power transmit of EUT.
3. The path loss was compensated to the results for each measurement.
4. Measure and record the result of Average output power. in the test report.

4.3.3 Test Setup

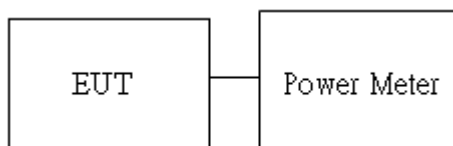

4.3.4 Test Result

Conducted output power :

UNII-1 2Tx								
Config	CH	Freq. (MHz)	AV Power(dBm)		AV Total Power (dBm)	AV Total Power (W)	DG (dBi)	Limit (dBm)
			chain0	chain1				
IEEE 802.11a Data rate: 6Mbps	36	5180	20.33	20.91	23.64	0.2312	4.44	30
	44	5220	19.98	20.07	23.03	0.2009		
	48	5240	22.61	22.58	25.60	0.3631		
IEEE 802.11n HT20 Data rate: MCS0	36	5180	21.82	21.66	24.75	0.2985		
	44	5220	22.44	21.66	25.07	0.3214		
	48	5240	21.99	22.01	25.01	0.3170		
IEEE 802.11n HT40 Data rate: MCS0	38	5190	19.07	19.79	22.45	0.1758		
	46	5230	21.13	22.08	24.64	0.2911		
IEEE 802.11ac VHT20 Data rate: MCS0	36	5180	21.66	21.61	24.64	0.2911		
	44	5220	20.96	21.61	24.31	0.2698		
	48	5240	21.93	21.99	24.97	0.3141		
IEEE 802.11ac VHT40 Data rate: MCS0	38	5190	19.31	19.72	22.53	0.1791		
	46	5230	22.10	22.02	25.07	0.3214		
IEEE 802.11ac VHT80 Data rate: MCS0	42	5210	17.84	17.90	20.88	0.1225		

UNII-3 2Tx								
Config	CH	Freq. (MHz)	AV Power(dBm)		AV Total Power (dBm)	AV Total Power (W)	DG (dBi)	Limit (dBm)
			chain0	chain1				
IEEE 802.11a Data rate: 6Mbps	149	5745	22.43	21.56	25.02	0.3177	4.63	30
	157	5785	22.44	21.41	24.96	0.3133		
	165	5825	22.24	21.16	24.74	0.2979		
IEEE 802.11n HT20 Data rate: MCS0	149	5745	22.17	21.37	24.80	0.3020		
	157	5785	22.32	21.17	24.79	0.3013		
	165	5825	22.11	20.96	24.58	0.2871		
IEEE 802.11n HT40 Data rate: MCS0	151	5755	20.80	20.18	23.51	0.2244		
	159	5795	21.24	20.97	24.12	0.2582		
IEEE 802.11ac VHT20 Data rate: MCS0	149	5745	21.62	21.83	24.74	0.2979		
	157	5785	21.36	21.56	24.47	0.2799		
	165	5825	22.22	21.32	24.80	0.3020		
IEEE 802.11ac VHT40 Data rate: MCS0	151	5755	20.80	20.79	23.81	0.2404		
	159	5795	21.15	20.89	24.03	0.2529		
IEEE 802.11ac VHT80 Data rate: MCS0	155	5775	17.66	17.37	20.53	0.1130		

4.4 POWER SPECTRAL DENSITY

4.4.1 Test Limit

According to §15.407 (a)(1) and 15.407(a)(3)

UNII-1 :

For an indoor access point operating in the band 5.15-5.25 GHz, the maximum conducted output power over the frequency band of operation shall not exceed 1 W provided the maximum antenna gain does not exceed 6 dBi. In addition, the maximum power spectral density shall not exceed 17 dBm in any 1 megahertz band. If transmitting antennas of directional gain greater than 6 dBi are used, both the maximum conducted output power and the maximum power spectral density shall be reduced by the amount in dB that the directional gain of the antenna exceeds 6 dBi.

UNII-3:

For the band 5.725-5.85 GHz, the maximum conducted output power over the frequency band of operation shall not exceed 1 W. In addition, the maximum power spectral density shall not exceed 30 dBm in any 500-kHz band. If transmitting antennas of directional gain greater than 6 dBi are used, both the maximum conducted output power and the maximum power spectral density shall be reduced by the amount in dB that the directional gain of the antenna exceeds 6 dBi.

*Directional gain(DG) reference Page 6 for calculations.

UNII-1 Limit	<input type="checkbox"/> Antenna not exceed 6 dBi : <input checked="" type="checkbox"/> Antenna with DG greater than 6 dBi : 15.55 [Limit = 17 – (DG – 6) = 17-1.45 = 15.55, DG = 7.45]
UNII-3 Limit	<input type="checkbox"/> Antenna not exceed 6 dBi : <input checked="" type="checkbox"/> Antenna with DG greater than 6 dBi : 28.36 [Limit = 30 – (DG – 6) = 30-1.64 = 28.36, DG = 7.64]

4.4.2 Test Procedure

Test method Refer as KDB 789033 D02 v01r02, Section F

1. The EUT RF output connected to the spectrum analyzer by RF cable.
2. Setting maximum power transmit of EUT
3. UNII-1, SA set RBW = 1MHz, VBW = 1MHz and Detector = RMS, to measurement Power Density.
4. UNII-3, SA set RBW = 500kHz, VBW = 2MHz and Detector = RMS, to measurement Power Density
5. The path loss and Duty Factor were compensated to the results for each measurement by SA.
6. Mark the maximum level.
7. Measure and record the result of power spectral density. in the test report.

4.4.3 Test Setup

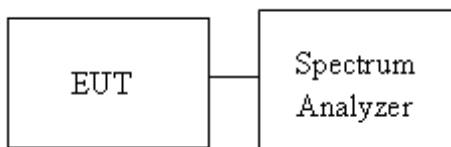

4.4.4 Test Result

UNII-1 5150-5250 MHz					
Test mode: IEEE 802.11a mode					
Channel	Frequency (MHz)	Chain 0 PPSD (dBm)	Chain 1 PPSD (dBm)	Total PSSD (dBm)	limit (dBm)
Low	5180	10.32	10.36	13.35	15.55
Mid	5220	10.26	10.36	13.32	
High	5240	10.54	10.37	13.47	
Test mode: IEEE 802.11n HT20 mode					
Channel	Frequency (MHz)	Chain 0 PPSD (dBm)	Chain 1 PPSD (dBm)	Total PSSD (dBm)	limit (dBm)
Low	5180	10.39	10.42	13.42	15.55
Mid	5220	10.41	10.45	13.44	
High	5240	10.57	10.53	13.56	
Test mode: IEEE 802.11n HT40 mode					
Channel	Frequency (MHz)	Chain 0 PPSD (dBm)	Chain 1 PPSD (dBm)	Total PSSD (dBm)	limit (dBm)
Low	5190	5.23	5.29	8.27	15.55
High	5230	7.60	7.68	10.65	
Test mode: IEEE 802.11ac VHT80 mode					
Channel	Frequency (MHz)	Chain 0 PPSD (dBm)	Chain 1 PPSD (dBm)	Total PSSD (dBm)	limit (dBm)
Mid	5210	0.36	0.26	3.32	15.55

UNII-3 5725-5825 MHz					
Test mode: IEEE 802.11a mode					
Channel	Frequency (MHz)	Chain 0 PPSD (dBm)	Chain 1 PPSD (dBm)	Total PSSD (dBm)	limit (dBm)
Low	5745	7.58	7.89	10.75	28.36
Mid	5785	7.45	7.58	10.53	
High	5825	7.41	7.63	10.53	
Test mode: IEEE 802.11n HT20 mode					
Channel	Frequency (MHz)	Chain 0 PPSD (dBm)	Chain 1 PPSD (dBm)	Total PSSD (dBm)	limit (dBm)
Low	5745	6.82	7.51	10.19	28.36
Mid	5785	7.06	7.42	10.25	
High	5825	7.35	7.48	10.43	
Test mode: IEEE 802.11n HT40 mode					
Channel	Frequency (MHz)	Chain 0 PPSD (dBm)	Chain 1 PPSD (dBm)	Total PSSD (dBm)	limit (dBm)
Low	5755	3.40	3.72	6.57	28.36
High	5795	3.42	3.50	6.47	
Test mode: IEEE 802.11ac VHT80 mode					
Channel	Frequency (MHz)	Chain 0 PPSD (dBm)	Chain 1 PPSD (dBm)	Total PSSD (dBm)	limit (dBm)
Mid	5775	-3.50	-3.00	-0.23	28.36

Test Data

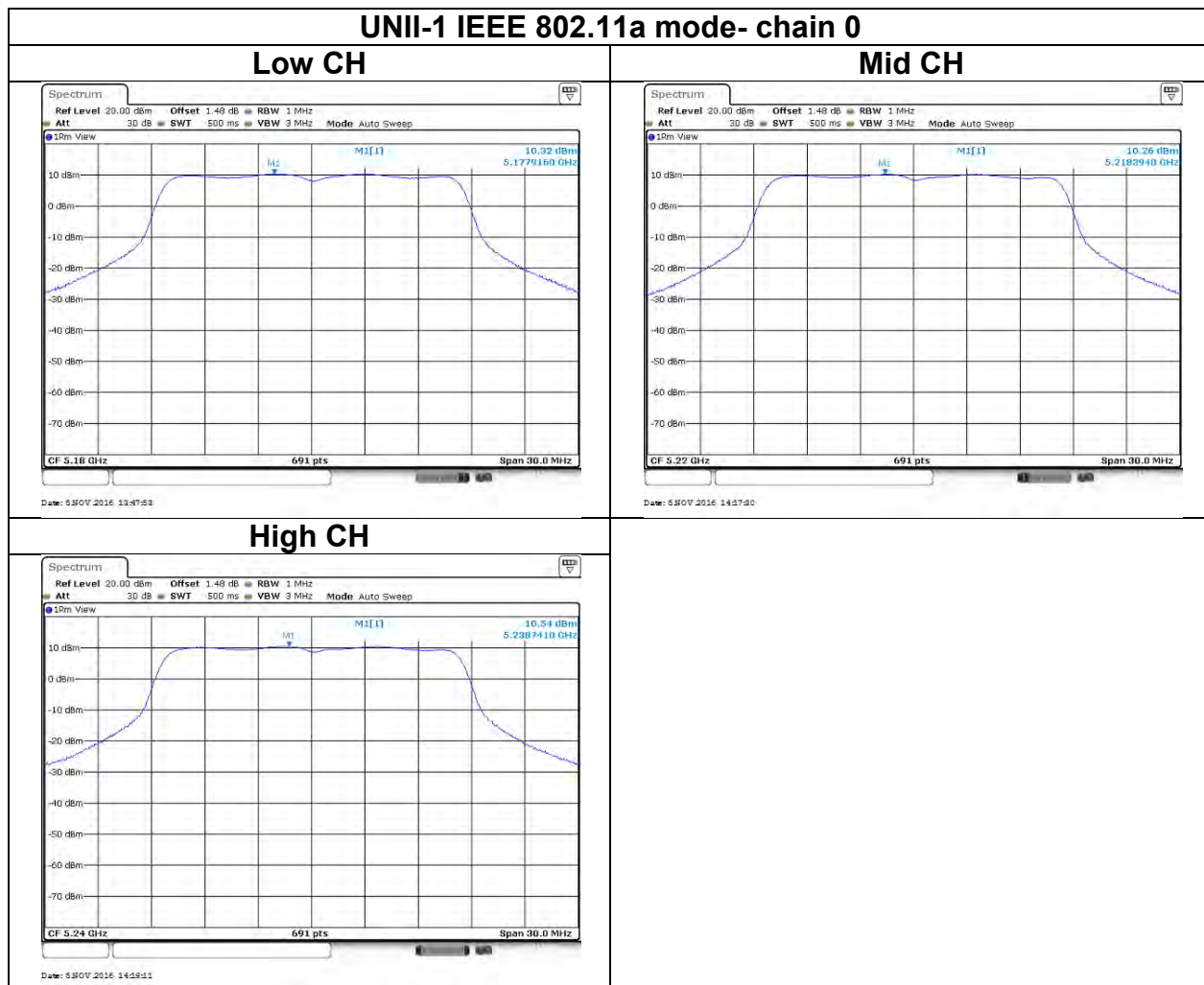

UNII-1 IEEE 802.11a mode- chain 1

Low CH



Date: 5/30/2016 14:05:45

Mid CH



Date: 5/30/2016 14:02:58

High CH



Date: 5/30/2016 14:22:52

UNII-1 IEEE 802.11n HT20 mode- chain 0

Low CH



Date: 5/30/2016 14:02:58

Mid CH



Date: 5/30/2016 14:25:58

High CH



Date: 5/30/2016 15:23:46

UNII-1 IEEE 802.11n HT20 mode- chain 1

Low CH



Date: 5/30/2016 14:31:19

Mid CH



Date: 5/30/2016 14:27:44

High CH



Date: 5/30/2016 14:32:25

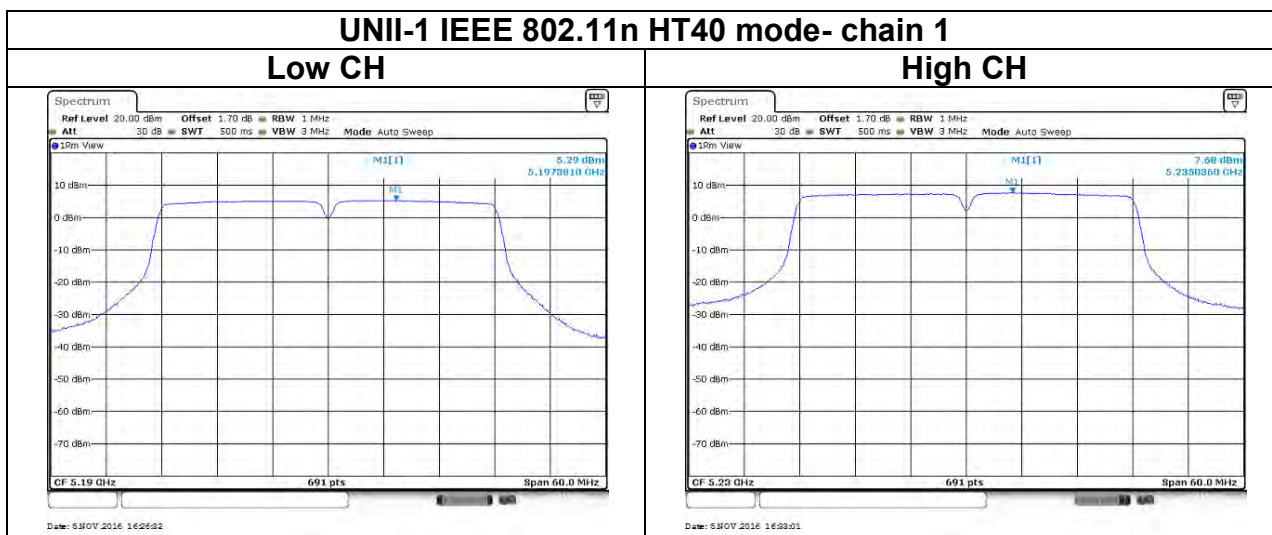
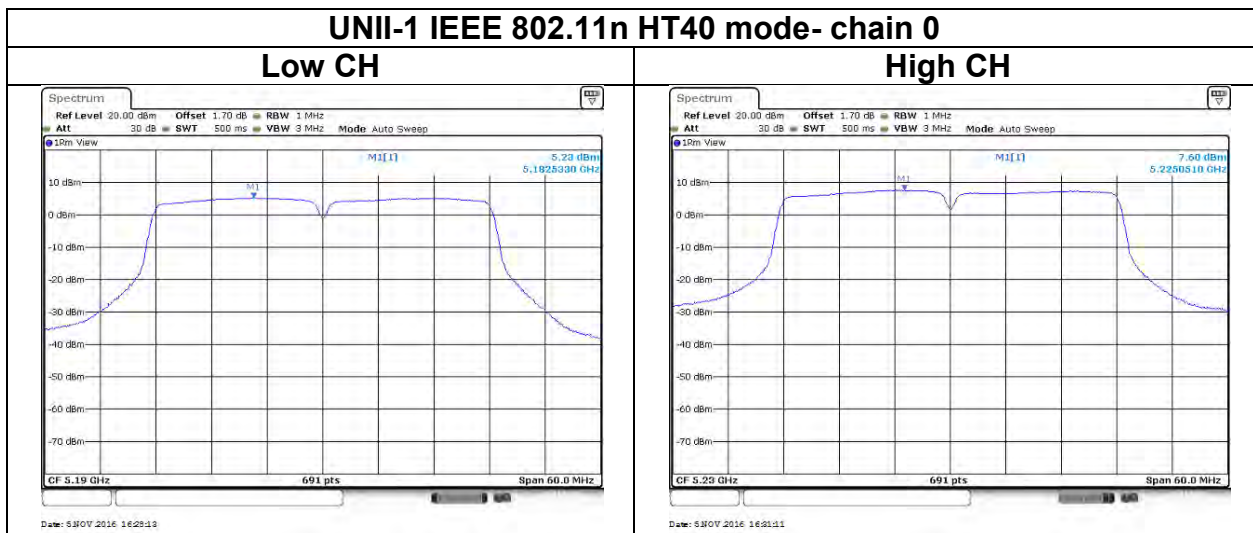

UNII-1 IEEE 802.11ac VHT80 mode- chain 0

Mid CH

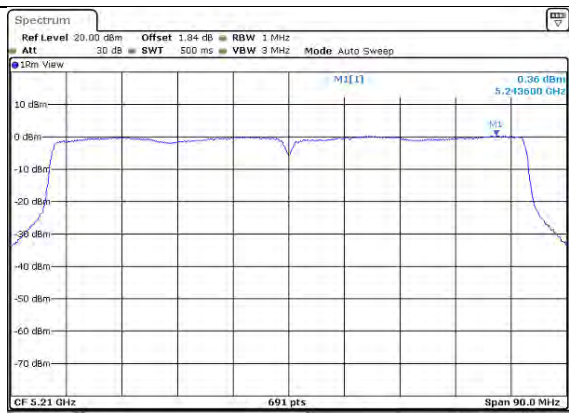

Date: 8 NOV 2016 17:29:27

UNII-1 IEEE 802.11ac VHT80 mode- chain 1

Mid CH

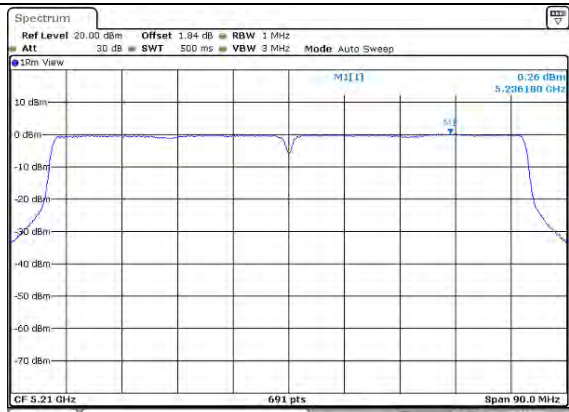

Date: 8 NOV 2016 17:40:12

Test Data



UNII-3 IEEE 802.11a mode- chain 1

Low CH

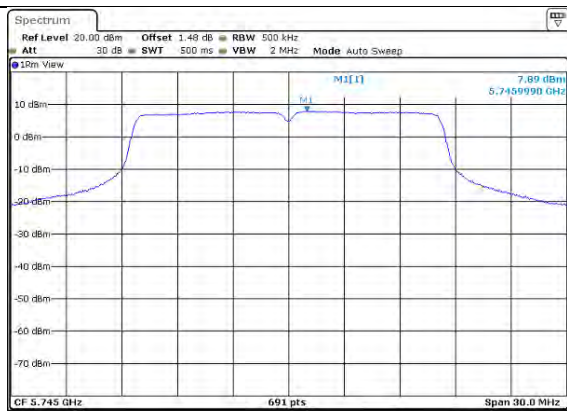

Mid CH

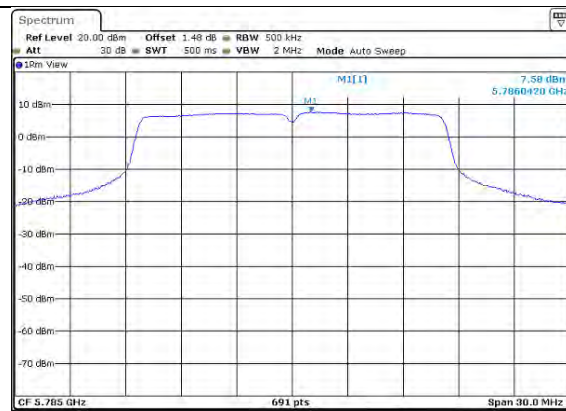

High CH

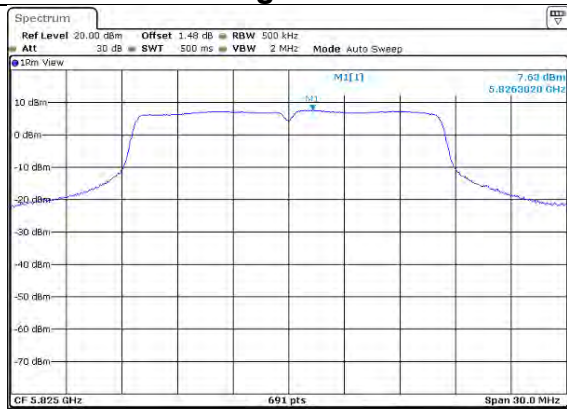

UNII-3 IEEE 802.11n HT20 mode- chain 0

Low CH

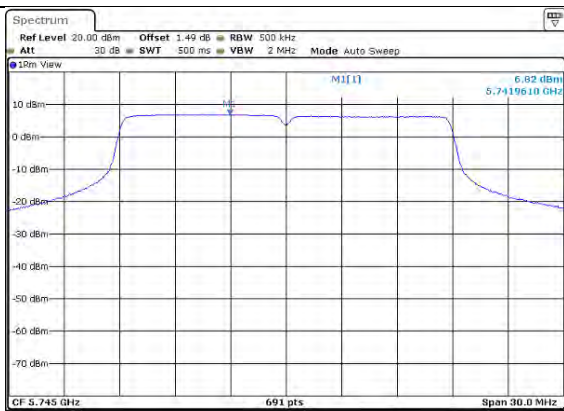

Date: 7 NOV 2016 08:44:28

Mid CH

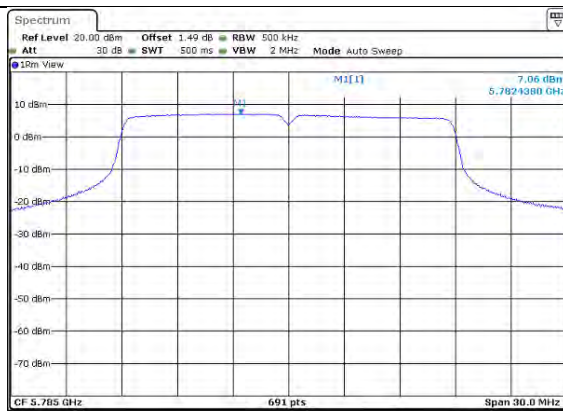

Date: 7 NOV 2016 08:51:56

High CH

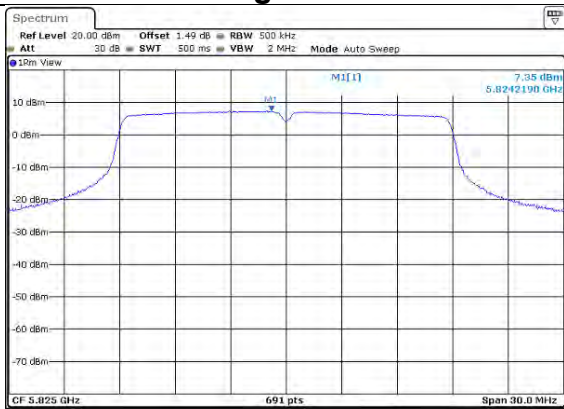

Date: 7 NOV 2016 08:56:24

UNII-3 IEEE 802.11n HT20 mode- chain 1

Low CH

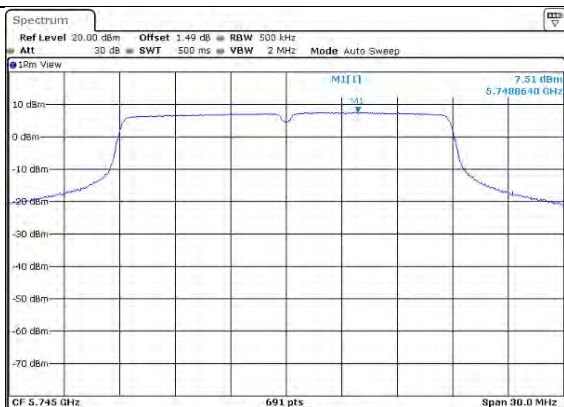

Mid CH

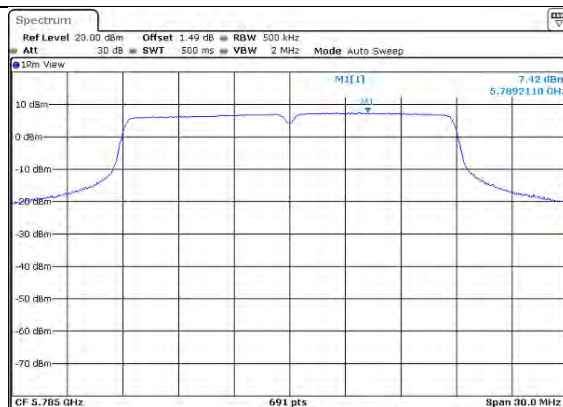

High CH

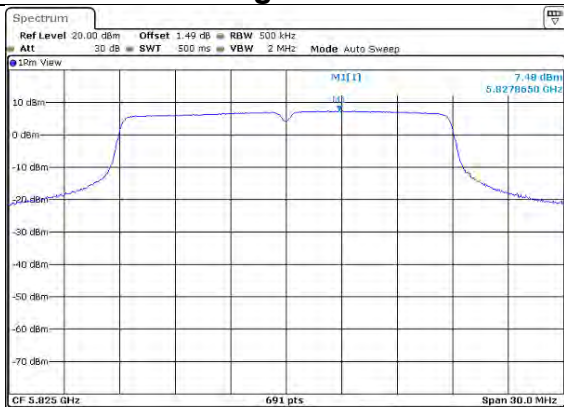

UNII-3 IEEE 802.11n HT40 mode- chain 0

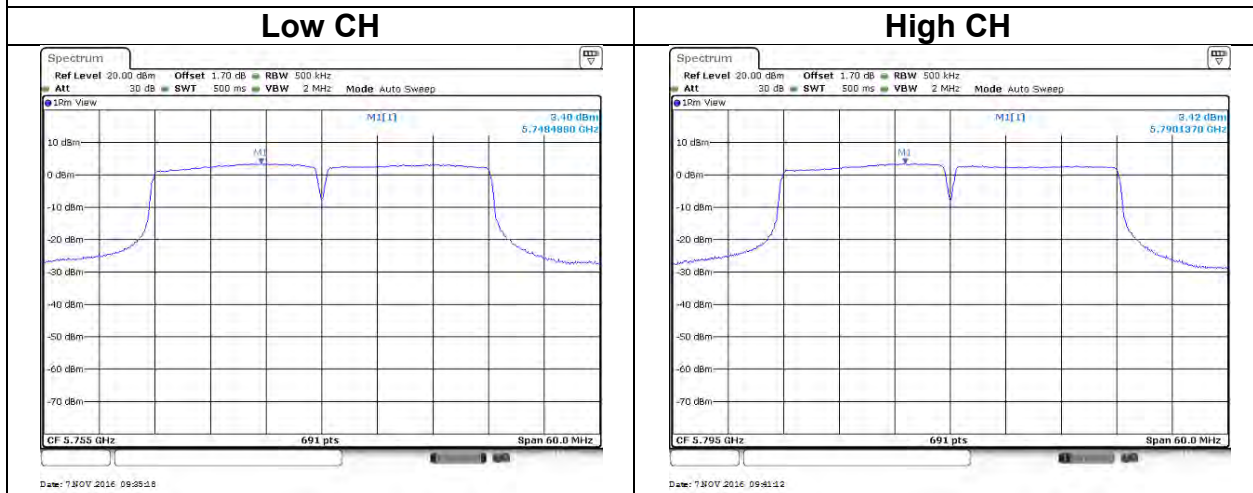

UNII-3 IEEE 802.11n HT40 mode- chain 1

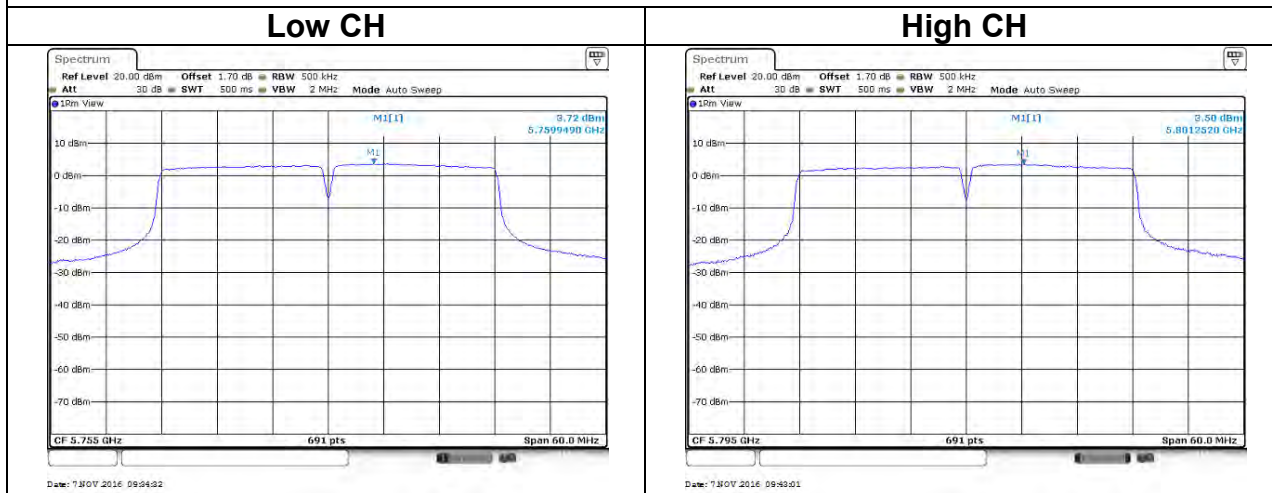

UNII-3 IEEE 802.11ac VHT80 mode- chain 0

Mid CH

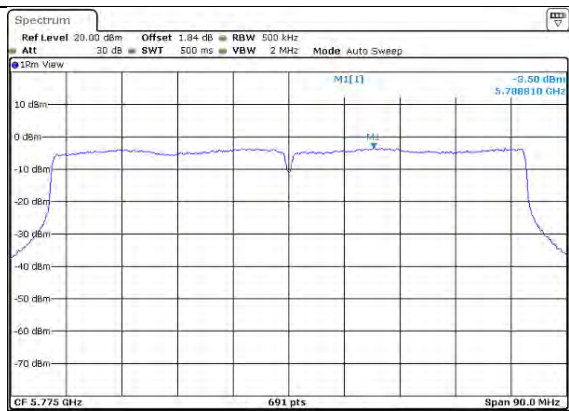

UNII-3 IEEE 802.11ac VHT80 mode- chain 1

Mid CH

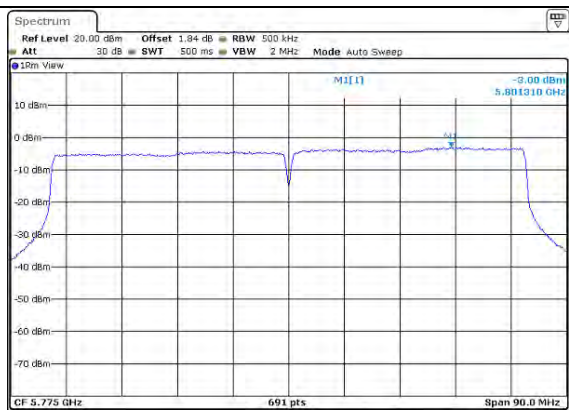

4.5 RADIATION BANDEGE AND SPURIOUS EMISSION

4.5.1 Test Limit

According to §15.407, §15.209 and §15.205,

Below 30 MHz

Frequency	Field Strength (microvolts/m)	Magnetic H-Field (microamperes/m)	Measurement Distance (metres)
9-490 kHz	2,400/F (F in kHz)	2,400/F (F in kHz)	300
490-1,705 kHz	24,000/F (F in kHz)	24,000/F (F in kHz)	30
1.705-30 MHz	30	N/A	30

Above 30 MHz

Frequency (MHz)	Field Strength microvolts/m at 3 metres (watts, e.i.r.p.)	
	Transmitters	Receivers
30-88	100 (3 nW)	100 (3 nW)
88-216	150 (6.8 nW)	150 (6.8 nW)
216-960	200 (12 nW)	200 (12 nW)
Above 960	500 (75 nW)	500 (75 nW)

4.5.2 Test Procedure

Test method Refer as KDB 789033 D02 v01r03, Section G.3, G.4, G.5, and G.6,.

1. The EUT is placed on a turntable, Above 1 GHz is 1.5m and below 1 GHz is 0.8m above ground plane. The EUT Configured un accordance with ANSI C63.10, and the EUT set in a continuous mode.
2. The turntable shall be rotated for 360 degrees to determine the position of maximum emission level. And EUT is set 3m away from the receiving antenna, which is scanned from 1m to 4m above the ground plane to find out the highest emissions. Measurement are made polarized in both the vertical and the horizontal positions with antenna.
3. Span shall wide enough to full capture the emission measured. The SA from 30MHz to 26.5GHz set to the low, Mid and High channels with the EUT transmit.
5. The SA setting following :
 - (1) Below 1G : RBW = 100kHz, VBW \geq 3*RBW, Sweep = Auto, Detector = Peak, Trace = Max hold.
 - (2) Above 1G :
 - (2.1) For Peak measurement : RBW = 1MHz, VBW \geq 3 RBW, Sweep = Auto, Detector = Peak, Trace = Max hold.
 - (2.2) For Average measurement : RBW = 1MHz, VBW
 - If Duty Cycle \geq 98%, VBW=10Hz.
 - If Duty Cycle < 98%, VBW=1/T.

Configuration	Duty Cycle (%)	VBW
802.11a	99.43%	10Hz
802.11n HT20	97.97%	10Hz
802.11n HT40	94.44%	750Hz
802.11ac VHT80	90.67%	1.5kHz

4.5.3 Test Setup

9kHz ~ 30MHz

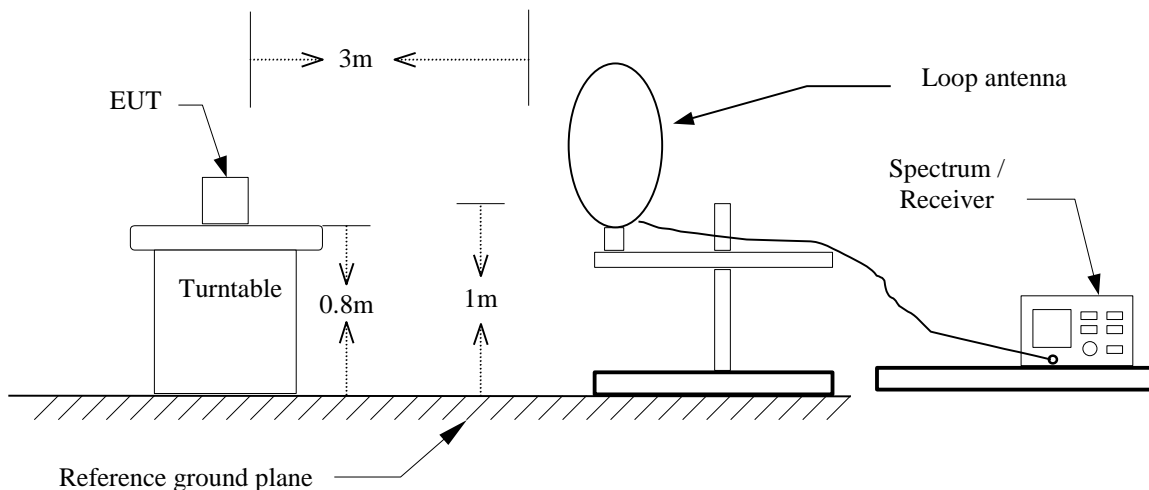

30MHz ~ 1GHz

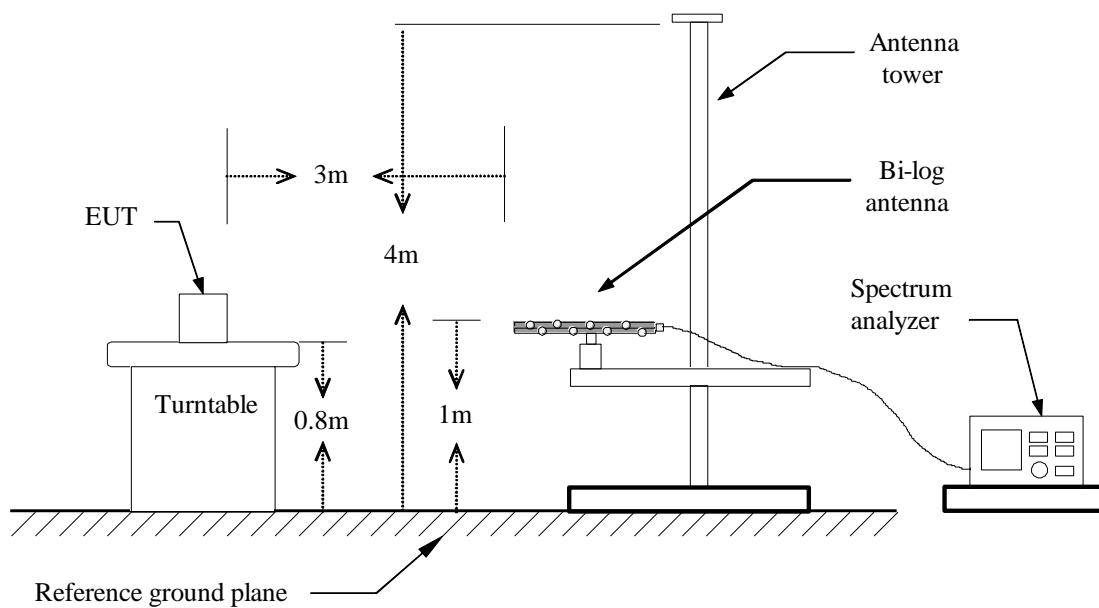

Above 1 GHz

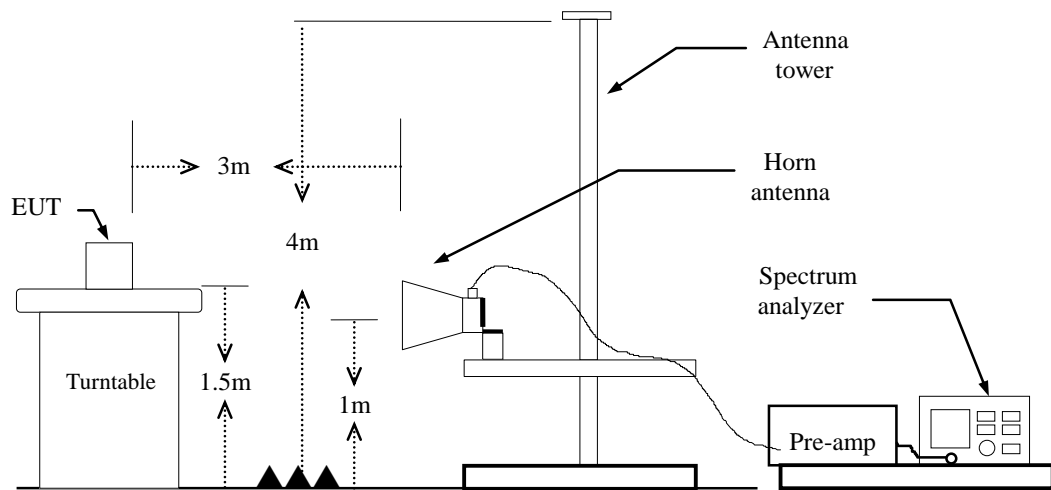

4.5.4 Test Result

Test Data

Band Edge Test Data for UNII-1

Test Mode	IEEE 802.11a Low CH	Temp/Hum	27(°C)/ 53%RH
Test Item	Band Edge	Test Date	Nov 08, 2016
Polarize	Vertical	Test Engineer	Dennis Li
Detector	Peak	Test Voltage	120Vac / 60Hz

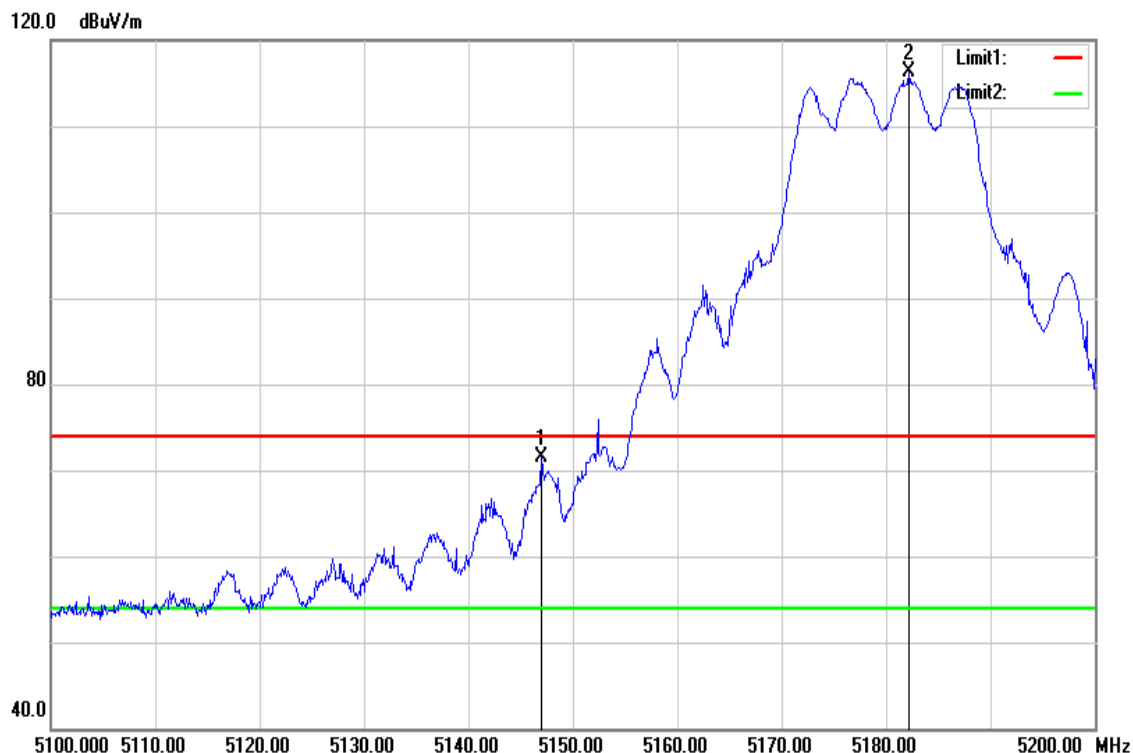

Frequency (MHz)	Reading (dBuV)	Correct Factor (dB/m)	Result (dBuV/m)	Limit (dBuV/m)	Margin (dB)	Remark
5147.000	68.42	3.02	71.44	74.00	-2.56	peak
5182.200	112.36	3.97	116.33	-	-	peak

Test Mode	IEEE 802.11a Low CH	Temperature	27(°C)/ 53%RH
Test Item	Band Edge	Test Date	Nov 08, 2016
Polarize	Vertical	Test Engineer	Dennis Li
Detector	Average	Test Voltage	120Vac / 60Hz

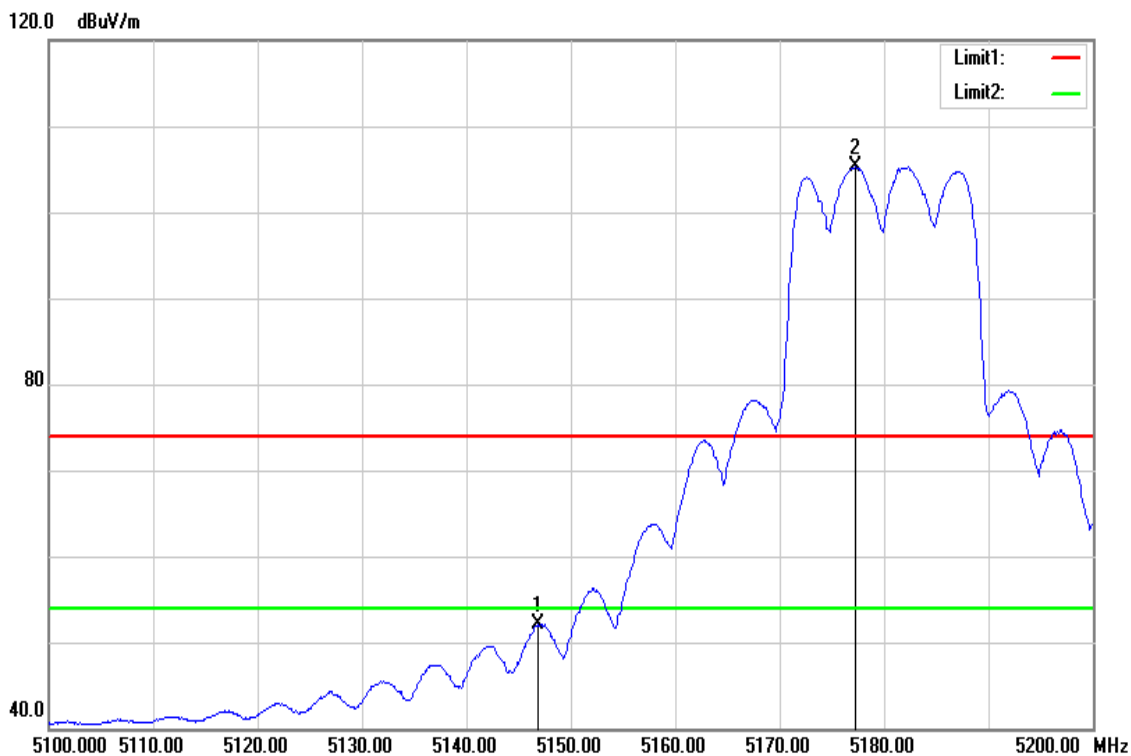

Frequency (MHz)	Reading (dBuV)	Correct Factor (dB/m)	Result (dBuV/m)	Limit (dBuV/m)	Margin (dB)	Remark
5146.800	49.10	3.02	52.12	54.00	-1.88	AVG
5177.300	101.55	3.83	105.38	-	-	AVG

Test Mode	IEEE 802.11a High CH	Temp/Hum	27(°C)/ 53%RH
Test Item	Band Edge	Test Date	Nov 08, 2016
Polarize	Vertical	Test Engineer	Dennis Li
Detector	Peak	Test Voltage	120Vac / 60Hz

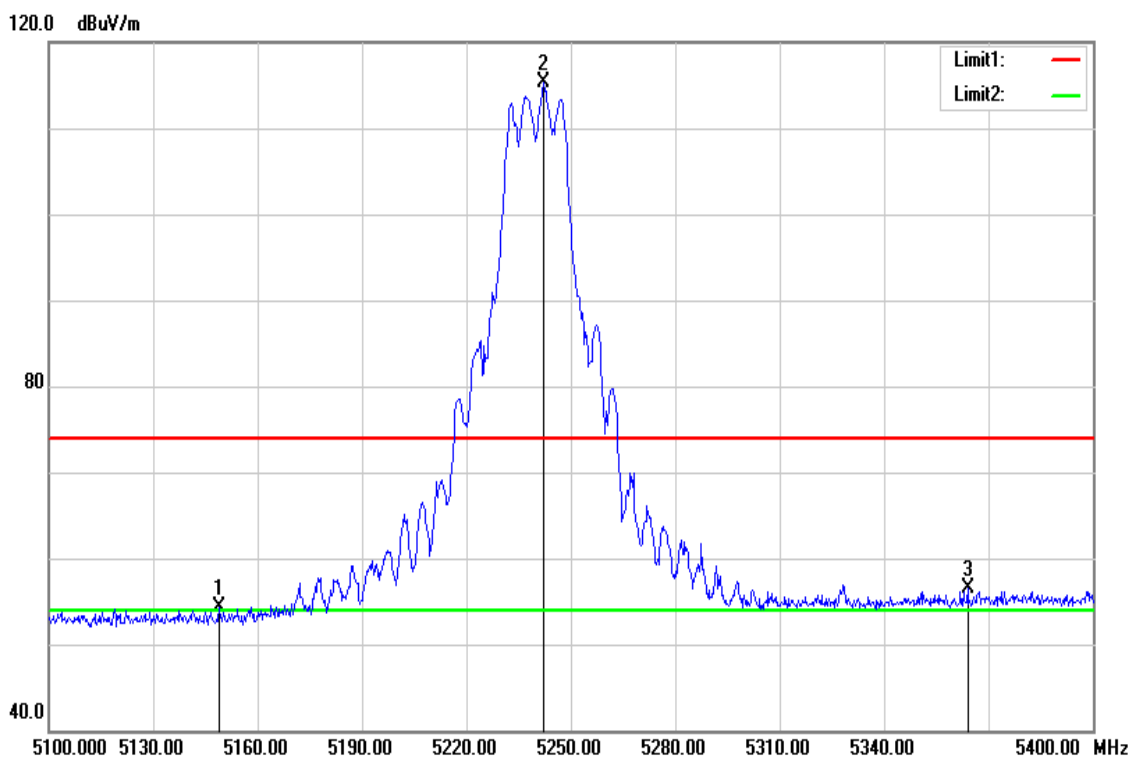

Frequency (MHz)	Reading (dBuV)	Correct Factor (dB/m)	Result (dBuV/m)	Limit (dBuV/m)	Margin (dB)	Remark
5148.900	51.34	3.03	54.37	74.00	-19.63	peak
5242.200	110.65	4.63	115.28	-	-	peak
5364.000	51.01	5.42	56.43	74.00	-17.57	peak

Test Mode	IEEE 802.11a High CH	Temperature	27(°C) / 53%RH
Test Item	Band Edge	Test Date	Nov 08, 2016
Polarize	Vertical	Test Engineer	Dennis Li
Detector	Average	Test Voltage	120Vac / 60Hz

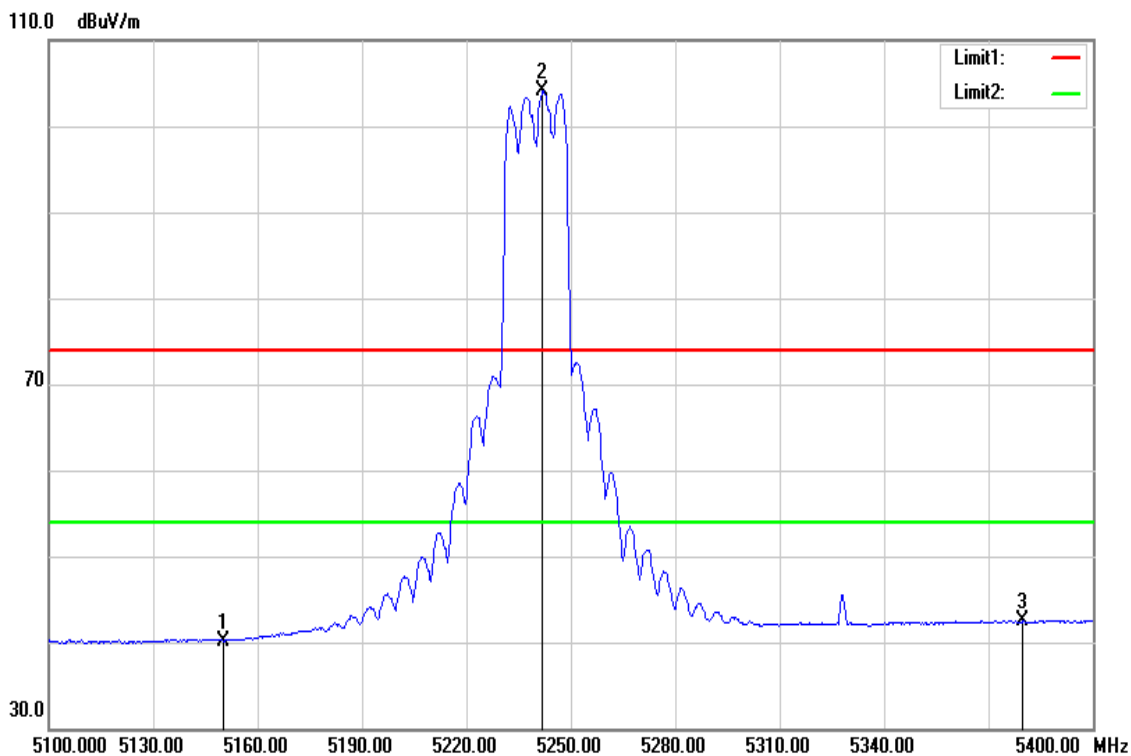

Frequency (MHz)	Reading (dBuV)	Correct Factor (dB/m)	Result (dBuV/m)	Limit (dBuV/m)	Margin (dB)	Remark
5150.000	37.13	3.04	40.17	54.00	-13.83	AVG
5241.900	99.51	4.63	104.14	-	-	AVG
5379.900	36.95	5.56	42.51	54.00	-11.49	AVG

Test Mode	IEEE 802.11n HT20 Low CH	Temp/Hum	27(°C) / 53%RH
Test Item	Band Edge	Test Date	Nov 08, 2016
Polarize	Vertical	Test Engineer	Dennis Li
Detector	Peak	Test Voltage	120Vac / 60Hz

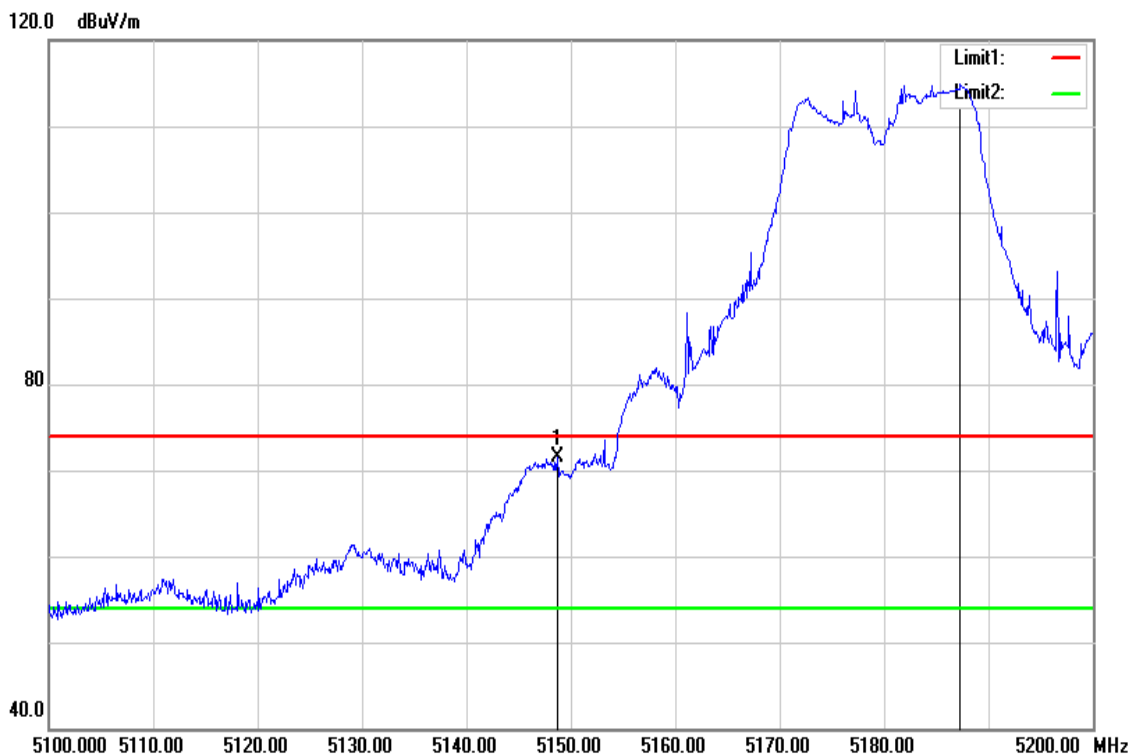

Frequency (MHz)	Reading (dBuV)	Correct Factor (dB/m)	Result (dBuV/m)	Limit (dBuV/m)	Margin (dB)	Remark
5148.700	68.41	3.03	71.44	74.00	-2.56	peak
5187.300	110.73	4.12	114.85	-	-	peak

Test Mode	IEEE 802.11n HT20 Low CH	Temperature	27(°C) / 53%RH
Test Item	Band Edge	Test Date	Nov 08, 2016
Polarize	Vertical	Test Engineer	Dennis Li
Detector	Average	Test Voltage	120Vac / 60Hz

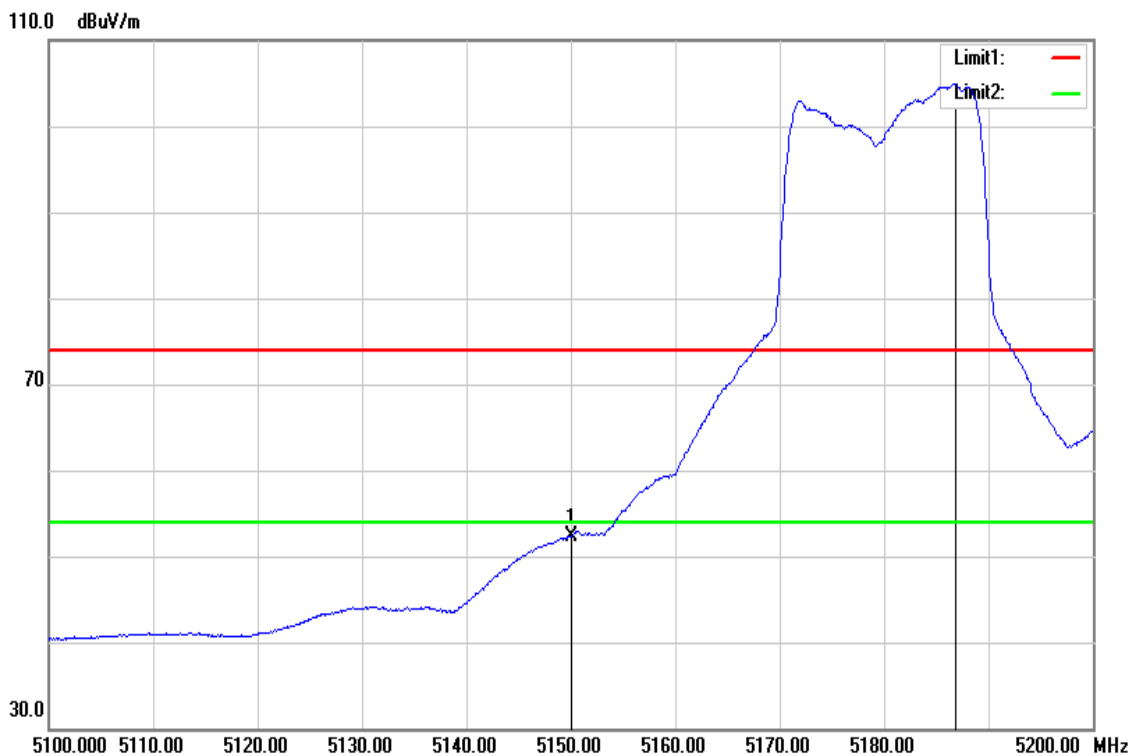

Frequency (MHz)	Reading (dBuV)	Correct Factor (dB/m)	Result (dBuV/m)	Limit (dBuV/m)	Margin (dB)	Remark
5150.000	49.31	3.04	52.35	54.00	-1.65	AVG
5186.800	100.86	4.11	104.97	-	-	AVG

Test Mode	IEEE 802.11n HT20 High CH	Temp/Hum	27(°C) / 53%RH
Test Item	Band Edge	Test Date	Nov 08, 2016
Polarize	Vertical	Test Engineer	Dennis Li
Detector	Peak	Test Voltage	120Vac / 60Hz

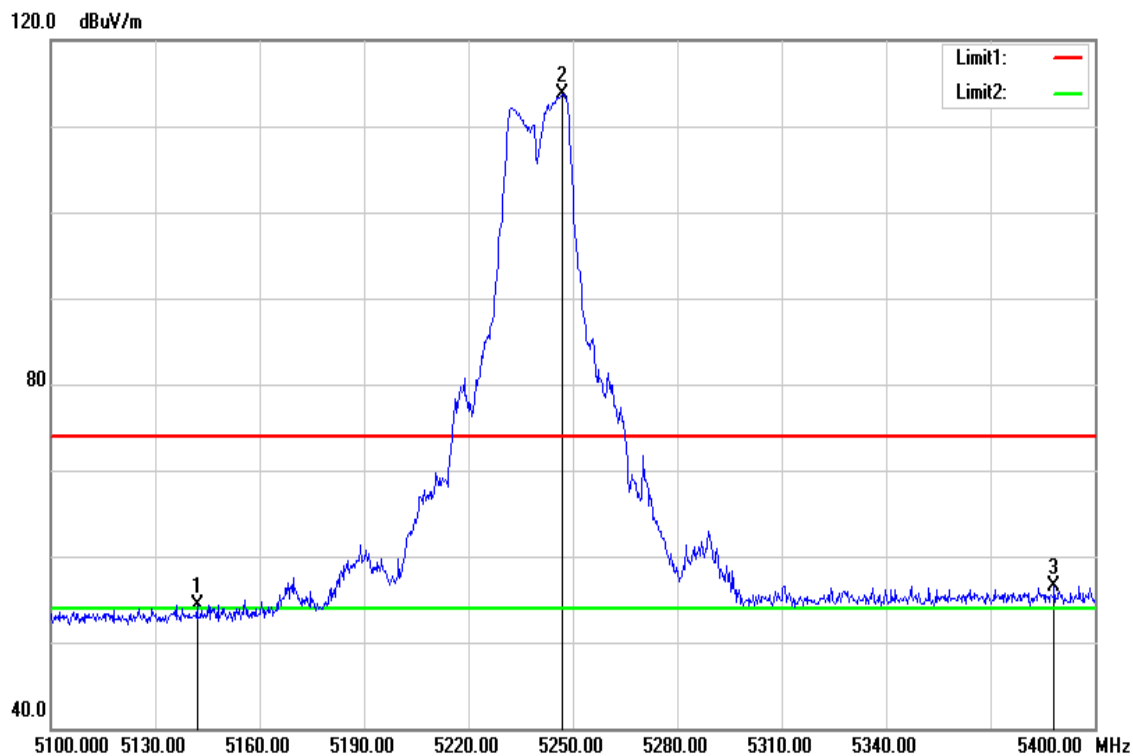

Frequency (MHz)	Reading (dBuV)	Correct Factor (dB/m)	Result (dBuV/m)	Limit (dBuV/m)	Margin (dB)	Remark
5142.000	51.36	2.99	54.35	74.00	-19.65	peak
5247.000	109.04	4.65	113.69	-	-	peak
5388.300	50.86	5.62	56.48	74.00	-17.52	peak

Test Mode	IEEE 802.11n HT20 High CH	Temperature	27(°C) / 53%RH
Test Item	Band Edge	Test Date	Nov 08, 2016
Polarize	Vertical	Test Engineer	Dennis Li
Detector	Average	Test Voltage	120Vac / 60Hz

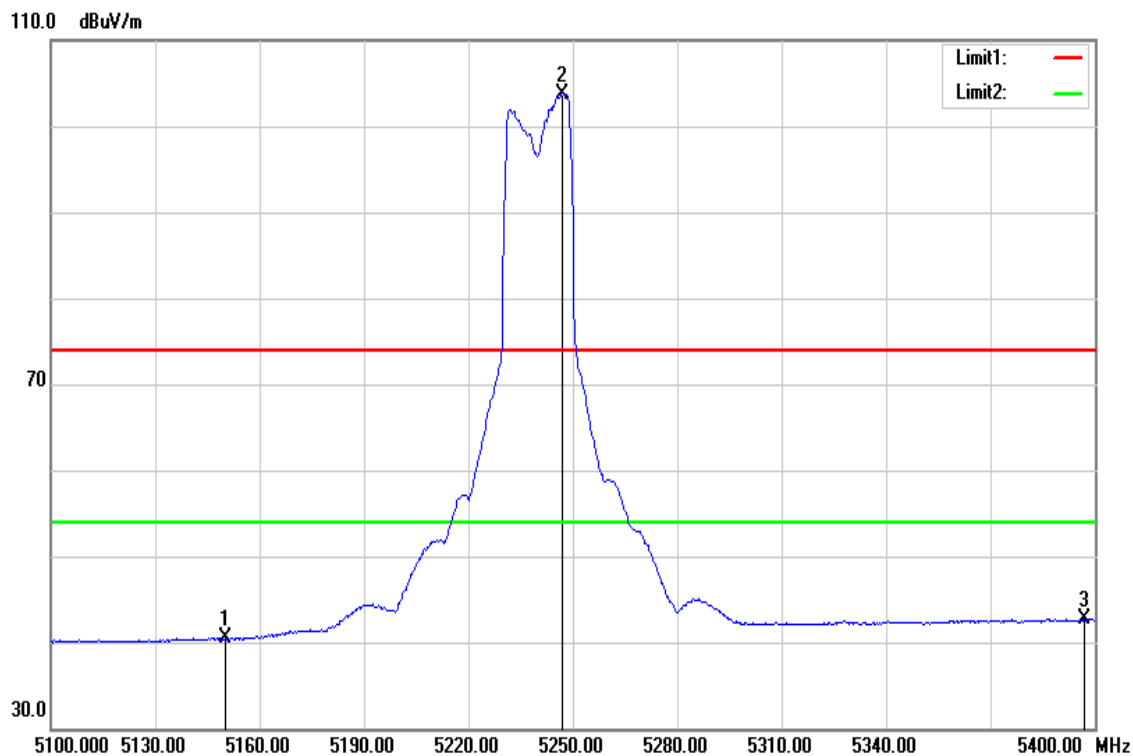

Frequency (MHz)	Reading (dBuV)	Correct Factor (dB/m)	Result (dBuV/m)	Limit (dBuV/m)	Margin (dB)	Remark
5150.000	37.38	3.04	40.42	54.00	-13.58	AVG
5247.000	99.15	4.65	103.80	-	-	AVG
5397.000	37.00	5.70	42.70	54.00	-11.30	AVG

Test Mode	IEEE 802.11n HT40 Low CH	Temp/Hum	27(°C) / 53%RH
Test Item	Band Edge	Test Date	Nov 08, 2016
Polarize	Vertical	Test Engineer	Dennis Li
Detector	Peak	Test Voltage	120Vac / 60Hz

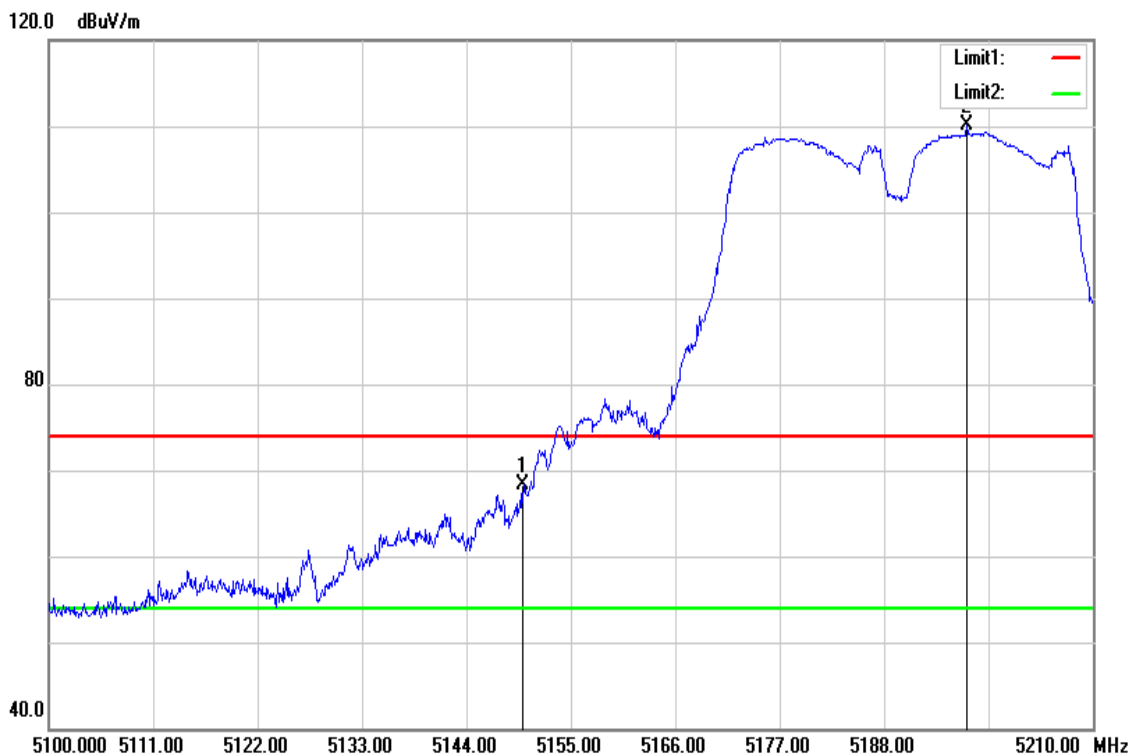

Frequency (MHz)	Reading (dBuV)	Correct Factor (dB/m)	Result (dBuV/m)	Limit (dBuV/m)	Margin (dB)	Remark
5150.000	65.35	3.04	68.39	74.00	-5.61	peak
5196.690	105.66	4.39	110.05	-	-	peak

Test Mode	IEEE 802.11n HT40 Low CH	Temperature	27(°C) / 53%RH
Test Item	Band Edge	Test Date	Nov 08, 2016
Polarize	Vertical	Test Engineer	Dennis Li
Detector	Average	Test Voltage	120Vac / 60Hz

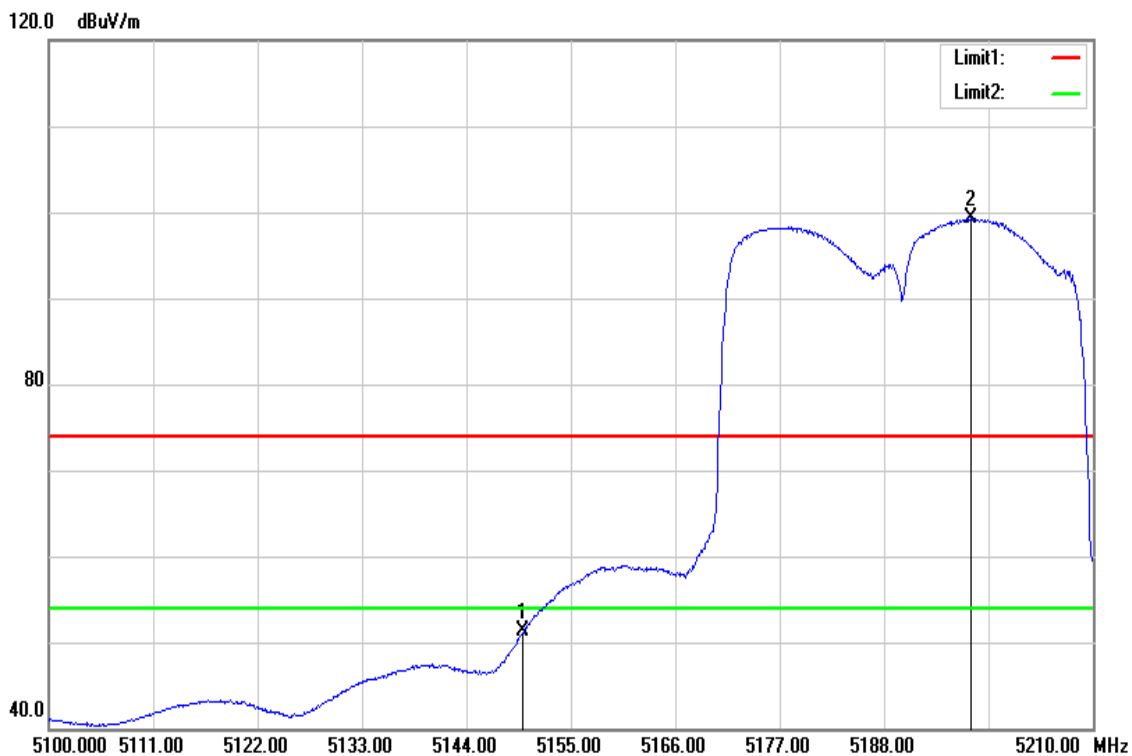

Frequency (MHz)	Reading (dBuV)	Correct Factor (dB/m)	Result (dBuV/m)	Limit (dBuV/m)	Margin (dB)	Remark
5150.000	48.16	3.04	51.20	54.00	-2.80	AVG
5197.130	94.87	4.41	99.28	-	-	AVG

Test Mode	IEEE 802.11n HT40 High CH	Temp/Hum	27(°C)/ 53%RH
Test Item	Band Edge	Test Date	Nov 08, 2016
Polarize	Vertical	Test Engineer	Dennis Li
Detector	Peak	Test Voltage	120Vac / 60Hz

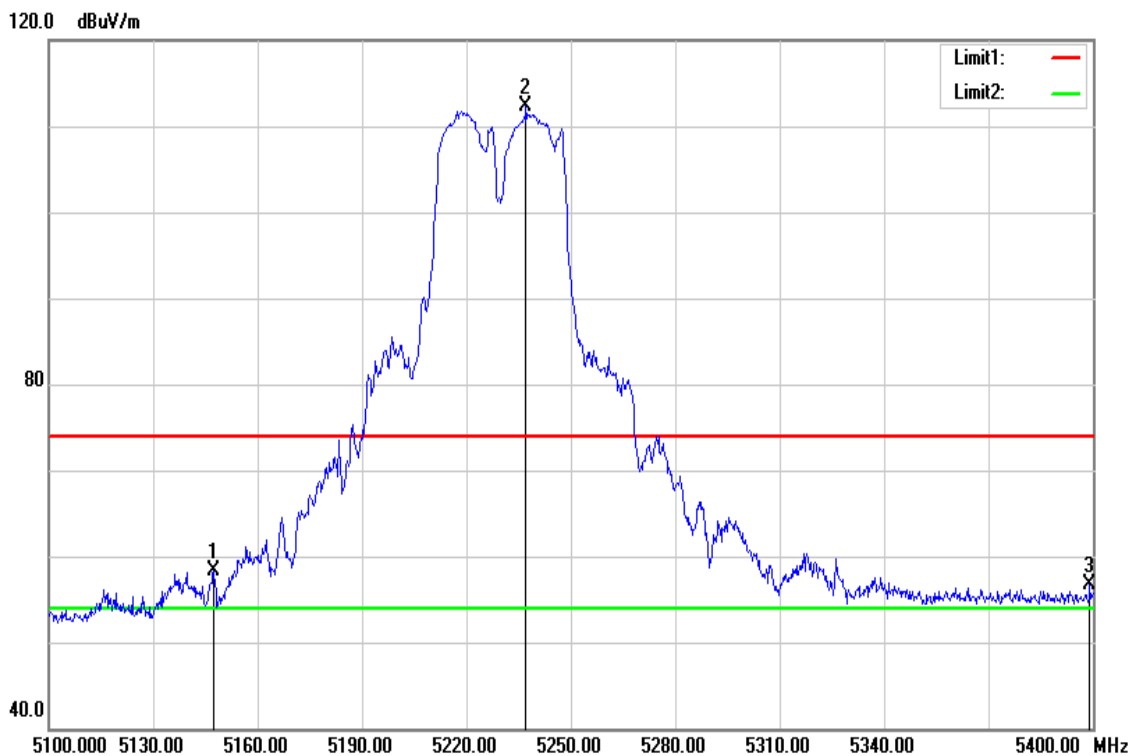

Frequency (MHz)	Reading (dBuV)	Correct Factor (dB/m)	Result (dBuV/m)	Limit (dBuV/m)	Margin (dB)	Remark
5147.400	55.27	3.02	58.29	74.00	-15.71	peak
5237.100	107.62	4.62	112.24	-	-	peak
5399.100	50.97	5.71	56.68	74.00	-17.32	peak

Test Mode	IEEE 802.11n HT40 High CH	Temperature	27(°C) / 53%RH
Test Item	Band Edge	Test Date	Nov 08, 2016
Polarize	Vertical	Test Engineer	Dennis Li
Detector	Average	Test Voltage	120Vac / 60Hz

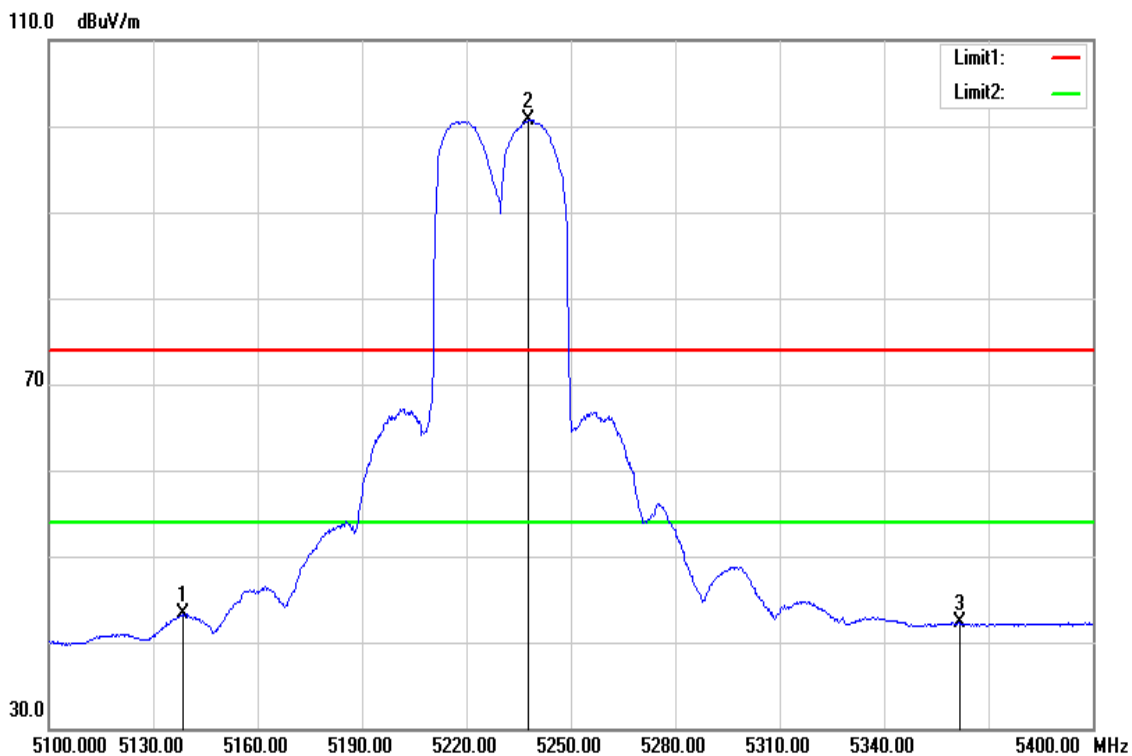

Frequency (MHz)	Reading (dBuV)	Correct Factor (dB/m)	Result (dBuV/m)	Limit (dBuV/m)	Margin (dB)	Remark
5138.700	40.27	2.96	43.23	54.00	-10.77	AVG
5237.700	96.16	4.62	100.78	-	-	AVG
5361.900	36.88	5.41	42.29	54.00	-11.71	AVG

Test Mode	IEEE 802.11ac VHT80 Mid CH	Temp/Hum	27(°C) / 53%RH
Test Item	Band Edge	Test Date	Nov 08, 2016
Polarize	Vertical	Test Engineer	Dennis Li
Detector	Peak	Test Voltage	120Vac / 60Hz

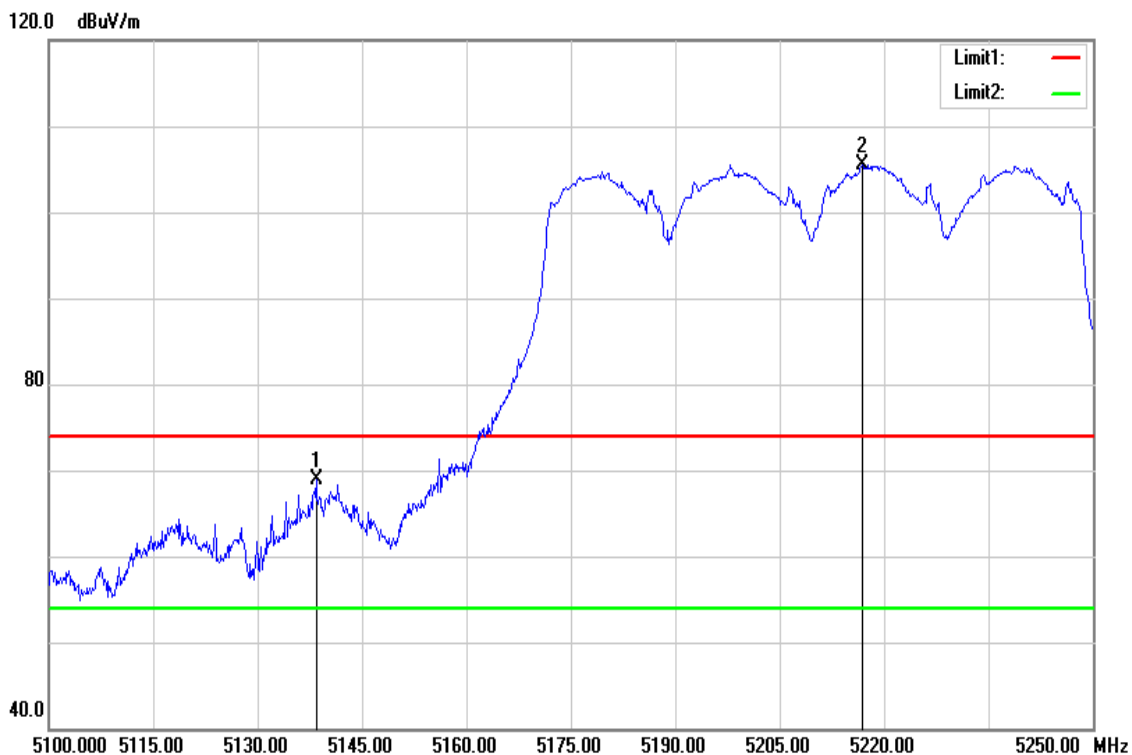

Frequency (MHz)	Reading (dBuV)	Correct Factor (dB/m)	Result (dBuV/m)	Limit (dBuV/m)	Margin (dB)	Remark
5138.400	65.98	2.96	68.94	74.00	-5.06	peak
5216.850	100.96	4.55	105.51	-	-	peak

Test Mode	IEEE 802.11ac VHT80 Mid CH	Temperature	27(°C) / 53%RH
Test Item	Band Edge	Test Date	Nov 08, 2016
Polarize	Vertical	Test Engineer	Dennis Li
Detector	Average	Test Voltage	120Vac / 60Hz

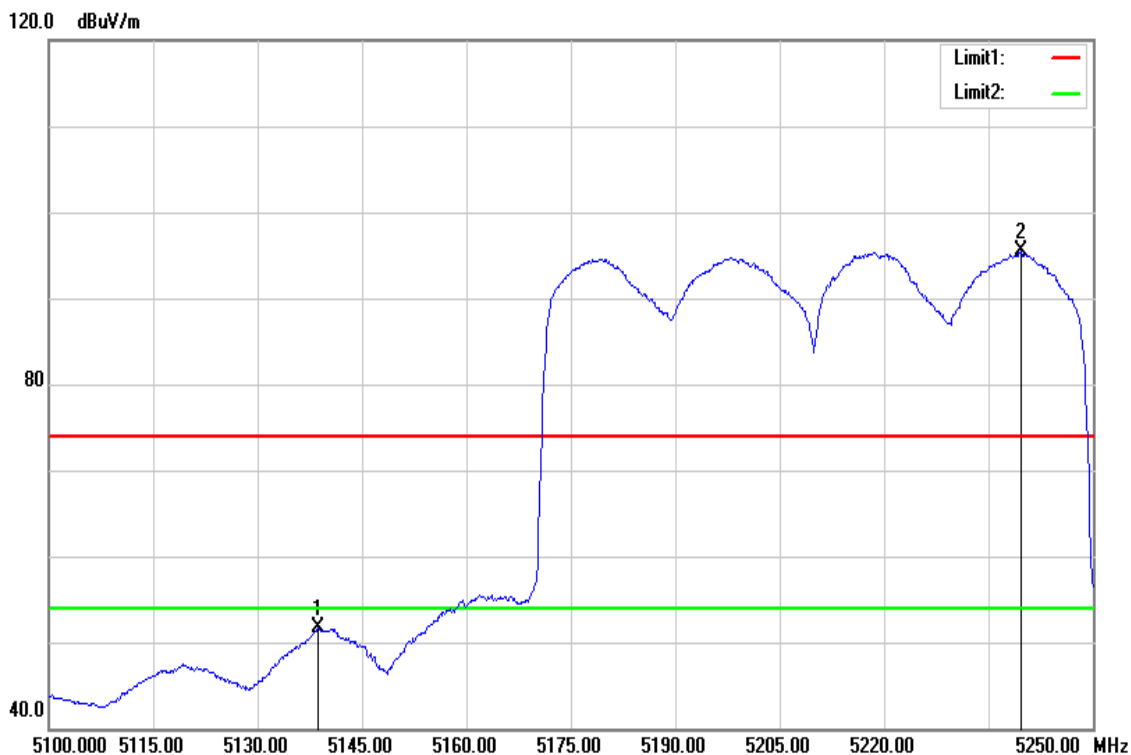

Frequency (MHz)	Reading (dBuV)	Correct Factor (dB/m)	Result (dBuV/m)	Limit (dBuV/m)	Margin (dB)	Remark
5138.700	48.72	2.96	51.68	54.00	-2.32	AVG
5239.650	90.94	4.62	95.56	-	-	AVG

Band Edge Test Data for UNII-3

Test Mode	IEEE 802.11a Low CH	Temp/Hum	27(°C)/ 53%RH
Test Item	Band Edge	Test Date	Nov 08, 2016
Polarize	Vertical	Test Engineer	Dennis Li
Detector	Peak	Test Voltage	120Vac / 60Hz

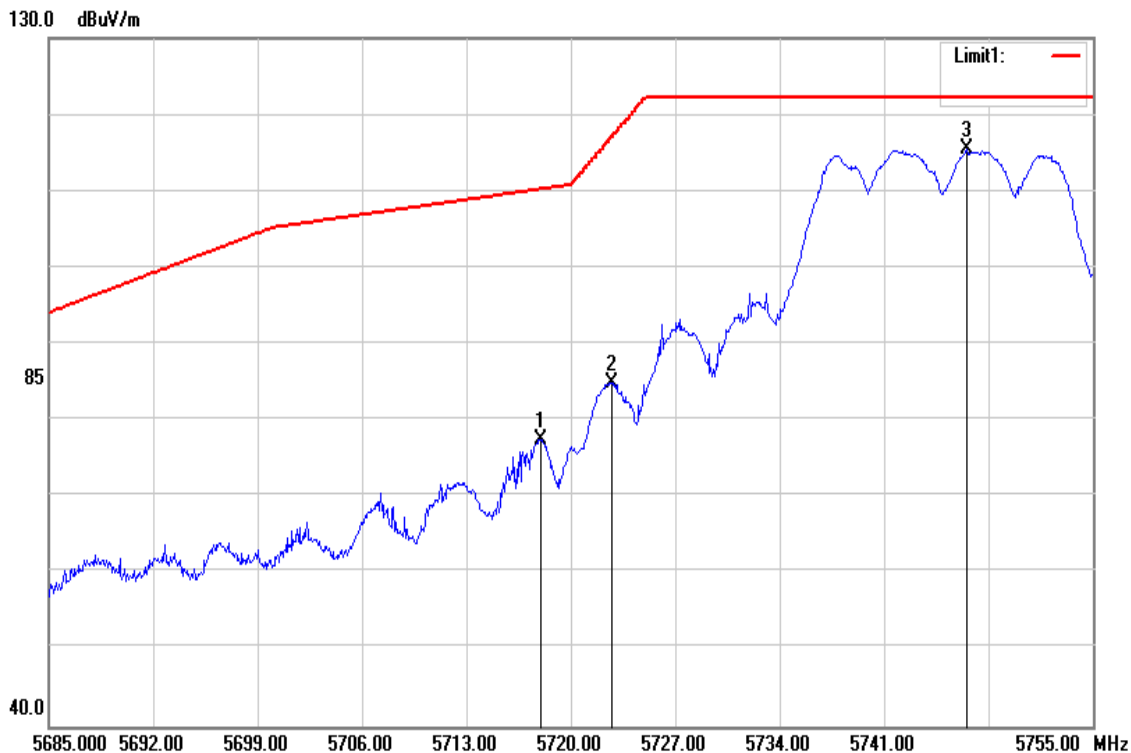

Frequency (MHz)	Reading (dBuV)	Correct Factor (dB/m)	Result (dBuV/m)	Limit (dBuV/m)	Margin (dB)	Remark
5717.970	71.30	6.18	77.48	110.23	-32.75	peak
5722.730	78.73	6.20	84.93	117.02	-32.09	peak
5746.530	109.15	6.30	115.45	-	-	peak

Test Mode	IEEE 802.11a Low CH	Temperature	27(°C) / 53%RH
Test Item	Band Edge	Test Date	Nov 08, 2016
Polarize	Vertical	Test Engineer	Dennis Li
Detector	Average	Test Voltage	120Vac / 60Hz

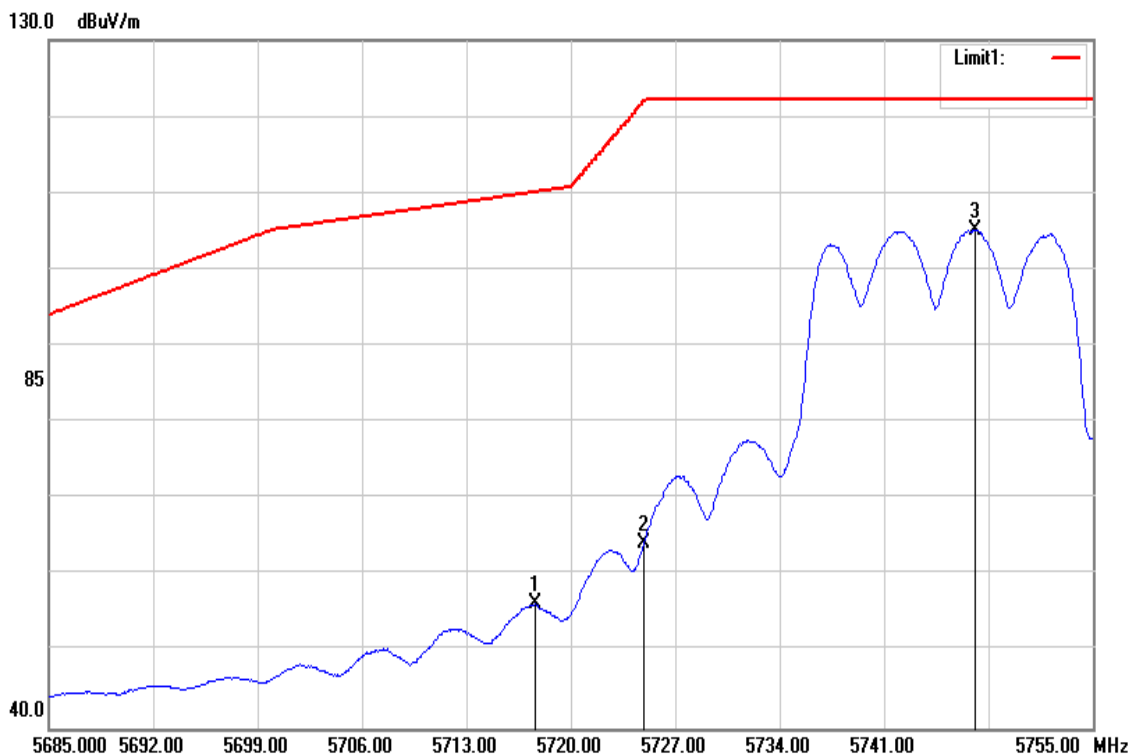

Frequency (MHz)	Reading (dBuV)	Correct Factor (dB/m)	Result (dBuV/m)	Limit (dBuV/m)	Margin (dB)	Remark
5717.620	50.08	6.18	56.26	110.13	-53.87	AVG
5724.900	57.92	6.21	64.13	121.97	-57.84	AVG
5747.090	98.92	6.30	105.22	-	-	AVG

Test Mode	IEEE 802.11a High CH	Temp/Hum	27(°C) / 53%RH
Test Item	Band Edge	Test Date	Nov 08, 2016
Polarize	Vertical	Test Engineer	Dennis Li
Detector	Peak	Test Voltage	120Vac / 60Hz

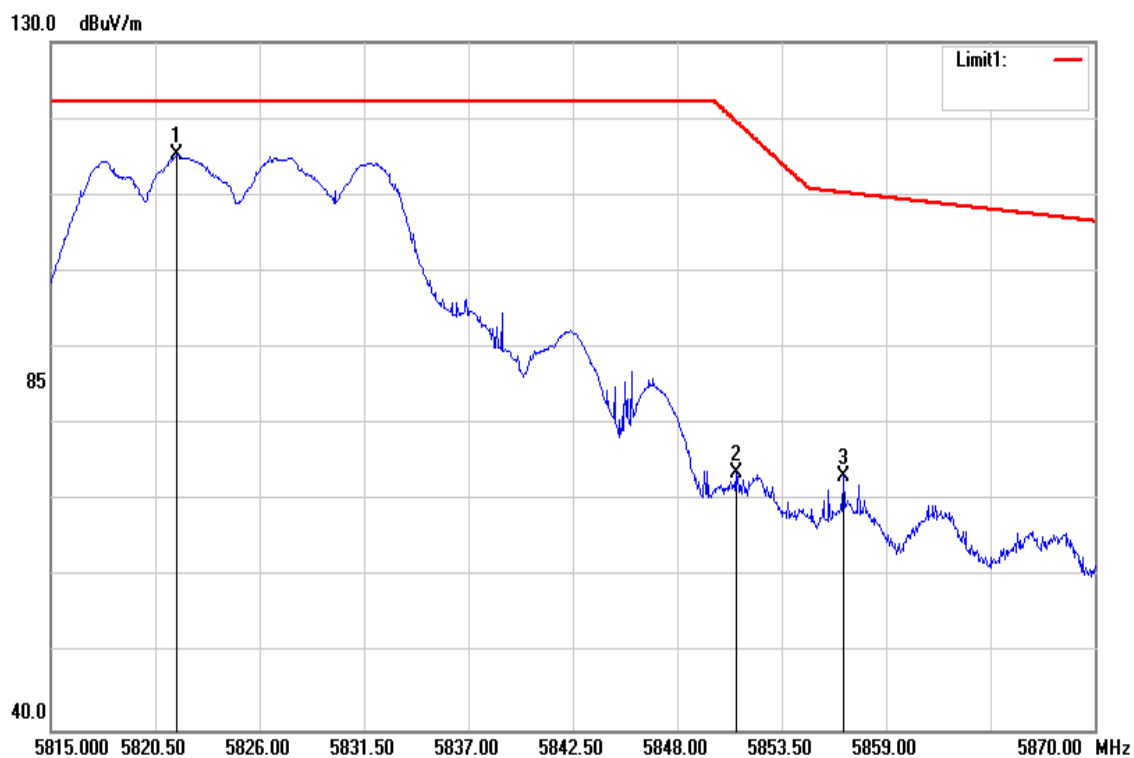

Frequency (MHz)	Reading (dBuV)	Correct Factor (dB/m)	Result (dBuV/m)	Limit (dBuV/m)	Margin (dB)	Remark
5821.655	108.66	6.62	115.28	-	-	peak
5851.080	66.86	6.75	73.61	119.74	-46.13	peak
5856.745	66.53	6.77	73.30	110.31	-37.01	peak

Test Mode	IEEE 802.11a High CH	Temperature	27(°C) / 53%RH
Test Item	Band Edge	Test Date	Nov 08, 2016
Polarize	Vertical	Test Engineer	Dennis Li
Detector	Average	Test Voltage	120Vac / 60Hz

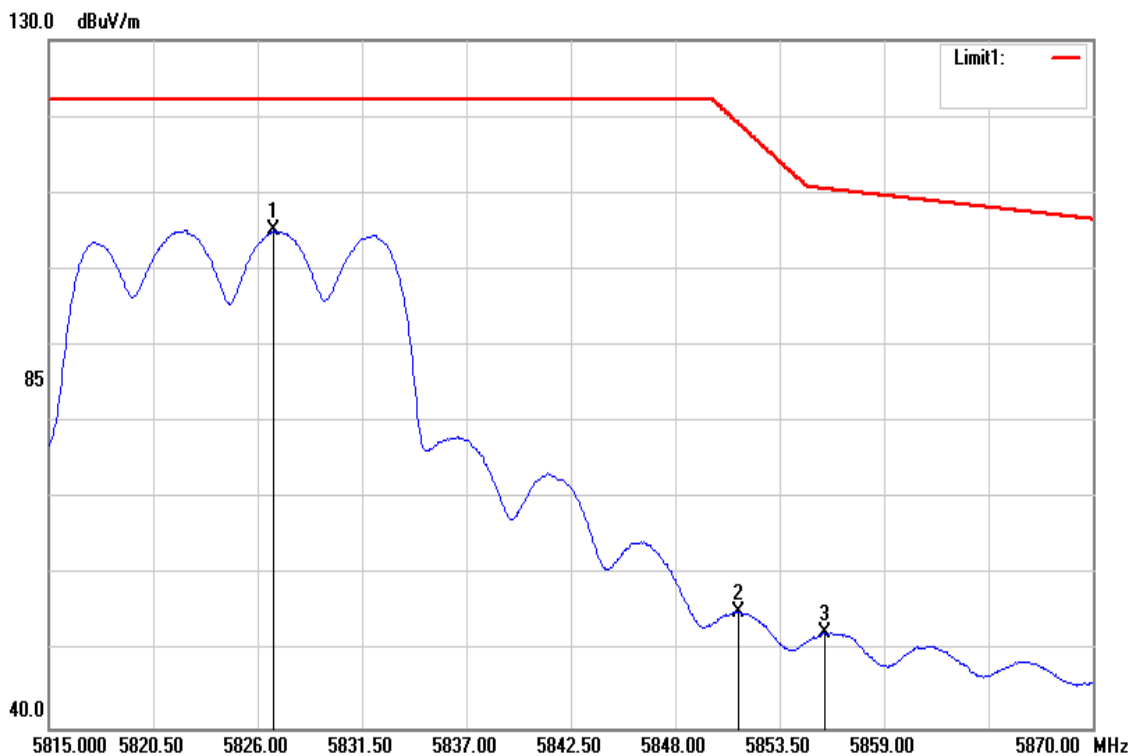

Frequency (MHz)	Reading (dBuV)	Correct Factor (dB/m)	Result (dBuV/m)	Limit (dBuV/m)	Margin (dB)	Remark
5826.825	98.46	6.64	105.10	-	-	AVG
5851.300	48.47	6.75	55.22	119.24	-64.02	AVG
5855.865	45.72	6.77	52.49	110.56	-58.07	AVG

Test Mode	IEEE 802.11n HT20 Low CH	Temp/Hum	27(°C) / 53%RH
Test Item	Band Edge	Test Date	Nov 08, 2016
Polarize	Vertical	Test Engineer	Dennis Li
Detector	Peak	Test Voltage	120Vac / 60Hz

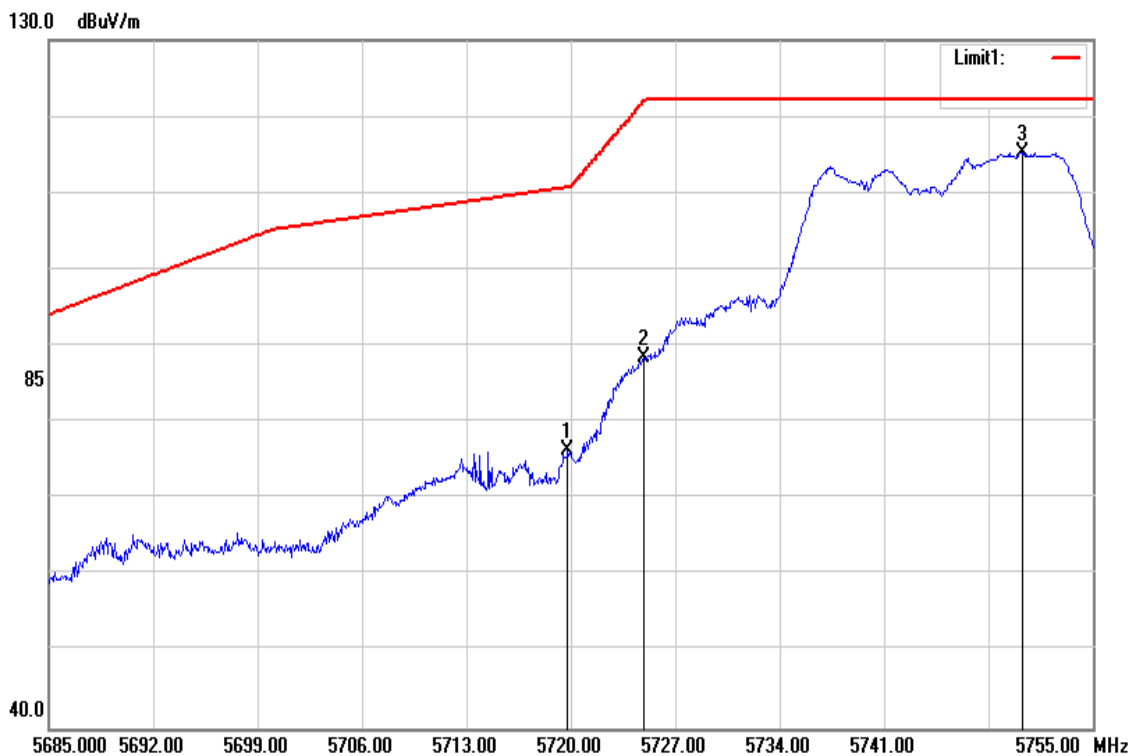

Frequency (MHz)	Reading (dBuV)	Correct Factor (dB/m)	Result (dBuV/m)	Limit (dBuV/m)	Margin (dB)	Remark
5719.790	70.08	6.19	76.27	110.74	-34.47	peak
5724.900	82.24	6.21	88.45	121.97	-33.52	peak
5750.240	109.05	6.32	115.37	-	-	peak

Test Mode	IEEE 802.11n HT20 Low CH	Temperature	27(°C) / 53%RH
Test Item	Band Edge	Test Date	Nov 08, 2016
Polarize	Vertical	Test Engineer	Dennis Li
Detector	Average	Test Voltage	120Vac / 60Hz

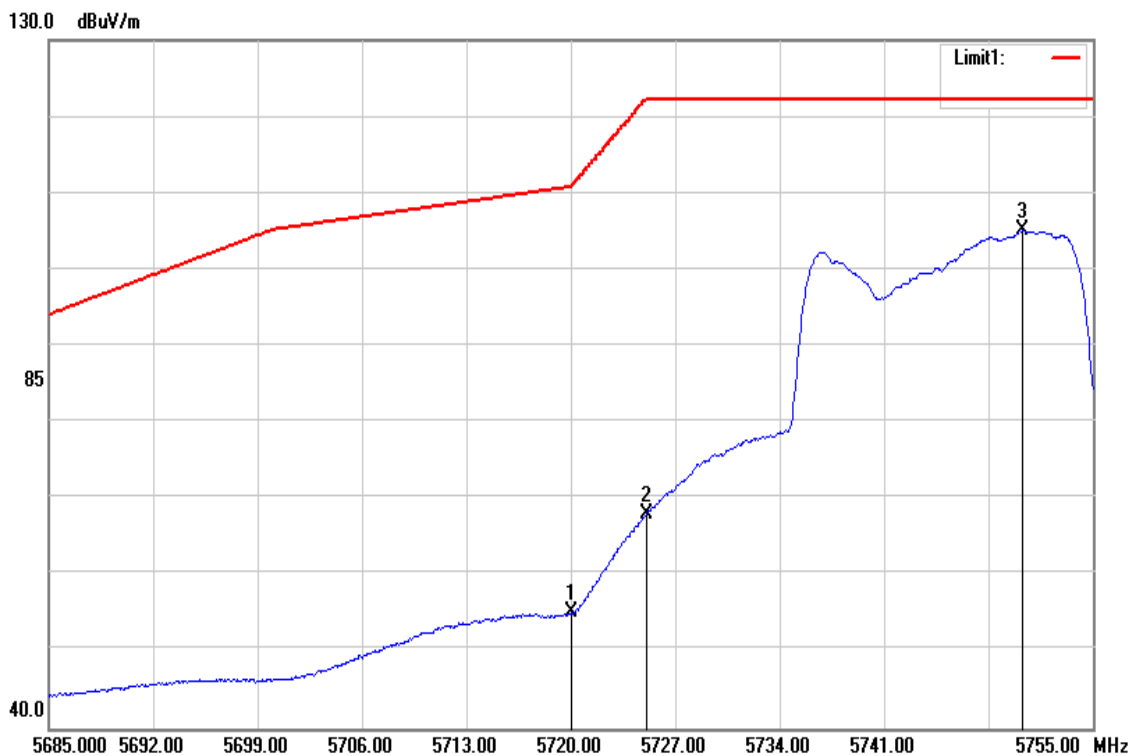

Frequency (MHz)	Reading (dBuV)	Correct Factor (dB/m)	Result (dBuV/m)	Limit (dBuV/m)	Margin (dB)	Remark
5720.000	48.90	6.19	55.09	110.80	-55.71	AVG
5725.110	61.91	6.21	68.12	122.20	-54.08	AVG
5750.310	98.75	6.32	105.07	-	-	AVG

Test Mode	IEEE 802.11n HT20 High CH	Temp/Hum	27(°C)/ 53%RH
Test Item	Band Edge	Test Date	Nov 08, 2016
Polarize	Vertical	Test Engineer	Dennis Li
Detector	Peak	Test Voltage	120Vac / 60Hz

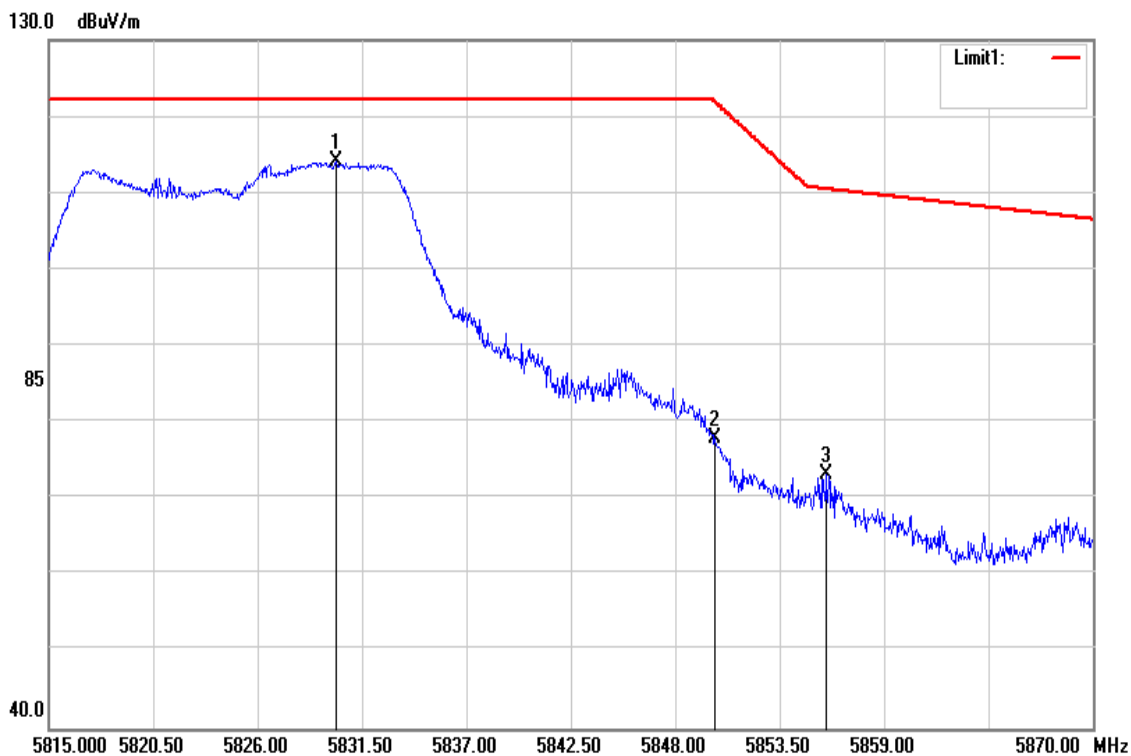

Frequency (MHz)	Reading (dBuV)	Correct Factor (dB/m)	Result (dBuV/m)	Limit (dBuV/m)	Margin (dB)	Remark
5830.125	107.43	6.66	114.09	-	-	peak
5850.090	71.28	6.74	78.02	121.99	-43.97	peak
5855.975	66.37	6.77	73.14	110.53	-37.39	peak

Test Mode	IEEE 802.11n HT20 High CH	Temperature	27(°C) / 53%RH
Test Item	Band Edge	Test Date	Nov 08, 2016
Polarize	Vertical	Test Engineer	Dennis Li
Detector	Average	Test Voltage	120Vac / 60Hz

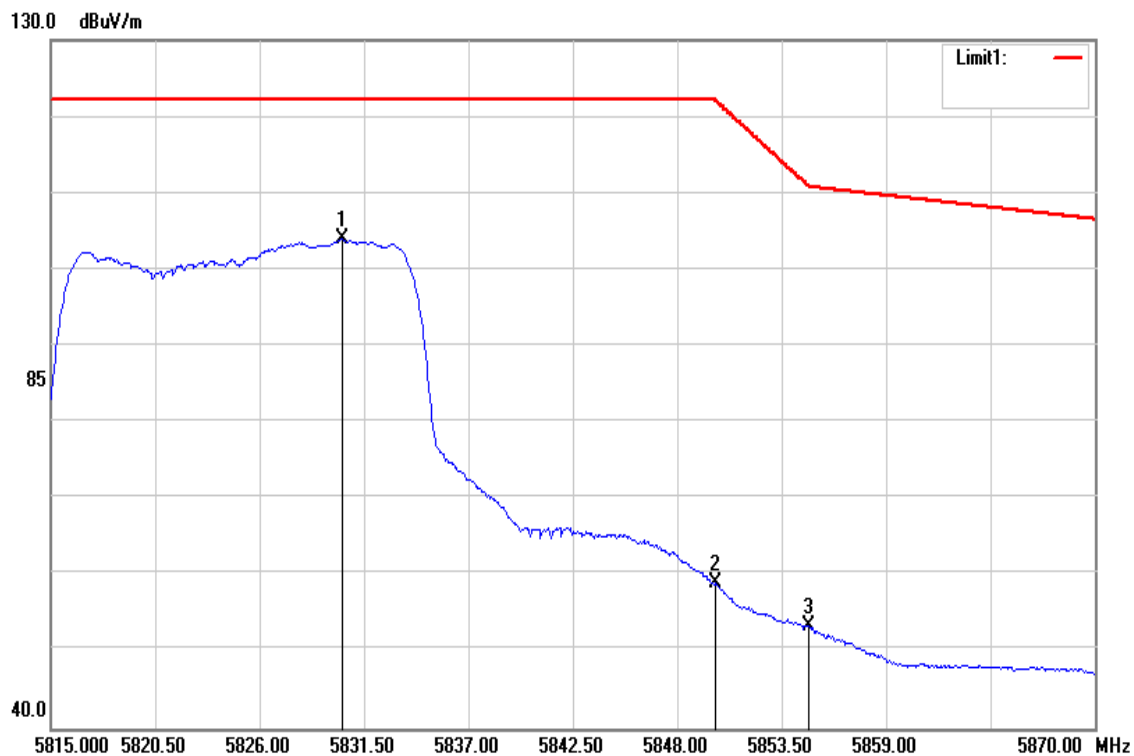

Frequency (MHz)	Reading (dBuV)	Correct Factor (dB/m)	Result (dBuV/m)	Limit (dBuV/m)	Margin (dB)	Remark
5830.345	97.25	6.66	103.91	-	-	AVG
5850.035	52.19	6.74	58.93	122.12	-63.19	AVG
5854.930	46.58	6.76	53.34	110.96	-57.62	AVG

Test Mode	IEEE 802.11n HT40 Low CH	Temp/Hum	27(°C) / 53%RH
Test Item	Band Edge	Test Date	Nov 08, 2016
Polarize	Vertical	Test Engineer	Dennis Li
Detector	Peak	Test Voltage	120Vac / 60Hz

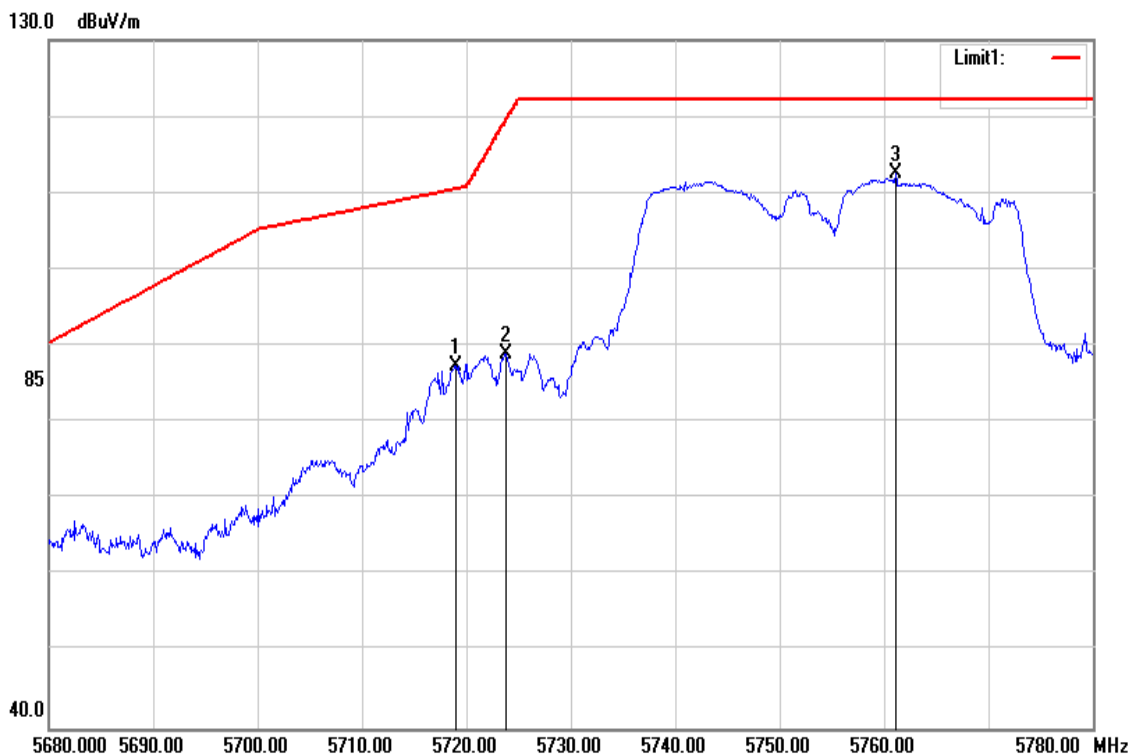

Frequency (MHz)	Reading (dBuV)	Correct Factor (dB/m)	Result (dBuV/m)	Limit (dBuV/m)	Margin (dB)	Remark
5719.000	81.21	6.18	87.39	110.52	-23.13	peak
5723.800	82.75	6.20	88.95	119.46	-30.51	peak
5761.100	106.25	6.36	112.61	-	-	peak

Test Mode	IEEE 802.11n HT40 Low CH	Temperature	27(°C) / 53%RH
Test Item	Band Edge	Test Date	Nov 08, 2016
Polarize	Vertical	Test Engineer	Dennis Li
Detector	Average	Test Voltage	120Vac / 60Hz

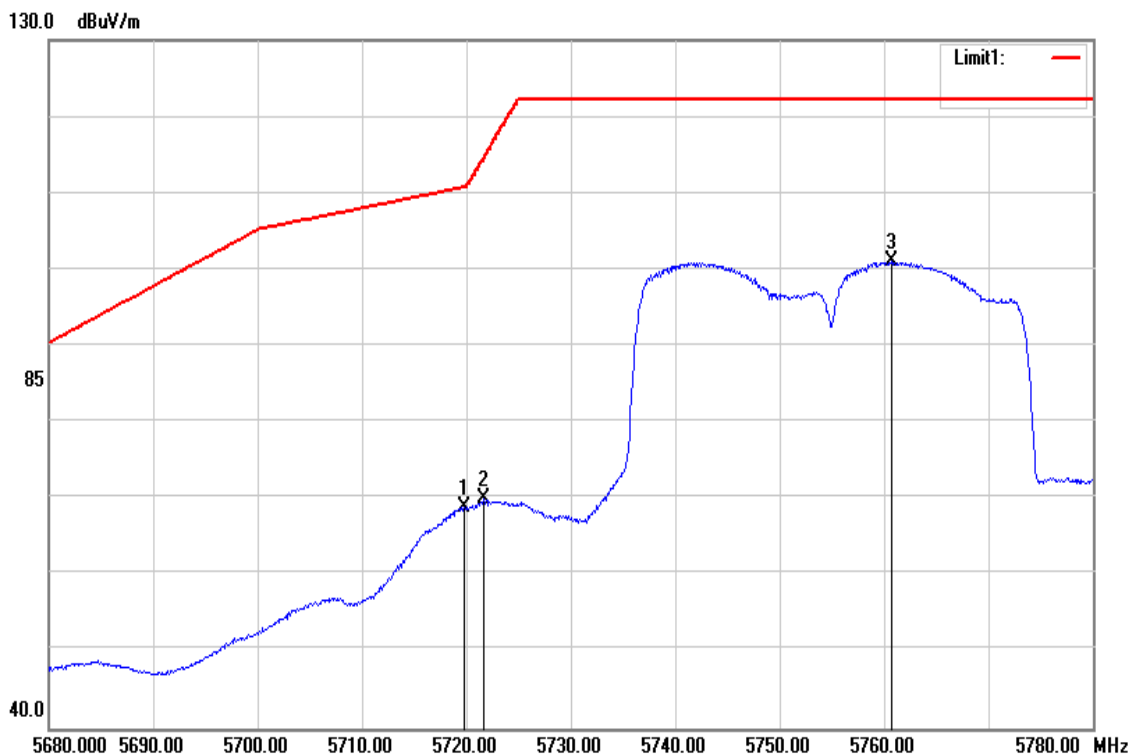

Frequency (MHz)	Reading (dBuV)	Correct Factor (dB/m)	Result (dBuV/m)	Limit (dBuV/m)	Margin (dB)	Remark
5719.800	62.69	6.19	68.88	110.74	-41.86	AVG
5721.700	63.86	6.19	70.05	114.68	-44.63	AVG
5760.700	94.67	6.36	101.03	-	-	AVG

Test Mode	IEEE 802.11n HT40 High CH	Temp/Hum	27(°C)/ 53%RH
Test Item	Band Edge	Test Date	Nov 08, 2016
Polarize	Vertical	Test Engineer	Dennis Li
Detector	Peak	Test Voltage	120Vac / 60Hz

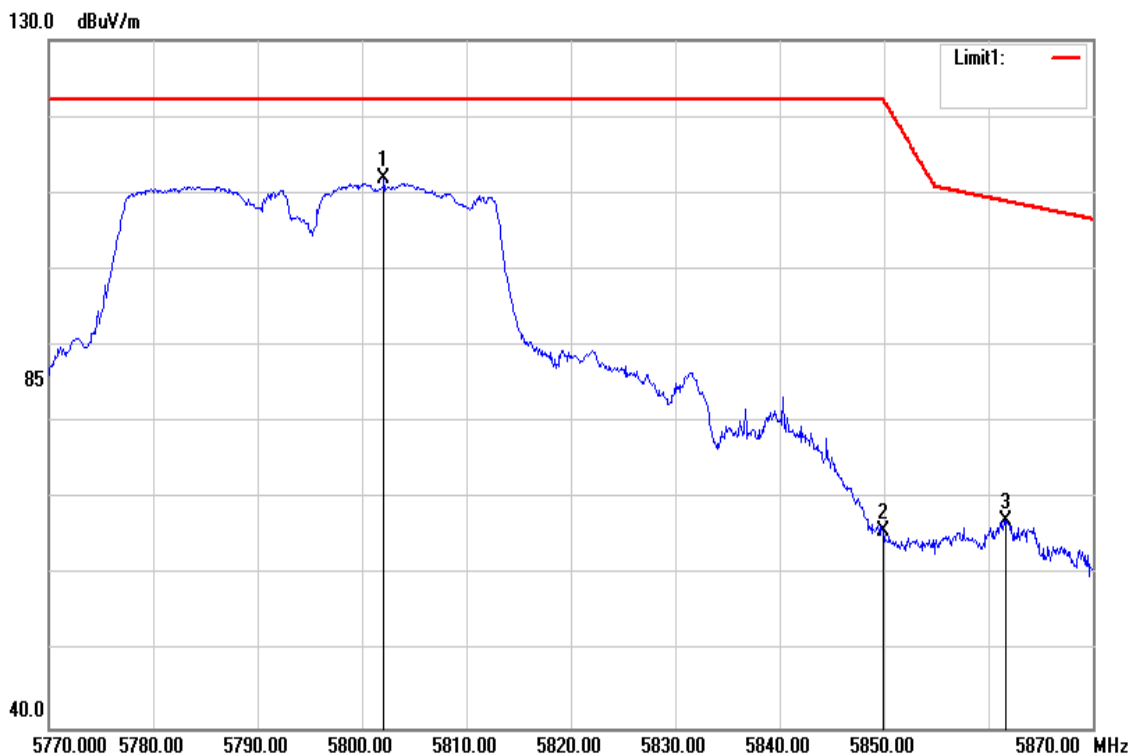

Frequency (MHz)	Reading (dBuV)	Correct Factor (dB/m)	Result (dBuV/m)	Limit (dBuV/m)	Margin (dB)	Remark
5802.100	105.43	6.54	111.97	-	-	peak
5849.900	59.13	6.74	65.87	122.20	-56.33	peak
5861.700	60.43	6.79	67.22	108.92	-41.70	peak

Test Mode	IEEE 802.11n HT40 High CH	Temperature	27(°C) / 53%RH
Test Item	Band Edge	Test Date	Nov 08, 2016
Polarize	Vertical	Test Engineer	Dennis Li
Detector	Average	Test Voltage	120Vac / 60Hz

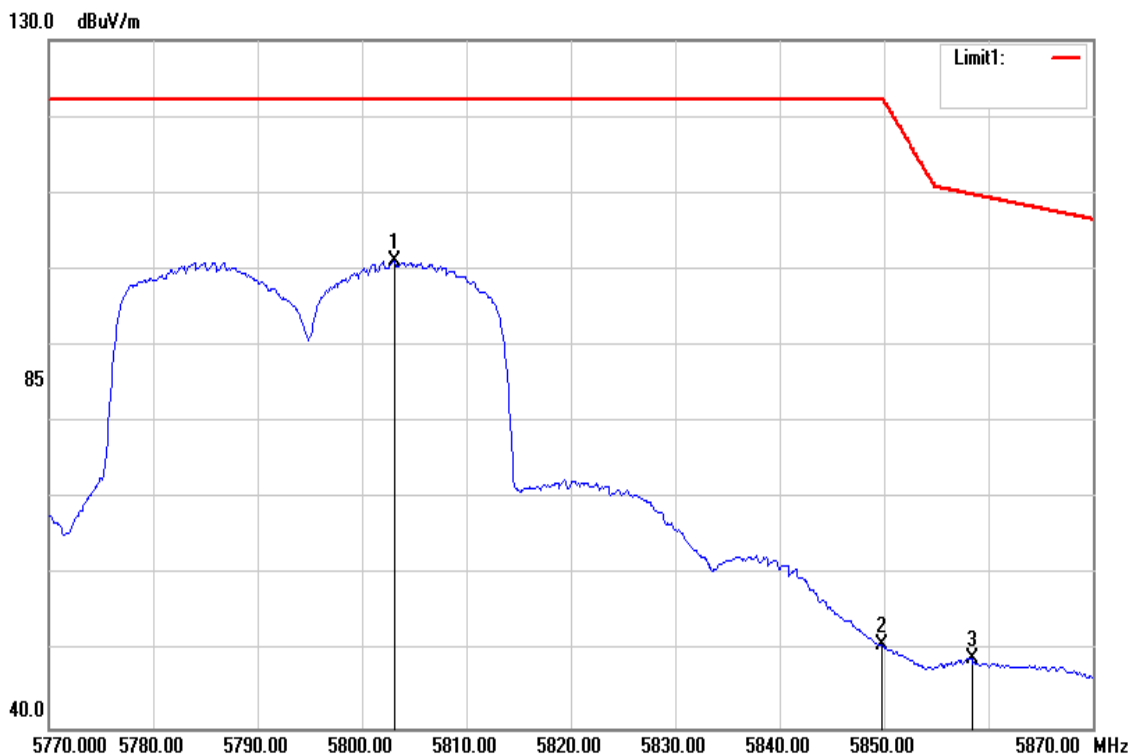

Frequency (MHz)	Reading (dBuV)	Correct Factor (dB/m)	Result (dBuV/m)	Limit (dBuV/m)	Margin (dB)	Remark
5803.100	94.57	6.54	101.11	-	-	AVG
5849.800	44.07	6.74	50.81	122.20	-71.39	AVG
5858.400	42.35	6.78	49.13	109.85	-60.72	AVG

Test Mode	IEEE 802.11ac VHT80 Mid CH	Temp/Hum	27(°C) / 53%RH
Test Item	Band Edge	Test Date	Nov 08, 2016
Polarize	Vertical	Test Engineer	Dennis Li
Detector	Peak	Test Voltage	120Vac / 60Hz

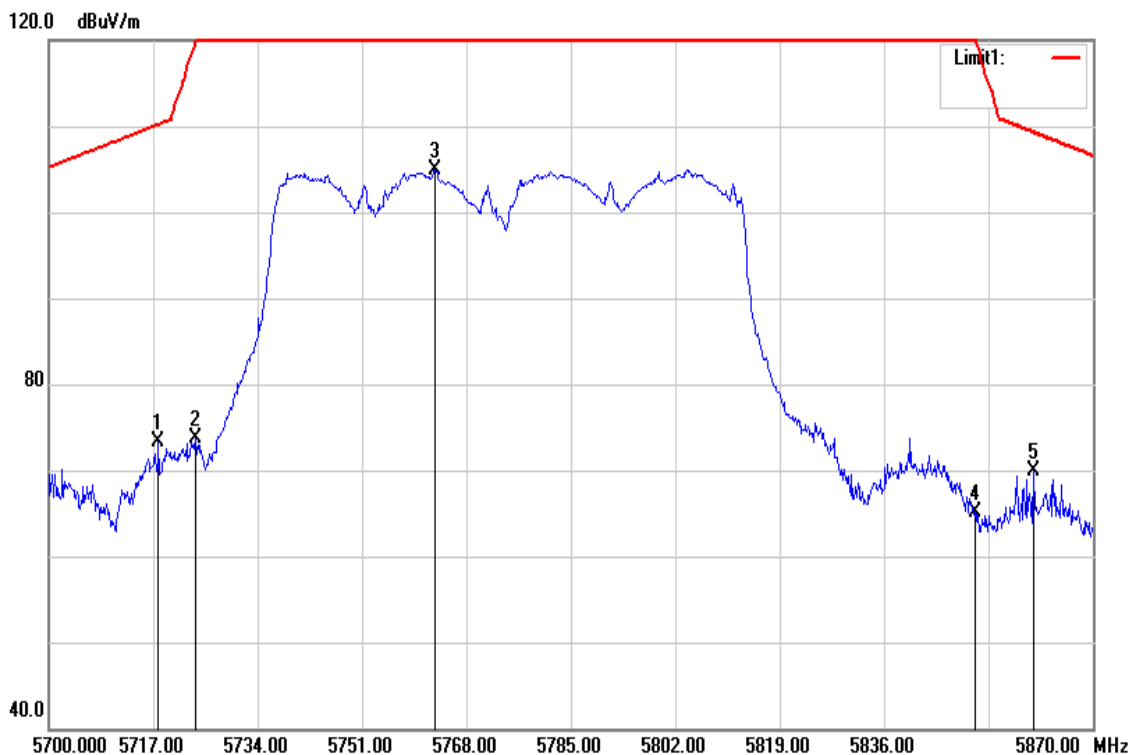

Frequency (MHz)	Reading (dBuV)	Correct Factor (dB/m)	Result (dBuV/m)	Limit (dBuV/m)	Margin (dB)	Remark
5717.850	67.04	6.18	73.22	110.20	-36.98	peak
5723.970	67.55	6.20	73.75	119.85	-46.10	peak
5762.900	98.54	6.37	104.91	-	-	peak
5850.790	58.36	6.74	65.10	120.40	-55.30	peak
5860.310	63.05	6.78	69.83	109.31	-39.48	peak

Test Mode	IEEE 802.11ac VHT80 Mid CH	Temperature	27(°C) / 53%RH
Test Item	Band Edge	Test Date	Nov 08, 2016
Polarize	Vertical	Test Engineer	Dennis Li
Detector	Average	Test Voltage	120Vac / 60Hz

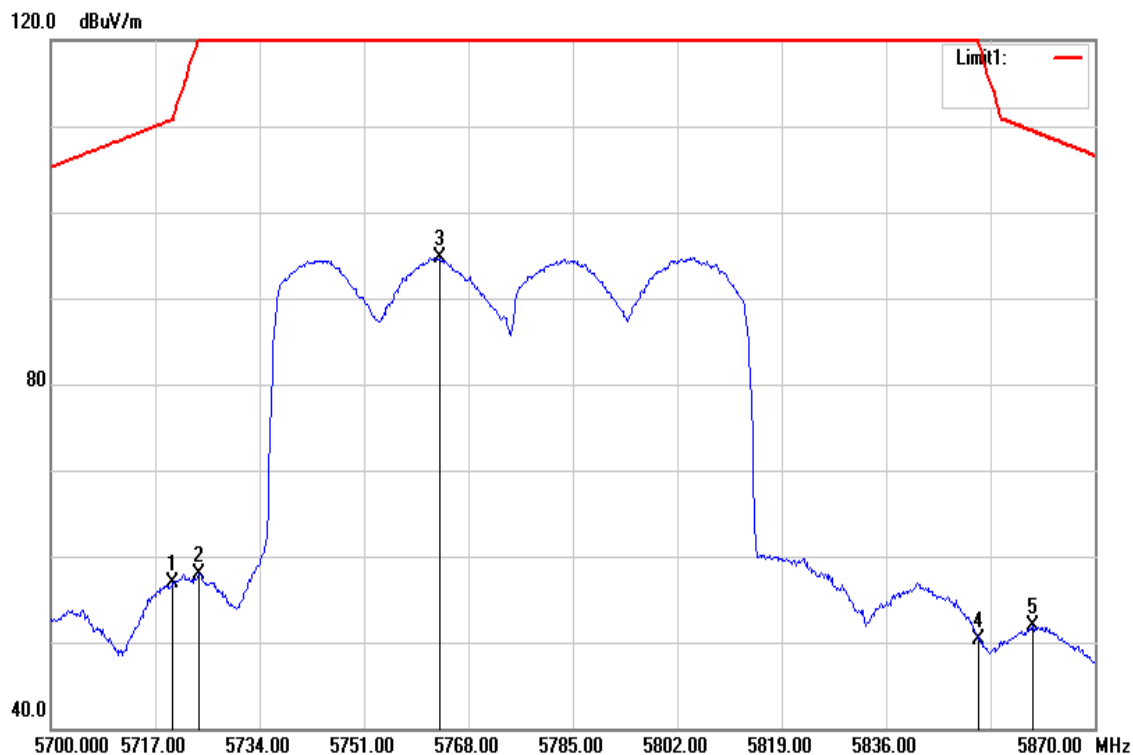

Frequency (MHz)	Reading (dBuV)	Correct Factor (dB/m)	Result (dBuV/m)	Limit (dBuV/m)	Margin (dB)	Remark
5719.890	50.65	6.19	56.84	110.77	-53.93	AVG
5724.140	51.74	6.20	57.94	120.24	-62.30	AVG
5763.240	88.37	6.37	94.74	-	-	AVG
5851.130	43.63	6.75	50.38	119.62	-69.24	AVG
5859.800	45.19	6.78	51.97	109.46	-57.49	AVG

Below 1G Test Data

Test Mode	Mode 1	Temp/Hum	27(°C)/ 53%RH
Test Item	30MHz-1GHz	Test Date	Nov 17, 2016
Polarize	Vertical	Test Engineer	Dennis Li
Detector	Peak and Qusi-peak	Test Voltage	120Vac / 60Hz

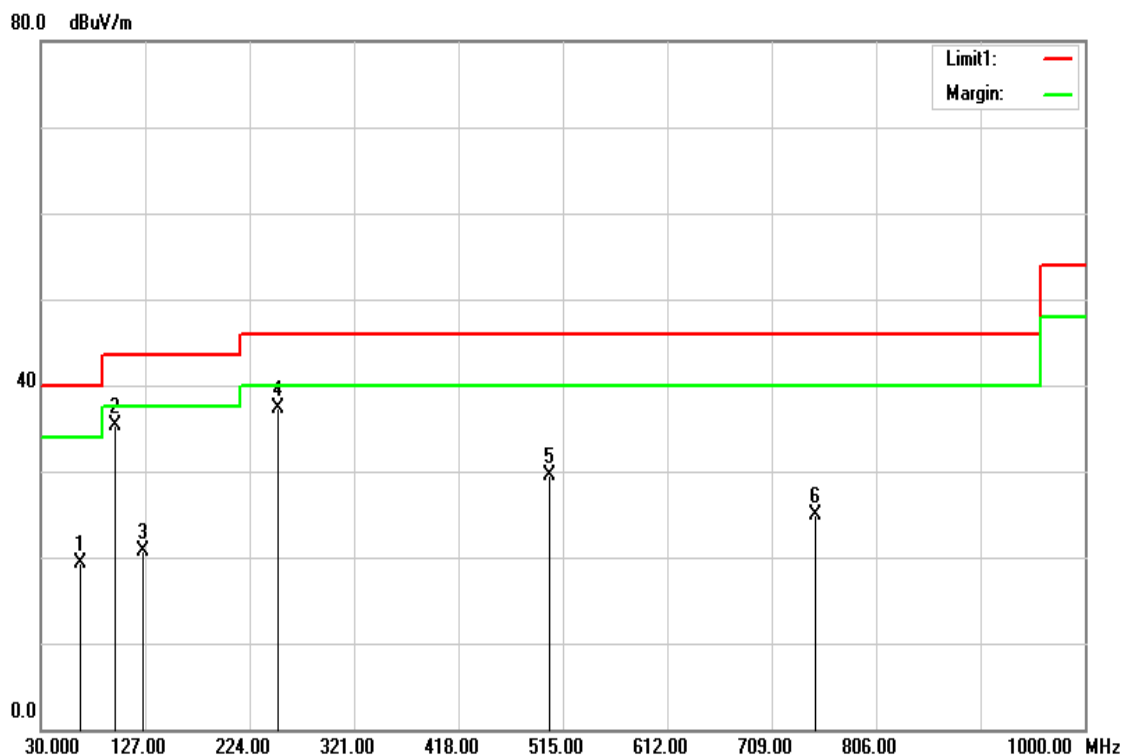

Frequency (MHz)	Reading (dBuV)	Correct Factor (dB/m)	Result (dBuV/m)	Limit (dBuV/m)	Margin (dB)	Remark
66.8600	40.52	-21.16	19.36	40.00	-20.64	QP
98.8700	54.55	-19.31	35.24	43.50	-8.26	peak
125.0600	36.31	-15.57	20.74	43.50	-22.76	QP
250.1900	53.51	-16.27	37.24	46.00	-8.76	peak
502.3900	38.79	-9.20	29.59	46.00	-16.41	peak
749.7400	29.81	-4.93	24.88	46.00	-21.12	peak

Test Mode	Mode 1	Temp/Hum	27(°C)/ 53%RH
Test Item	30MHz-1GHz	Test Date	Nov 17, 2016
Polarize	Vertical	Test Engineer	Dennis Li
Detector	Peak and Qusi-peak	Test Voltage	120Vac / 60Hz

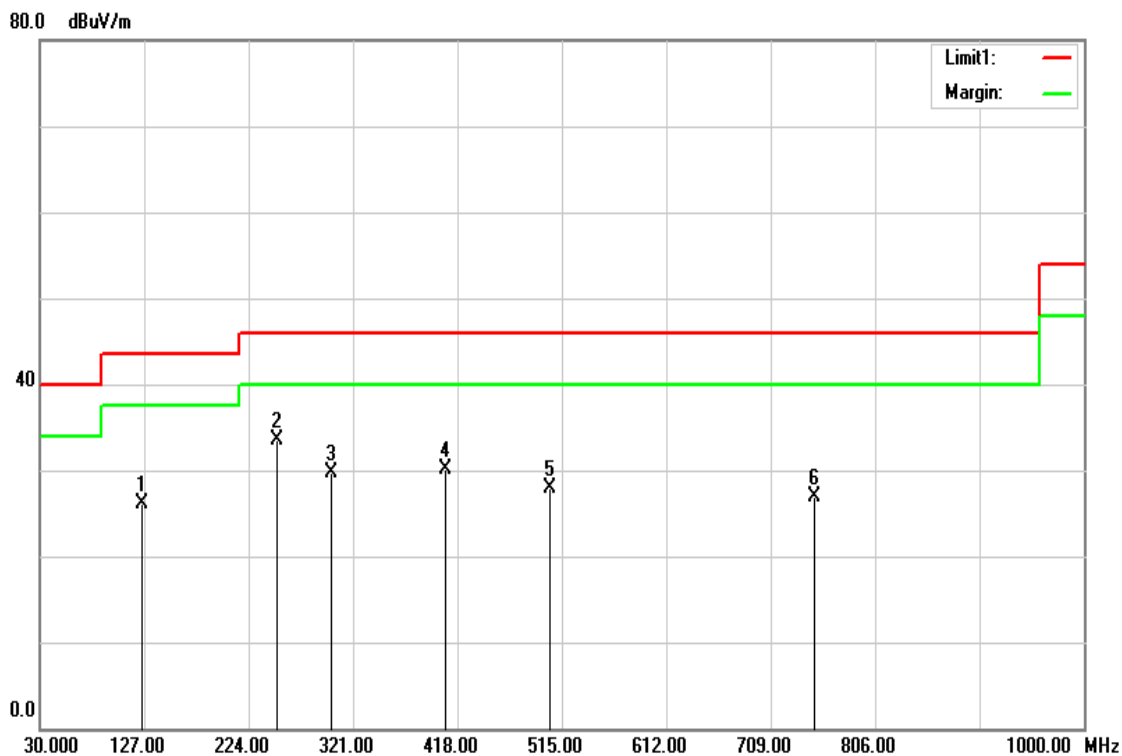

Frequency (MHz)	Reading (dBuV)	Correct Factor (dB/m)	Result (dBuV/m)	Limit (dBuV/m)	Margin (dB)	Remark
125.0600	41.68	-15.57	26.11	43.50	-17.39	peak
250.1900	49.70	-16.27	33.43	46.00	-12.57	peak
300.6300	43.86	-14.22	29.64	46.00	-16.36	peak
407.3300	41.52	-11.48	30.04	46.00	-15.96	peak
503.3600	37.15	-9.19	27.96	46.00	-18.04	peak
749.7400	31.82	-4.93	26.89	46.00	-19.11	peak

Test Mode	Mode 2	Temp/Hum	27(°C) / 53%RH
Test Item	30MHz-1GHz	Test Date	Nov 17, 2016
Polarize	Vertical	Test Engineer	Dennis Li
Detector	Peak and Qusi-peak	Test Voltage	120Vac / 60Hz

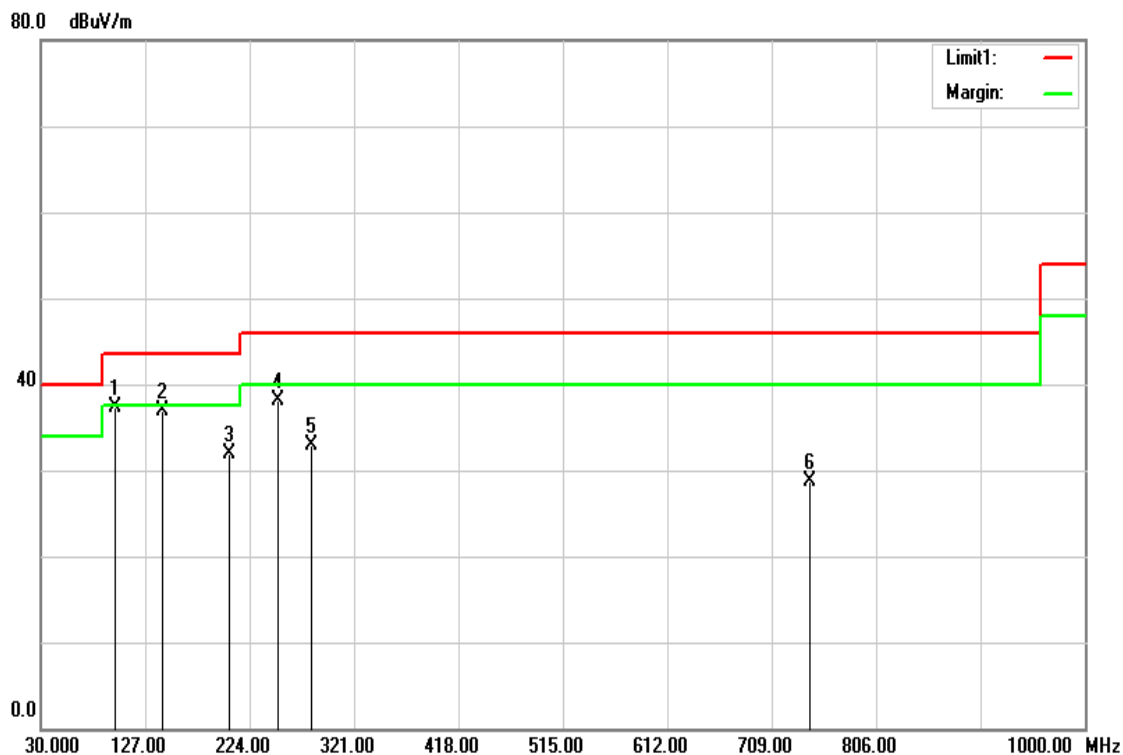

Frequency (MHz)	Reading (dBuV)	Correct Factor (dB/m)	Result (dBuV/m)	Limit (dBuV/m)	Margin (dB)	Remark
98.8700	56.65	-19.31	37.34	43.50	-6.16	peak
143.4900	52.86	-15.88	36.98	43.50	-6.52	peak
204.6000	47.87	-15.87	32.00	43.50	-11.50	peak
250.1900	54.35	-16.27	38.08	46.00	-7.92	peak
281.2300	47.55	-14.59	32.96	46.00	-13.04	peak
743.9200	33.70	-5.06	28.64	46.00	-17.36	peak

Test Mode	Mode 2	Temp/Hum	27(°C)/ 53%RH
Test Item	30MHz-1GHz	Test Date	Nov 17, 2016
Polarize	Vertical	Test Engineer	Dennis Li
Detector	Peak and Qusi-peak	Test Voltage	120Vac / 60Hz

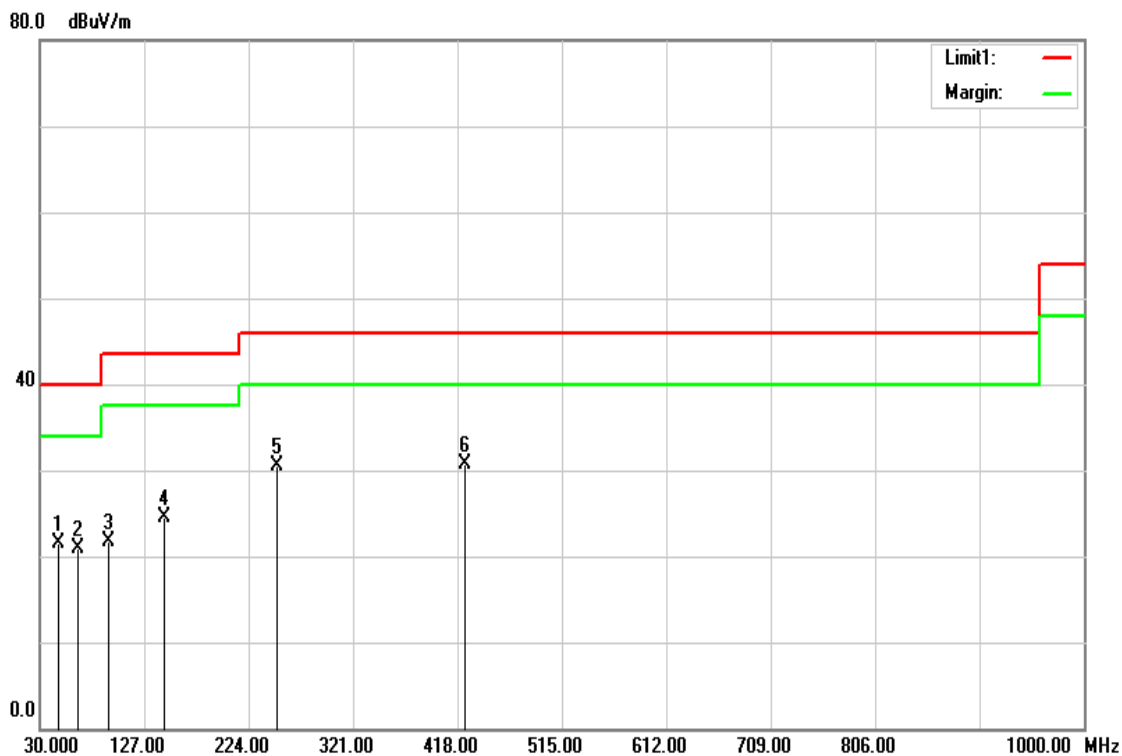

Frequency (MHz)	Reading (dBuV)	Correct Factor (dB/m)	Result (dBuV/m)	Limit (dBuV/m)	Margin (dB)	Remark
47.4600	41.18	-19.61	21.57	40.00	-18.43	QP
64.9200	42.30	-21.43	20.87	40.00	-19.13	QP
94.0200	42.19	-20.51	21.68	43.50	-21.82	QP
145.4300	40.46	-15.94	24.52	43.50	-18.98	QP
250.1900	46.77	-16.27	30.50	46.00	-15.50	peak
424.7900	41.67	-10.95	30.72	46.00	-15.28	peak

Above 1G Test Data for UNII-1

Test Mode	IEEE 802.11a Low CH	Temp/Hum	27(°C)/ 53%RH
Test Item	Harmonic	Test Date	Nov 17, 2016
Polarize	Vertical	Test Engineer	Dennis Li
Detector	Peak and Average	Test Voltage	120Vac / 60Hz

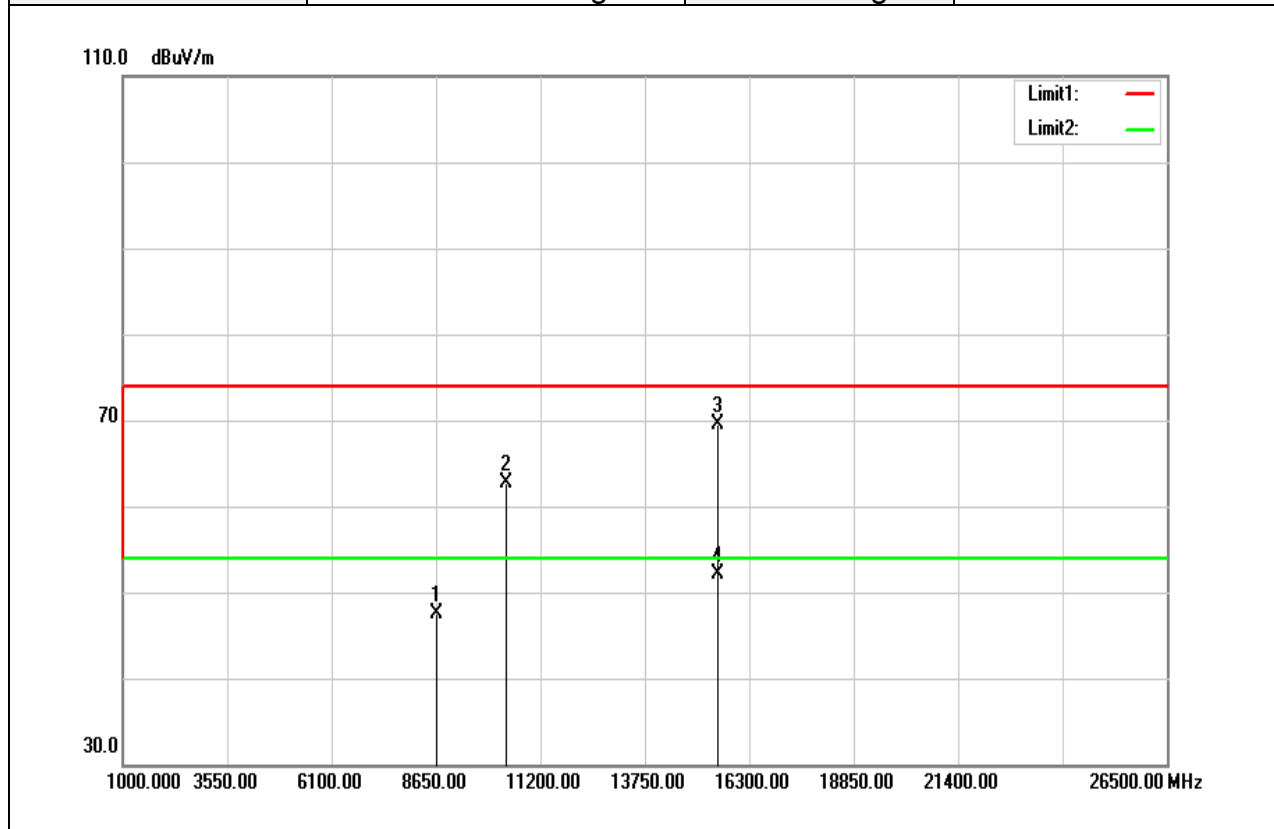

Frequency (MHz)	Reading (dBuV)	Correct Factor (dB/m)	Result (dBuV/m)	Limit (dBuV/m)	Margin (dB)	Remark
8655.000	32.14	15.37	47.51	74.00	-26.49	peak
10360.000	45.06	17.58	62.64	74.00	-11.36	peak
15550.000	48.79	20.64	69.43	74.00	-4.57	peak
15550.000	31.44	20.64	52.08	54.00	-1.92	AVG

Remark:

1. Measuring frequencies from 1 GHz to the 10th harmonic of highest fundamental frequency.
2. For above 1GHz, the EUT peak value was under average limit, therefore the Average value compliance with the average limit

Test Mode	IEEE 802.11a Low CH	Temp/Hum	27(°C) / 53%RH
Test Item	Harmonic	Test Date	Nov 08, 2016
Polarize	Horizontal	Test Engineer	Dennis Li
Detector	Peak and Average	Test Voltage	120Vac / 60Hz

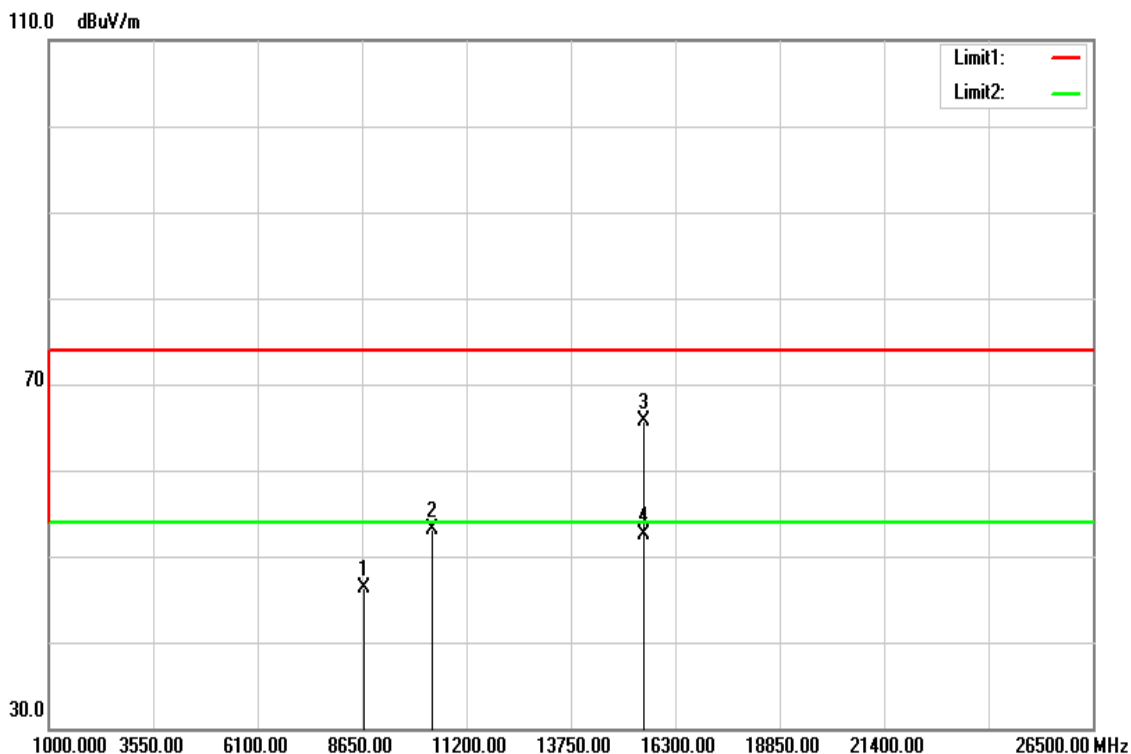

Frequency (MHz)	Reading (dBuV)	Correct Factor (dB/m)	Result (dBuV/m)	Limit (dBuV/m)	Margin (dB)	Remark
8698.000	30.87	15.45	46.32	74.00	-27.68	peak
10360.000	35.50	17.58	53.08	74.00	-20.92	peak
15550.000	45.02	20.64	65.66	74.00	-8.34	peak
15550.000	31.83	20.64	52.47	54.00	-1.53	AVG

Remark:

1. Measuring frequencies from 1 GHz to the 10th harmonic of highest fundamental frequency.
2. For above 1GHz, the EUT peak value was under average limit, therefore the Average value compliance with the average limit

Test Mode	IEEE 802.11a Mid CH	Temp/Hum	27(°C) / 53%RH
Test Item	Harmonic	Test Date	Nov 08, 2016
Polarize	Vertical	Test Engineer	Dennis Li
Detector	Peak and Average	Test Voltage	120Vac / 60Hz

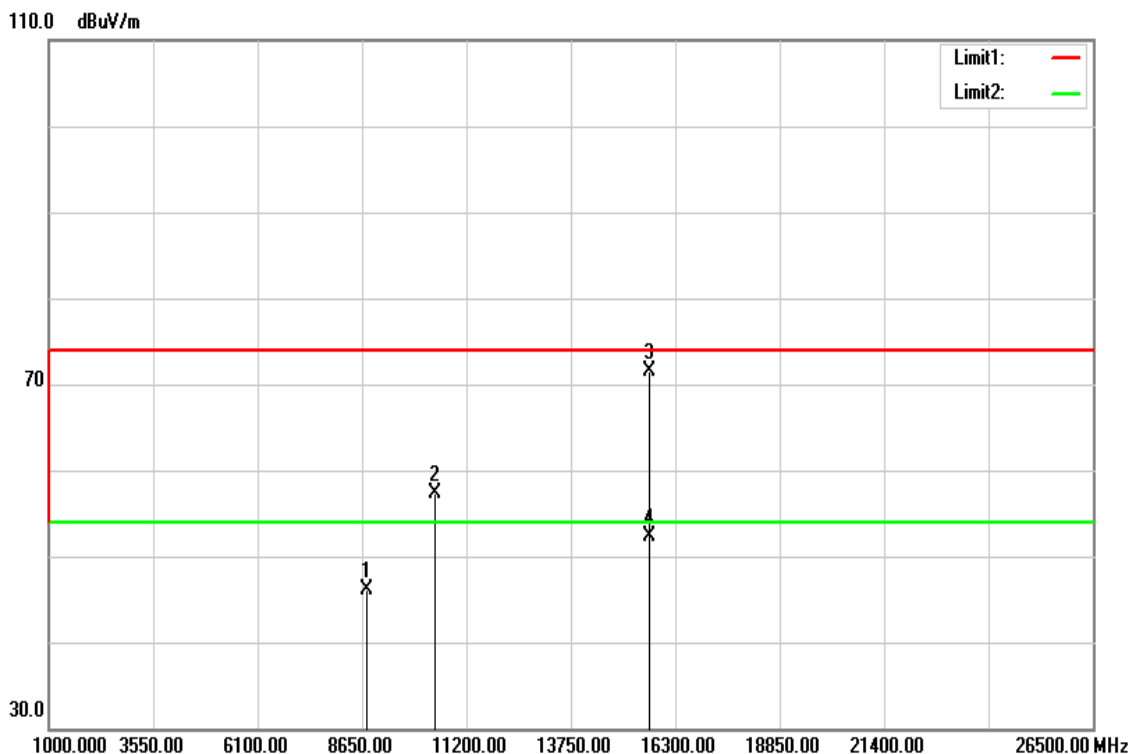

Frequency (MHz)	Reading (dBuV)	Correct Factor (dB/m)	Result (dBuV/m)	Limit (dBuV/m)	Margin (dB)	Remark
8753.000	30.56	15.56	46.12	74.00	-27.88	peak
10440.000	39.77	17.57	57.34	74.00	-16.66	peak
15670.000	50.36	21.05	71.41	74.00	-2.59	peak
15670.000	31.18	21.05	52.23	54.00	-1.77	AVG

Remark:

1. Measuring frequencies from 1 GHz to the 10th harmonic of highest fundamental frequency.
2. For above 1GHz, the EUT peak value was under average limit, therefore the Average value compliance with the average limit

Test Mode	IEEE 802.11a Mid CH	Temp/Hum	27(°C)/ 53%RH
Test Item	Harmonic	Test Date	Nov 08, 2016
Polarize	Horizontal	Test Engineer	Dennis Li
Detector	Peak and Average	Test Voltage	120Vac / 60Hz

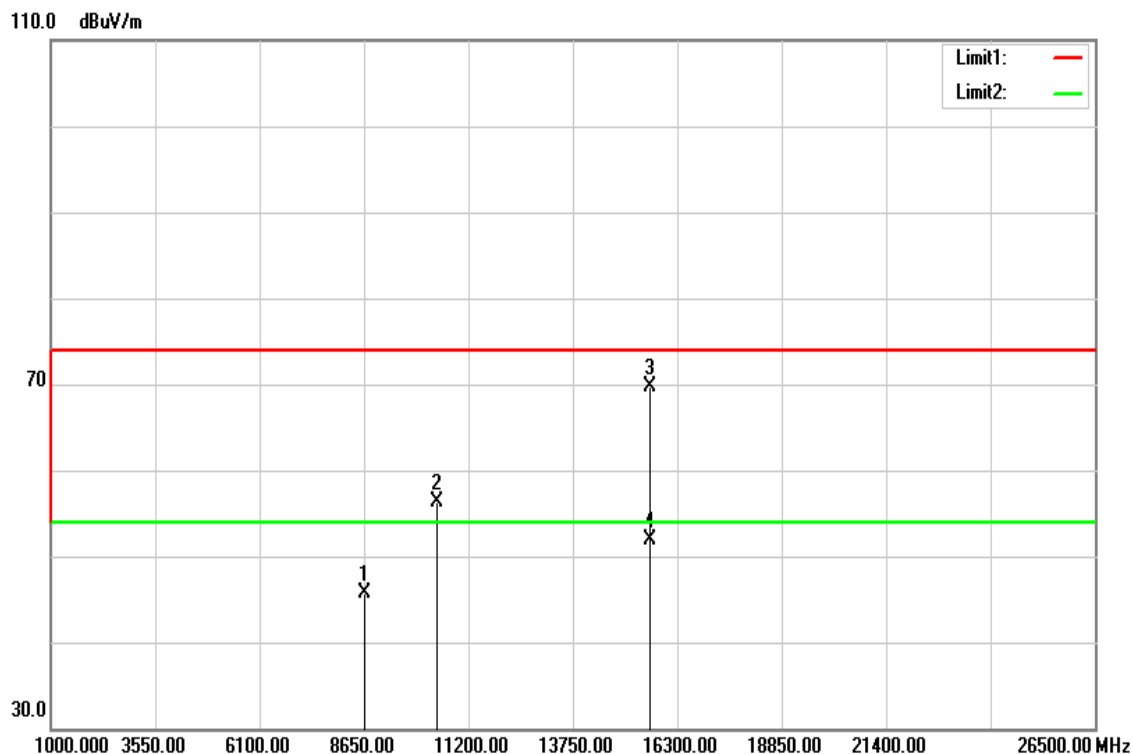

Frequency (MHz)	Reading (dBuV)	Correct Factor (dB/m)	Result (dBuV/m)	Limit (dBuV/m)	Margin (dB)	Remark
8674.000	30.23	15.41	45.64	74.00	-28.36	peak
10440.000	38.76	17.57	56.33	74.00	-17.67	peak
15650.000	48.63	20.98	69.61	74.00	-4.39	peak
15650.000	30.84	20.98	51.82	54.00	-2.18	AVG

Remark:

1. Measuring frequencies from 1 GHz to the 10th harmonic of highest fundamental frequency.
2. For above 1GHz, the EUT peak value was under average limit, therefore the Average value compliance with the average limit

Test Mode	IEEE 802.11a High CH	Temp/Hum	27(°C) / 53%RH
Test Item	Harmonic	Test Date	Nov 08, 2016
Polarize	Vertical	Test Engineer	Dennis Li
Detector	Peak and Average	Test Voltage	120Vac / 60Hz

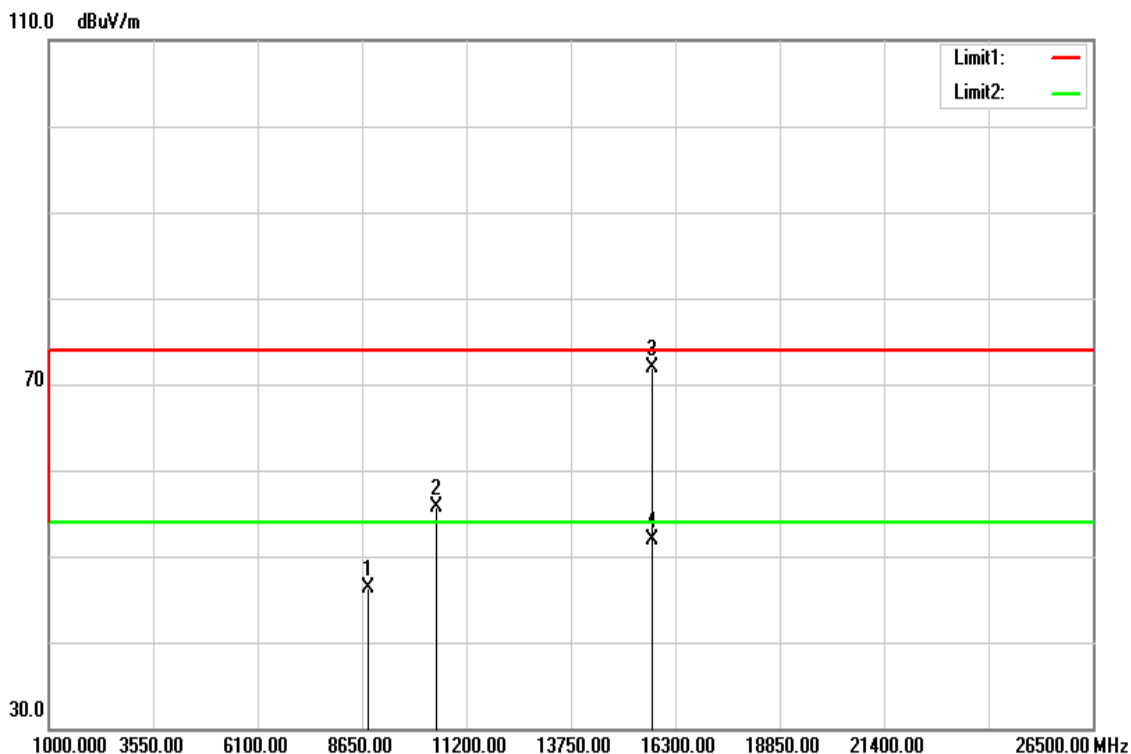

Frequency (MHz)	Reading (dBuV)	Correct Factor (dB/m)	Result (dBuV/m)	Limit (dBuV/m)	Margin (dB)	Remark
8793.000	30.65	15.63	46.28	74.00	-27.72	peak
10480.000	38.13	17.57	55.70	74.00	-18.30	peak
15730.000	50.58	21.26	71.84	74.00	-2.16	peak
15730.000	30.66	21.26	51.92	54.00	-2.08	AVG

Remark:

1. Measuring frequencies from 1 GHz to the 10th harmonic of highest fundamental frequency.
2. For above 1GHz, the EUT peak value was under average limit, therefore the Average value compliance with the average limit

Test Mode	IEEE 802.11a High CH	Temp/Hum	27(°C)/ 53%RH
Test Item	Harmonic	Test Date	Nov 08, 2016
Polarize	Horizontal	Test Engineer	Dennis Li
Detector	Peak and Average	Test Voltage	120Vac / 60Hz

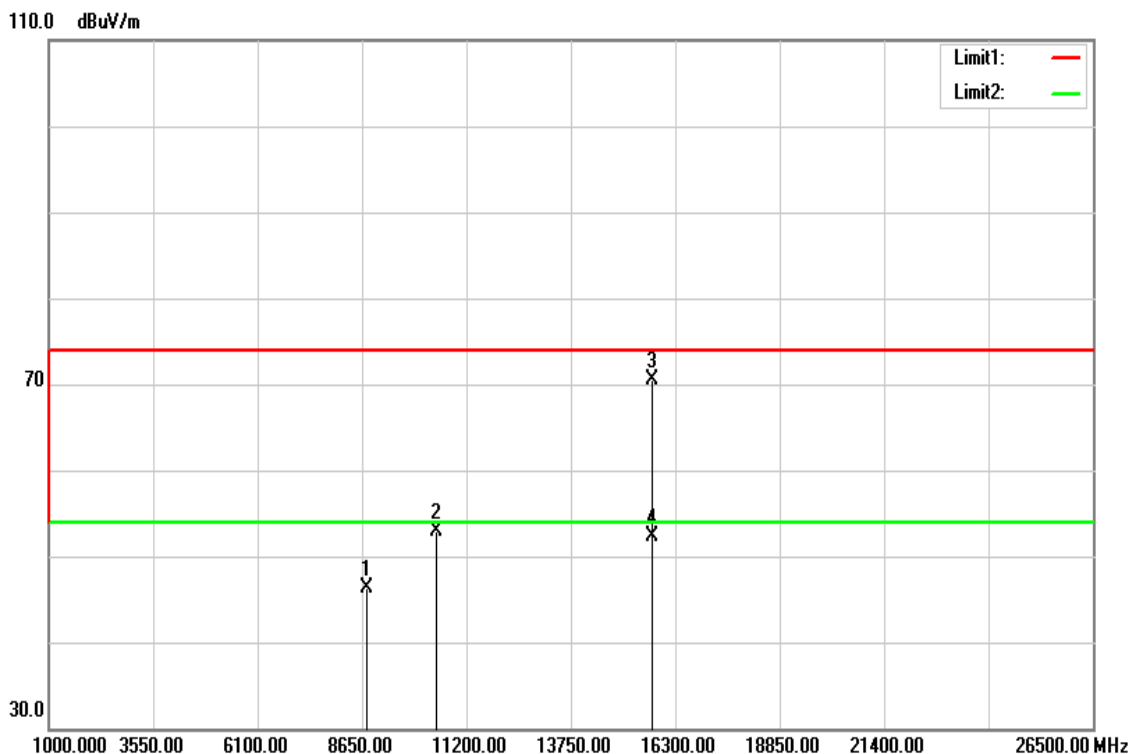

Frequency (MHz)	Reading (dBuV)	Correct Factor (dB/m)	Result (dBuV/m)	Limit (dBuV/m)	Margin (dB)	Remark
8756.000	30.80	15.56	46.36	74.00	-27.64	peak
10480.000	35.39	17.57	52.96	74.00	-21.04	peak
15730.000	49.22	21.26	70.48	74.00	-3.52	peak
15730.000	31.07	21.26	52.33	54.00	-1.67	AVG

Remark:

1. Measuring frequencies from 1 GHz to the 10th harmonic of highest fundamental frequency.
2. For above 1GHz, the EUT peak value was under average limit, therefore the Average value compliance with the average limit

Test Mode	IEEE 802.11n HT20 Low CH	Temp/Hum	27(°C)/ 53%RH
Test Item	Harmonic	Test Date	Nov 08, 2016
Polarize	Vertical	Test Engineer	Dennis Li
Detector	Peak and Average	Test Voltage	120Vac / 60Hz

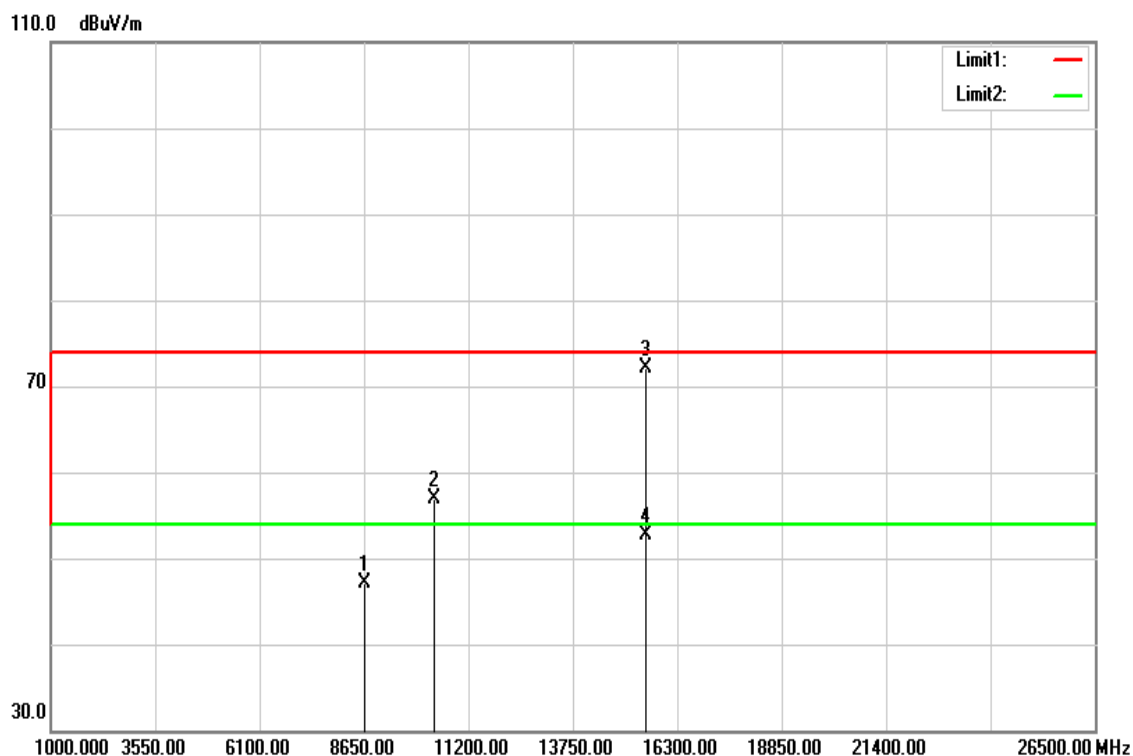

Frequency (MHz)	Reading (dBuV)	Correct Factor (dB/m)	Result (dBuV/m)	Limit (dBuV/m)	Margin (dB)	Remark
8658.000	31.76	15.38	47.14	74.00	-26.86	peak
10360.000	39.30	17.58	56.88	74.00	-17.12	peak
15540.000	51.46	20.61	72.07	74.00	-1.93	peak
15540.000	32.14	20.61	52.75	54.00	-1.25	AVG

Remark:

1. Measuring frequencies from 1 GHz to the 10th harmonic of highest fundamental frequency.
2. For above 1GHz, the EUT peak value was under average limit, therefore the Average value compliance with the average limit

Test Mode	IEEE 802.11n HT20 Low CH	Temp/Hum	27(°C) / 53%RH
Test Item	Harmonic	Test Date	Nov 08, 2016
Polarize	Horizontal	Test Engineer	Dennis Li
Detector	Peak and Average	Test Voltage	120Vac / 60Hz

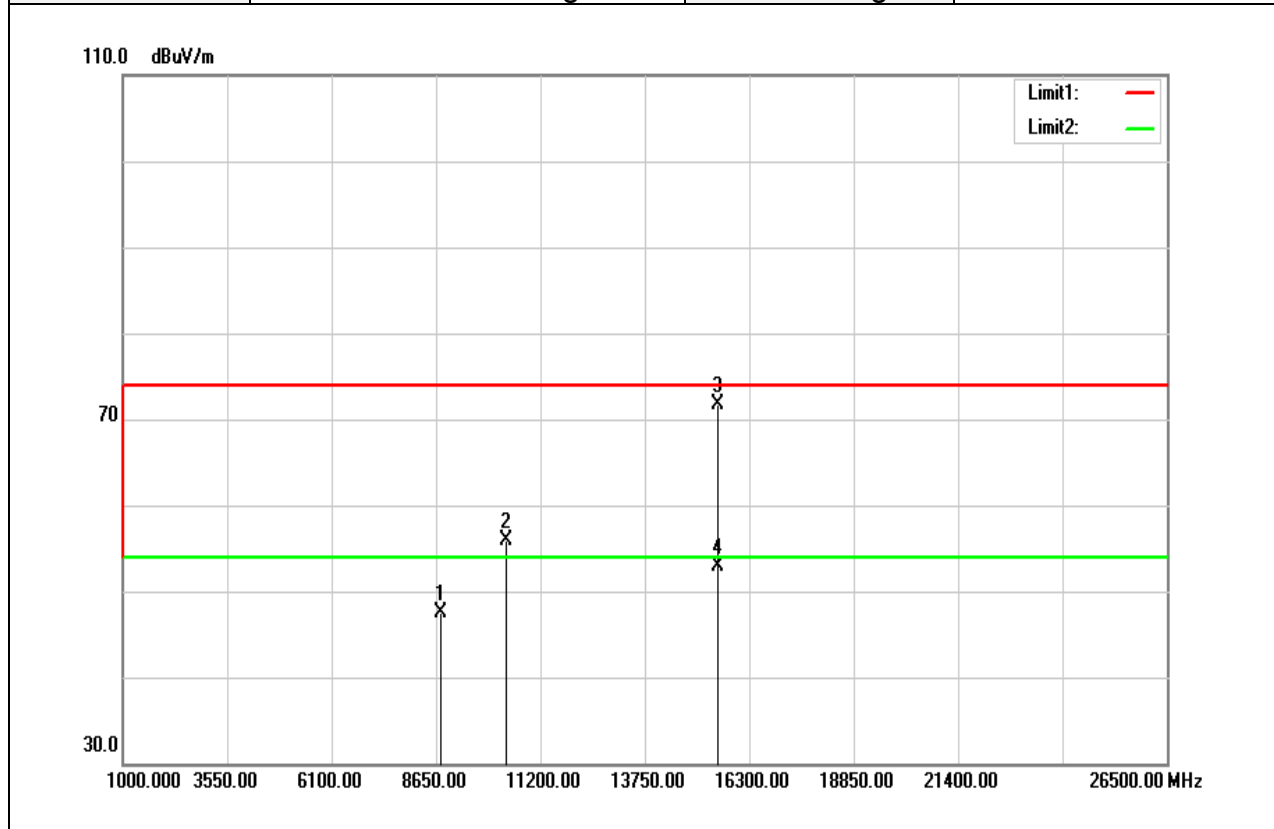

Frequency (MHz)	Reading (dBuV)	Correct Factor (dB/m)	Result (dBuV/m)	Limit (dBuV/m)	Margin (dB)	Remark
8758.000	31.94	15.57	47.51	74.00	-26.49	peak
10360.000	38.28	17.58	55.86	74.00	-18.14	peak
15540.000	51.19	20.61	71.80	74.00	-2.20	peak
15540.000	32.21	20.61	52.82	54.00	-1.18	AVG

Remark:

1. Measuring frequencies from 1 GHz to the 10th harmonic of highest fundamental frequency.
2. For above 1GHz, the EUT peak value was under average limit, therefore the Average value compliance with the average limit

Test Mode	IEEE 802.11n HT20 Mid CH	Temp/Hum	27(°C) / 53%RH
Test Item	Harmonic	Test Date	Nov 08, 2016
Polarize	Vertical	Test Engineer	Dennis Li
Detector	Peak and Average	Test Voltage	120Vac / 60Hz

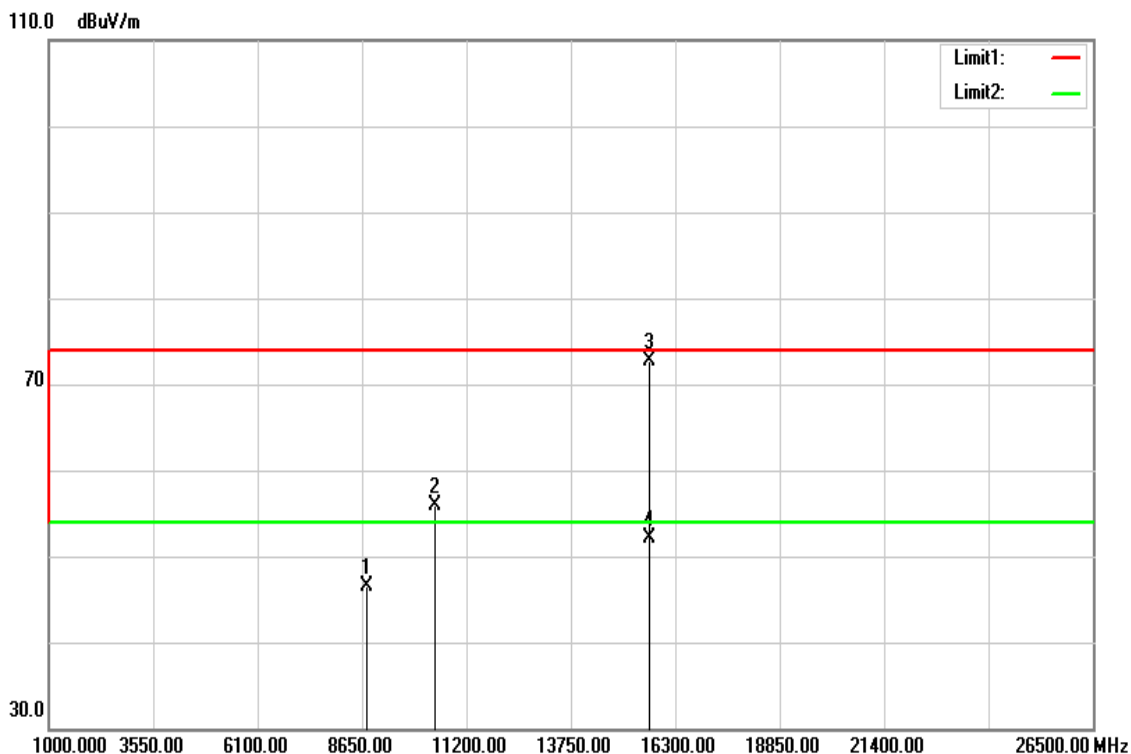

Frequency (MHz)	Reading (dBuV)	Correct Factor (dB/m)	Result (dBuV/m)	Limit (dBuV/m)	Margin (dB)	Remark
8756.000	30.91	15.56	46.47	74.00	-27.53	peak
10450.000	38.24	17.57	55.81	74.00	-18.19	peak
15670.000	51.75	21.05	72.80	74.00	-1.20	peak
15670.000	31.09	21.05	52.14	54.00	-1.86	AVG

Remark:

1. Measuring frequencies from 1 GHz to the 10th harmonic of highest fundamental frequency.
2. For above 1GHz, the EUT peak value was under average limit, therefore the Average value compliance with the average limit

Test Mode	IEEE 802.11n HT20 Mid CH	Temp/Hum	27(°C)/ 53%RH
Test Item	Harmonic	Test Date	Nov 08, 2016
Polarize	Horizontal	Test Engineer	Dennis Li
Detector	Peak and Average	Test Voltage	120Vac / 60Hz

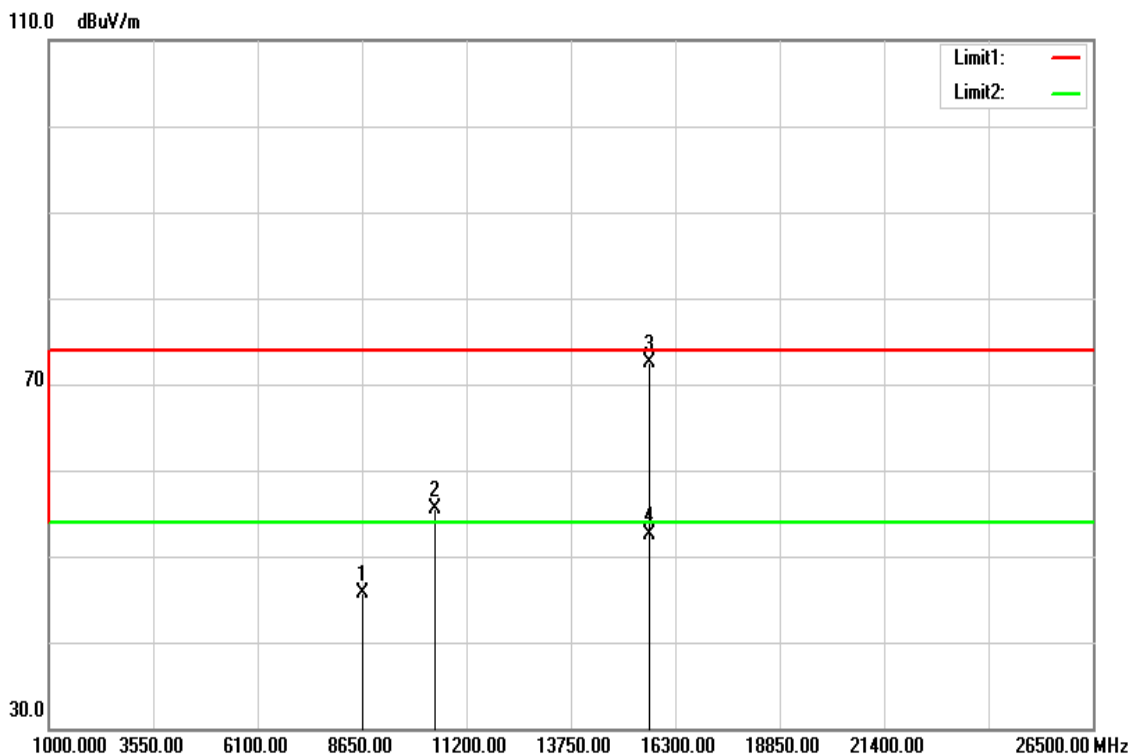

Frequency (MHz)	Reading (dBuV)	Correct Factor (dB/m)	Result (dBuV/m)	Limit (dBuV/m)	Margin (dB)	Remark
8678.000	30.25	15.41	45.66	74.00	-28.34	peak
10440.000	38.03	17.57	55.60	74.00	-18.40	peak
15660.000	51.40	21.02	72.42	74.00	-1.58	peak
15660.000	31.52	21.02	52.54	54.00	-1.46	AVG

Remark:

1. Measuring frequencies from 1 GHz to the 10th harmonic of highest fundamental frequency.
2. For above 1GHz, the EUT peak value was under average limit, therefore the Average value compliance with the average limit

Test Mode	IEEE 802.11n HT20 High CH	Temp/Hum	27(°C)/ 53%RH
Test Item	Harmonic	Test Date	Nov 08, 2016
Polarize	Vertical	Test Engineer	Dennis Li
Detector	Peak and Average	Test Voltage	120Vac / 60Hz

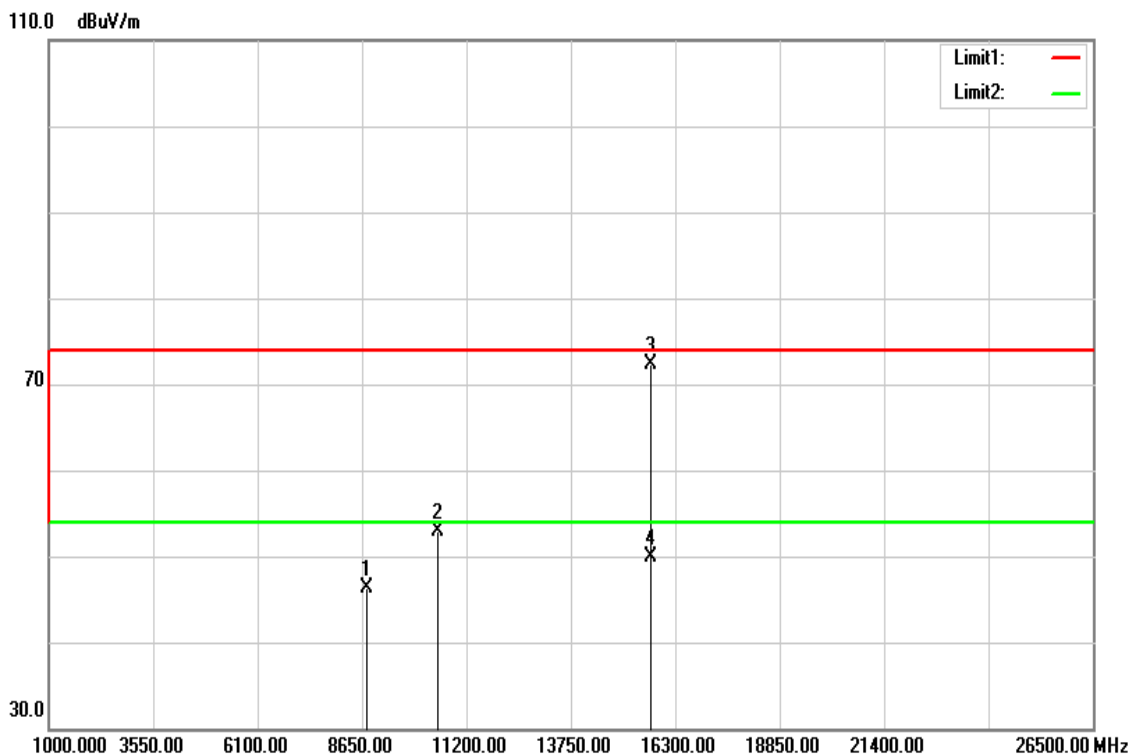

Frequency (MHz)	Reading (dBuV)	Correct Factor (dB/m)	Result (dBuV/m)	Limit (dBuV/m)	Margin (dB)	Remark
8755.000	30.67	15.56	46.23	74.00	-27.77	peak
10490.000	35.26	17.57	52.83	74.00	-21.17	peak
15710.000	51.11	21.19	72.30	74.00	-1.70	peak
15710.000	28.74	21.19	49.93	54.00	-4.07	AVG

Remark:

1. Measuring frequencies from 1 GHz to the 10th harmonic of highest fundamental frequency.
2. For above 1GHz, the EUT peak value was under average limit, therefore the Average value compliance with the average limit

Test Mode	IEEE 802.11n HT20 High CH	Temp/Hum	27(°C)/ 53%RH
Test Item	Harmonic	Test Date	Nov 08, 2016
Polarize	Horizontal	Test Engineer	Dennis Li
Detector	Peak and Average	Test Voltage	120Vac / 60Hz

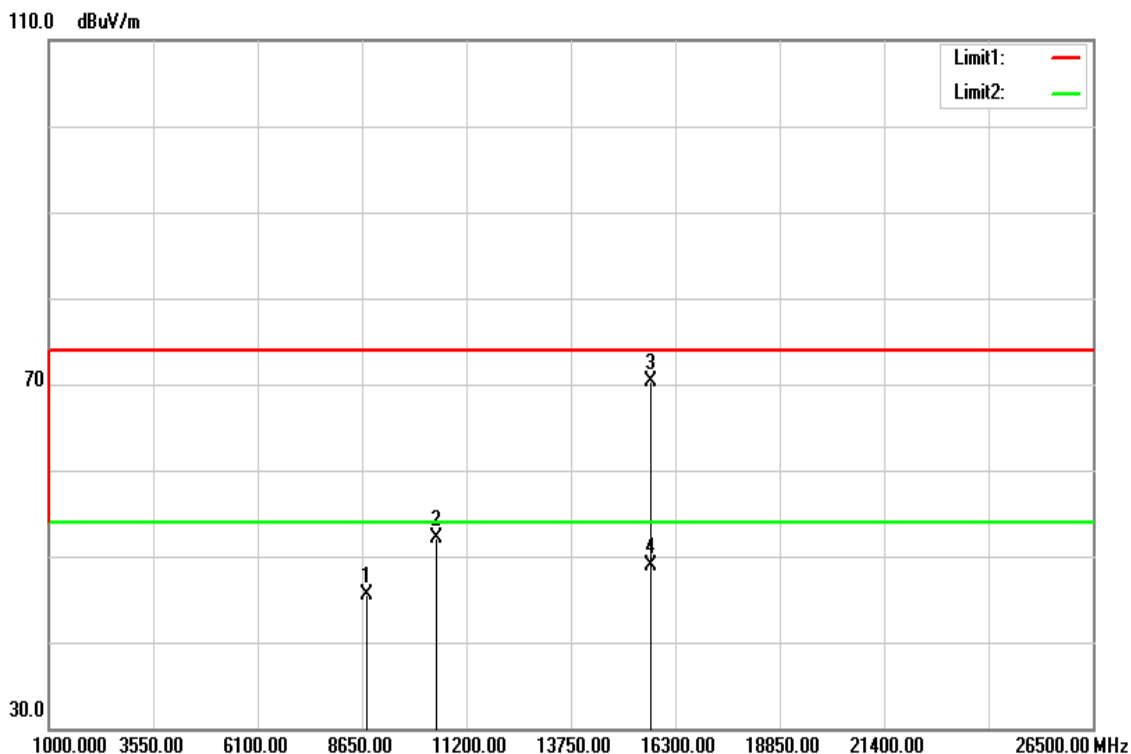

Frequency (MHz)	Reading (dBuV)	Correct Factor (dB/m)	Result (dBuV/m)	Limit (dBuV/m)	Margin (dB)	Remark
8758.000	29.95	15.57	45.52	74.00	-28.48	peak
10480.000	34.61	17.57	52.18	74.00	-21.82	peak
15720.000	49.03	21.22	70.25	74.00	-3.75	peak
15720.000	27.68	21.22	48.90	54.00	-5.10	AVG

Remark:

1. Measuring frequencies from 1 GHz to the 10th harmonic of highest fundamental frequency.
2. For above 1GHz, the EUT peak value was under average limit, therefore the Average value compliance with the average limit

Test Mode	IEEE 802.11n HT40 Low CH	Temp/Hum	27(°C)/ 53%RH
Test Item	Harmonic	Test Date	Nov 08, 2016
Polarize	Vertical	Test Engineer	Dennis Li
Detector	Peak and Average	Test Voltage	120Vac / 60Hz

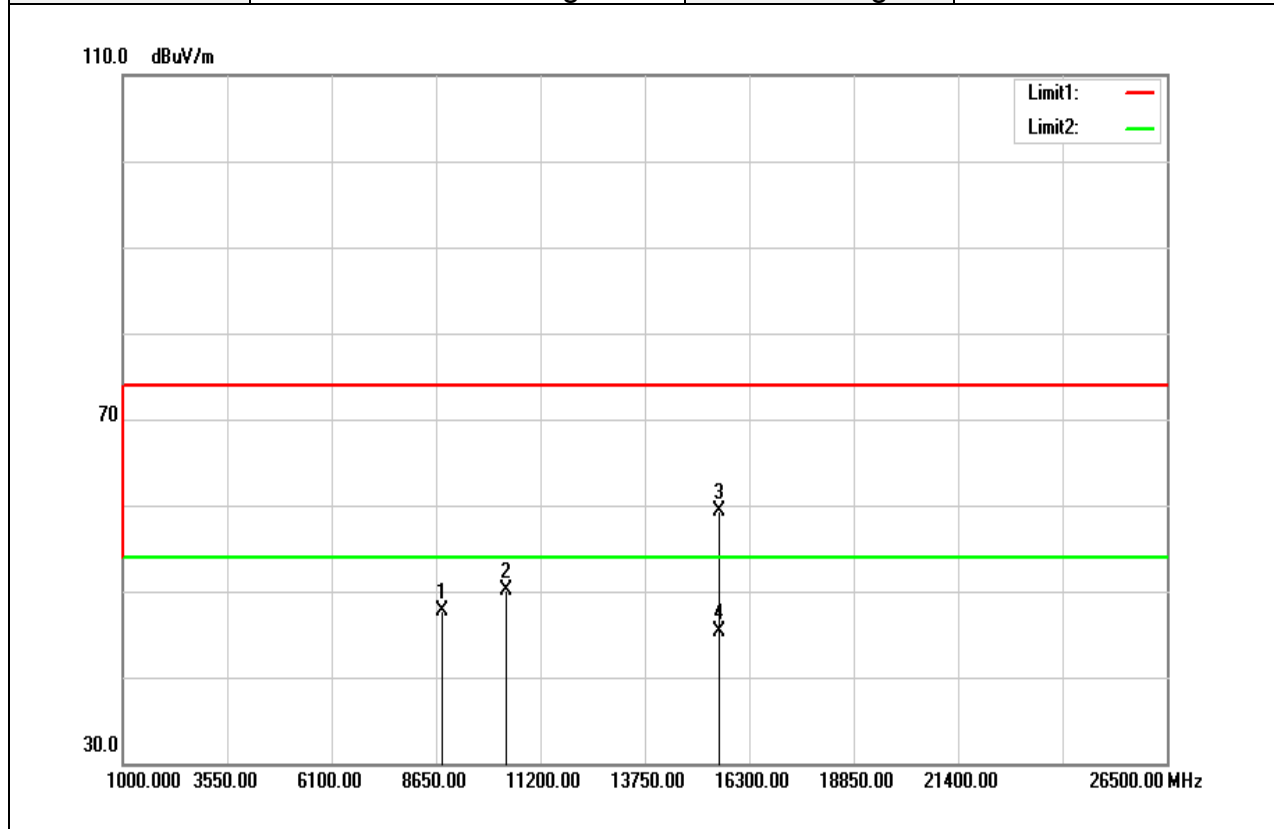

Frequency (MHz)	Reading (dBuV)	Correct Factor (dB/m)	Result (dBuV/m)	Limit (dBuV/m)	Margin (dB)	Remark
8788.000	32.14	15.62	47.76	74.00	-26.24	peak
10380.000	32.48	17.58	50.06	74.00	-23.94	peak
15570.000	38.53	20.71	59.24	74.00	-14.76	peak
15570.000	24.64	20.71	45.35	54.00	-8.65	AVG

Remark:

1. Measuring frequencies from 1 GHz to the 10th harmonic of highest fundamental frequency.
2. For above 1GHz, the EUT peak value was under average limit, therefore the Average value compliance with the average limit

Test Mode	IEEE 802.11n HT40 Low CH	Temp/Hum	27(°C) / 53%RH
Test Item	Harmonic	Test Date	Nov 08, 2016
Polarize	Horizontal	Test Engineer	Dennis Li
Detector	Peak and Average	Test Voltage	120Vac / 60Hz

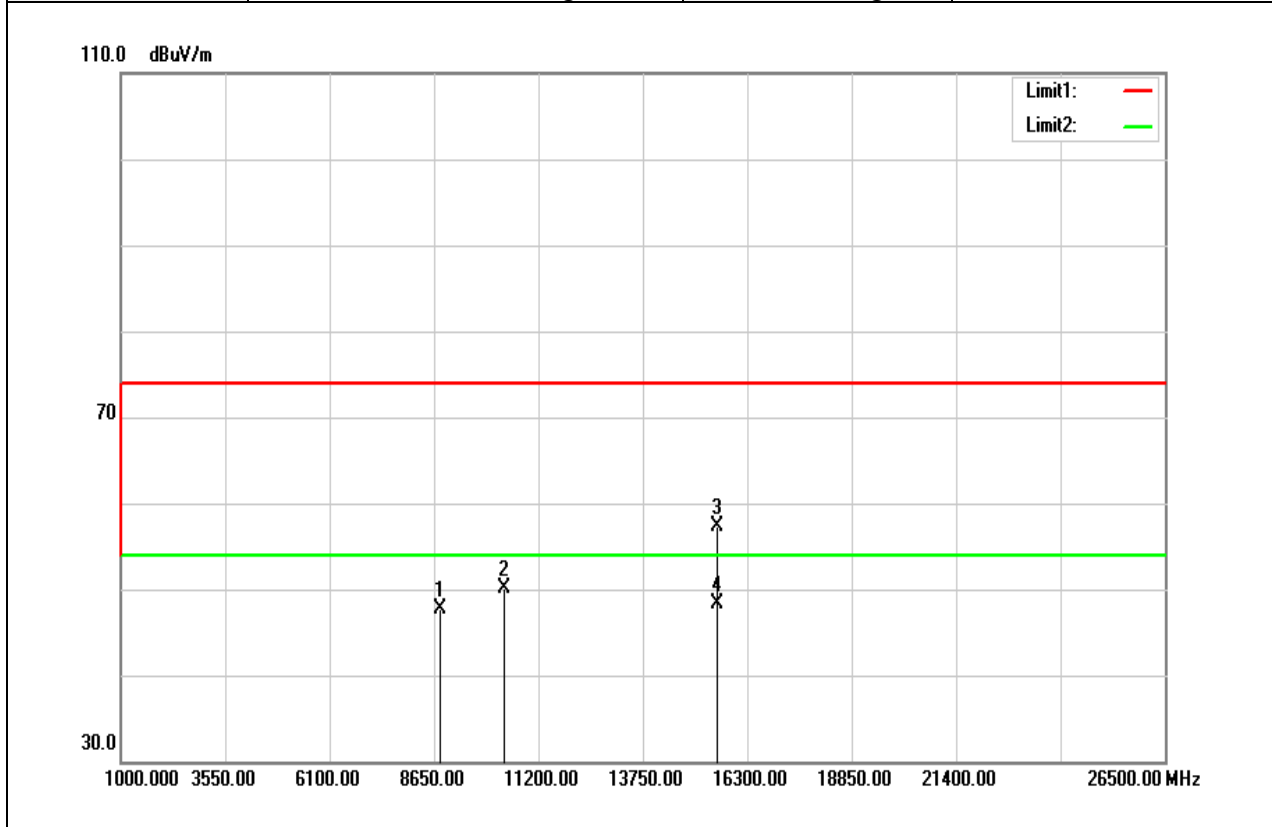

Frequency (MHz)	Reading (dBuV)	Correct Factor (dB/m)	Result (dBuV/m)	Limit (dBuV/m)	Margin (dB)	Remark
8788.000	32.11	15.62	47.73	74.00	-26.27	peak
10380.000	32.53	17.58	50.11	74.00	-23.89	peak
15570.000	36.56	20.71	57.27	74.00	-16.73	peak
15570.000	27.65	20.71	48.36	54.00	-5.64	AVG

Remark:

1. Measuring frequencies from 1 GHz to the 10th harmonic of highest fundamental frequency.
2. For above 1GHz, the EUT peak value was under average limit, therefore the Average value compliance with the average limit

Test Mode	IEEE 802.11n HT40 High CH	Temp/Hum	27(°C)/ 53%RH
Test Item	Harmonic	Test Date	Nov 08, 2016
Polarize	Vertical	Test Engineer	Dennis Li
Detector	Peak and Average	Test Voltage	120Vac / 60Hz

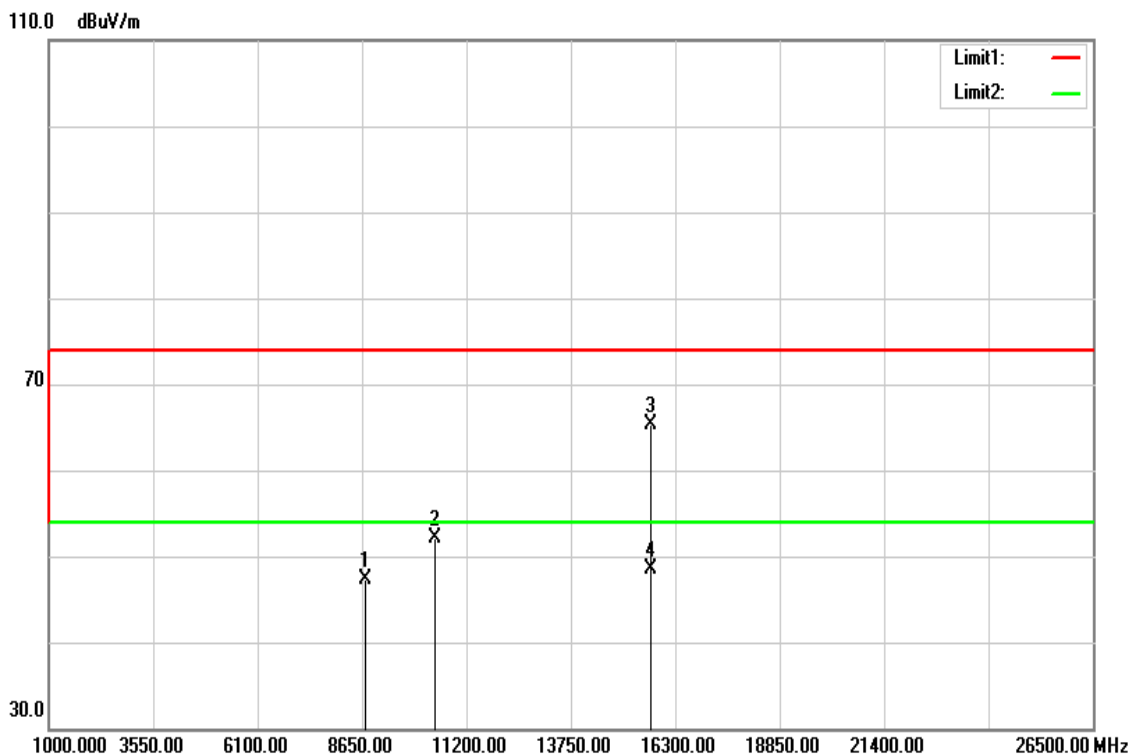

Frequency (MHz)	Reading (dBuV)	Correct Factor (dB/m)	Result (dBuV/m)	Limit (dBuV/m)	Margin (dB)	Remark
8745.000	31.80	15.54	47.34	74.00	-26.66	peak
10450.000	34.49	17.57	52.06	74.00	-21.94	peak
15690.000	44.24	21.12	65.36	74.00	-8.64	peak
15690.000	27.29	21.12	48.41	54.00	-5.59	AVG

Remark:

1. Measuring frequencies from 1 GHz to the 10th harmonic of highest fundamental frequency.
2. For above 1GHz, the EUT peak value was under average limit, therefore the Average value compliance with the average limit

Test Mode	IEEE 802.11n HT40 High CH	Temp/Hum	27(°C)/ 53%RH
Test Item	Harmonic	Test Date	Nov 08, 2016
Polarize	Horizontal	Test Engineer	Dennis Li
Detector	Peak and Average	Test Voltage	120Vac / 60Hz

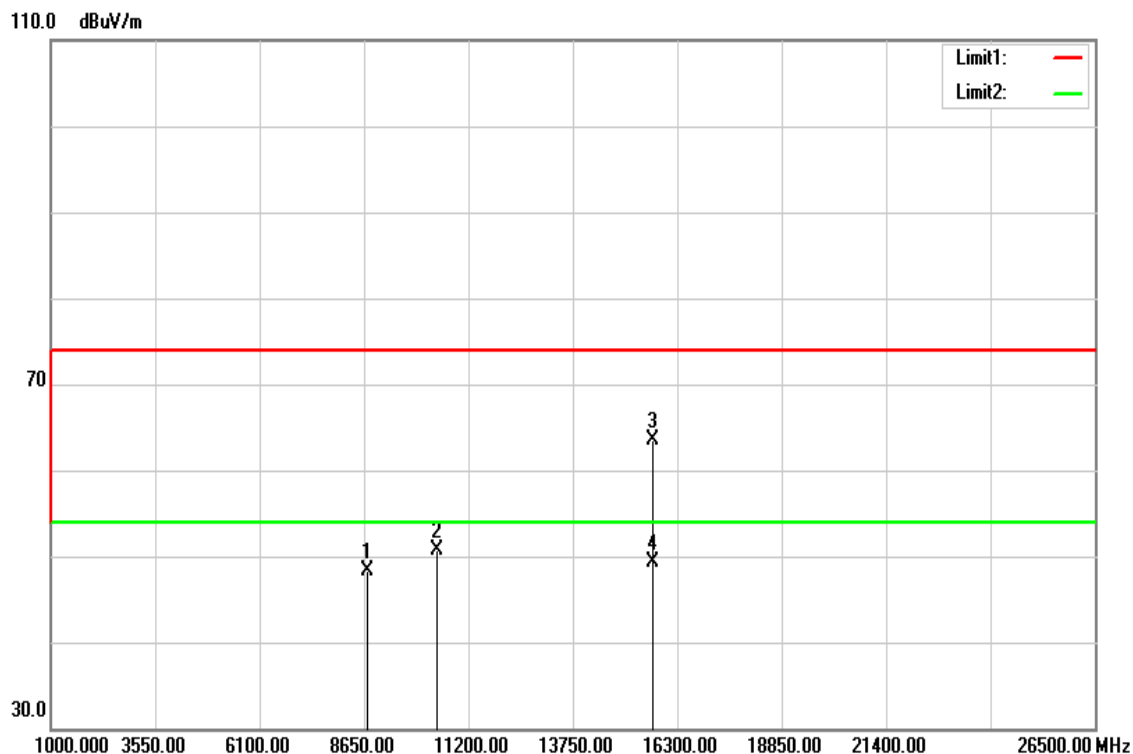

Frequency (MHz)	Reading (dBuV)	Correct Factor (dB/m)	Result (dBuV/m)	Limit (dBuV/m)	Margin (dB)	Remark
8745.000	32.77	15.54	48.31	74.00	-25.69	peak
10450.000	33.04	17.57	50.61	74.00	-23.39	peak
15690.000	42.44	21.12	63.56	74.00	-10.44	peak
15690.000	28.24	21.12	49.36	54.00	-4.64	AVG

Remark:

1. Measuring frequencies from 1 GHz to the 10th harmonic of highest fundamental frequency.
2. For above 1GHz, the EUT peak value was under average limit, therefore the Average value compliance with the average limit

Test Mode	IEEE 802.11ac VHT80 Mid CH	Temp/Hum	27(°C) / 53%RH
Test Item	Harmonic	Test Date	Nov 08, 2016
Polarize	Vertical	Test Engineer	Dennis Li
Detector	Peak and Average	Test Voltage	120Vac / 60Hz

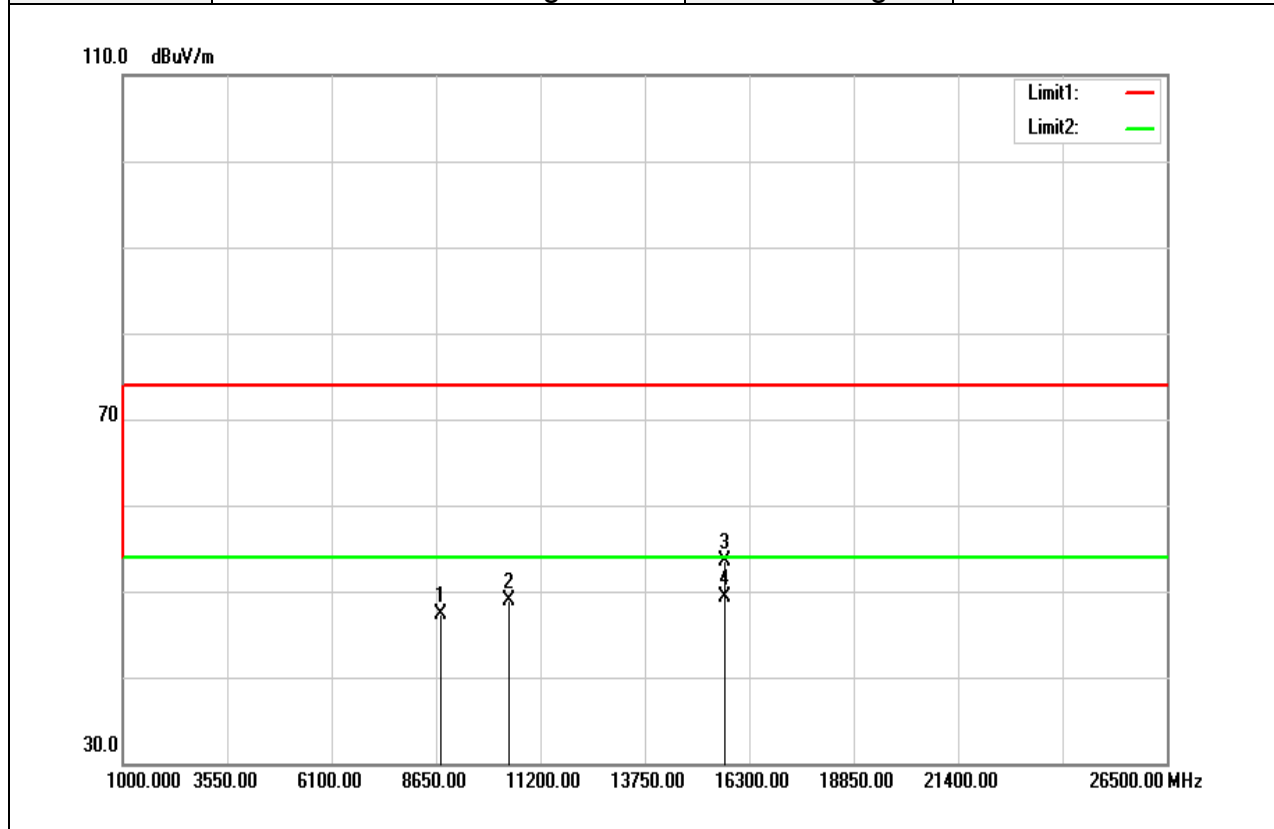

Frequency (MHz)	Reading (dBuV)	Correct Factor (dB/m)	Result (dBuV/m)	Limit (dBuV/m)	Margin (dB)	Remark
8756.000	31.84	15.56	47.40	74.00	-26.60	peak
10420.000	31.31	17.57	48.88	74.00	-25.12	peak
15720.000	32.23	21.22	53.45	74.00	-20.55	peak
15720.000	28.11	21.22	49.33	54.00	-4.67	AVG

Remark:

1. Measuring frequencies from 1 GHz to the 10th harmonic of highest fundamental frequency.
2. For above 1GHz, the EUT peak value was under average limit, therefore the Average value compliance with the average limit

Test Mode	IEEE 802.11ac VHT80 Mid CH	Temp/Hum	27(°C)/ 53%RH
Test Item	Harmonic	Test Date	Nov 08, 2016
Polarize	Horizontal	Test Engineer	Dennis Li
Detector	Peak and Average	Test Voltage	120Vac / 60Hz

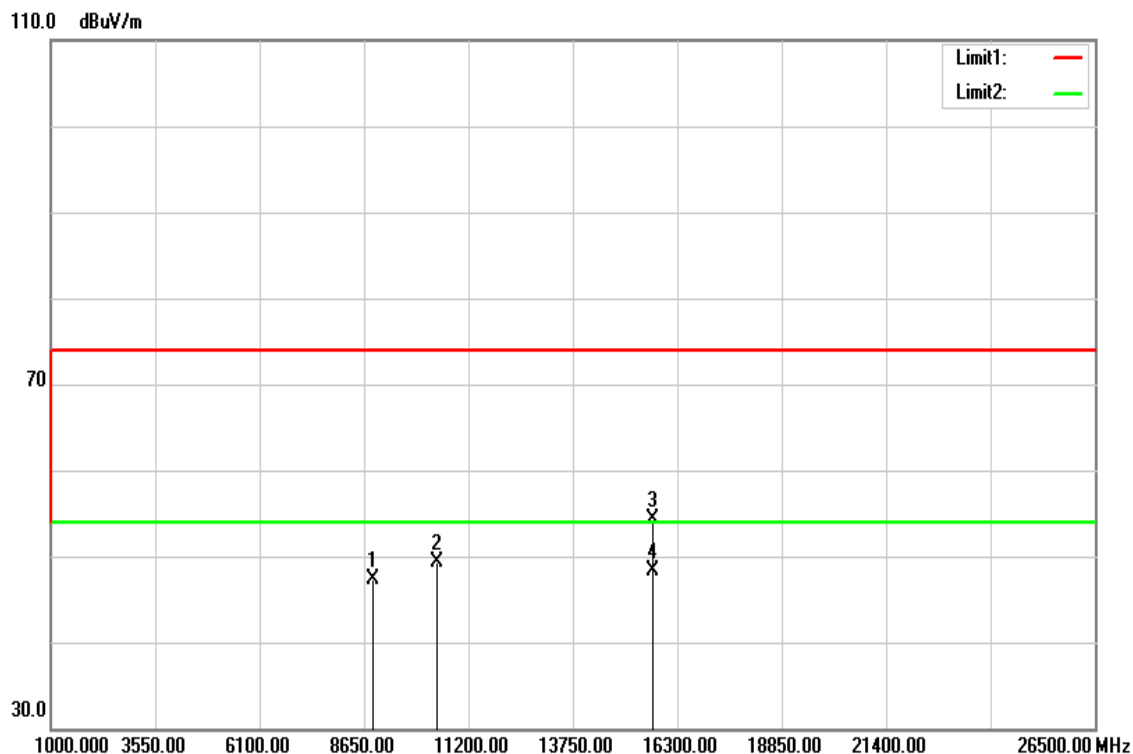

Frequency (MHz)	Reading (dBuV)	Correct Factor (dB/m)	Result (dBuV/m)	Limit (dBuV/m)	Margin (dB)	Remark
8866.000	31.44	15.77	47.21	74.00	-26.79	peak
10420.000	31.72	17.57	49.29	74.00	-24.71	peak
15720.000	32.99	21.22	54.21	74.00	-19.79	peak
15720.000	27.14	21.22	48.36	54.00	-5.64	AVG

Remark:

1. Measuring frequencies from 1 GHz to the 10th harmonic of highest fundamental frequency.
2. For above 1GHz, the EUT peak value was under average limit, therefore the Average value compliance with the average limit

Above 1G Test Data for UNII-3

Test Mode	IEEE 802.11a Low CH	Temp/Hum	27(°C)/ 53%RH
Test Item	Harmonic	Test Date	Nov 17, 2016
Polarize	Vertical	Test Engineer	Dennis Li
Detector	Peak and Average	Test Voltage	120Vac / 60Hz

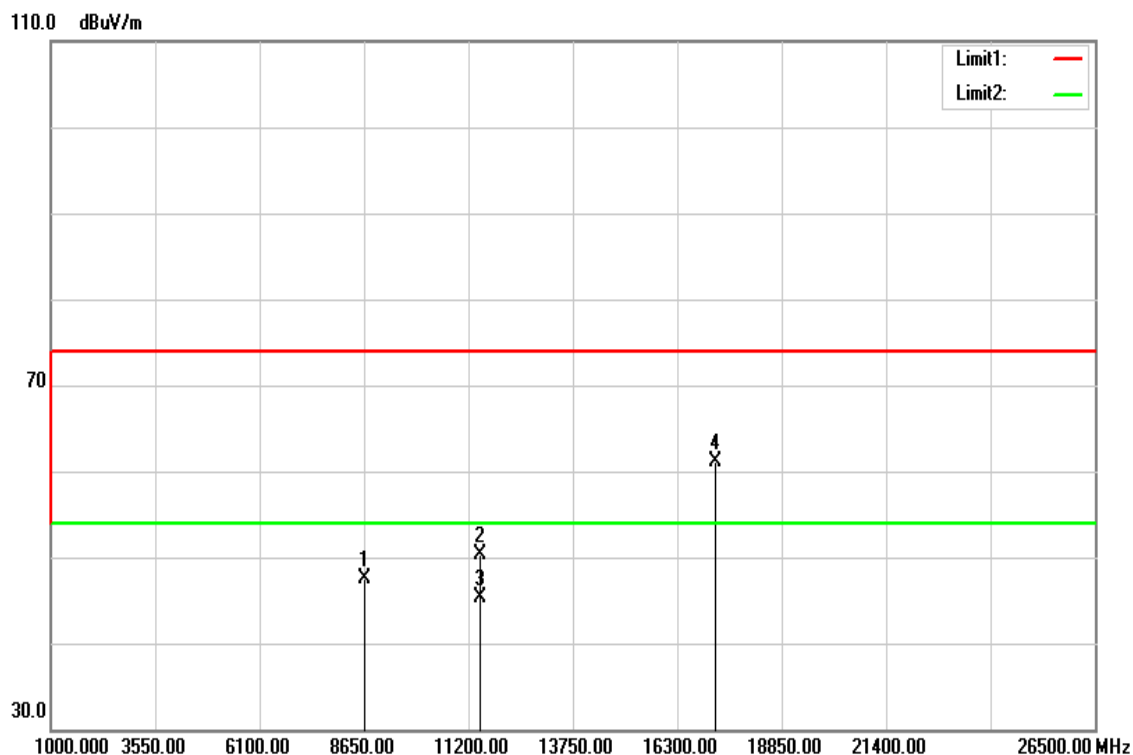

Frequency (MHz)	Reading (dBuV)	Correct Factor (dB/m)	Result (dBuV/m)	Limit (dBuV/m)	Margin (dB)	Remark
8659.000	32.03	15.38	47.41	74.00	-26.59	peak
11490.000	32.16	18.16	50.32	74.00	-23.68	peak
11490.000	27.20	18.16	45.36	54.00	-8.64	AVG
17230.000	34.21	26.80	61.01	74.00	-12.99	peak

Remark:

1. Measuring frequencies from 1 GHz to the 10th harmonic of highest fundamental frequency.
2. For above 1GHz, the EUT peak value was under average limit, therefore the Average value compliance with the average limit

Test Mode	IEEE 802.11a Low CH	Temp/Hum	27(°C)/ 53%RH
Test Item	Harmonic	Test Date	Nov 08, 2016
Polarize	Horizontal	Test Engineer	Dennis Li
Detector	Peak and Average	Test Voltage	120Vac / 60Hz

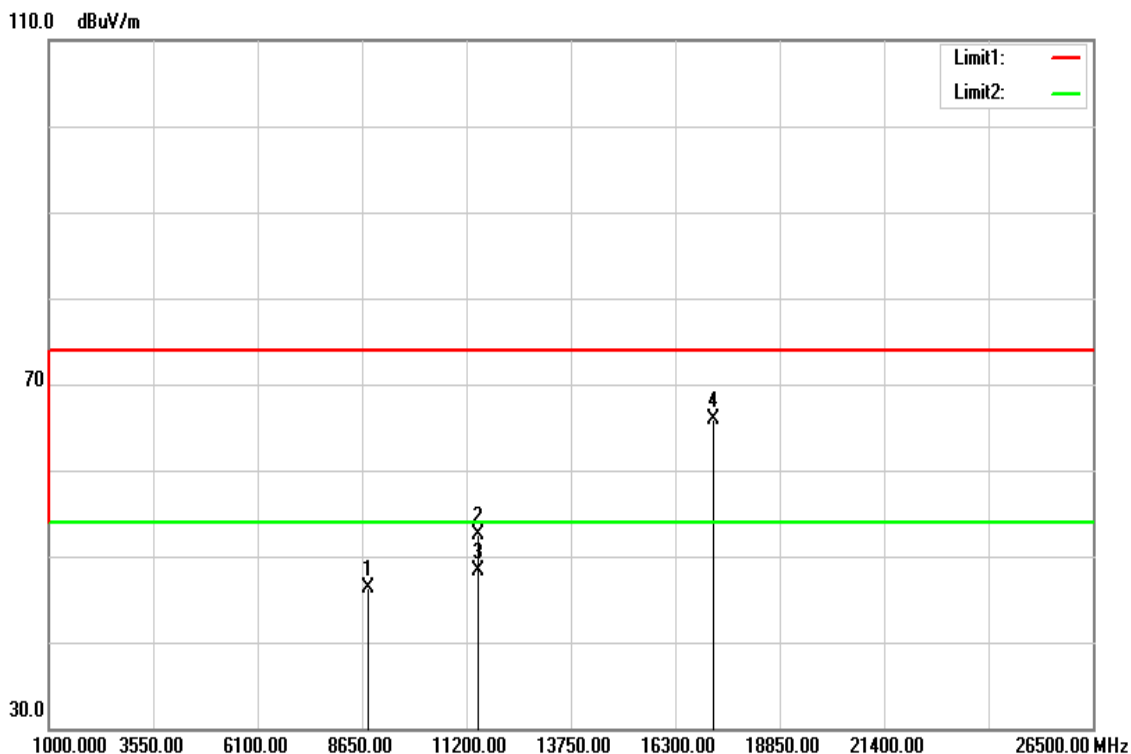

Frequency (MHz)	Reading (dBuV)	Correct Factor (dB/m)	Result (dBuV/m)	Limit (dBuV/m)	Margin (dB)	Remark
8788.000	30.75	15.62	46.37	74.00	-27.63	peak
11490.000	34.25	18.16	52.41	74.00	-21.59	peak
11490.000	30.09	18.16	48.25	54.00	-5.75	AVG
17230.000	39.20	26.80	66.00	74.00	-8.00	peak

Remark:

1. Measuring frequencies from 1 GHz to the 10th harmonic of highest fundamental frequency.
2. For above 1GHz, the EUT peak value was under average limit, therefore the Average value compliance with the average limit

Test Mode	IEEE 802.11a Mid CH	Temp/Hum	27(°C) / 53%RH
Test Item	Harmonic	Test Date	Nov 08, 2016
Polarize	Vertical	Test Engineer	Dennis Li
Detector	Peak and Average	Test Voltage	120Vac / 60Hz

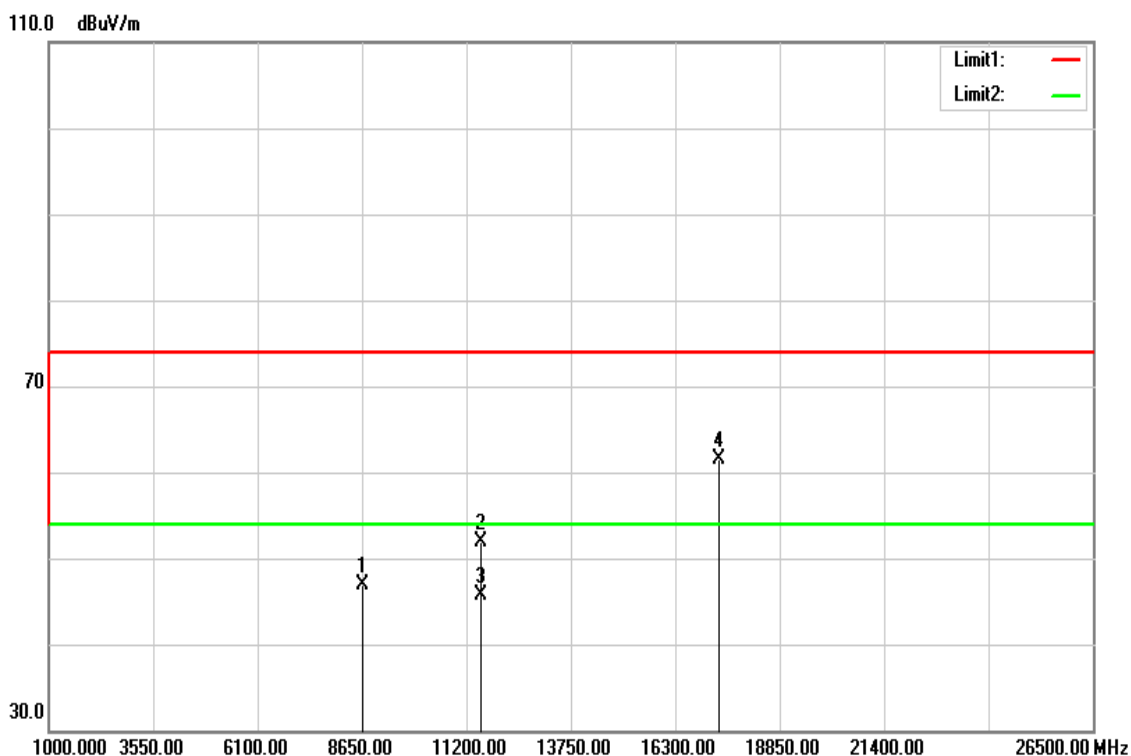

Frequency (MHz)	Reading (dBuV)	Correct Factor (dB/m)	Result (dBuV/m)	Limit (dBuV/m)	Margin (dB)	Remark
8654.000	31.48	15.37	46.85	74.00	-27.15	peak
11570.000	33.71	18.17	51.88	74.00	-22.12	peak
11570.000	27.51	18.17	45.68	54.00	-8.32	AVG
17355.000	33.98	27.57	61.55	74.00	-12.45	peak

Remark:

1. Measuring frequencies from 1 GHz to the 10th harmonic of highest fundamental frequency.
2. For above 1GHz, the EUT peak value was under average limit, therefore the Average value compliance with the average limit

Test Mode	IEEE 802.11a Mid CH	Temp/Hum	27(°C)/ 53%RH
Test Item	Harmonic	Test Date	Nov 08, 2016
Polarize	Horizontal	Test Engineer	Dennis Li
Detector	Peak and Average	Test Voltage	120Vac / 60Hz

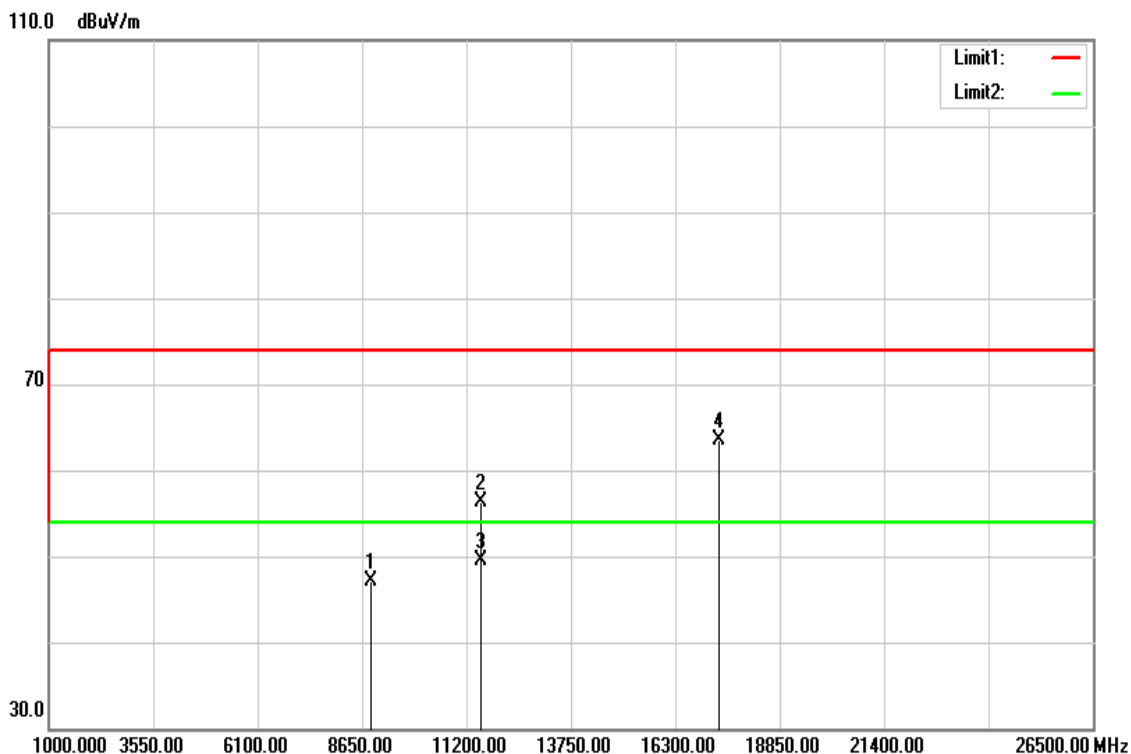

Frequency (MHz)	Reading (dBuV)	Correct Factor (dB/m)	Result (dBuV/m)	Limit (dBuV/m)	Margin (dB)	Remark
8866.000	31.30	15.77	47.07	74.00	-26.93	peak
11570.000	38.17	18.17	56.34	74.00	-17.66	peak
11570.000	31.41	18.17	49.58	54.00	-4.42	AVG
17355.000	35.91	27.57	63.48	74.00	-10.52	peak

Remark:

1. Measuring frequencies from 1 GHz to the 10th harmonic of highest fundamental frequency.
2. For above 1GHz, the EUT peak value was under average limit, therefore the Average value compliance with the average limit

Test Mode	IEEE 802.11a High CH	Temp/Hum	27(°C)/ 53%RH
Test Item	Harmonic	Test Date	Nov 08, 2016
Polarize	Vertical	Test Engineer	Dennis Li
Detector	Peak and Average	Test Voltage	120Vac / 60Hz

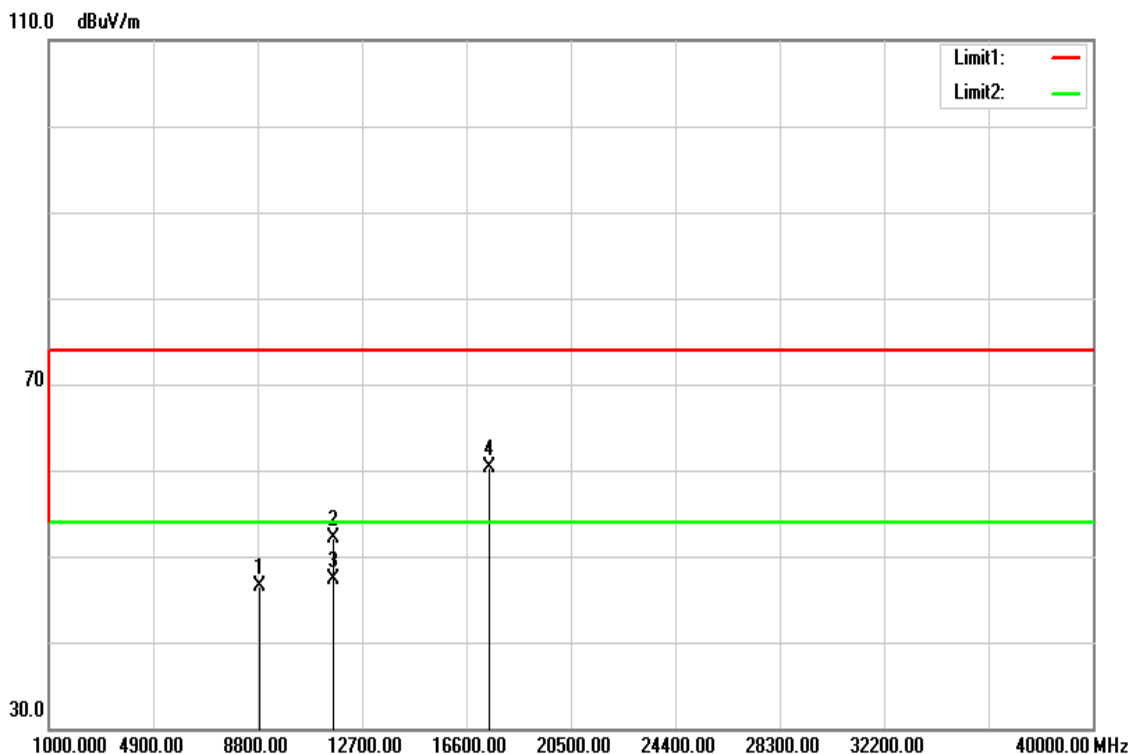

Frequency (MHz)	Reading (dBuV)	Correct Factor (dB/m)	Result (dBuV/m)	Limit (dBuV/m)	Margin (dB)	Remark
8877.000	30.67	15.79	46.46	74.00	-27.54	peak
11650.000	33.91	18.19	52.10	74.00	-21.90	peak
11650.000	29.06	18.19	47.25	54.00	-6.75	AVG
17475.000	32.05	28.30	60.35	74.00	-13.65	peak

Remark:

1. Measuring frequencies from 1 GHz to the 10th harmonic of highest fundamental frequency.
2. For above 1GHz, the EUT peak value was under average limit, therefore the Average value compliance with the average limit

Test Mode	IEEE 802.11a High CH	Temp/Hum	27(°C)/ 53%RH
Test Item	Harmonic	Test Date	Nov 08, 2016
Polarize	Horizontal	Test Engineer	Dennis Li
Detector	Peak and Average	Test Voltage	120Vac / 60Hz

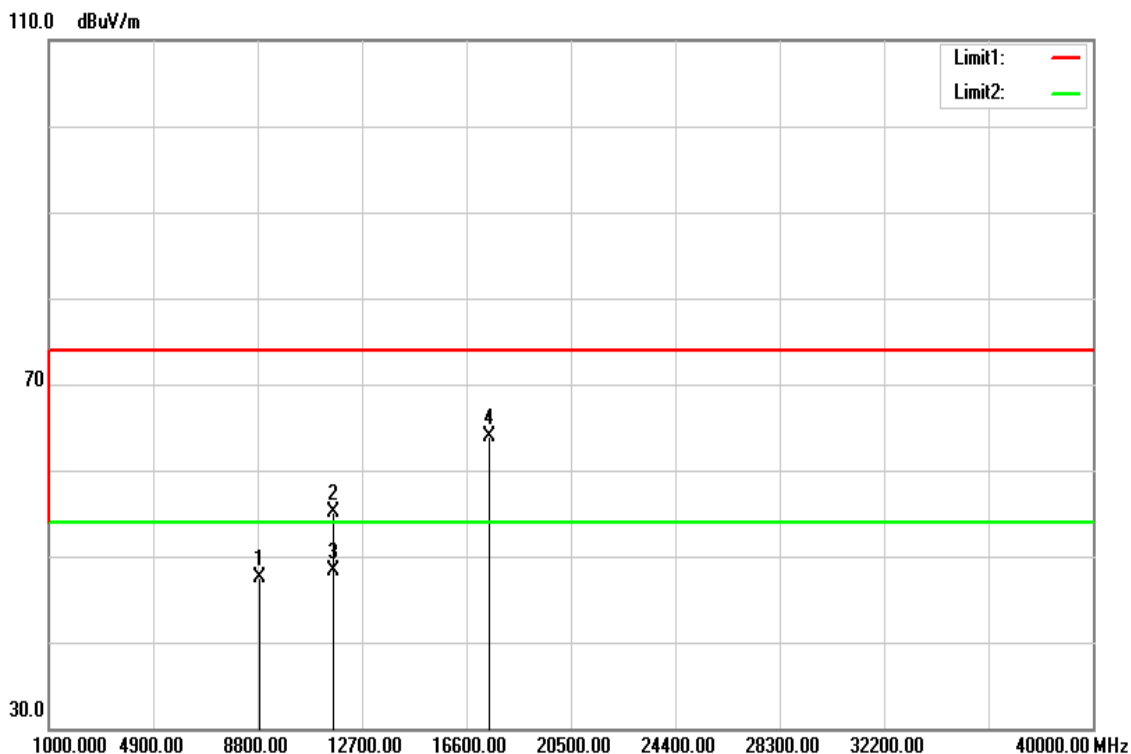

Frequency (MHz)	Reading (dBuV)	Correct Factor (dB/m)	Result (dBuV/m)	Limit (dBuV/m)	Margin (dB)	Remark
8877.000	31.72	15.79	47.51	74.00	-26.49	peak
11650.000	36.97	18.19	55.16	74.00	-18.84	peak
11650.000	30.17	18.19	48.36	54.00	-5.64	AVG
17475.000	35.52	28.30	63.82	74.00	-10.18	peak

Remark:

1. Measuring frequencies from 1 GHz to the 10th harmonic of highest fundamental frequency.
2. For above 1GHz, the EUT peak value was under average limit, therefore the Average value compliance with the average limit

Test Mode	IEEE 802.11n HT20 Low CH	Temp/Hum	27(°C)/ 53%RH
Test Item	Harmonic	Test Date	Nov 08, 2016
Polarize	Vertical	Test Engineer	Dennis Li
Detector	Peak and Average	Test Voltage	120Vac / 60Hz

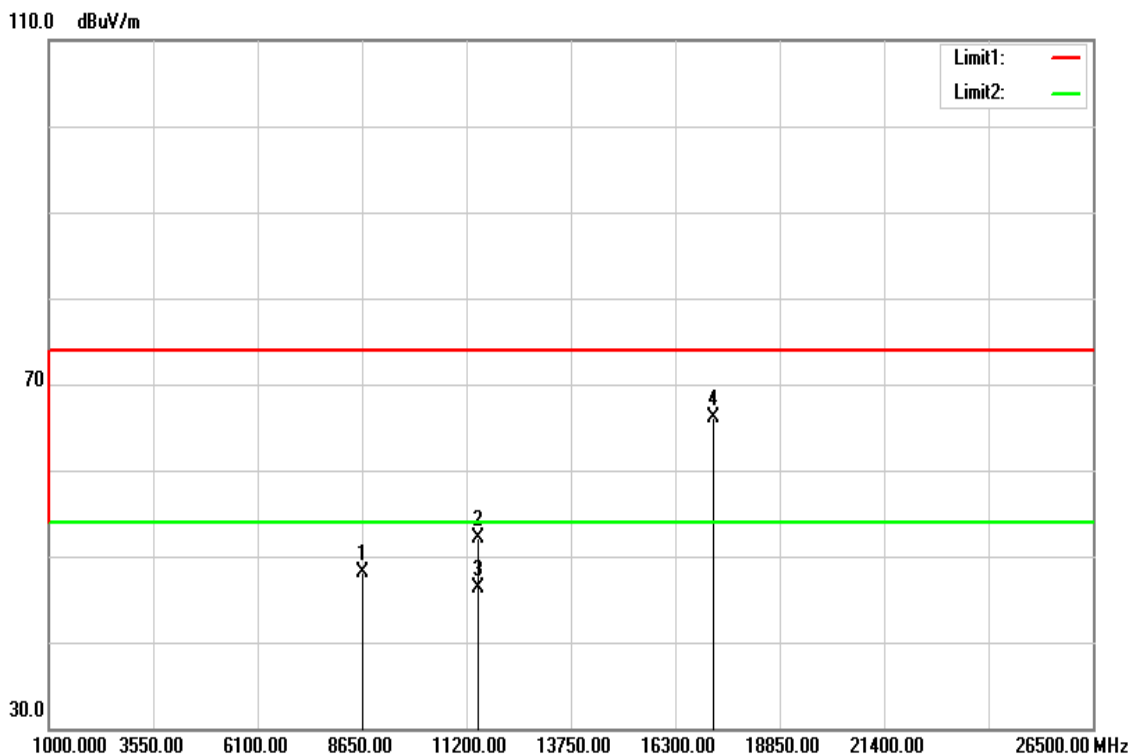

Frequency (MHz)	Reading (dBuV)	Correct Factor (dB/m)	Result (dBuV/m)	Limit (dBuV/m)	Margin (dB)	Remark
8675.000	32.63	15.41	48.04	74.00	-25.96	peak
11500.000	33.96	18.16	52.12	74.00	-21.88	peak
11500.000	28.20	18.16	46.36	54.00	-7.64	AVG
17250.000	39.17	26.92	66.09	74.00	-7.91	peak

Remark:

1. Measuring frequencies from 1 GHz to the 10th harmonic of highest fundamental frequency.
2. For above 1GHz, the EUT peak value was under average limit, therefore the Average value compliance with the average limit

Test Mode	IEEE 802.11n HT20 Low CH	Temp/Hum	27(°C) / 53%RH
Test Item	Harmonic	Test Date	Nov 08, 2016
Polarize	Horizontal	Test Engineer	Dennis Li
Detector	Peak and Average	Test Voltage	120Vac / 60Hz

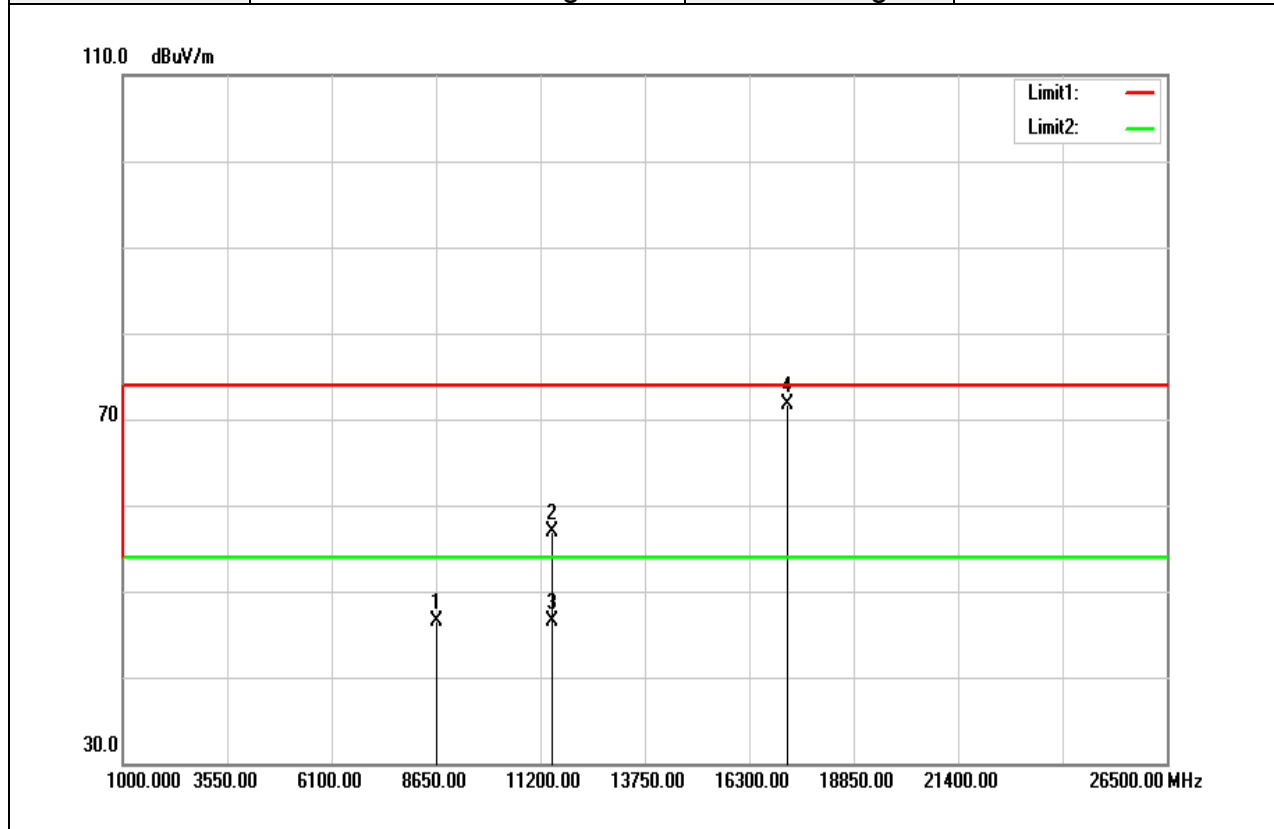

Frequency (MHz)	Reading (dBuV)	Correct Factor (dB/m)	Result (dBuV/m)	Limit (dBuV/m)	Margin (dB)	Remark
8675.000	31.09	15.41	46.50	74.00	-27.50	peak
11490.000	38.75	18.16	56.91	74.00	-17.09	peak
11490.000	28.42	18.16	46.58	54.00	-7.42	AVG
17250.000	44.71	26.92	71.63	74.00	-2.37	peak

Remark:

1. Measuring frequencies from 1 GHz to the 10th harmonic of highest fundamental frequency.
2. For above 1GHz, the EUT peak value was under average limit, therefore the Average value compliance with the average limit

Test Mode	IEEE 802.11n HT20 Mid CH	Temp/Hum	27(°C)/ 53%RH
Test Item	Harmonic	Test Date	Nov 08, 2016
Polarize	Vertical	Test Engineer	Dennis Li
Detector	Peak and Average	Test Voltage	120Vac / 60Hz

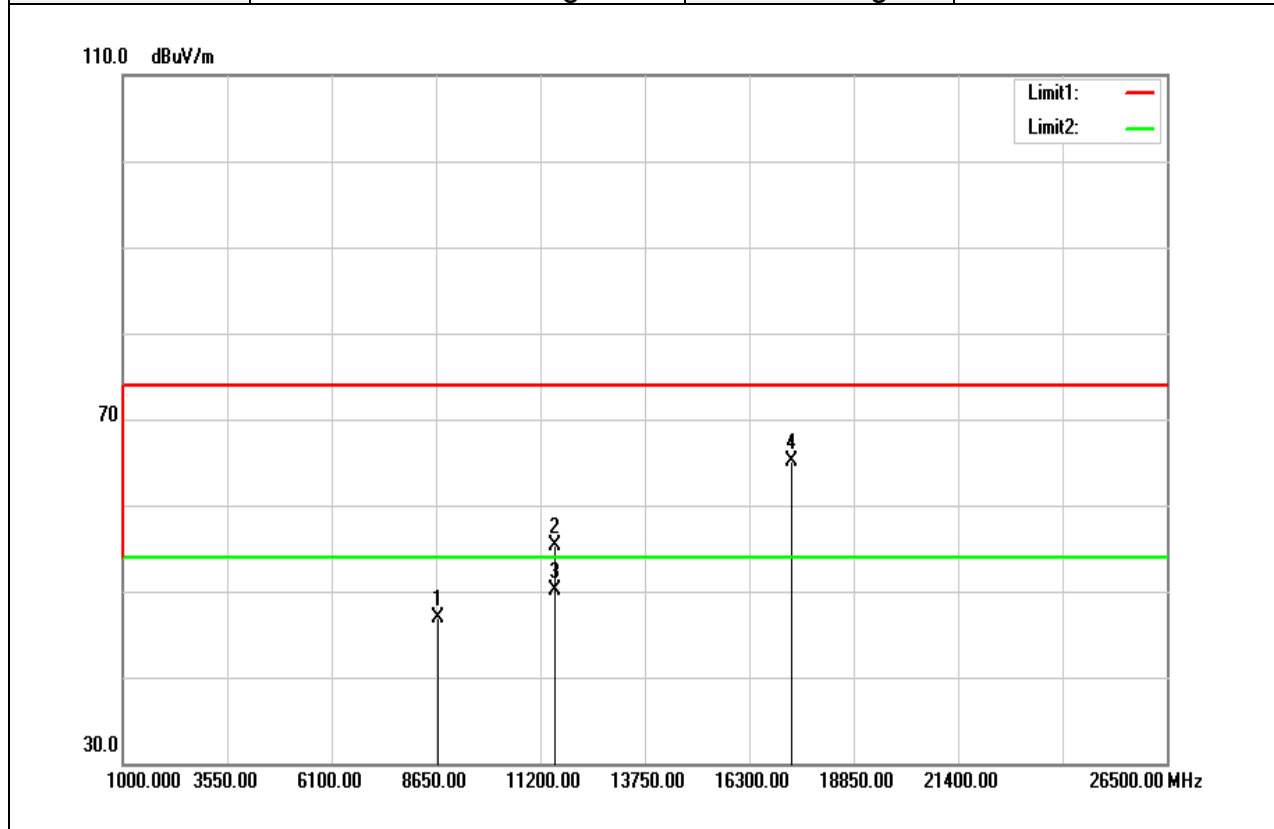

Frequency (MHz)	Reading (dBuV)	Correct Factor (dB/m)	Result (dBuV/m)	Limit (dBuV/m)	Margin (dB)	Remark
8698.000	31.50	15.45	46.95	74.00	-27.05	peak
11570.000	37.19	18.17	55.36	74.00	-18.64	peak
11570.000	31.94	18.17	50.11	54.00	-3.89	AVG
17350.000	37.55	27.54	65.09	74.00	-8.91	peak

Remark:

1. Measuring frequencies from 1 GHz to the 10th harmonic of highest fundamental frequency.
2. For above 1GHz, the EUT peak value was under average limit, therefore the Average value compliance with the average limit

Test Mode	IEEE 802.11n HT20 Mid CH	Temp/Hum	27(°C)/ 53%RH
Test Item	Harmonic	Test Date	Nov 08, 2016
Polarize	Horizontal	Test Engineer	Dennis Li
Detector	Peak and Average	Test Voltage	120Vac / 60Hz

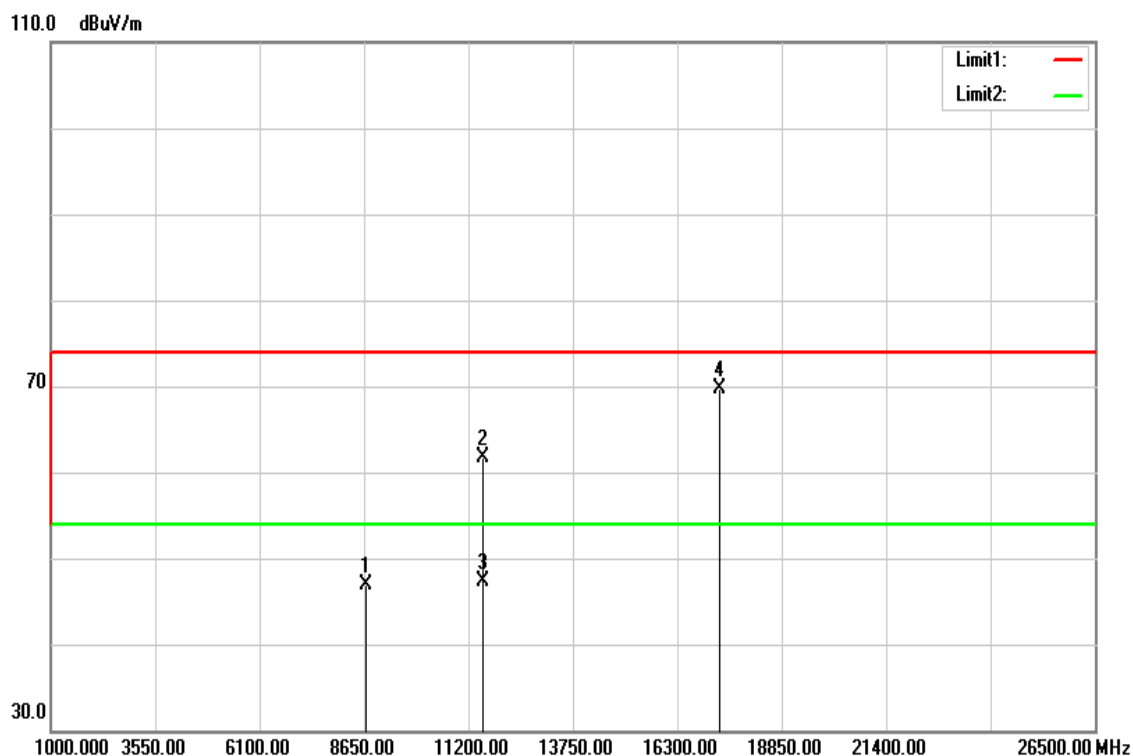

Frequency (MHz)	Reading (dBuV)	Correct Factor (dB/m)	Result (dBuV/m)	Limit (dBuV/m)	Margin (dB)	Remark
8699.000	31.43	15.45	46.88	74.00	-27.12	peak
11570.000	43.60	18.17	61.77	74.00	-12.23	peak
11570.000	29.07	18.17	47.24	54.00	-6.76	AVG
17350.000	42.22	27.54	69.76	74.00	-4.24	peak

Remark:

1. Measuring frequencies from 1 GHz to the 10th harmonic of highest fundamental frequency.
2. For above 1GHz, the EUT peak value was under average limit, therefore the Average value compliance with the average limit

Test Mode	IEEE 802.11n HT20 High CH	Temp/Hum	27(°C)/ 53%RH
Test Item	Harmonic	Test Date	Nov 08, 2016
Polarize	Vertical	Test Engineer	Dennis Li
Detector	Peak and Average	Test Voltage	120Vac / 60Hz

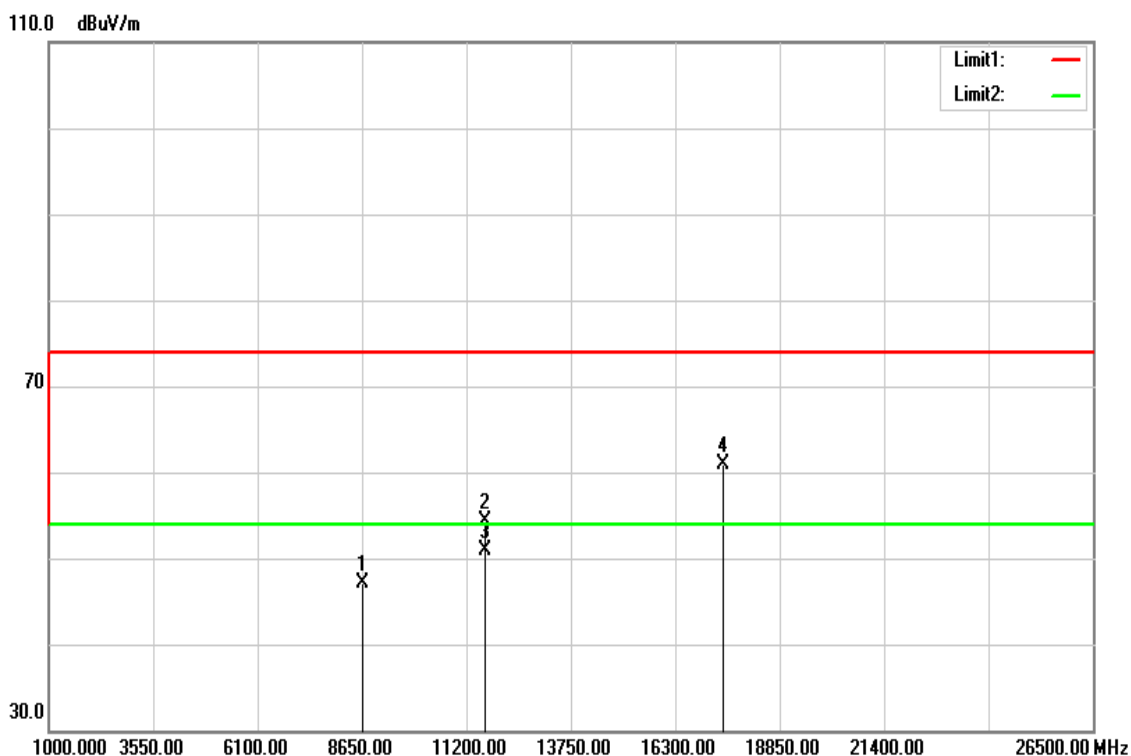

Frequency (MHz)	Reading (dBuV)	Correct Factor (dB/m)	Result (dBuV/m)	Limit (dBuV/m)	Margin (dB)	Remark
8679.000	31.72	15.42	47.14	74.00	-26.86	peak
11650.000	36.17	18.19	54.36	74.00	-19.64	peak
11650.000	32.62	18.19	50.81	54.00	-3.19	AVG
17475.000	32.69	28.30	60.99	74.00	-13.01	peak

Remark:

1. Measuring frequencies from 1 GHz to the 10th harmonic of highest fundamental frequency.
2. For above 1GHz, the EUT peak value was under average limit, therefore the Average value compliance with the average limit

Test Mode	IEEE 802.11n HT20 High CH	Temp/Hum	27(°C)/ 53%RH
Test Item	Harmonic	Test Date	Nov 08, 2016
Polarize	Horizontal	Test Engineer	Dennis Li
Detector	Peak and Average	Test Voltage	120Vac / 60Hz

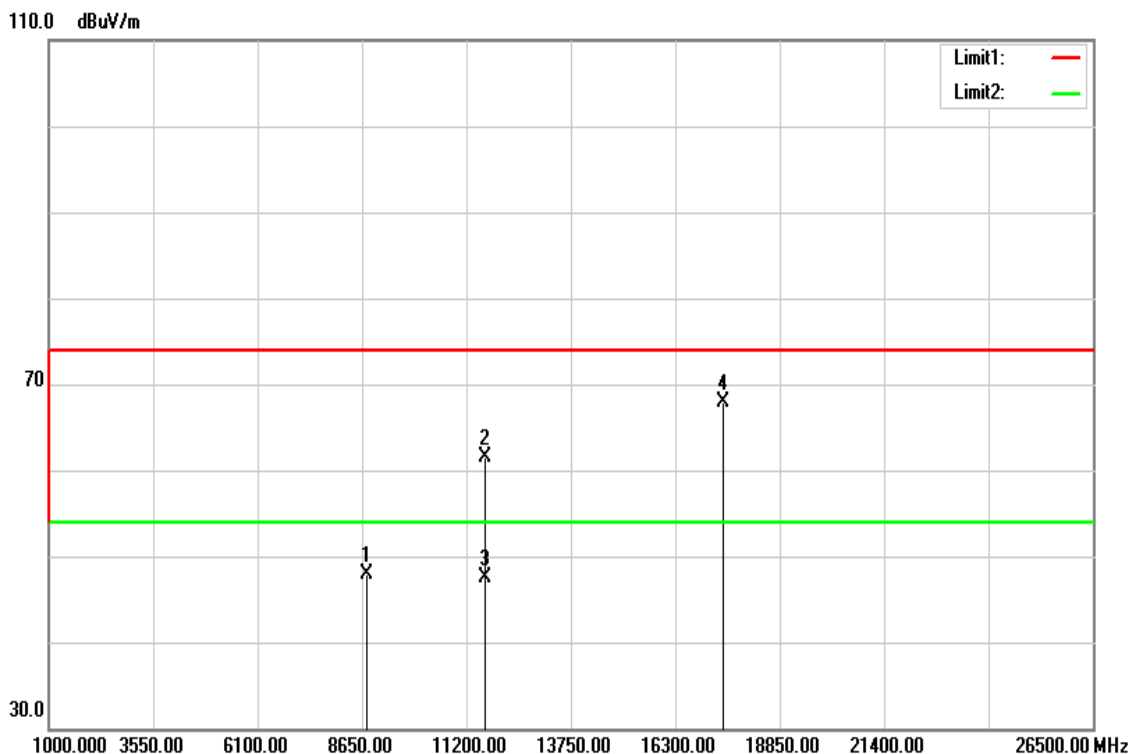

Frequency (MHz)	Reading (dBuV)	Correct Factor (dB/m)	Result (dBuV/m)	Limit (dBuV/m)	Margin (dB)	Remark
8756.000	32.35	15.56	47.91	74.00	-26.09	peak
11650.000	43.40	18.19	61.59	74.00	-12.41	peak
11650.000	29.25	18.19	47.44	54.00	-6.56	AVG
17475.000	39.67	28.30	67.97	74.00	-6.03	peak

Remark:

1. Measuring frequencies from 1 GHz to the 10th harmonic of highest fundamental frequency.
2. For above 1GHz, the EUT peak value was under average limit, therefore the Average value compliance with the average limit

Test Mode	IEEE 802.11n HT40 Low CH	Temp/Hum	27(°C)/ 53%RH
Test Item	Harmonic	Test Date	Nov 08, 2016
Polarize	Vertical	Test Engineer	Dennis Li
Detector	Peak and Average	Test Voltage	120Vac / 60Hz

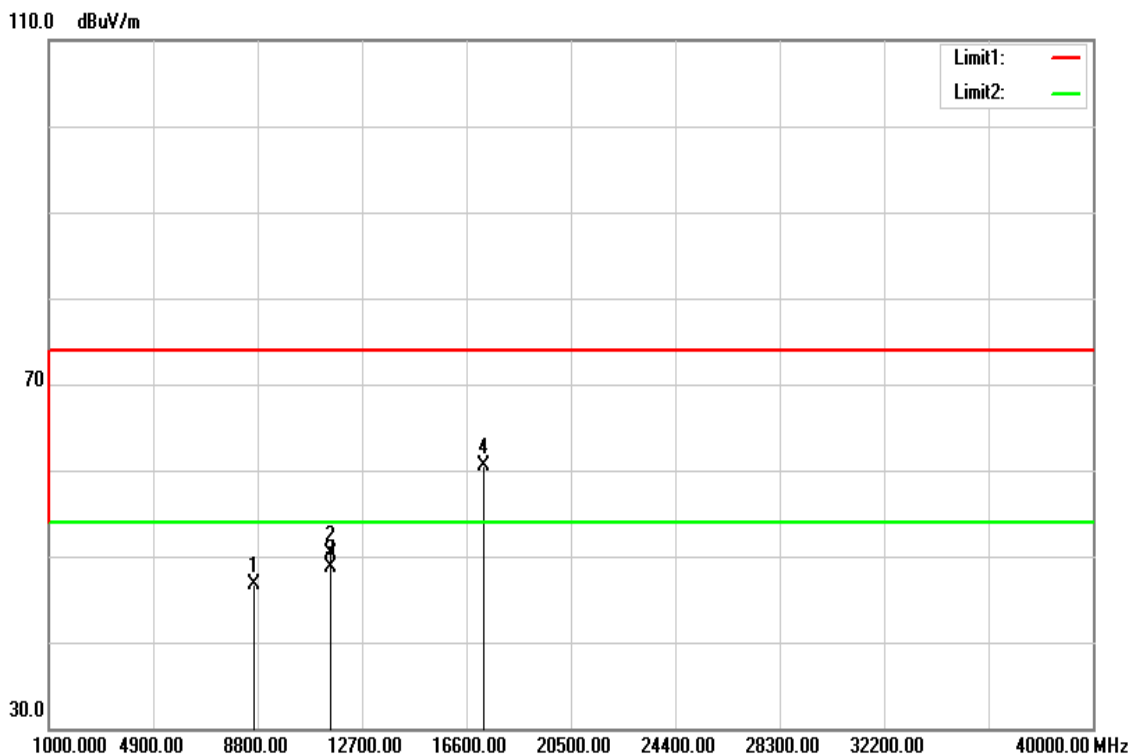

Frequency (MHz)	Reading (dBuV)	Correct Factor (dB/m)	Result (dBuV/m)	Limit (dBuV/m)	Margin (dB)	Remark
8691.000	31.17	15.44	46.61	74.00	-27.39	peak
11510.000	32.17	18.16	50.33	74.00	-23.67	peak
11510.000	30.53	18.16	48.69	54.00	-5.31	AVG
17265.000	33.54	27.02	60.56	74.00	-13.44	peak

Remark:

1. Measuring frequencies from 1 GHz to the 10th harmonic of highest fundamental frequency.
2. For above 1GHz, the EUT peak value was under average limit, therefore the Average value compliance with the average limit

Test Mode	IEEE 802.11n HT40 Low CH	Temp/Hum	27(°C)/ 53%RH
Test Item	Harmonic	Test Date	Nov 08, 2016
Polarize	Horizontal	Test Engineer	Dennis Li
Detector	Peak and Average	Test Voltage	120Vac / 60Hz

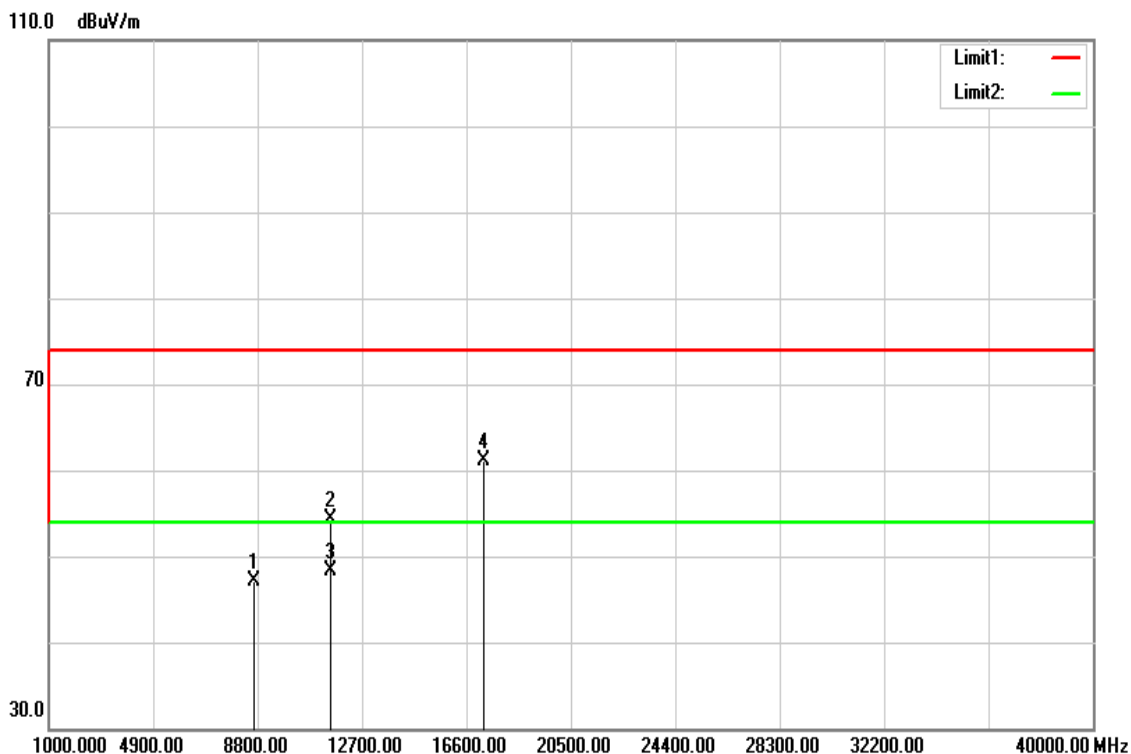

Frequency (MHz)	Reading (dBuV)	Correct Factor (dB/m)	Result (dBuV/m)	Limit (dBuV/m)	Margin (dB)	Remark
8691.000	31.65	15.44	47.09	74.00	-26.91	peak
11510.000	36.16	18.16	54.32	74.00	-19.68	peak
11510.000	30.20	18.16	48.36	54.00	-5.64	AVG
17265.000	34.01	27.02	61.03	74.00	-12.97	peak

Remark:

1. Measuring frequencies from 1 GHz to the 10th harmonic of highest fundamental frequency.
2. For above 1GHz, the EUT peak value was under average limit, therefore the Average value compliance with the average limit

Test Mode	IEEE 802.11n HT40 High CH	Temp/Hum	27(°C) / 53%RH
Test Item	Harmonic	Test Date	Nov 08, 2016
Polarize	Vertical	Test Engineer	Dennis Li
Detector	Peak and Average	Test Voltage	120Vac / 60Hz

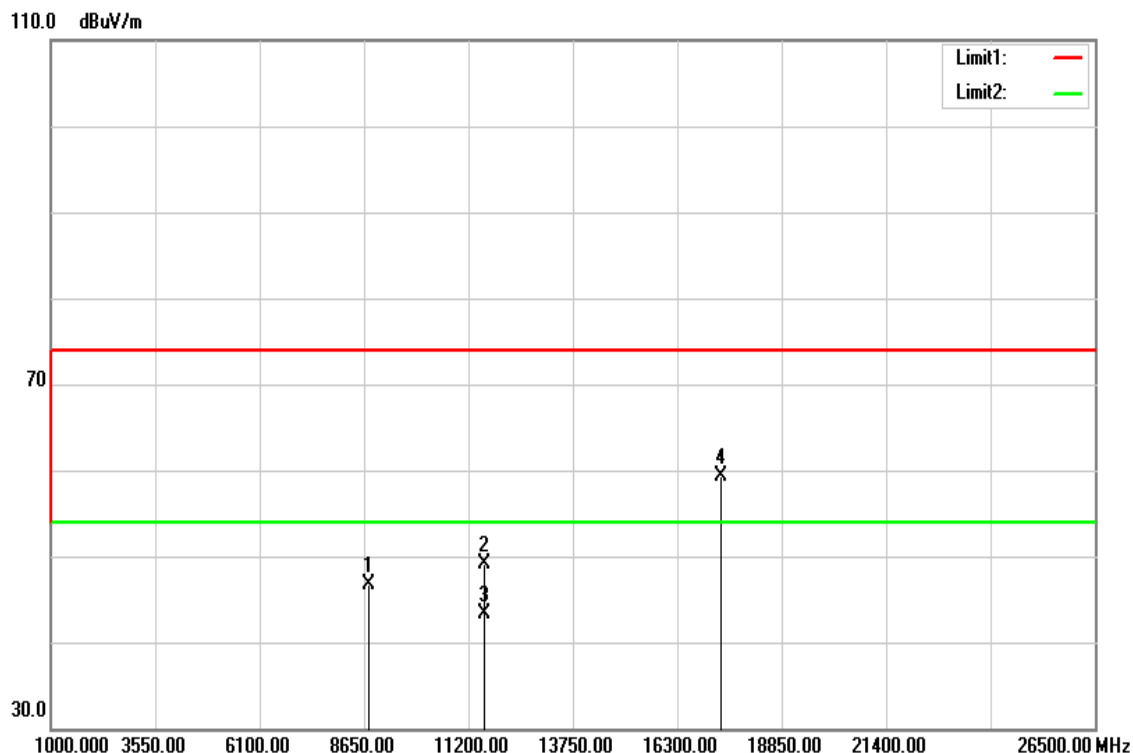

Frequency (MHz)	Reading (dBuV)	Correct Factor (dB/m)	Result (dBuV/m)	Limit (dBuV/m)	Margin (dB)	Remark
8756.000	31.14	15.56	46.70	74.00	-27.30	peak
11590.000	30.95	18.18	49.13	74.00	-24.87	peak
11590.000	25.18	18.18	43.36	54.00	-10.64	AVG
17385.000	31.61	27.75	59.36	74.00	-14.64	peak

Remark:

1. Measuring frequencies from 1 GHz to the 10th harmonic of highest fundamental frequency.
2. For above 1GHz, the EUT peak value was under average limit, therefore the Average value compliance with the average limit

Test Mode	IEEE 802.11n HT40 High CH	Temp/Hum	27(°C)/ 53%RH
Test Item	Harmonic	Test Date	Nov 08, 2016
Polarize	Horizontal	Test Engineer	Dennis Li
Detector	Peak and Average	Test Voltage	120Vac / 60Hz

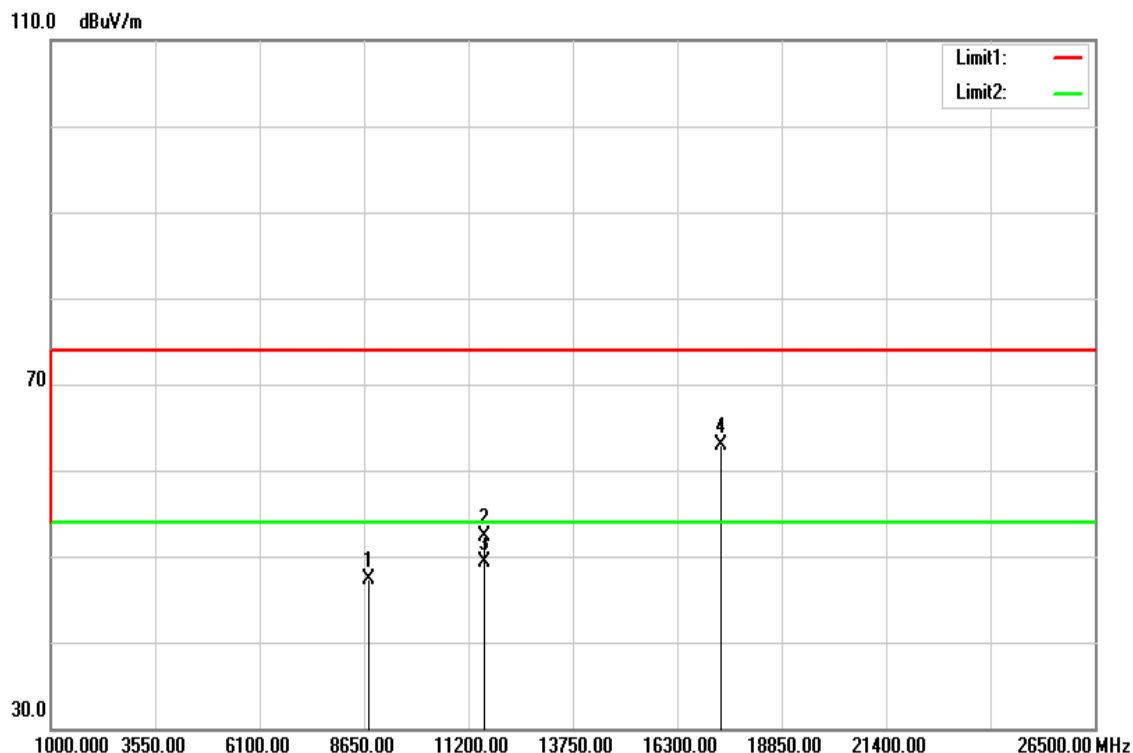

Frequency (MHz)	Reading (dBuV)	Correct Factor (dB/m)	Result (dBuV/m)	Limit (dBuV/m)	Margin (dB)	Remark
8756.000	31.84	15.56	47.40	74.00	-26.60	peak
11590.000	34.21	18.18	52.39	74.00	-21.61	peak
11590.000	31.15	18.18	49.33	54.00	-4.67	AVG
17385.000	35.20	27.75	62.95	74.00	-11.05	peak

Remark:

1. Measuring frequencies from 1 GHz to the 10th harmonic of highest fundamental frequency.
2. For above 1GHz, the EUT peak value was under average limit, therefore the Average value compliance with the average limit

Test Mode	IEEE 802.11ac VHT80 Mid CH	Temp/Hum	27(°C) / 53%RH
Test Item	Harmonic	Test Date	Nov 08, 2016
Polarize	Vertical	Test Engineer	Dennis Li
Detector	Peak and Average	Test Voltage	120Vac / 60Hz

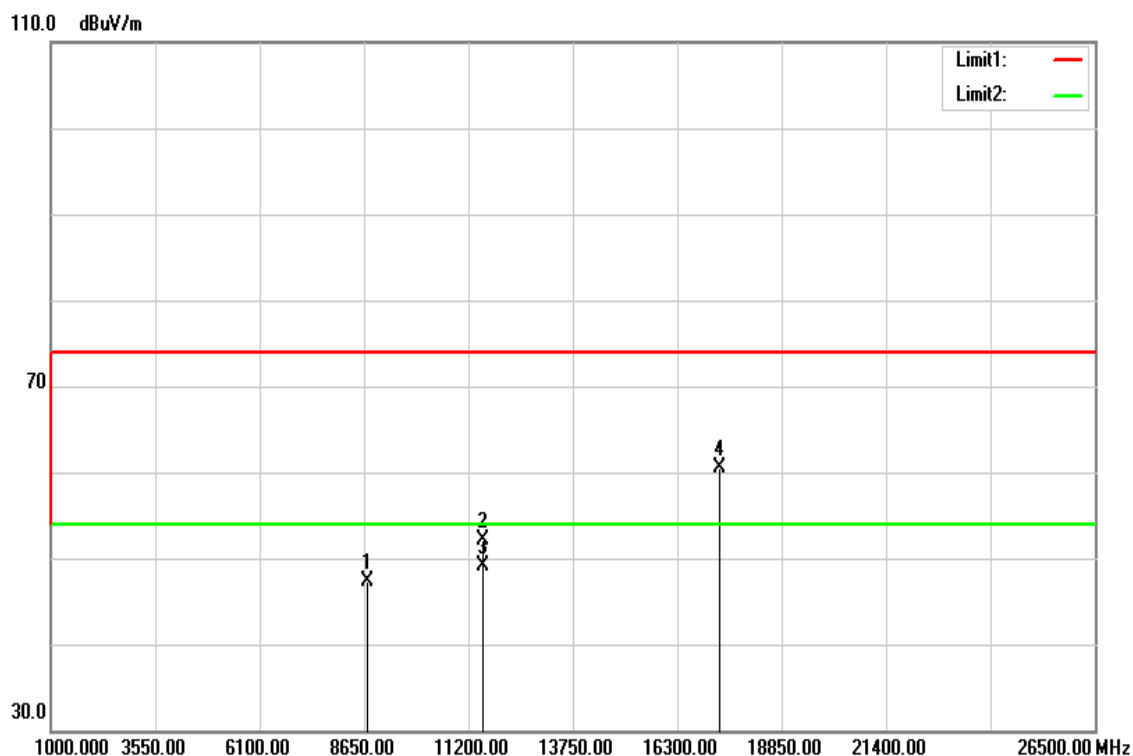

Frequency (MHz)	Reading (dBuV)	Correct Factor (dB/m)	Result (dBuV/m)	Limit (dBuV/m)	Margin (dB)	Remark
8746.000	31.86	15.54	47.40	74.00	-26.60	peak
11550.000	33.95	18.17	52.12	74.00	-21.88	peak
11550.000	30.96	18.17	49.13	54.00	-4.87	AVG
17325.000	33.06	27.38	60.44	74.00	-13.56	peak

Remark:

1. Measuring frequencies from 1 GHz to the 10th harmonic of highest fundamental frequency.
2. For above 1GHz, the EUT peak value was under average limit, therefore the Average value compliance with the average limit

Test Mode	IEEE 802.11ac VHT80 Mid CH	Temp/Hum	27(°C)/ 53%RH
Test Item	Harmonic	Test Date	Nov 08, 2016
Polarize	Horizontal	Test Engineer	Dennis Li
Detector	Peak and Average	Test Voltage	120Vac / 60Hz

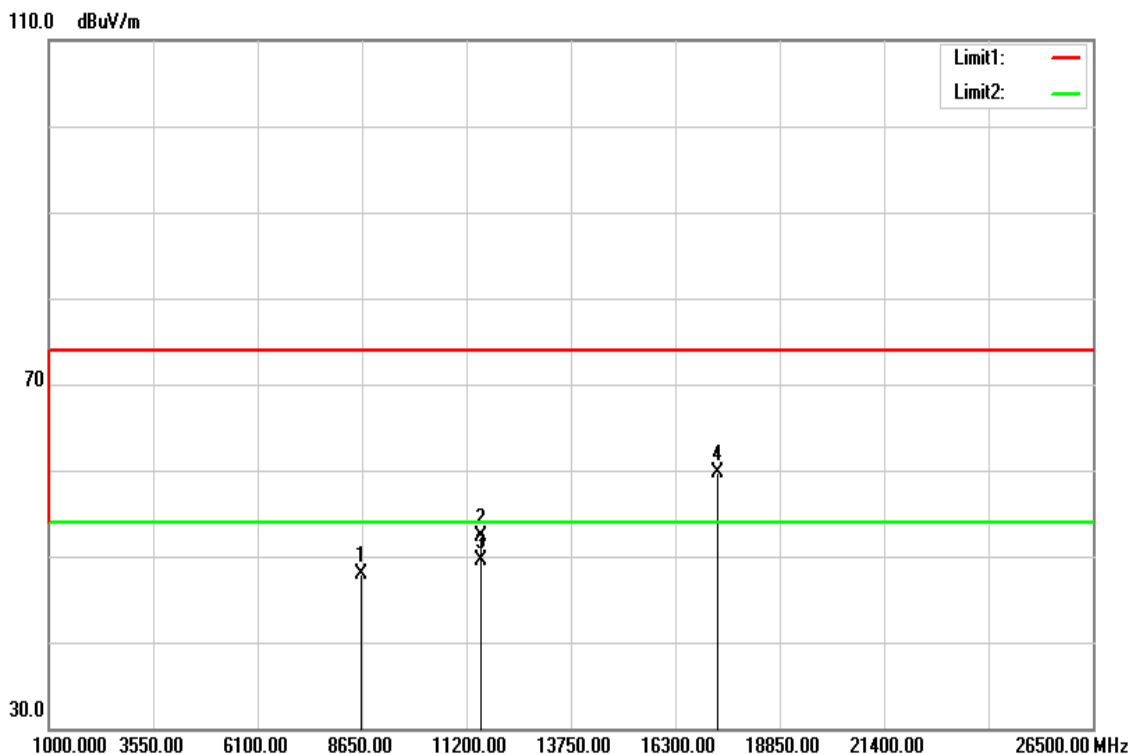

Frequency (MHz)	Reading (dBuV)	Correct Factor (dB/m)	Result (dBuV/m)	Limit (dBuV/m)	Margin (dB)	Remark
8646.000	32.57	15.35	47.92	74.00	-26.08	peak
11550.000	34.14	18.17	52.31	74.00	-21.69	peak
11550.000	31.33	18.17	49.50	54.00	-4.50	AVG
17325.000	32.41	27.38	59.79	74.00	-14.21	peak

Remark:

1. Measuring frequencies from 1 GHz to the 10th harmonic of highest fundamental frequency.
2. For above 1GHz, the EUT peak value was under average limit, therefore the Average value compliance with the average limit

4.6 FREQUENCY STABILITY

4.6.1 Test Limit

According to §15.407(g) manufacturers of U-NII devices are responsible for ensuring frequency stability such that an emission is maintained within the band of operation under all conditions of normal operation as specified in the operational description.

4.6.2 Test Procedure

The equipment under test was connected to an external AC or DC power supply and input rated voltage. RF output was connected to a frequency counter or spectrum analyzer via feed through attenuators. The EUT was placed inside the temperature chamber. Set the spectrum analyzer RBW low enough to obtain the desired frequency resolution and measure EUT 20°C operating frequency as reference frequency. Turn EUT off and set the chamber temperature to -20°C. After the temperature stabilized for approximately 30 minutes recorded the frequency. Repeat step measure with 10°C increased per stage until the highest temperature of +50°C reached.

4.6.3 Test Setup

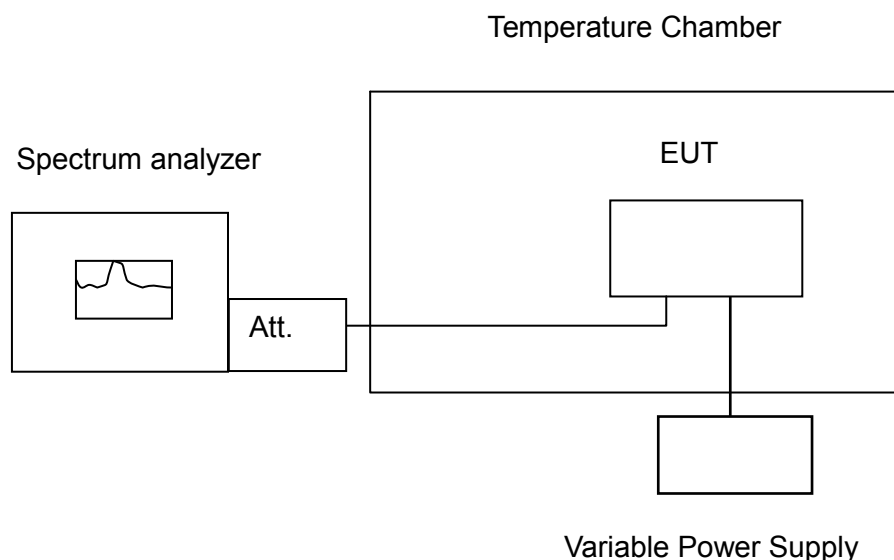

4.6.4 Test Result

Temperature Variations for UNII-1

Temp. (°C)	Voltage (V)	Measured Frequency	5180				Limit				Result
			Time (min)				20ppm				
Operating Frequency:		0 min	2 min	5 min	10 min	0 min	2 min	5 min	10 min		
50	12	5179.9889	5179.9889	5179.9889	5179.9889	-2.1347	-2.1351	-2.1351	-2.1371	Pass	
40	12	5179.9882	5179.9888	5179.9882	5179.9883	-2.2871	-2.1593	-2.2819	-2.2683	Pass	
30	12	5179.9881	5179.9881	5179.9881	5179.9880	-2.2973	-2.2934	-2.3069	-2.3108	Pass	
20	12	5179.9837	5179.9837	5179.9836	5179.9836	-3.1556	-3.1564	-3.1660	-3.1680	Pass	
10	12	5180.0091	5180.0091	5180.0092	5180.0092	1.7593	1.7625	1.7683	1.7741	Pass	
0	12	5180.0106	5180.0106	5180.0106	5180.0108	2.0367	2.0425	2.0463	2.0753	Pass	
-10	12	5180.0222	5180.0225	5180.0223	5180.0227	4.2853	4.3436	4.3127	4.3726	Pass	
-20	12	5180.0409	5180.0409	5180.0410	5180.0412	7.8890	7.8919	7.9054	7.9575	Pass	

Temp. (°C)	Voltage (V)	Measured Frequency	5180				Limit				Result
			Time (min)				20ppm				
Operating Frequency:		0 min	2 min	5 min	10 min	0 min	2 min	5 min	10 min		
20	10.2	5179.9851	5179.9851	5179.9851	5179.9851	-2.8718	-2.8718	-2.8718	-2.8707	Pass	
20	12	5179.9837	5179.9837	5179.9837	5179.9837	-3.1556	-3.1556	-3.1544	-3.1533	Pass	
20	13.8	5179.9822	5179.9822	5179.9822	5179.9822	-3.4288	-3.4288	-3.4295	-3.4284	Pass	

Temperature Variations for UNII-3

Temp. (°C)	Voltage (V)	Measured Frequency	5745				Limit				Result
			Time (min)				20ppm				
Operating Frequency:		0 min	2 min	5 min	10 min	0 min	2 min	5 min	10 min		
50	12	5745.9813	5745.9813	5745.9812	5745.9812	170.8007	170.8007	170.7990	170.7990	Pass	
40	12	5745.9810	5745.9811	5745.9810	5745.9810	170.7641	170.7659	170.7641	170.7641	Pass	
30	12	5745.9811	5745.9810	5745.9810	5745.9810	170.7746	170.7589	170.7554	170.7554	Pass	
20	12	5745.9808	5745.9808	5745.9808	5745.9808	170.7171	170.7171	170.7154	170.7154	Pass	
10	12	5745.0052	5745.0052	5745.0052	5745.0052	0.9069	0.9069	0.9051	0.9034	Pass	
0	12	5745.0105	5745.0105	5745.0104	5745.0104	1.8190	1.8190	1.8172	1.8172	Pass	
-10	12	5745.0211	5745.0211	5745.0211	5745.0211	3.6658	3.6675	3.6675	3.6658	Pass	
-20	12	5745.0409	5745.0409	5745.0409	5745.0409	7.1140	7.1123	7.1123	7.1105	Pass	

Temp. (°C)	Voltage (V)	Measured Frequency	5745				Limit				Result
			Time (min)				20ppm				
Operating Frequency:		0 min	2 min	5 min	10 min	0 min	2 min	5 min	10 min		
20	10.2	5745.9846	5745.9846	5745.9846	5745.9846	171.3856	171.3838	171.3838	171.3821	Pass	
20	12	5745.9808	5745.9808	5745.9808	5745.9808	170.7171	170.7171	170.7154	170.7154	Pass	
20	13.8	5745.9811	5745.9811	5745.9811	5745.9811	170.7659	170.7659	170.7676	170.7676	Pass	