

FCC RADIO TEST REPORT

FCC 47 CFR PART 15 SUBPART C

Test Standard **FCC Part 15.247**
FCC ID **PPQ-WP8331**
Product name **802.11ac Dual Band PoE Access Point**

**Brand name /
Model No.**

Model No.	Brand name
C-100	MOJO
	WatchGuard
WP8331	LITE-ON
AP200	WatchGuard

Test Result **Pass**

The test Result was tested by Compliance Certification Services Inc. The test data, data evaluation, test procedures, and equipment configurations shown in this report were given in ANSI C63.10: 2013 and compliance standards.

The test results of this report relate only to the tested sample (EUT) identified in this report.

The test Report of full or partial shall not copy. Without written approval of CCS. Inc.

The sample selected for test was production product and was provided by manufacturer.



Approved by:

Reviewed by:

Sam Chuang

Zeus Chen

Sam Chuang
Manager

Zeus Chen
Supervisor

Revision History

Rev.	Issue Date	Revisions	Revised By
00	November 22, 2016	Initial Issue	Angel Cheng

Table of contents

1. GENERAL INFORMATION	4
1.1 EUT INFORMATION	4
1.2 EUT CHANNEL INFORMATION	5
1.3 ANTENNA INFORMATION	5
1.4 MEASUREMENT UNCERTAINTY.....	6
1.5 FACILITIES AND TEST LOCATION	7
1.6 INSTRUMENT CALIBRATION	7
1.7 SUPPORT AND EUT ACCESSORIES EQUIPMENT	8
2. TEST SUMMERY	9
3. DESCRIPTION OF TEST MODES	10
3.1 THE WORST MODE OF OPERATING CONDITION	10
3.2 THE WORST MODE OF MEASUREMENT	11
3.3 EUT DUTY CYCLE.....	12
4. TEST RESULT	13
4.1 AC POWER LINE CONDUCTED EMISSION	13
4.2 6DB BANDWIDTH AND OCCUPIED BANDWIDTH(99%)	16
4.3 OUTPUT POWER MEASUREMENT	18
4.4 POWER SPECTRAL DENSITY.....	20
4.5 CONDUCTED BANDEDGE AND SPURIOUS EMISSION.....	22
4.6 RADIATION BANDEDGE AND SPURIOUS EMISSION	26
APPENDIX 1 - PHOTOGRAPHS OF EUT	

1. GENERAL INFORMATION

1.1 EUT INFORMATION

Applicant	Lite-On Technology Corp. Bldg. C, 90, Chien 1 Road, Chung Ho, New Taipei City 23585, Taiwan, R.O.C		
Equipment	802.11ac Dual Band PoE Access Point		
Brand name / Model No.	Model No.	Brand name	
	C-100	MOJO	
	WP8331	WatchGuard	
	AP200	LITE-ON	
Model Discrepancy	All the specification and layout are identical except they come with different model numbers for marketing purposes.		
EUT Functions	IEEE 802.11abgn+ac+BT		
Received Date	Nov 2, 2016		
Date of Test	Nov 03, 2016 ~ Nov 09, 2016		
Output Power(W)	BLE : 0.0022 W		
Power Operation	<input checked="" type="checkbox"/> AC 120V/60Hz <input checked="" type="checkbox"/> Adapter(Not for sale) <input checked="" type="checkbox"/> PoE(Not for sale) <input type="checkbox"/> DC Type : <input type="checkbox"/> Battery <input type="checkbox"/> DC Power Supply <input type="checkbox"/> External DC adapter		

1.2 EUT CHANNEL INFORMATION

Frequency Range	2402MHz-2480MHz
Modulation Type	GFSK for BLE-1Mbps
Number of channel	40 Channels

Remark:

Refer as ANSI 63.10:2013 clause 5.6.1 Table 4 for test channels

Number of frequencies to be tested		
Frequency range in which device operates	Number of frequencies	Location in frequency range of operation
<input type="checkbox"/> 1 MHz or less	1	Middle
<input type="checkbox"/> 1 MHz to 10 MHz	2	1 near top and 1 near bottom
<input checked="" type="checkbox"/> More than 10 MHz	3	1 near top, 1 near middle, and 1 near bottom

1.3 ANTENNA INFORMATION

Antenna Category	<input checked="" type="checkbox"/> Integral: antenna permanently attached <input type="checkbox"/> External dedicated antennas <input type="checkbox"/> External Unique antenna connector
Antenna Type	<input checked="" type="checkbox"/> PIFA <input type="checkbox"/> PCB <input type="checkbox"/> Dipole <input type="checkbox"/> Printed <input type="checkbox"/> Coils
Antenna Gain	2.6 dBi

1.4 MEASUREMENT UNCERTAINTY

PARAMETER	UNCERTAINTY
AC Powerline Conducted Emission	+/- 1.2575
Emission bandwidth, 20dB bandwidth	+/- 1.4003
RF output power, conducted	+/- 1.1372
Power density, conducted	+/- 1.4003
3M Semi Anechoic Chamber / 30M~200M	+/- 4.0138
3M Semi Anechoic Chamber / 200M~1000M	+/- 3.9483
3M Semi Anechoic Chamber / 1G~8G	+/- 2.5975
3M Semi Anechoic Chamber / 8G~18G	+/- 2.6112
3M Semi Anechoic Chamber / 18G~26G	+/- 2.7389
3M Semi Anechoic Chamber / 26G~40G	+/- 2.9683
3M Semi Anechoic Chamber / 40G~60G	+/- 1.8509
3M Semi Anechoic Chamber / 60G~75G	+/- 1.9869
3M Semi Anechoic Chamber / 75G~110G	+/- 2.9651
3M Semi Anechoic Chamber / 110G~170G	+/- 2.7807
3M Semi Anechoic Chamber / 170G~220G	+/- 3.6437
3M Semi Anechoic Chamber / 220G~325G	+/- 4.2982

Remark:

1. This uncertainty represents an expanded uncertainty expressed at approximately the 95% confidence level using a coverage factor of $k=2$
2. ISO/IEC 17025 requires that an estimate of the measurement uncertainties associated with the emissions test results be included in the report.

1.5 FACILITIES AND TEST LOCATION

All measurement facilities used to collect the measurement data are located at No.11, Wugong 6th Rd., Wugu Dist., New Taipei City 24891, Taiwan. (R.O.C.)

Test site	Test Engineer	Remark
AC Conduction Room	Anderson Kuo	
Radiation	Dennis Li	
RF Conducted	Ian Tu	

Remark: The sites are constructed in conformance with the requirements of ANSI C63.7, ANSI C63.4 and CISPR Publication 22.

1.6 INSTRUMENT CALIBRATION

RF Conducted Test Site				
Equipment	Manufacturer	Model	S/N	Cal Due
Spectrum Analyzer	R&S	FSV 40	101073	07/31/2017

3M 966 Chamber Test Site				
Equipment	Manufacturer	Model	S/N	Cal Due
Spectrum Analyzer	Agilent	E4446A	US42510252	12/07/2016
Loop Ant	COM-POWER	AL-130	121051	02/24/2017
Bilog Antenna	Sunol Sciences	JB3	A030105	07/02/2017
Pre-Amplifier	EMEC	EM330	60609	06/07/2017
Horn Antenna	ETC	MCTD 1209	DRH13M02003	09/01/2017
Pre-Amplifier	MITEQ	AMF-6F-260400-40-8P	985646	01/13/2017
Horn Antenna	EMCO	3116	26370	01/14/2017
Antenna Tower	CCS	CC-A-1F	N/A	N.C.R
Controller	CCS	CC-C-1F	N/A	N.C.R
Turn Table	CCS	CC-T-1F	N/A	N.C.R

AC Conducted Emissions Test Site				
Equipment	Manufacturer	Model	S/N	Cal Due
LISN	R&S	ENV216	101054	05/10/2017
Receiver	R&S	ESCI	101073	08/19/2017

Remark: Each piece of equipment is scheduled for calibration once a year.

1.7 SUPPORT AND EUT ACCESSORIES EQUIPMENT



EUT Accessories Equipment					
No.	Equipment	Brand	Model	Series No.	FCC ID
1	Adapter	APD	WB-18D-12FU	N/A	N/A
2	PoE	I.T.E	PW130	N/A	N/A

Support Equipment					
No.	Equipment	Brand	Model	Series No.	FCC ID
1	Notebook	ASUS	A&J	N/A	PD9WM3945ABG
2	Notebook	ASUS	K45V	N/A	PPD-AR5B225

1.8 Test methodology and applied standards

The test methodology, setups and results comply with all requirements in accordance with ANSI C63.10:2013, FCC Part 2, FCC Part 15.247, KDB 558074 D01 v03r05.

1.9 Table of accreditations and listings

Country	Agency	Scope of Accreditation	Logo
USA	FCC	3M Semi Anechoic Chamber (FCC MRA: TW1039) to perform FCC Part 15 measurements	
Canada	Industry Canada	3M Semi Anechoic Chamber (IC 2324G-1 / IC 2324G-2) to perform	

2. TEST SUMMERY

FCC Standard Sec.	Report Section	Test Item	Result
15.203	1.2	Antenna Requirement	Pass
15.207	4.1	AC Conducted Emission	Pass
15.247(a)(2)	4.2	6 dB Bandwidth	Pass
-	4.2	Occupied Bandwidth (99%)	-
15.247(b)	4.3	Output Power Measurement	Pass
15.247(e)	4.4	Power Spectral Density	Pass
15.247(d)	4.5	Conducted Band Edge	Pass
15.247(d)	4.5	Conducted Emission	Pass
15.247(d)	4.6	Radiation Band Edge	Pass
15.247(d)	4.6	Radiation Spurious Emission	Pass

3. DESCRIPTION OF TEST MODES

3.1 THE WORST MODE OF OPERATING CONDITION

Operation mode	BLE Mode (1Mbps)
Test Channel Frequencies	1.Lowest Channel : 2402MHz 2.Middle Channel : 2440MHz 3.Highest Channel : 2480MHz

Remark:

1. EUT pre-scanned data rate of output power for each mode, the worst data rate were recorded in this report.

.

3.2 THE WORST MODE OF MEASUREMENT

AC Power Line Conducted Emission	
Test Condition	AC Power line conducted emission for line and neutral
Voltage/Hz	120V/60Hz
Test Mode	Mode 1:EUT power by AC adapter Mode 2:EUT power by PoE adapter via LAN cable
Worst Mode	<input checked="" type="checkbox"/> Mode 1 <input type="checkbox"/> Mode 2 <input type="checkbox"/> Mode 3 <input type="checkbox"/> Mode 4

Radiated Emission Measurement Above 1G	
Test Condition	Band edge, Emission for Unwanted and Fundamental
Voltage/Hz	120V/60Hz
Test Mode	Mode 1:EUT power by AC adapter Mode 2:EUT power by PoE adapter via LAN cable
Worst Mode	<input checked="" type="checkbox"/> Mode 1 <input type="checkbox"/> Mode 2 <input type="checkbox"/> Mode 3 <input type="checkbox"/> Mode 4
Worst Position	<input type="checkbox"/> Placed in fixed position. <input checked="" type="checkbox"/> Placed in fixed position at X-Plane (E2-Plane) <input type="checkbox"/> Placed in fixed position at Y-Plane (E1-Plane) <input type="checkbox"/> Placed in fixed position at Z-Plane (H-Plane)
Worst Polarity	<input checked="" type="checkbox"/> Horizontal <input type="checkbox"/> Vertical

Radiated Emission Measurement Below 1G	
Test Condition	Radiated Emission Below 1G
Voltage/Hz	120V/60Hz
Test Mode	Mode 1:EUT power by AC adapter Mode 2:EUT power by PoE adapter via LAN cable
Worst Mode	<input checked="" type="checkbox"/> Mode 1 <input checked="" type="checkbox"/> Mode 2 <input type="checkbox"/> Mode 3 <input type="checkbox"/> Mode 4

Remark:

1. The worst mode was record in this test report.
2. EUT pre-scanned in three axis ,X ,Y, Z and two polarity, Horizontal and Vertical for radiated measurement. The worst case were recorded in this report.
3. For below 1G AC power line conducted emission and radiation emission were performed the EUT transmit at the highest output power channel as worse case.
4. EUT power supply had two ways (Adapter and PoE, both not for sale),that EUT pre-scanned two power supply at Radiated below 1G, and the worst case was Adapter mode. Therefore EUT used adapter mode for Radiated measurement above 1G and Conduction below 1G in test report.

3.3 EUT DUTY CYCLE

Duty Cycle				
Configuration	TX ON (ms)	TX ALL (ms)	Duty Cycle (%)	Duty Factor(dB)
BLE	0.47	0.66	71 %	1.47 dB

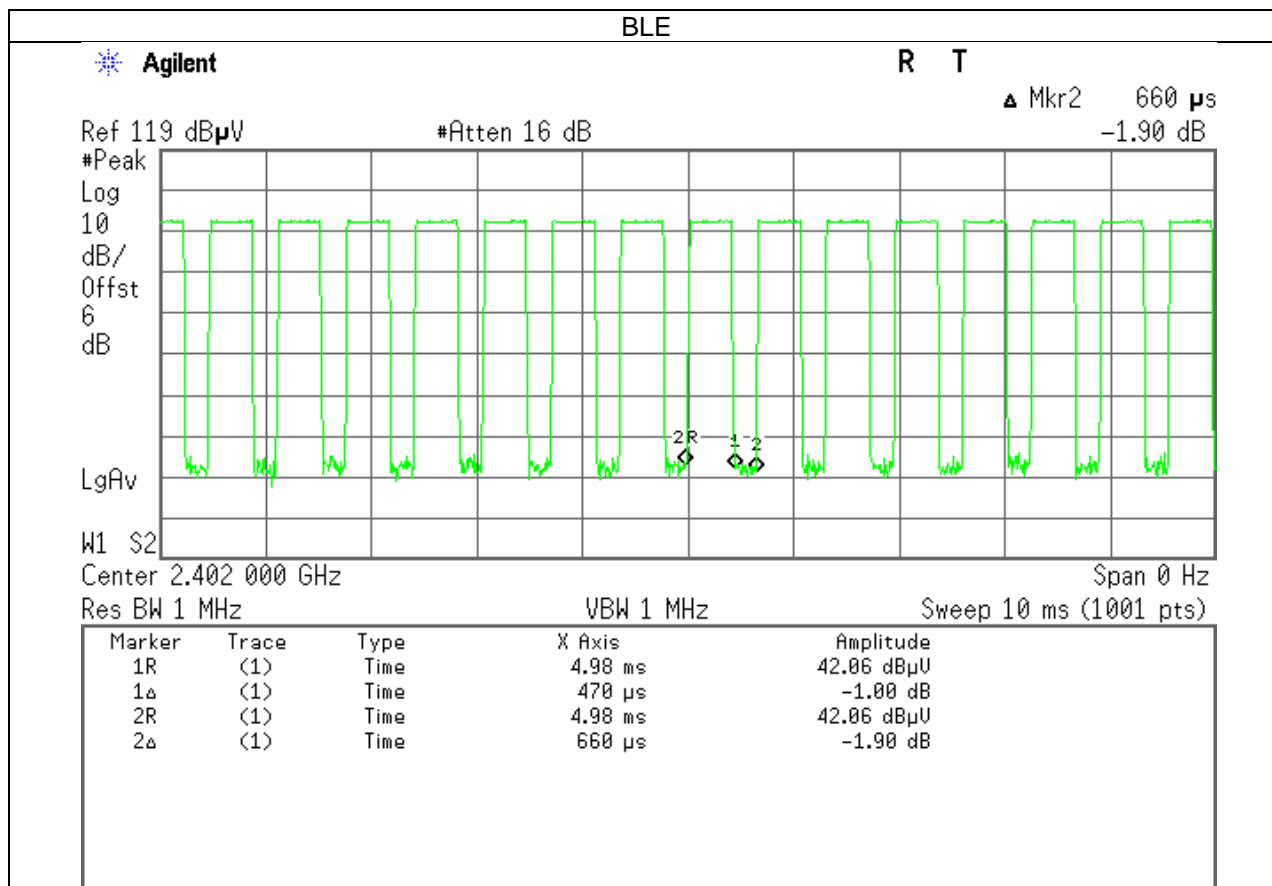

4. TEST RESULT

4.1 AC POWER LINE CONDUCTED EMISSION

4.1.1 Test Limit

According to §15.207(a)

Frequency Range (MHz)	Limits(dBμV)	
	Quasi-peak	Average
0.15 to 0.50	66 to 56*	56 to 46*
0.50 to 5	56	46
5 to 30	60	50

* Decreases with the logarithm of the frequency.

4.1.2 Test Procedure

Test method Refer as ANSI 63.10:2013 clause 6.2,

1. The EUT was placed on a non-conducted table, which is 0.8m above horizontal ground plane and 0.4m above vertical ground plane.
2. EUT connected to the line impedance stabilization network (LISN)
3. Receiver set RBW of 9kHz and Detector Peak, and note as quasi-peak and average.
4. Maximum procedure was performed on the six highest emissions to ensure EUT compliance.
5. Recorded Line for Neutral and Line.

4.1.3 Test Setup

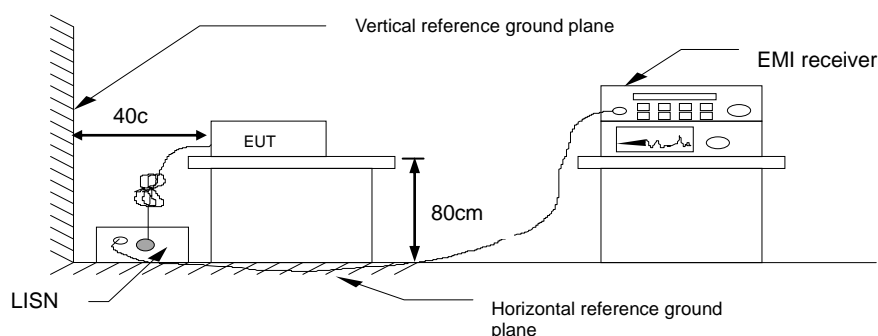

4.1.4 Test Result

Pass.

Test Data

Test Mode	Mode 1	Temp/Hum	24(°C)/ 50%RH
Test Voltage	120Vac / 60Hz	Test Date	Nov 09, 2016
Phase	Line	Test Engineer	Anderson Kuo

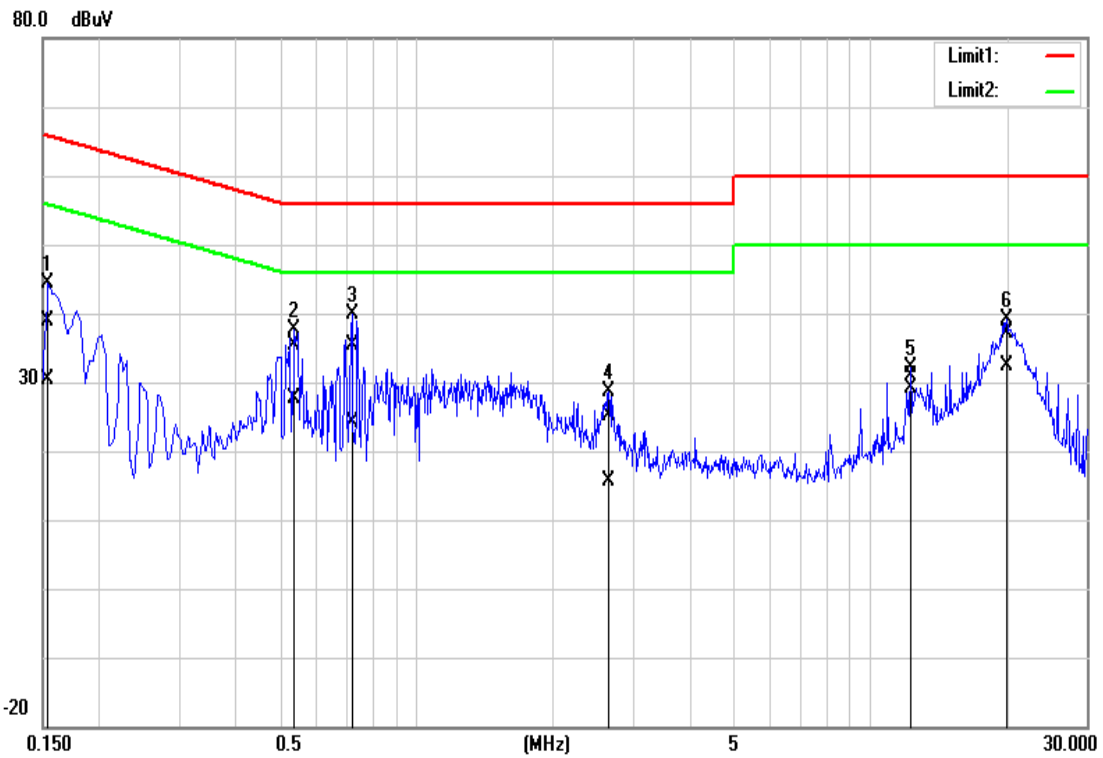

Frequency (MHz)	Quasi Peak reading (dBuV)	Average reading (dBuV)	Correction factor (dB)	Quasi Peak result (dBuV)	Average result (dBuV)	Quasi Peak limit (dBuV)	Average limit (dBuV)	Quasi Peak margin (dB)	Average margin (dB)	Remark
0.1540	29.19	20.66	9.71	38.90	30.37	65.78	55.78	-26.88	-25.41	Pass
0.5380	25.71	18.04	9.70	35.41	27.74	56.00	46.00	-20.59	-18.26	Pass
0.7220	25.74	14.45	9.71	35.45	24.16	56.00	46.00	-20.55	-21.84	Pass
2.6540	15.34	5.90	9.73	25.07	15.63	56.00	46.00	-30.93	-30.37	Pass
12.2740	21.04	19.40	9.81	30.85	29.21	60.00	50.00	-29.15	-20.79	Pass
20.0460	27.34	22.43	9.88	37.22	32.31	60.00	50.00	-22.78	-17.69	Pass

Test Mode	Mode 1	Temp/Hum	27(°C)/ 53%RH
Test Voltage	120Vac / 60Hz	Test Date	Nov 09, 2016
Phase	Neutral	Test Engineer	Anderson Kuo

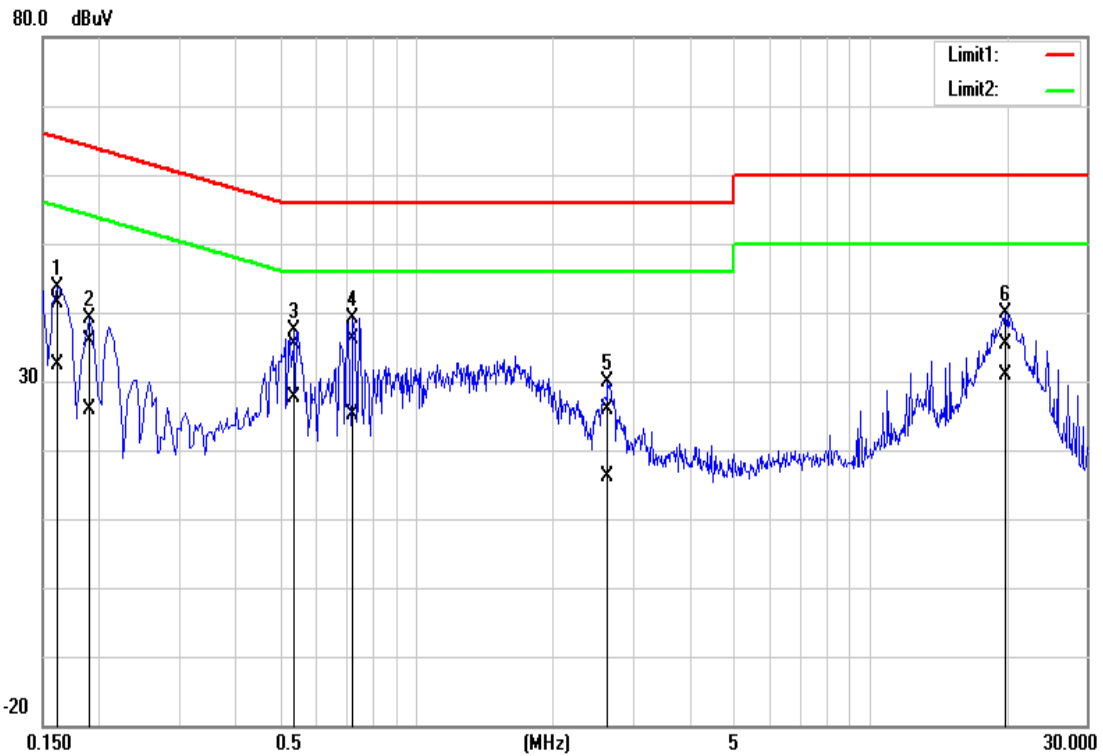

Frequency (MHz)	Quasi Peak reading (dBuV)	Average reading (dBuV)	Correction factor (dB)	Quasi Peak result (dBuV)	Average result (dBuV)	Quasi Peak limit (dBuV)	Average limit (dBuV)	Quasi Peak margin (dB)	Average margin (dB)	Remark
0.1620	31.71	22.67	9.78	41.49	32.45	65.36	55.36	-23.87	-22.91	Pass
0.1900	26.06	16.14	9.77	35.83	25.91	64.04	54.04	-28.21	-28.13	Pass
0.5380	25.59	17.98	9.76	35.35	27.74	56.00	46.00	-20.65	-18.26	Pass
0.7260	26.26	15.47	9.76	36.02	25.23	56.00	46.00	-19.98	-20.77	Pass
2.6460	16.05	6.32	9.80	25.85	16.12	56.00	46.00	-30.15	-29.88	Pass
19.8820	25.18	20.70	10.27	35.45	30.97	60.00	50.00	-24.55	-19.03	Pass

4.2 6DB BANDWIDTH AND OCCUPIED BANDWIDTH(99%)

4.2.1 Test Limit

According to §15.247(a)(2)

6 dB Bandwidth :

Limit	Shall be at least 500kHz
-------	--------------------------

Occupied Bandwidth(99%) : For reporting purposes only.

4.2.2 Test Procedure

Test method Refer as KDB 558074 D01 v03r05, Section 8.1 and ANSI 63.10:2013 clause 6.9.2,

1. The EUT RF output connected to the spectrum analyzer by RF cable.
2. Setting maximum power transmit of EUT
3. SA set RBW = 100kHz, VBW = 300kHz and Detector = Peak, to measurement 6 dB Bandwidth and 99% Bandwidth.
4. Measure and record the result of 6 dB Bandwidth and 99% Bandwidth. in the test report.

4.2.3 Test Setup

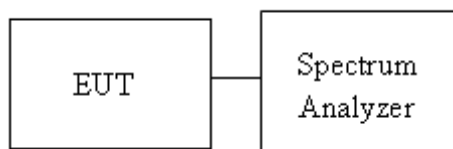

4.2.4 Test Result

Test mode: BLE mode / 2402-2480 MHz				
Channel	Frequency (MHz)	OBW (99%) (MHz)	6dB BW (MHz)	6dB limit (kHz)
Low	2402	1.0463	0.7033	>500
Mid	2440	1.0419	0.6946	
High	2480	1.0463	0.7033	

Test Data

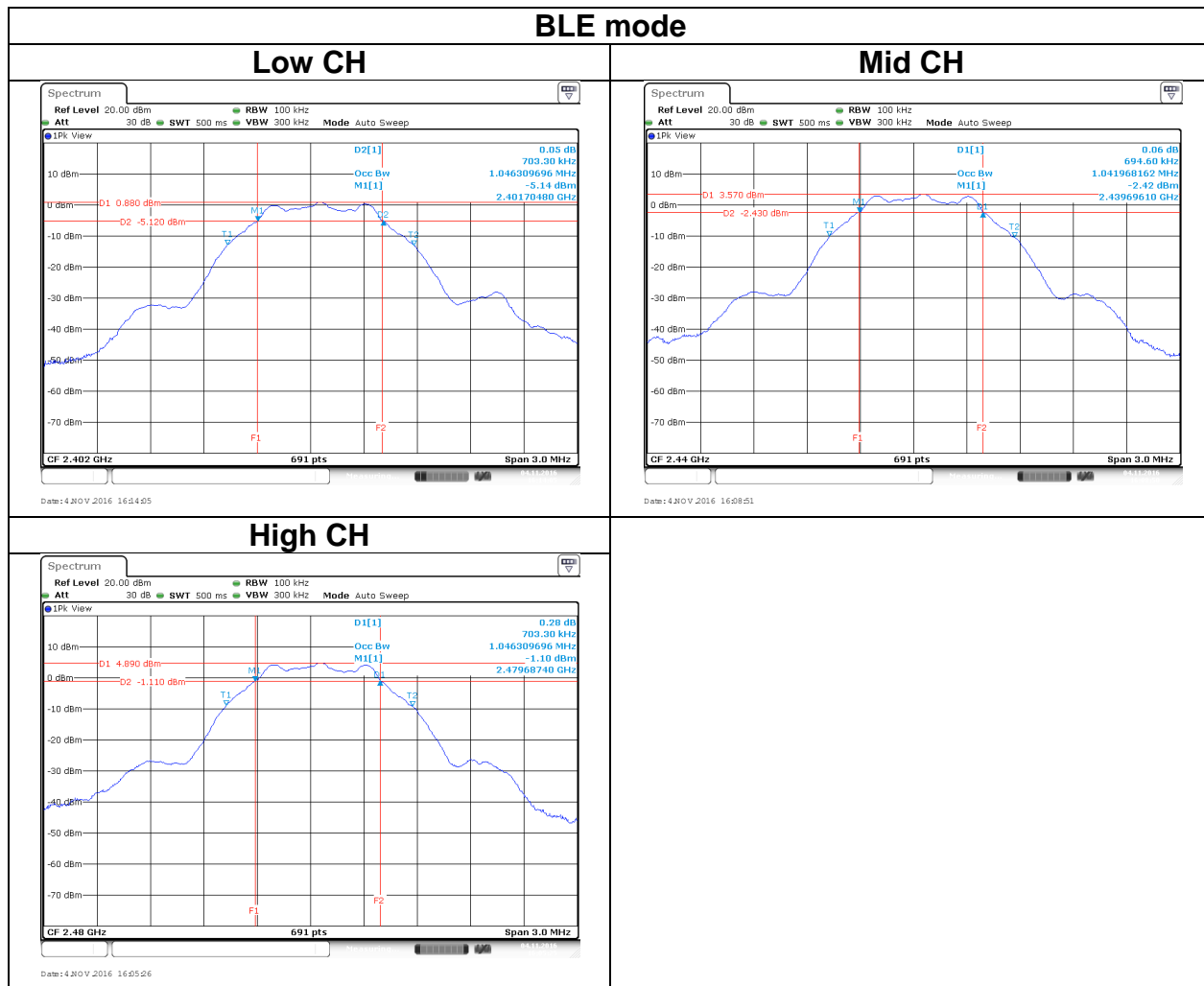

4.3 OUTPUT POWER MEASUREMENT

4.3.1 Test Limit

According to §15.247(b)

Peak output power :

For systems using digital modulation in the 2400-2483.5 MHz, and 5725-5850 MHz bands: 1 Watt(30 dBm), base on the use of antennas with directional gain not exceed 6 dBi If transmitting antennas of directional gain greater than 6dBi are used the peak output power the conducted output power from the intentional radiator shall be reduced by the amount in dB that the directional gain of the antenna exceeds 6 dBi. In case of point-to-point operation, the limit has to be reduced by 1dB for every 3 dB that the directional gain of the antenna exceeds 6 dBi.

Limit	<input checked="" type="checkbox"/> Antenna not exceed 6 dBi : 30dBm <input type="checkbox"/> Antenna with DG greater than 6 dBi : [Limit = 30 – (DG – 6)] <input type="checkbox"/> Point-to-point operation :
-------	--------------------------------------------------------------------------------------------------------------------------------------------------------------------------------------------------------------------------

Average output power : For reporting purposes only.

4.3.2 Test Procedure

Test method Refer as KDB 558074 D01 v03r05, Section 9.1.2.

1. The EUT RF output connected to the power meter by RF cable.
2. Setting maximum power transmit of EUT.
3. The path loss was compensated to the results for each measurement.
4. Measure and record the result of Peak output power and Average output power. in the test report.

4.3.3 Test Setup

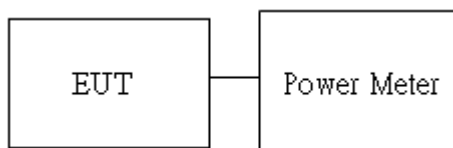

4.3.4 Test Result

Peak output power :

BT LE Mode					
Config.	CH	Freq. (MHz)	PK Power (dBm)	PK Power (W)	FCCLimit (dBm)
BLE Data rate: 1Mbps	0	2402	-1.24	0.0008	30
	19	2440	1.55	0.0014	
	39	2480	3.49	0.0022	

Average output power :

BT LE Mode			
Config.	CH	Freq. (MHz)	Average Power (dBm)
BLE Data rate: 1Mbps	0	2402	-1.69
	19	2440	1.28
	39	2480	3.26

4.4 POWER SPECTRAL DENSITY

4.4.1 Test Limit

According to §15.247(e)

For digitally modulated systems, the power spectral density conducted from the intentional radiator to the antenna shall not be greater than 8 dBm in any 3 kHz band during any time interval of continuous transmission.

Limit	<input checked="" type="checkbox"/> Antenna not exceed 6 dBi : 8dBm <input type="checkbox"/> Antenna with DG greater than 6 dBi : [Limit = 8 – (DG – 6)] <input type="checkbox"/> Point-to-point operation :
-------	------------------------------------------------------------------------------------------------------------------------------------------------------------------------------------------------------------------------

4.4.2 Test Procedure

Test method Refer as KDB 558074 D01 v03r05, Section 10.2

1. The EUT RF output connected to the spectrum analyzer by RF cable.
2. Setting maximum power transmit of EUT
3. SA set RBW = 3kHz, VBW = 30kHz, Span = 1.5 times DTS Bandwidth (6 dB BW), Detector = Peak, Sweep Time = Auto and Trace = Max hold.
4. The path loss and Duty Factor were compensated to the results for each measurement by SA.
5. Mark the maximum level.
6. Measure and record the result of power spectral density. in the test report.

4.4.3 Test Setup

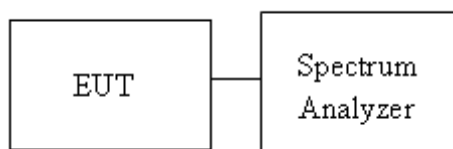

4.4.4 Test Result

Test mode: BLE mode / 2402-2480 MHz			
Channel	Frequency (MHz)	PPSD (dBm)	IC/FCC limit (dBm)
Low	2402	-13.85	8
Mid	2440	-11.20	
High	2480	-9.75	

Test Data

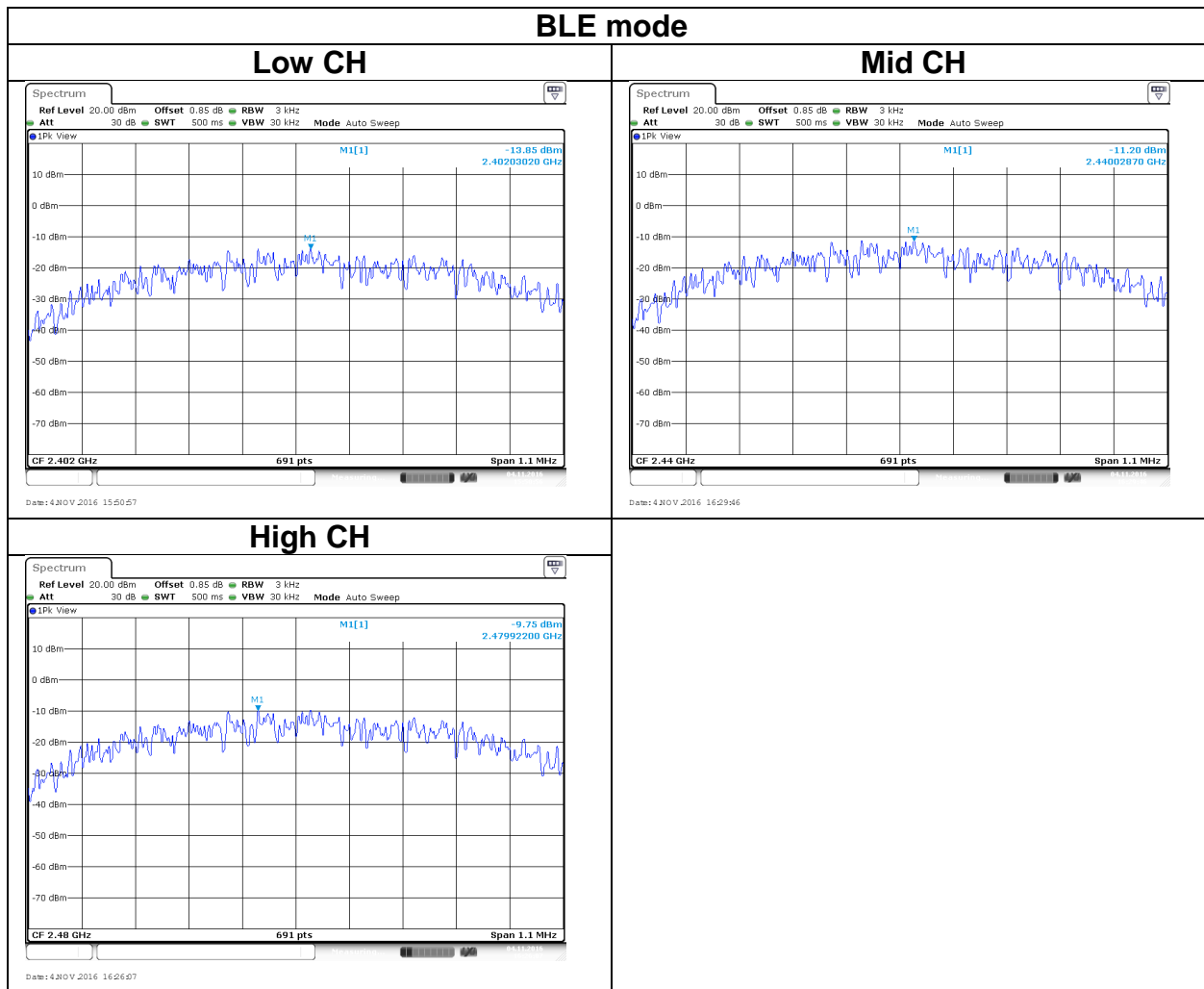

4.5 CONDUCTED BANDEDGE AND SPURIOUS EMISSION

4.5.1 Test Limit

According to §15.247(d)

In any 100 kHz bandwidth outside the authorized frequency band,

Non-restricted bands shall be attenuated at least 20 dB/30 dB relative to the maximum PSD level in 100 kHz by RF conducted or a radiated measurement which fall in the restricted bands, as defined in §15.205(a), must also comply with the radiated emission limits specified in §15.209(a).

4.5.2 Test Procedure

Test method Refer as KDB 558074 D01 v03r05, Section 11.

1. EUT RF output port connected to the SA by RF cable, and the path loss was compensated to result.
2. SA setting, RBW=100kHz, VBW=300kHz, Detector=Peak, Trace mode = max hold, SWT = Auto.
3. In any 100 kHz bandwidth outside the authorized frequency band, shall be attenuated at least 20 dB relative to the maximum in-band peak PSD level in 100 kHz when conducted power procedure is used. If the transmitter complies with the conducted power limits based on the use of RMS averaging over a time interval, the attenuation required under this paragraph shall be 30 dB instead of 20 dB.

4.5.3 Test Setup

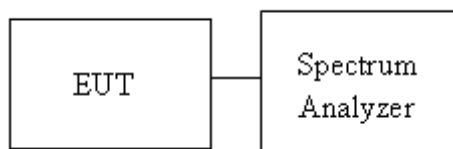

4.5.4 Test Result

Test Data

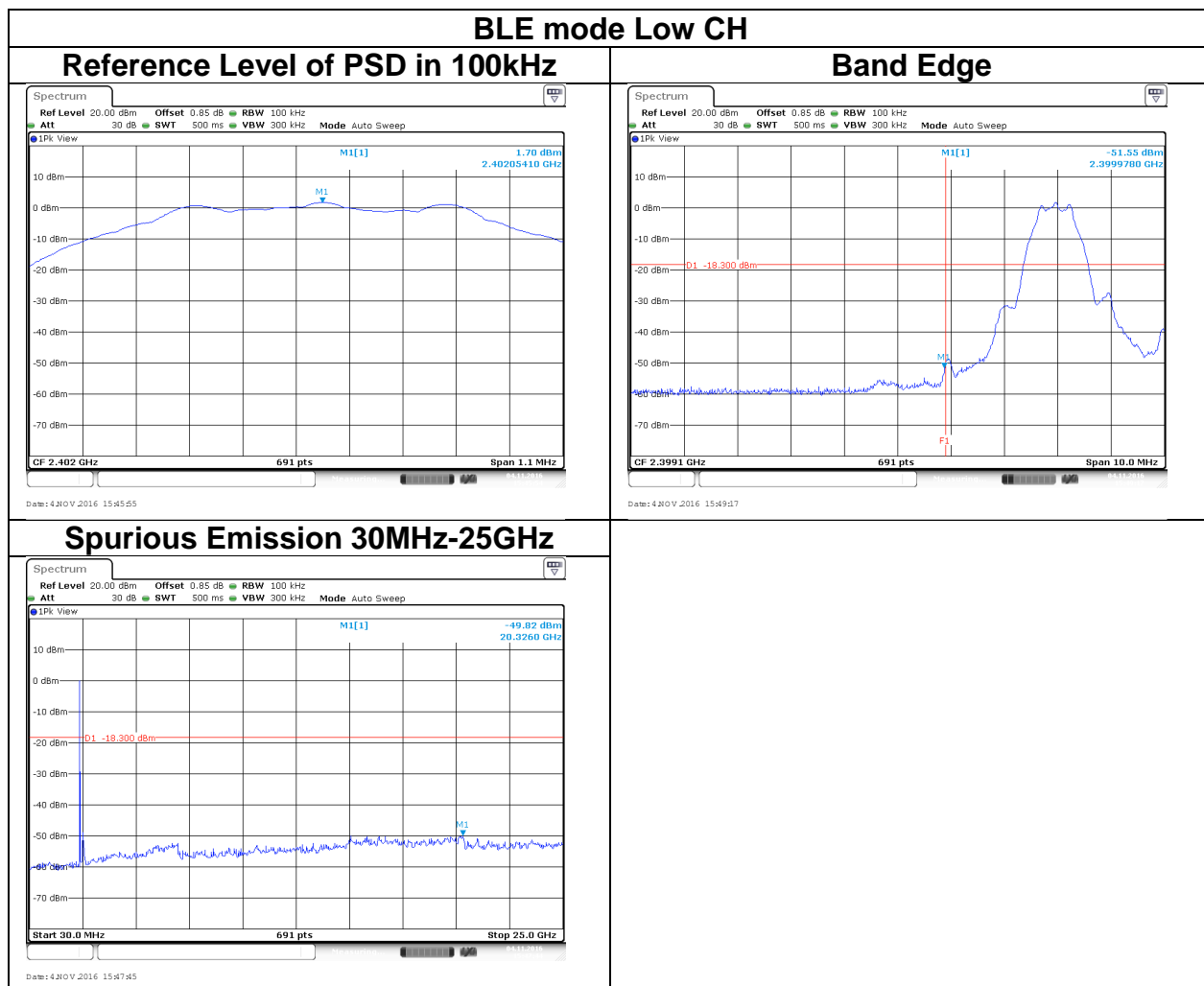

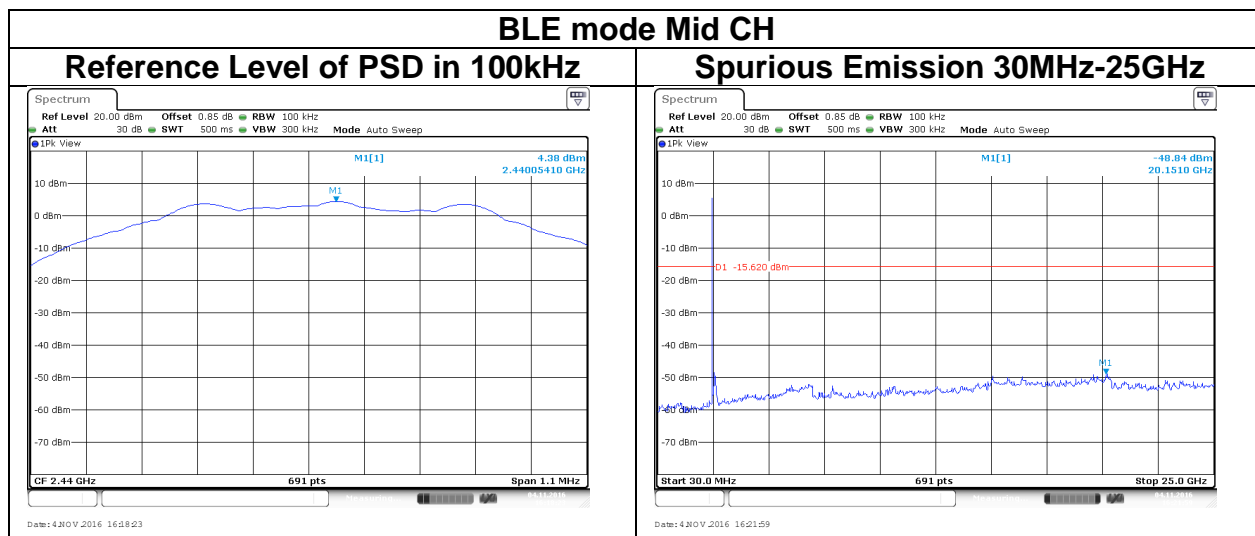

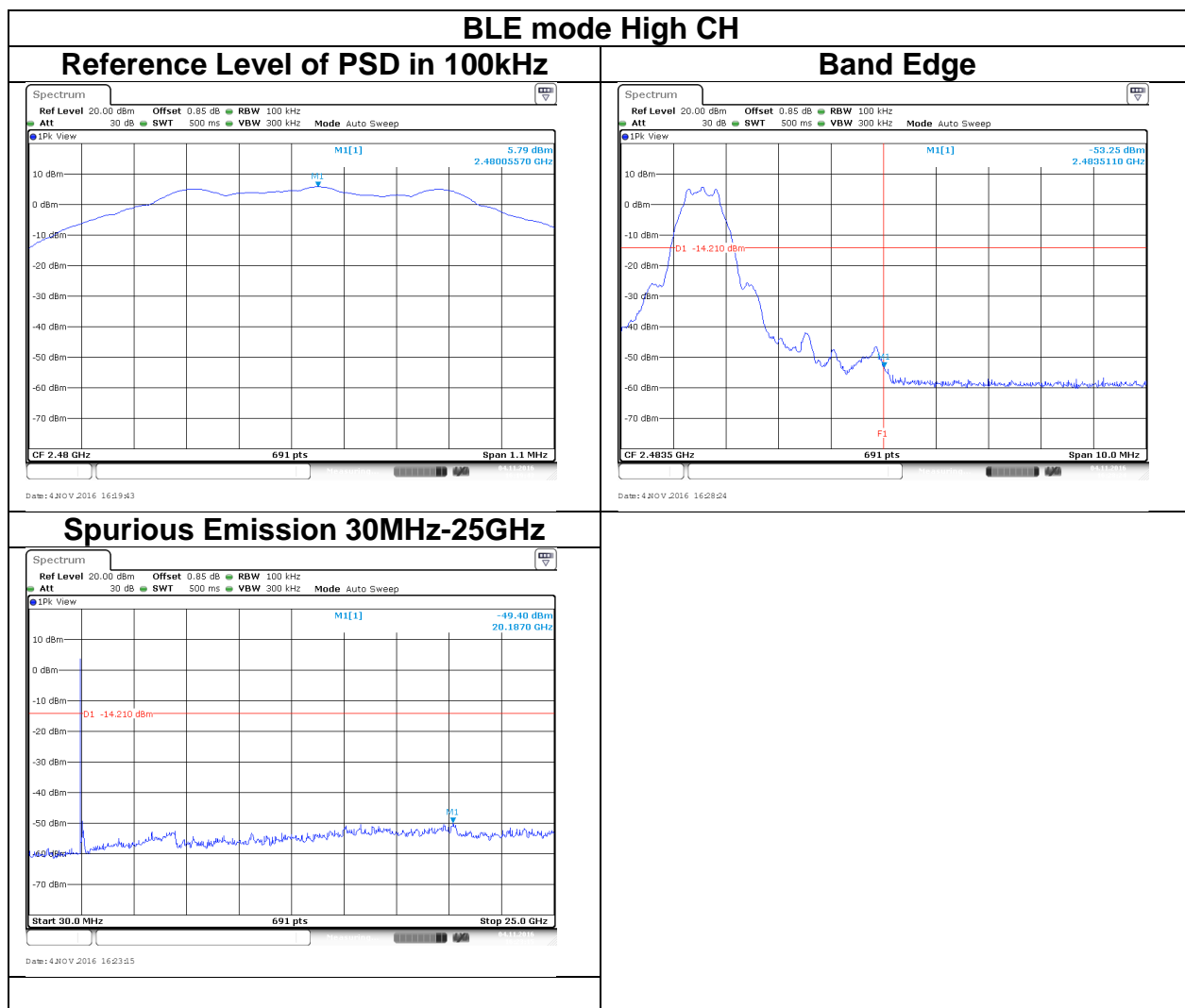

4.6 RADIATION BANDEGE AND SPURIOUS EMISSION

4.6.1 Test Limit

FCC according to §15.247(d), §15.209 and §15.205,

In any 100 kHz bandwidth outside the authorized frequency band, all harmonic and spurious must be least 20 dB below the highest emission level with the authorized frequency band. Radiation emission which fall in the restricted bands must also follow the FCC section 15.209 as below limit in table.

Below 30 MHz

Frequency	Field Strength (microvolts/m)	Magnetic H-Field (microamperes/m)	Measurement Distance (metres)
9-490 kHz	2,400/F (F in kHz)	2,400/F (F in kHz)	300
490-1,705 kHz	24,000/F (F in kHz)	24,000/F (F in kHz)	30
1.705-30 MHz	30	N/A	30

Above 30 MHz

Frequency (MHz)	Field Strength microvolts/m at 3 metres (watts, e.i.r.p.)	
	Transmitters	Receivers
30-88	100 (3 nW)	100 (3 nW)
88-216	150 (6.8 nW)	150 (6.8 nW)
216-960	200 (12 nW)	200 (12 nW)
Above 960	500 (75 nW)	500 (75 nW)

4.6.2 Test Procedure

Test method Refer as KDB 558074 D01 v03r05, Section 12.1.

1. The EUT is placed on a turntable, Above 1 GHz is 1.5m and below 1 GHz is 0.8m above ground plane. The EUT Configured un accordance with ANSI C63.10, and the EUT set in a continuous mode.
2. The turntable shall be rotated for 360 degrees to determine the position of maximum emission level. And EUT is set 3m away from the receiving antenna, which is scanned from 1m to 4m above the ground plane to find out the highest emissions. Measurement are made polarized in both the vertical and the horizontal positions with antenna.
3. Span shall wide enough to full capture the emission measured. The SA from 30MHz to 26.5GHz set to the low, Mid and High channels with the EUT transmit.
5. The SA setting following :
 - (1) Below 1G : RBW = 100kHz, VBW \geq 3 RBW, Sweep = Auto, Detector = Peak, Trace = Max hold.
 - (2) Above 1G :
 - (2.1) For Peak measurement : RBW = 1MHz, VBW \geq 3 RBW, Sweep = Auto, Detector = Peak, Trace = Max hold.
 - (2.2) For Average measurement : RBW = 1MHz, VBW
 - If Duty Cycle \geq 98%, VBW=10Hz.
 - If Duty Cycle < 98%, VBW=1/T.

Configuration	Duty Cycle (%)	VBW
BLE	71.2%	2.12 kHz

4.6.3 Test Setup

9kHz ~ 30MHz

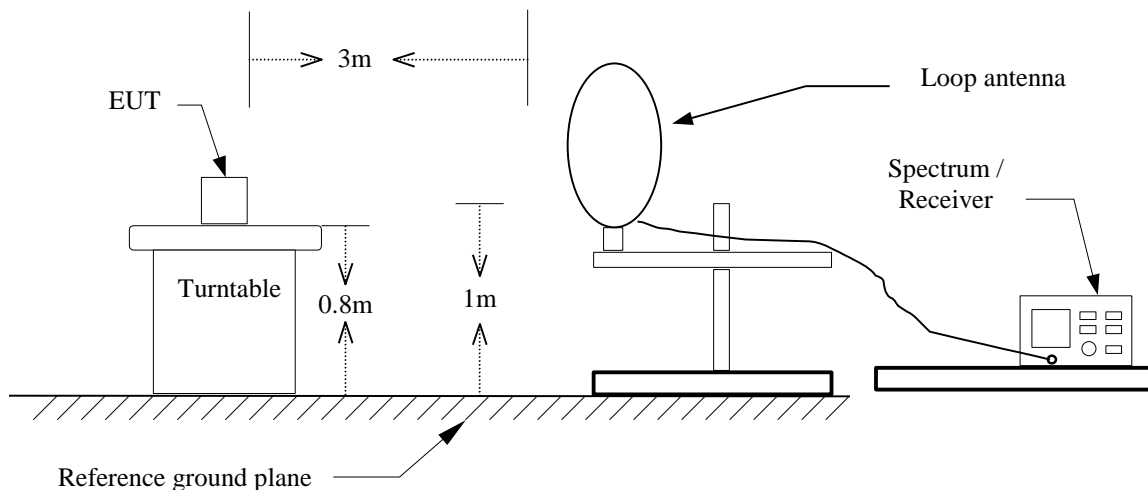

30MHz ~ 1GHz

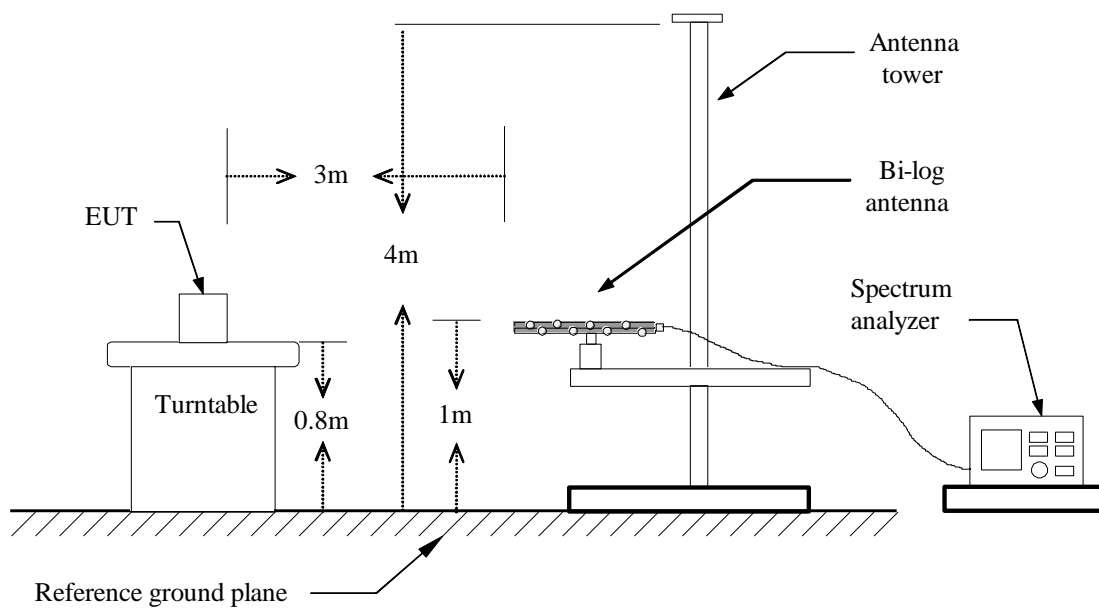

Above 1 GHz

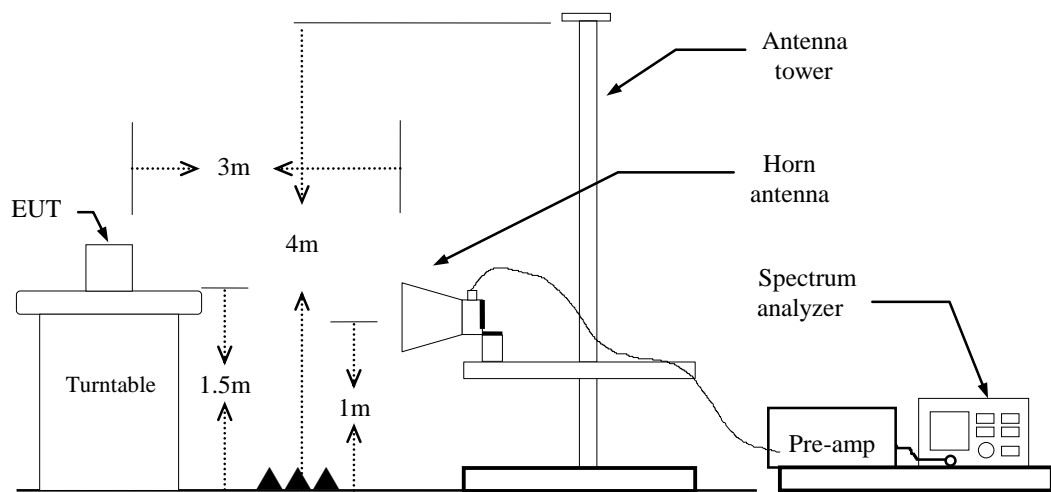

4.6.4 Test Result

Band Edge Test Data

Test Mode	BLE Low CH	Temp/Hum	27(°C)/ 53%RH
Test Item	Band Edge	Test Date	Nov 03, 2016
Polarize	Horizontal	Test Engineer	Dennis Li
Detector	Peak	Test Voltage	120Vac / 60Hz

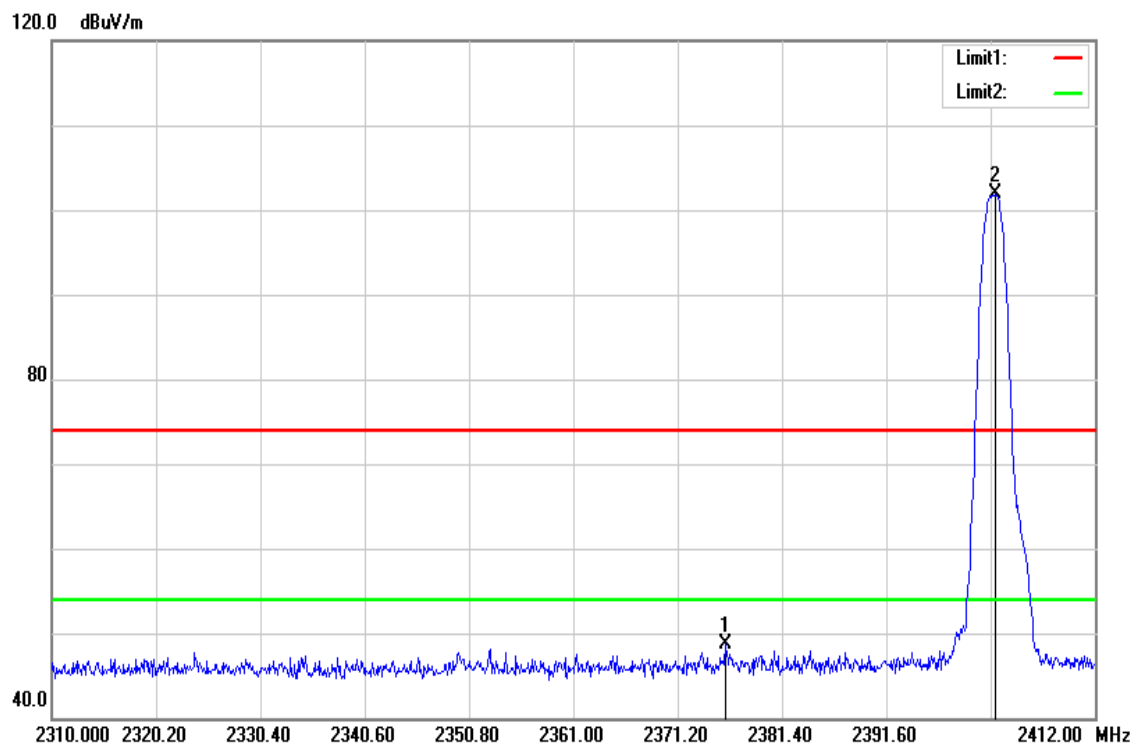

Frequency (MHz)	Reading (dBuV)	Correct Factor (dB/m)	Result (dBuV/m)	Limit (dBuV/m)	Margin (dB)	Remark
2375.892	51.24	-2.61	48.63	74.00	-25.37	peak
2402.310	104.25	-2.41	101.84	-	-	peak

Test Mode	BLE Low CH	Temp/Hum	27(°C)/ 53%RH
Test Item	Band Edge	Test Date	Nov 03, 2016
Polarize	Horizontal	Test Engineer	Dennis Li
Detector	Average	Test Voltage	120Vac / 60Hz

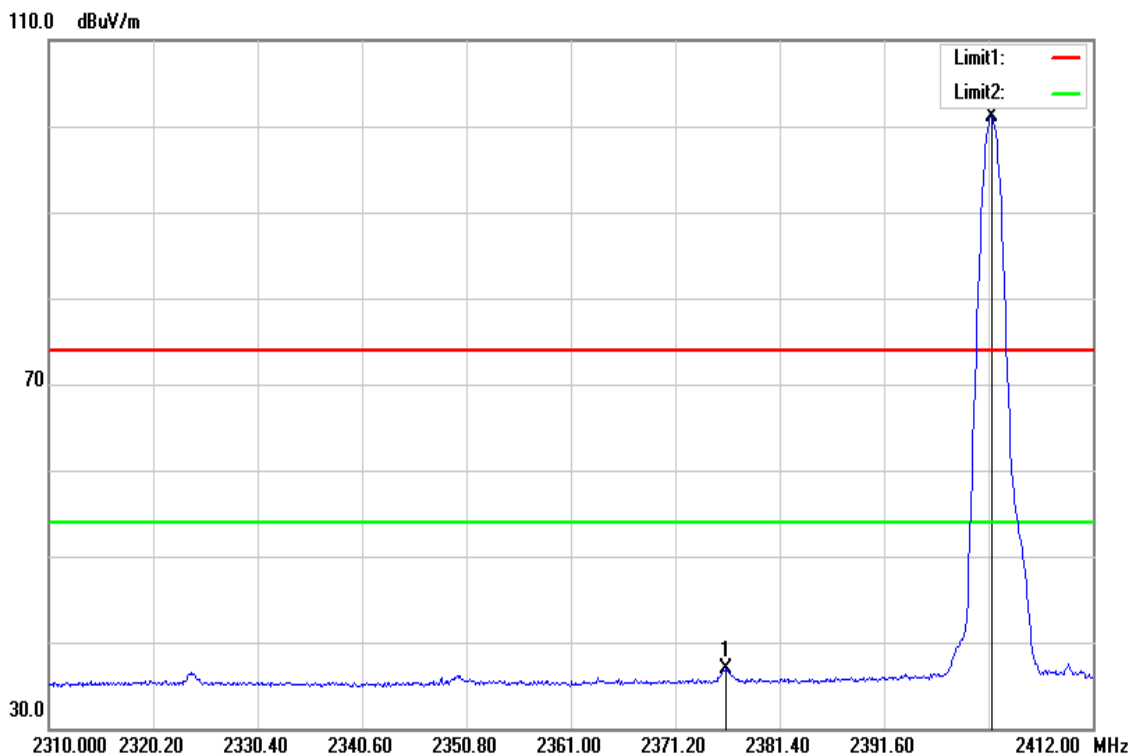

Frequency (MHz)	Reading (dBuV)	Correct Factor (dB/m)	Result (dBuV/m)	Limit (dBuV/m)	Margin (dB)	Remark
2376.198	39.58	-2.61	36.97	54.00	-17.03	AVG
2402.106	103.51	-2.41	101.10	-	-	AVG

Test Mode	BLE High CH	Temp/Hum	27(°C)/ 53%RH
Test Item	Band Edge	Test Date	Nov 03, 2016
Polarize	Horizontal	Test Engineer	Dennis Li
Detector	Peak	Test Voltage	120Vac / 60Hz

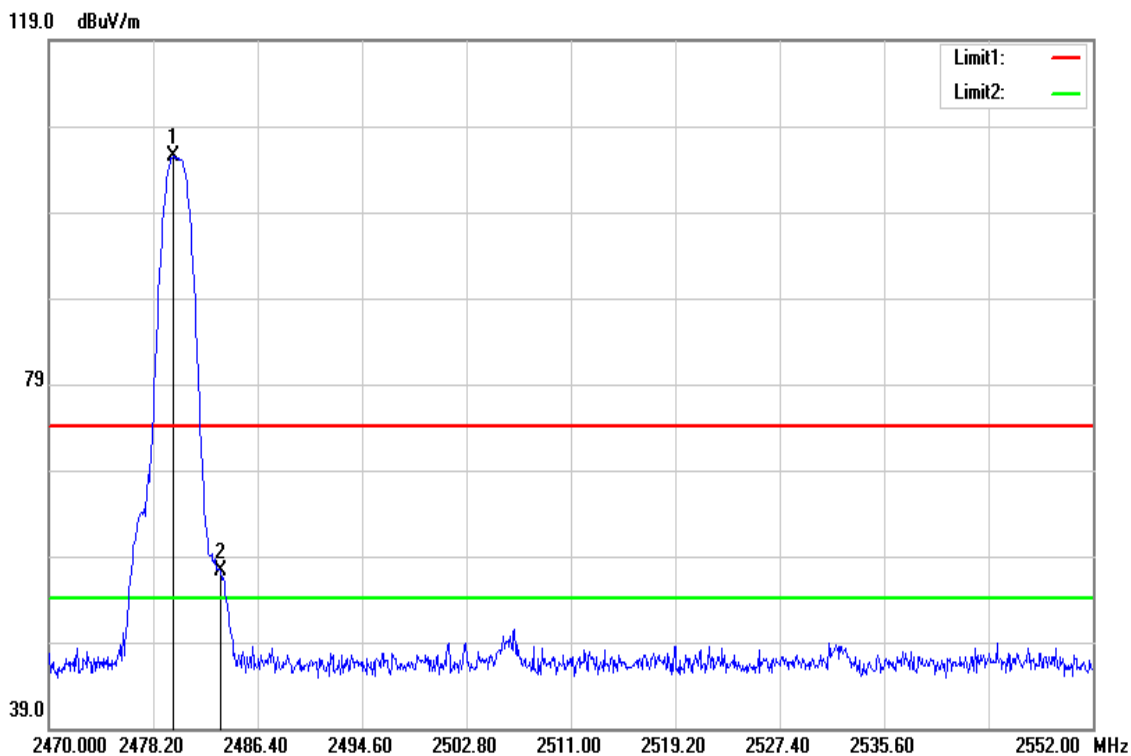

Frequency (MHz)	Reading (dBuV)	Correct Factor (dB/m)	Result (dBuV/m)	Limit (dBuV/m)	Margin (dB)	Remark
2479.758	107.43	-2.03	105.40	-	-	peak
2483.530	59.19	-1.99	57.20	74.00	-16.80	peak

Test Mode	BLE High CH	Temp/Hum	27(°C)/ 53%RH
Test Item	Band Edge	Test Date	Nov 03, 2016
Polarize	Horizontal	Test Engineer	Dennis Li
Detector	Average	Test Voltage	120Vac / 60Hz

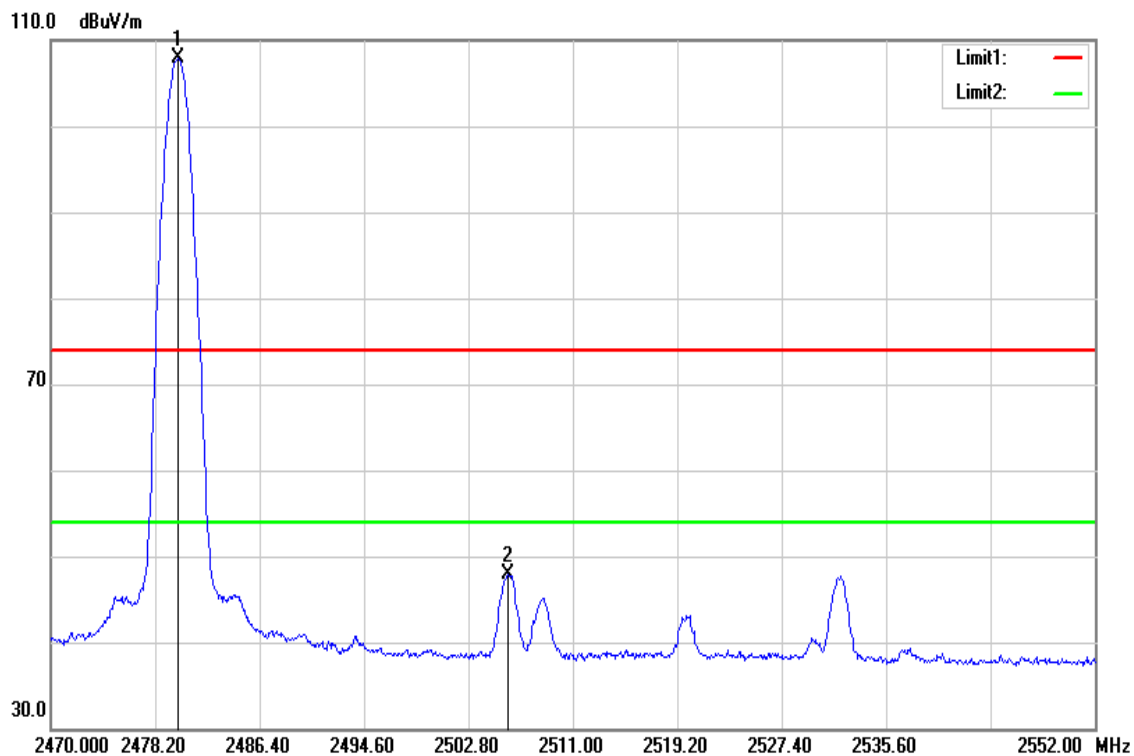

Frequency (MHz)	Reading (dBuV)	Correct Factor (dB/m)	Result (dBuV/m)	Limit (dBuV/m)	Margin (dB)	Remark
2480.086	106.22	-2.03	104.19	-	-	AVG
2483.530	47.39	-1.99	45.40	54.00	-8.60	AVG

Below 1G Test Data

Test Mode	Mode 1	Temp/Hum	27(°C)/ 53%RH
Test Item	30MHz-1GHz	Test Date	Nov 03, 2016
Polarize	Vertical	Test Engineer	Dennis Li
Detector	Peak and Qusi-peak	Test Voltage	120Vac / 60Hz

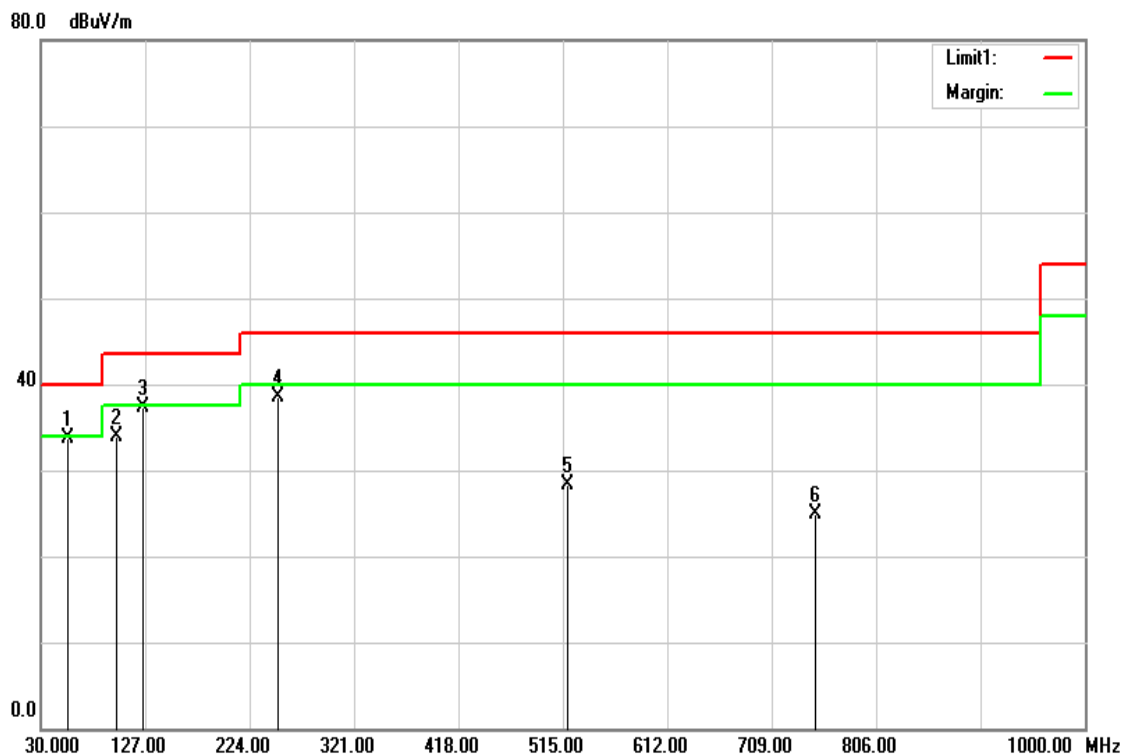

Frequency (MHz)	Reading (dBuV)	Correct Factor (dB/m)	Result (dBuV/m)	Limit (dBuV/m)	Margin (dB)	Remark
55.2200	55.34	-21.61	33.73	40.00	-6.27	peak
99.8400	53.04	-19.07	33.97	43.50	-9.53	peak
125.0600	52.85	-15.57	37.28	43.50	-6.22	peak
250.1900	54.80	-16.27	38.53	46.00	-7.47	peak
519.8500	37.20	-8.94	28.26	46.00	-17.74	peak
749.7400	29.93	-4.93	25.00	46.00	-21.00	peak

Test Mode	Mode 1	Temp/Hum	27(°C)/ 53%RH
Test Item	30MHz-1GHz	Test Date	Nov 03, 2016
Polarize	Horizontal	Test Engineer	Dennis Li
Detector	Peak and Qusi-peak	Test Voltage	120Vac / 60Hz

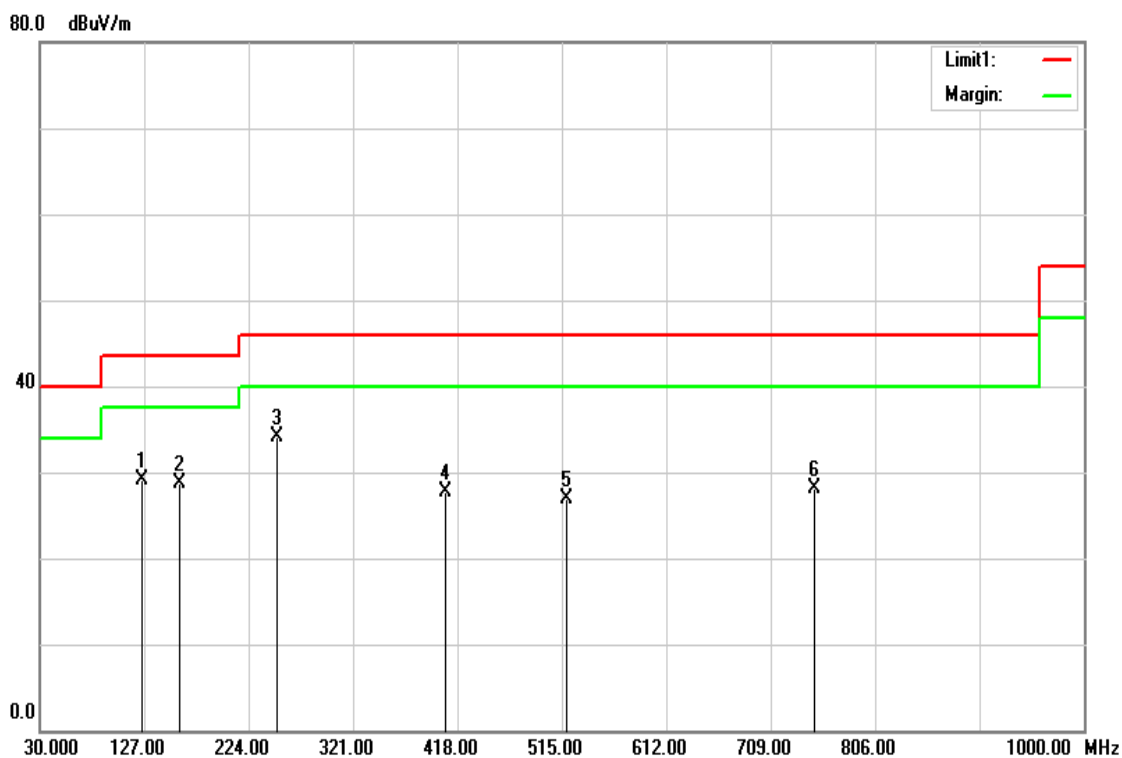

Frequency (MHz)	Reading (dBuV)	Correct Factor (dB/m)	Result (dBuV/m)	Limit (dBuV/m)	Margin (dB)	Remark
125.0600	44.76	-15.57	29.19	43.50	-14.31	peak
159.9800	44.98	-16.36	28.62	43.50	-14.88	peak
250.1900	50.40	-16.27	34.13	46.00	-11.87	peak
407.3300	39.13	-11.48	27.65	46.00	-18.35	peak
519.8500	35.87	-8.94	26.93	46.00	-19.07	peak
749.7400	32.95	-4.93	28.02	46.00	-17.98	peak

Test Mode	Mode 2	Temp/Hum	27(°C)/ 53%RH
Test Item	30MHz-1GHz	Test Date	Nov 03, 2016
Polarize	Vertical	Test Engineer	Dennis Li
Detector	Peak and Qusi-peak	Test Voltage	120Vac / 60Hz

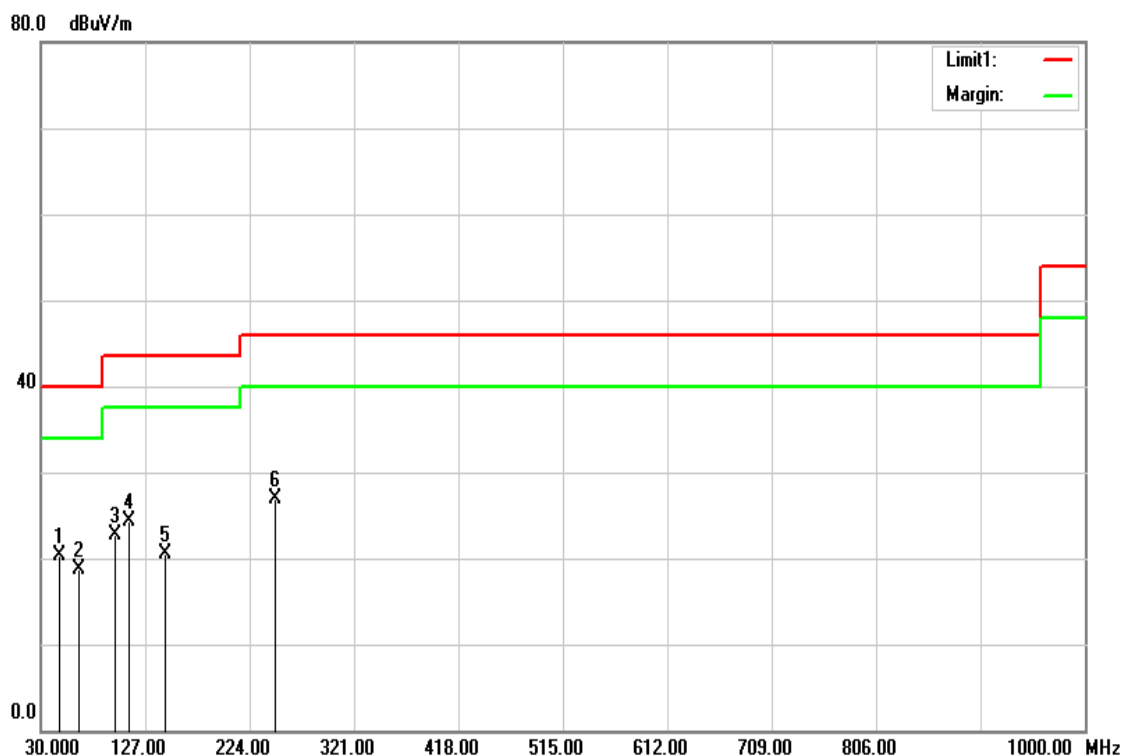

Frequency (MHz)	Reading (dBuV)	Correct Factor (dB/m)	Result (dBuV/m)	Limit (dBuV/m)	Margin (dB)	Remark
47.4600	39.94	-19.61	20.33	40.00	-19.67	peak
64.9200	40.17	-21.43	18.74	40.00	-21.26	peak
98.8700	42.11	-19.31	22.80	43.50	-20.70	peak
111.4800	41.38	-17.00	24.38	43.50	-19.12	peak
145.4300	36.50	-15.94	20.56	43.50	-22.94	peak
248.2500	43.27	-16.32	26.95	46.00	-19.05	peak

Test Mode	Mode 2	Temp/Hum	27(°C)/ 53%RH
Test Item	30MHz-1GHz	Test Date	Nov 03, 2016
Polarize	Horizontal	Test Engineer	Dennis Li
Detector	Peak and Qusi-peak	Test Voltage	120Vac / 60Hz

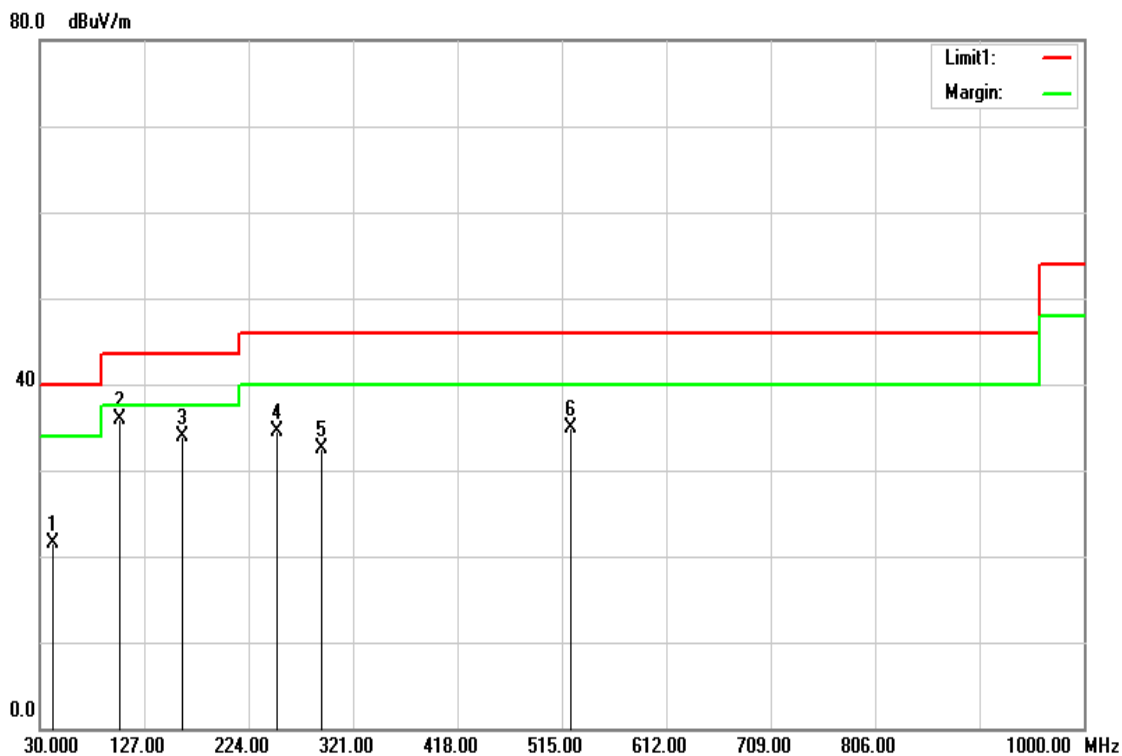

Frequency (MHz)	Reading (dBuV)	Correct Factor (dB/m)	Result (dBuV/m)	Limit (dBuV/m)	Margin (dB)	Remark
42.6100	38.39	-16.84	21.55	40.00	-18.45	peak
104.6900	54.15	-18.20	35.95	43.50	-7.55	peak
161.9200	50.29	-16.45	33.84	43.50	-9.66	peak
250.1900	50.77	-16.27	34.50	46.00	-11.50	peak
291.9000	46.90	-14.39	32.51	46.00	-13.49	peak
523.7300	43.87	-8.88	34.99	46.00	-11.01	peak

Above 1G Test Data

Test Mode	BLE Low CH	Temp/Hum	27(°C)/ 53%RH
Test Item	Harmonic	Test Date	Nov 03, 2016
Polarize	Vertical	Test Engineer	Dennis Li
Detector	Peak and Average	Test Voltage	120Vac / 60Hz

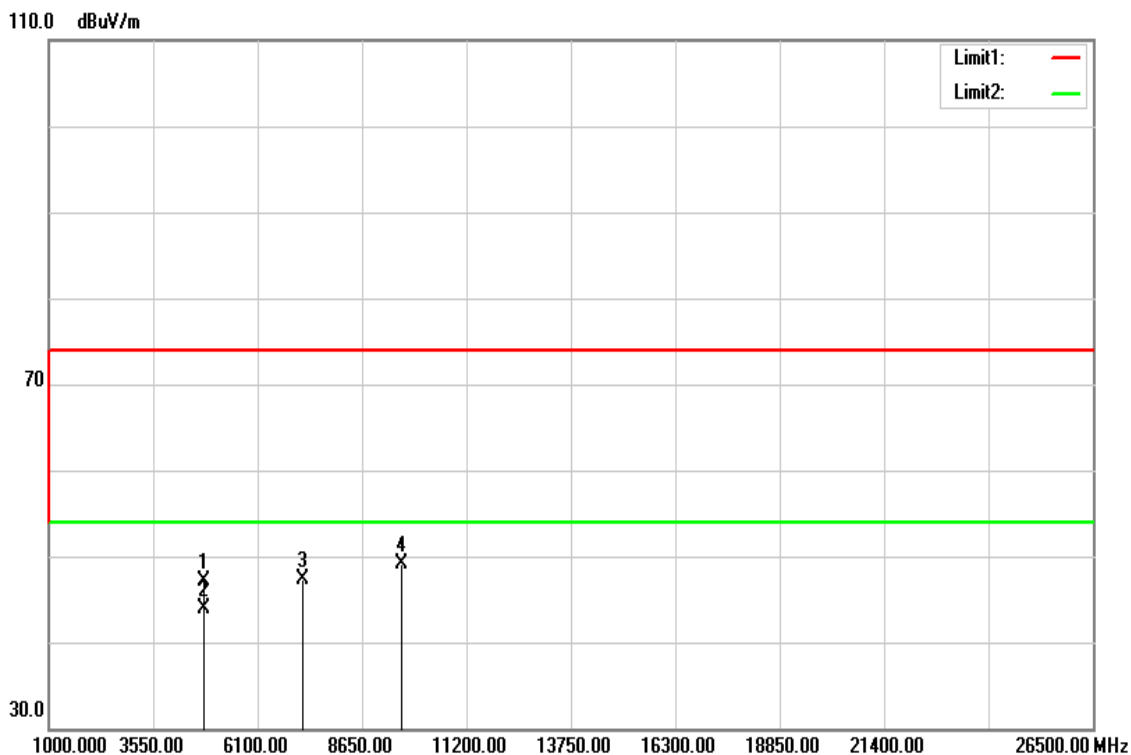

Frequency (MHz)	Reading (dBuV)	Correct Factor (dB/m)	Result (dBuV/m)	Limit (dBuV/m)	Margin (dB)	Remark
4804.000	42.13	5.04	47.17	74.00	-26.83	peak
4804.000	38.85	5.04	43.89	54.00	-10.11	AVG
7206.000	34.68	12.62	47.30	74.00	-26.70	peak
9608.000	31.52	17.60	49.12	74.00	-24.88	peak

Remark:

1. Measuring frequencies from 1 GHz to the 10th harmonic of highest fundamental frequency.
2. For above 1GHz, the EUT peak value was under average limit, therefore the Average value compliance with the average limit

Test Mode	BLE Low CH	Temp/Hum	27(°C)/ 53%RH
Test Item	Harmonic	Test Date	Nov 03, 2016
Polarize	Horizontal	Test Engineer	Dennis Li
Detector	Peak and Average	Test Voltage	120Vac / 60Hz

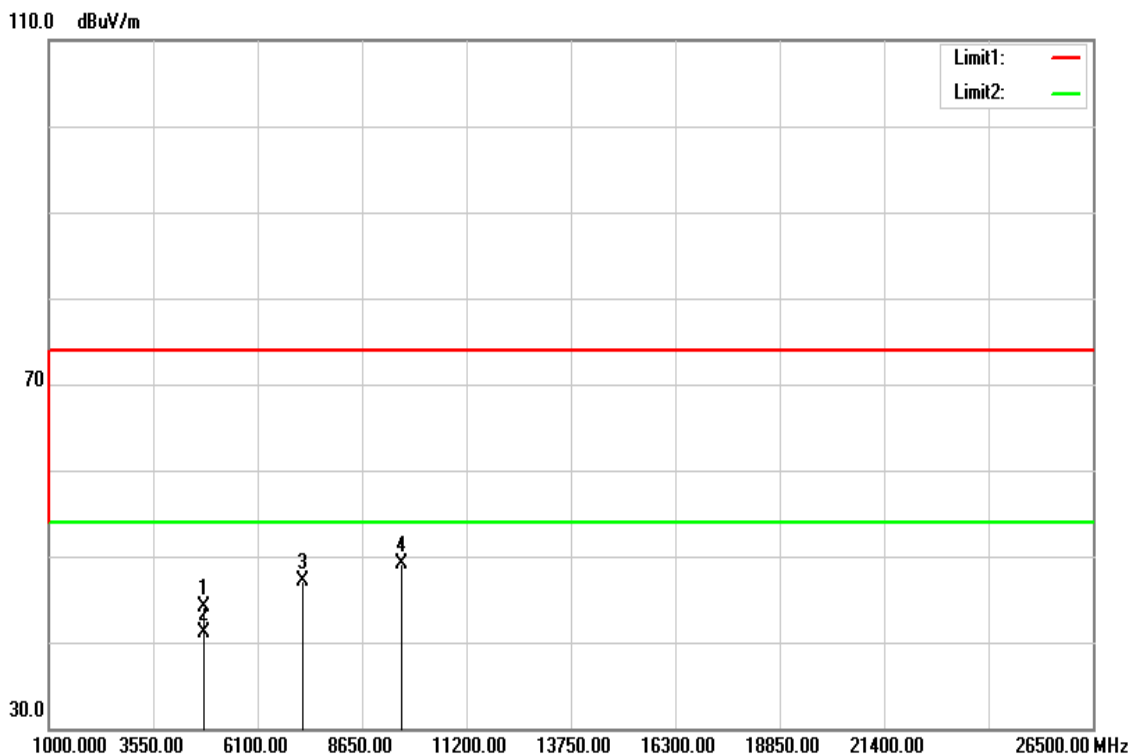

Frequency (MHz)	Reading (dBuV)	Correct Factor (dB/m)	Result (dBuV/m)	Limit (dBuV/m)	Margin (dB)	Remark
4804.000	39.09	5.04	44.13	74.00	-29.87	peak
4804.000	35.98	5.04	41.02	54.00	-12.98	AVG
7206.000	34.40	12.62	47.02	74.00	-26.98	peak
9608.000	31.41	17.60	49.01	74.00	-24.99	peak

Remark:

1. Measuring frequencies from 1 GHz to the 10th harmonic of highest fundamental frequency.
2. For above 1GHz, the EUT peak value was under average limit, therefore the Average value compliance with the average limit

Test Mode	BLE Mid CH	Temp/Hum	27(°C)/ 53%RH
Test Item	Harmonic	Test Date	Nov 03, 2016
Polarize	Vertical	Test Engineer	Dennis Li
Detector	Peak and Average	Test Voltage	120Vac / 60Hz

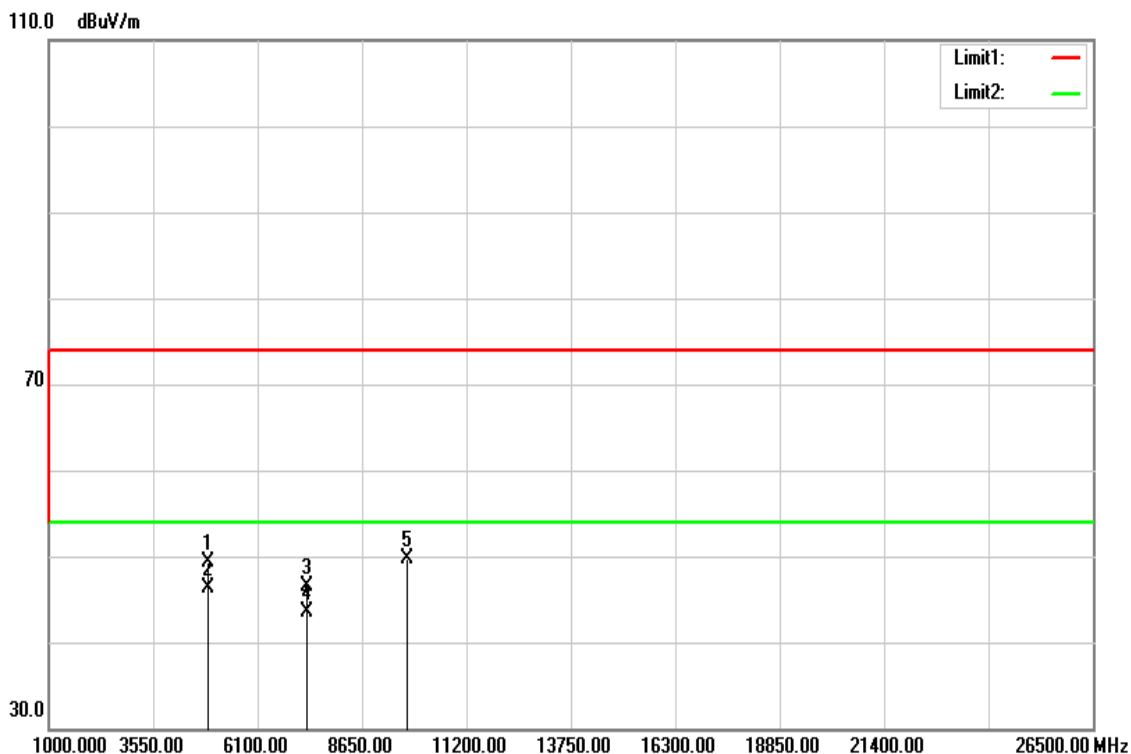

Frequency (MHz)	Reading (dBuV)	Correct Factor (dB/m)	Result (dBuV/m)	Limit (dBuV/m)	Margin (dB)	Remark
4880.000	44.04	5.25	49.29	74.00	-24.71	peak
4880.000	41.10	5.25	46.35	54.00	-7.65	AVG
7320.000	33.51	12.97	46.48	74.00	-27.52	peak
7320.000	30.44	12.97	43.41	54.00	-10.59	AVG
9760.000	32.18	17.60	49.78	74.00	-24.22	peak

Remark:

1. Measuring frequencies from 1 GHz to the 10th harmonic of highest fundamental frequency.
2. For above 1GHz, the EUT peak value was under average limit, therefore the Average value compliance with the average limit

Test Mode	BLE Mid CH	Temp/Hum	27(°C)/ 53%RH
Test Item	Harmonic	Test Date	Nov 03, 2016
Polarize	Horizontal	Test Engineer	Dennis Li
Detector	Peak and Average	Test Voltage	120Vac / 60Hz

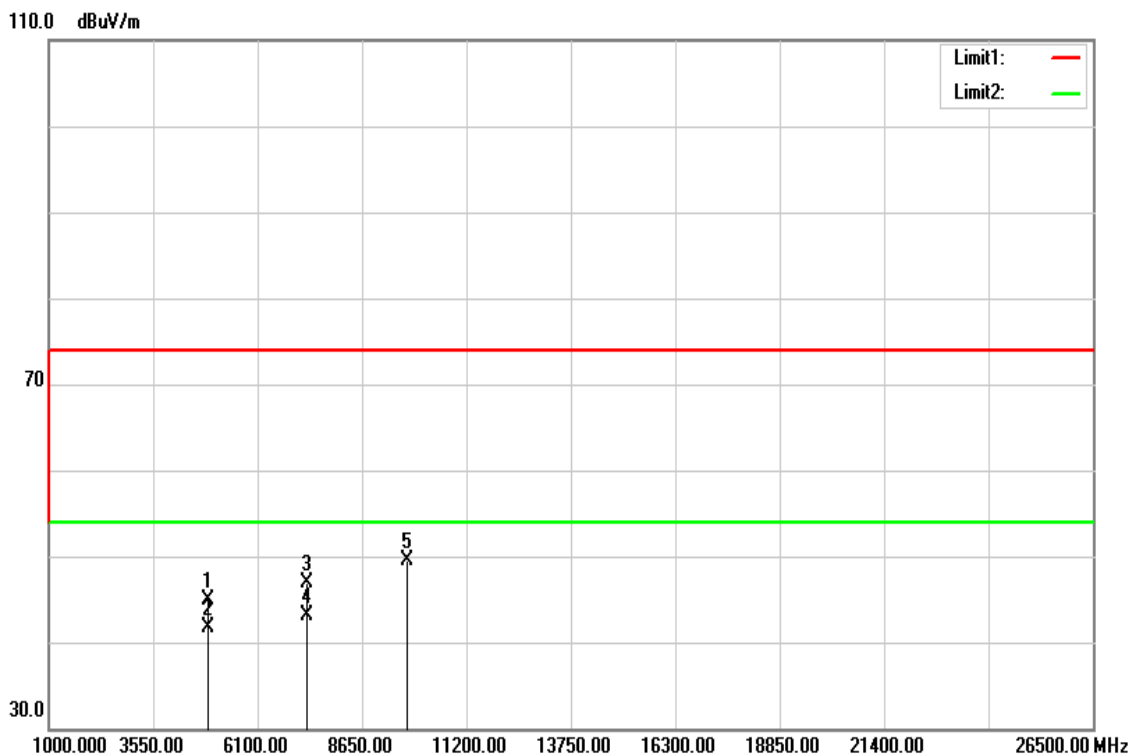

Frequency (MHz)	Reading (dBuV)	Correct Factor (dB/m)	Result (dBuV/m)	Limit (dBuV/m)	Margin (dB)	Remark
4880.000	39.62	5.25	44.87	74.00	-29.13	peak
4880.000	36.40	5.25	41.65	54.00	-12.35	AVG
7320.000	33.86	12.97	46.83	74.00	-27.17	peak
7320.000	30.18	12.97	43.15	54.00	-10.85	AVG
9760.000	31.97	17.60	49.57	74.00	-24.43	peak

Remark:

1. Measuring frequencies from 1 GHz to the 10th harmonic of highest fundamental frequency.
2. For above 1GHz, the EUT peak value was under average limit, therefore the Average value compliance with the average limit

Test Mode	BLE High CH	Temp/Hum	27(°C)/ 53%RH
Test Item	Harmonic	Test Date	Nov 03, 2016
Polarize	Vertical	Test Engineer	Dennis Li
Detector	Peak and Average	Test Voltage	120Vac / 60Hz

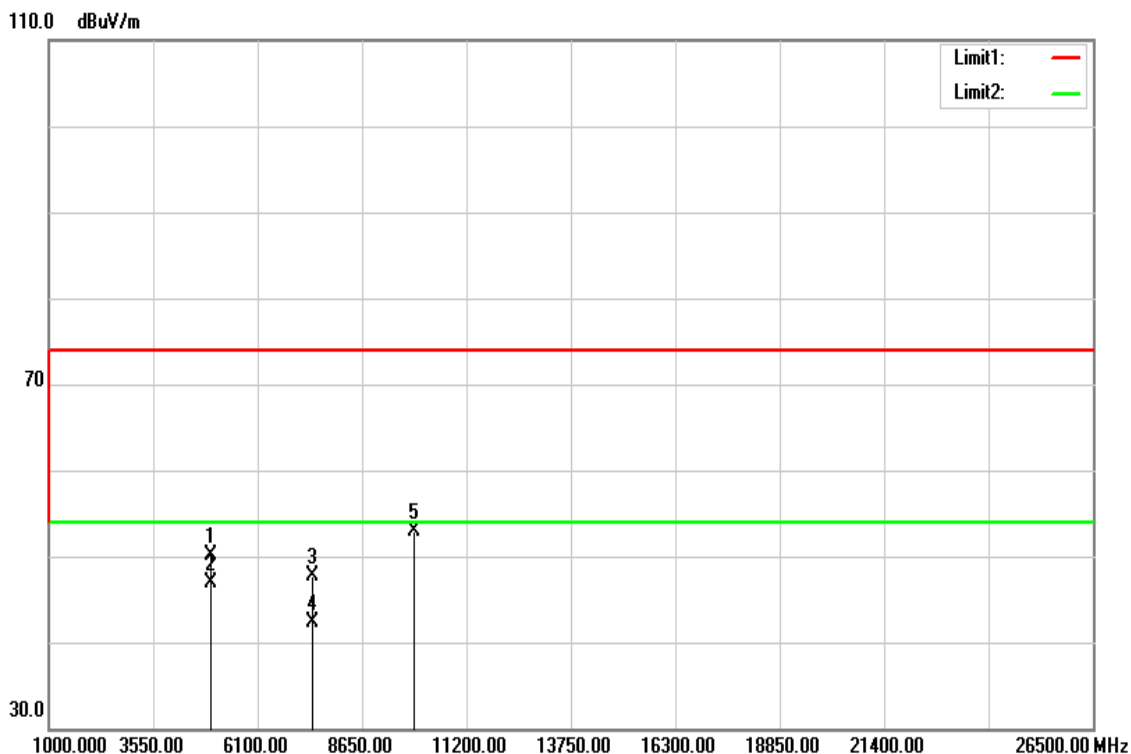

Frequency (MHz)	Reading (dBuV)	Correct Factor (dB/m)	Result (dBuV/m)	Limit (dBuV/m)	Margin (dB)	Remark
4960.000	44.65	5.46	50.11	74.00	-23.89	peak
4960.000	41.38	5.46	46.84	54.00	-7.16	AVG
7440.000	34.43	13.33	47.76	74.00	-26.24	peak
7440.000	28.87	13.33	42.20	54.00	-11.80	AVG
9920.000	35.39	17.60	52.99	74.00	-21.01	peak

Remark:

1. Measuring frequencies from 1 GHz to the 10th harmonic of highest fundamental frequency.
2. For above 1GHz, the EUT peak value was under average limit, therefore the Average value compliance with the average limit

Test Mode	BLE High CH	Temp/Hum	27(°C)/ 53%RH
Test Item	Harmonic	Test Date	Nov 03, 2016
Polarize	Horizontal	Test Engineer	Dennis Li
Detector	Peak and Average	Test Voltage	120Vac / 60Hz

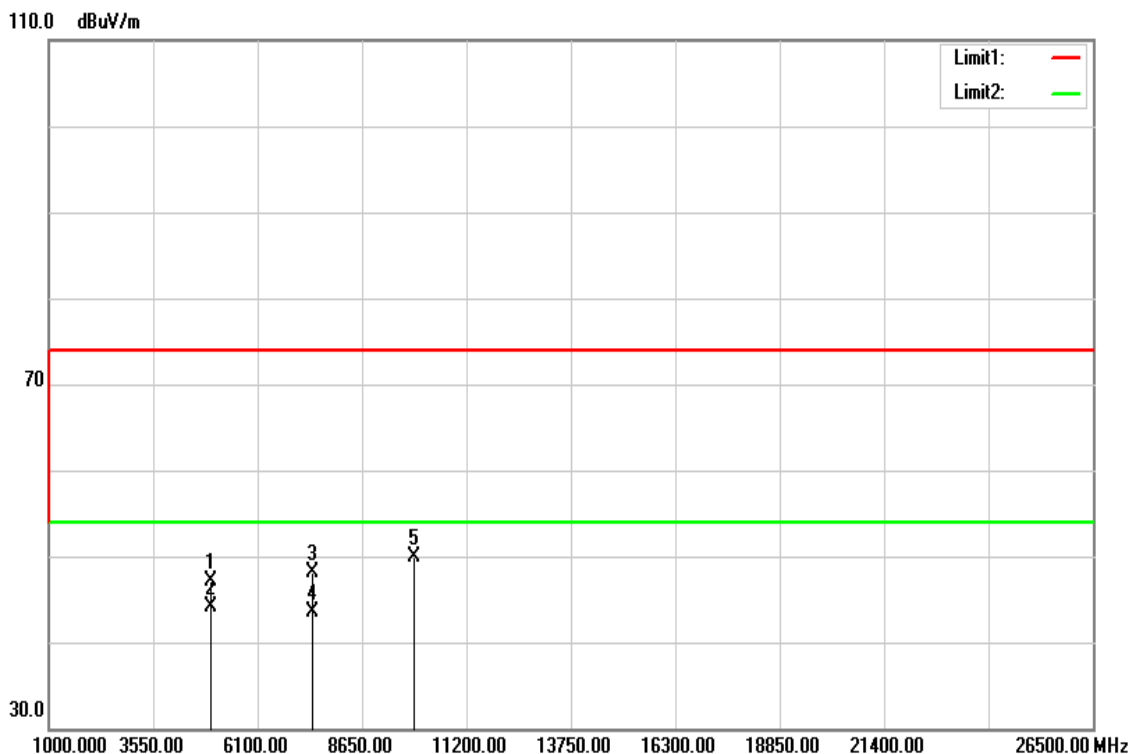

Frequency (MHz)	Reading (dBuV)	Correct Factor (dB/m)	Result (dBuV/m)	Limit (dBuV/m)	Margin (dB)	Remark
4960.000	41.56	5.46	47.02	74.00	-26.98	peak
4960.000	38.57	5.46	44.03	54.00	-9.97	AVG
7440.000	34.74	13.33	48.07	74.00	-25.93	peak
7440.000	30.25	13.33	43.58	54.00	-10.42	AVG
9920.000	32.35	17.60	49.95	74.00	-24.05	peak

Remark:

1. Measuring frequencies from 1 GHz to the 10th harmonic of highest fundamental frequency.
2. For above 1GHz, the EUT peak value was under average limit, therefore the Average value compliance with the average limit