

FCC RADIO TEST REPORT

FCC 47 CFR PART 15 SUBPART C

Test Standard	FCC Part 15.247
FCC ID	PPQ-WN4519R
Brand name	LITE-ON
Applicant	Lite-On Technology Corp.
Product name	802.11a/b/g/n 2T2R Wireless LAN USB Module
Model No.	WN4519R
Test Result	Pass

The test Result was tested by Compliance Certification Services Inc. The test data, data evaluation, test procedures, and equipment configurations shown in this report were given in ANSI C63.10: 2013 and compliance standards.

The test results of this report relate only to the tested sample (EUT) identified in this report.

The test Report of full or partial shall not copy. Without written approval of Compliance Certification Services Inc. (Wugu Laboratory).

The sample selected for test was production product and was provided by manufacturer.



Approved by:

Reviewed by:

A handwritten signature in black ink that reads "Sam Chuang".

A handwritten signature in black ink that reads "Ian Tu".

Sam Chuang
Manager

Ian Tu
Asst. Manager

Revision History

Rev.	Issue Date	Revisions	Revised By
00	February 3, 2017	Initial Issue	Angel Cheng

Table of contents

1. GENERAL INFORMATION	4
1.1 EUT INFORMATION	4
1.2 EUT CHANNEL INFORMATION	5
1.3 ANTENNA INFORMATION	5
1.4 MEASUREMENT UNCERTAINTY.....	6
1.5 FACILITIES AND TEST LOCATION	7
1.6 INSTRUMENT CALIBRATION	7
1.7 SUPPORT AND EUT ACCESSORIES EQUIPMENT	8
1.9 TABLE OF ACCREDITATIONS AND LISTINGS	8
2. TEST SUMMERY	9
3. DESCRIPTION OF TEST MODES	10
3.1 THE WORST MODE OF OPERATING CONDITION	10
3.2 THE WORST MODE OF MEASUREMENT	11
3.3 EUT DUTY CYCLE.....	12
4. TEST RESULT	13
4.1 AC POWER LINE CONDUCTED EMISSION	13
4.2 6DB BANDWIDTH.....	16
4.3 OUTPUT POWER MEASUREMENT	28
4.4 POWER SPECTRAL DENSITY	31
4.5 CONDUCTED BANEDGE AND SPURIOUS EMISSION.....	43
4.6 RADIATION BANEDGE AND SPURIOUS EMISSION	74
APPENDIX 1 - PHOTOGRAPHS OF EUT	

1. GENERAL INFORMATION

1.1 EUT INFORMATION

Applicant	Lite-On Technology Corp.
Applicant address	Bldg. C, 90, Chien 1 Road, Chung Ho, New Taipei City 23585, Taiwan, R.O.C
Equipment	802.11a/b/g/n 2T2R Wireless LAN USB Module
Model Name	WN4519R
Model Discrepancy	N/A
EUT Functions	IEEE 802.11abgn
Received Date	December 23, 2016
Date of Test	December 26, 2016 ~ January 21, 2017
Output Power(W)	IEEE 802.11b mode: 0.1426 IEEE 802.11g mode: 0.3524 IEEE 802.11n HT 20 MHz mode: 0.4864 IEEE 802.11n HT 40 MHz mode: 0.4171
Power Operation	<input type="checkbox"/> AC 120V/60Hz <input type="checkbox"/> Adapter <input type="checkbox"/> PoE <input checked="" type="checkbox"/> Host system(NB) <input type="checkbox"/> DC Type : <input type="checkbox"/> Battery <input type="checkbox"/> DC Power Supply <input type="checkbox"/> External DC adapter

Remark:

All listed models are using an identical RF module with the only differences on number of key buttons mounted for additional functions.

Due to similarity of RF product constructions of given model series, only dedicated model as described in test report with the most complexity constructions was selected for testing and record.

1.2 EUT CHANNEL INFORMATION

Frequency Range	2412MHz-2462MHz
Modulation Type	1. IEEE 802.11b mode: CCK 2. IEEE 802.11g mode: OFDM 3. IEEE 802.11n HT 20 MHz mode: OFDM 4. IEEE 802.11n HT 40 MHz mode: OFDM
Bandwidth	1. IEEE 802.11b mode: 11 Channels 2. IEEE 802.11g mode: 11 Channels 3. IEEE 802.11n HT 20 MHz mode: 11 Channels 4. IEEE 802.11n HT 40 MHz mode: 7 Channels

Remark:

Refer as ANSI 63.10:2013 clause 5.6.1 Table 4 and RSS-GEN Table A1 for test channels

Number of frequencies to be tested		
Frequency range in which device operates	Number of frequencies	Location in frequency range of operation
<input type="checkbox"/> 1 MHz or less	1	Middle
<input type="checkbox"/> 1 MHz to 10 MHz	2	1 near top and 1 near bottom
<input checked="" type="checkbox"/> More than 10 MHz	3	1 near top, 1 near middle, and 1 near bottom

1.3 ANTENNA INFORMATION

Antenna Category	<input checked="" type="checkbox"/> Integral: antenna permanently attached <input type="checkbox"/> External dedicated antennas <input type="checkbox"/> External Unique antenna connector
Antenna Type	<input checked="" type="checkbox"/> PIFA <input type="checkbox"/> PCB <input type="checkbox"/> Dipole <input type="checkbox"/> Coils
Antenna Gain	1. Auden / T-0082 Antenna 1: Gain: 2.70 dBi Antenna 2: Gain: 0.63 dBi 2. Walsin / RFMTA200700NNLB002 Antenna 1: Gain: 1.53 dBi Antenna 2: Gain: -0.29 dBi

1.4 MEASUREMENT UNCERTAINTY

PARAMETER	UNCERTAINTY
Semi Anechoic Chamber (966 Chamber_B) / Radiated Emission, 30 to 1000 MHz	+/- 3.97
Semi Anechoic Chamber (966 Chamber_B) / Radiated Emission, 1 to 18GHz	+/- 3.58
Semi Anechoic Chamber (966 Chamber_B) / Radiated Emission, 18 to 26 GHz	+/- 3.59
Semi Anechoic Chamber (966 Chamber_B) / Radiated Emission, 26 to 40 GHz	+/- 3.81
Conducted Emission (Mains Terminals), 9kHz to 30MHz	+/- 2.48

Remark:

1. This uncertainty represents an expanded uncertainty expressed at approximately the 95% confidence level using a coverage factor of $k=2$
2. ISO/IEC 17025 requires that an estimate of the measurement uncertainties associated with the emissions test results be included in the report.

1.5 FACILITIES AND TEST LOCATION

All measurement facilities used to collect the measurement data are located at
No.11, Wugong 6th Rd., Wugu Dist., New Taipei City 24891, Taiwan. (R.O.C.)

Test site	Test Engineer	Remark
AC Conduction Room	Andersonkuo	
Radiation	Kevin Kuo	
RF Conducted	IanTu	

Remark: The sites are constructed in conformance with the requirements of ANSI C63.7, ANSI C63.4 and CISPR Publication 22.

1.6 INSTRUMENT CALIBRATION

RF Conducted Test Site					
Equipment	Manufacturer	Model	S/N	Cal Date	Cal Due
Power Sensor	Anritsu	MA2411B	917072	7/4/2016	7/3/2017
Spectrum Analyzer	R&S	FSV 40	101073	10/5/2016	10/4/2017
Spectrum Analyzer	Keysight	N9010B	MY55460167	6/15/2016	6/14/2017
Spectrum Analyzer	R&S	FSU 26	100258	6/27/2016	6/26/2017
Spectrum Analyzer	R&S	FSU 8	200114	7/26/2016	7/27/2017
Thermostatic/Hrgrosatic Chamber	GWINSTEK	GTC-288MH-CC	TH160402	5/4/2016	5/3/2017
USB Wideband Power Sensor	Agilent	U2021XA	MY54250027	5/12/2016	5/11/2017
USB Wideband Power Sensor	Agilent	U2021XA	MY54260016	5/12/2016	5/11/2017
USB Wideband Power Sensor	Agilent	U2021XA	MY54260020	5/12/2016	5/11/2017
USB Wideband Power Sensor	Agilent	U2021XA	MY54260007	5/12/2016	5/11/2017

3M 966 Chamber Test Site					
Equipment	Manufacturer	Model	S/N	Cal Date	Cal Due
Spectrum Analyzer	Agilent	E4446A	US42510252	12/5/2016	12/4/2017
Loop Ant	COM-POWER	AL-130	121051	2/25/2016	2/24/2017
Bilog Antenna	Sunol Sciences	JB3	A030105	7/3/2016	7/2/2017
Pre-Amplifier	EMEC	EM330	60609	6/8/2016	6/7/2017
Horn Antenna	ETC	MCTD 1209	DRH13M02003	9/2/2016	9/1/2017
Pre-Amplifier	MITEQ	AMF-6F-260400-40-8P	985646	1/14/2016	9/7/2017
Horn Antenna	EMCO	3116	26370	1/15/2016	1/14/2017
Antenna Tower	CCS	CC-A-1F	N/A	N.C.R	N.C.R
Controller	CCS	CC-C-1F	N/A	N.C.R	N.C.R
Turn Table	CCS	CC-T-1F	N/A	N.C.R	N.C.R

AC Conducted Emissions Test Site					
Equipment	Manufacturer	Model	S/N	Cal Date	Cal Due
LISN	R&S	ENV216	101054	5/11/2016	5/10/2017
LISN	SCHWARZBECK	NSLK 8127	8127-541	11/23/2015	11/22/2016
Receiver	R&S	ESCI	101073	8/20/2016	8/19/2017

Remark: Each piece of equipment is scheduled for calibration once a year.

1.7 SUPPORT AND EUT ACCESSORIES EQUIPMENT

EUT Accessories Equipment					
No.	Equipment	Brand	Model	Series No.	FCC ID
	N/A				

Support Equipment					
No.	Equipment	Brand	Model	Series No.	FCC ID
1	NB	DELL	PP19L	R33002	E2KWM3945ABG

1.8 Test methodology and applied standards

The test methodology, setups and results comply with all requirements in accordance with ANSI C63.10:2013, FCC Part 2, FCC Part 15.247, KDB 558074 D01 v03r05.

1.9 TABLE OF ACCREDITATIONS AND LISTINGS

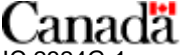
Country	Agency	Scope of Accreditation	Logo
USA	FCC	3M Semi Anechoic Chamber (FCC MRA: TW1039) to perform FCC Part 15 measurements	 FCC MRA: TW1039
Canada	Industry Canada	3M Semi Anechoic Chamber (IC 2324G-1 / IC 2324G-2) to perform	 IC 2324G-1 IC 2324G-2

2. TEST SUMMERY

FCC Standard Section	Report Section	Test Item	Result
15.203	1.2	Antenna Requirement	Pass
15.207(a)	4.1	AC Conducted Emission	Pass
15.247(a)(2)	4.2	6 dB Bandwidth	Pass
15.247(b)	4.3	Output Power Measurement	Pass
15.247(e)	4.4	Power Spectral Density	Pass
15.247(d)	4.5	Conducted Band Edge	Pass
15.247(d)	4.5	Conducted Emission	Pass
15.247(d)	4.6	Radiation Band Edge	Pass
15.247(d)	4.6	Radiation Spurious Emission	Pass

3. DESCRIPTION OF TEST MODES

3.1 THE WORST MODE OF OPERATING CONDITION

Operation mode	IEEE 802.11b mode :1Mbps IEEE 802.11g mode :6Mbps IEEE 802.11n HT20 mode :MCS8 IEEE 802.11n HT40 mode :MCS8
Test Channel Frequencies	IEEE 802.11b mode : 1. Lowest Channel : 2412MHz 2. Middle Channel : 2437MHz 3. Highest Channel : 2462MHz IEEE 802.11g mode : 1. Lowest Channel : 2412MHz 2. Middle Channel : 2437MHz 3. Highest Channel : 2462MHz IEEE 802.11n HT20 mode : 1. Lowest Channel : 2412MHz 2. Middle Channel : 2437MHz 3. Highest Channel : 2462MHz IEEE 802.11n HT40 mode : 1. Lowest Channel : 2422MHz 2. Middle Channel : 2437MHz 3. Highest Channel : 2452MHz
Operation Transmitter	IEEE 802.11b mode :1T1R IEEE 802.11g mode :1T1R IEEE 802.11n HT20 mode :2T2R IEEE 802.11n HT40 mode :2T2R

Remark:

1. EUT pre-scanned data rate of output power for each mode, the worst data rate were recorded in this report.

3.2 THE WORST MODE OF MEASUREMENT

AC Power Line Conducted Emission	
Test Condition	AC Power line conducted emission for line and neutral
Voltage/Hz	120V/60Hz
Test Mode	Mode 1:EUT power by AC adapter via power cable.
Worst Mode	<input checked="" type="checkbox"/> Mode 1 <input type="checkbox"/> Mode 2 <input type="checkbox"/> Mode 3 <input type="checkbox"/> Mode 4

Radiated Emission Measurement	
Test Condition	Band edge, Emission for Unwanted and Fundamental
Voltage/Hz	120V/60Hz
Test Mode	Mode 1:EUT power by AC adapter via power cable.
Worst Mode	<input checked="" type="checkbox"/> Mode 1 <input type="checkbox"/> Mode 2 <input type="checkbox"/> Mode 3 <input type="checkbox"/> Mode 4
Worst Position	<input type="checkbox"/> Placed in fixed position. <input type="checkbox"/> Placed in fixed position at X-Plane (E2-Plane) <input checked="" type="checkbox"/> Placed in fixed position at Y-Plane (E1-Plane) <input type="checkbox"/> Placed in fixed position at Z-Plane (H-Plane)
Worst Polarity	<input type="checkbox"/> Horizontal <input checked="" type="checkbox"/> Vertical

Radiated Emission Measurement Below 1G	
Test Condition	Radiated Emission Below 1G
Voltage/Hz	120V/60Hz
Test Mode	Mode 1:EUT power by AC adapter via power cable.
Worst Mode	<input checked="" type="checkbox"/> Mode 1 <input type="checkbox"/> Mode 2 <input type="checkbox"/> Mode 3 <input type="checkbox"/> Mode 4

Remark:

1. The worst mode was record in this test report.
2. EUT pre-scanned in three axis ,X, Y, Z and two polarity, Horizontal and Vertical for radiated measurement. The worst case(Y-Plane and Vertical) were recorded in this report

3.3 EUT DUTY CYCLE

Duty Cycle					
Configuration	TX ON (ms)	TX ALL (ms)	Duty Cycle (%)	Duty Factor(dB)	
802.11b	1.0000	1.0000	100%	0.00	
802.11g	1.0000	1.0000	100%	0.00	
802.11n HT20	1.0000	1.0000	100%	0.00	
802.11n HT40	1.0000	1.0000	100%	0.00	

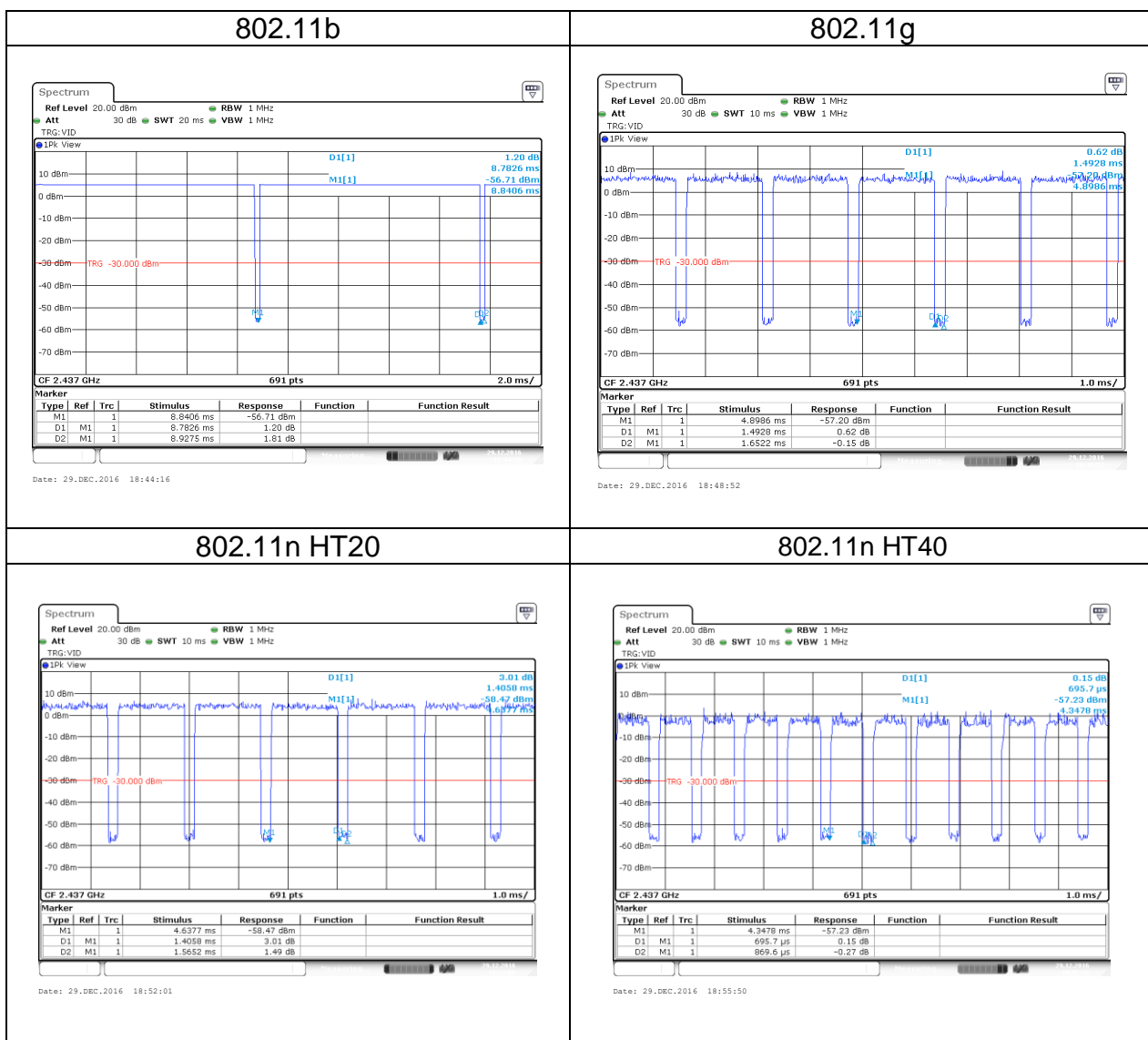

4. TEST RESULT

4.1 AC POWER LINE CONDUCTED EMISSION

4.1.1 Test Limit

According to §15.207(a)(2),

Frequency Range (MHz)	Limits(dBμV)	
	Quasi-peak	Average
0.15 to 0.50	66 to 56*	56 to 46*
0.50 to 5	56	46
5 to 30	60	50

* Decreases with the logarithm of the frequency.

4.1.2 Test Procedure

Test method Refer as ANSI 63.10:2013 clause 6.2,

1. The EUT was placed on a non-conducted table, which is 0.8m above horizontal ground plane and 0.4m above vertical ground plane.
2. EUT connected to the line impedance stabilization network (LISN)
3. Receiver set RBW of 9kHz and Detector Peak, and note as quasi-peak and average.
4. Maximum procedure was performed on the six highest emissions to ensure EUT compliance.
5. Recorded Line for Neutral and Line.

4.1.3 Test Setup

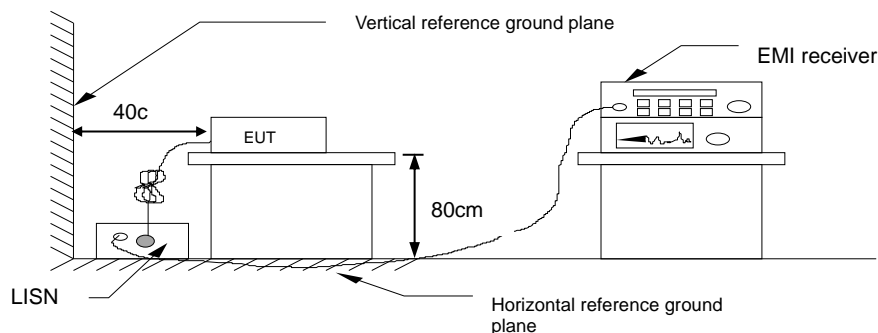

4.1.4 Test Result

Pass.

Test Data

Test Mode:	Mode 1	Temp/Hum	24(°C)/ 50%RH
Test Voltage:	120Vac / 60Hz	Test Date	January 5, 2017
Phase:	Line	Test Engineer	Andersonkuo

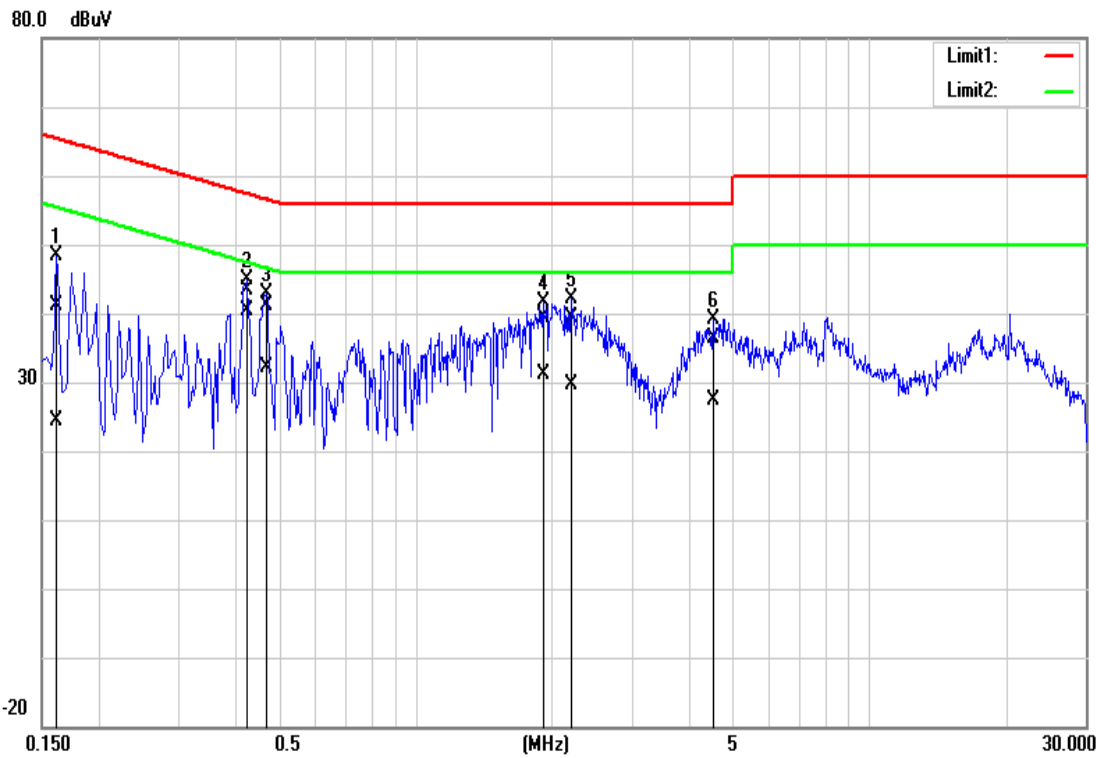

Frequency (MHz)	Quasi Peak reading (dBuV)	Average reading (dBuV)	Correction factor (dB)	Quasi Peak result (dBuV)	Average result (dBuV)	Quasi Peak limit (dBuV)	Average limit (dBuV)	Quasi Peak margin (dB)	Average margin (dB)	Remark
0.1620	31.29	14.61	9.82	41.11	24.44	65.36	55.36	-24.25	-30.92	Pass
0.4260	33.50	30.57	9.81	43.31	40.36	57.33	47.33	-14.02	-6.97	Pass
0.4700	31.30	22.47	9.81	41.11	32.22	56.51	46.51	-15.40	-14.29	Pass
1.9180	29.40	21.37	9.87	39.27	31.14	56.00	46.00	-16.73	-14.86	Pass
2.2100	29.41	19.66	9.88	39.29	29.52	56.00	46.00	-16.71	-16.48	Pass
4.5340	26.45	17.42	9.94	36.39	27.34	56.00	46.00	-19.61	-18.66	Pass

Test Mode:	Mode 1	Temp/Hum	27(°C)/ 53%RH
Test Voltage:	120Vac / 60Hz	Test Date	January 5, 2017
Phase:	Neutral	Test Engineer	Andersonkuo

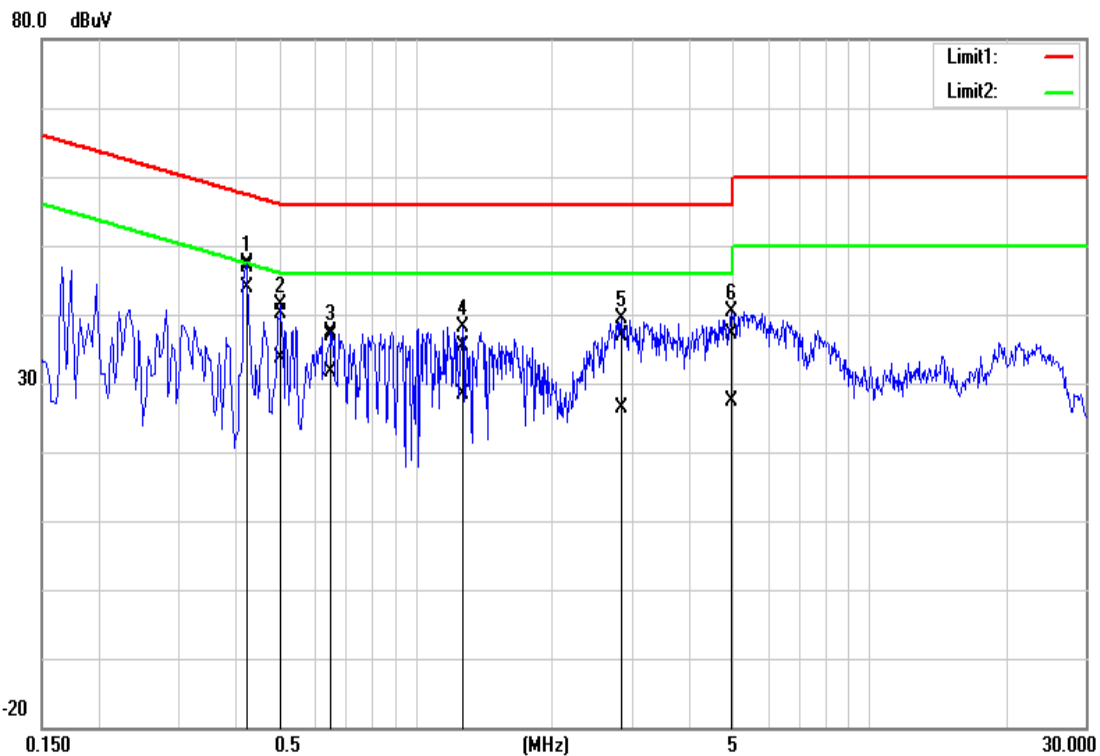

Frequency (MHz)	Quasi Peak reading (dBuV)	Average reading (dBuV)	Correction factor (dB)	Quasi Peak result (dBuV)	Average result (dBuV)	Quasi Peak limit (dBuV)	Average limit (dBuV)	Quasi Peak margin (dB)	Average margin (dB)	Remark
0.4260	36.97	34.02	9.87	46.84	43.93	57.33	47.33	-10.49	-3.42	Pass
0.5060	30.14	23.87	9.87	40.01	33.75	56.00	46.00	-15.99	-12.28	Pass
0.6540	27.11	21.82	9.87	36.98	31.68	56.00	46.00	-19.02	-14.33	Pass
1.2740	25.47	18.36	9.89	35.36	28.25	56.00	46.00	-20.64	-17.72	Pass
2.8500	26.94	16.35	9.96	36.90	26.29	56.00	46.00	-19.10	-19.72	Pass
4.9980	27.01	17.24	10.07	37.08	27.24	56.00	46.00	-18.92	-18.71	Pass

4.2 6DB BANDWIDTH

4.2.1 Test Limit

According to §15.247(a)(2).

6 dB Bandwidth :

Limit	Shall be at least 500kHz
-------	--------------------------

Occupied Bandwidth(99%) : For reporting purposes only.

4.2.2 Test Procedure

Test method Refer as KDB 558074 D01 v03r05, Section 8.1 and ANSI 63.10:2013 clause 6.9.2,

1. The EUT RF output connected to the spectrum analyzer by RF cable.
2. Setting maximum power transmit of EUT
3. SA set RBW = 100kHz, VBW = 300kHz and Detector = Peak, to measurement 6 dB Bandwidth.
4. Measure and record the result of 6 dB Bandwidth in the test report.

4.2.3 Test Setup

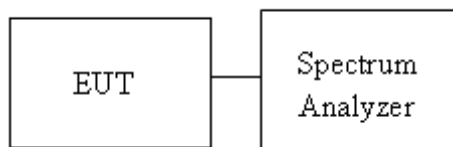

4.2.4 Test Result

Test mode: IEEE 802.11b mode / 2412-2462 MHz					
Channel	Frequency (MHz)	Chain 0 6dB BW (MHz)	Chain 1 6dB BW (MHz)	Total 6dB BW (MHz)	6dB limit (kHz)
Low	2412	10.0870	-	10.0870	≥500
Mid	2437	10.0870	-	10.0870	
High	2462	10.0870	-	10.0870	

Test mode: IEEE 802.11g mode / 2412-2462 MHz					
Channel	Frequency (MHz)	Chain 0 6dB BW (MHz)	Chain 1 6dB BW (MHz)	Total 6dB BW (MHz)	6dB limit (kHz)
Low	2412	16.3478	-	16.3478	≥500
Mid	2437	16.3478	-	16.3478	
High	2462	16.3478	-	16.3478	

Test mode: IEEE 802.11n HT 20 MHz mode / 2412-2462 MHz					
Channel	Frequency (MHz)	Chain 0 6dB BW (MHz)	Chain 1 6dB BW (MHz)	6dB limit (kHz)	
Low	2412	17.2609	17.1304	≥500	
Mid	2437	17.1304	17.1304		
High	2462	17.0435	16.9565		

Test mode: IEEE 802.11n HT 40 MHz mode / 2422-2452 MHz					
Channel	Frequency (MHz)	Chain 0 6dB BW (MHz)	Chain 1 6dB BW (MHz)	6dB limit (kHz)	
Low	2422	35.246	35.594	>500	
Mid	2437	35.362	35.594		
High	2452	35.478	35.478		

Test Data

IEEE 802.11b mode / Low / Chain 0

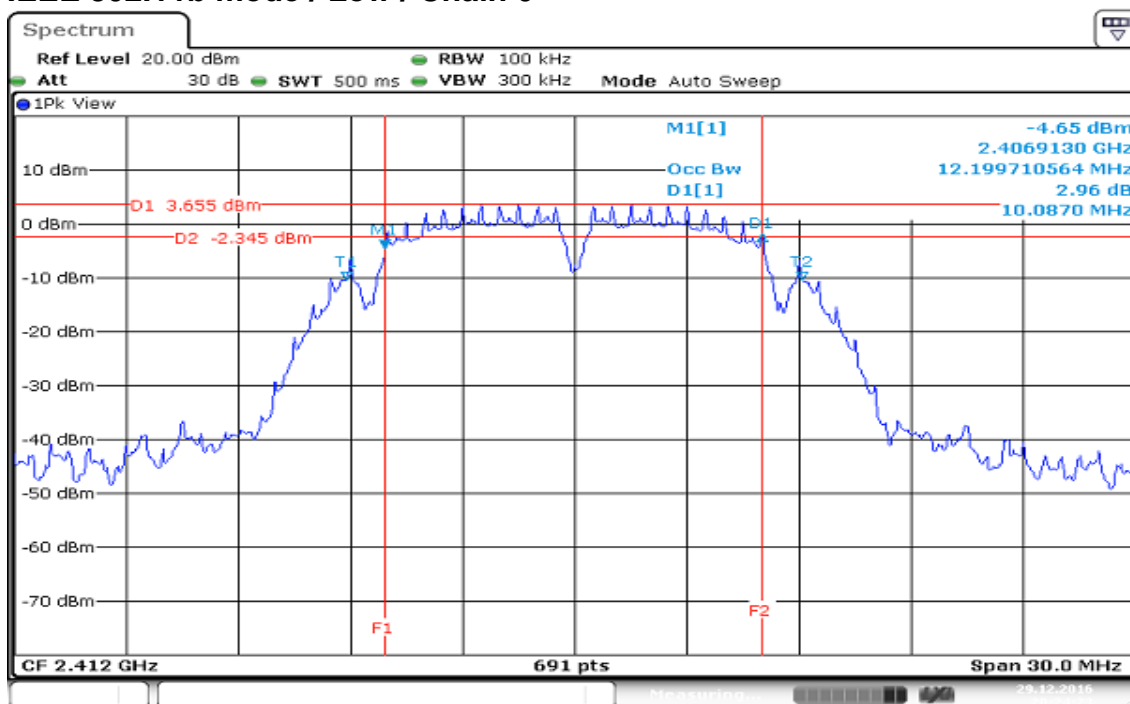

IEEE 802.11b mode / Mid / Chain 0

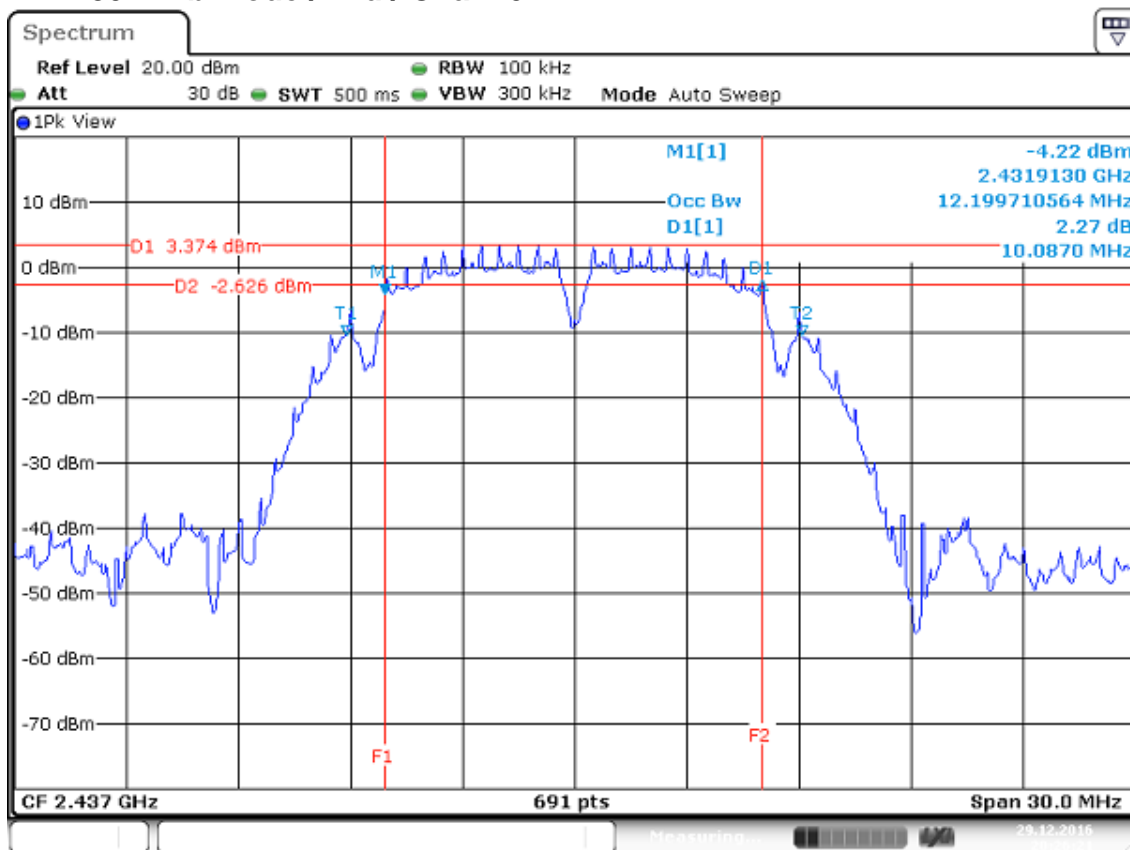

IEEE 802.11b mode /High / Chain 0

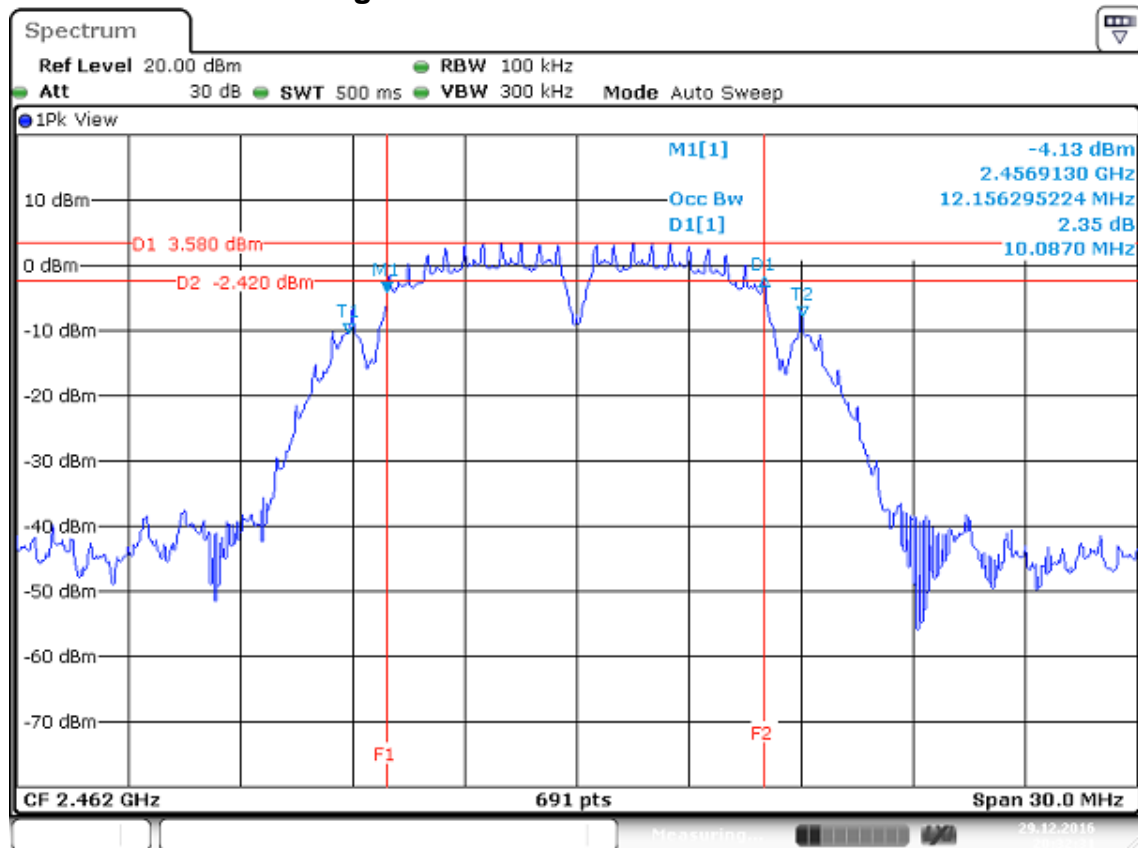

Date: 29.DEC.2016 20:32:31

IEEE 802.11g mode / Low / Chain 0

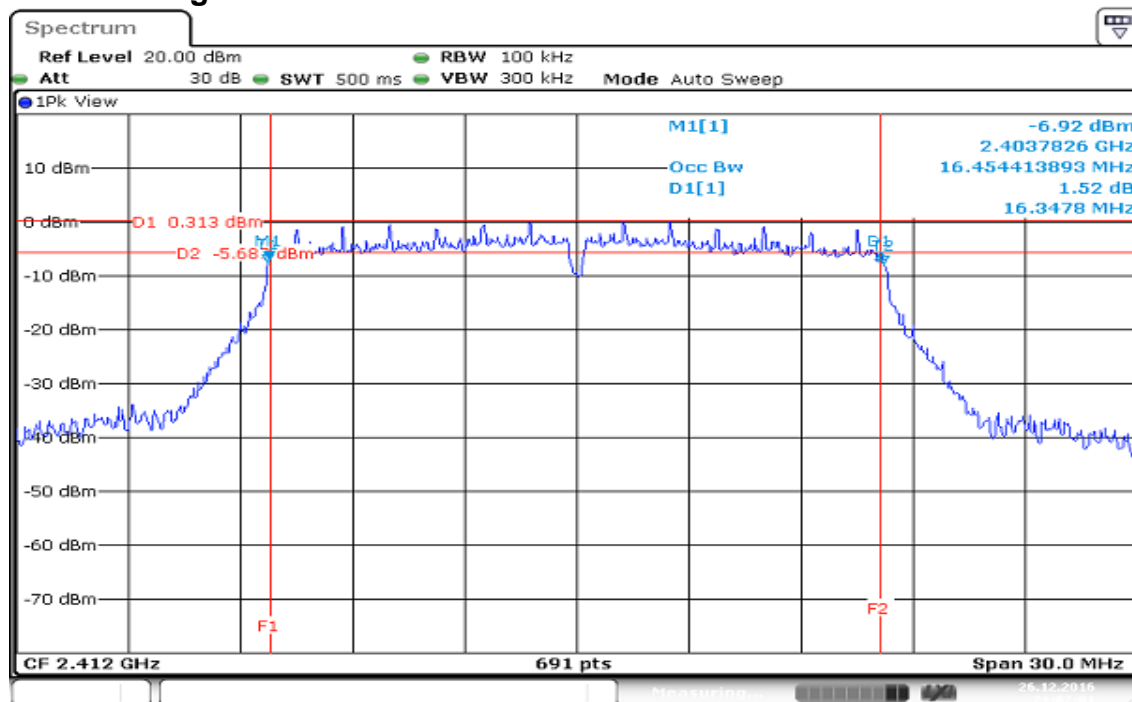

Date: 26 DEC 2016 21:02:01

IEEE 802.11g mode / Mid / Chain 0

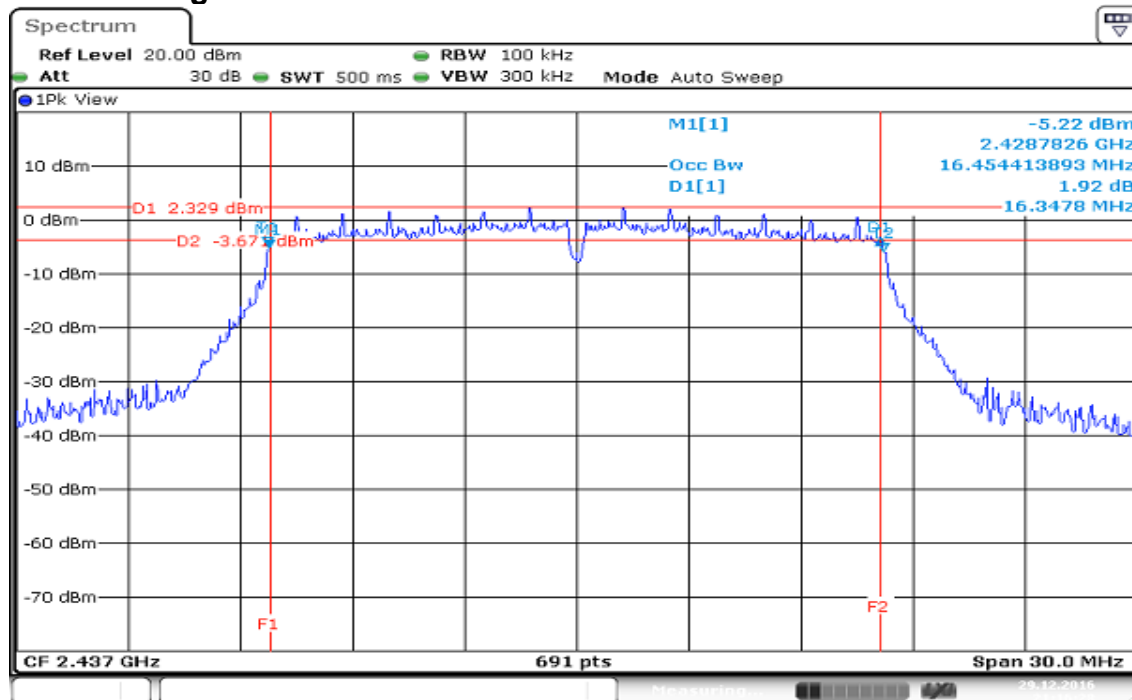

Date: 29 DEC 2016 21:16:27

IEEE 802.11g mode / High / Chain 0

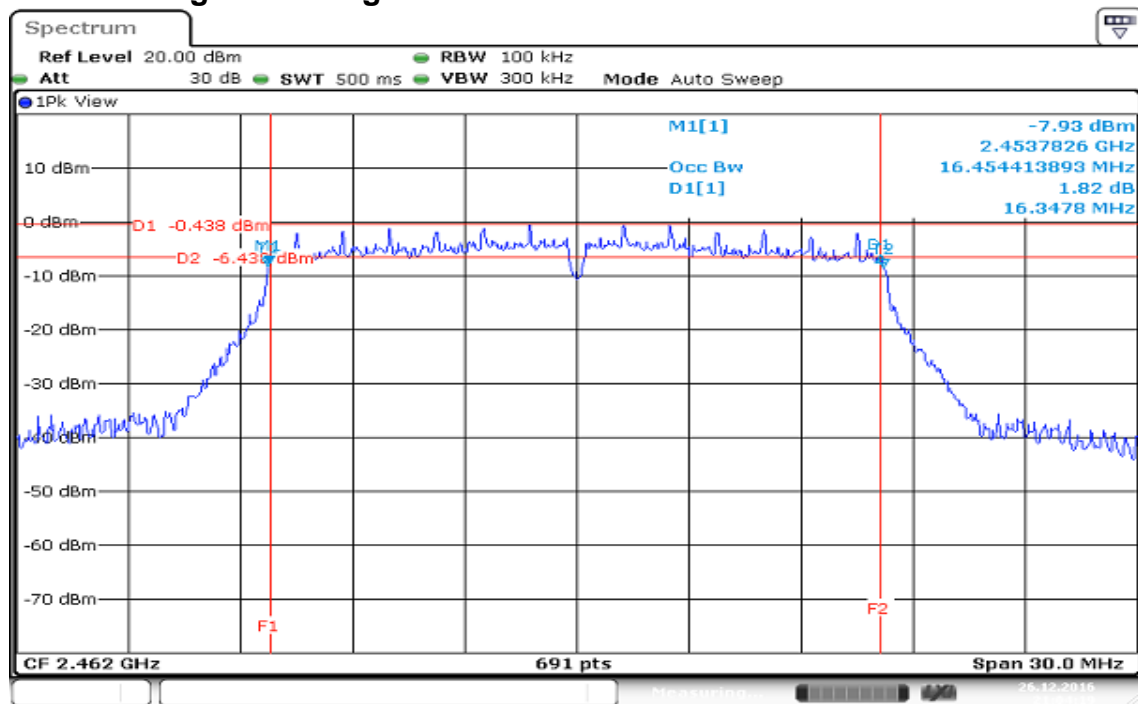

Date: 26 DEC 2016 21:04:19

IEEE 802.11n HT 20 MHz mode / Low / Chain 0

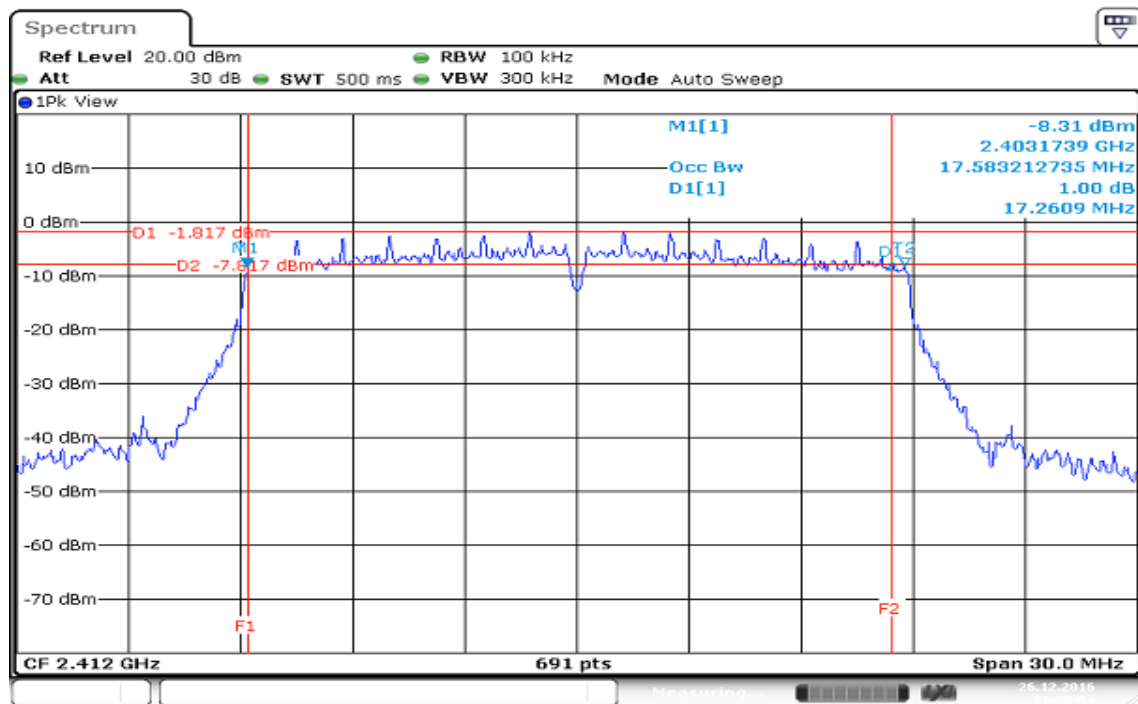

IEEE 802.11n HT 20 MHz mode / Mid / Chain 0

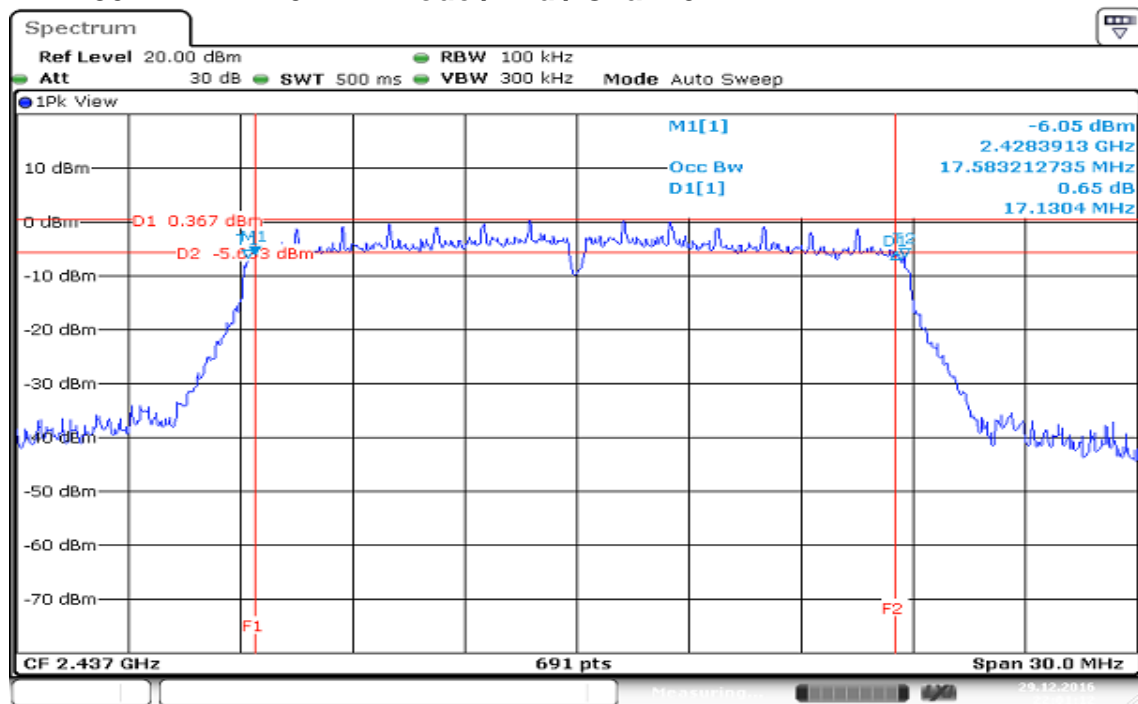

IEEE 802.11n HT 20 MHz mode / High / Chain 0

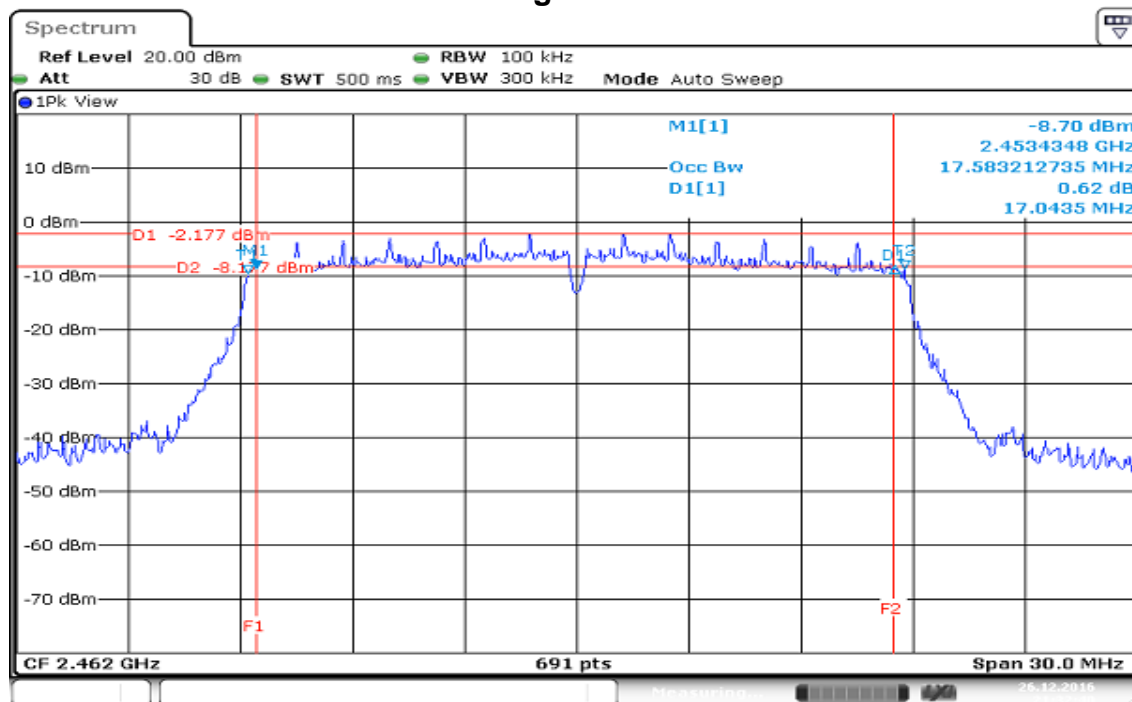

Date: 26 DEC 2016 21:32:41

IEEE 802.11n HT 20 MHz mode / Low / Chain 1

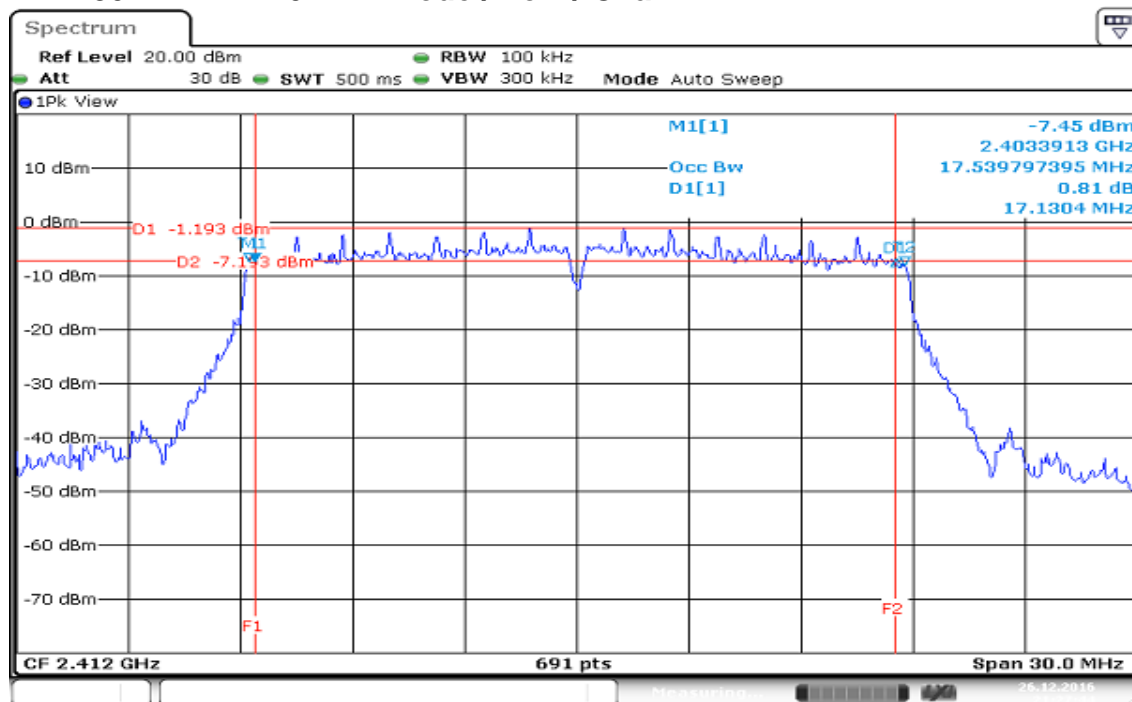

Date: 26 DEC 2016 21:27:45

IEEE 802.11n HT 20 MHz mode / Mid / Chain 1

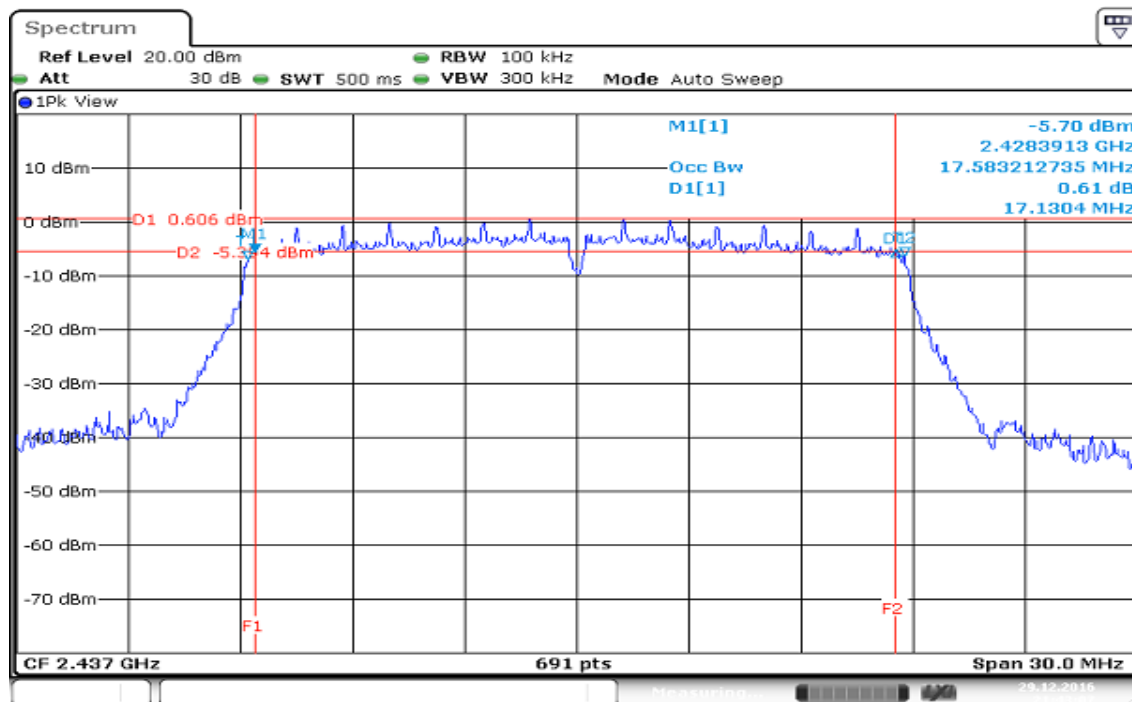

Date: 29.DEC.2016 21:43:07

IEEE 802.11n HT 20 MHz mode / High / Chain 1

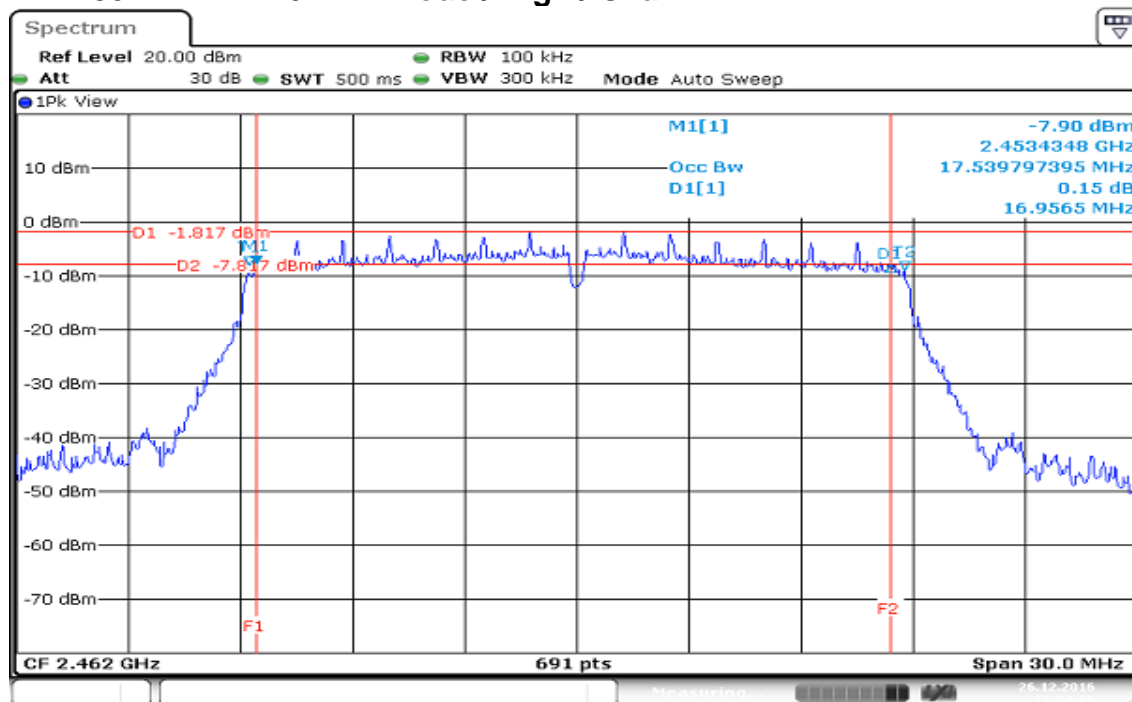

Date: 26.DEC.2016 21:34:06

IEEE 802.11n HT 40 MHz mode / Low / Chain 0

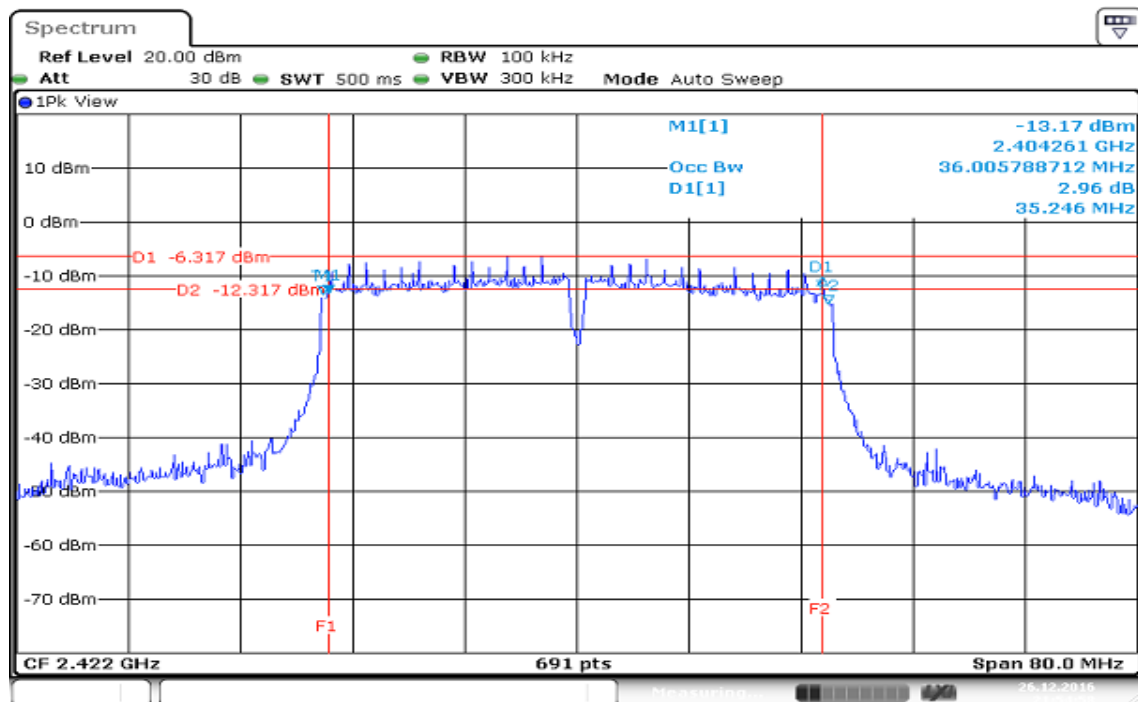

IEEE 802.11n HT 40 MHz mode / Mid / Chain 0

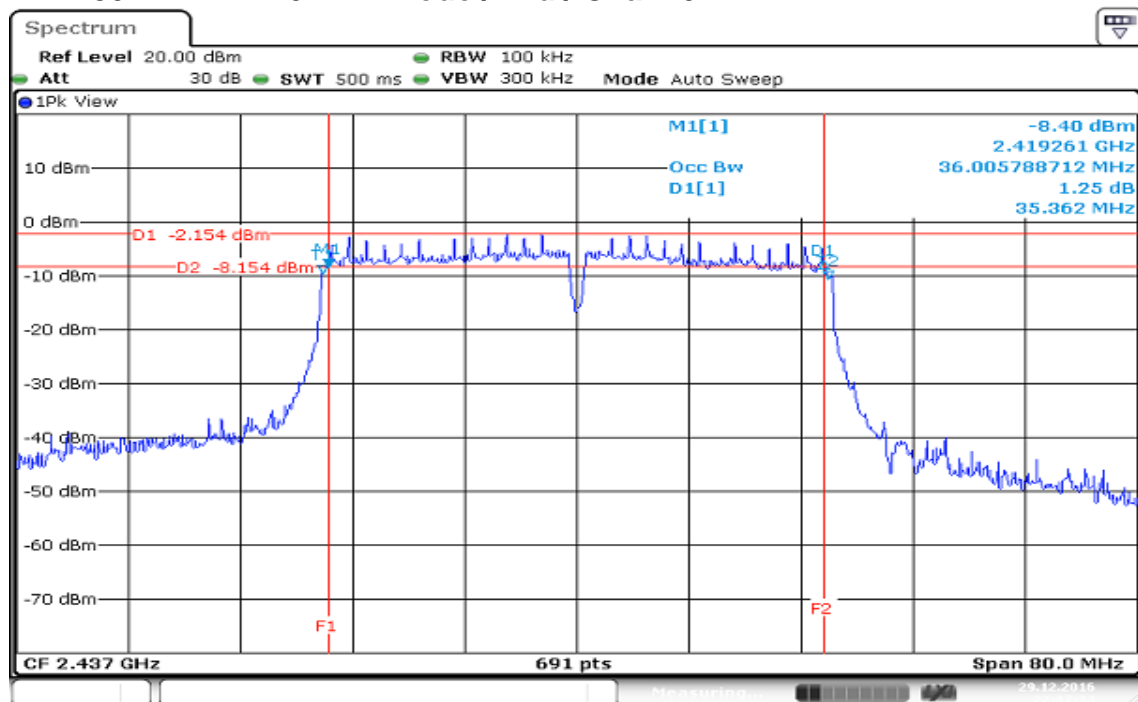

IEEE 802.11n HT 40 MHz mode / High / Chain 0

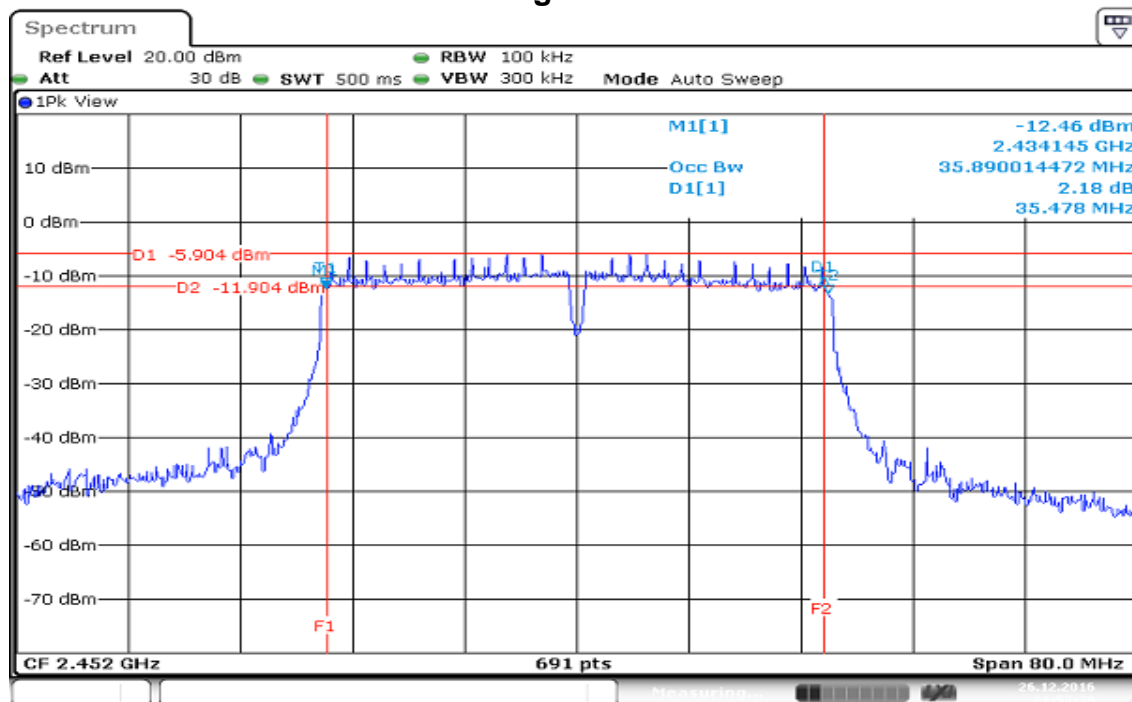

Date: 26 DEC 2016 21:53:29

IEEE 802.11n HT 40 MHz mode / Low / Chain 1

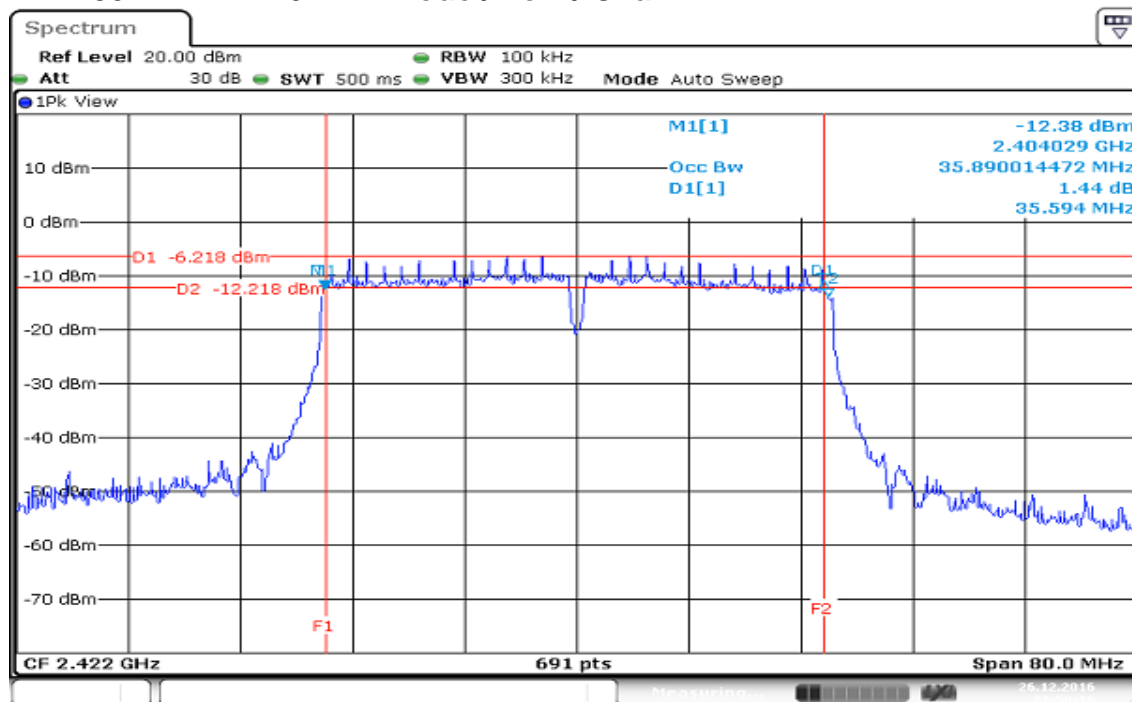

Date: 26 DEC 2016 21:50:16

IEEE 802.11n HT 40 MHz mode / Mid / Chain 1

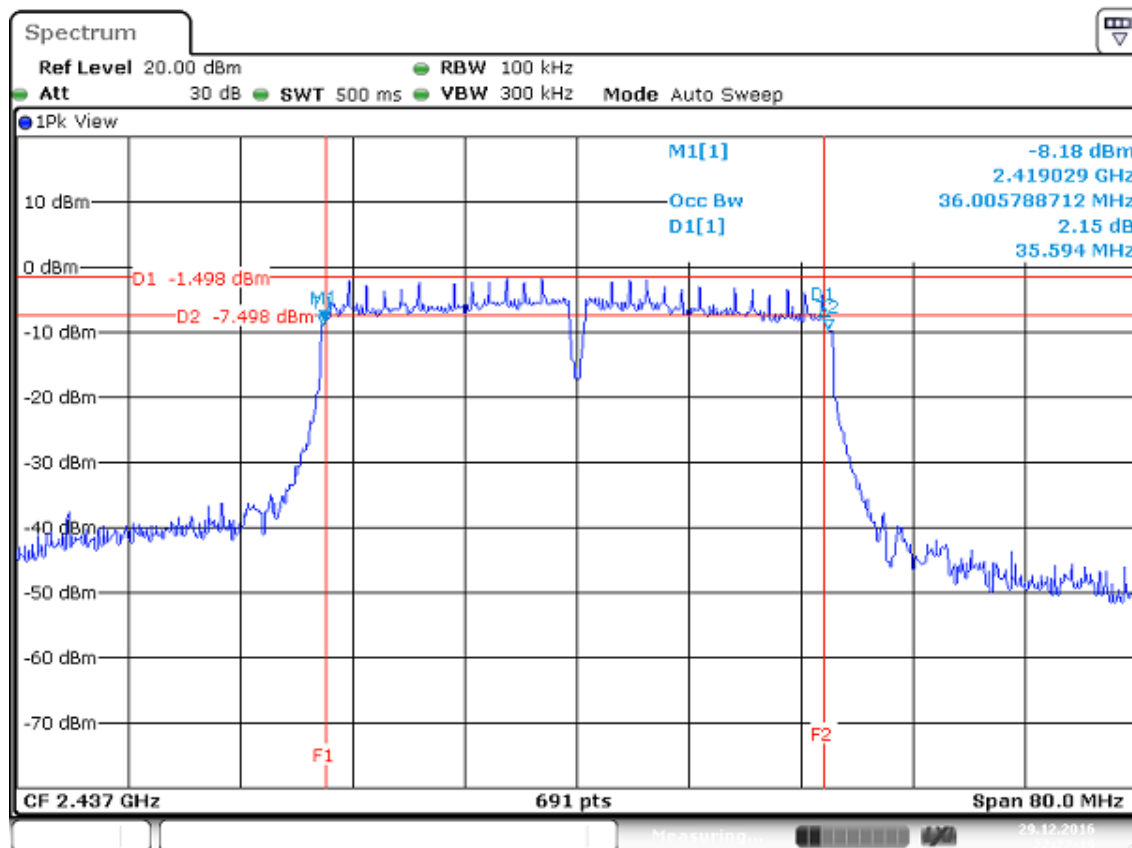

IEEE 802.11n HT 40 MHz mode / High / Chain 1

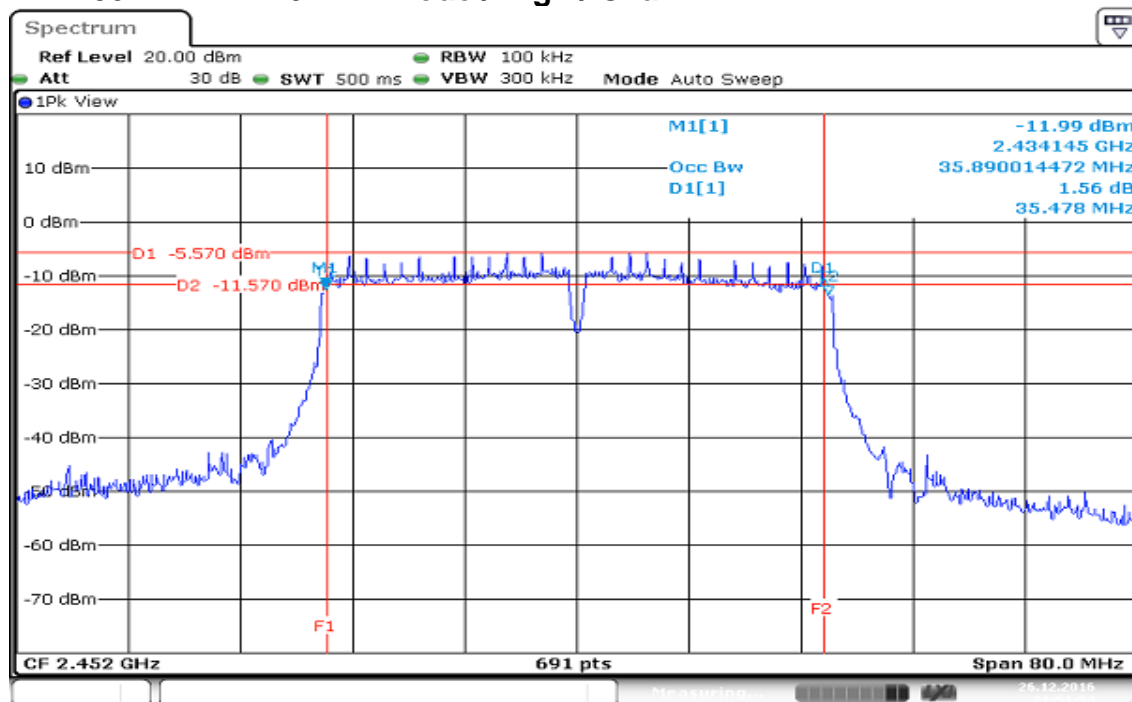

4.3 OUTPUT POWER MEASUREMENT

4.3.1 Test Limit

According to §15.247(b).

Peak output power :

For systems using digital modulation in the 2400-2483.5 MHz, and 5725-5850 MHz bands: 1 Watt(30 dBm)and the e.i.r.p. shall not exceed 4Watt(36 dBm), base on the use of antennas with directional gain not exceed 6 dBi If transmitting antennas of directional gain greater than 6dBi are used the peak output powerthe conducted output power from the intentional radiator shall be reduced by the amount in dB that the directional gain of the antenna exceeds 6 dBi. In case of point-to-point operation, the limit has to be reduced by 1dB for every 3 dB that the directional gain of the antenna exceeds 6 dBi.

Limit	<input checked="" type="checkbox"/> Antenna not exceed 6 dBi : 30dBm <input type="checkbox"/> Antenna with DG greater than 6 dBi : [Limit = 30 – (DG– 6)] <input type="checkbox"/> Point-to-point operation :
-------	--

Average output power : For reporting purposes only.

4.3.2 Test Procedure

Test method Refer as KDB 558074 D01 v03r05, Section 9.1.2.

1. The EUT RF output connected to the power meter by RF cable.
2. Setting maximum power transmit of EUT.
3. The path loss was compensated to the results for each measurement.
4. Measure and record the result of Peak output power and Average output power. in the test report.

4.3.3 Test Setup

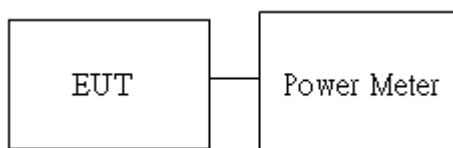

4.3.4 Test Result

Peak output power :

Wifi 2.4G								
Config	CH	Freq. (MHz)	power set		PK Power(dBm)		PK Total Power (dBm)	PK Total Power (W)
			chain0	chain1	chain0	chain1		
IEEE 802.11b Data rate: 1Mbps	Low	2412	1F	-	19.68	-	19.68	0.0929
	Mid	2437	24	-	21.54	-	21.54	0.1426
	High	2462	1F	-	19.91	-	19.91	0.0979
IEEE 802.11g Data rate: 6Mbps	Low	2412	1E	-	24.62	-	24.62	0.2897
	Mid	2437	24	-	25.47	-	25.47	0.3524
	High	2462	1E	-	24.53	-	24.53	0.2838
IEEE 802.11n HT20 Data rate: MCS8	Low	2412	1C	1C	22.95	23.45	26.22	0.4188
	Mid	2437	1D	1D	22.23	23.41	25.87	0.3864
	High	2462	1F	1F	23.47	24.22	26.87	0.4864
IEEE 802.11n HT40 Data rate: MCS8	Low	2422	18	18	21.77	21.62	24.71	0.2958
	Mid	2437	1D	1D	22.93	23.44	26.20	0.4169
	High	2452	18	18	22.12	22.02	25.08	0.3221

Average output power :

Wifi 2.4G					
Config	CH	Freq. (MHz)	AV Power(dBm)		AV Total Power (dBm)
			chain0	chain1	
IEEE 802.11b Data rate: 1Mbps	Low	2412	16.02	-	16.02
	Mid	2437	17.85	-	17.85
	High	2462	16.52	-	16.52
IEEE 802.11g Data rate: 6Mbps	Low	2412	14.96	-	14.96
	Mid	2437	17.47	-	17.47
	High	2462	14.89	-	14.89
IEEE 802.11n HT20 Data rate: MCS8	Low	2412	12.15	12.86	15.53
	Mid	2437	12.71	13.15	15.95
	High	2462	13.65	13.52	16.60
IEEE 802.11n HT40 Data rate: MCS8	Low	2422	10.09	10.03	13.07
	Mid	2437	12.62	12.68	15.66
	High	2452	10.12	10.10	13.12

4.4 POWER SPECTRAL DENSITY

4.4.1 Test Limit

According to §15.247(e).

For digitally modulated systems, the power spectral density conducted from the intentional radiator to the antenna shall not be greater than 8 dBm in any 3 kHz band during any time interval of continuous transmission.

Limit	<input checked="" type="checkbox"/> Antenna not exceed 6 dBi : 8dBm <input type="checkbox"/> Antenna with DG greater than 6 dBi : [Limit = 8 – (DG– 6)] <input type="checkbox"/> Point-to-point operation :
-------	--

4.4.2 Test Procedure

Test method Refer as KDB 558074 D01 v03r05, Section 10.2

1. The EUT RF output connected to the spectrum analyzer by RF cable.
2. Setting maximum power transmit of EUT
3. SA set RBW = 3kHz, VBW = 30kHz, Span = 1.5 times DTS Bandwidth (6 dB BW), Detector = Peak, Sweep Time = Auto and Trace = Max hold.
4. The path loss and Duty Factor were compensated to the results for each measurement by SA.
5. Mark the maximum level.
6. Measure and record the result of power spectral density. in the test report.

4.4.3 Test Setup

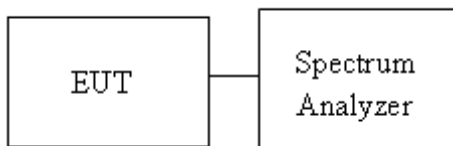

4.4.4 Test Result

Test mode: IEEE 802.11b mode / 2412-2462 MHz					
Channel	Frequency (MHz)	Chain 0 PPSD (dBm)	Chain 1 PPSD (dBm)	Total PSSD (dBm)	Limit (dBm)
Low	2412	-9.59	-	-9.59	8
Mid	2437	-9.87	-	-9.87	
High	2462	-9.90	-	-9.90	

Test mode: IEEE 802.11g mode / 2412-2462 MHz					
Channel	Frequency (MHz)	Chain 0 PPSD (dBm)	Chain 1 PPSD (dBm)	Total PSSD (dBm)	Limit (dBm)
Low	2412	-13.66	-	-13.66	8
Mid	2437	-10.32	-	-10.32	
High	2462	-13.38	-	-13.38	

Test mode: IEEE 802.11n HT 20 MHz mode / 2412-2462 MHz					
Channel	Frequency (MHz)	Chain 0 PPSD (dBm)	Chain 1 PPSD (dBm)	Total PSSD (dBm)	Limit (dBm)
Low	2412	-15.85	-14.24	-11.96	8
Mid	2437	-14.06	-12.90	-10.43	
High	2462	-16.18	-15.59	-12.86	

Test mode: IEEE 802.11n HT 40 MHz mode / 2422-2452 MHz					
Channel	Frequency (MHz)	Chain 0 PPSD (dBm)	Chain 1 PPSD (dBm)	Total PSSD (dBm)	Limit (dBm)
Low	2422	-19.13	-18.20	-15.63	8
Mid	2437	-14.45	-13.88	-11.15	
High	2452	-18.41	-17.73	-15.05	

Test Data

IEEE 802.11b mode / Low / Chain 0

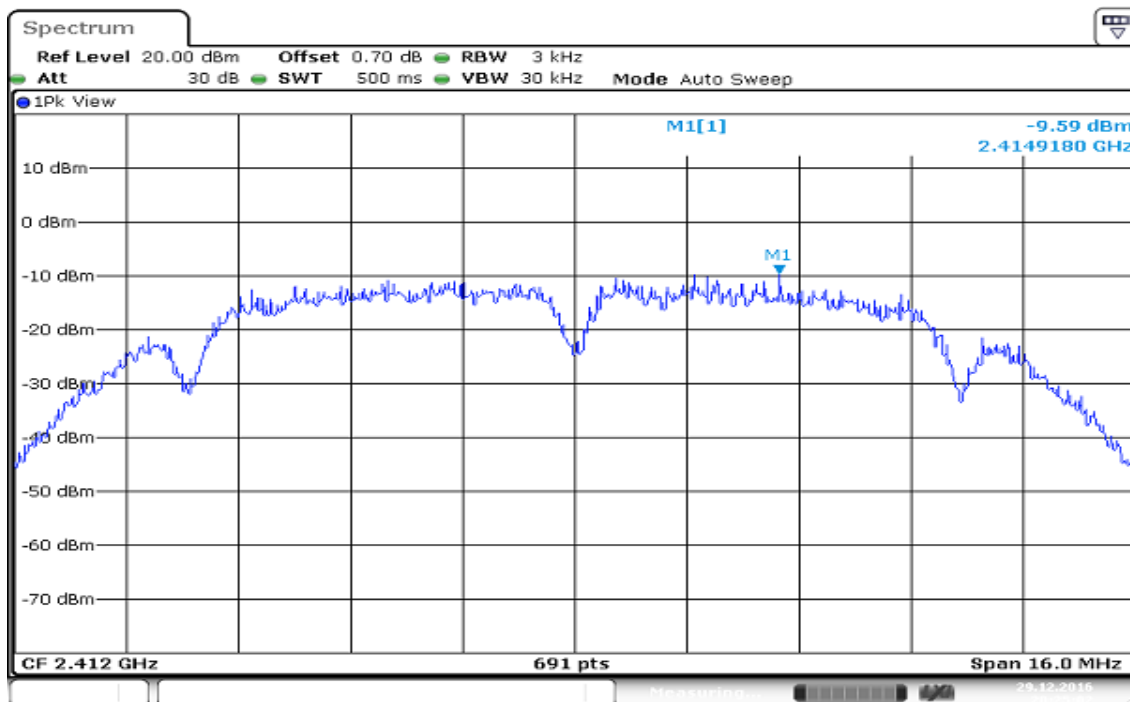

IEEE 802.11b mode / Mid / Chain 0

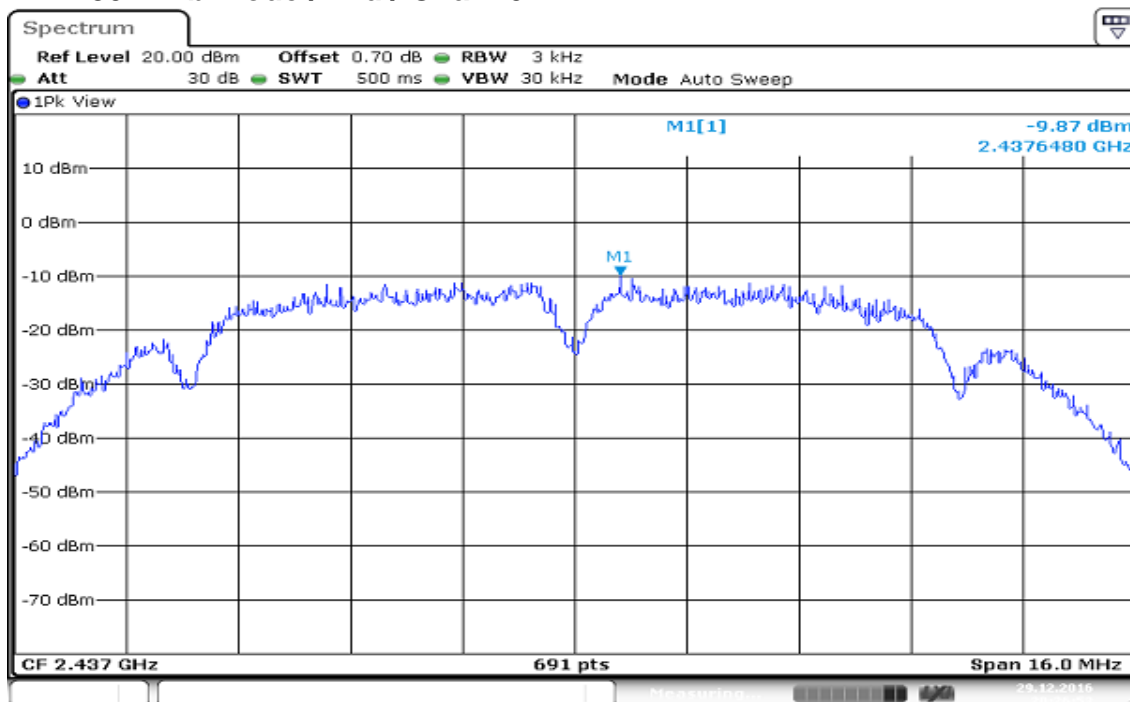

IEEE 802.11b mode / High / Chain 0

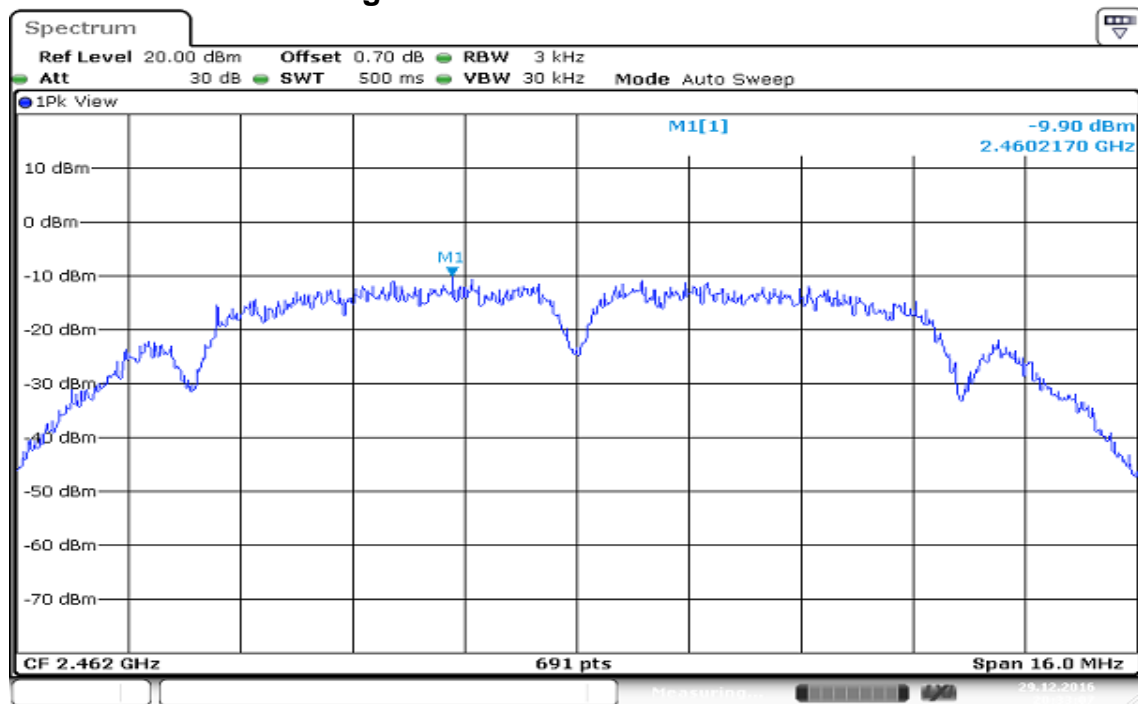

Date: 29.DEC.2016 20:33:07

IEEE 802.11g mode / Low / Chain 0

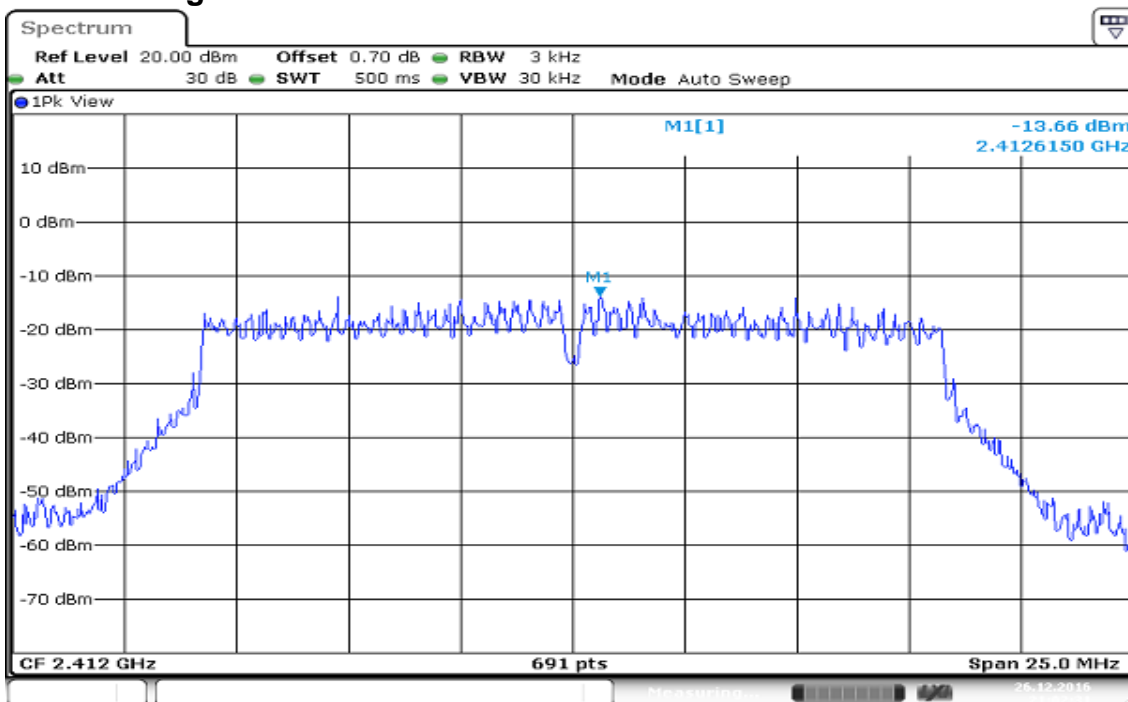

Date: 26 DEC 2016 21:02:32

IEEE 802.11g mode / Mid / Chain 0

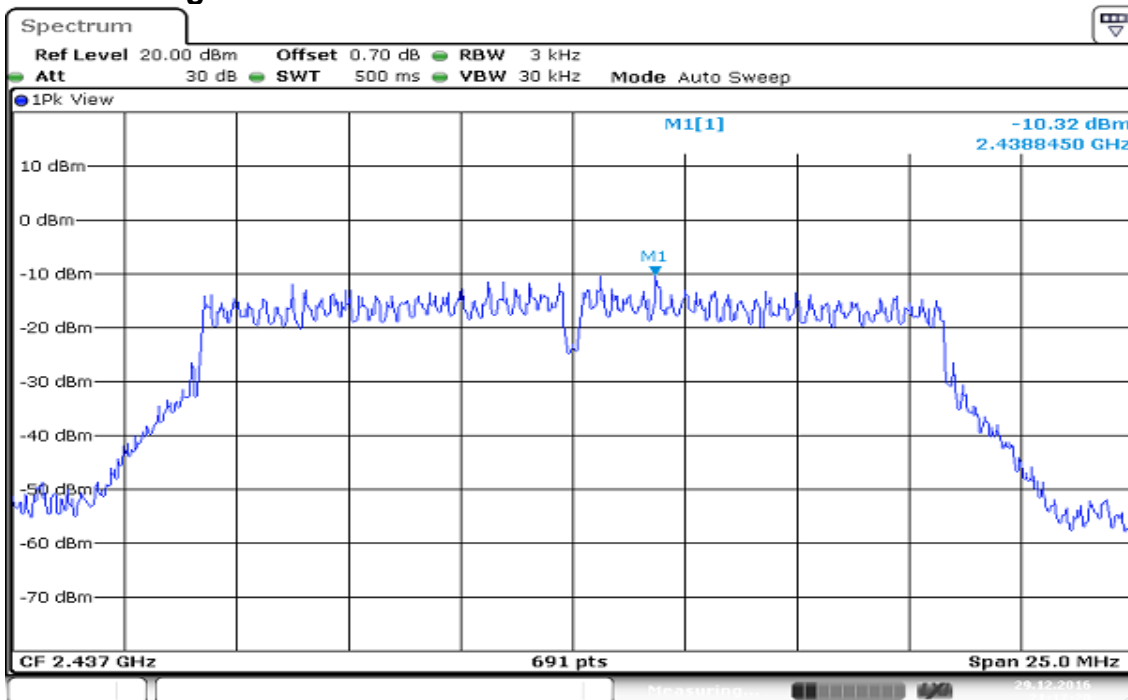

Date: 29 DEC 2016 21:17:20

IEEE 802.11g mode / High / Chain 0

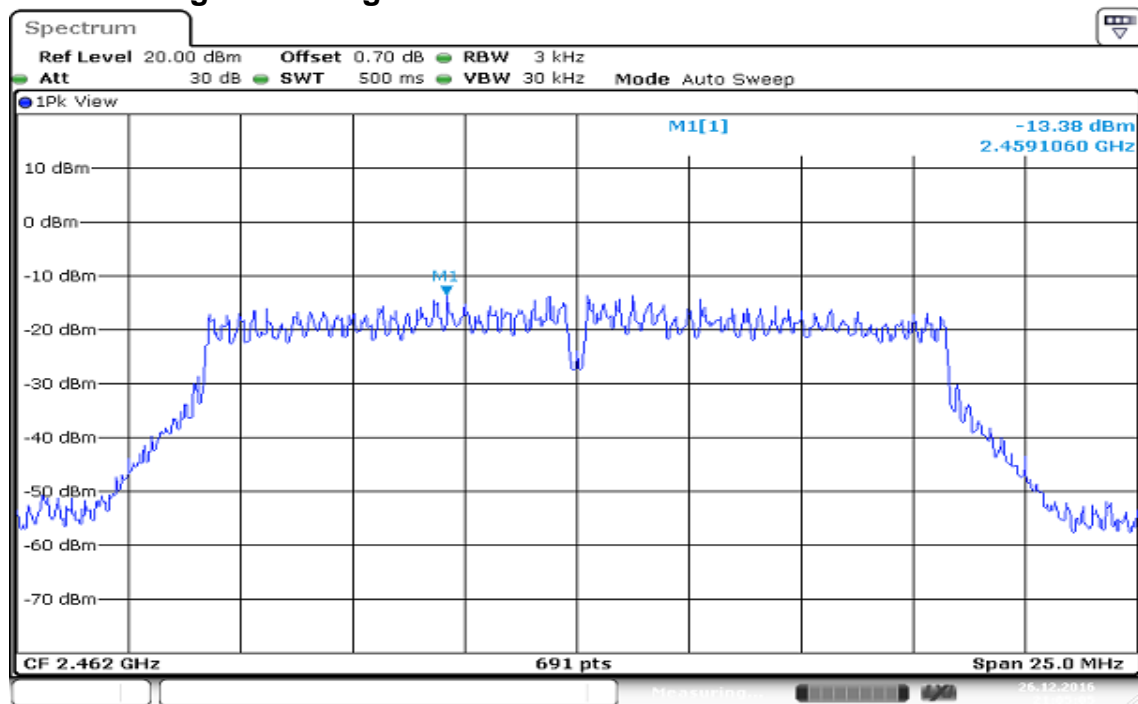

Date: 26 DEC 2016 21:05:05

IEEE 802.11n HT 20 MHz mode / Low / Chain 0

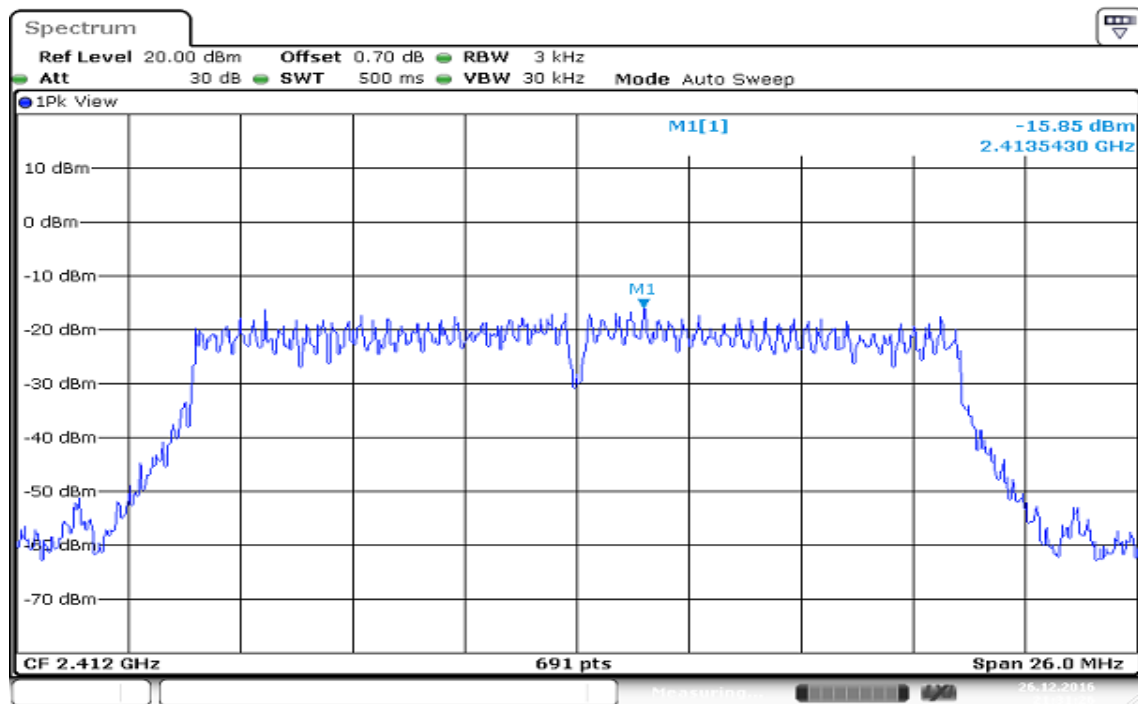

Date: 26 DEC 2016 21:31:27

IEEE 802.11n HT 20 MHz mode / Mid / Chain 0

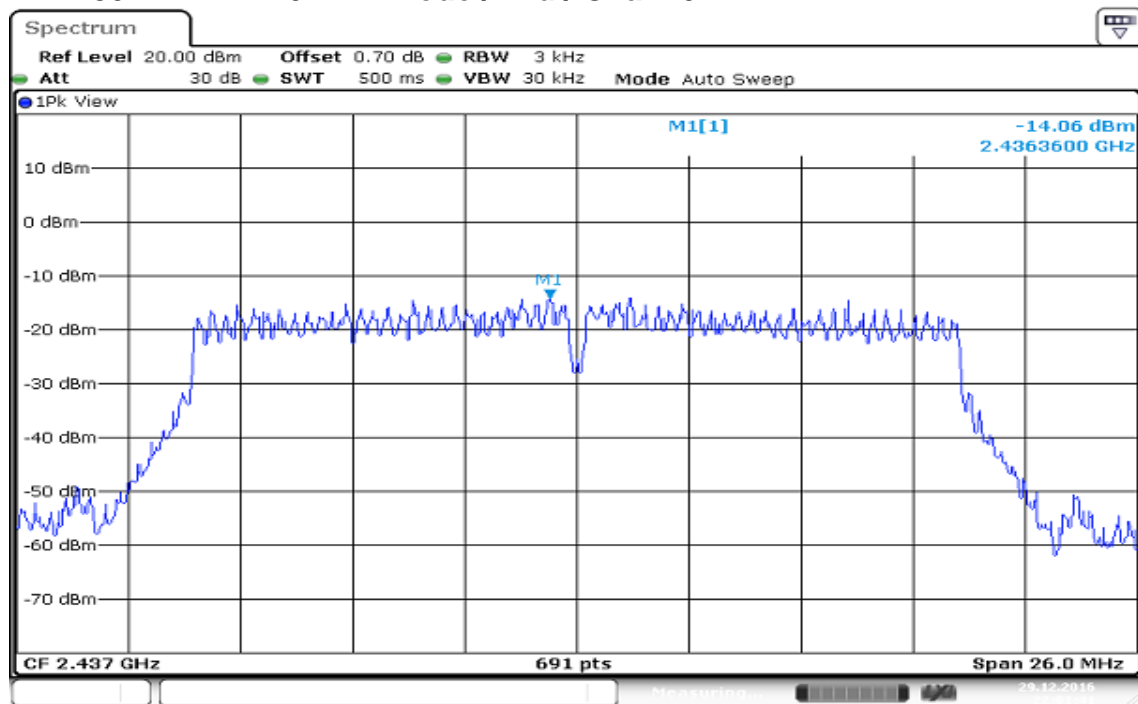

Date: 29 DEC 2016 22:01:40

IEEE 802.11n HT 20 MHz mode / High / Chain 0

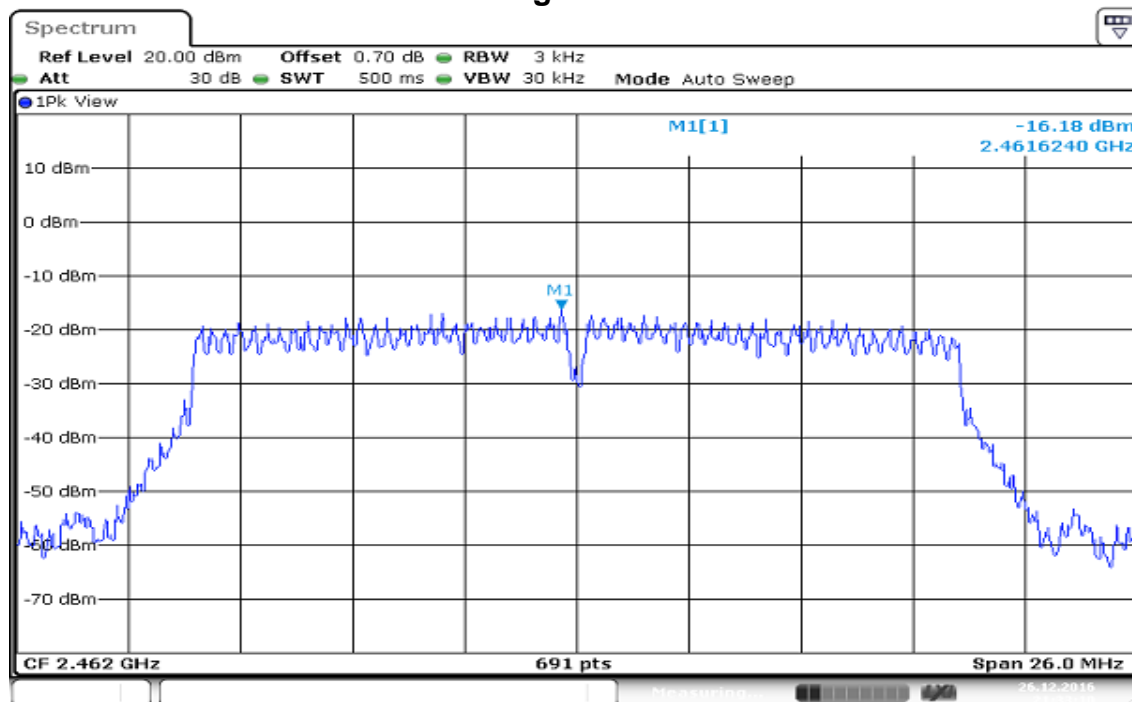

IEEE 802.11n HT 20 MHz mode / Low / Chain 1

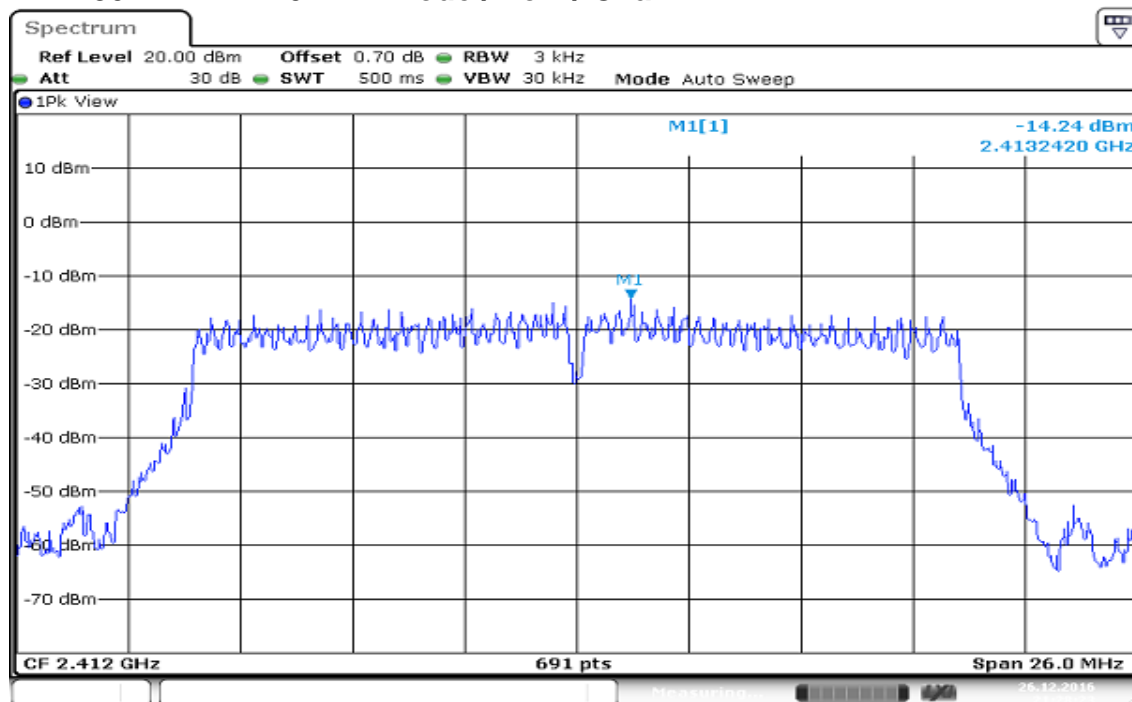

IEEE 802.11n HT 20 MHz mode / Mid / Chain 1

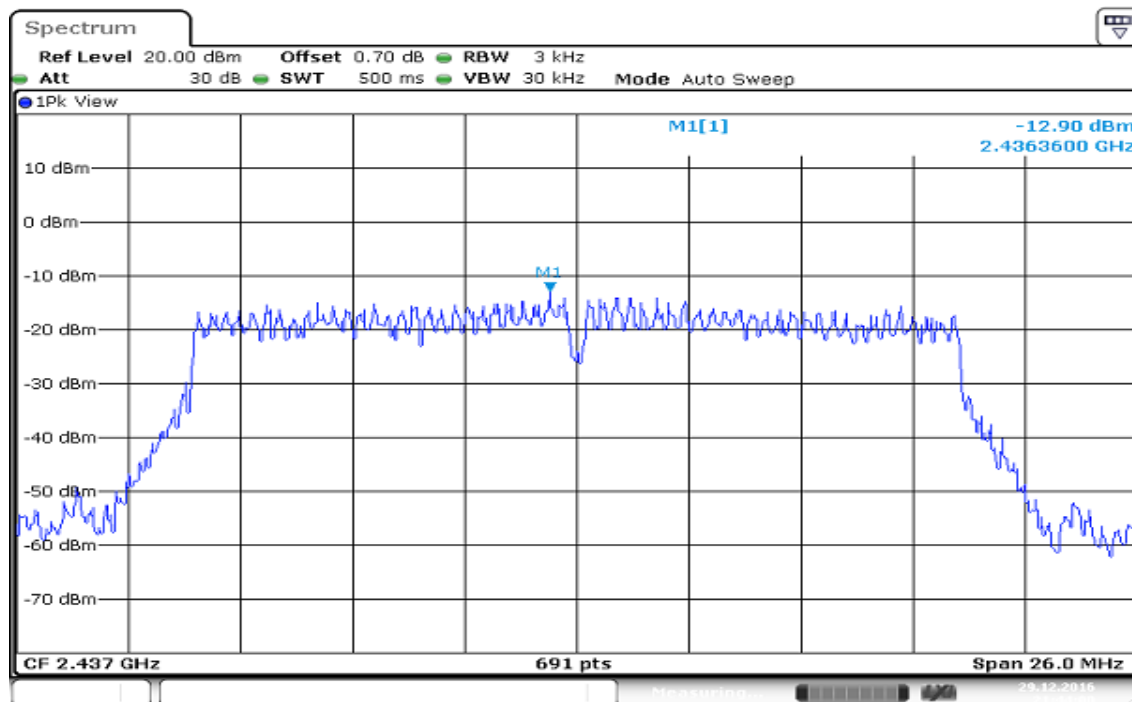

IEEE 802.11n HT 20 MHz mode / High / Chain 1

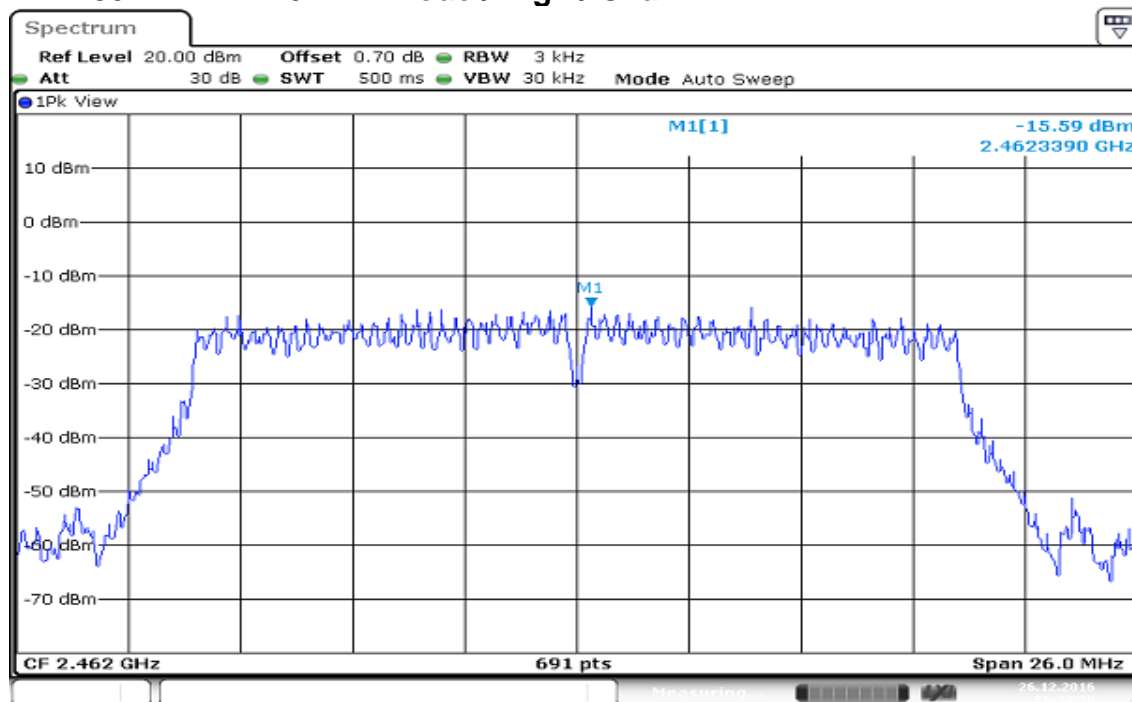

IEEE 802.11n HT 40 MHz mode / Low / Chain 0

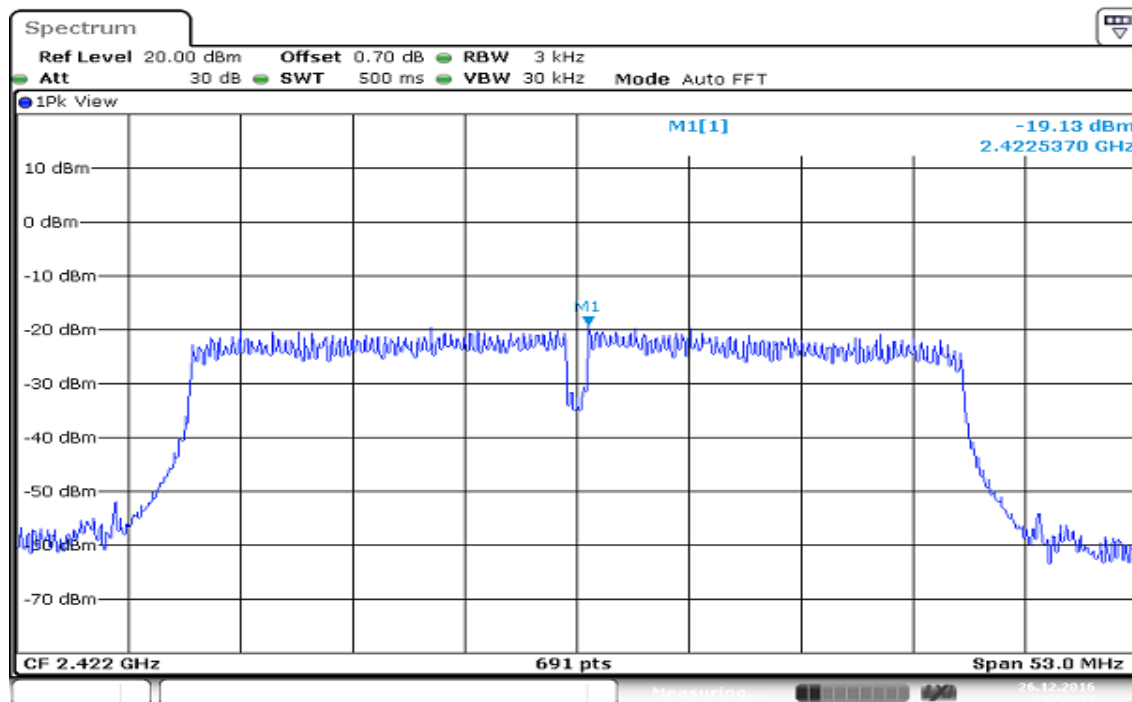

IEEE 802.11n HT 40 MHz mode / Mid / Chain 0

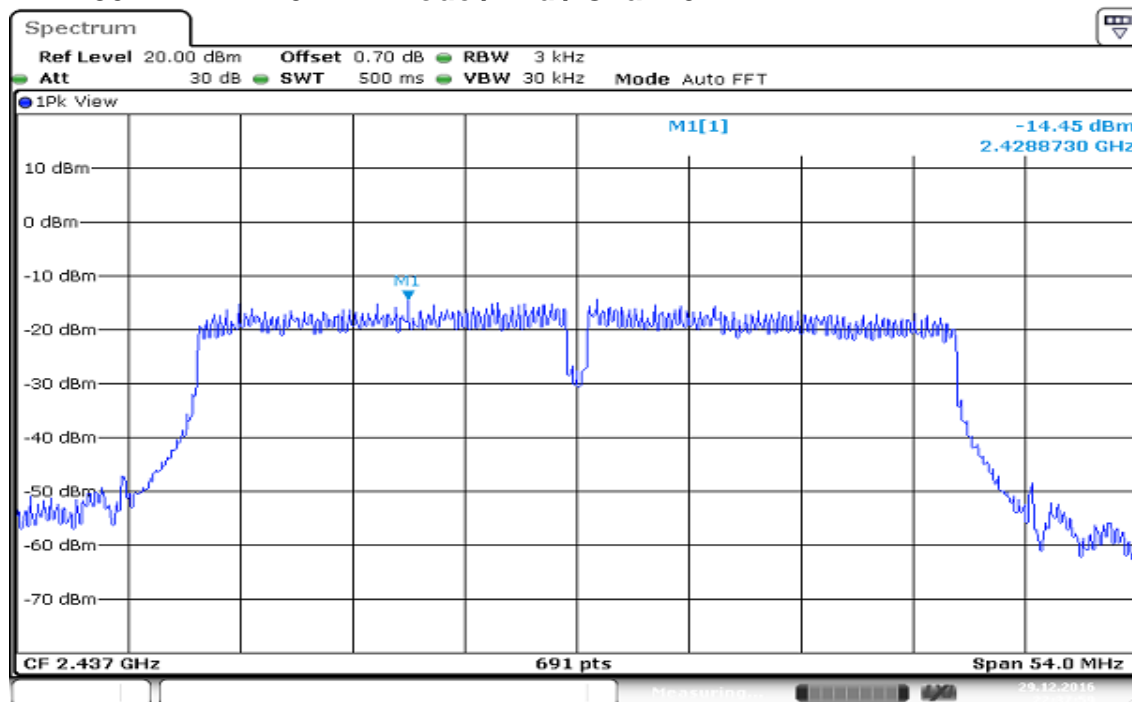

IEEE 802.11n HT 40 MHz mode / High / Chain 0

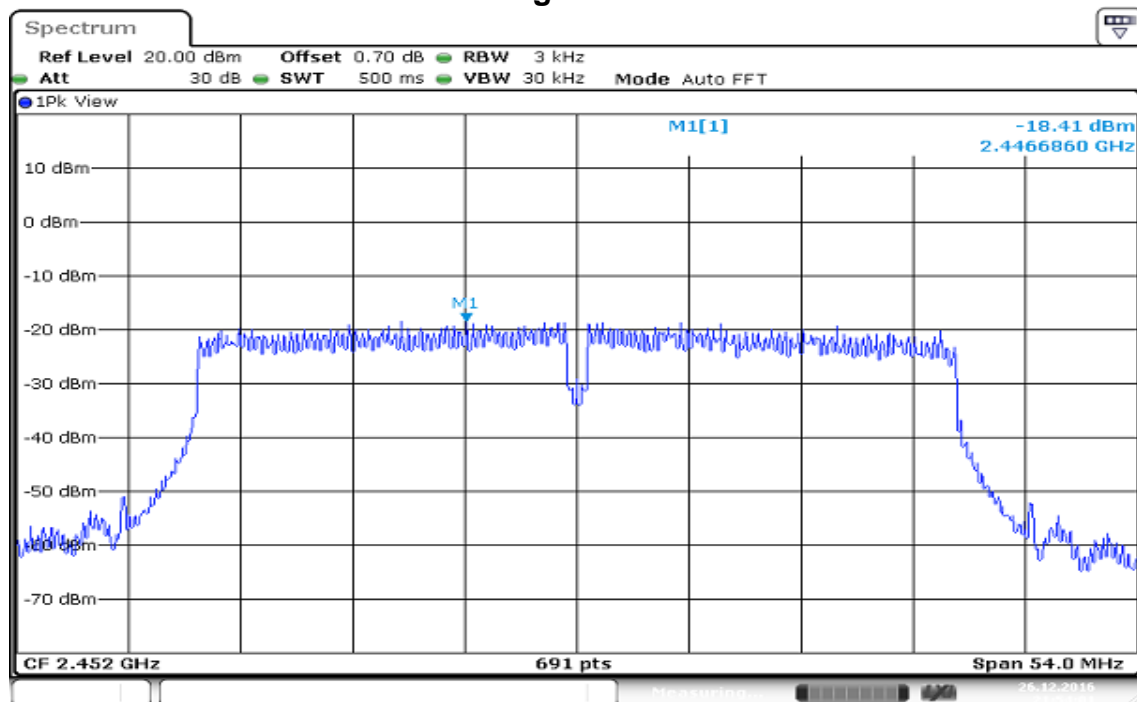

IEEE 802.11n HT 40 MHz mode / Low / Chain 1

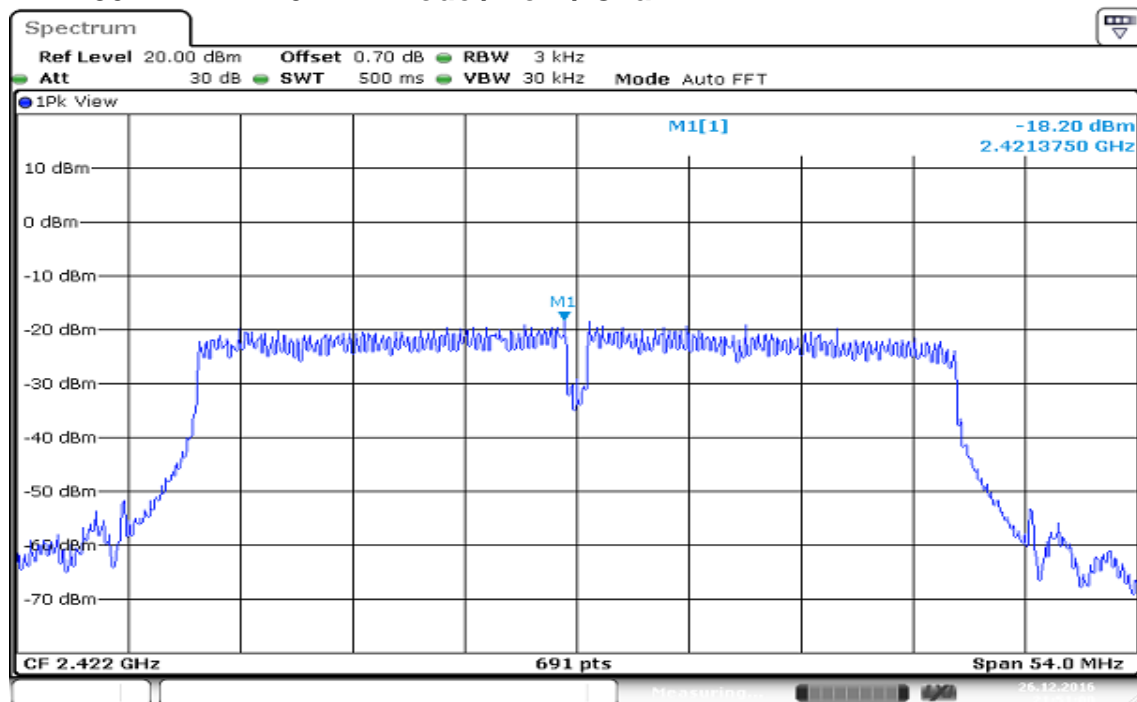

IEEE 802.11n HT 40 MHz mode / Mid / Chain 1

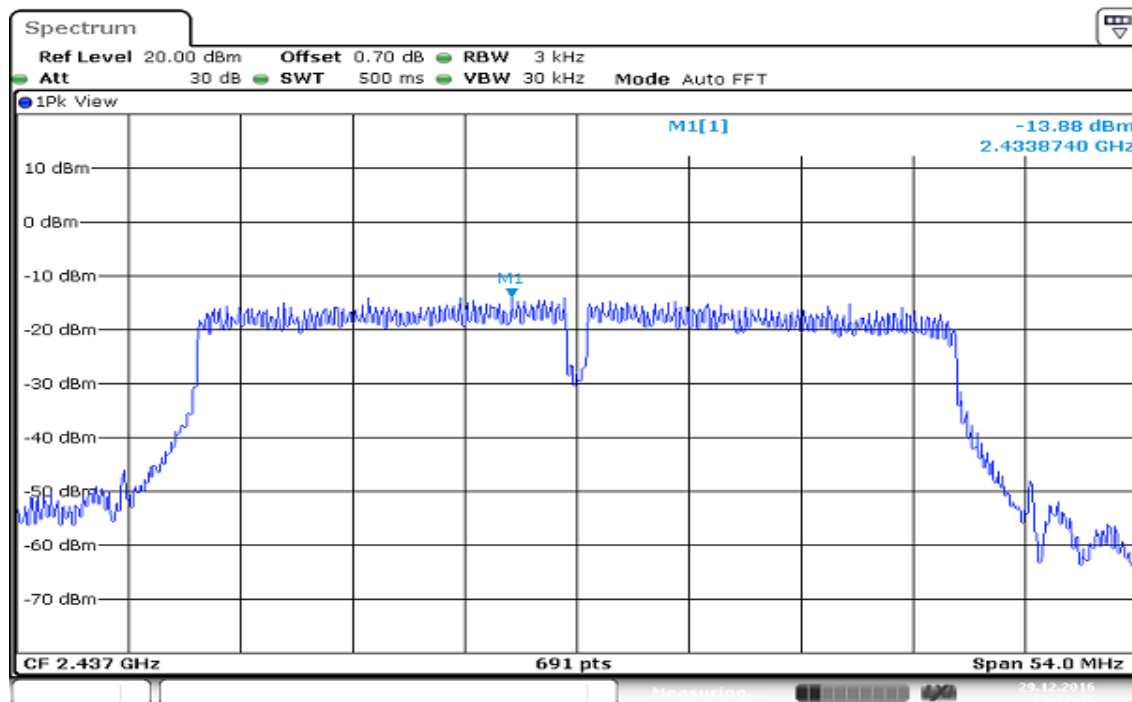

IEEE 802.11n HT 40 MHz mode / High / Chain 1

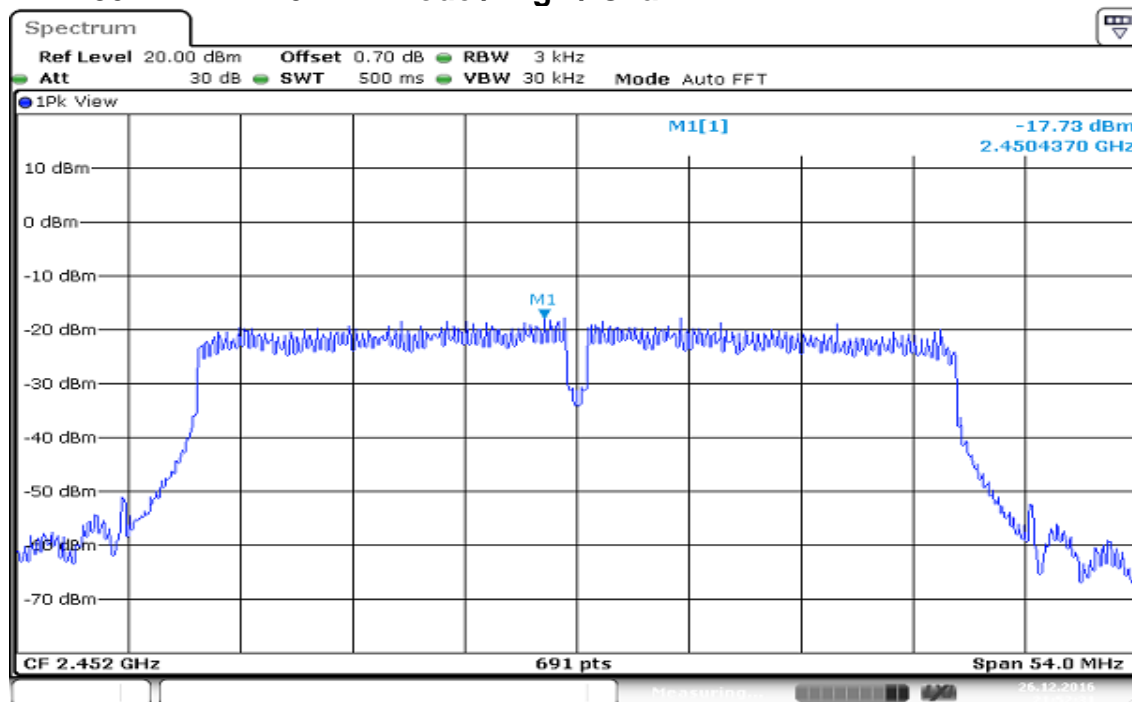

4.5 CONDUCTED BANDEDGE AND SPURIOUS EMISSION

4.5.1 Test Limit

According to §15.247(d).

In any 100 kHz bandwidth outside the authorized frequency band,

Non-restricted bands shall be attenuated at least 20 dB/30 dB relative to the maximum PSD level in 100 kHz by RF conducted or a radiated measurement which fall in the restricted bands, as defined in §15.205(a), must also comply with the radiated emission limits specified in §15.209(a).

4.5.2 Test Procedure

Test method Refer as KDB 558074 D01 v03r05, Section 11.

1. EUT RF output port connected to the SA by RF cable, and the path loss was compensated to result.
2. SA setting, RBW=100kHz, VBW=300kHz, Detector=Peak, Trace mode = max hold, SWT = Auto.
3. In any 100 kHz bandwidth outside the authorized frequency band, shall be attenuated at least 20 dB relative to the maximum in-band peak PSD level in 100 kHz when conducted power procedure is used. If the transmitter complies with the conducted power limits based on the use of RMS averaging over a time interval, the attenuation required under this paragraph shall be 30 dB instead of 20 dB.

4.5.3 Test Setup

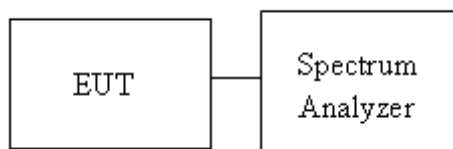

4.5.4 Test Result

Test Data

IEEE 802.11b mode Low CH chain 0

Reference Level of PSD in 100

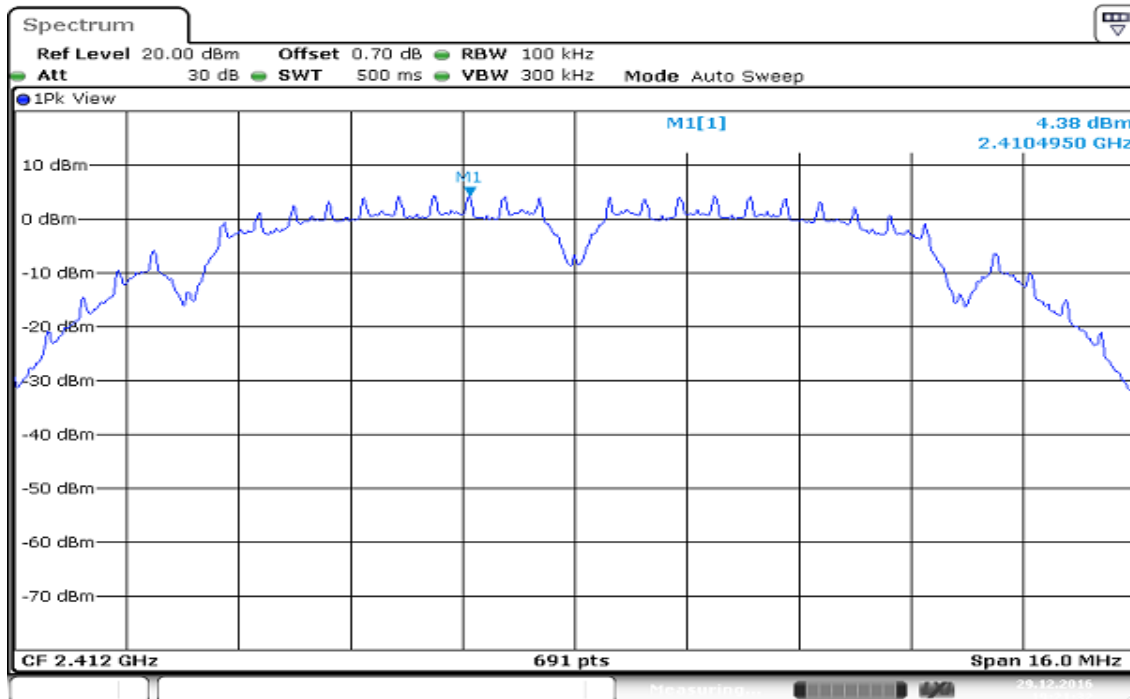

Band Edge

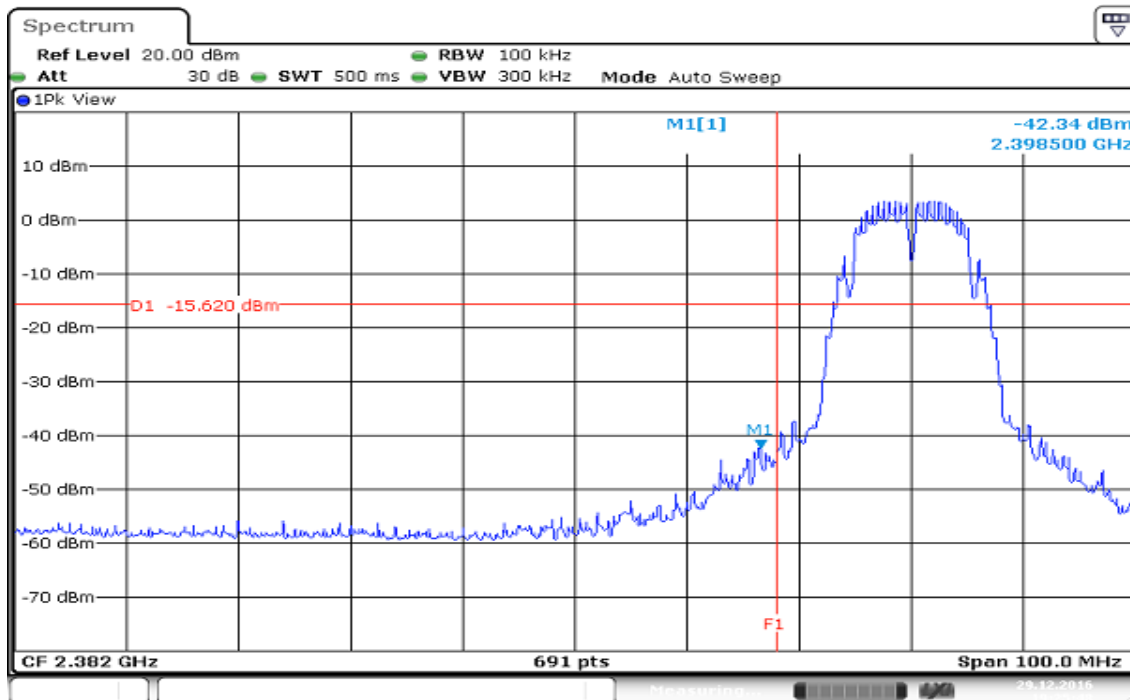

Spurious Emission 30MHz-25GHz

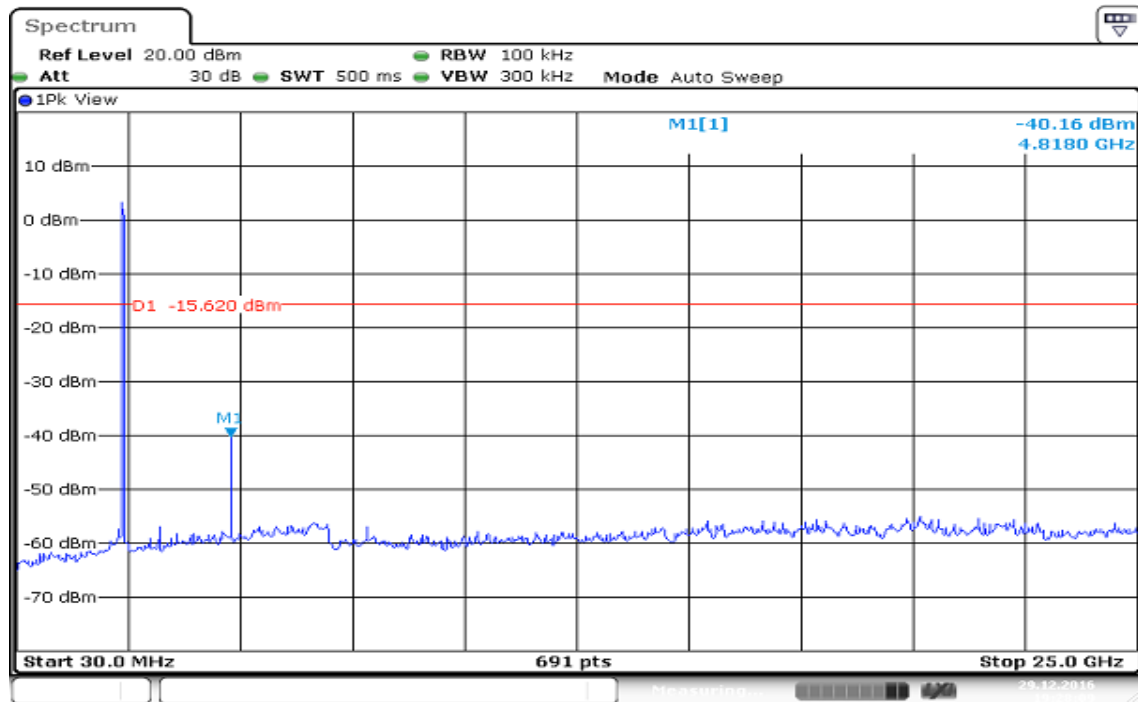

Date: 29.DEC.2016 19:28:09

IEEE 802.11b mode Mid CH chain 0

Reference Level of PSD in 100kHz

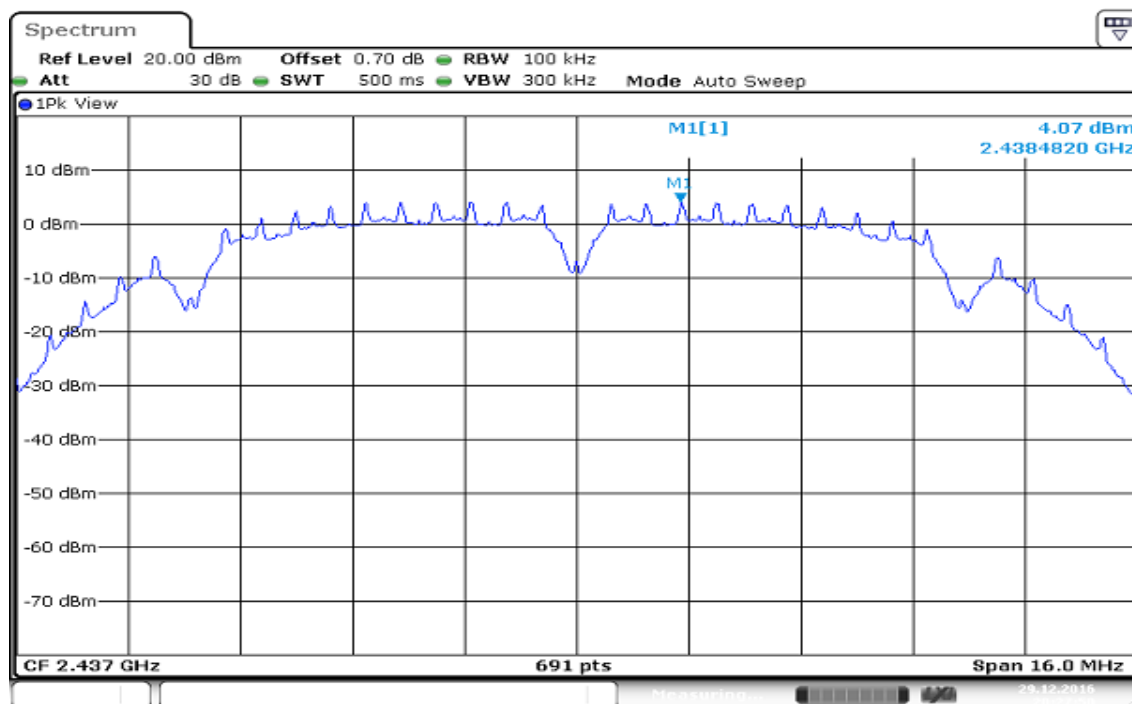

Spurious Emission 30MHz-25GHz

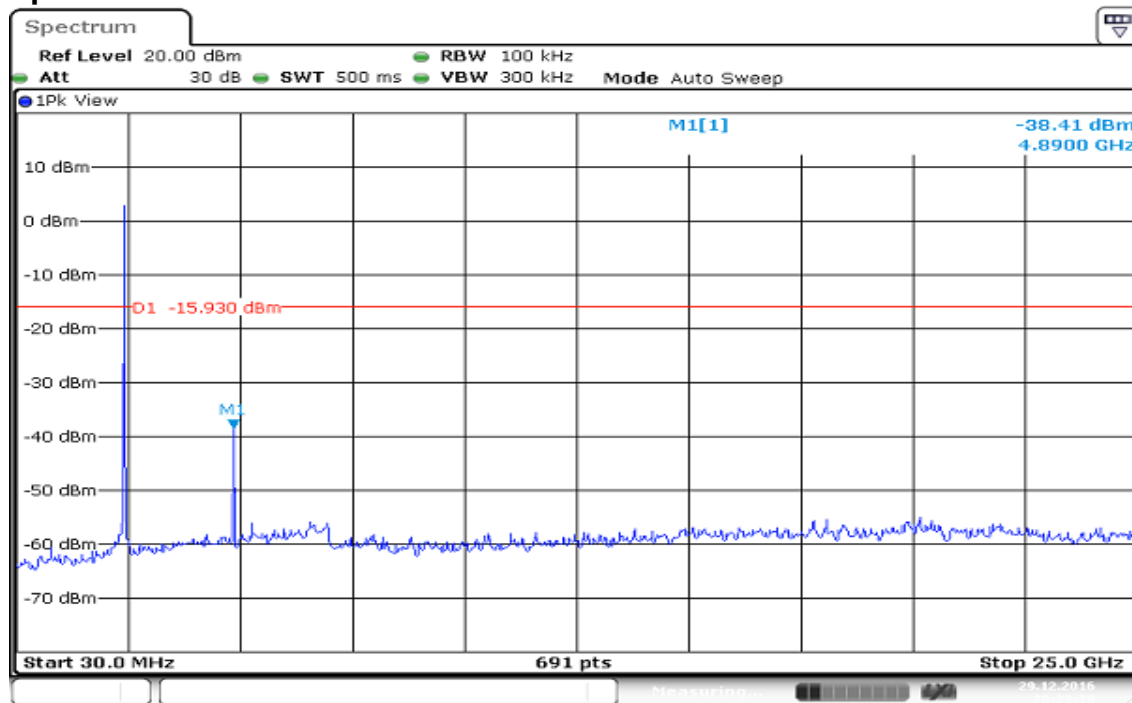

IEEE 802.11b mode High CH chain 0
Reference Level of PSD in 100kHz

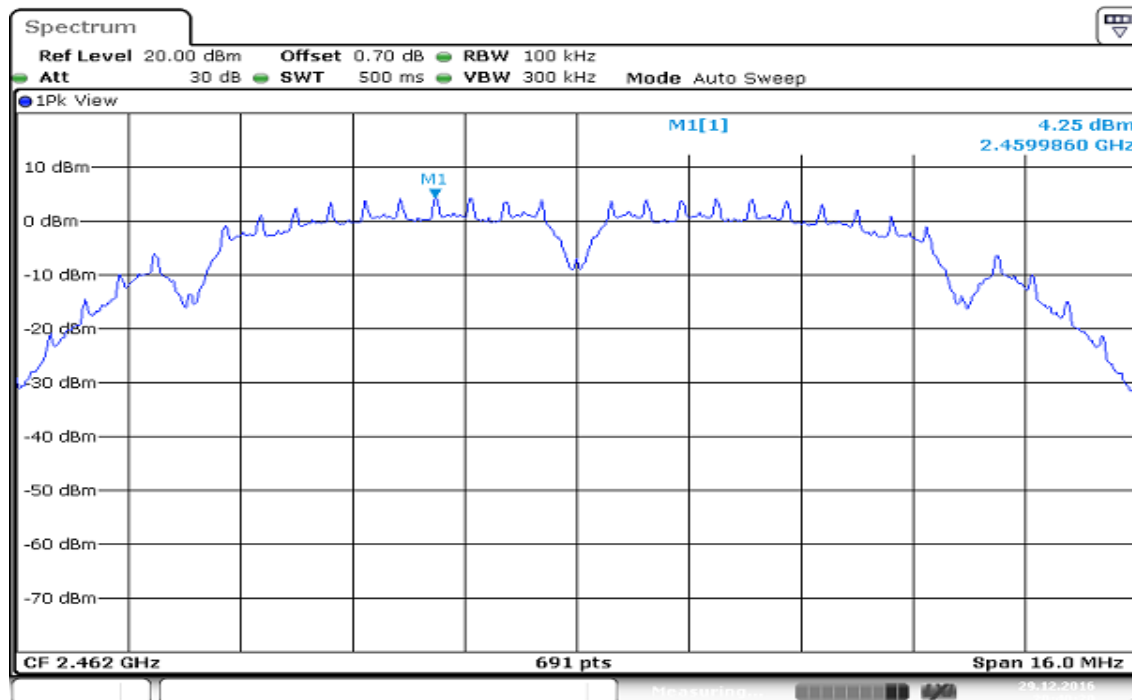

Band Edge

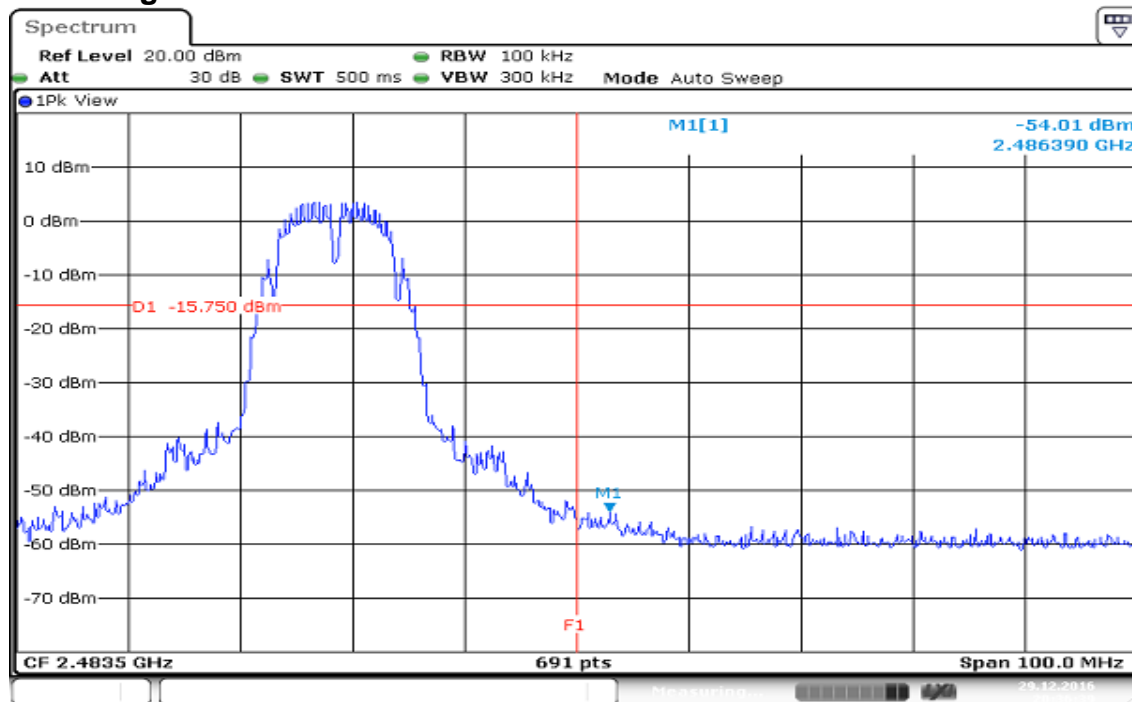

Spurious Emission 30MHz-25GHz

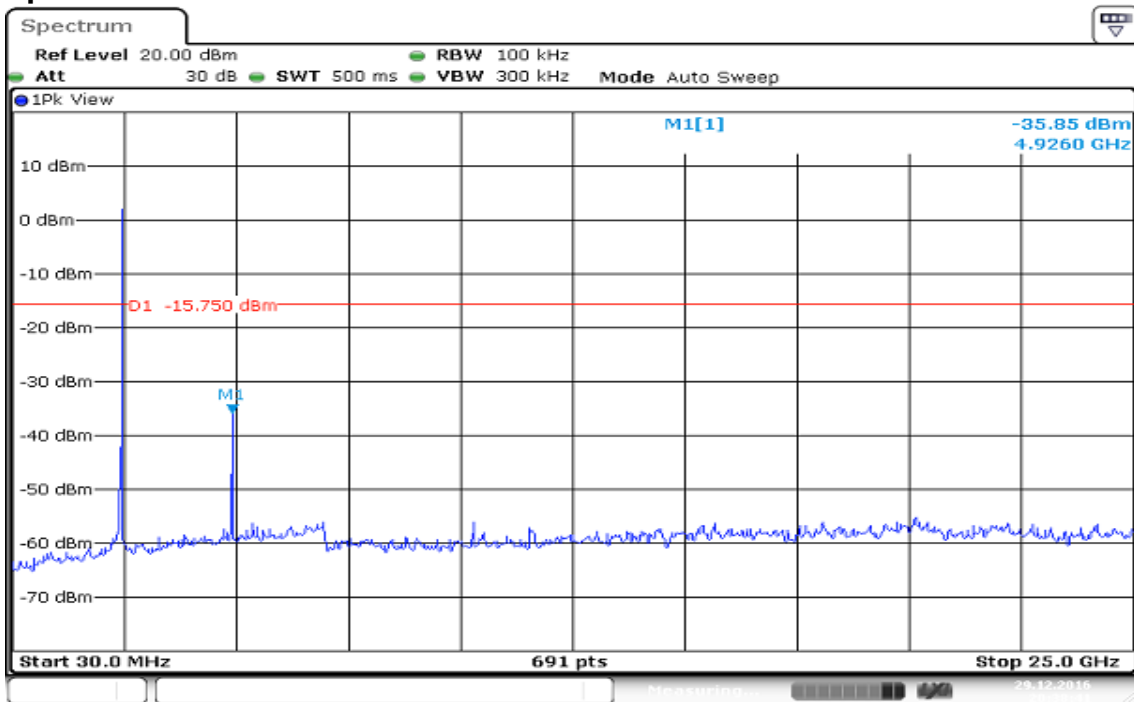

Date: 29.DEC.2016 20:38:41

IEEE 802.11g mode Low CH chain 0
Reference Level of PSD in 100kHz

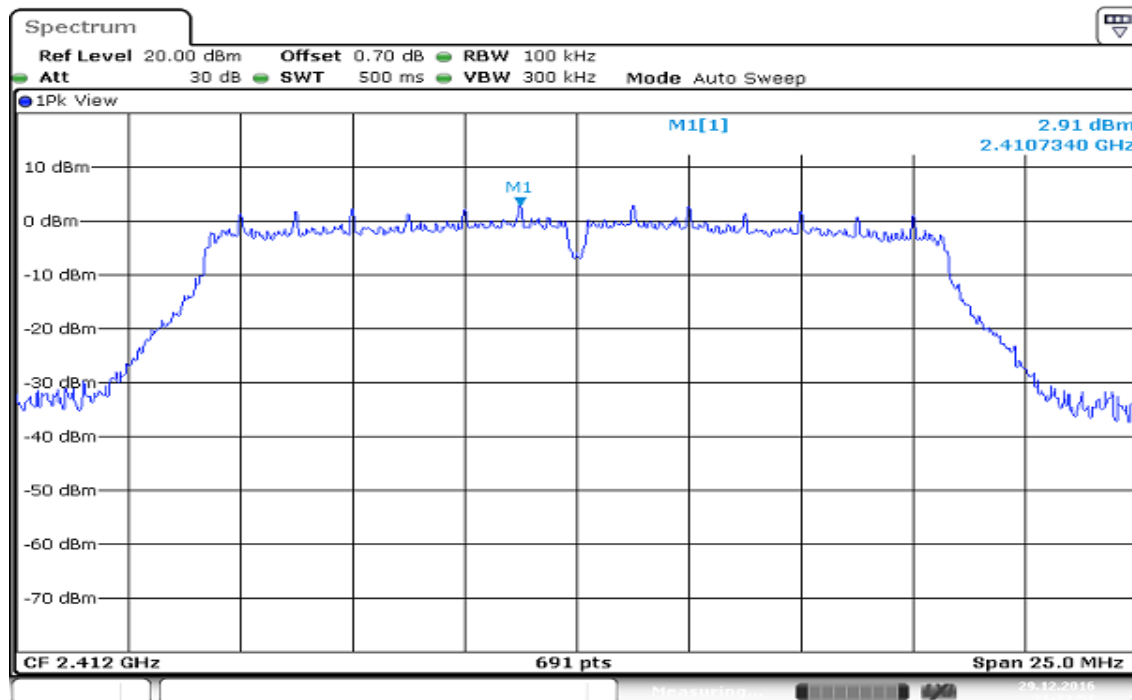

Band Edge

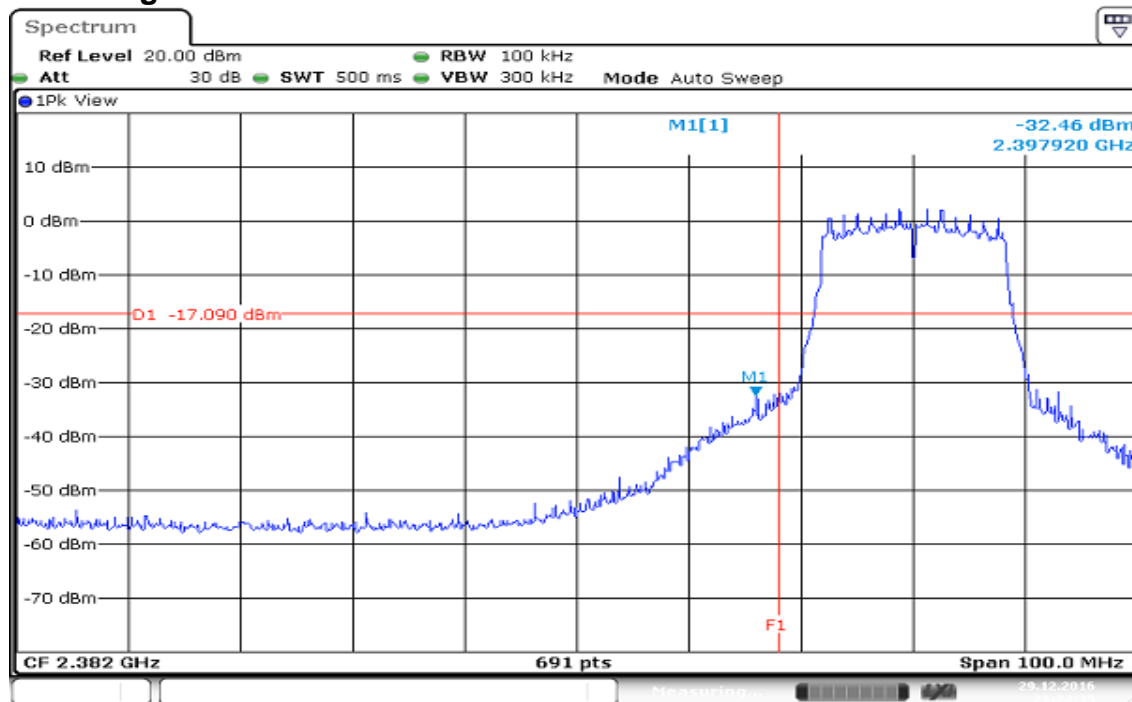

Spurious Emission 30MHz-25GHz

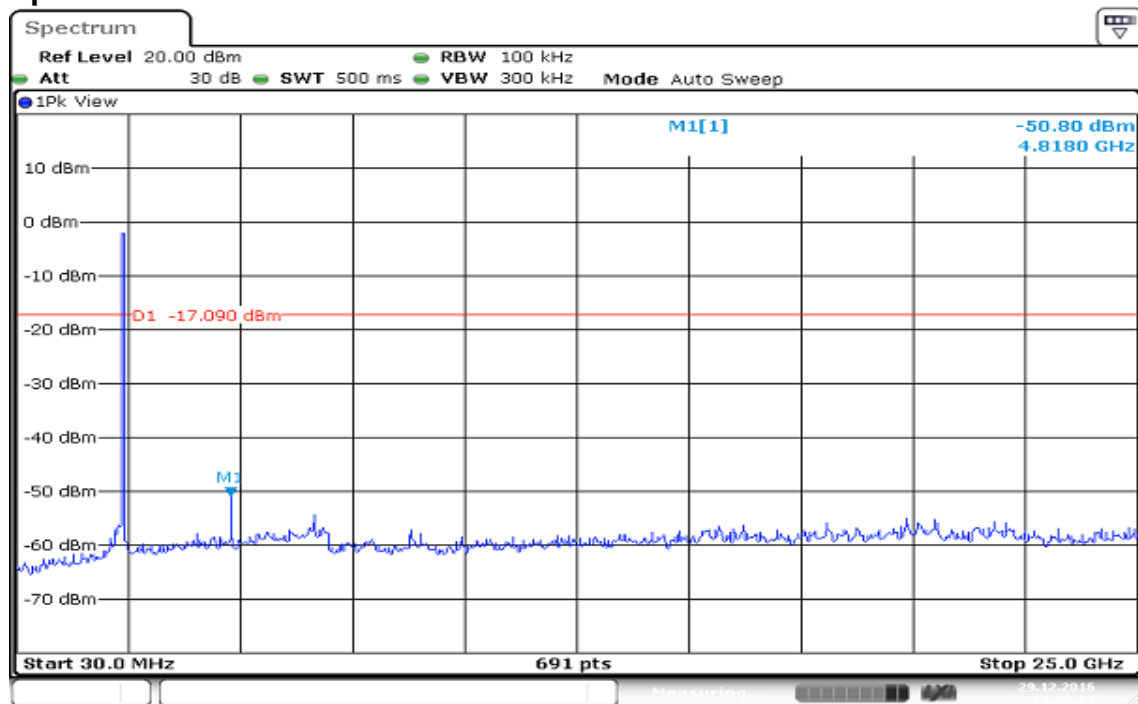

Date: 29.DEC.2016 21:25:23

IEEE 802.11g mode Mid CH chain 0

Reference Level of PSD in 100kHz

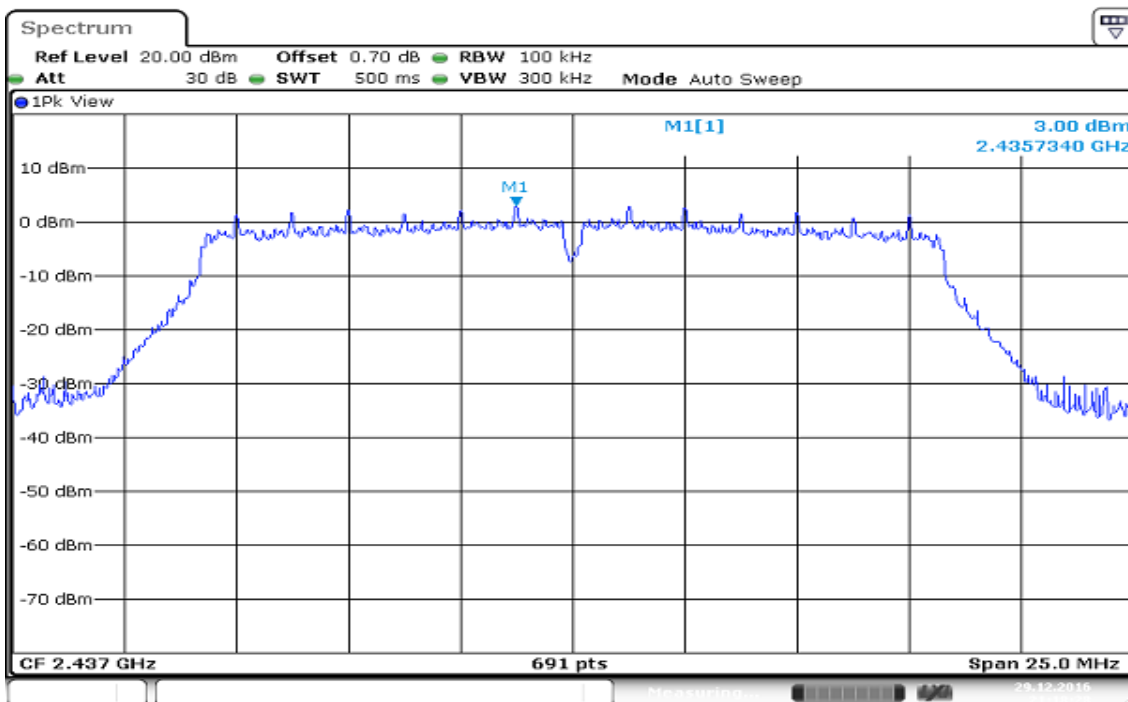

Spurious Emission 30MHz-25GHz

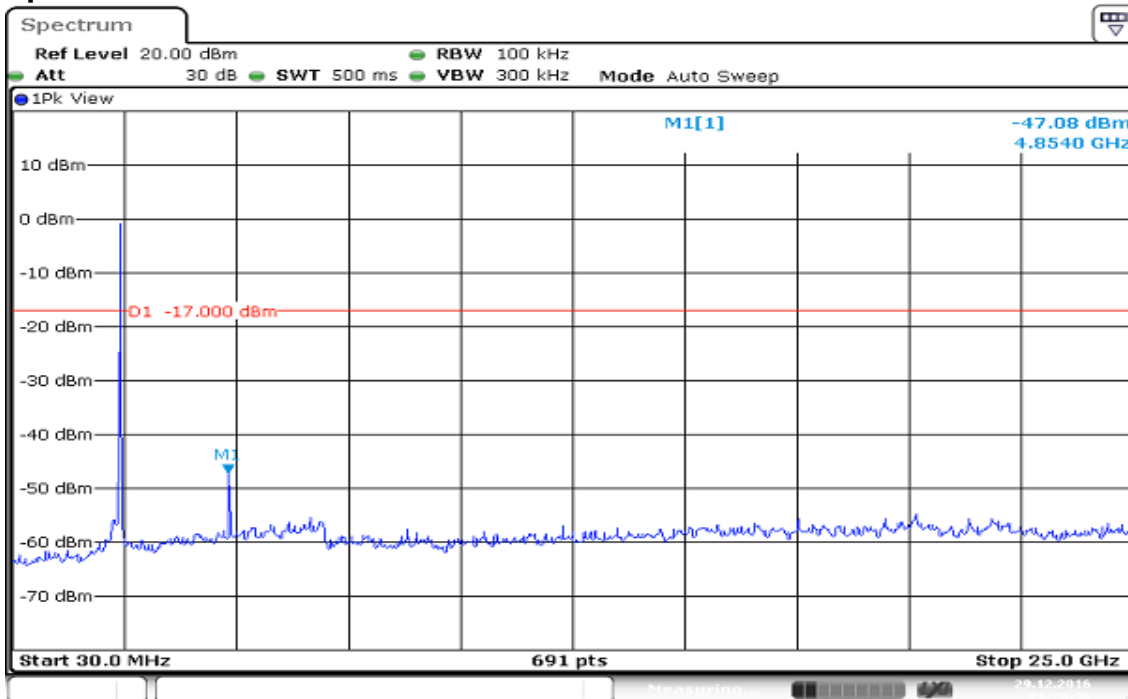

IEEE 802.11g mode High CH chain 0
Reference Level of PSD in 100kHz

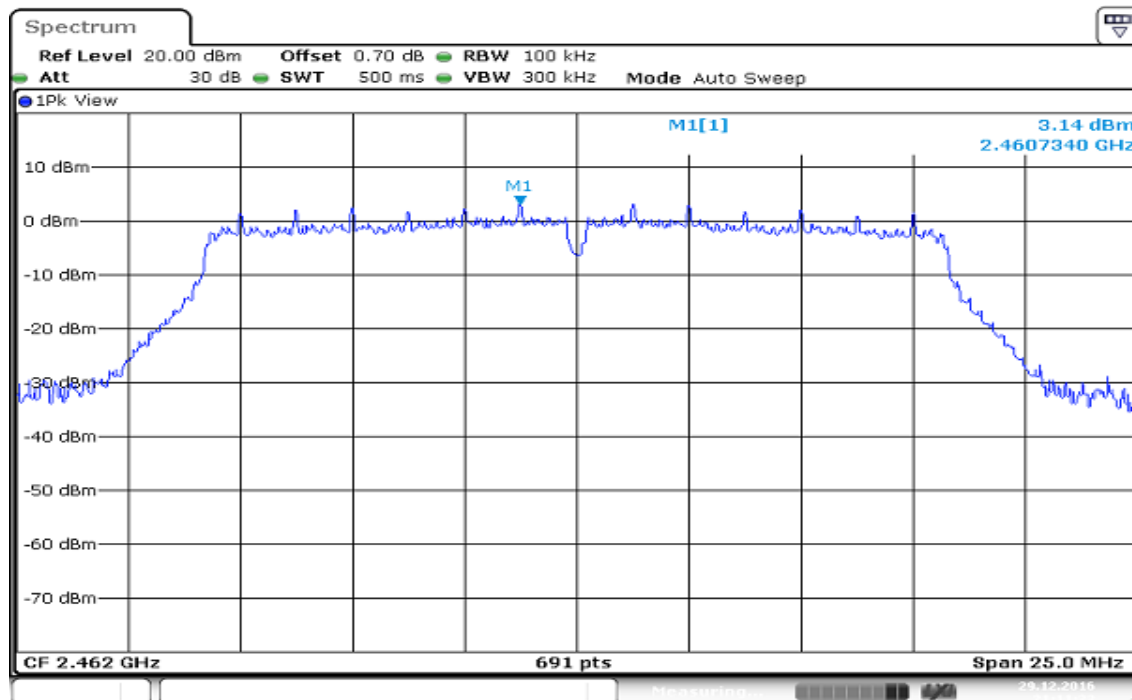

Band Edge

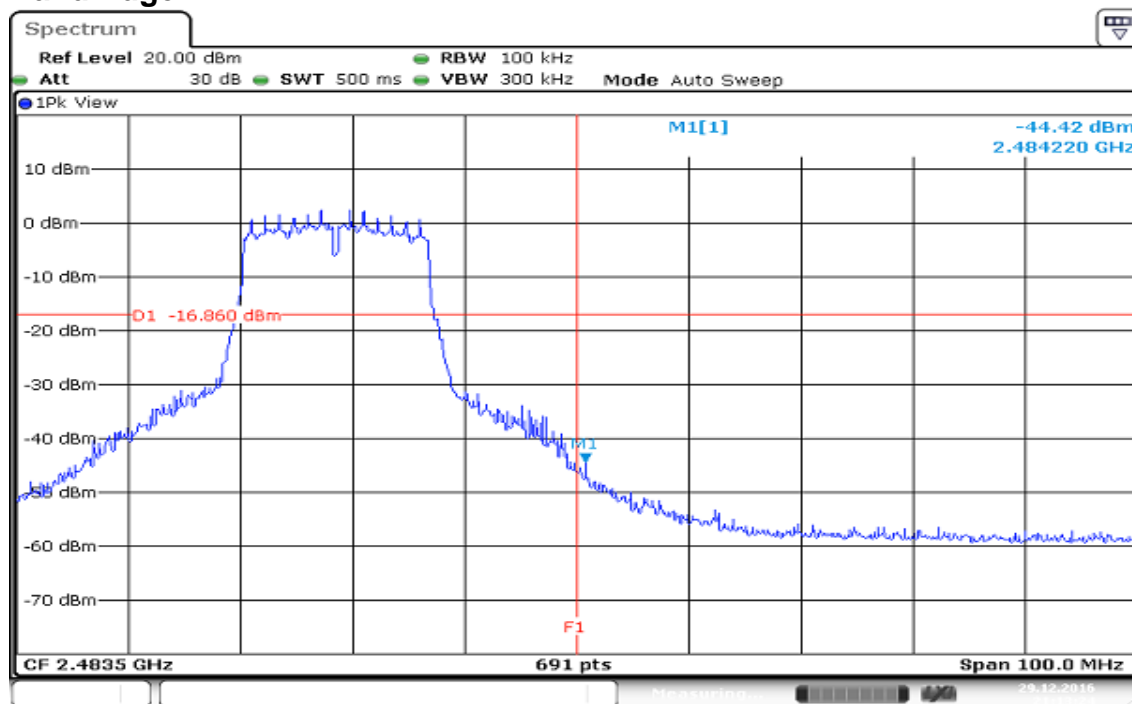

Spurious Emission 30MHz-25GHz

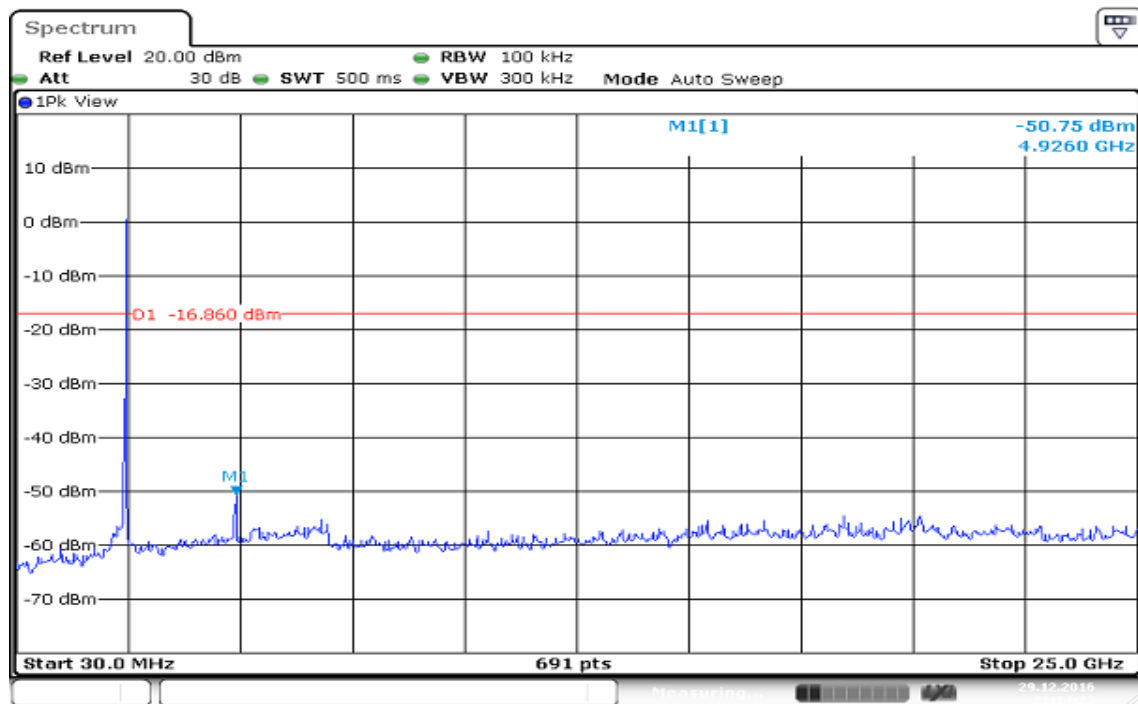

Date: 29. DEC. 2016 21:14:22

IEEE 802.11 n HT20 mode Low CH chain 0

Reference Level of PSD in 100kHz

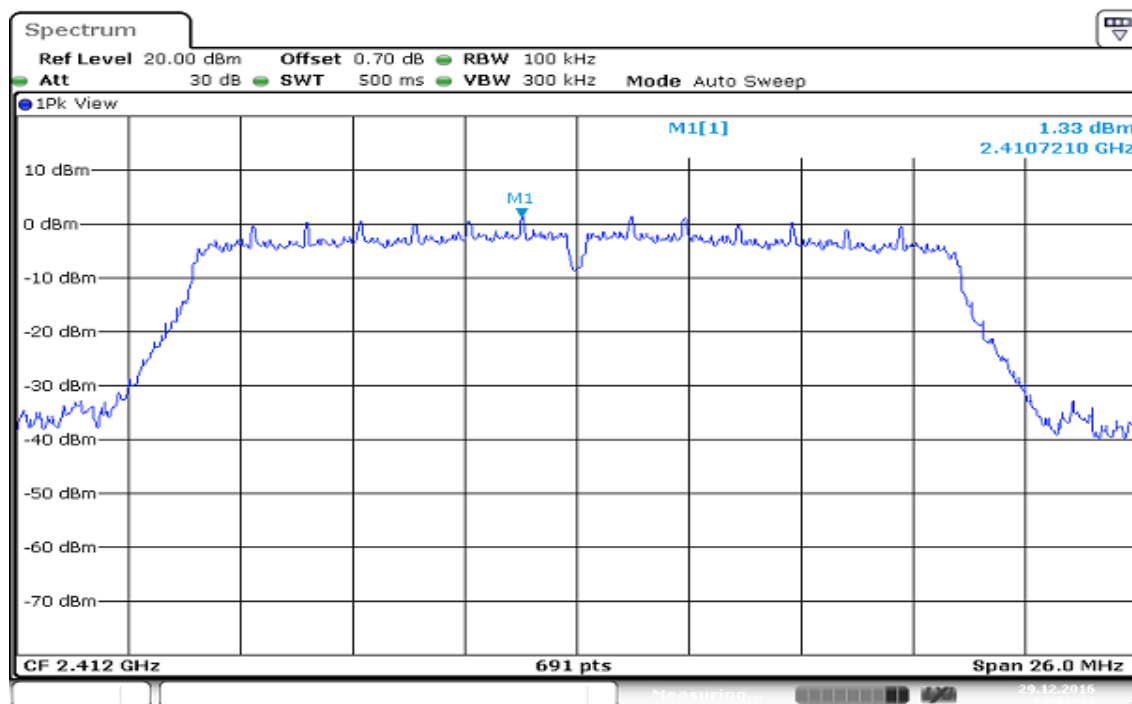

Date: 29. DEC. 2016 22:07:43

Band Edge

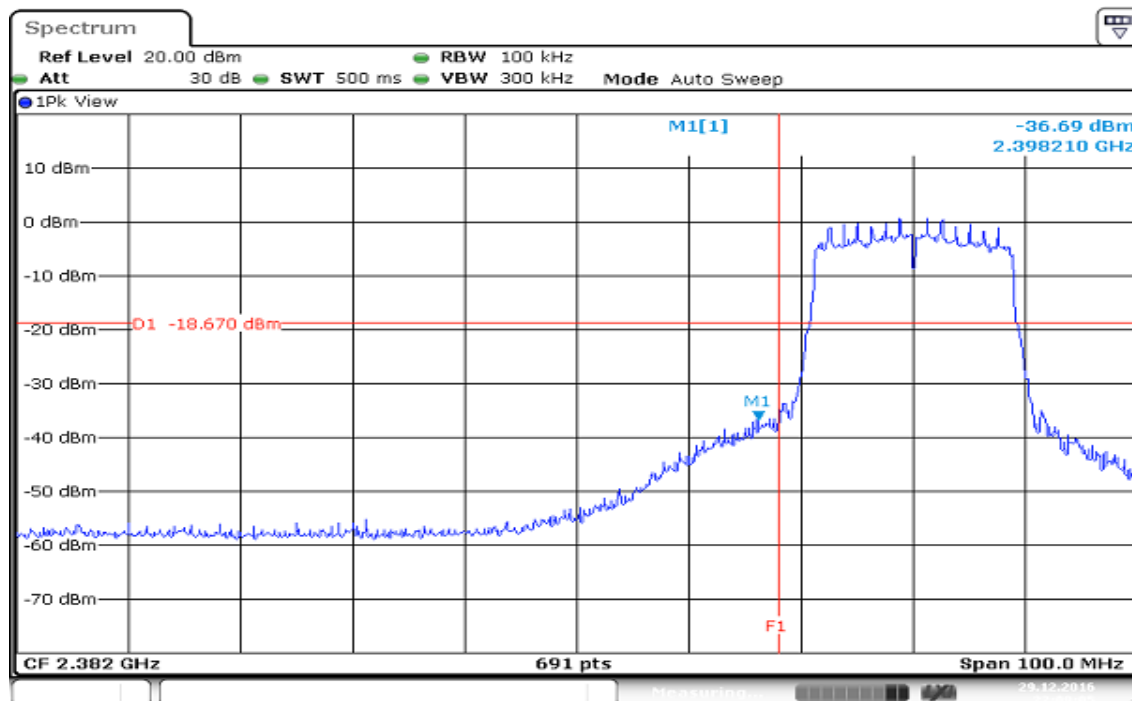

Date: 29. DEC. 2016 22:09:05

Spurious Emission 30MHz-25GHz

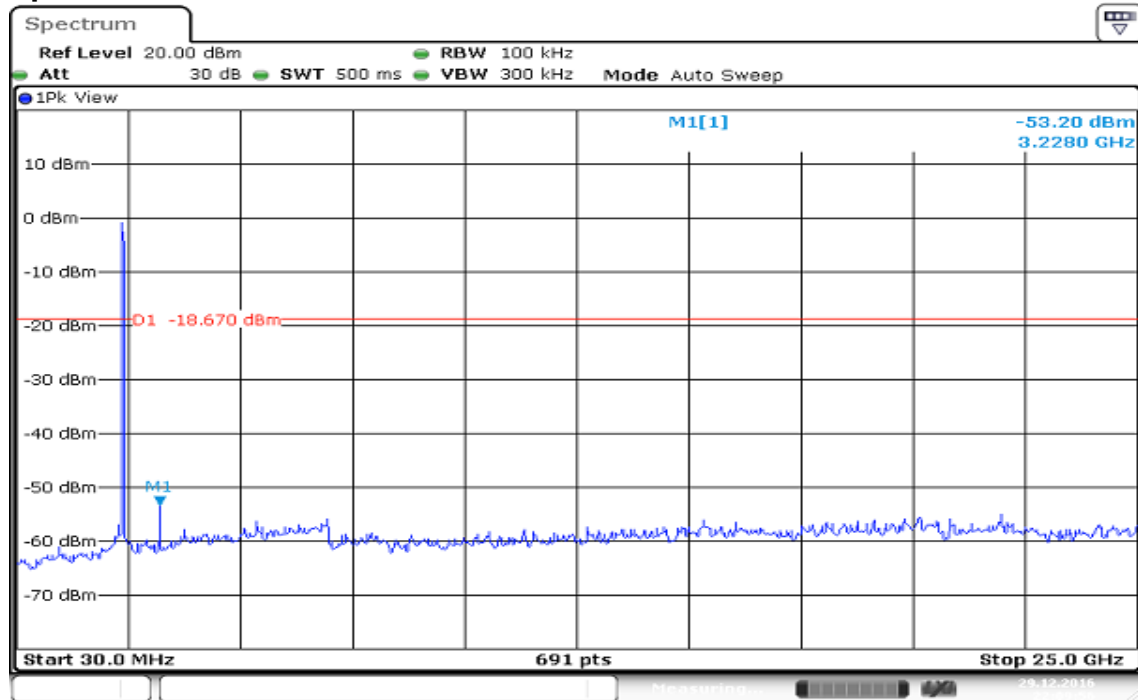

Date: 29.DEC.2016 22:09:56

IEEE 802.11 n HT20 mode Mid CH chain 0

Reference Level of PSD in 100kHz

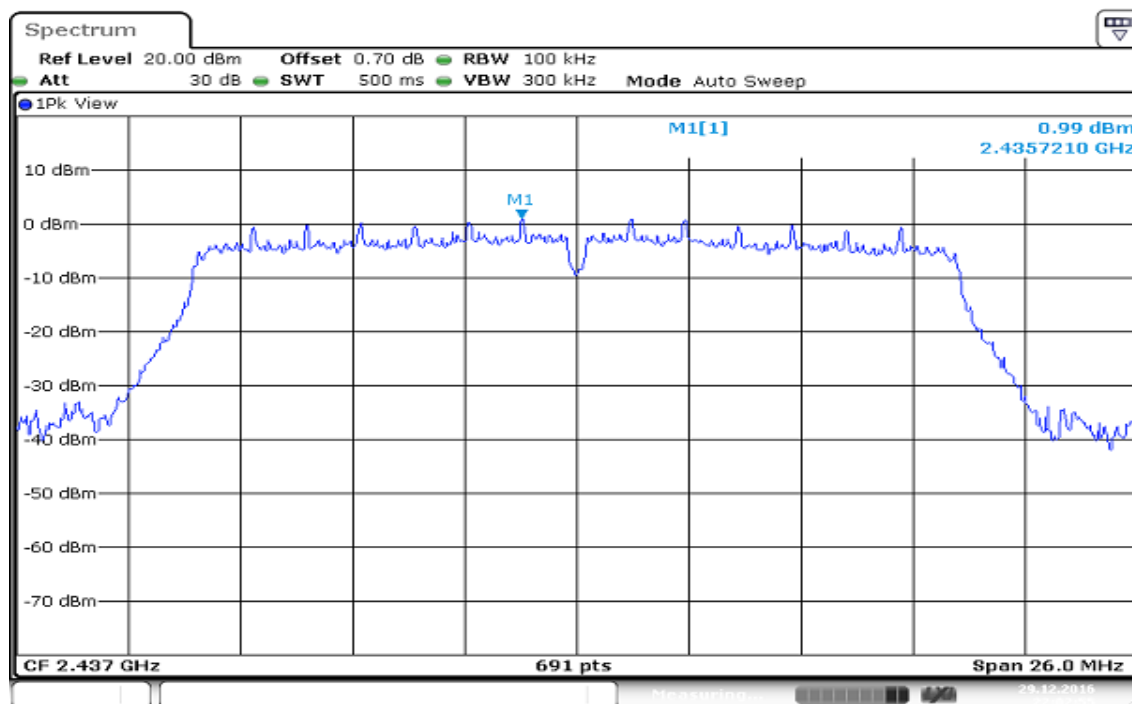

Date: 29. DEC. 2016 22:02:55

Spurious Emission 30MHz-25GHz

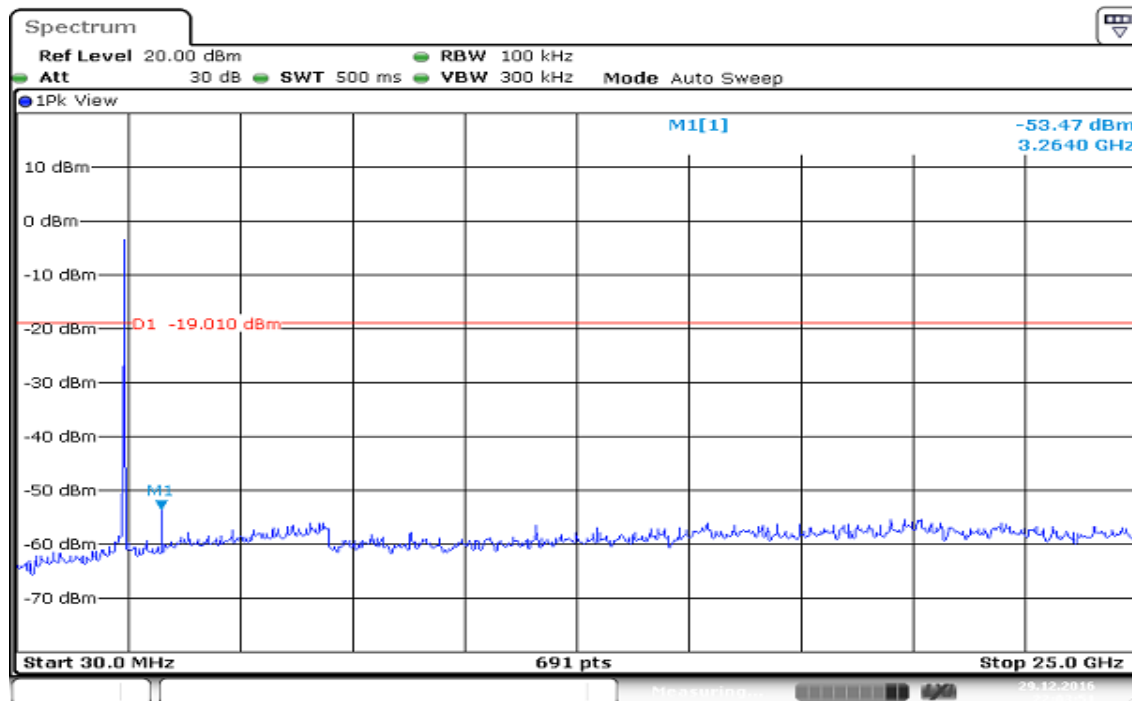

Date: 29. DEC. 2016 22:03:51

IEEE 802.11n HT20 mode High CH chain 0
Reference Level of PSD in 100kHz

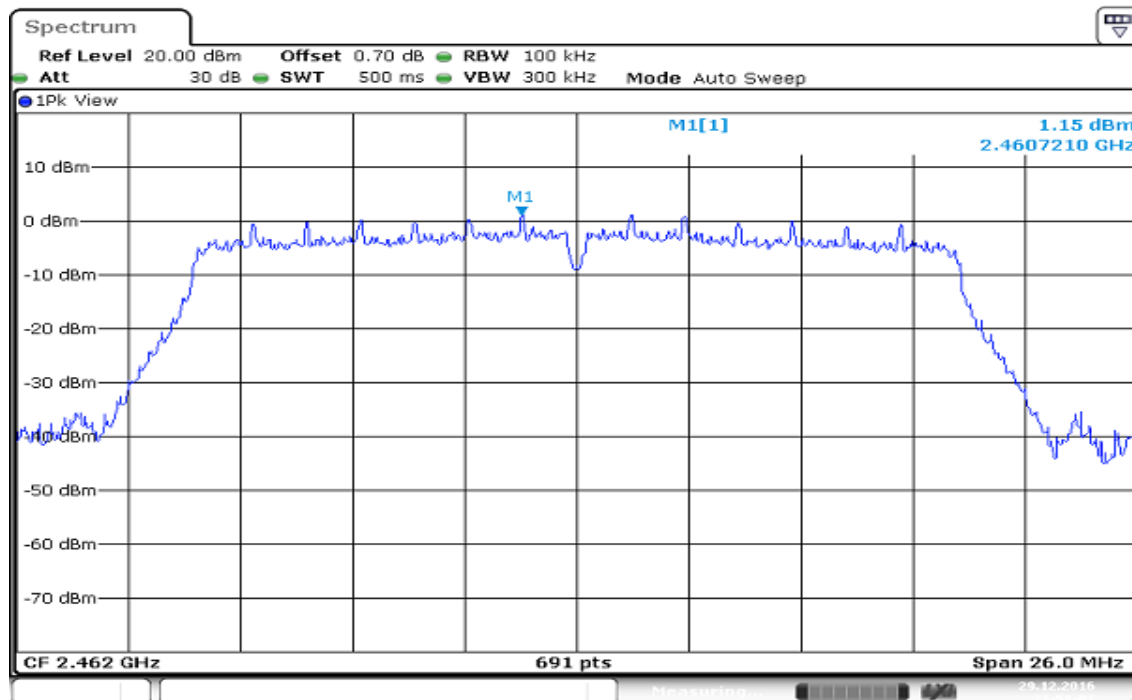

Band Edge

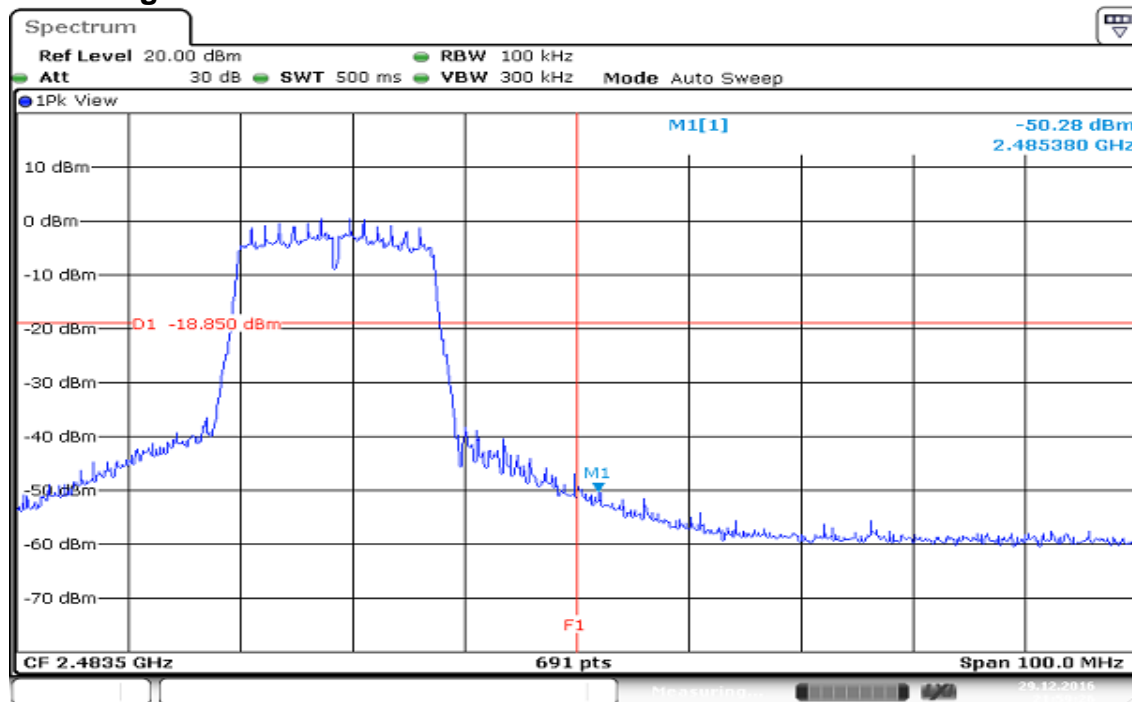

Spurious Emission 30MHz-25GHz

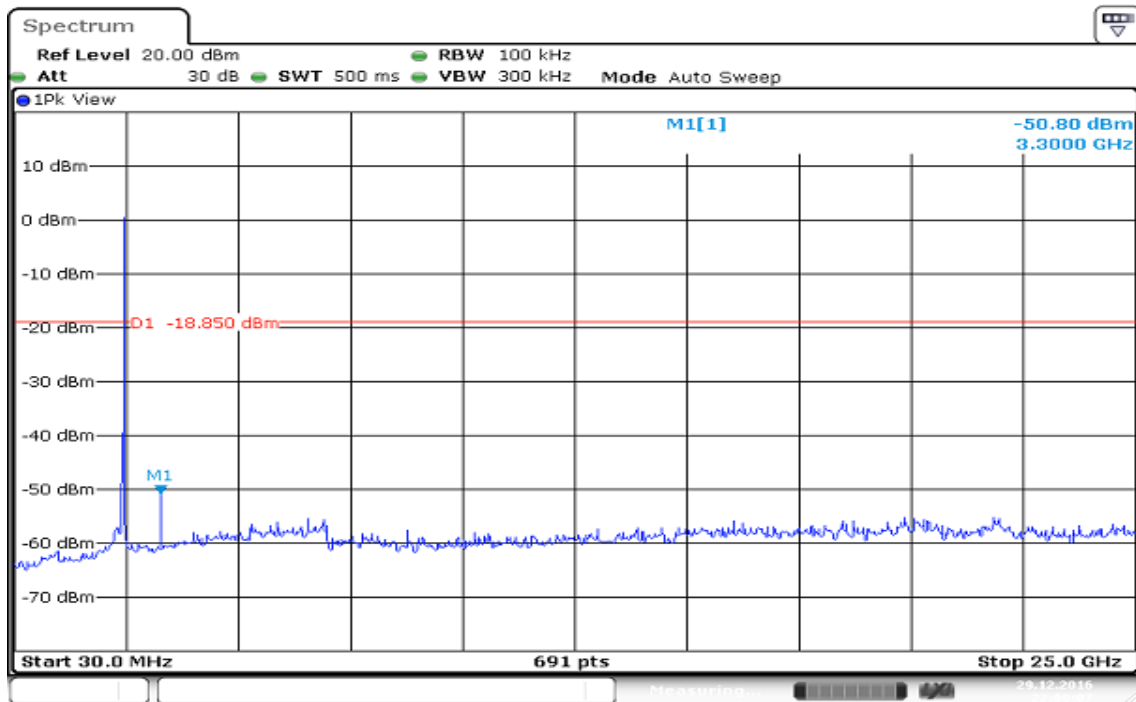

IEEE 802.11 n HT20 mode Low CH chain 1

Reference Level of PSD in 100kHz

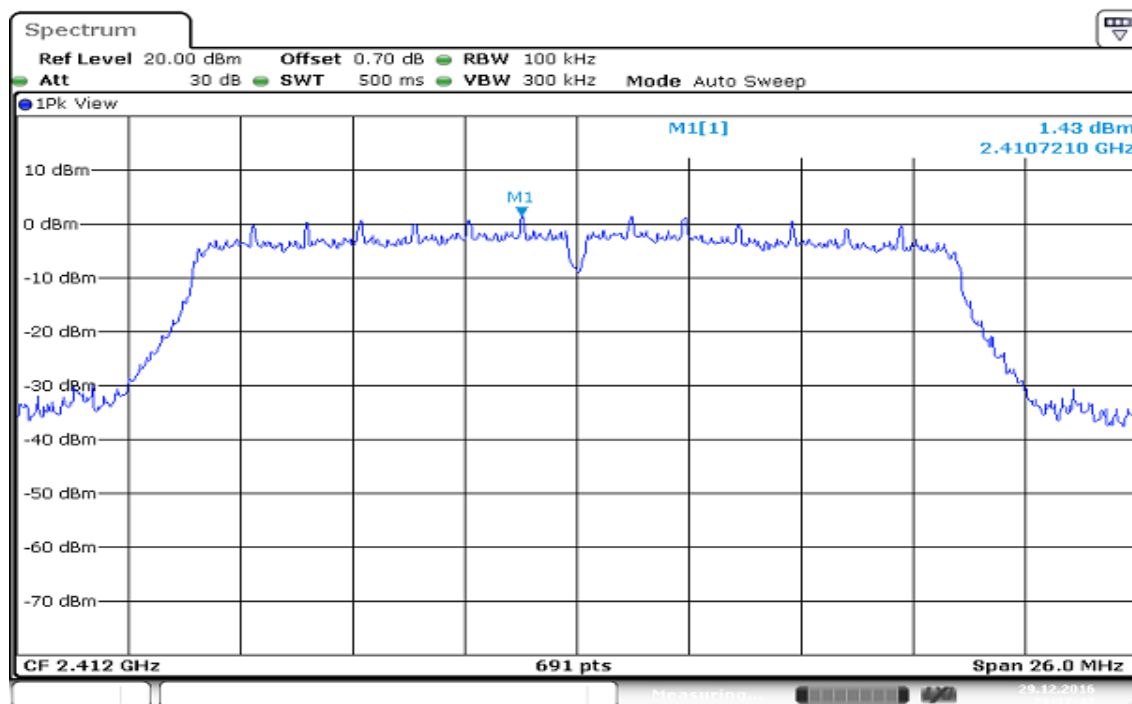

Date: 29. DEC. 2016 21:37:47

Band Edge

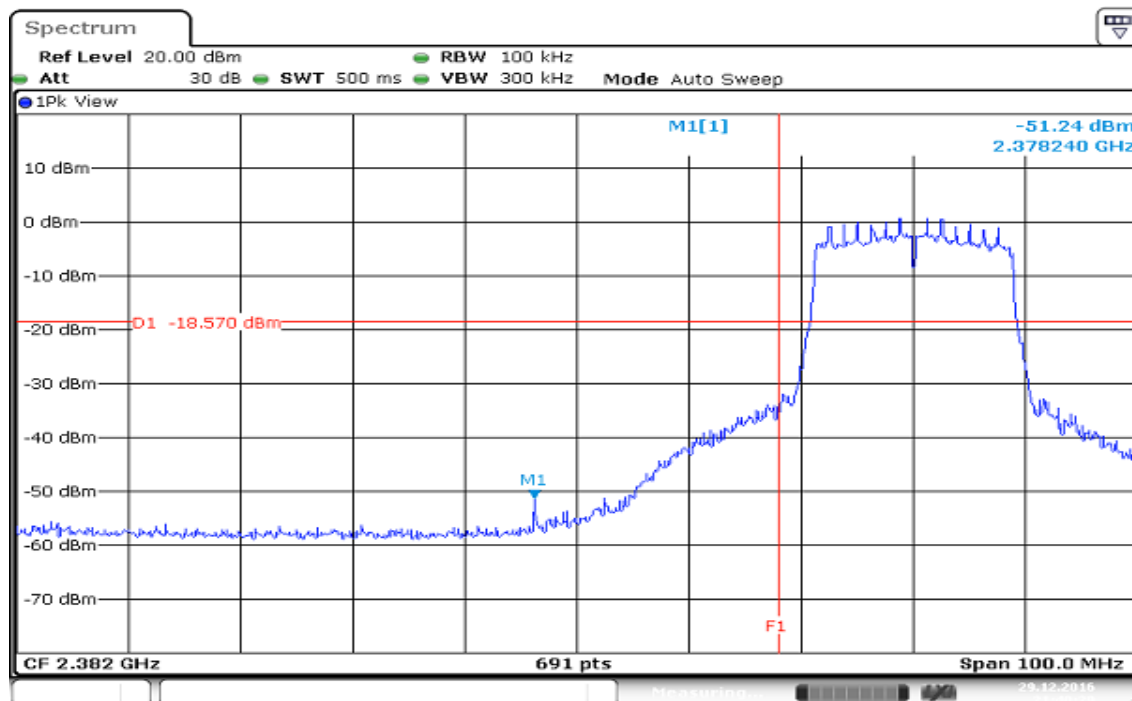

Date: 29. DEC. 2016 21:40:29

Spurious Emission 30MHz-25GHz

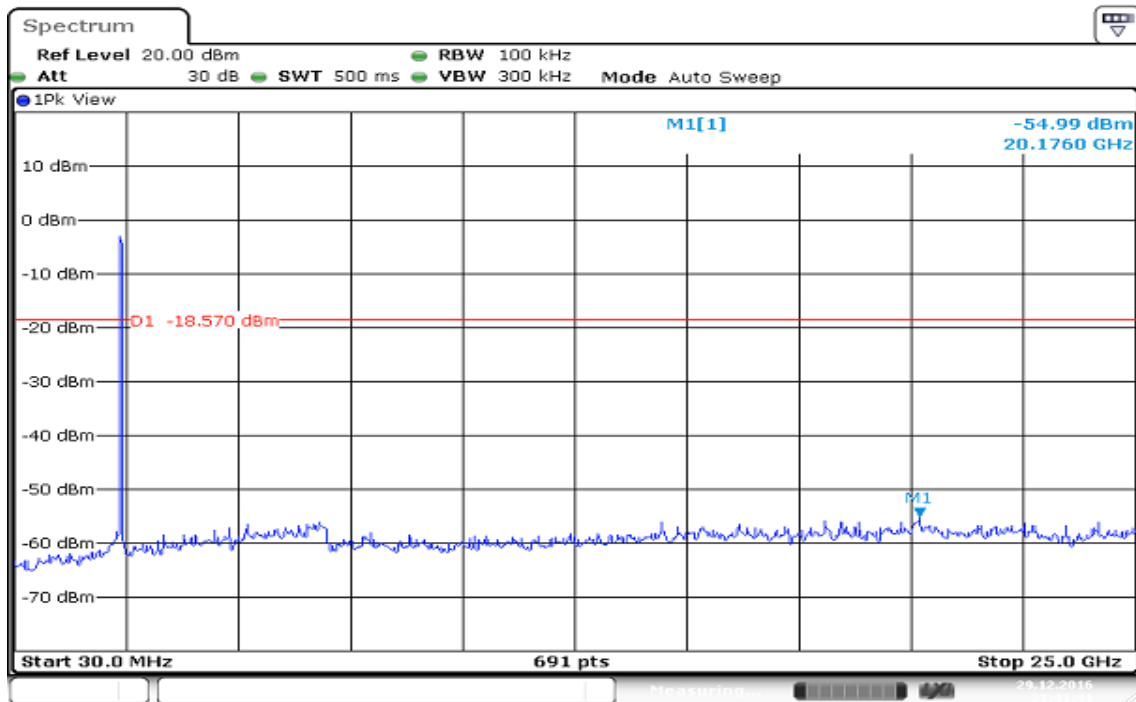

Date: 29.DEC.2016 21:41:41

IEEE 802.11 n HT20 mode Mid CH chain 1
Reference Level of PSD in 100kHz

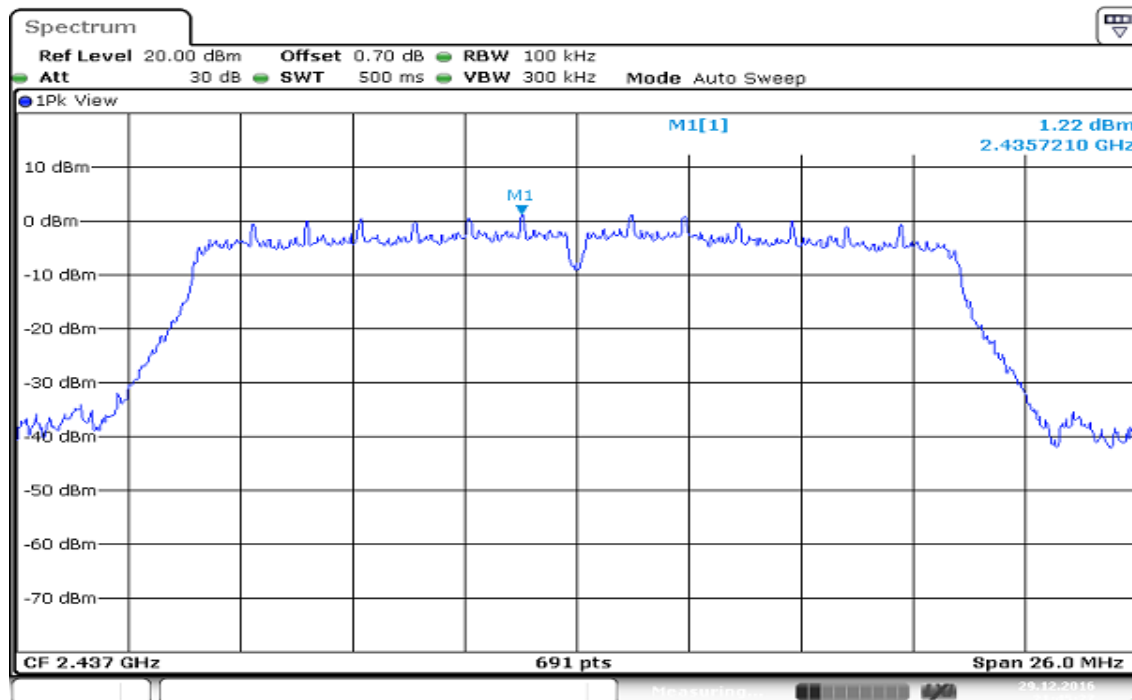

Date: 29. DEC. 2016 21:45:27

Spurious Emission 30MHz-25GHz

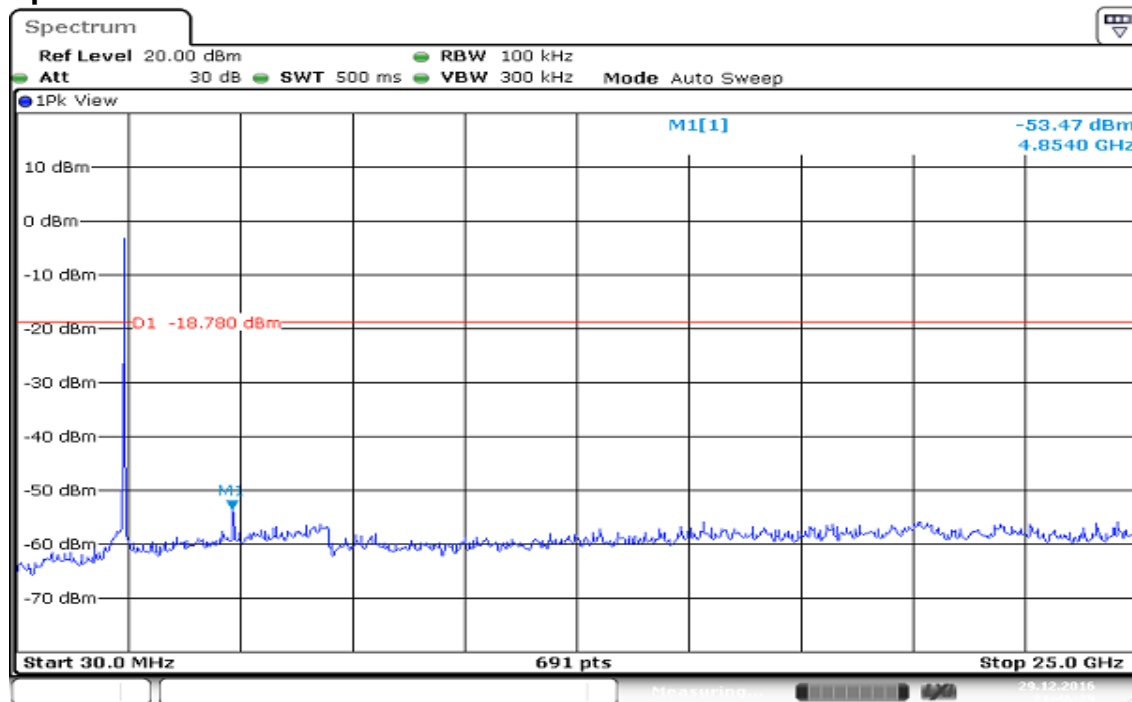

Date: 29. DEC. 2016 21:46:29

IEEE 802.11n HT20 mode High CH chain 1

Reference Level of PSD in 100kHz

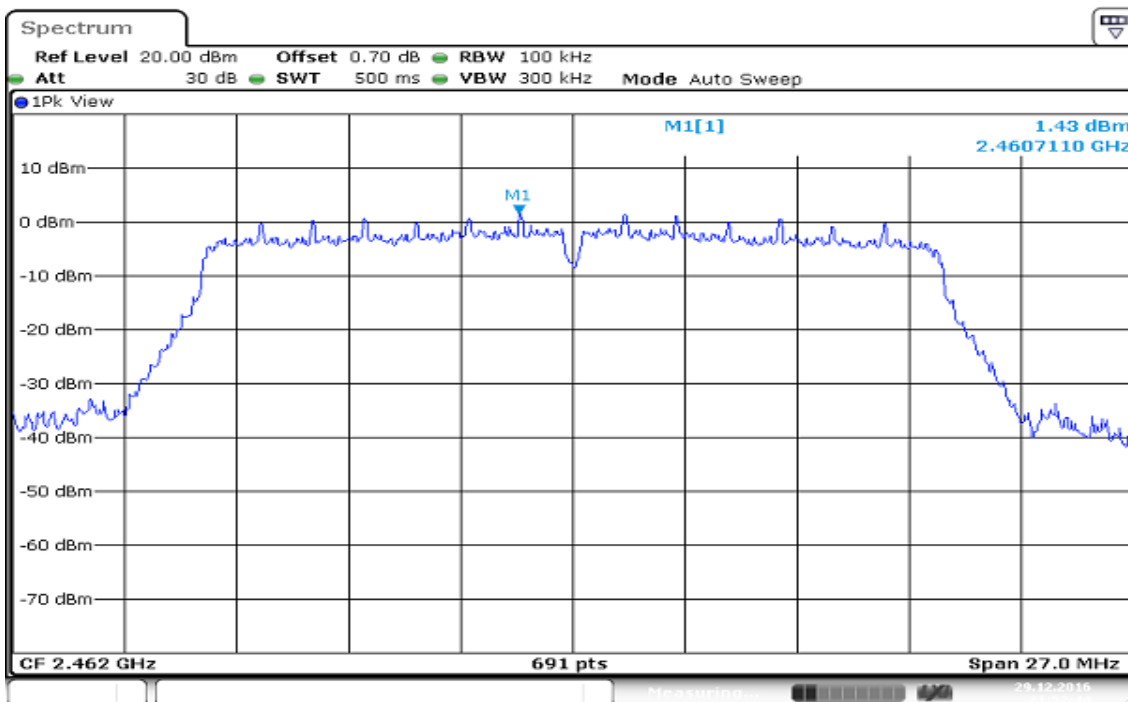

Band Edge

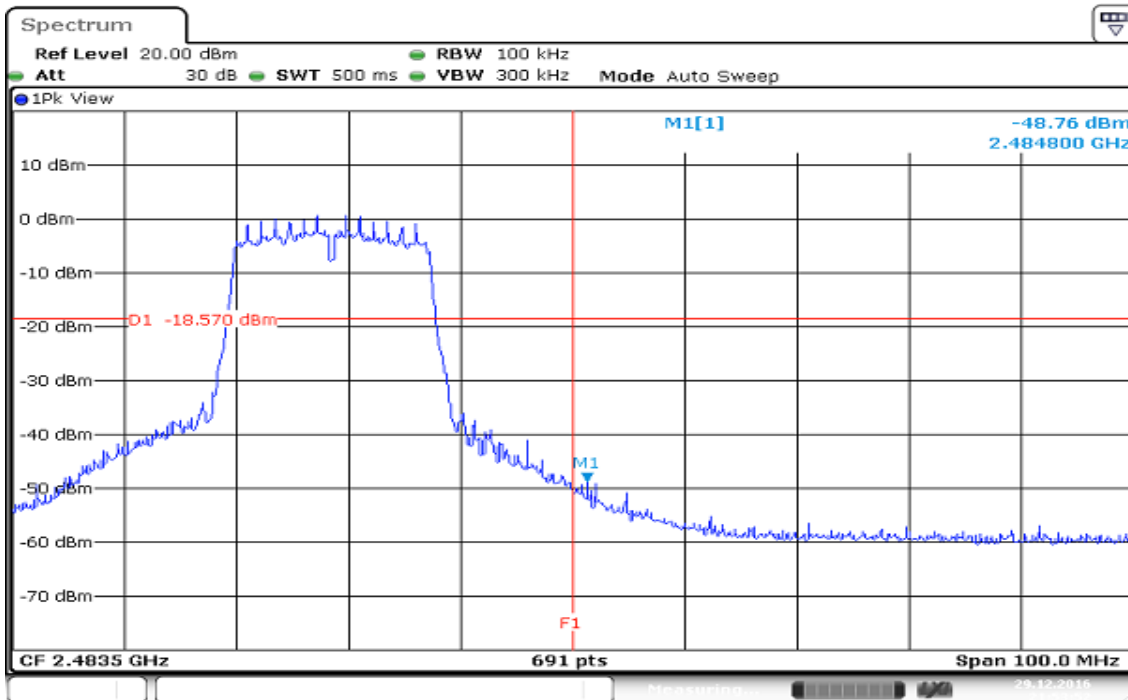

Spurious Emission 30MHz-25GHz

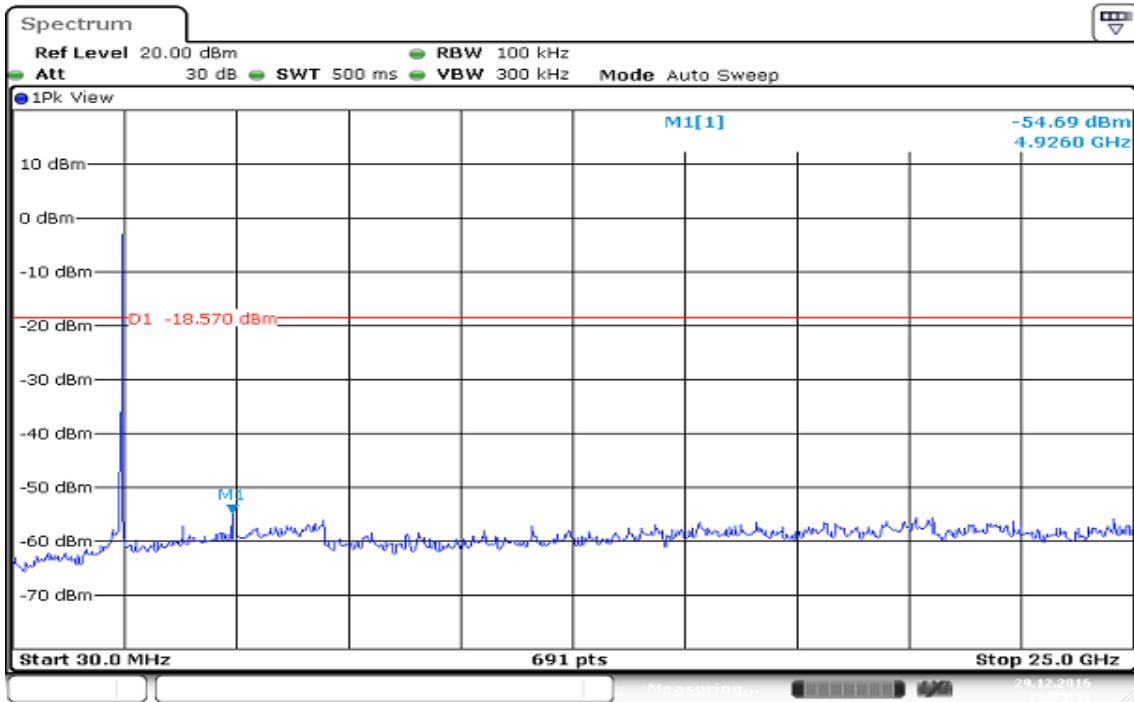

Date: 29.DEC.2016 21:55:13

IEEE 802.11 n HT40 mode Low CH chain 0

Reference Level of PSD in 100kHz

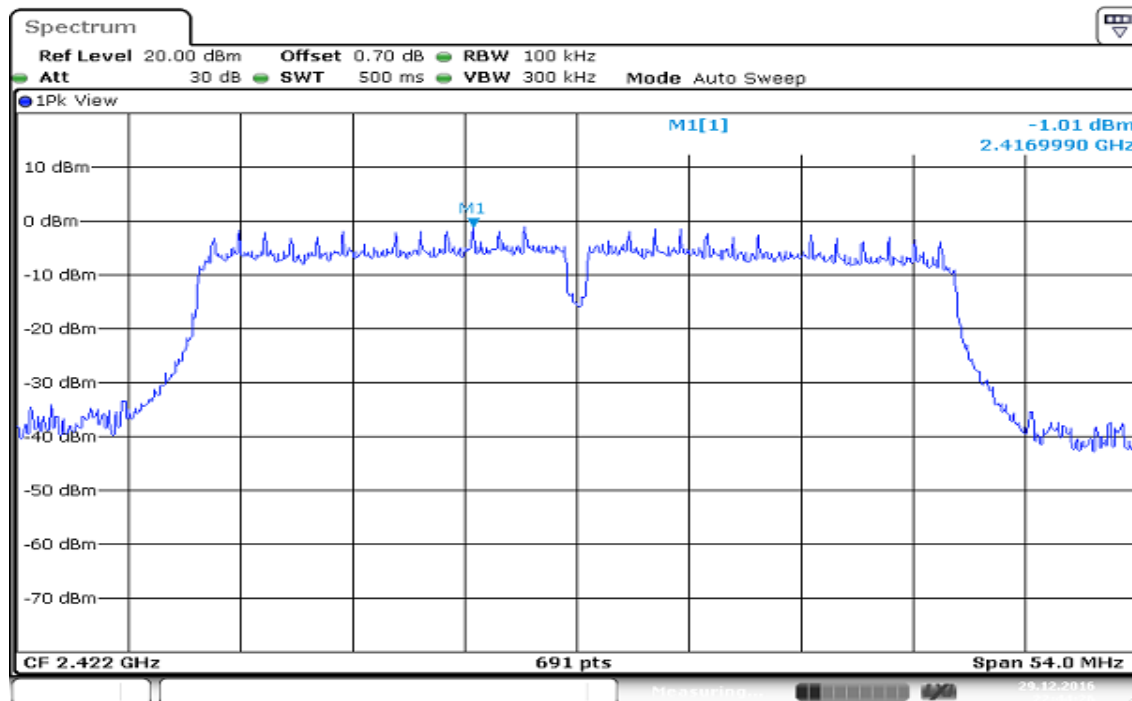

Date: 29.DEC.2016 22:44:26

Band Edge

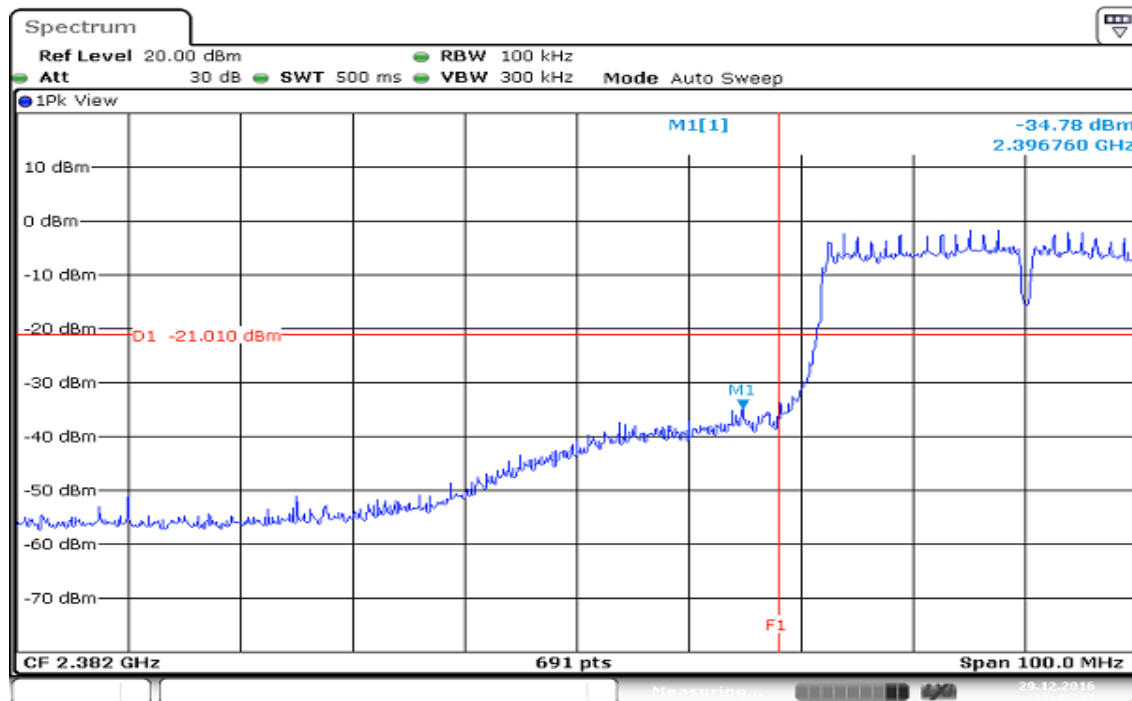

Date: 29.DEC.2016 22:45:47

Spurious Emission 30MHz-25GHz

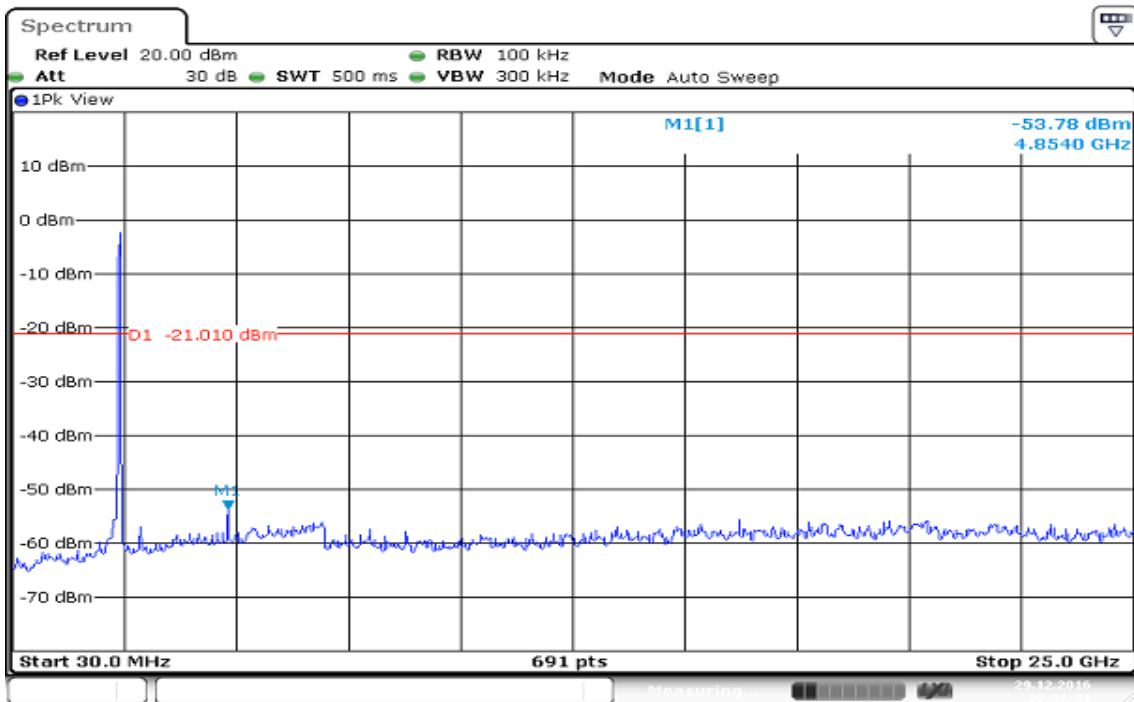

Date: 29.DEC.2016 22:46:31

IEEE 802.11 n HT40 mode Mid CH chain 0
Reference Level of PSD in 100kHz

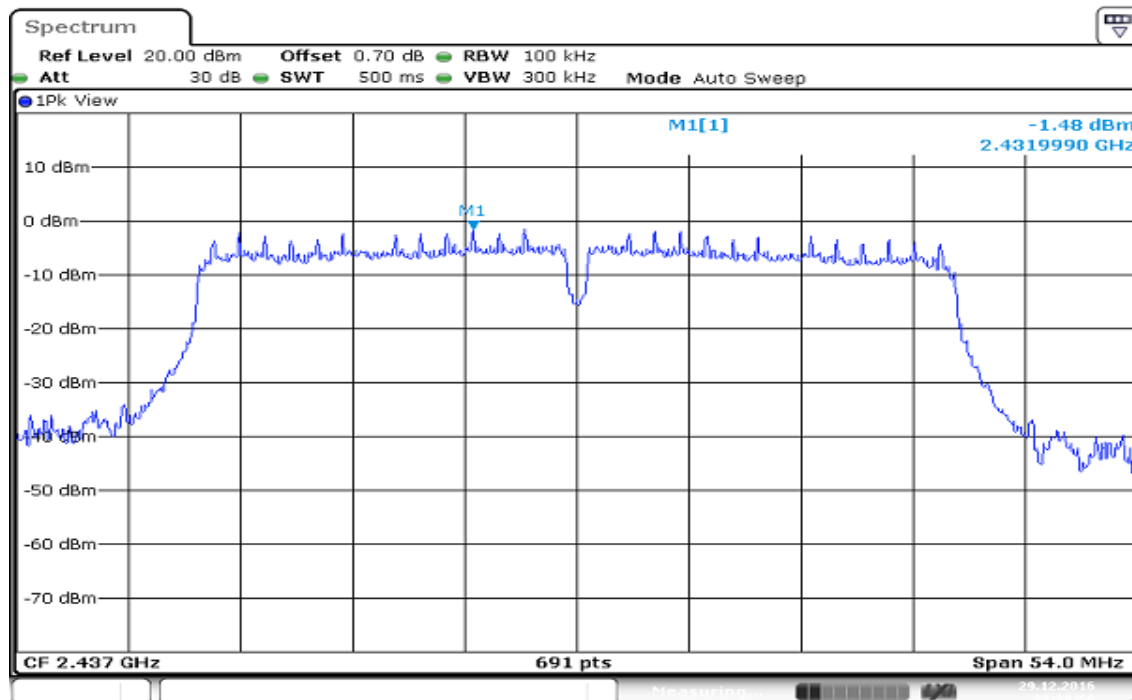

Date: 29.DEC.2016 22:38:56

Spurious Emission 30MHz-25GHz

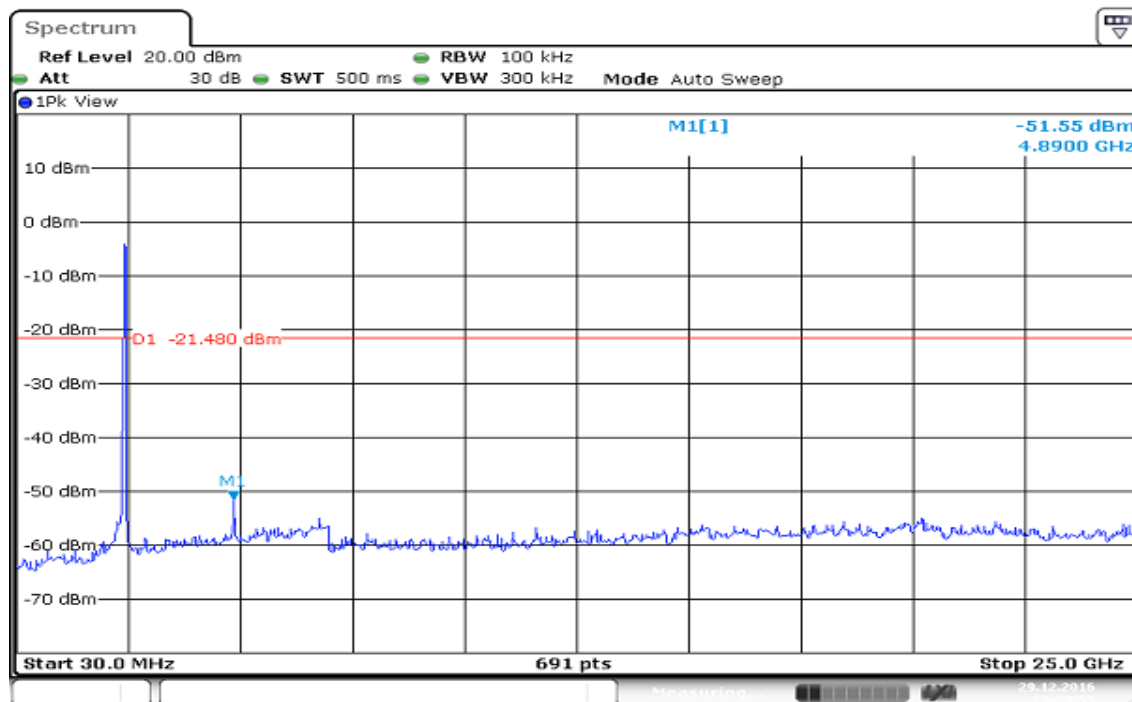

Date: 29.DEC.2016 22:39:55

IEEE 802.11n HT40 mode High CH chain 0
Reference Level of PSD in 100kHz

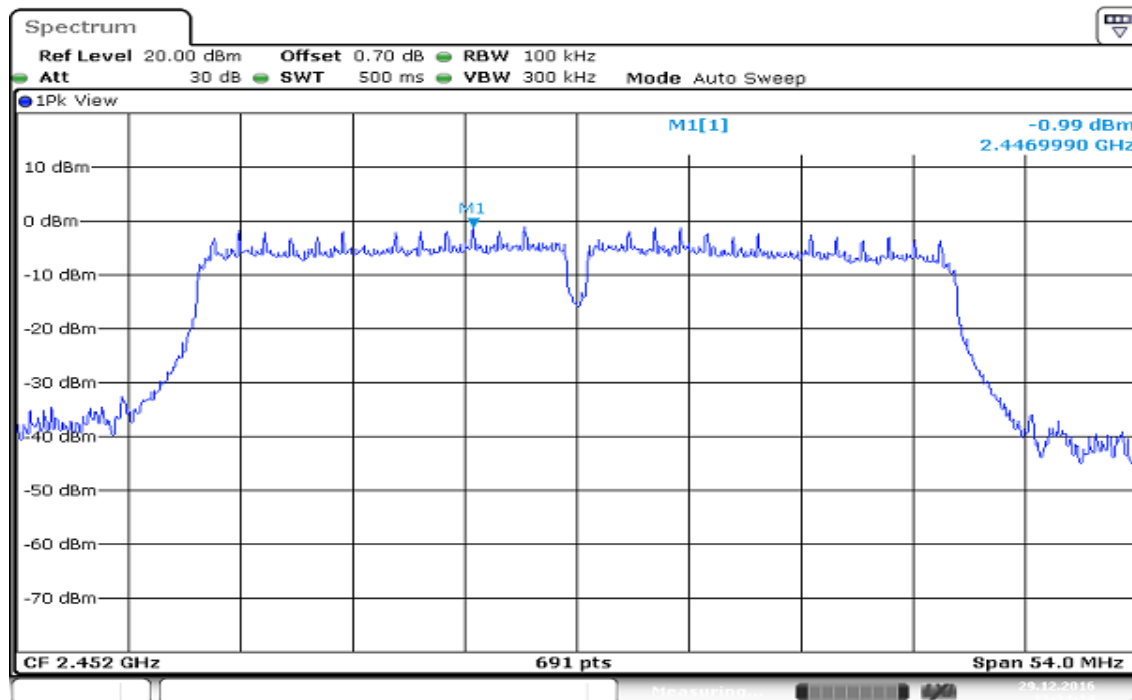

Band Edge

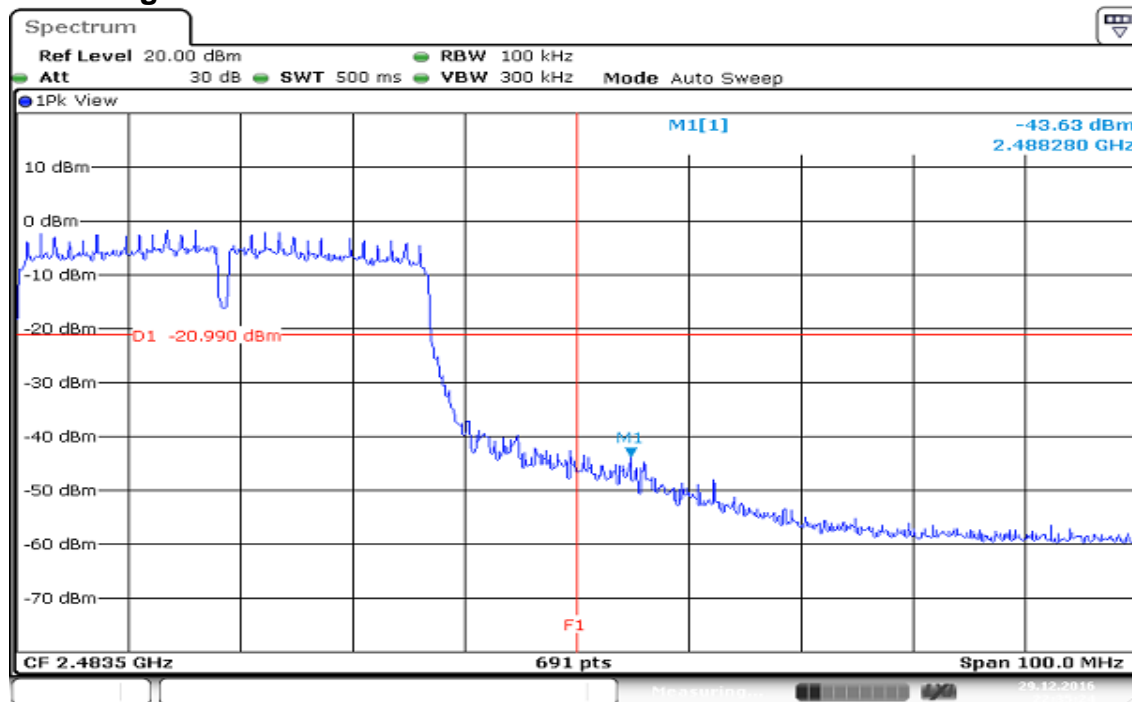

Spurious Emission 30MHz-25GHz

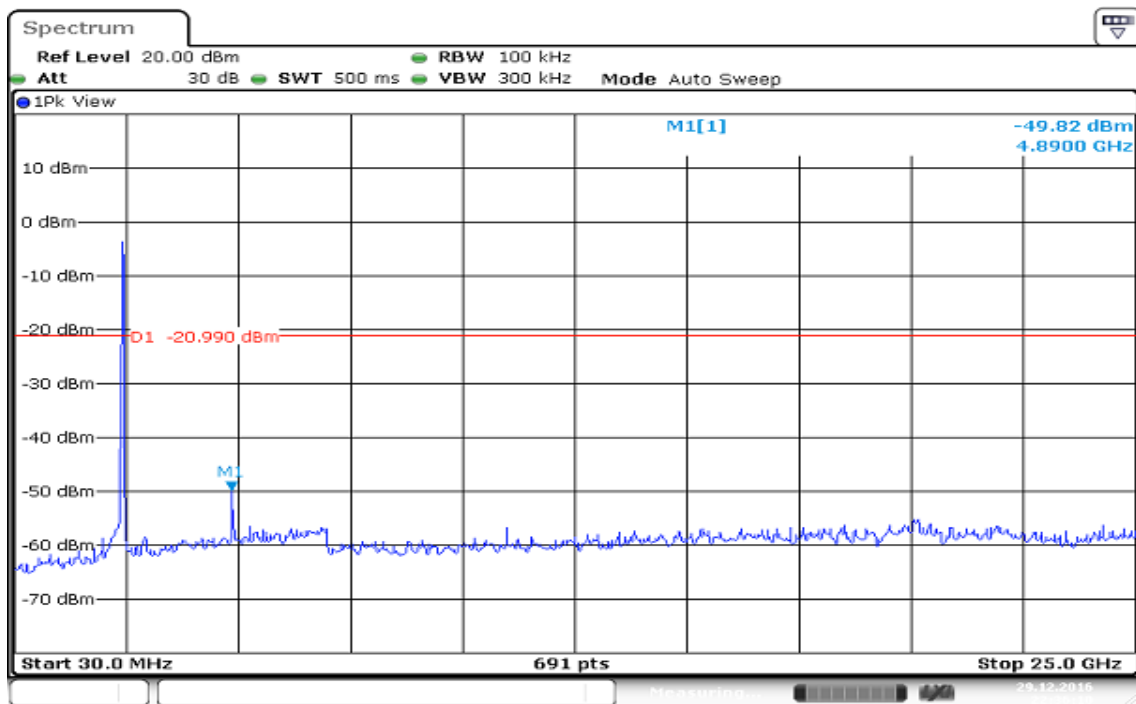

Date: 29 DEC 2016 22:36:09

IEEE 802.11 n HT40 mode Low CH chain 1

Reference Level of PSD in 100kHz

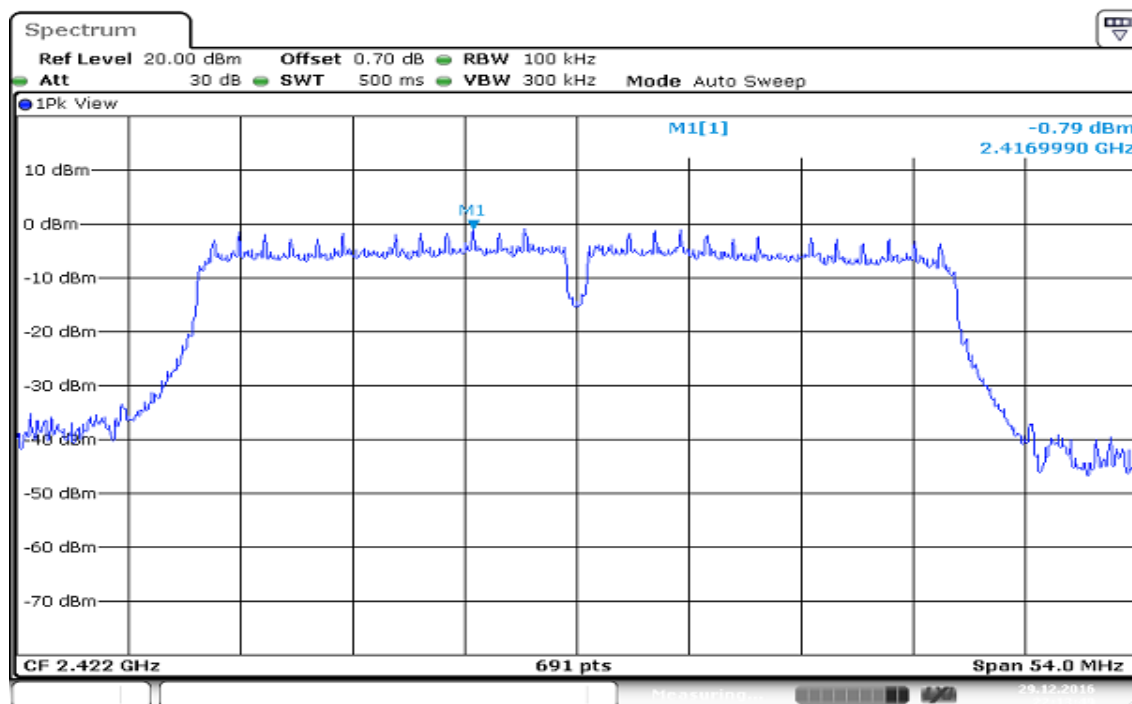

Band Edge

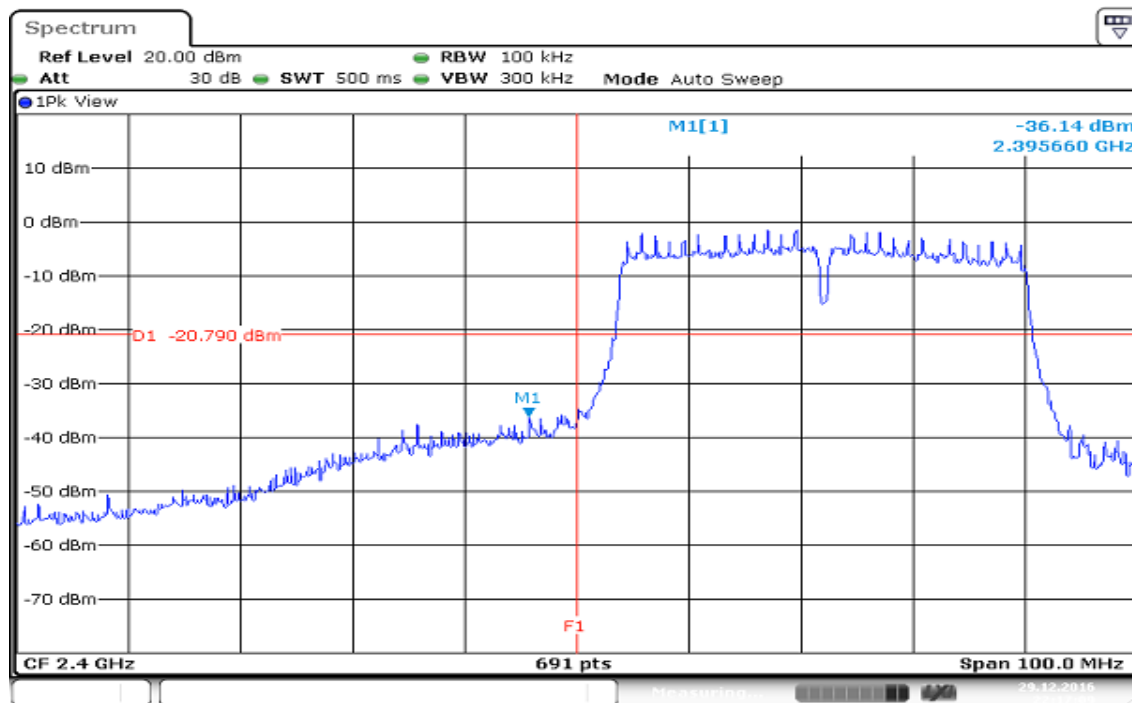

Spurious Emission 30MHz-25GHz

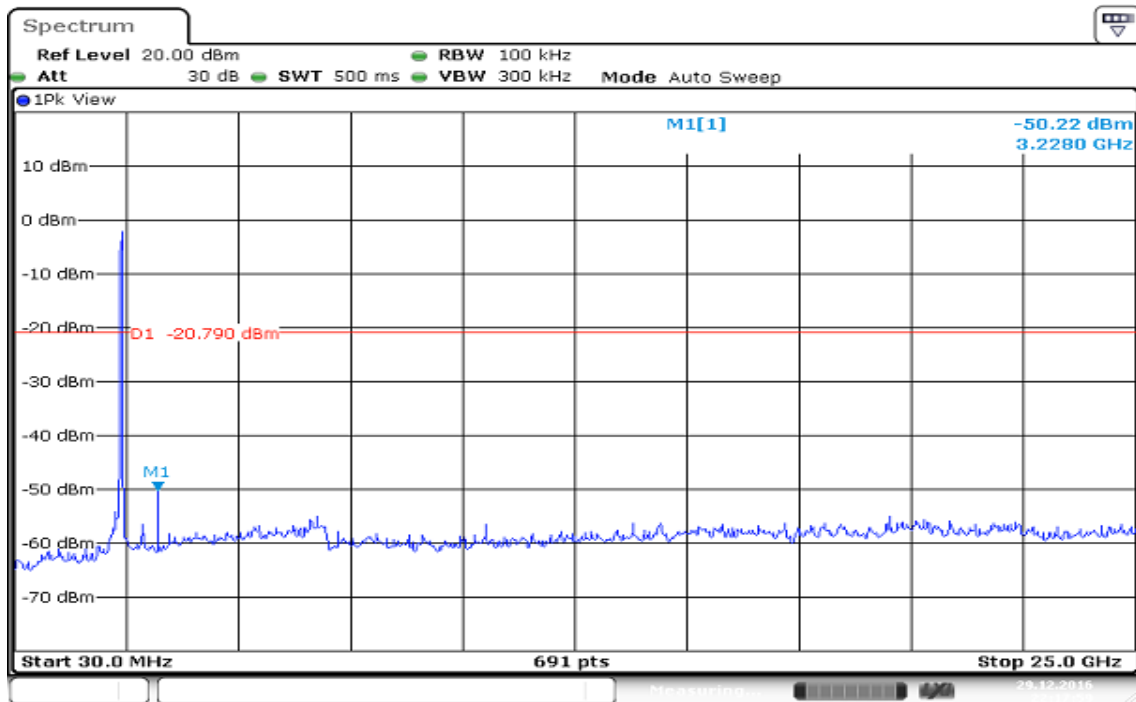

Date: 29.DEC.2016 22:17:59

IEEE 802.11 n HT40 mode Mid CH chain 1

Reference Level of PSD in 100kHz

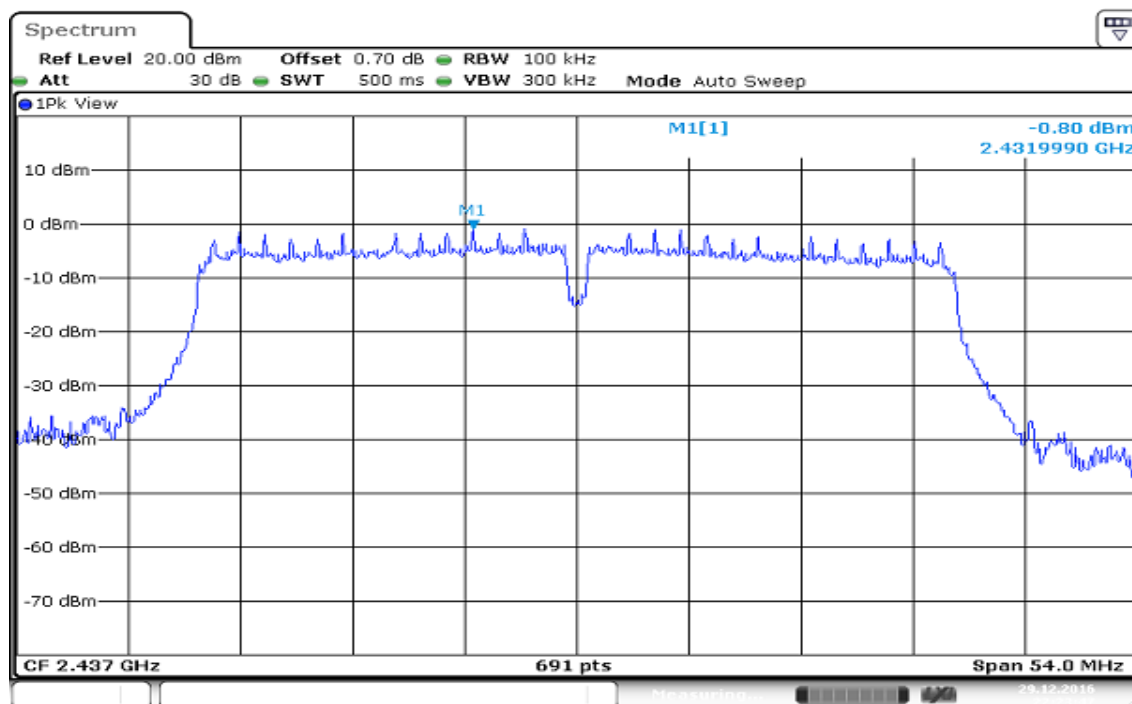

Spurious Emission 30MHz-25GHz

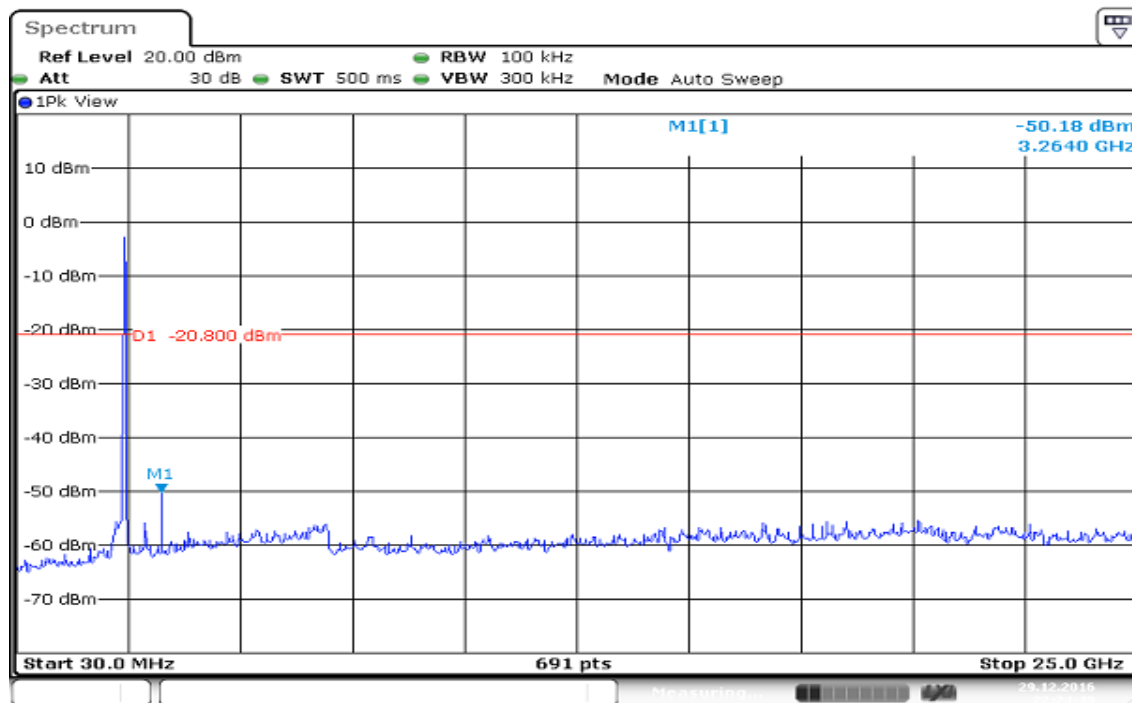

IEEE 802.11n HT40 mode High CH chain 1

Reference Level of PSD in 100kHz

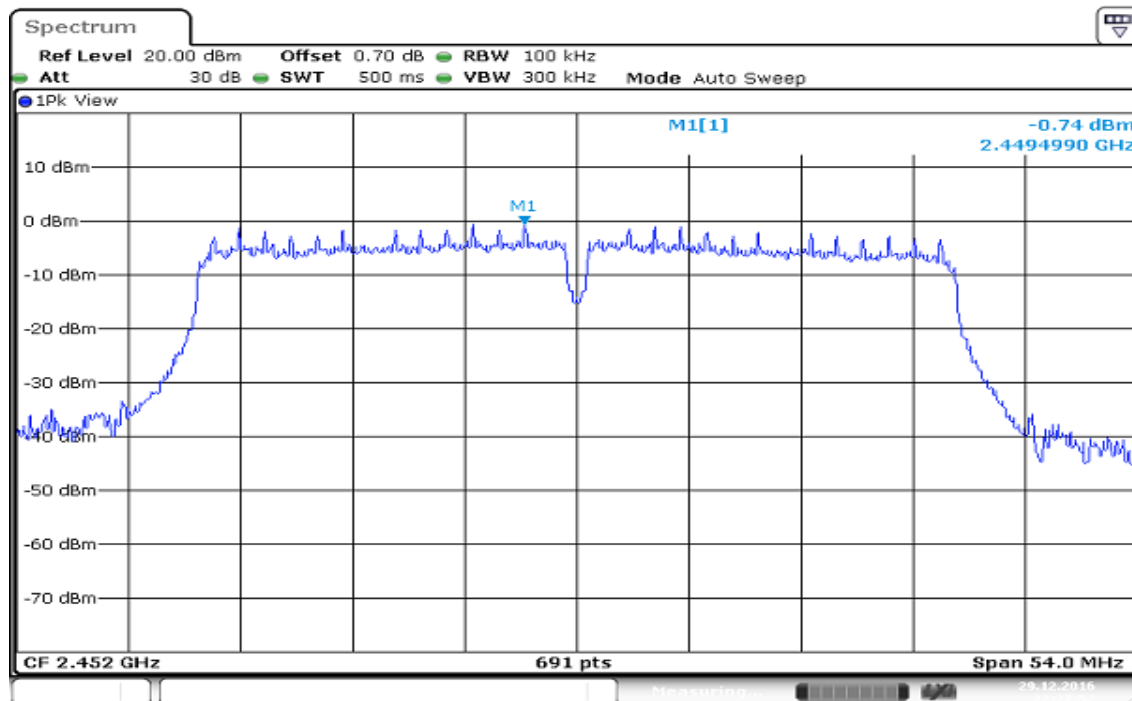

Band Edge

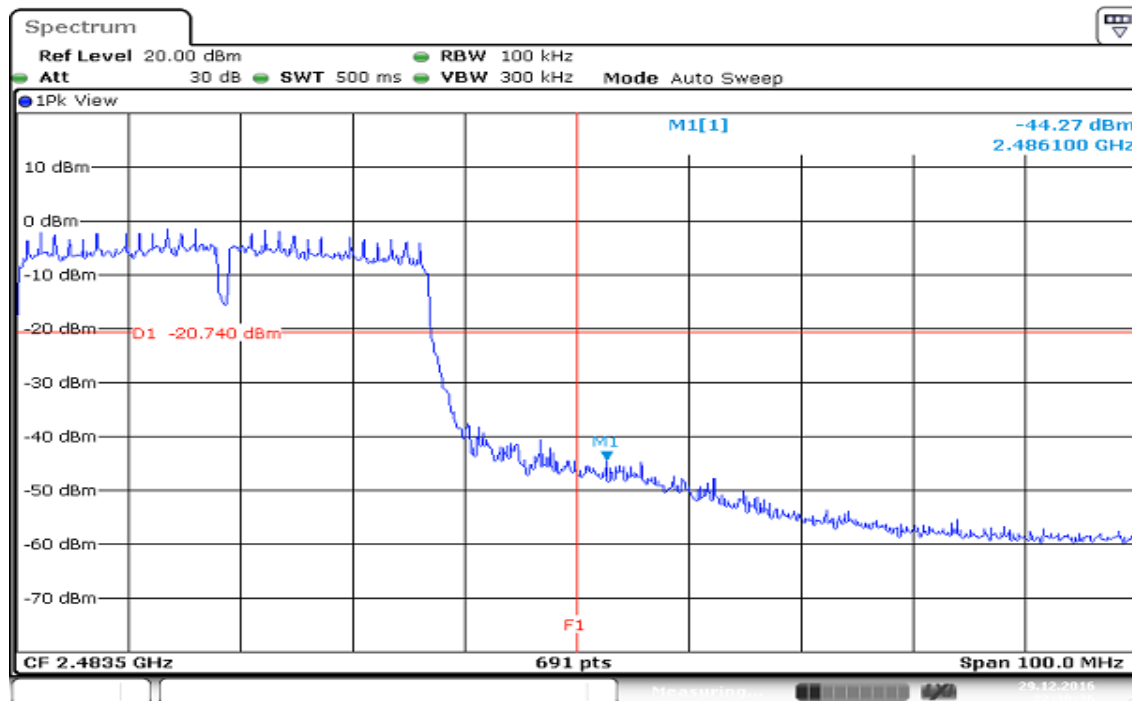

Spurious Emission 30MHz-25GHz

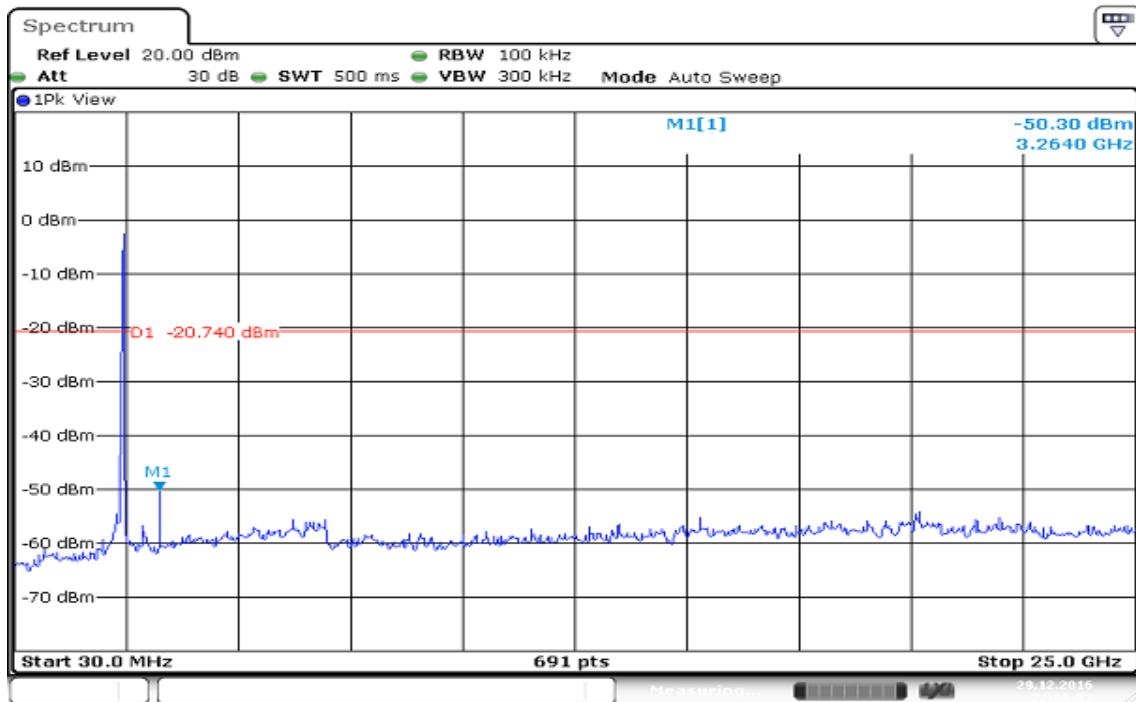

Date: 29.DEC.2016 22:28:52

4.6 RADIATION BANDEDGE AND SPURIOUS EMISSION

4.6.1 Test Limit

FCC according to §15.247(d), §15.209 and §15.205,

In any 100 kHz bandwidth outside the authorized frequency band, all harmonic and spurious must be least 20 dB below the highest emission level with the authorized frequency band. Radiation emission which fall in the restricted bands must also follow the FCC section 15.209 as below limit in table.

Below 30 MHz

Frequency	Field Strength (microvolts/m)	Magnetic H-Field (microamperes/m)	Measurement Distance (metres)
9-490 kHz	2,400/F (F in kHz)	2,400/F (F in kHz)	300
490-1,705 kHz	24,000/F (F in kHz)	24,000/F (F in kHz)	30
1.705-30 MHz	30	N/A	30

Above 30 MHz

Frequency	Field Strength (microvolts/m)	Measurement Distance (metres)
30-88	100	3
88-216	150	3
216-960	200	3
Above 960	500	3

4.6.2 Test Procedure

Test method Refer as KDB 558074 D01 v03r05, Section 12.1.

1. The EUT is placed on a turntable, Above 1 GHz is 1.5m and below 1 GHz is 0.8m above ground plane. The EUT Configured un accordance with ANSI C63.10, and the EUT set in a continuous mode.
2. The turntable shall be rotated for 360 degrees to determine the position of maximum emission level. And EUT is set 3m away from the receiving antenna, which is scanned from 1m to 4m above the ground plane to find out the highest emissions. Measurement are made polarized in both the vertical and the horizontal positions with antenna.
3. Span shall wide enough to full capture the emission measured. The SA from 30MHz to 26.5GHz set to the low, Mid and High channels with the EUT transmit.
5. The SA setting following :
 - (1) Below 1G : RBW = 100kHz, VBW \geq 3 RBW, Sweep = Auto, Detector = Peak, Trace = Max hold.
 - (2) Above 1G :
 - (2.1) For Peak measurement : RBW = 1MHz, VBW \geq 3 RBW, Sweep = Auto, Detector = Peak, Trace = Max hold.
 - (2.2) For Average measurement : RBW = 1MHz, VBW
 - If Duty Cycle \geq 98%, VBW=10Hz.
 - If Duty Cycle <98%, VBW=1/T.

Configuration	Duty Cycle (%)	VBW
802.11b	100%	10Hz
802.11g	100%	10Hz
802.11n HT20	100%	10Hz
802.11n HT40	100%	10Hz

4.6.3 Test Setup

9kHz ~ 30MHz

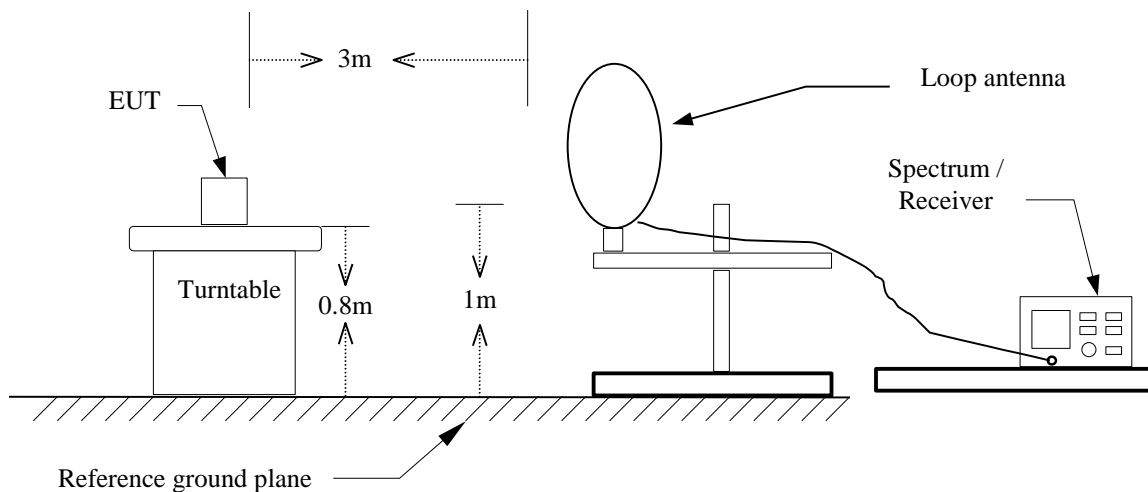

30MHz ~ 1GHz

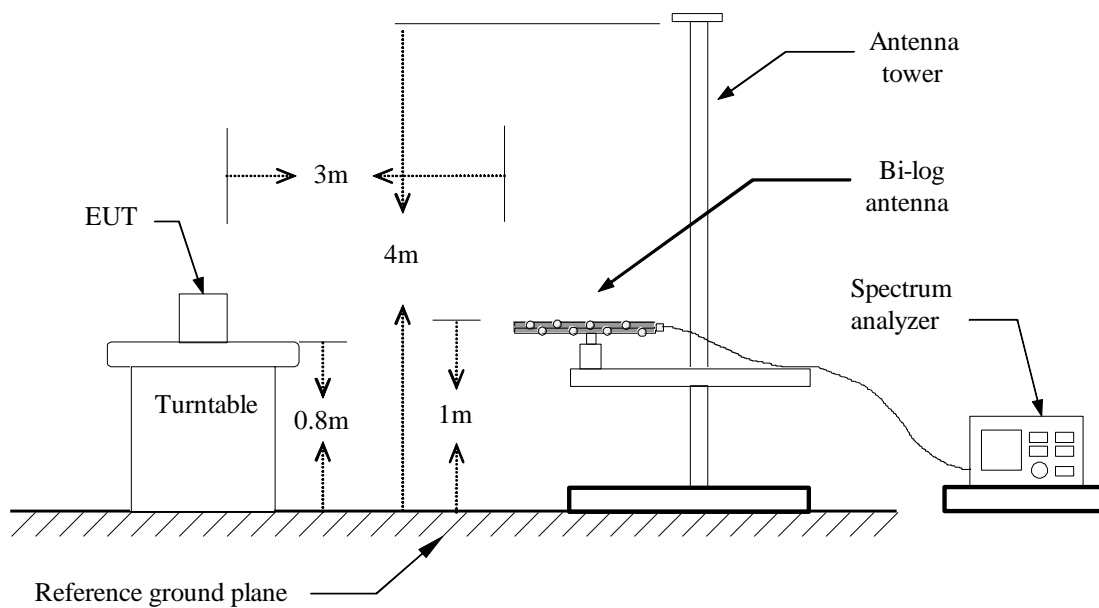

Above 1 GHz

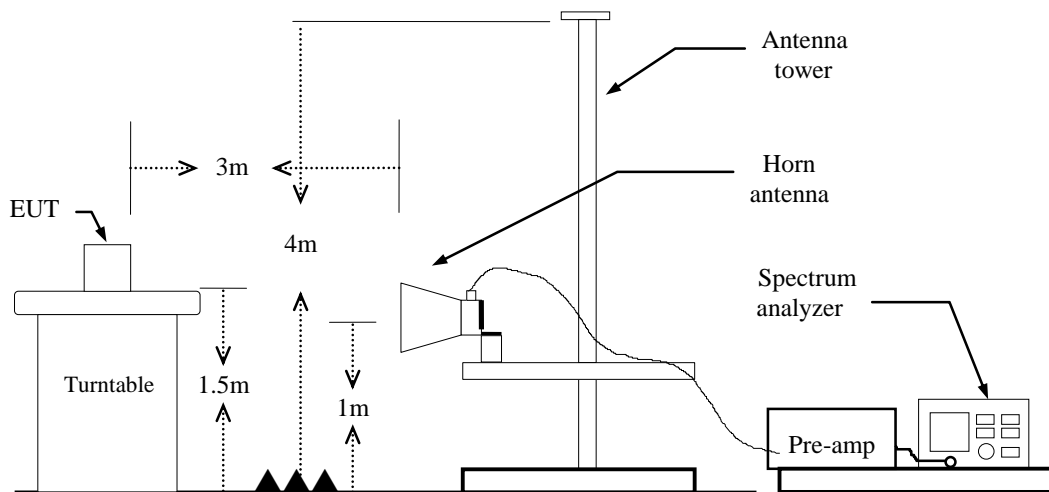

4.6.4 Test Result

Band Edge Test Data

Test Mode	IEEE 802.11b Low CH	Temp/Hum	27(°C)/ 53%RH
Test Item	Band Edge	Test Date	January 16, 2017
Polarize	Vertical	Test Engineer	Kevin Kuo
Detector	Peak	Test Voltage	120Vac / 60Hz

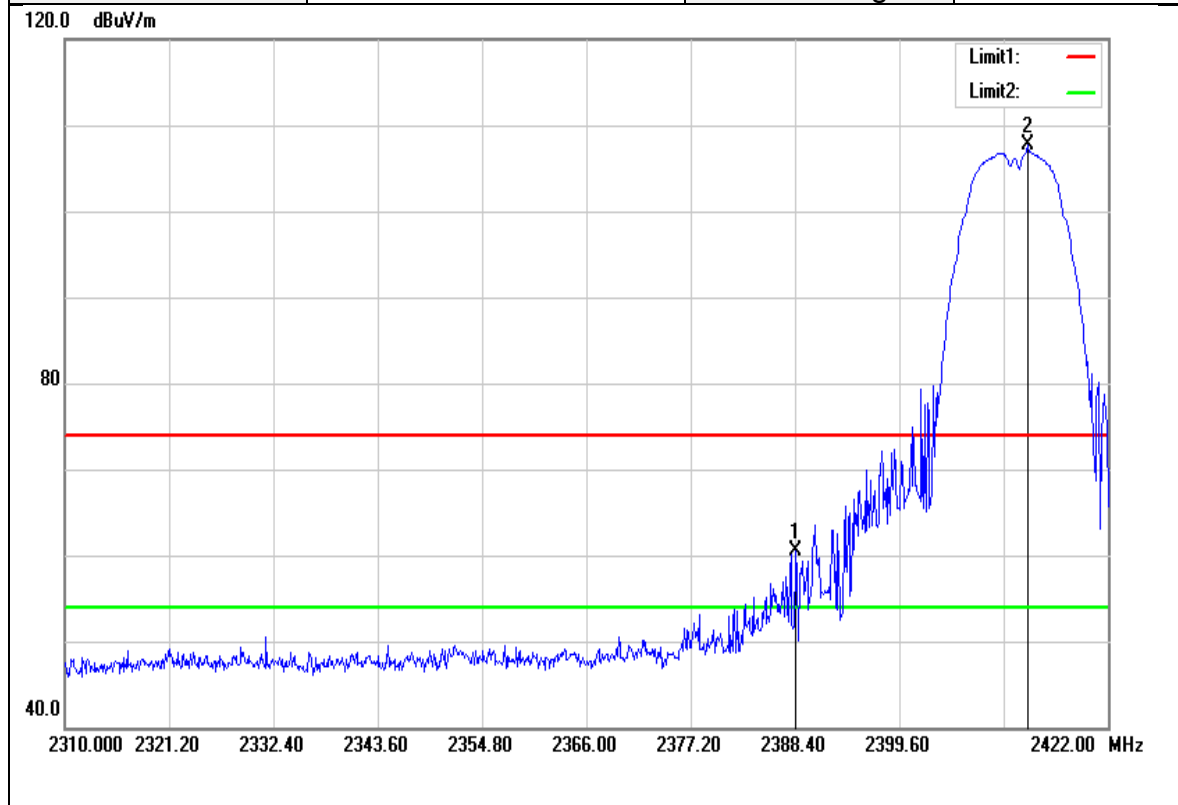

No.	Frequency (MHz)	Reading (dBuV)	Correct Factor(dB/m)	Result (dBuV/m)	Limit (dBuV/m)	Margin (dB)	Remark
1	2388.512	62.96	-2.50	60.46	74.00	-13.54	peak
2	2413.376	110.04	-2.41	107.63	-	-	peak

Test Mode	IEEE 802.11b Low CH	Temperature:	27(°C)/ 53%RH
Test Item	Band Edge	Test Date	January 16, 2017
Polarize	Vertical	Test Engineer	Kevin Kuo
Detector	Average	Test Voltage	120Vac / 60Hz

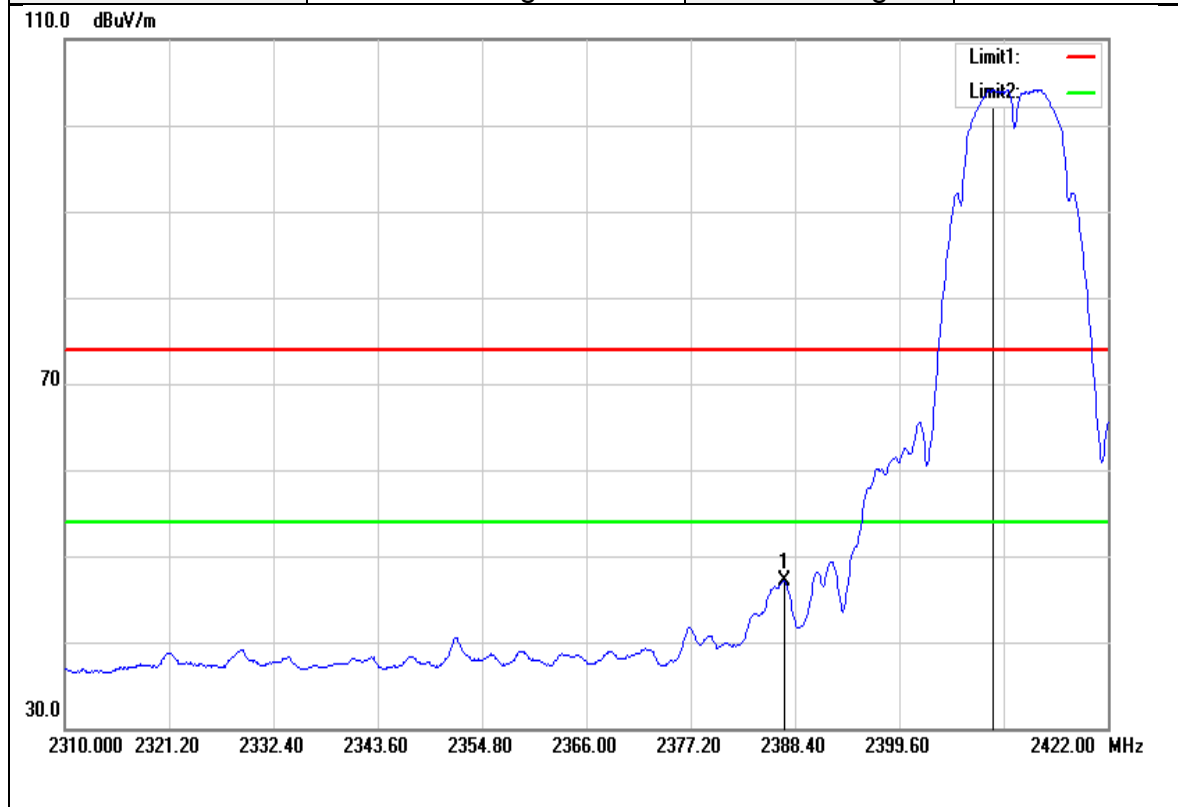

No.	Frequency (MHz)	Reading (dBuV)	Correct Factor(dB/m)	Result (dBuV/m)	Limit (dBuV/m)	Margin (dB)	Remark
1	2387.280	49.65	-2.51	47.14	54.00	-6.86	AVG
2	2409.680	106.60	-2.43	104.17	-	-	AVG

Test Mode	IEEE 802.11b High CH	Temp/Hum	27(°C)/ 53%RH
Test Item	Band Edge	Test Date	January 16, 2017
Polarize	Vertical	Test Engineer	Kevin Kuo
Detector	Peak	Test Voltage	120Vac / 60Hz

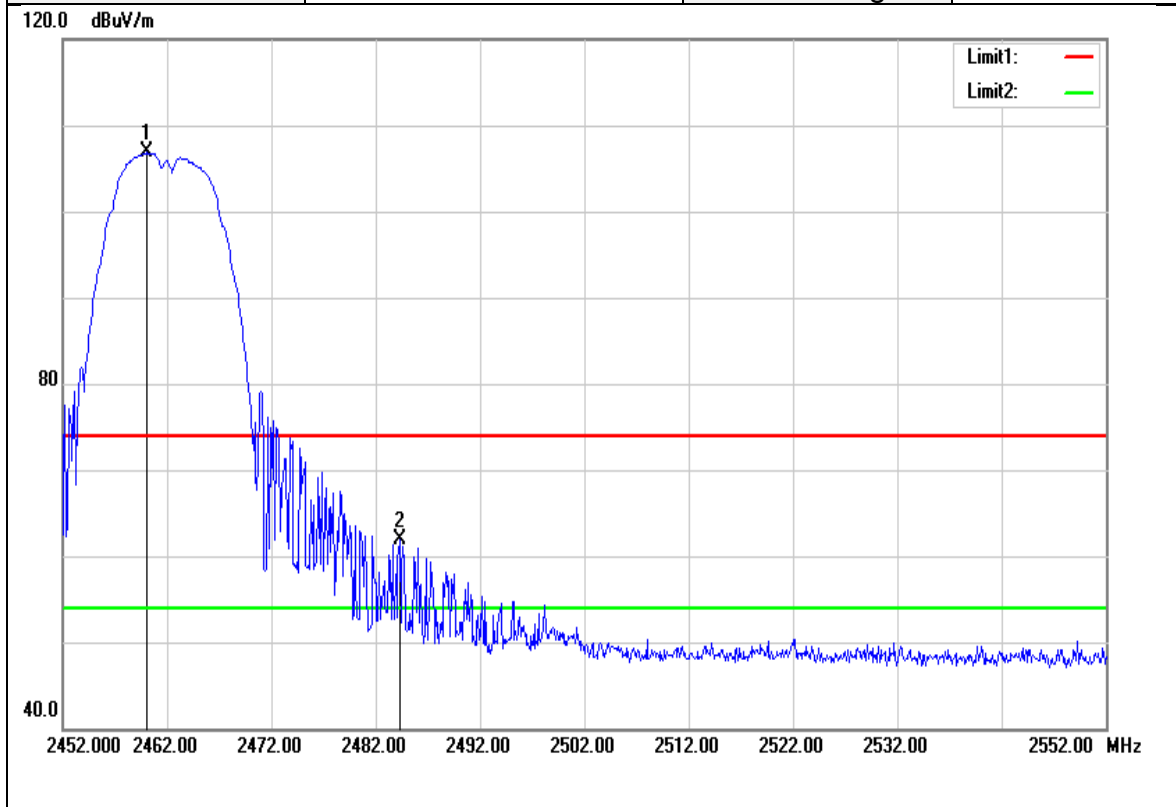

No.	Frequency (MHz)	Reading (dBuV)	Correct Factor(dB/m)	Result (dBuV/m)	Limit (dBuV/m)	Margin (dB)	Remark
1	2460.100	108.93	-2.10	106.83	-	-	peak
2	2484.300	63.88	-1.99	61.89	74.00	-12.11	peak

Test Mode	IEEE 802.11b High CH	Temperature:	27(°C)/ 53%RH
Test Item	Band Edge	Test Date	January 16, 2017
Polarize	Vertical	Test Engineer	Kevin Kuo
Detector	Average	Test Voltage	120Vac / 60Hz

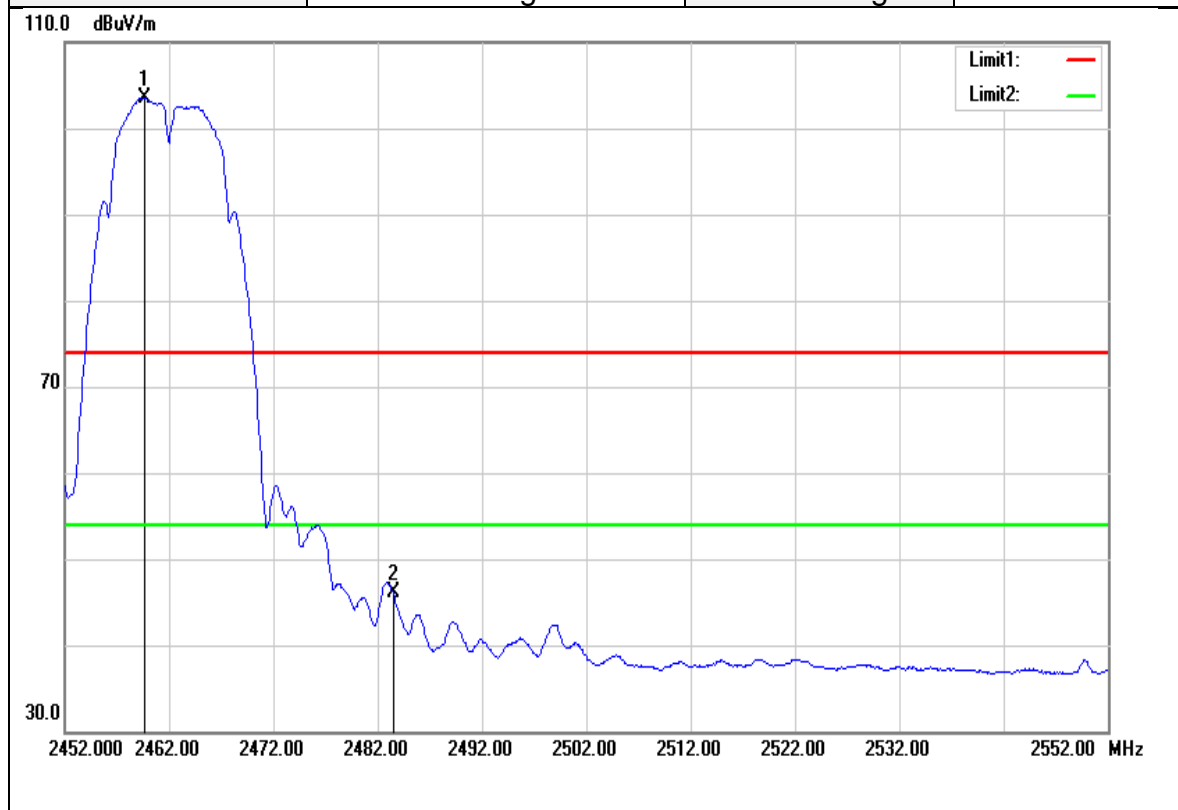

No.	Frequency (MHz)	Reading (dBuV)	Correct Factor(dB/m)	Result (dBuV/m)	Limit (dBuV/m)	Margin (dB)	Remark
1	2459.700	105.59	-2.10	103.49	-	-	AVG
2	2483.500	48.00	-1.99	46.01	54.00	-7.99	AVG

Test Mode	IEEE 802.11g Low CH	Temp/Hum	27(°C)/ 53%RH
Test Item	Band Edge	Test Date	January 16, 2017
Polarize	Vertical	Test Engineer	Kevin Kuo
Detector	Peak	Test Voltage	120Vac / 60Hz

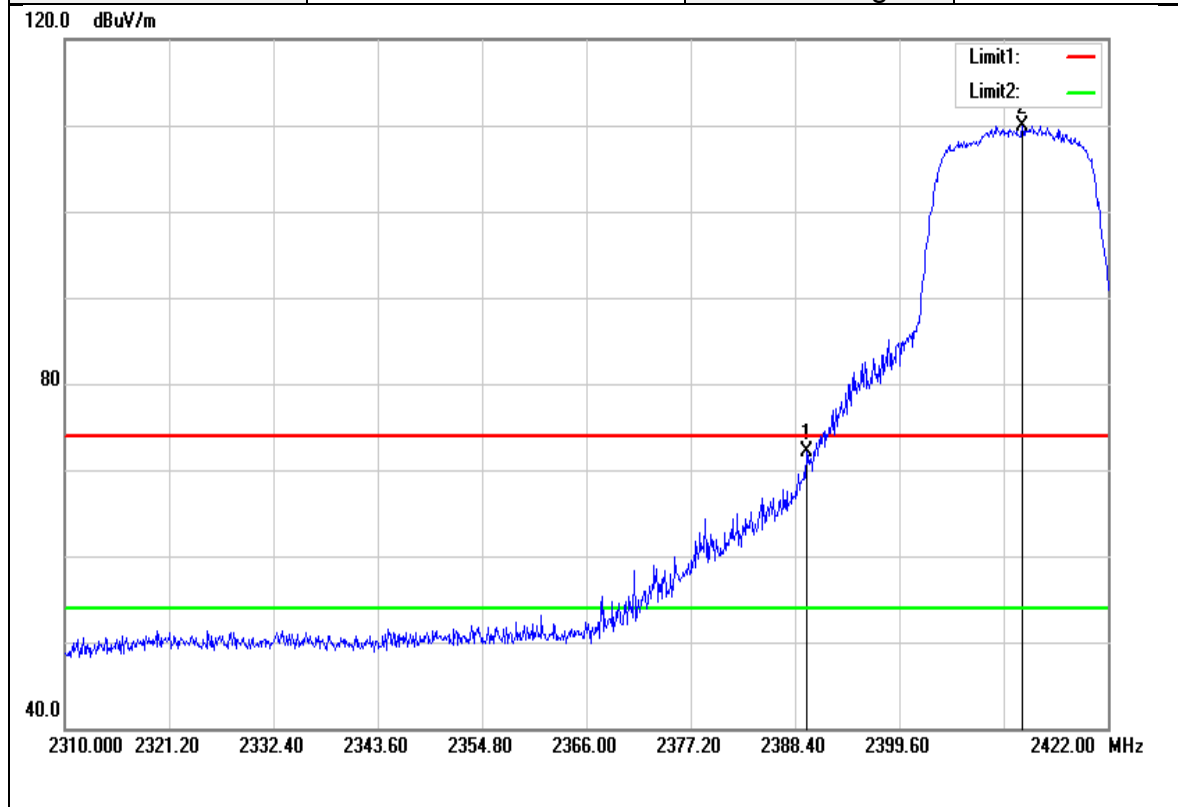

No.	Frequency (MHz)	Reading (dBuV)	Correct Factor(dB/m)	Result (dBuV/m)	Limit (dBuV/m)	Margin (dB)	Remark
1	2389.632	74.65	-2.49	72.16	74.00	-1.84	peak
2	2412.816	112.40	-2.41	109.99	-	-	peak

Test Mode	IEEE 802.11g Low CH	Temperature:	27(°C)/ 53%RH
Test Item	Band Edge	Test Date	January 16, 2017
Polarize	Vertical	Test Engineer	Kevin Kuo
Detector	Average	Test Voltage	120Vac / 60Hz

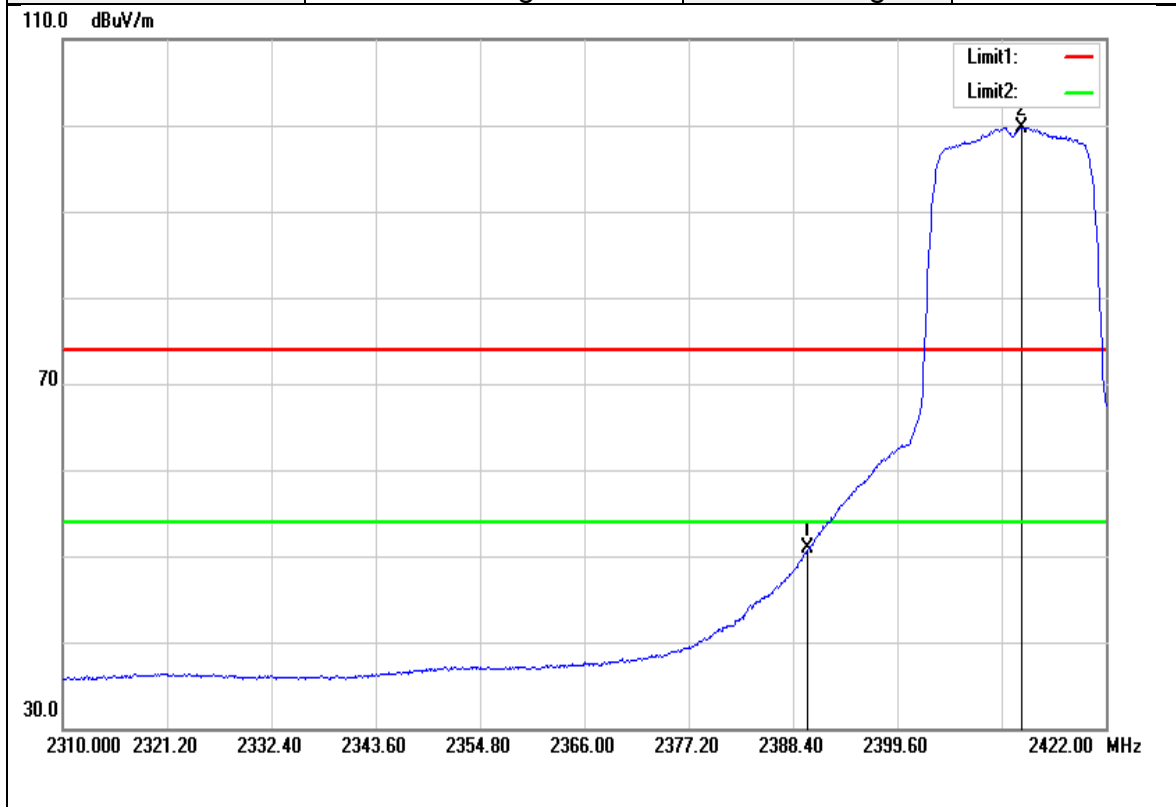

No.	Frequency (MHz)	Reading (dBuV)	Correct Factor(dB/m)	Result (dBuV/m)	Limit (dBuV/m)	Margin (dB)	Remark
1	2390.000	53.42	-2.49	50.93	54.00	-3.07	AVG
2	2412.928	102.14	-2.41	99.73	-	-	AVG

Test Mode	IEEE 802.11g High CH	Temp/Hum	27(°C)/ 53%RH
Test Item	Band Edge	Test Date	January 16, 2017
Polarize	Vertical	Test Engineer	Kevin Kuo
Detector	Peak	Test Voltage	120Vac / 60Hz

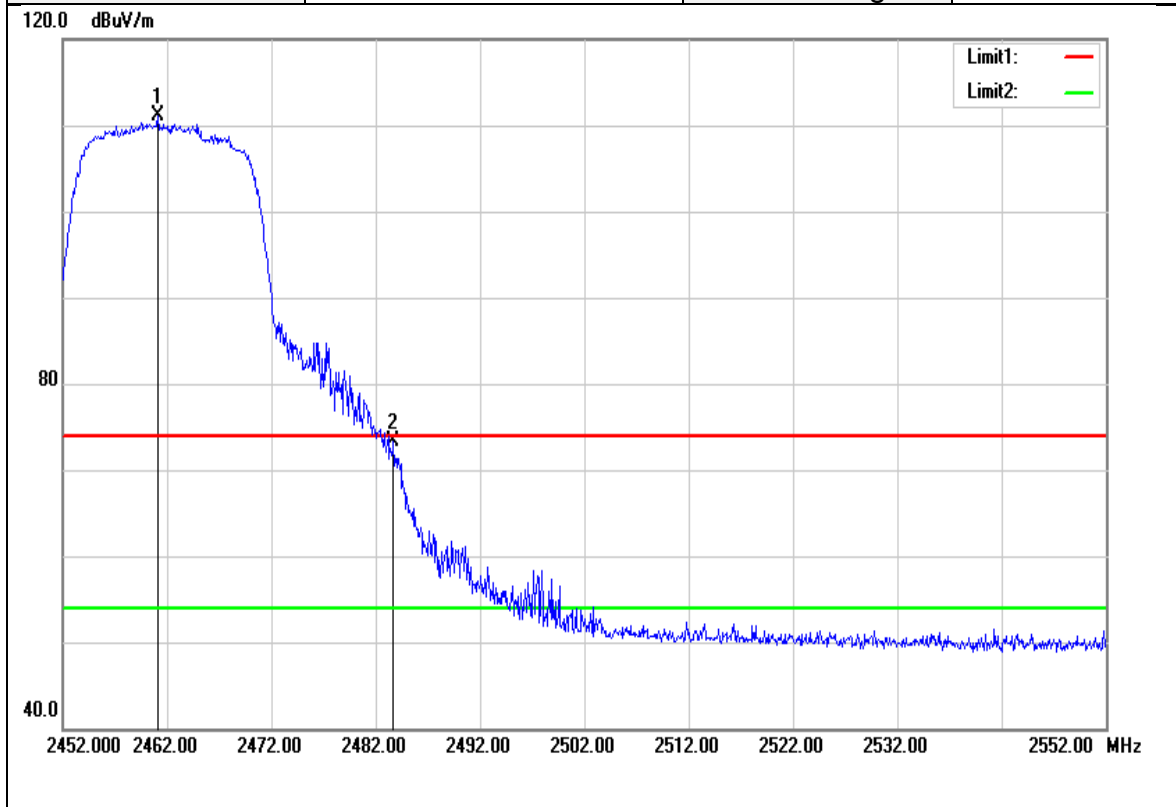

No.	Frequency (MHz)	Reading (dBuV)	Correct Factor(dB/m)	Result (dBuV/m)	Limit (dBuV/m)	Margin (dB)	Remark
1	2461.100	113.14	-2.10	111.04	-	-	peak
2	2483.700	75.24	-1.99	73.25	74.00	-0.75	peak

Test Mode	IEEE 802.11g High CH	Temperature:	27(°C)/ 53%RH
Test Item	Band Edge	Test Date	January 16, 2017
Polarize	Vertical	Test Engineer	Kevin Kuo
Detector	Average	Test Voltage	120Vac / 60Hz

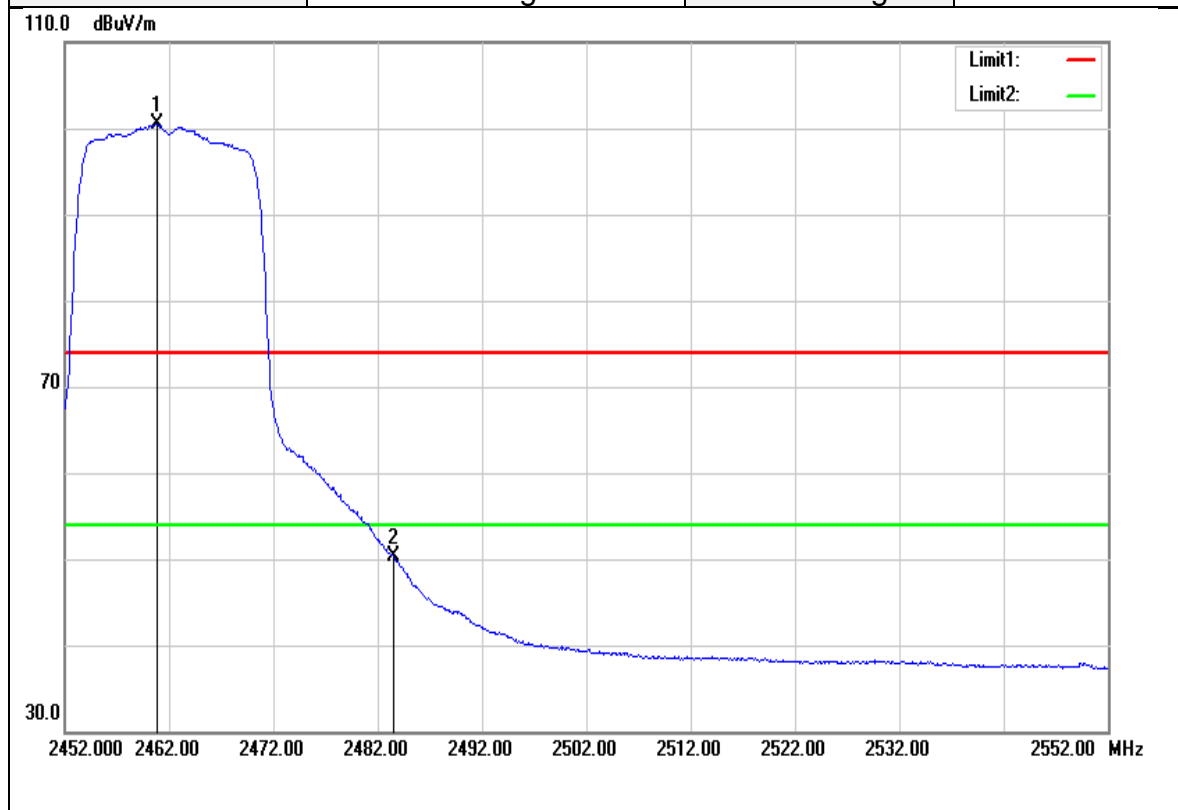

No.	Frequency (MHz)	Reading (dBuV)	Correct Factor(dB/m)	Result (dBuV/m)	Limit (dBuV/m)	Margin (dB)	Remark
1	2460.800	102.62	-2.10	100.52	-	-	AVG
2	2483.500	52.19	-1.99	50.20	54.00	-3.80	AVG

Test Mode	IEEE 802.11n HT20 Low CH	Temp/Hum	27(°C)/ 53%RH
Test Item	Band Edge	Test Date	January 16, 2017
Polarize	Vertical	Test Engineer	Kevin Kuo
Detector	Peak	Test Voltage	120Vac / 60Hz

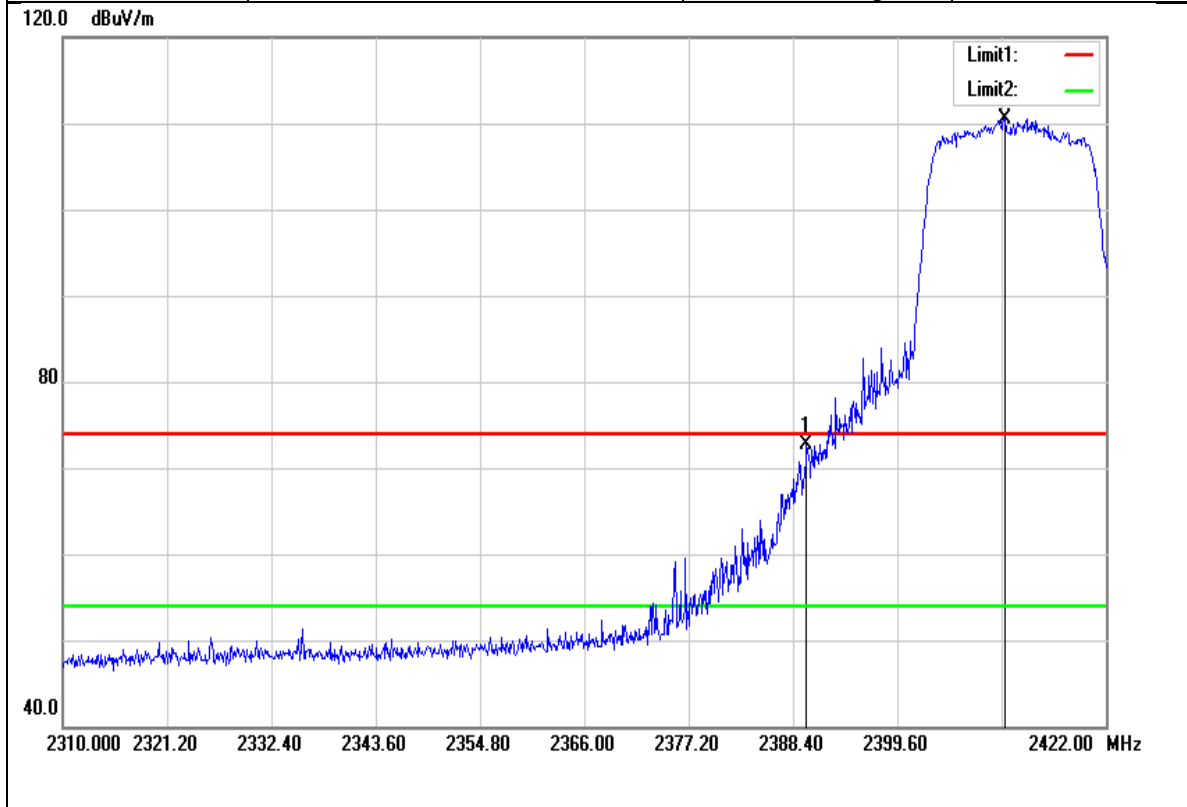

No.	Frequency (MHz)	Reading (dBuV)	Correct Factor(dB/m)	Result (dBuV/m)	Limit (dBuV/m)	Margin (dB)	Remark
1	2389.856	75.24	-2.49	72.75	74.00	-1.25	peak
2	2411.136	112.90	-2.42	110.48	-	-	peak

Test Mode	IEEE 802.11n HT20 Low CH	Temperature:	27(°C)/ 53%RH
Test Item	Band Edge	Test Date	January 16, 2017
Polarize	Vertical	Test Engineer	Kevin Kuo
Detector	Average	Test Voltage	120Vac / 60Hz

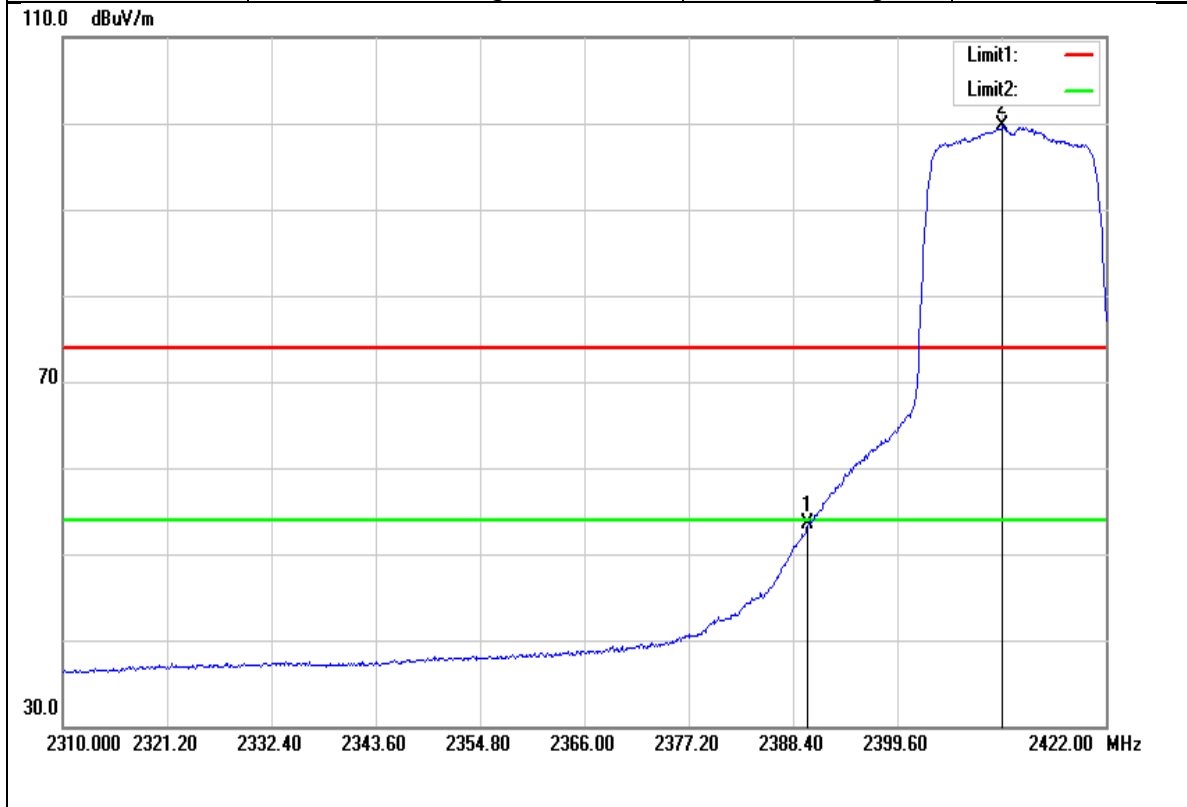

No.	Frequency (MHz)	Reading (dBuV)	Correct Factor(dB/m)	Result (dBuV/m)	Limit (dBuV/m)	Margin (dB)	Remark
1	2390.000	56.06	-2.49	53.57	54.00	-0.43	AVG
2	2410.912	102.15	-2.42	99.73	-	-	AVG

Test Mode	IEEE 802.11n HT20 High CH	Temp/Hum	27(°C)/ 53%RH
Test Item	Band Edge	Test Date	January 16, 2017
Polarize	Vertical	Test Engineer	Kevin Kuo
Detector	Peak	Test Voltage	120Vac / 60Hz

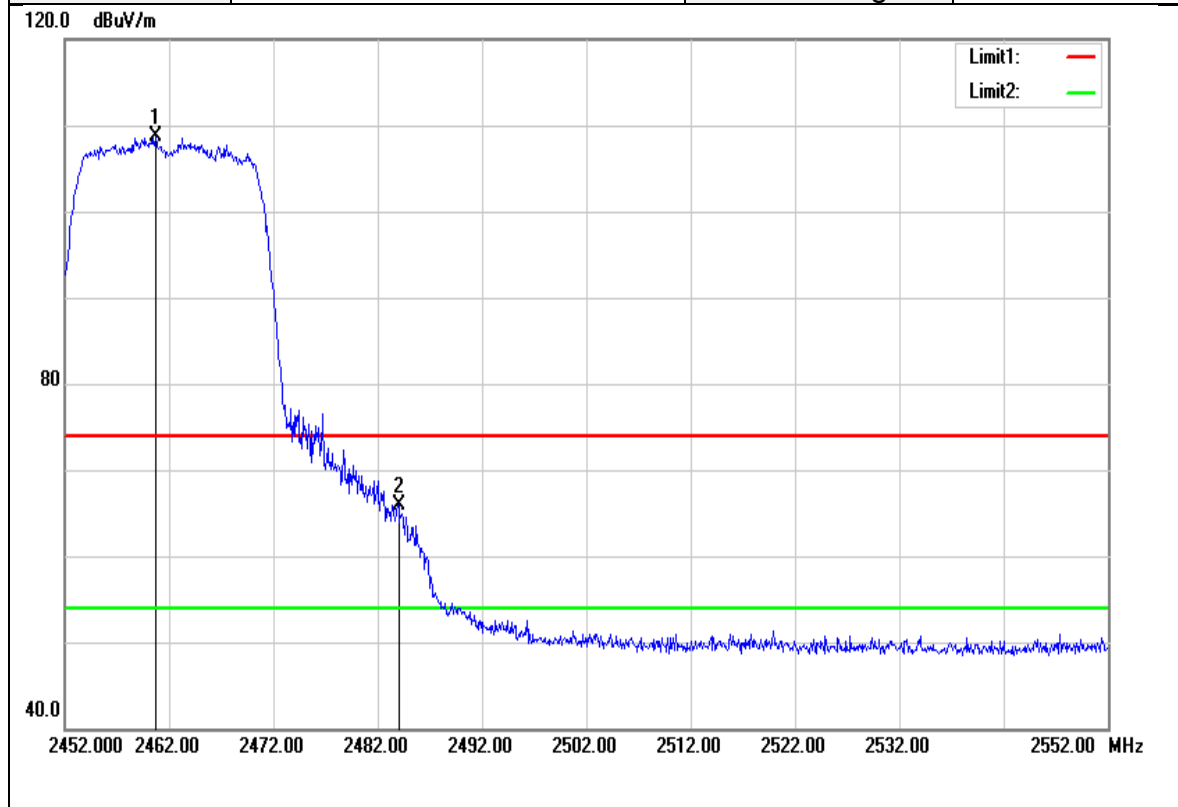

No.	Frequency (MHz)	Reading (dBuV)	Correct Factor(dB/m)	Result (dBuV/m)	Limit (dBuV/m)	Margin (dB)	Remark
1	2460.700	110.81	-2.10	108.71	-	-	peak
2	2484.000	67.90	-1.99	65.91	74.00	-8.09	peak

Test Mode	IEEE 802.11n HT20 High CH	Temperature:	27(°C)/ 53%RH
Test Item	Band Edge	Test Date	January 16, 2017
Polarize	Vertical	Test Engineer	Kevin Kuo
Detector	Average	Test Voltage	120Vac / 60Hz

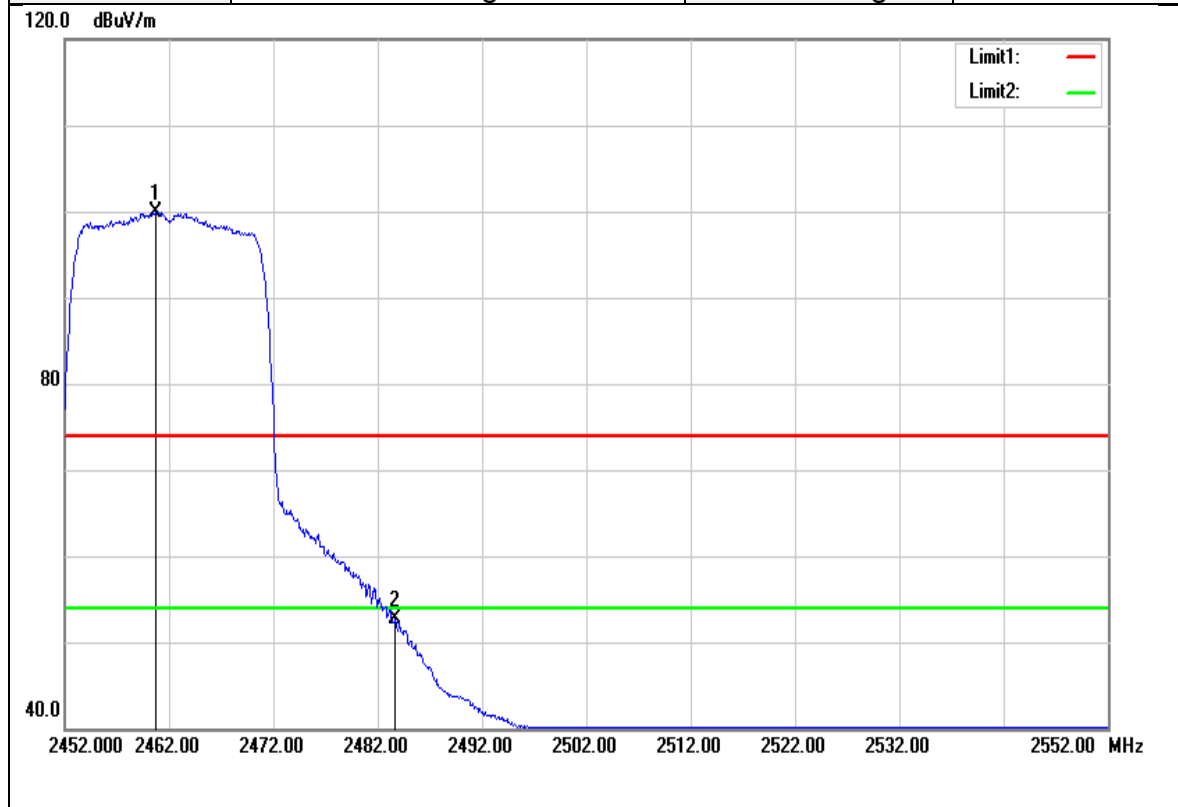

No.	Frequency (MHz)	Reading (dBuV)	Correct Factor(dB/m)	Result (dBuV/m)	Limit (dBuV/m)	Margin (dB)	Remark
1	2460.700	102.02	-2.10	99.92	-	-	AVG
2	2483.700	54.62	-1.99	52.63	54.00	-1.37	AVG

Test Mode	IEEE 802.11n HT40 Low CH	Temp/Hum	27(°C)/ 53%RH
Test Item	Band Edge	Test Date	January 16, 2017
Polarize	Vertical	Test Engineer	Kevin Kuo
Detector	Peak	Test Voltage	120Vac / 60Hz

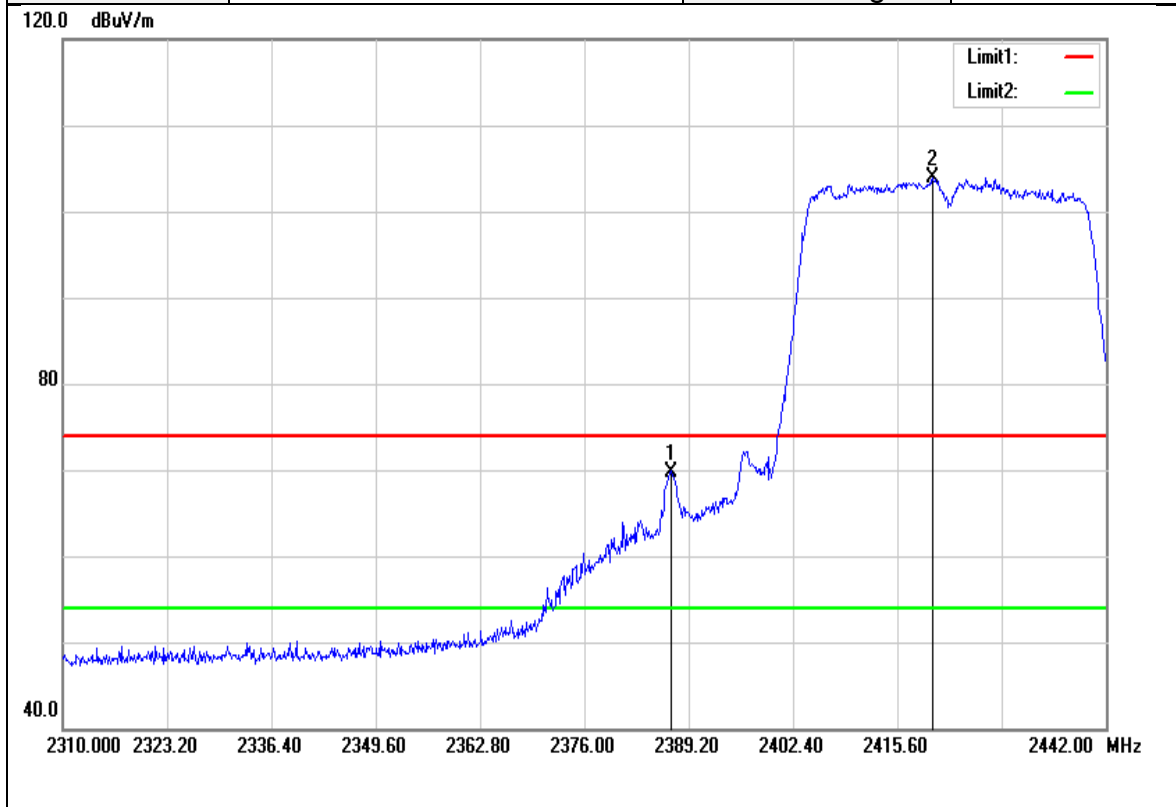

No.	Frequency (MHz)	Reading (dBuV)	Correct Factor(dB/m)	Result (dBuV/m)	Limit (dBuV/m)	Margin (dB)	Remark
1	2386.956	72.32	-2.52	69.80	74.00	-4.20	peak
2	2420.088	106.33	-2.36	103.97	-	-	peak

Test Mode	IEEE 802.11n HT40 Low CH	Temperature:	27(°C)/ 53%RH
Test Item	Band Edge	Test Date	January 16, 2017
Polarize	Vertical	Test Engineer	Kevin Kuo
Detector	Average	Test Voltage	120Vac / 60Hz

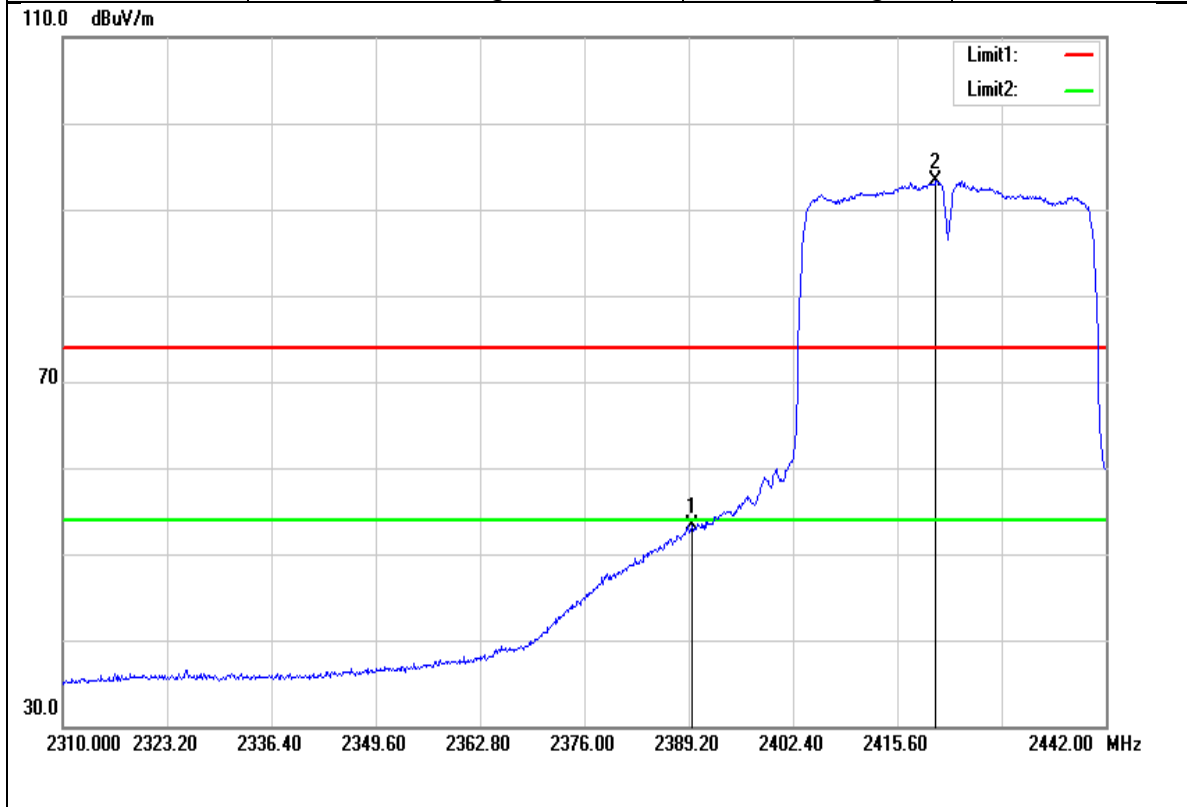

No.	Frequency (MHz)	Reading (dBuV)	Correct Factor(dB/m)	Result (dBuV/m)	Limit (dBuV/m)	Margin (dB)	Remark
1	2389.596	55.84	-2.49	53.35	54.00	-0.65	AVG
2	2420.484	95.64	-2.35	93.29	-	-	AVG

Test Mode	IEEE 802.11n HT40 High CH	Temp/Hum	27(°C)/ 53%RH
Test Item	Band Edge	Test Date	January 16, 2017
Polarize	Vertical	Test Engineer	Kevin Kuo
Detector	Peak	Test Voltage	120Vac / 60Hz

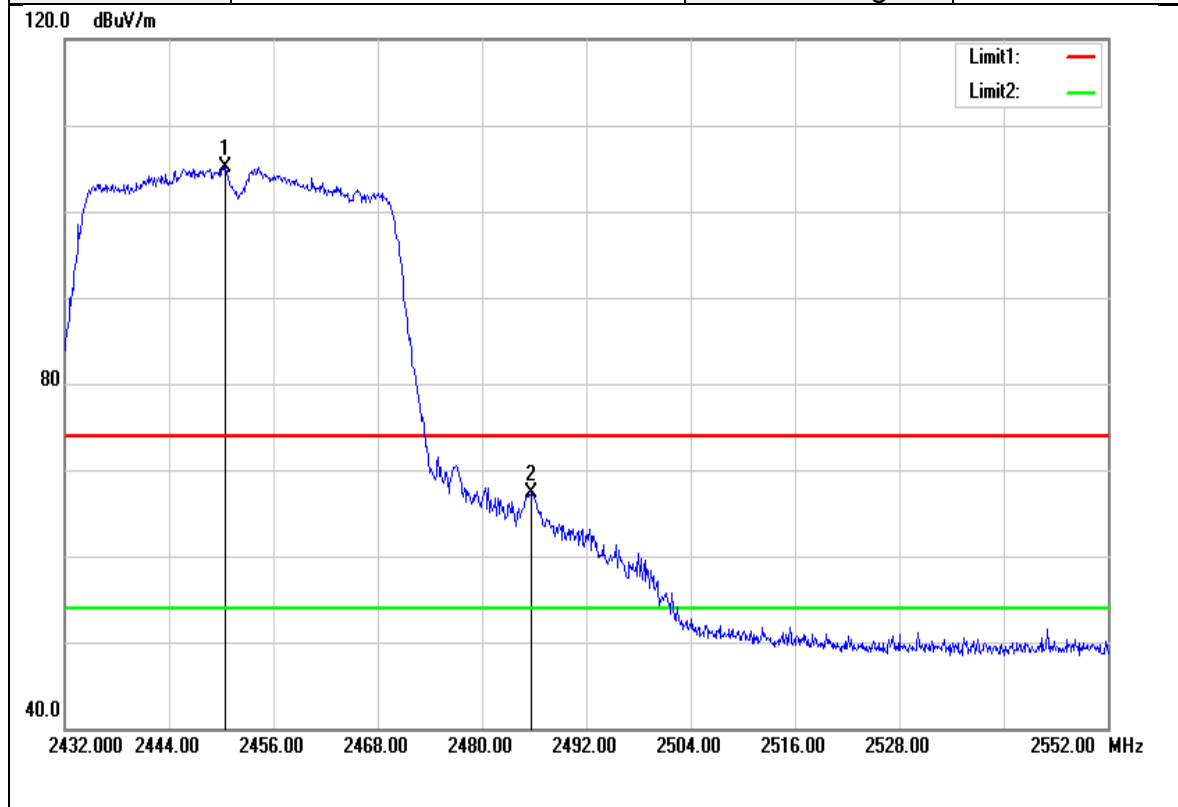

No.	Frequency (MHz)	Reading (dBuV)	Correct Factor(dB/m)	Result (dBuV/m)	Limit (dBuV/m)	Margin (dB)	Remark
1	2450.480	107.31	-2.14	105.17	-	-	peak
2	2485.640	69.29	-1.97	67.32	74.00	-6.68	peak

Test Mode	IEEE 802.11n HT40 High CH	Temperature:	27(°C)/ 53%RH
Test Item	Band Edge	Test Date	January 16, 2017
Polarize	Vertical	Test Engineer	Kevin Kuo
Detector	Average	Test Voltage	120Vac / 60Hz

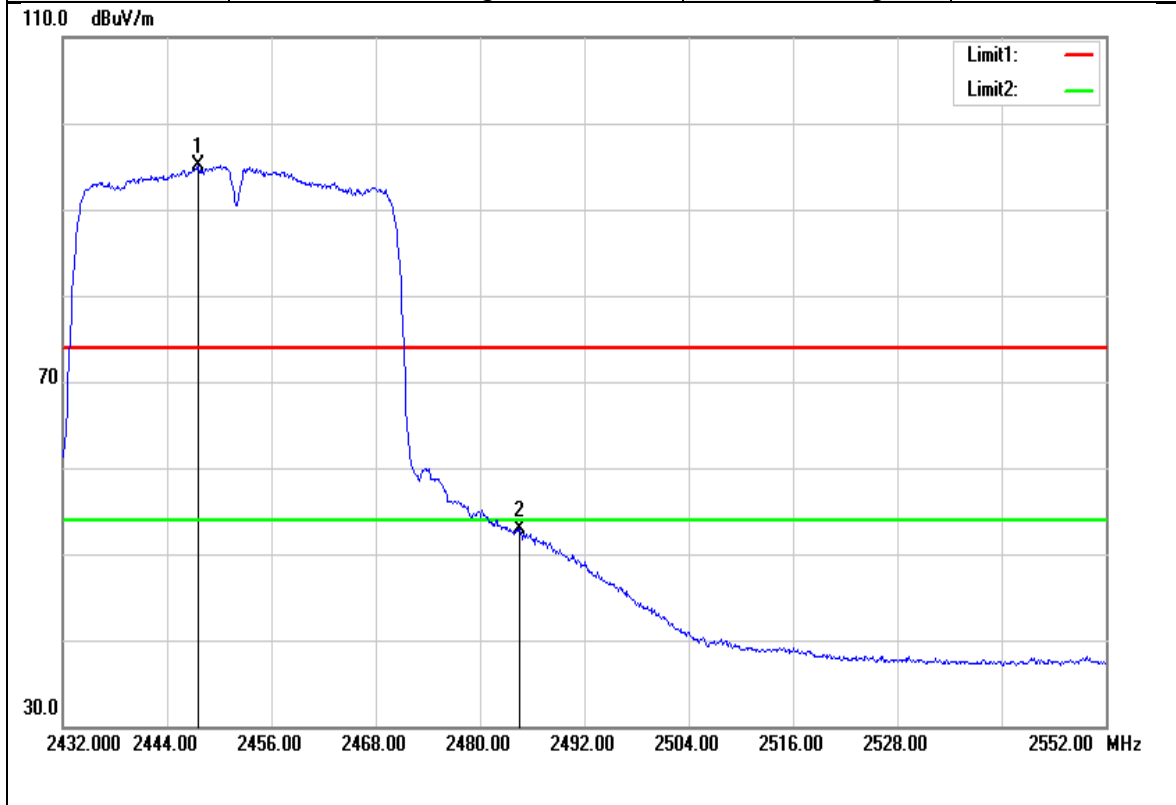

No.	Frequency (MHz)	Reading (dBuV)	Correct Factor(dB/m)	Result (dBuV/m)	Limit (dBuV/m)	Margin (dB)	Remark
1	2447.600	97.22	-2.16	95.06	-	-	AVG
2	2484.560	54.88	-1.98	52.90	54.00	-1.10	AVG

Below 1G Test Data

Test Mode	Mode 1	Temp/Hum	27(°C)/ 53%RH
Test Item	30MHz-1GHz	Test Date	Dec30, 2016
Polarize	Vertical	Test Engineer	Kevin Kuo
Detector	Peak and Qusi-peak	Test Voltage	120Vac / 60Hz

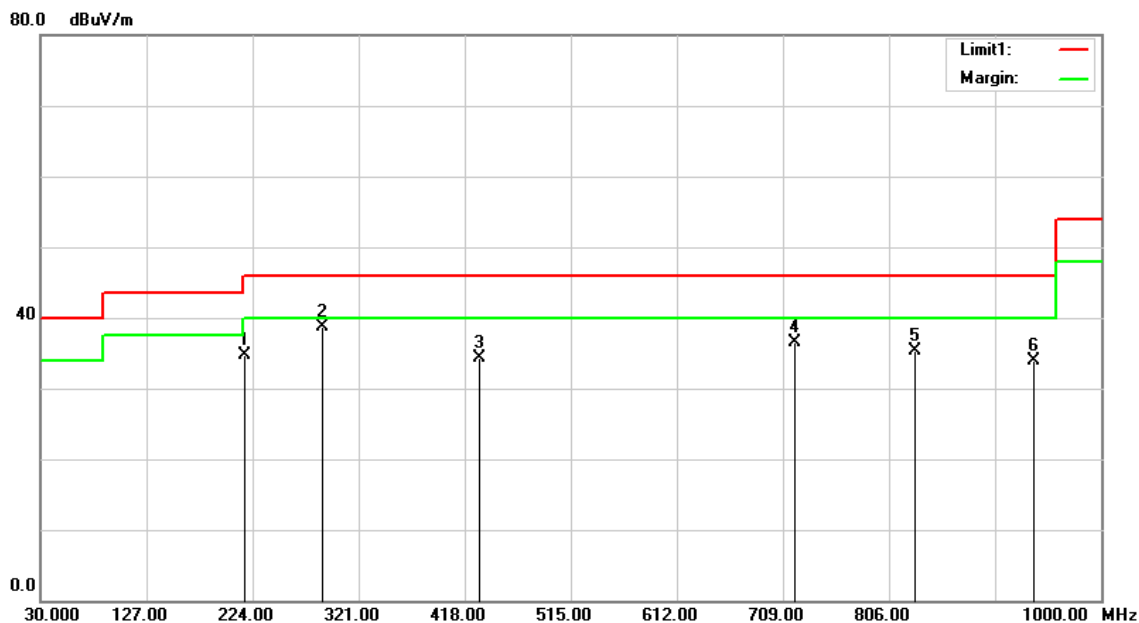

Frequency (MHz)	Reading (dBuV)	Correct Factor (dB/m)	Result (dBuV/m)	Limit (dBuV/m)	Margin (dB)	Remark
216.2400	51.34	-16.69	34.65	46.00	-11.35	QP
288.0200	53.22	-14.46	38.76	46.00	-7.24	peak
431.5800	45.13	-10.75	34.38	46.00	-11.62	peak
719.6700	42.22	-5.62	36.60	46.00	-9.40	peak
829.2800	39.45	-4.08	35.37	46.00	-10.63	peak
937.9200	36.55	-2.59	33.96	46.00	-12.04	peak

Test Mode	Mode 1	Temp/Hum	27(°C)/ 53%RH
Test Item	30MHz-1GHz	Test Date	Dec30, 2016
Polarize	Horizontal	Test Engineer	Kevin Kuo
Detector	Peak and Qusi-peak	Test Voltage	120Vac / 60Hz

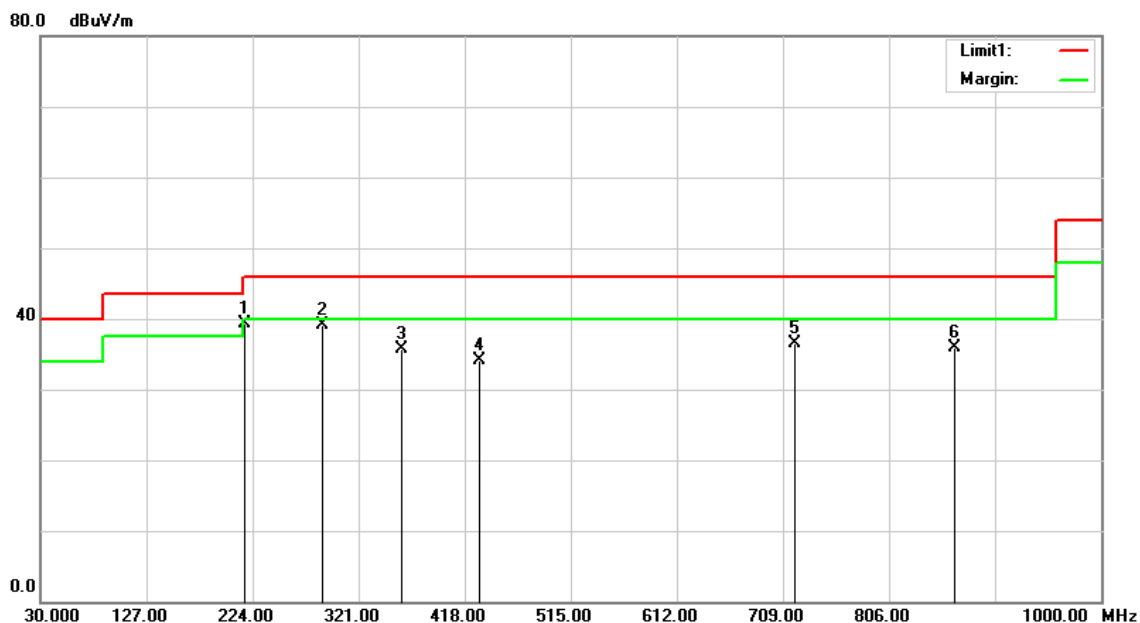

Frequency (MHz)	Reading (dBuV)	Correct Factor (dB/m)	Result (dBuV/m)	Limit (dBuV/m)	Margin (dB)	Remark
216.2400	56.05	-16.69	39.36	46.00	-6.64	peak
288.0200	53.56	-14.46	39.10	46.00	-6.90	peak
360.7700	48.43	-12.63	35.80	46.00	-10.20	peak
431.5800	44.93	-10.75	34.18	46.00	-11.82	peak
719.6700	42.17	-5.62	36.55	46.00	-9.45	peak
866.1400	39.40	-3.59	35.81	46.00	-10.19	peak

Above 1G Test Data

Test Mode	IEEE 802.11b Low CH	Temp/Hum	27(°C)/ 53%RH
Test Item	Harmonic	Test Date	January 21, 2017
Polarize	Vertical	Test Engineer	Kevin Kuo
Detector	Peak and Average	Test Voltage	120Vac / 60Hz

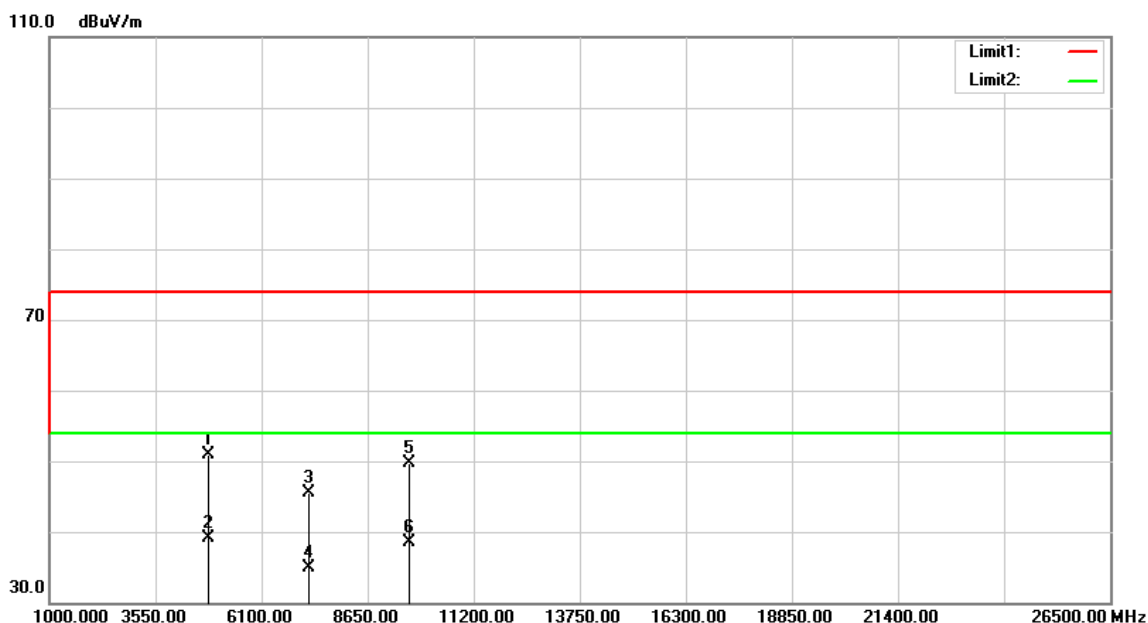

Frequency (MHz)	Reading (dBuV)	Correct Factor (dB/m)	Result (dBuV/m)	Limit (dBuV/m)	Margin (dB)	Remark
4827.000	45.81	5.11	50.92	74.00	-23.08	peak
4827.000	34.04	5.11	39.15	54.00	-14.85	AVG
7236.000	32.84	12.71	45.55	74.00	-28.45	peak
7236.000	22.21	12.71	34.92	54.00	-19.08	AVG
9648.000	32.10	17.60	49.70	74.00	-24.30	peak
9648.000	20.98	17.60	38.58	54.00	-15.42	AVG

Remark:

1. Measuring frequencies from 1 GHz to the 10th harmonic of highest fundamental frequency.
2. For above 1GHz, the EUT peak value was under average limit, therefore the Average value compliance with the average limit

Test Mode	IEEE 802.11b Low CH	Temp/Hum	27(°C)/ 53%RH
Test Item	Harmonic	Test Date	January 21, 2017
Polarize	Horizontal	Test Engineer	Kevin Kuo
Detector	Peak and Average	Test Voltage	120Vac / 60Hz

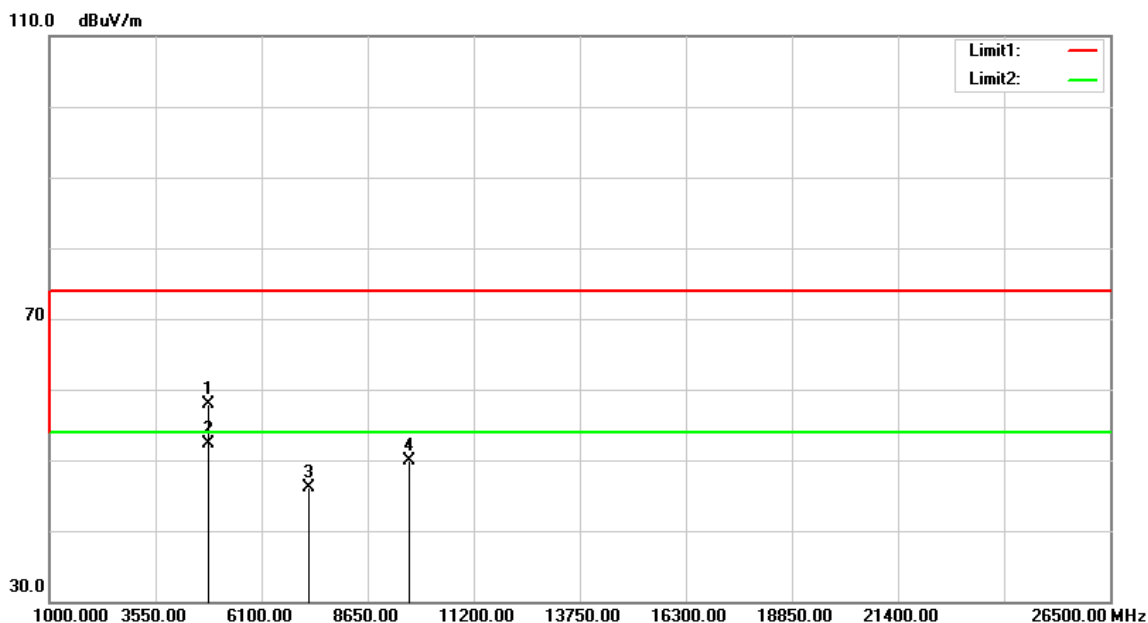

Frequency (MHz)	Reading (dBuV)	Correct Factor (dB/m)	Result (dBuV/m)	Limit (dBuV/m)	Margin (dB)	Remark
4827.000	52.77	5.11	57.88	74.00	-16.12	peak
4827.000	47.15	5.11	52.26	54.00	-1.74	AVG
7236.000	33.38	12.71	46.09	74.00	-27.91	peak
9648.000	32.21	17.60	49.81	74.00	-24.19	peak

Remark:

1. Measuring frequencies from 1 GHz to the 10th harmonic of highest fundamental frequency.
2. For above 1GHz, the EUT peak value was under average limit, therefore the Average value compliance with the average limit

Test Mode	IEEE 802.11b Mid CH	Temp/Hum	27(°C)/ 53%RH
Test Item	Harmonic	Test Date	January 21, 2017
Polarize	Vertical	Test Engineer	Kevin Kuo
Detector	Peak and Average	Test Voltage	120Vac / 60Hz

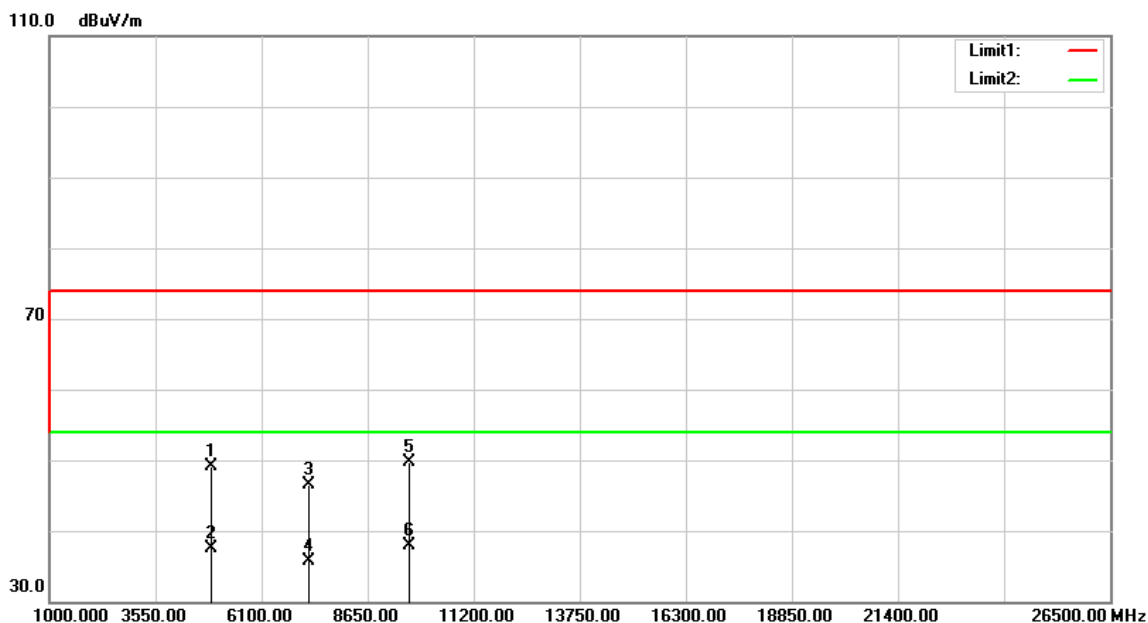

Frequency (MHz)	Reading (dBuV)	Correct Factor (dB/m)	Result (dBuV/m)	Limit (dBuV/m)	Margin (dB)	Remark
4876.000	43.88	5.24	49.12	74.00	-24.88	peak
4876.000	32.28	5.24	37.52	54.00	-16.48	AVG
7236.000	33.85	12.71	46.56	74.00	-27.44	peak
7236.000	22.98	12.71	35.69	54.00	-18.31	AVG
9648.000	32.08	17.60	49.68	74.00	-24.32	peak
9648.000	20.21	17.60	37.81	54.00	-16.19	AVG

Remark:

1. Measuring frequencies from 1 GHz to the 10th harmonic of highest fundamental frequency.
2. For above 1GHz, the EUT peak value was under average limit, therefore the Average value compliance with the average limit

Test Mode	IEEE 802.11b Mid CH	Temp/Hum	27(°C)/ 53%RH
Test Item	Harmonic	Test Date	January 21, 2017
Polarize	Horizontal	Test Engineer	Kevin Kuo
Detector	Peak and Average	Test Voltage	120Vac / 60Hz

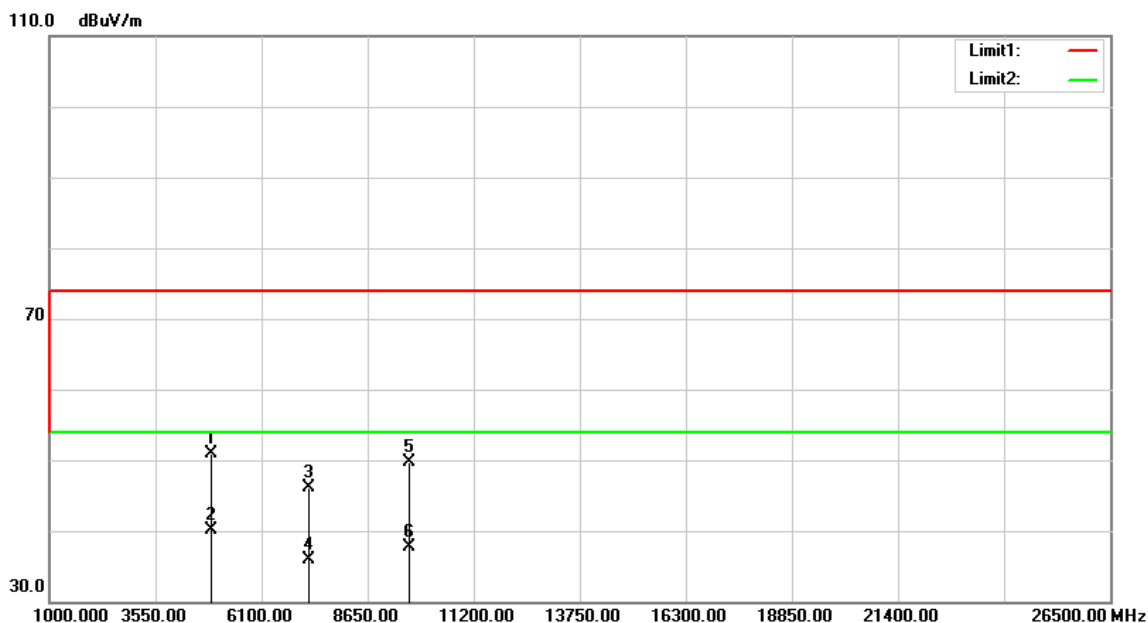

Frequency (MHz)	Reading (dBuV)	Correct Factor (dB/m)	Result (dBuV/m)	Limit (dBuV/m)	Margin (dB)	Remark
4876.000	45.61	5.24	50.85	74.00	-23.15	peak
4876.000	34.94	5.24	40.18	54.00	-13.82	AVG
7236.000	33.44	12.71	46.15	74.00	-27.85	peak
7236.000	23.11	12.71	35.82	54.00	-18.18	AVG
9648.000	32.08	17.60	49.68	74.00	-24.32	peak
9648.000	20.09	17.60	37.69	54.00	-16.31	AVG

Remark:

1. Measuring frequencies from 1 GHz to the 10th harmonic of highest fundamental frequency.
2. For above 1GHz, the EUT peak value was under average limit, therefore the Average value compliance with the average limit

Test Mode	IEEE 802.11b High CH	Temp/Hum	27(°C)/ 53%RH
Test Item	Harmonic	Test Date	January 21, 2017
Polarize	Vertical	Test Engineer	Kevin Kuo
Detector	Peak and Average	Test Voltage	120Vac / 60Hz

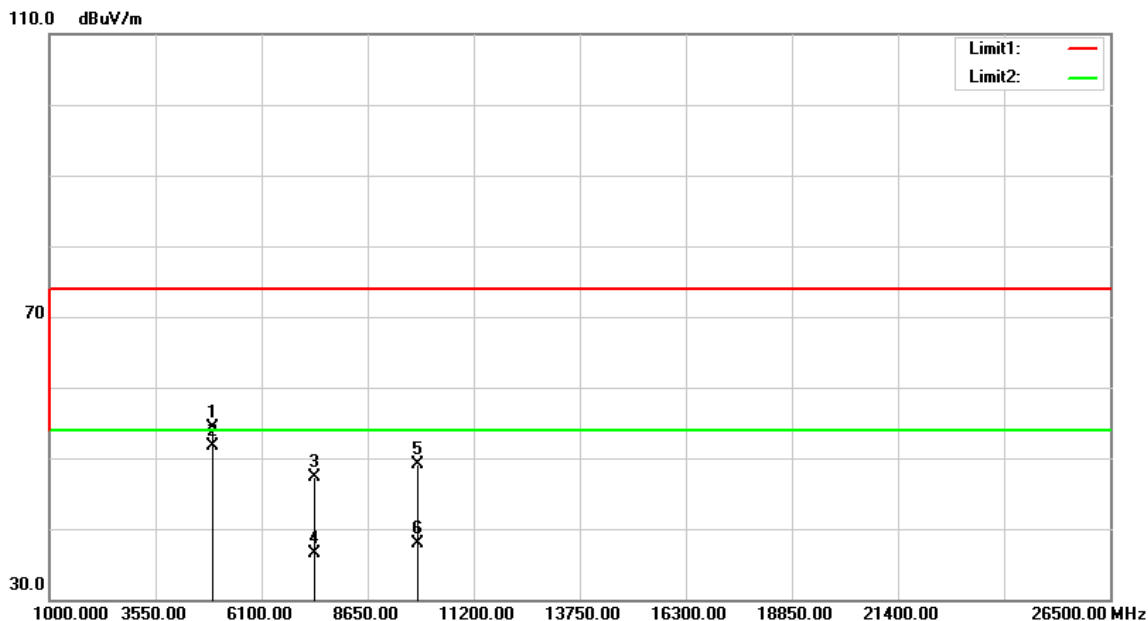

Frequency (MHz)	Reading (dBuV)	Correct Factor (dB/m)	Result (dBuV/m)	Limit (dBuV/m)	Margin (dB)	Remark
4925.000	48.91	5.37	54.28	74.00	-19.72	peak
4925.000	46.24	5.37	51.61	54.00	-2.39	AVG
7386.000	34.10	13.17	47.27	74.00	-26.73	peak
7386.000	23.41	13.17	36.58	54.00	-17.42	AVG
9848.000	31.44	17.60	49.04	74.00	-24.96	peak
9848.000	20.29	17.60	37.89	54.00	-16.11	AVG

Remark:

1. Measuring frequencies from 1 GHz to the 10th harmonic of highest fundamental frequency.
2. For above 1GHz, the EUT peak value was under average limit, therefore the Average value compliance with the average limit

Test Mode	IEEE 802.11b High CH	Temp/Hum	27(°C)/ 53%RH
Test Item	Harmonic	Test Date	January 21, 2017
Polarize	Horizontal	Test Engineer	Kevin Kuo
Detector	Peak and Average	Test Voltage	120Vac / 60Hz

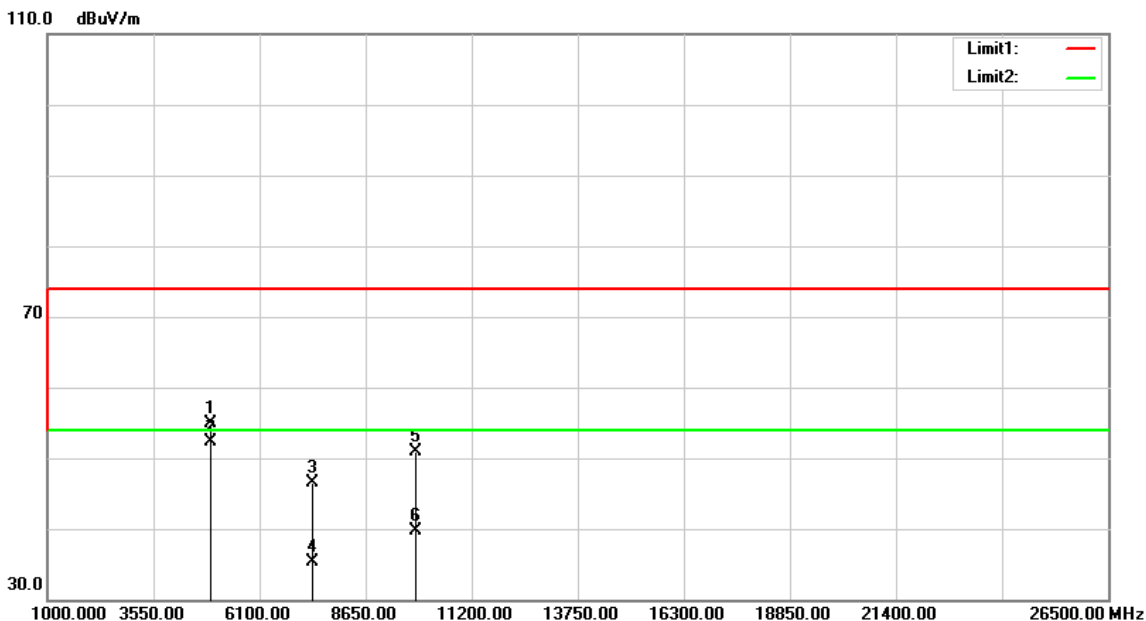

Frequency (MHz)	Reading (dBuV)	Correct Factor (dB/m)	Result (dBuV/m)	Limit (dBuV/m)	Margin (dB)	Remark
4925.000	49.46	5.37	54.83	74.00	-19.17	peak
4925.000	46.94	5.37	52.31	54.00	-1.69	AVG
7386.000	33.33	13.17	46.50	74.00	-27.50	peak
7386.000	22.23	13.17	35.40	54.00	-18.60	AVG
9848.000	33.23	17.60	50.83	74.00	-23.17	peak
9848.000	22.18	17.60	39.78	54.00	-14.22	AVG

Remark:

1. Measuring frequencies from 1 GHz to the 10th harmonic of highest fundamental frequency.
2. For above 1GHz, the EUT peak value was under average limit, therefore the Average value compliance with the average limit

Test Mode	IEEE 802.11g Low CH	Temp/Hum	27(°C)/ 53%RH
Test Item	Harmonic	Test Date	January 21, 2017
Polarize	Vertical	Test Engineer	Kevin Kuo
Detector	Peak and Average	Test Voltage	120Vac / 60Hz

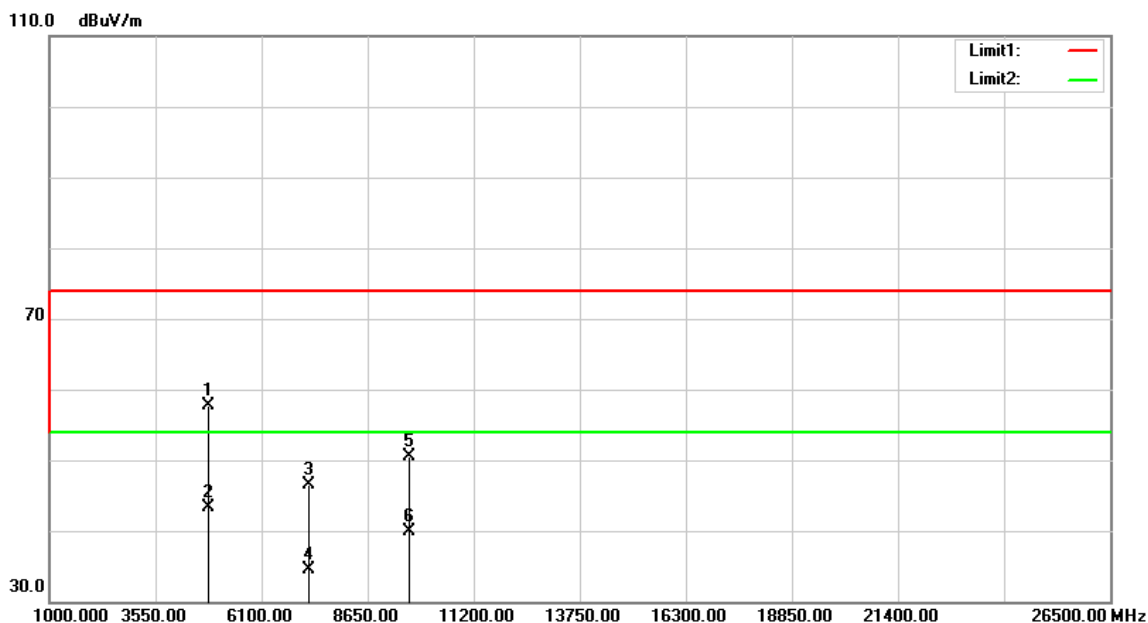

Frequency (MHz)	Reading (dBuV)	Correct Factor (dB/m)	Result (dBuV/m)	Limit (dBuV/m)	Margin (dB)	Remark
4827.000	52.54	5.11	57.65	74.00	-16.35	peak
4827.000	38.22	5.11	43.33	54.00	-10.67	AVG
7236.000	33.85	12.71	46.56	74.00	-27.44	peak
7236.000	21.87	12.71	34.58	54.00	-19.42	AVG
9648.000	32.96	17.60	50.56	74.00	-23.44	peak
9648.000	22.27	17.60	39.87	54.00	-14.13	AVG

Remark:

1. Measuring frequencies from 1 GHz to the 10th harmonic of highest fundamental frequency.
2. For above 1GHz, the EUT peak value was under average limit, therefore the Average value compliance with the average limit

Test Mode	IEEE 802.11g Low CH	Temp/Hum	27(°C)/ 53%RH
Test Item	Harmonic	Test Date	January 21, 2017
Polarize	Horizontal	Test Engineer	Kevin Kuo
Detector	Peak and Average	Test Voltage	120Vac / 60Hz

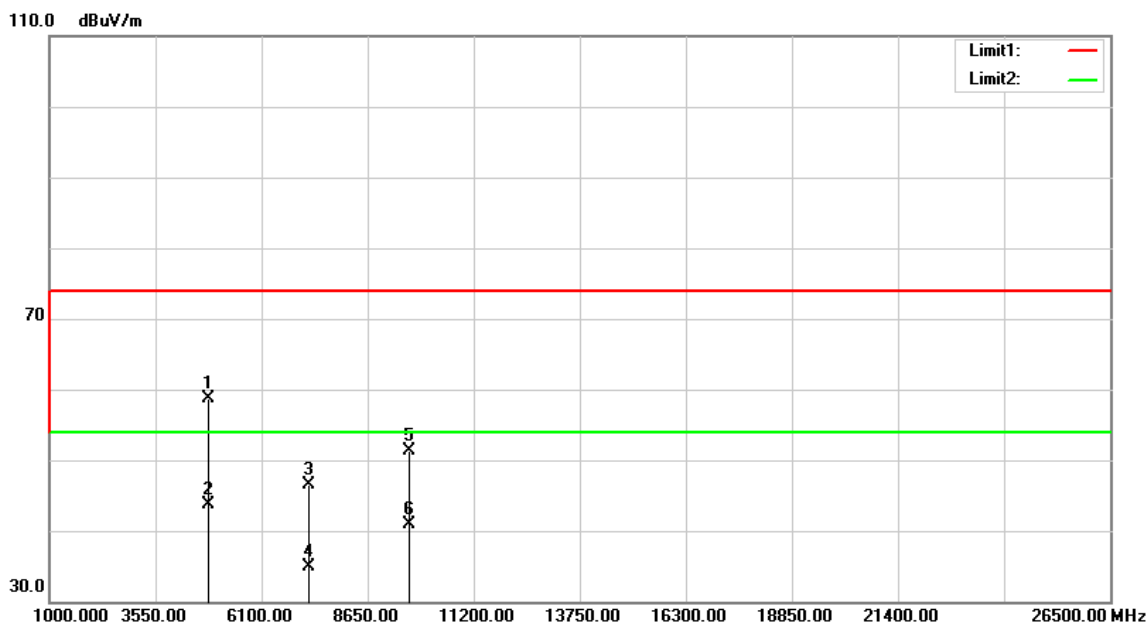

Frequency (MHz)	Reading (dBuV)	Correct Factor (dB/m)	Result (dBuV/m)	Limit (dBuV/m)	Margin (dB)	Remark
4827.000	53.66	5.11	58.77	74.00	-15.23	peak
4827.000	38.51	5.11	43.62	54.00	-10.38	AVG
7236.000	33.78	12.71	46.49	74.00	-27.51	peak
7236.000	22.14	12.71	34.85	54.00	-19.15	AVG
9648.000	33.63	17.60	51.23	74.00	-22.77	peak
9648.000	23.38	17.60	40.98	54.00	-13.02	AVG

Remark:

1. Measuring frequencies from 1 GHz to the 10th harmonic of highest fundamental frequency.
2. For above 1GHz, the EUT peak value was under average limit, therefore the Average value compliance with the average limit

Test Mode	IEEE 802.11g Mid CH	Temp/Hum	27(°C)/ 53%RH
Test Item	Harmonic	Test Date	January 21, 2017
Polarize	Vertical	Test Engineer	Kevin Kuo
Detector	Peak and Average	Test Voltage	120Vac / 60Hz

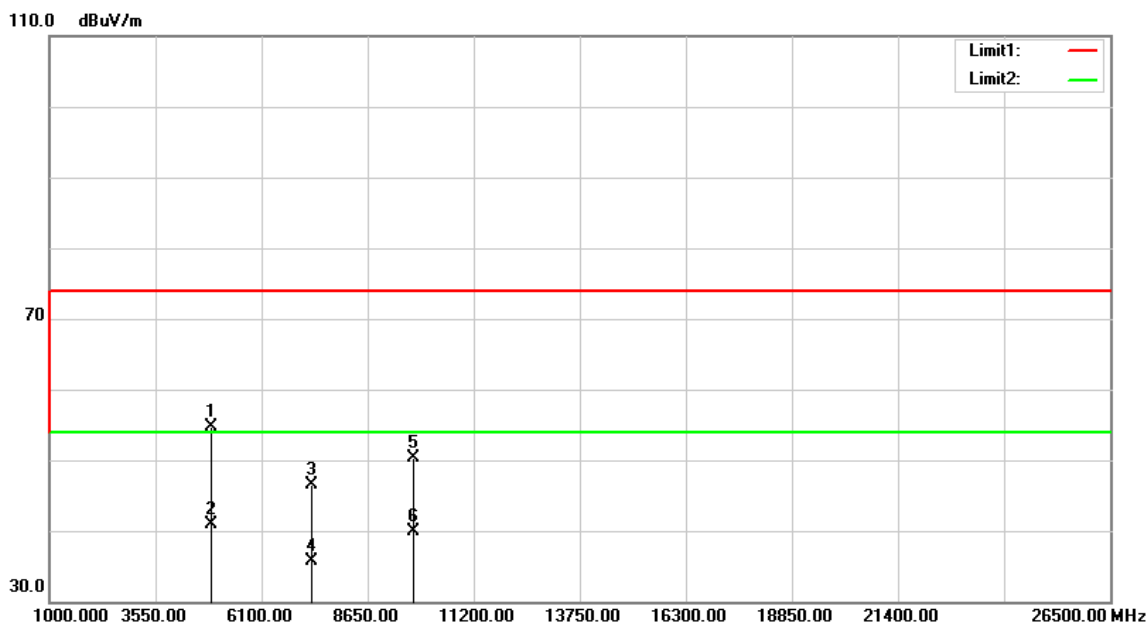

Frequency (MHz)	Reading (dBuV)	Correct Factor (dB/m)	Result (dBuV/m)	Limit (dBuV/m)	Margin (dB)	Remark
4876.000	49.39	5.24	54.63	74.00	-19.37	peak
4876.000	35.66	5.24	40.90	54.00	-13.10	AVG
7311.000	33.56	12.94	46.50	74.00	-27.50	peak
7311.000	22.80	12.94	35.74	54.00	-18.26	AVG
9748.000	32.79	17.60	50.39	74.00	-23.61	peak
9748.000	22.25	17.60	39.85	54.00	-14.15	AVG

Remark:

1. Measuring frequencies from 1 GHz to the 10th harmonic of highest fundamental frequency.
2. For above 1GHz, the EUT peak value was under average limit, therefore the Average value compliance with the average limit

Test Mode	IEEE 802.11g Mid CH	Temp/Hum	27(°C)/ 53%RH
Test Item	Harmonic	Test Date	January 21, 2017
Polarize	Horizontal	Test Engineer	Kevin Kuo
Detector	Peak and Average	Test Voltage	120Vac / 60Hz

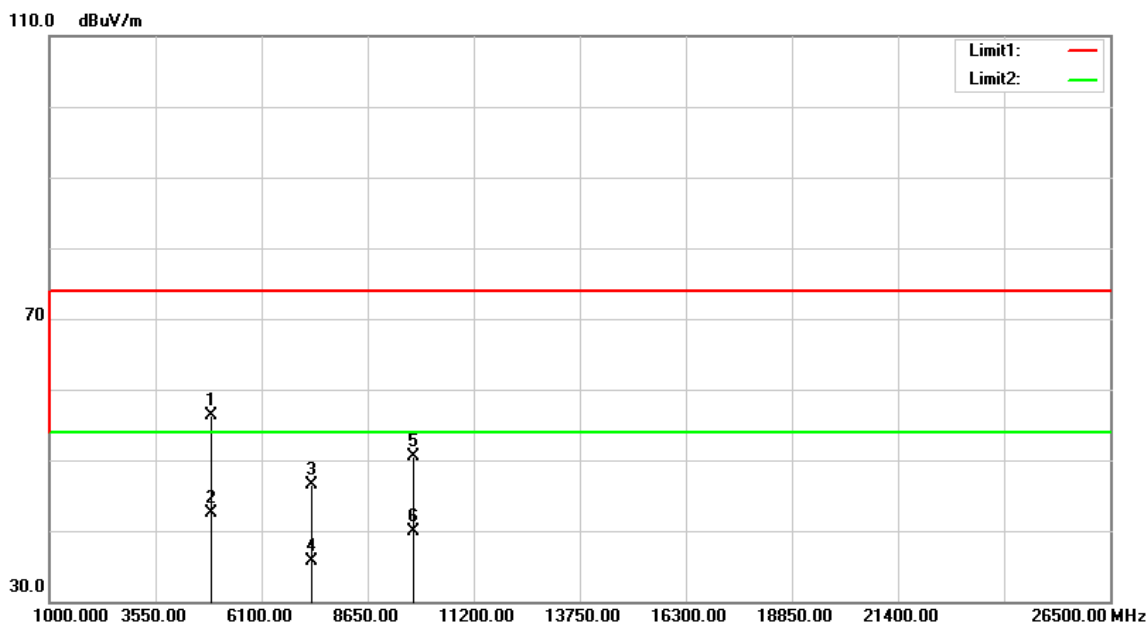

Frequency (MHz)	Reading (dBuV)	Correct Factor (dB/m)	Result (dBuV/m)	Limit (dBuV/m)	Margin (B)	Remark
4876.000	51.00	5.24	56.24	74.00	-17.76	peak
4876.000	37.35	5.24	42.59	54.00	-11.41	AVG
7311.000	33.54	12.94	46.48	74.00	-27.52	peak
7311.000	22.75	12.94	35.69	54.00	-18.31	AVG
9748.000	32.99	17.60	50.59	74.00	-23.41	peak
9748.000	22.27	17.60	39.87	54.00	-14.13	AVG

Remark:

1. Measuring frequencies from 1 GHz to the 10th harmonic of highest fundamental frequency.
2. For above 1GHz, the EUT peak value was under average limit, therefore the Average value compliance with the average limit

Test Mode	IEEE 802.11g High CH	Temp/Hum	27(°C)/ 53%RH
Test Item	Harmonic	Test Date	January 21, 2017
Polarize	Vertical	Test Engineer	Kevin Kuo
Detector	Peak and Average	Test Voltage	120Vac / 60Hz

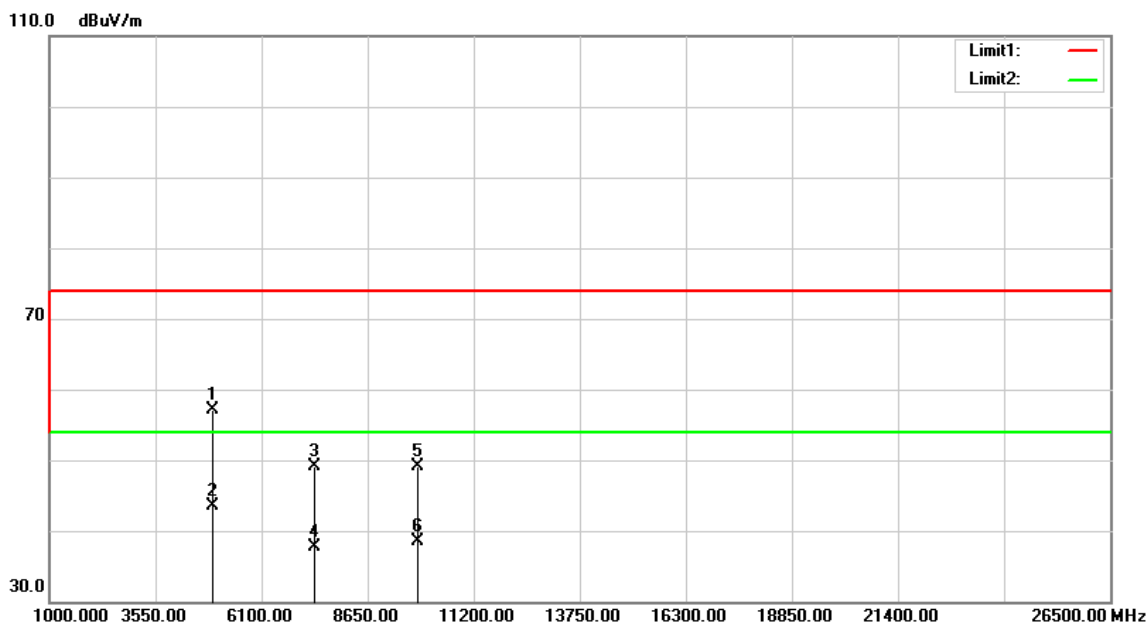

Frequency (MHz)	Reading (dBuV)	Correct Factor (dB/m)	Result (dBuV/m)	Limit (dBuV/m)	Margin (dB)	Remark
4918.000	51.74	5.35	57.09	74.00	-16.91	peak
4918.000	38.13	5.35	43.48	54.00	-10.52	AVG
7386.000	35.89	13.17	49.06	74.00	-24.94	peak
7386.000	24.51	13.17	37.68	54.00	-16.32	AVG
9848.000	31.59	17.60	49.19	74.00	-24.81	peak
9848.000	20.88	17.60	38.48	54.00	-15.52	AVG

Remark:

1. Measuring frequencies from 1 GHz to the 10th harmonic of highest fundamental frequency.
2. For above 1GHz, the EUT peak value was under average limit, therefore the Average value compliance with the average limit

Test Mode	IEEE 802.11g High CH	Temp/Hum	27(°C)/ 53%RH
Test Item	Harmonic	Test Date	January 21, 2017
Polarize	Horizontal	Test Engineer	Kevin Kuo
Detector	Peak and Average	Test Voltage	120Vac / 60Hz

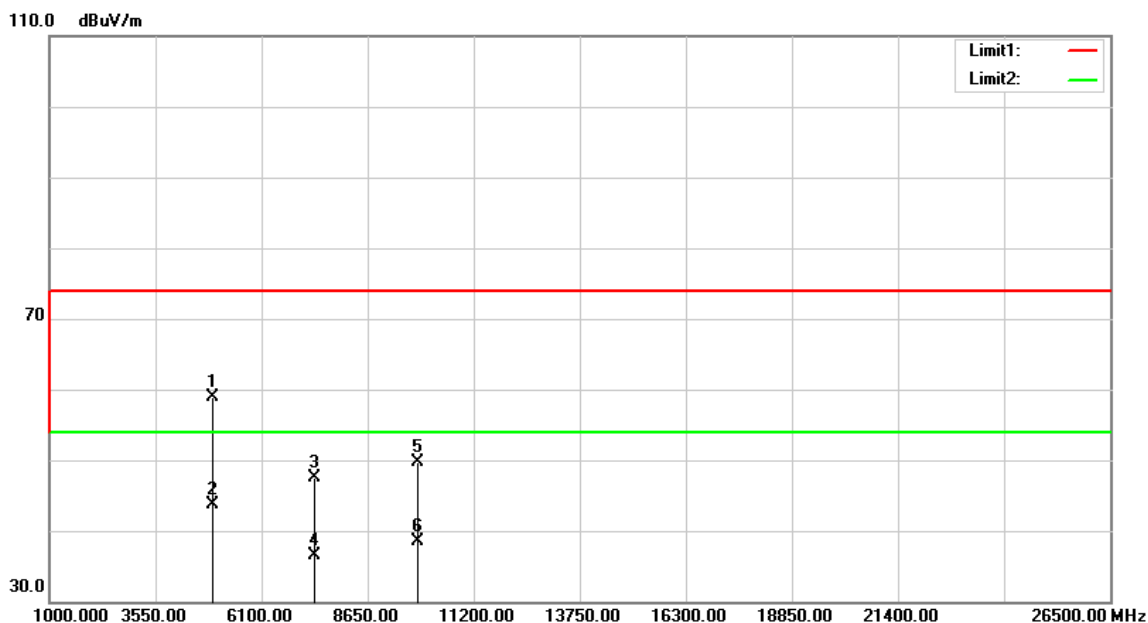

Frequency (MHz)	Reading (dBuV)	Correct Factor (dB/m)	Result (dBuV/m)	Limit (dBuV/m)	Margin (dB)	Remark
4918.000	53.48	5.35	58.83	74.00	-15.17	peak
4918.000	38.35	5.35	43.70	54.00	-10.30	AVG
7386.000	34.33	13.17	47.50	74.00	-26.50	peak
7386.000	23.31	13.17	36.48	54.00	-17.52	AVG
9848.000	32.08	17.60	49.68	74.00	-24.32	peak
9848.000	20.86	17.60	38.46	54.00	-15.54	AVG

Remark:

1. Measuring frequencies from 1 GHz to the 10th harmonic of highest fundamental frequency.
2. For above 1GHz, the EUT peak value was under average limit, therefore the Average value compliance with the average limit

Test Mode	IEEE 802.11n HT20 Low CH	Temp/Hum	27(°C)/ 53%RH
Test Item	Harmonic	Test Date	January 21, 2017
Polarize	Vertical	Test Engineer	Kevin Kuo
Detector	Peak and Average	Test Voltage	120Vac / 60Hz

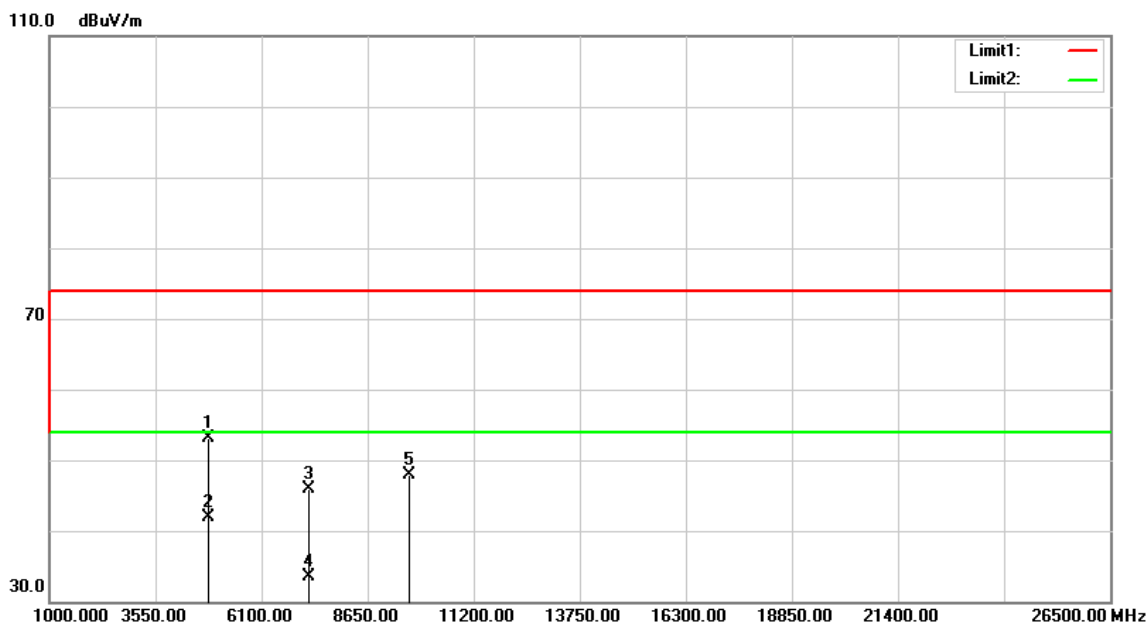

Frequency (MHz)	Reading (dBuV)	Correct Factor (dB/m)	Result (dBuV/m)	Limit (dBuV/m)	Margin (dB)	R mark
4824.000	48.08	5.10	53.18	74.00	-20.82	peak
4824.000	36.85	5.10	41.95	54.00	-12.05	AVG
7236.000	33.20	12.71	45.91	74.00	-28.09	peak
7236.000	20.83	12.71	33.54	54.00	-20.46	AVG
9648.000	30.24	17.60	47.84	74.00	-26.16	peak

Remark:

1. Measuring frequencies from 1 GHz to the 10th harmonic of highest fundamental frequency.
2. For above 1GHz, the EUT peak value was under average limit, therefore the Average value compliance with the average limit

Test Mode	IEEE 802.11n HT20 Low CH	Temp/Hum	27(°C)/ 53%RH
Test Item	Harmonic	Test Date	January 21, 2017
Polarize	Horizontal	Test Engineer	Kevin Kuo
Detector	Peak and Average	Test Voltage	120Vac / 60Hz

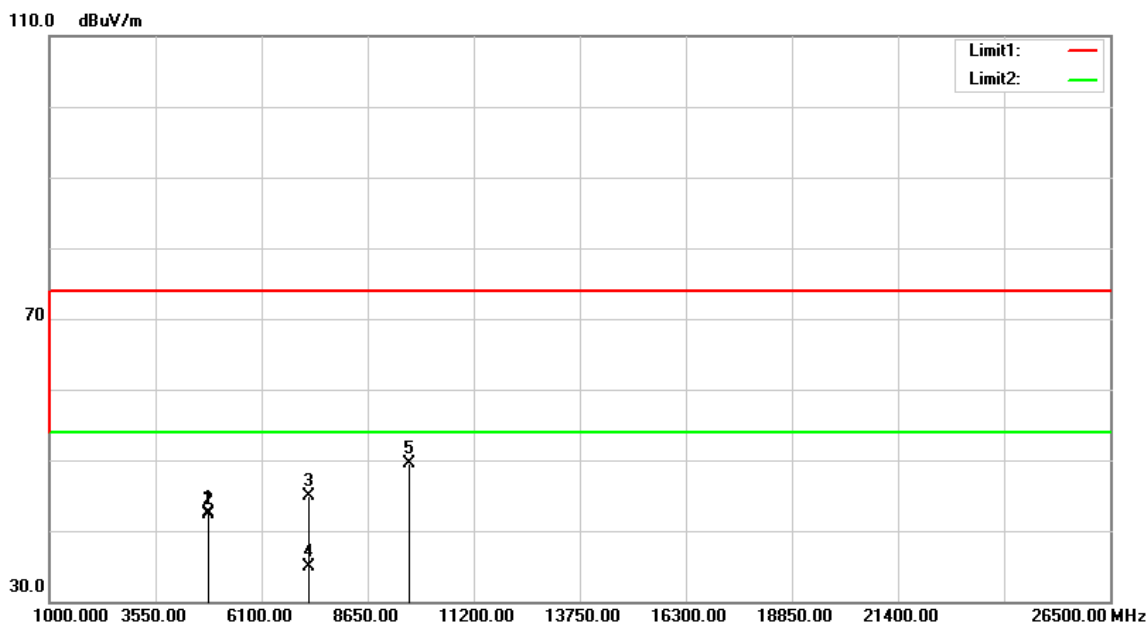

Frequency (MHz)	Reading (dBuV)	Correct Factor (dB/m)	Result (dBuV/m)	Limit (dBuV/m)	Margin (dB)	Remark
4824.000	37.47	5.10	42.57	74.00	-31.43	peak
4824.000	37.18	5.10	42.28	54.00	-11.72	AVG
7236.000	32.24	12.71	44.95	74.00	-29.05	peak
7236.000	22.14	12.71	34.85	54.00	-19.15	AVG
9648.000	31.97	17.60	49.57	74.00	-24.43	peak

Remark:

1. Measuring frequencies from 1 GHz to the 10th harmonic of highest fundamental frequency.
2. For above 1GHz, the EUT peak value was under average limit, therefore the Average value compliance with the average limit

Test Mode	IEEE 802.11n HT20 Mid CH	Temp/Hum	27(°C)/ 53%RH
Test Item	Harmonic	Test Date	January 21, 2017
Polarize	Vertical	Test Engineer	Kevin Kuo
Detector	Peak and Average	Test Voltage	120Vac / 60Hz

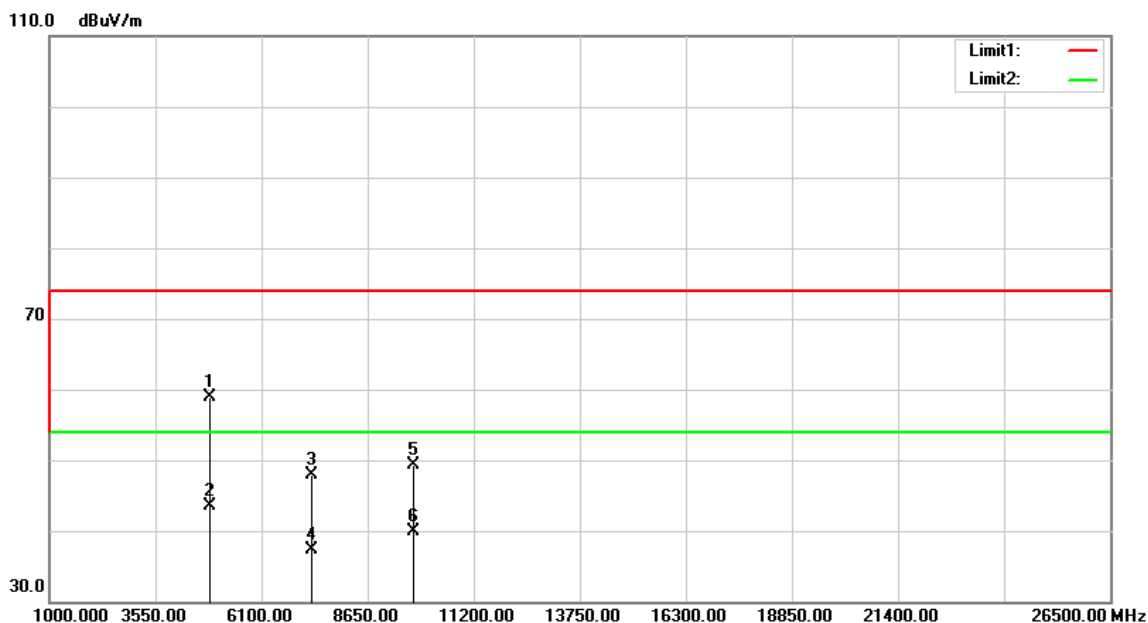

Frequency (MHz)	Reading (dBuV)	Correct Factor (dB/m)	Result (dBuV/m)	Limit (dBuV/m)	Margin (dB)	R mark
4869.000	53.65	5.22	58.87	74.00	-15.13	peak
4869.000	38.31	5.22	43.53	54.00	-10.47	AVG
7311.000	34.91	12.94	47.85	74.00	-26.15	peak
7311.000	24.44	12.94	37.38	54.00	-16.62	AVG
9748.000	31.67	17.60	49.27	74.00	-24.73	peak
9748.000	22.38	17.60	39.98	54.00	-14.02	AVG

Remark:

1. Measuring frequencies from 1 GHz to the 10th harmonic of highest fundamental frequency.
2. For above 1GHz, the EUT peak value was under average limit, therefore the Average value compliance with the average limit

Test Mode	IEEE 802.11n HT20 Mid CH	Temp/Hum	27(°C)/ 53%RH
Test Item	Harmonic	Test Date	January 21, 2017
Polarize	Horizontal	Test Engineer	Kevin Kuo
Detector	Peak and Average	Test Voltage	120Vac / 60Hz

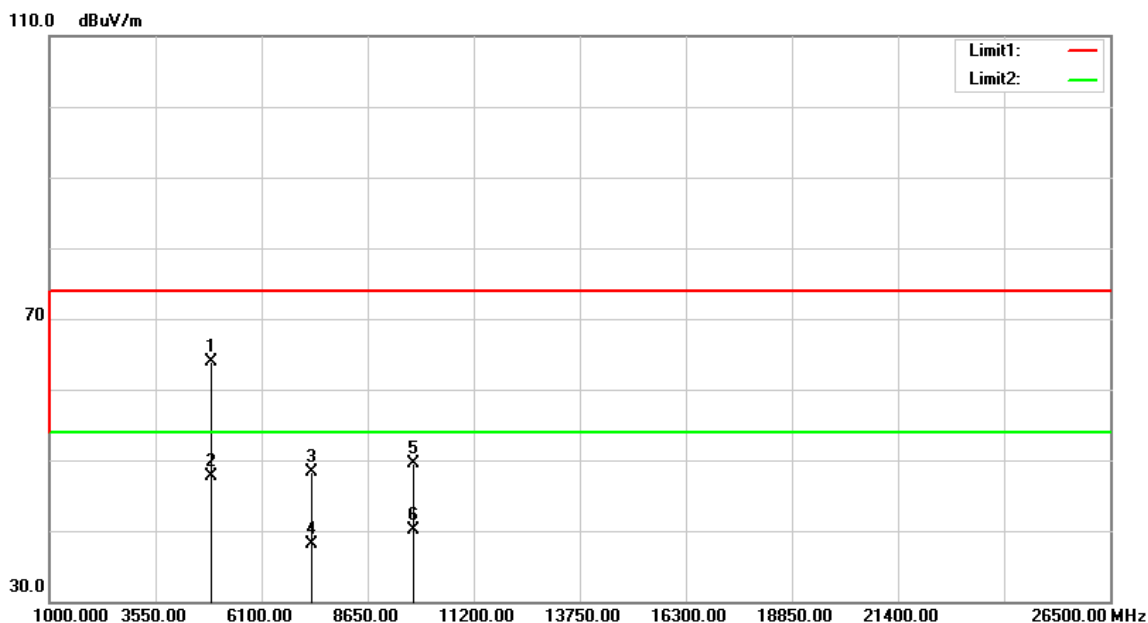

Frequency (MHz)	Reading (dBuV)	Correct Factor (dB/m)	Result (dBuV/m)	Limit (dBuV/m)	Margin (dB)	Remark
4883.000	58.66	5.26	63.92	74.00	-10.08	peak
4883.000	42.48	5.26	47.74	54.00	-6.26	AVG
7311.000	35.43	12.94	48.37	74.00	-25.63	peak
7311.000	25.16	12.94	38.10	54.00	-15.90	AVG
9748.000	31.90	17.60	49.50	74.00	-24.50	peak
9748.000	22.53	17.60	40.13	54.00	-13.87	AVG

Remark:

1. Measuring frequencies from 1 GHz to the 10th harmonic of highest fundamental frequency.
2. For above 1GHz, the EUT peak value was under average limit, therefore the Average value compliance with the average limit

Test Mode	IEEE 802.11n HT20 High CH	Temp/Hum	27(°C)/ 53%RH
Test Item	Harmonic	Test Date	January 21, 2017
Polarize	Vertical	Test Engineer	Kevin Kuo
Detector	Peak and Average	Test Voltage	120Vac / 60Hz

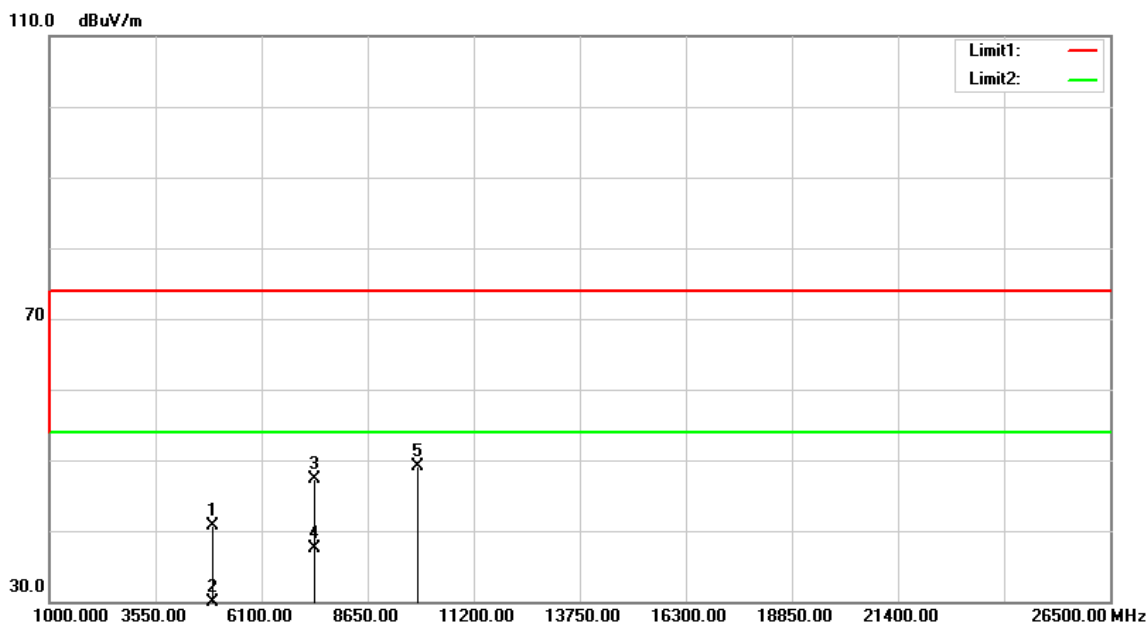

Frequency (MHz)	Reading (dBuV)	Correct Factor (dB/m)	Result (dBuV/m)	Limit (dBuV/m)	Margin (dB)	Remark
4924.000	35.26	5.37	40.63	74.00	-33.37	peak
4924.000	23.22	5.37	28.59	54.00	-25.41	AVG
7386.000	34.12	13.17	47.29	74.00	-26.71	peak
7386.000	24.27	13.17	37.44	54.00	-16.56	AVG
9848.000	31.46	17.60	49.06	74.00	-24.94	peak

Remark:

1. Measuring frequencies from 1 GHz to the 10th harmonic of highest fundamental frequency.
2. For above 1GHz, the EUT peak value was under average limit, therefore the Average value compliance with the average limit

Test Mode	IEEE 802.11n HT20 High CH	Temp/Hum	27(°C)/ 53%RH
Test Item	Harmonic	Test Date	January 21, 2017
Polarize	Horizontal	Test Engineer	Kevin Kuo
Detector	Peak and Average	Test Voltage	120Vac / 60Hz

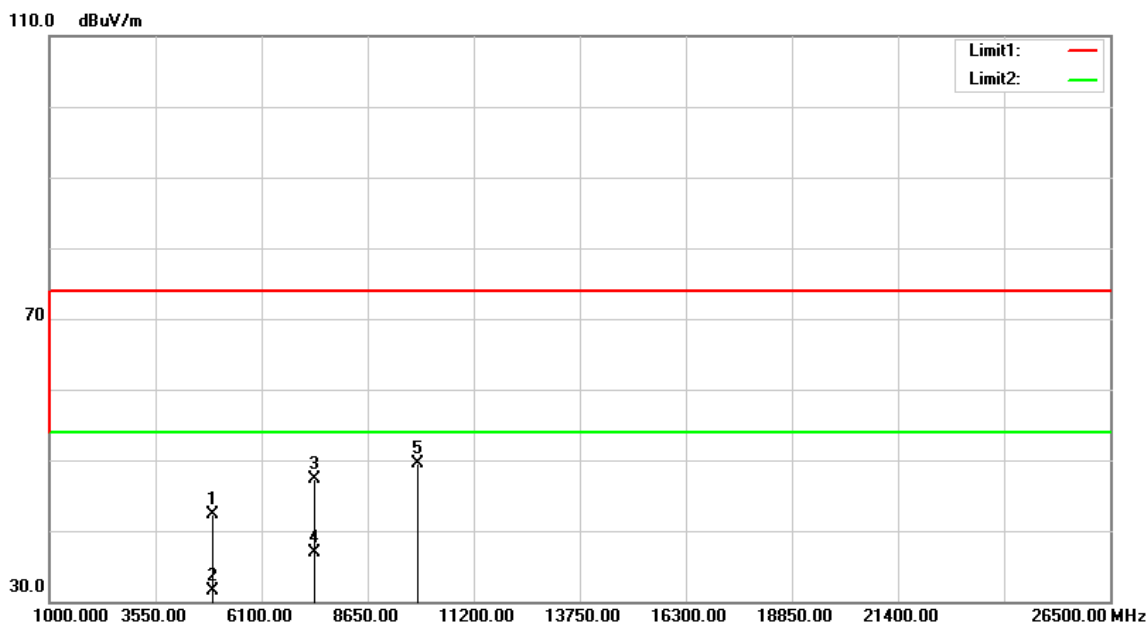

Frequency (MHz)	Reading (dBuV)	Correct Factor (dB/m)	Result (dBuV/m)	Limit (dBuV/m)	Margin (dB)	Remark
4924.000	37.00	5.37	42.37	74.00	-31.63	peak
4924.000	26.15	5.37	31.52	54.00	-22.48	AVG
7386.000	34.21	13.17	47.38	74.00	-26.62	peak
7386.000	23.67	13.17	36.84	54.00	-17.16	AVG
9848.000	31.97	17.60	49.57	74.00	-24.43	peak

Remark:

1. Measuring frequencies from 1 GHz to the 10th harmonic of highest fundamental frequency.
2. For above 1GHz, the EUT peak value was under average limit, therefore the Average value compliance with the average limit

Test Mode	IEEE 802.11n HT40 Low CH	Temp/Hum	27(°C)/ 53%RH
Test Item	Harmonic	Test Date	January 21, 2017
Polarize	Vertical	Test Engineer	Kevin Kuo
Detector	Peak and Average	Test Voltage	120Vac / 60Hz

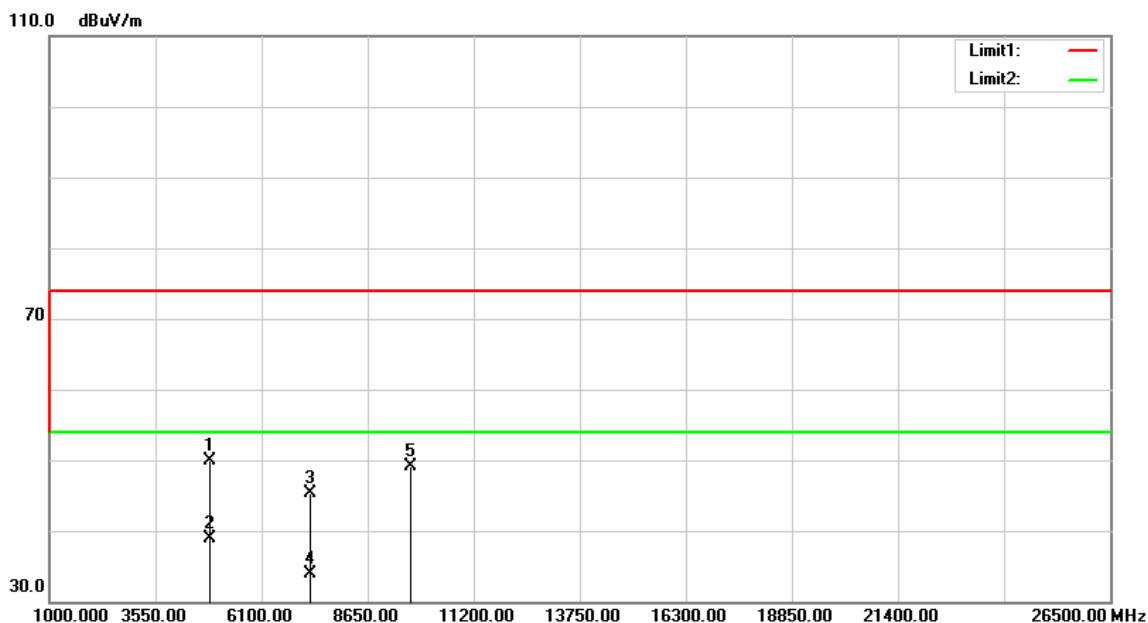

Frequency (MHz)	Reading (dBuV)	Correct Factor (dB/m)	Result (dBuV/m)	Limit (dBuV/m)	Margin (dB)	Remark
4844.000	44.70	5.15	49.85	74.00	-24.15	peak
4844.000	33.80	5.15	38.95	54.00	-15.05	AVG
7266.000	32.48	12.80	45.28	74.00	-28.72	peak
7266.000	21.04	12.80	33.84	54.00	-20.16	AVG
9688.000	31.58	17.60	49.18	74.00	-24.82	peak

Remark:

1. Measuring frequencies from 1 GHz to the 10th harmonic of highest fundamental frequency.
2. For above 1GHz, the EUT peak value was under average limit, therefore the Average value compliance with the average limit

Test Mode	IEEE 802.11n HT40 Low CH	Temp/Hum	27(°C)/ 53%RH
Test Item	Harmonic	Test Date	January 21, 2017
Polarize	Horizontal	Test Engineer	Kevin Kuo
Detector	Peak and Average	Test Voltage	120Vac / 60Hz

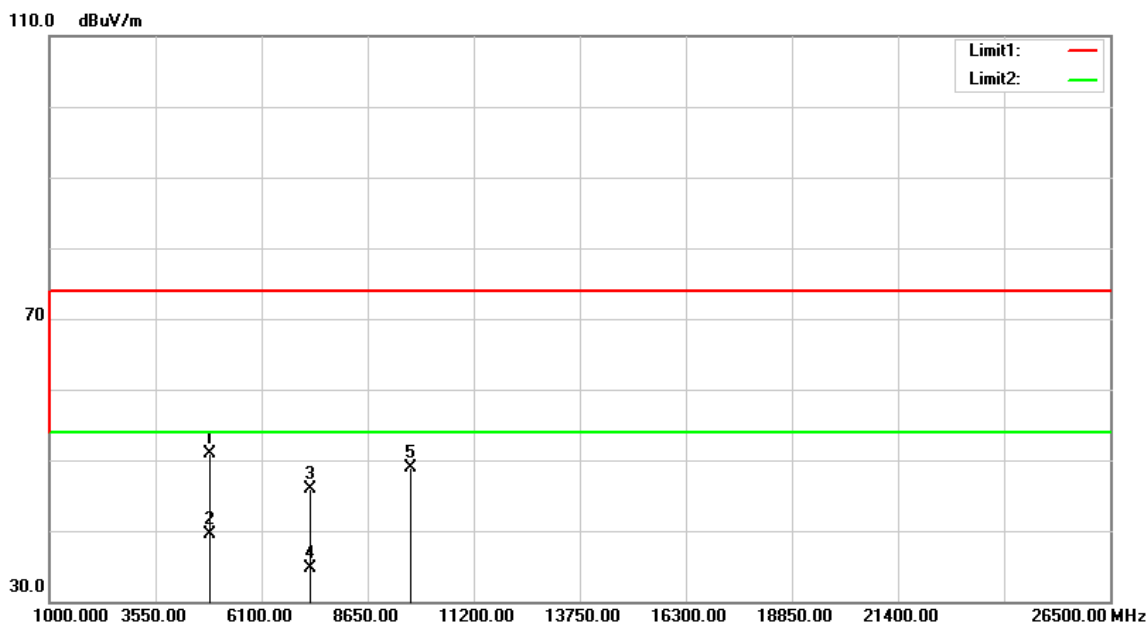

Frequency (MHz)	Reading (dBuV)	Correct Factor (dB/m)	Result (dBuV/m)	Limit (dBuV/m)	Margin (dB)	Remark
4844.000	45.83	5.15	50.98	74.00	-23.02	peak
4844.000	34.33	5.15	39.48	54.00	-14.52	AVG
7266.000	33.04	12.80	45.84	74.00	-28.16	peak
7266.000	21.91	12.80	34.71	54.00	-19.29	AVG
9688.000	31.39	17.60	48.99	74.00	-25.01	peak

Remark:

1. Measuring frequencies from 1 GHz to the 10th harmonic of highest fundamental frequency.
2. For above 1GHz, the EUT peak value was under average limit, therefore the Average value compliance with the average limit

Test Mode	IEEE 802.11n HT40 Mid CH	Temp/Hum	27(°C)/ 53%RH
Test Item	Harmonic	Test Date	January 21, 2017
Polarize	Vertical	Test Engineer	Kevin Kuo
Detector	Peak and Average	Test Voltage	120Vac / 60Hz

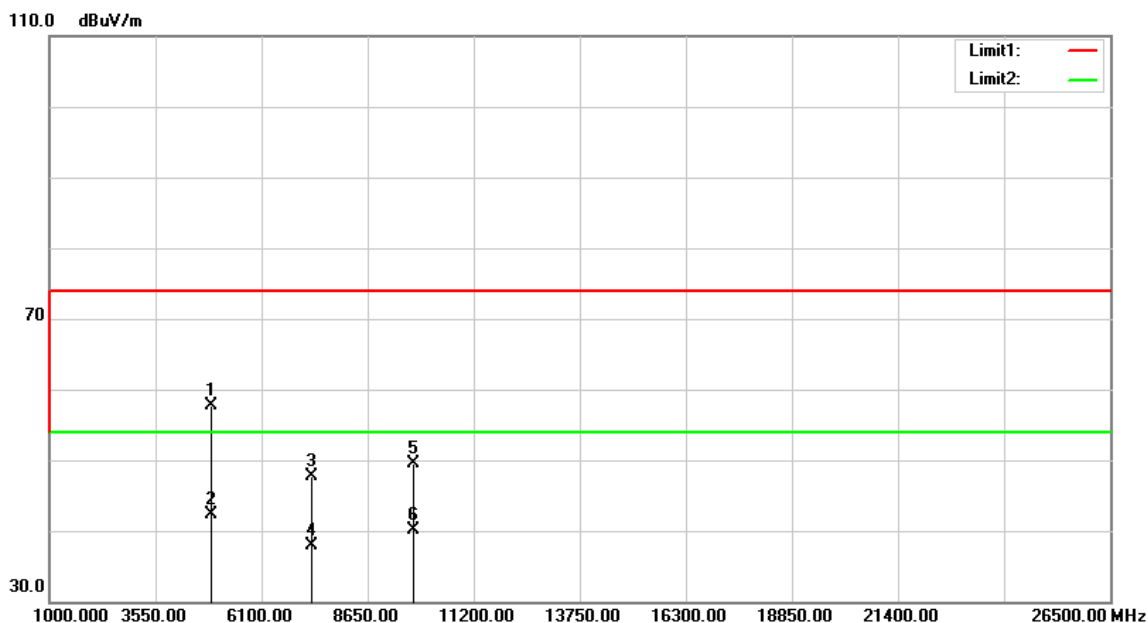

Frequency (MHz)	Reading (dBuV)	Correct Factor (dB/m)	Result (dBuV/m)	Limit (dBuV/m)	Margin (dB)	Remark
4876.000	52.39	5.24	57.63	74.00	-16.37	peak
4876.000	37.01	5.24	42.25	54.00	-11.75	AVG
7311.000	34.77	12.94	47.71	74.00	-26.29	peak
7311.000	25.02	12.94	37.96	54.00	-16.04	AVG
9748.000	31.86	17.60	49.46	74.00	-24.54	peak
9748.000	22.51	17.60	40.11	54.00	-13.89	AVG

Remark:

1. Measuring frequencies from 1 GHz to the 10th harmonic of highest fundamental frequency.
2. For above 1GHz, the EUT peak value was under average limit, therefore the Average value compliance with the average limit

Test Mode	IEEE 802.11n HT40 Mid CH	Temp/Hum	27(°C)/ 53%RH
Test Item	Harmonic	Test Date	January 21, 2017
Polarize	Horizontal	Test Engineer	Kevin Kuo
Detector	Peak and Average	Test Voltage	120Vac / 60Hz

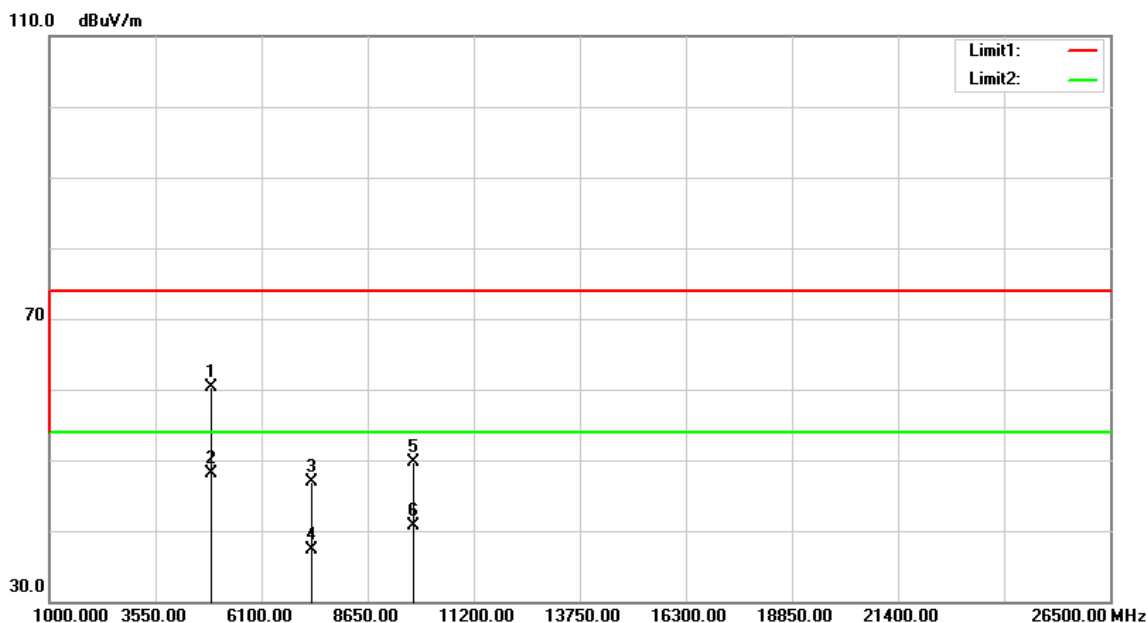

Frequency (MHz)	Reading (dBuV)	Correct Factor (dB/m)	Result (dBuV/m)	Limit (dBuV/m)	Margin (dB)	Remark
4876.000	55.13	5.24	60.37	74.00	-13.63	peak
4876.000	42.77	5.24	48.01	54.00	-5.99	AVG
7311.000	33.89	12.94	46.83	74.00	-27.17	peak
7311.000	24.27	12.94	37.21	54.00	-16.79	AVG
9748.000	32.10	17.60	49.70	74.00	-24.30	peak
9748.000	23.17	17.60	40.77	54.00	-13.23	AVG

Remark:

1. Measuring frequencies from 1 GHz to the 10th harmonic of highest fundamental frequency.
2. For above 1GHz, the EUT peak value was under average limit, therefore the Average value compliance with the average limit

Test Mode	IEEE 802.11n HT40 High CH	Temp/Hum	27(°C)/ 53%RH
Test Item	Harmonic	Test Date	January 21, 2017
Polarize	Vertical	Test Engineer	Kevin Kuo
Detector	Peak and Average	Test Voltage	120Vac / 60Hz

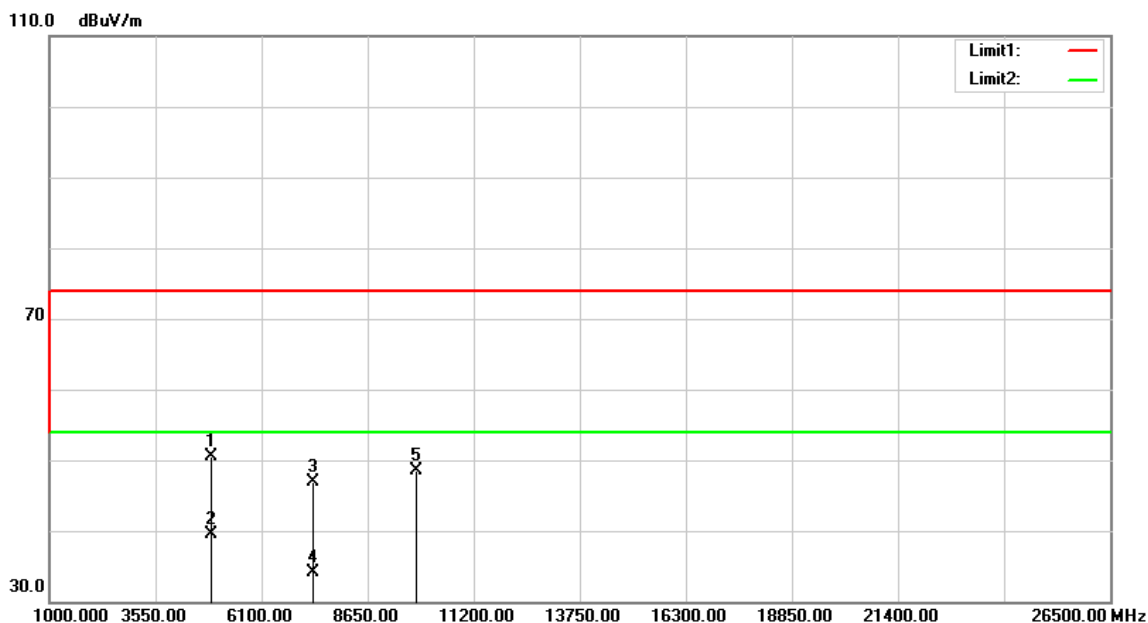

Frequency (MHz)	Reading (dBuV)	Correct Factor (dB/m)	Result (dBuV/m)	Limit (dBuV/m)	Margin (dB)	Remark
4904.000	45.27	5.31	50.58	74.00	-23.42	peak
4904.000	34.17	5.31	39.48	54.00	-14.52	AVG
7356.000	33.84	13.08	46.92	74.00	-27.08	peak
7356.000	21.03	13.08	34.11	54.00	-19.89	AVG
9808.000	30.99	17.60	48.59	74.00	-25.41	peak

Remark:

1. Measuring frequencies from 1 GHz to the 10th harmonic of highest fundamental frequency.
2. For above 1GHz, the EUT peak value was under average limit, therefore the Average value compliance with the average limit

Test Mode	IEEE 802.11n HT40 High CH	Temp/Hum	27(°C)/ 53%RH
Test Item	Harmonic	Test Date	January 21, 2017
Polarize	Horizontal	Test Engineer	Kevin Kuo
Detector	Peak and Average	Test Voltage	120Vac / 60Hz

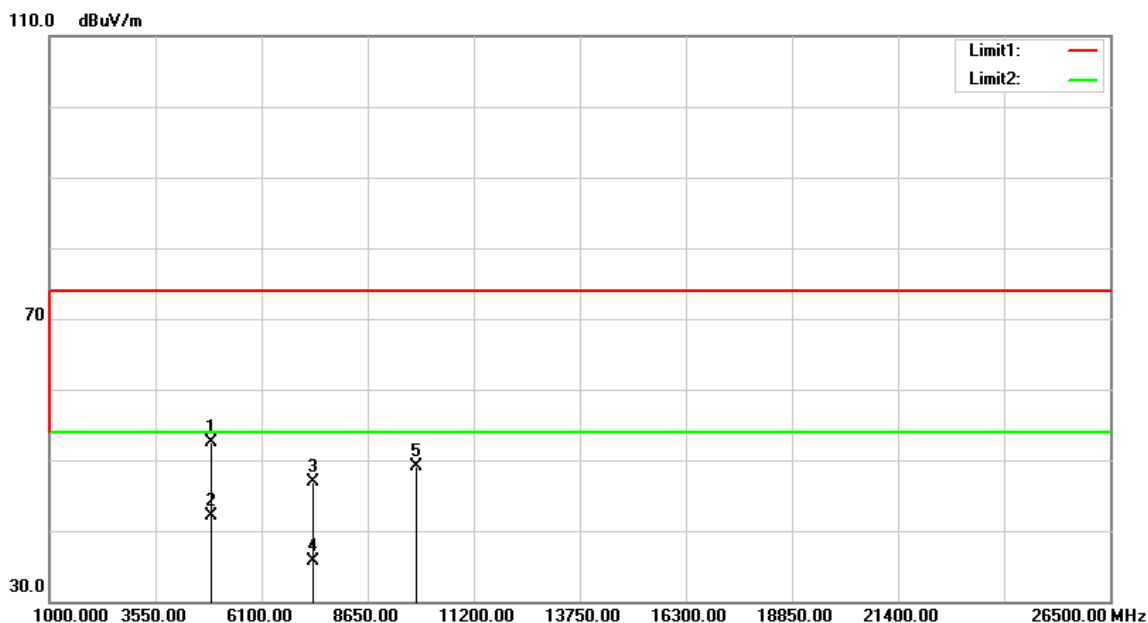

Frequency (MHz)	Reading (dBuV)	Correct Factor (dB/m)	Result (dBuV/m)	Limit (dBuV/m)	Margin (dB)	Remark
4904.000	47.17	5.31	52.48	74.00	-21.52	peak
4904.000	36.82	5.31	42.13	54.00	-11.87	AVG
7356.000	33.81	13.08	46.89	74.00	-27.11	peak
7356.000	22.69	13.08	35.77	54.00	-18.23	AVG
9808.000	31.58	17.60	49.18	74.00	-24.82	peak
4904.000	47.17	5.31	52.48	74.00	-21.52	peak

Remark:

1. Measuring frequencies from 1 GHz to the 10th harmonic of highest fundamental frequency.
2. For above 1GHz, the EUT peak value was under average limit, therefore the Average value compliance with the average limit