



FCC 47 CFR PART 15 SUBPART C

TEST REPORT

For

802.11a/b/g/n/ac, 2T2R Wireless LAN USB2.0 Module

Model: WN4505L

Trade Name: LITE-ON

Issued to

**Lite-On Technology Corp.
4F, 90, Chien 1 Road, Chung Ho,
New Taipei City 23585, Taiwan, R.O.C.**

Issued by

**Compliance Certification Services Inc.
No.11, Wugong 6th Rd., Wugu Dist.,
New Taipei City 24891, Taiwan. (R.O.C.)
<http://www.ccsrf.com>
service@ccsrf.com
Issued Date: July 17, 2014**



Note: This report shall not be reproduced except in full, without the written approval of Compliance Certification Services Inc. This document may be altered or revised by Compliance Certification Services Inc. personnel only, and shall be noted in the revision section of the document.



Revision History

Rev.	Issue Date	Revisions	Effect Page	Revised By
00	July 17, 2014	Initial Issue	ALL	Angel Cheng



TABLE OF CONTENTS

1. TEST RESULT CERTIFICATION.....	4
2. EUT DESCRIPTION	5
3. TEST METHODOLOGY	6
4.1 EUT CONFIGURATION	6
4.2 EUT EXERCISE.....	6
4.3 GENERAL TEST PROCEDURES.....	6
4.4 FCC PART 15.205 RESTRICTED BANDS OF OPERATIONS.....	7
4.5 DESCRIPTION OF TEST MODES	8
4. INSTRUMENT CALIBRATION.....	9
4.1 MEASURING INSTRUMENT CALIBRATION	9
4.2 MEASUREMENT EQUIPMENT USED	9
4.3 MEASUREMENT UNCERTAINTY	10
5 FACILITIES AND ACCREDITATIONS	11
5.1 FACILITIES	11
5.2 LABORATORY ACCREDITATIONS AND LISTING.....	11
5.3 TABLE OF ACCREDITATIONS AND LISTINGS.....	12
6 SETUP OF EQUIPMENT UNDER TEST	13
6.1 SETUP CONFIGURATION OF EUT.....	13
6.2 SUPPORT EQUIPMENT	13
7 APPLICABLE RULES	14
8 FCC PART 15 REQUIREMENTS.....	14
8.1 6DB BANDWIDTH	14
8.2 PEAK POWER.....	34
8.3 AVERAGE POWER	36
8.4 BAND EDGES MEASUREMENT	38
8.5 PEAK POWER SPECTRAL DENSITY	68
8.6 SPURIOUS EMISSIONS.....	88
8.7 POWERLINE CONDUCTED EMISSIONS.....	124
APPENDIX I PHOTOGRAPHS OF TEST SETUP	127
APPENDIX 1 - PHOTOGRAPHS OF EUT	



1. TEST RESULT CERTIFICATION

Applicant: Lite-On Technology Corp.
4F, 90, Chien 1 Road, Chung Ho, New Taipei City 23585,
Taiwan, R.O.C.

Manufacturer: LITE-ON TECHNOLOGY (Changzhou) CO., LTD
A9 Building, No.88 Yanghu Road, Wujin Hi-Tech Industrial
Development Zone, Changzhou City,
Jiangsu Province 213100 China

Equipment Under Test: 802.11a/b/g/n/ac, 2T2R Wireless LAN USB2.0 Module

Trade Name: LITE-ON

Model: WN4505L

Date of Test: April 22, 2014 ~ May 9, 2014

APPLICABLE STANDARDS	
STANDARD	TEST RESULT
FCC 47 CFR Part 15 Subpart C	No non-compliance noted

We hereby certify that:

Compliance Certification Services Inc. tested the above equipment in accordance with the requirements set forth in the above standards. The test results show that the equipment tested is capable of demonstrating compliance with the requirements as documented in this report.

The test results of this report relate only to the tested sample identified in this report.

Approved by

Reviewed by

Miller Lee
Section Manager
Compliance Certification Services Inc.

Angel Cheng
Section Manager
Compliance Certification Services Inc.



2. EUT DESCRIPTION

Product	802.11a/b/g/n/ac, 2T2R Wireless LAN USB2.0 Module
Trade Name	LITE-ON
Model Number	WN4505L
Model Discrepancy	N/A
Power Supply	Powered from host device
Received Date	July 9, 2014
Frequency Range	IEEE 802.11b/g/ IEEE 802.11n HT 20 MHz: 2.412~2.462 GHz IEEE 802.11n HT 40 MHz: 2.422~2.452GHz
Transmit Power	IEEE 802.11b mode: 19.90 dBm IEEE 802.11g mode: 25.50 dBm IEEE 802.11n HT 20 MHz mode: 22.60 dBm IEEE 802.11n HT 40 MHz mode: 22.60 dBm
Modulation Technique	IEEE 802.11b mode: DSSS (1, 2, 5.5 and 11 Mbps) IEEE 802.11g mode: OFDM (6, 9, 12, 18, 24, 36, 48 and 54 Mbps) IEEE 802.11n HT 20 mode: OFDM (6.5, 7.2, 13, 14.4, 14.44, 19.5, 21.7, 26, 28.89, 28.9, 39, 43.3, 43.33 52, 57.78, 57.8, 58.5, 65.0, 72.2, 78, 86.67, 104, 115.56, 117, 130, 144.44 Mbps) IEEE 802.11n HT 40 MHz mode: OFDM (13.5, 15, 27, 30, 40.5, 45, 54, 60, 81, 90, 108, 120, 121.5, 135, 150, 162, 180, 216, 240, 243, 270, 300 Mbps)
Number of Channels	IEEE 802.11b/g mode: 11 Channels IEEE 802.11n HT 20 mode: 11 Channels IEEE 802.11n HT 40 MHz mode: 7 Channels
Antenna Specification	LITE-ON / 3010000271ID Integral Antenna / Gain: 3.36 dBi

Remark:

1. The sample selected for test was engineering sample that approximated to production product and was provided by manufacturer.
2. This submittal(s) (test report) is intended for FCC ID: PPQ-WN4505L filing to comply with Section 15.207, 15.209 and 15.247 of the FCC Part 15, Subpart C Rules.



3. TEST METHODOLOGY

The tests documented in this report were performed in accordance with ANSI C63.10 and FCC CFR 47 Part 15.207, 15.209, 15.247 and KDB558074

4.1 EUT CONFIGURATION

The EUT configuration for testing is installed on RF field strength measurement to meet the Commissions requirement and operating in a manner that intends to maximize its emission characteristics in a continuous normal application.

4.2 EUT EXERCISE

The EUT was operated in the engineering mode to fix the TX frequency that was for the purpose of the measurements.

According to its specifications, the EUT must comply with the requirements of the Section 15.207, 15.209 and 15.247 under the FCC Rules Part 15 Subpart C.

4.3 GENERAL TEST PROCEDURES

Conducted Emissions

The EUT is placed on the turntable, which is 0.8 m above ground plane. According to the requirements in Section 13.1.4.1 of ANSI C63.10 Conducted emissions from the EUT measured in the frequency range between 0.15 MHz and 30MHz using CISPR Quasi-peak and average detector modes.

Radiated Emissions

The EUT is placed on a turn table, which is 0.8 m above ground plane. The turntable shall rotate 360 degrees to determine the position of maximum emission level. EUT is set 3m away from the receiving antenna, which varied from 1m to 4m to find out the highest emission. And also, each emission was to be maximized by changing the polarization of receiving antenna both horizontal and vertical. In order to find out the maximum emissions, exploratory radiated emission measurements were made according to the requirements in Section 13.1.4.1 of ANSI C63.10.



4.4 FCC PART 15.205 RESTRICTED BANDS OF OPERATIONS

- (a) Except as shown in paragraph (d) of this section, only spurious emissions are permitted in any of the frequency bands listed below:

MHz	MHz	MHz	GHz
0.090 - 0.110	16.42 - 16.423	399.9 - 410	4.5 - 5.15
¹ 0.495 - 0.505	16.69475 - 16.69525	608 - 614	5.35 - 5.46
2.1735 - 2.1905	16.80425 - 16.80475	960 - 1240	7.25 - 7.75
4.125 - 4.128	25.5 - 25.67	1300 - 1427	8.025 - 8.5
4.17725 - 4.17775	37.5 - 38.25	1435 - 1626.5	9.0 - 9.2
4.20725 - 4.20775	73 - 74.6	1645.5 - 1646.5	9.3 - 9.5
6.215 - 6.218	74.8 - 75.2	1660 - 1710	10.6 - 12.7
6.26775 - 6.26825	108 - 121.94	1718.8 - 1722.2	13.25 - 13.4
6.31175 - 6.31225	123 - 138	2200 - 2300	14.47 - 14.5
8.291 - 8.294	149.9 - 150.05	2310 - 2390	15.35 - 16.2
8.362 - 8.366	156.52475 -	2483.5 - 2500	17.7 - 21.4
8.37625 - 8.38675	156.52525	2655 - 2900	22.01 - 23.12
8.41425 - 8.41475	156.7 - 156.9	3260 - 3267	23.6 - 24.0
12.29 - 12.293	162.0125 - 167.17	3332 - 3339	31.2 - 31.8
12.51975 - 12.52025	167.72 - 173.2	3345.8 - 3358	36.43 - 36.5
12.57675 - 12.57725	240 - 285	3600 - 4400	(²)
13.36 - 13.41	322 - 335.4		

¹ Until February 1, 1999, this restricted band shall be 0.490-0.510 MHz.

² Above 38.6

- (b) Except as provided in paragraphs (d) and (e), the field strength of emissions appearing within these frequency bands shall not exceed the limits shown in Section 15.209. At frequencies equal to or less than 1000 MHz, compliance with the limits in Section 15.209 shall be demonstrated using measurement instrumentation employing a CISPR quasi-peak detector. Above 1000 MHz, compliance with the emission limits in Section 15.209 shall be demonstrated based on the average value of the measured emissions. The provisions in Section 15.35 apply to these measurements.



4.5 DESCRIPTION OF TEST MODES

The EUT (model: WN4505L) had been tested under operating condition.

Software used to control the EUT for staying in continuous transmitting and receiving mode was programmed.

After verification, all tests carried out are with the worst-case test modes as shown below except radiated spurious emission below 1GHz and power line conducted emissions below 30MHz, which worst case was in normal link mode and receiving radiated spurious emission above 1GHz, which worst case was in CH Mid mode only.

IEEE 802.11b mode:

Channel Low (2412MHz), Channel Mid (2442MHz) and Channel High (2462MHz) with 1Mbps data rate were chosen for full testing.

IEEE 802.11g mode:

Channel Low (2412MHz), Channel Mid (2442MHz) and Channel High (2462MHz) with 6Mbps data rate were chosen for full testing.

IEEE 802.11n HT 20 MHz mode:

Channel Low (2412MHz), Channel Mid (2442MHz) and Channel High (2462MHz) with 6.5Mbps data rate were chosen for full testing.

IEEE 802.11n HT 40 MHz mode:

Channel Low (2422MHz), Channel Mid (2442MHz) and Channel High (2452MHz) with 13.5Mbps data rate were chosen for full testing.



4. INSTRUMENT CALIBRATION

4.1 MEASURING INSTRUMENT CALIBRATION

The measuring equipment, which was utilized in performing the tests documented herein, has been calibrated in accordance with the manufacturer's recommendations for utilizing calibration equipment, which is traceable to recognized national standards.

4.2 MEASUREMENT EQUIPMENT USED

Equipment Used for Emissions Measurement

Remark: Each piece of equipment is scheduled for calibration once a year and Loop Antenna is scheduled for calibration once three years.

Conducted Emissions Test Site				
Name of Equipment	Manufacturer	Model	Serial Number	Calibration Due
Spectrum Analyzer	Agilent	E4446A	MY43360131	03/19/2015
Power Meter	Anritsu	ML2495A	1012009	06/03/2015
Power Sensor	Anritsu	MA2411B	0917072	06/03/2015

Wugu 966 Chamber A				
Name of Equipment	Manufacturer	Model	Serial Number	Calibration Due
Spectrum Analyzer	Agilent	E4446A	US42510268	11/05/2014
EMI Test Receiver	R&S	ESCI	100064	02/27/2015
Pre-Amplifier	Mini-Circuits	ZFL-1000LN	SF350700823	01/11/2015
Pre-Amplifier	MITEQ	AFS44-00102650-42-10P-44	1415367	11/18/2014
Bilog Antenna	Sunol Sciences	JB3	A030105	10/01/2014
Horn Antenna	EMCO	3117	00055165	02/12/2015
Horn Antenna	EMCO	3116	00026370	10/09/2014
Loop Antenna	EMCO	6502	8905/2356	06/08/2015
Turn Table	CCS	CC-T-1F	N/A	N.C.R
Antenna Tower	CCS	CC-A-1F	N/A	N.C.R
Controller	CCS	CC-C-1F	N/A	N.C.R
Site NSA	CCS	N/A	N/A	12/21/2014
Test S/W	EZ-EMC (CCS-3A1RE)			

Conducted Emission room # A				
Name of Equipment	Manufacturer	Model	Serial Number	Calibration Due
EMI Test Receiver	R&S	ESI	101203	09/12/2014
LISN	R&S	ESH3-Z5	848773/014	12/05/2014
Coaxial Cable	Commate	CFD300-NL	NA	12/05/2014
Test S/W	CCS-3A1-CE			



4.3 MEASUREMENT UNCERTAINTY

PARAMETER	UNCERTAINTY
Powerline Conducted Emission	+/- 1.2159
3M Semi Anechoic Chamber / 30M~200M	+/- 4.0138
3M Semi Anechoic Chamber / 200M~1000M	+/- 3.9483
3M Semi Anechoic Chamber / 1G~8G	+/- 2.5975
3M Semi Anechoic Chamber / 8G~18G	+/- 2.6112
3M Semi Anechoic Chamber / 18G~26G	+/- 2.7389
3M Semi Anechoic Chamber / 26G~40G	+/- 2.9683

Remark: This uncertainty represents an expanded uncertainty expressed at approximately the 95% confidence level using a coverage factor of $k=2$.



5 FACILITIES AND ACCREDITATIONS

5.1 FACILITIES

All measurement facilities used to collect the measurement data are located at

- No.199, Chunghsen Road, Hsintien City, Taipei Hsien, Taiwan, R.O.C.
Tel: 886-2-2217-0894 / Fax: 886-2-2217-1029
- No.11, Wu-Gong 6th Rd., Wugu Industrial Park, New Taipei City 248, Taiwan (R.O.C.)
Tel: 886-2-2299-9720 / Fax: 886-2-2298-4045
- No.81-1, Lane 210, Bade 2nd Rd., Lujhu Township, Taoyuan County 33841, TAIWAN, R.O.C.
Tel: 886-3-324-0332 / Fax: 886-3-324-5235

The sites are constructed in conformance with the requirements of ANSI C63.7, ANSI C63.4 and CISPR Publication 22.



All receiving equipment conforms to CISPR Publication 16-1, "Radio Interference Measuring Apparatus and Measurement Methods."

5.2 LABORATORY ACCREDITATIONS AND LISTING

The test facilities used to perform radiated and conducted emissions tests are accredited by American Association for Laboratory Accreditation Program for the specific scope accreditation under Lab Code: 0824-01 to perform Electromagnetic Interference tests according to FCC Part 15 and CISPR 22 requirements. In addition, the test facilities are listed with Industry Canada, Certification and Engineering Bureau, IC 2324G-1 for 3M Semi Anechoic Chamber A, IC 2324G-2 for 3M Semi Anechoic Chamber B.



5.3 TABLE OF ACCREDITATIONS AND LISTINGS

Country	Agency	Scope of Accreditation	Logo
USA	FCC	3M Semi Anechoic Chamber (FCC MRA: TW1039) to perform FCC Part 15 measurements	 FCC MRA: TW1039
Taiwan	TAF	LP0002, RTTE01, FCC Method-47 CFR Part 15 Subpart C, D, E, RSS-210, RSS-310 IDA TS SRD, AS/NZS 4268, AS/NZS 4771, TS 12.1 & 12.2, ETSI EN 300 440-1, ETSI EN 300 440-2, ETSI EN 300 328, ETSI EN 300 220-1, ETSI EN 300 220-2, ETSI EN 301 893, ETSI EN 301 489-1/3/7/17 FCC OET Bulletin 65 + Supplement C, EN 50360, EN 50361, EN 50371, RSS 102, EN 50383, EN 50385, EN 50392, IEC 62209, CNS 14958-1, CNS 14959 FCC Method -47 CFR Part 15 Subpart B IEC / EN 61000-3-2, IEC / EN 61000-3-3, IEC / EN 61000-4-2/3/4/5/6/8/11	
Canada	Industry Canada	3M Semi Anechoic Chamber (IC 2324G-1 / IC 2324G-2) to perform	 IC 2324G-1 IC 2324G-2

** No part of this report may be used to claim or imply product endorsement by A2LA or any agency of the US Government.*



6 SETUP OF EQUIPMENT UNDER TEST

6.1 SETUP CONFIGURATION OF EUT

See test photographs attached in Appendix II for the actual connections between EUT and support equipment.

6.2 SUPPORT EQUIPMENT

No.	Device Type	Brand	Model	Series No.	FCC ID	Data Cable	Power Cord
1	Notebook PC	IBM	7663 (T61)	L3E9812	N/A	N/A	AC I/P: Unshielded, 1.8m DC O/P: Unshielded, 1.8m with a core
2	Notebook PC	DELL	PP19L	7B3ZP1S	N/A	N/A	AC I/P: Unshielded, 1.8m DC O/P: Unshielded, 1.8m with a core

Remark:

1. All the equipment/cables were placed in the worst-case configuration to maximize the emission during the test.
2. Grounding was established in accordance with the manufacturer's requirements and conditions for the intended use.



7 APPLICABLE RULES

8 FCC PART 15 REQUIREMENTS

8.1 6DB BANDWIDTH

LIMIT

According to §15.247(a)(2) & RSS-210 §A8.2(a), systems using digital modulation techniques may operate in the 902 - 928 MHz, 2400 - 2483.5 MHz, and 5725 - 5850 MHz bands. The minimum 6dB bandwidth shall be at least 500 kHz.

Test Configuration

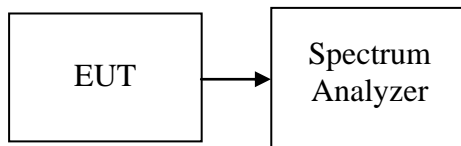

TEST PROCEDURE

1. Place the EUT on the table and set it in the transmitting mode.
2. Remove the antenna from the EUT and then connect a low loss RF cable from the antenna port to the spectrum analyzer.
3. Set the spectrum analyzer as RBW = VBW = 100kHz, Span = 50MHz, Sweep = auto.
4. Mark the peak frequency and -6dB (upper and lower) frequency.
5. Repeat until all the rest channels are investigated.

TEST RESULTS

No non-compliance noted



Test Data

Test mode: IEEE 802.11b mode

Channel	Frequency (MHz)	6dB Bandwidth (MHz)	Limit (kHz)	Result
Low	2412	10.3334	>500	PASS
Mid	2442	10.4167		PASS
High	2462	10.4167		PASS

Test mode: IEEE 802.11g mode

Channel	Frequency (MHz)	6dB Bandwidth (MHz)	Limit (kHz)	Result
Low	2412	16.6666	>500	PASS
Mid	2442	16.6666		PASS
High	2462	16.6666		PASS

Test mode: IEEE 802.11n HT 20 MHz mode / Chain 0

Channel	Frequency (MHz)	6dB Bandwidth (MHz)	Limit (kHz)	Result
Low	2412	17.8334	>500	PASS
Mid	2442	17.8334		PASS
High	2462	17.75		PASS

Test mode: IEEE 802.11n HT 20 MHz mode / Chain 1

Channel	Frequency (MHz)	6dB Bandwidth (MHz)	Limit (kHz)	Result
Low	2412	17.8334	>500	PASS
Mid	2442	17.8334		PASS
High	2462	17.9167		PASS

Test mode: IEEE 802.11n HT 40 MHz mode / Chain 0

Channel	Frequency (MHz)	6dB Bandwidth (MHz)	Limit (kHz)	Result
Low	2422	36.4167	>500	PASS
Mid	2442	36.4167		PASS
High	2452	36.4167		PASS

Test mode: IEEE 802.11n HT 40 MHz mode / Chain 1

Channel	Frequency (MHz)	6dB Bandwidth (MHz)	Limit (kHz)	Result
Low	2422	36.0833	>500	PASS
Mid	2442	36.0833		PASS
High	2452	36.1667		PASS



Test Plot

IEEE 802.11b mode

6dB Bandwidth (CH Low)

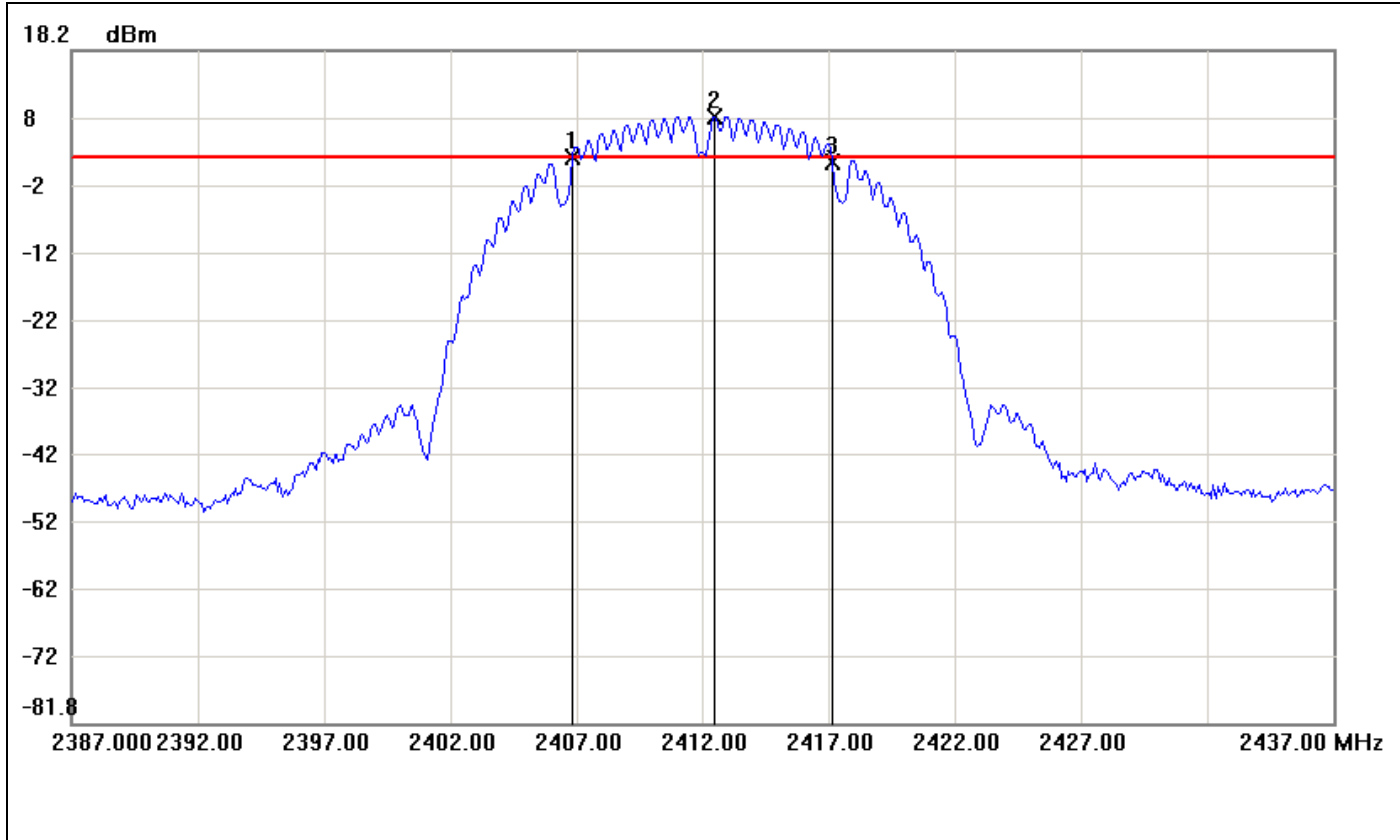

No.	Frequency(MHz)	Result(dBm)	Limit(dBm)	Margin(dBm)
1	2406.8333	2.34	2.43	-0.09
2	2412.5000	8.43	2.43	6.00
3	2417.1667	1.58	2.43	-0.85

No.		Δ Frequency(MHz)	Δ Level(dB)
1	mk3-mk1	10.3334	-0.76



6dB Bandwidth (CH Mid)

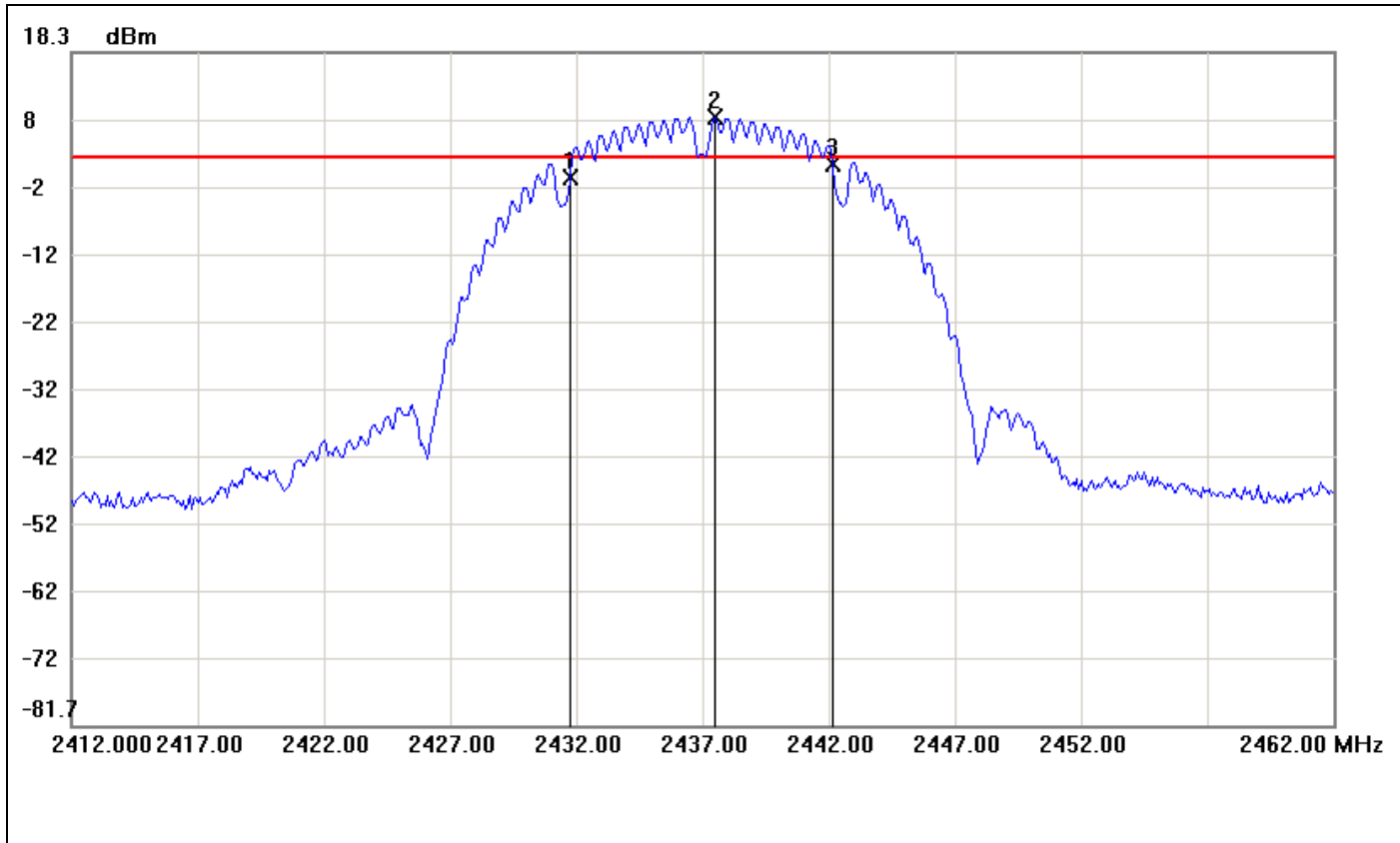

No.	Frequency(MHz)	Result(dBm)	Limit(dBm)	Margin(dBm)
1	2431.7500	-0.28	2.57	-2.85
2	2437.5000	8.57	2.57	6.00
3	2442.1667	1.58	2.57	-0.99

No.		Δ Frequency(MHz)	Δ Level(dB)
1	mk3-mk1	10.4167	1.86



6dB Bandwidth (CH High)

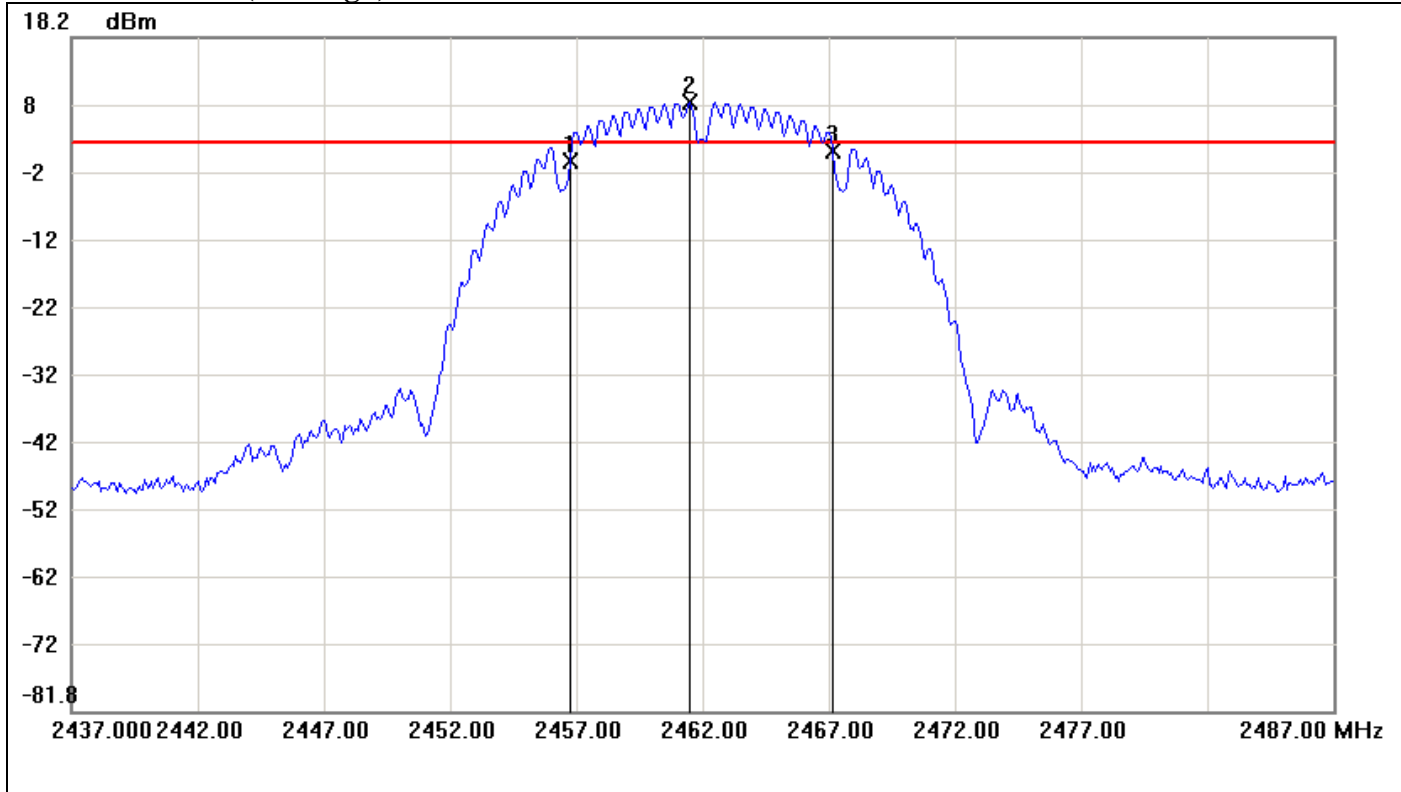

No.	Frequency(MHz)	Result(dBm)	Limit(dBm)	Margin(dBm)
1	2456.7500	-0.26	2.49	-2.75
2	2461.5000	8.49	2.49	6.00
3	2467.1667	1.38	2.49	-1.11

No.		Δ Frequency(MHz)	Δ Level(dB)
1	mk3-mk1	10.4167	1.64



IEEE 802.11g mode

6dB Bandwidth (CH Low)

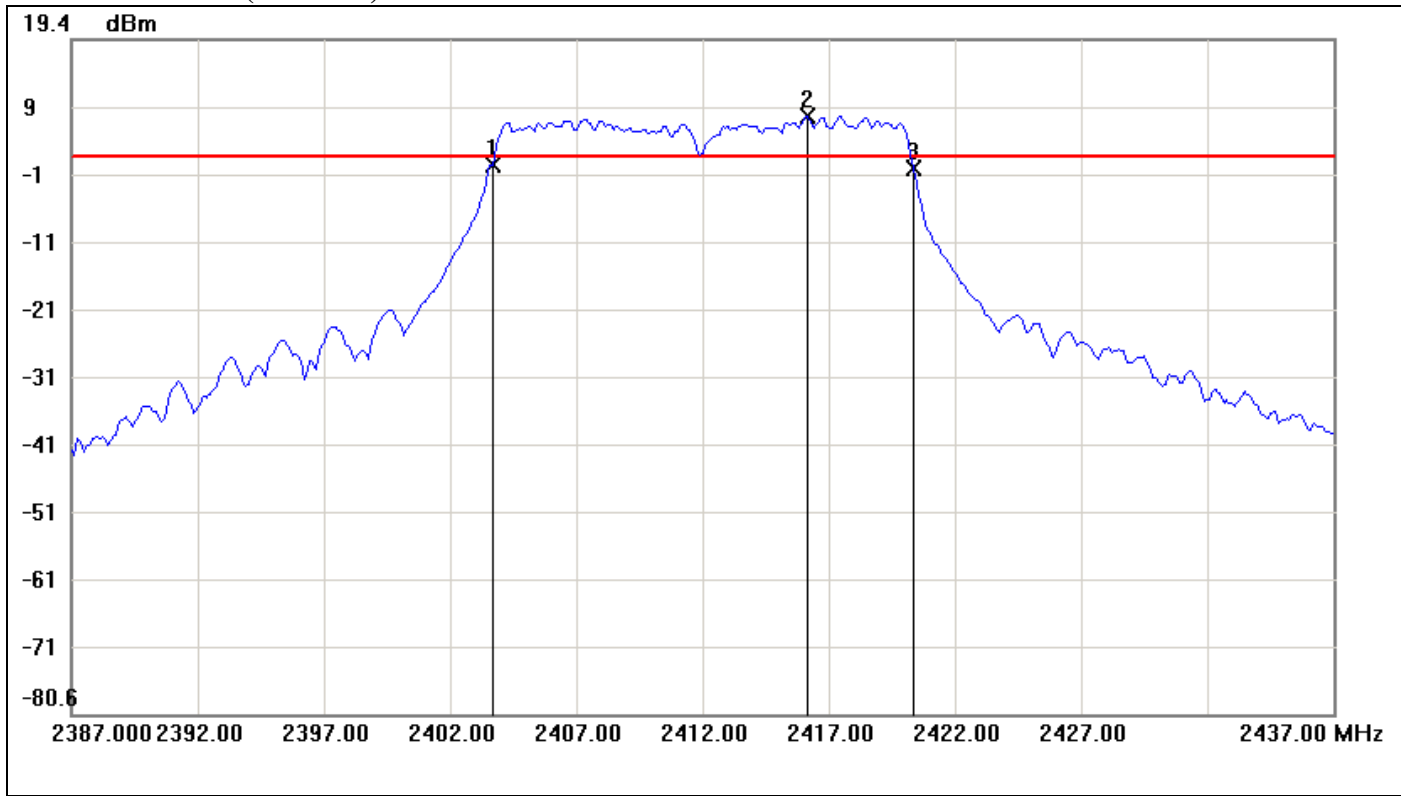

No.	Frequency(MHz)	Result(dBm)	Limit(dBm)	Margin(dBm)
1	2403.6667	0.91	2.05	-1.14
2	2416.1667	8.05	2.05	6.00
3	2420.3333	0.35	2.05	-1.70

No.		Δ Frequency(MHz)	Δ Level(dB)
1	mk3-mk1	16.6666	-0.56



6dB Bandwidth (CH Mid)

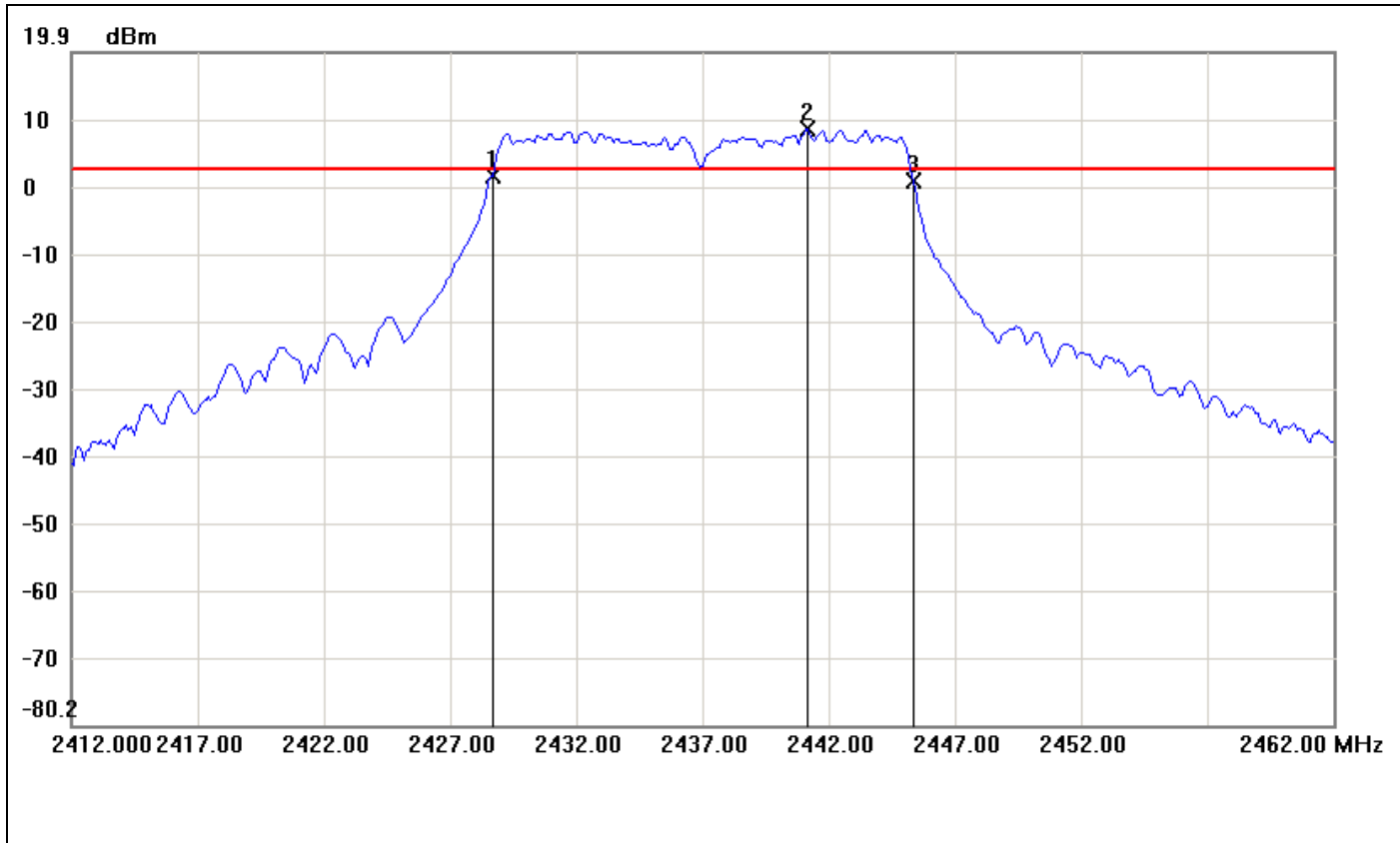

No.	Frequency(MHz)	Result(dBm)	Limit(dBm)	Margin(dBm)
1	2428.6667	1.48	2.38	-0.90
2	2441.1667	8.38	2.38	6.00
3	2445.3333	0.64	2.38	-1.74

No.		Δ Frequency(MHz)	Δ Level(dB)
1	mk3-mk1	16.6666	-0.84



6dB 6dB Bandwidth (CH High)

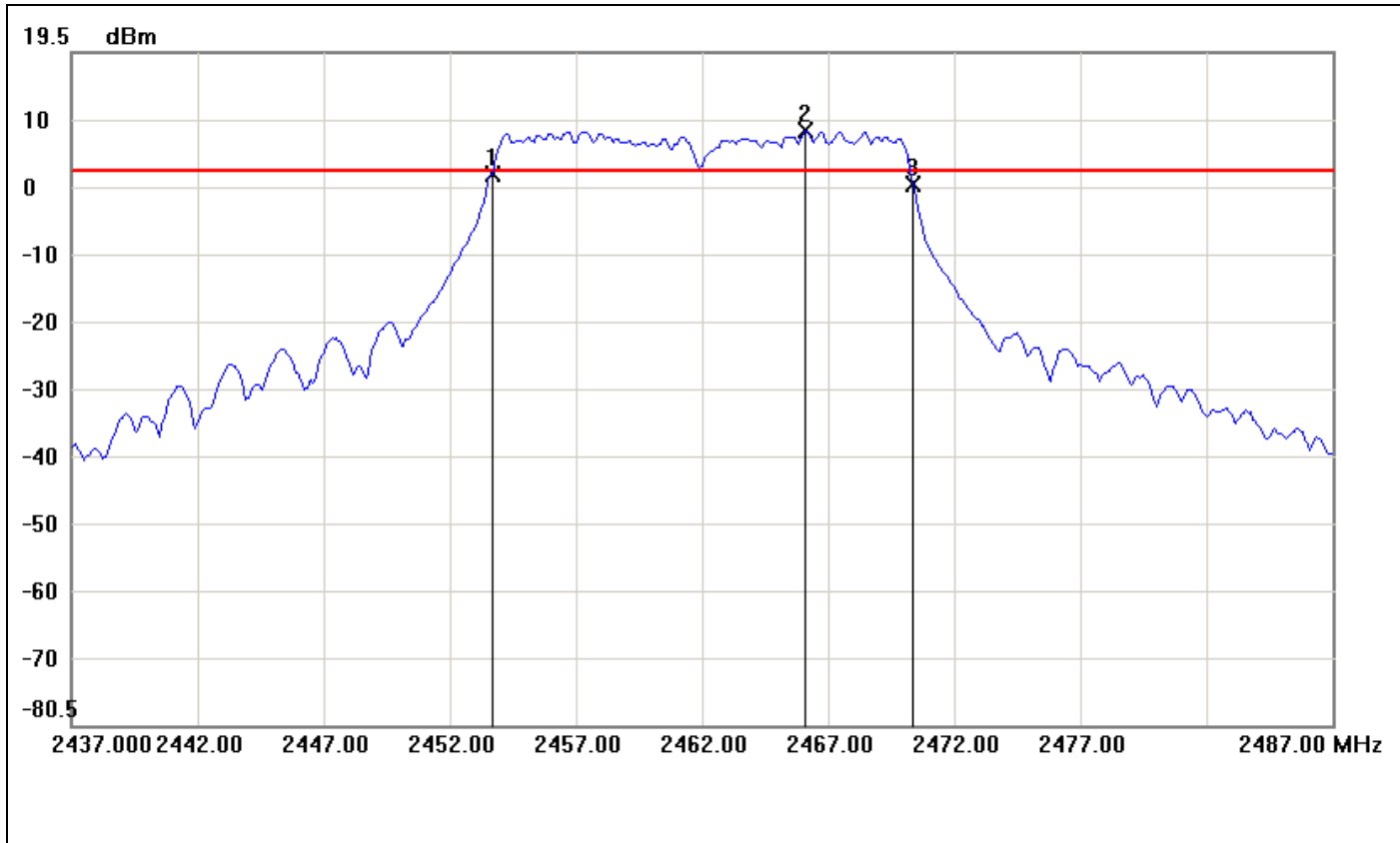

No.	Frequency(MHz)	Result(dBm)	Limit(dBm)	Margin(dBm)
1	2453.6667	1.29	1.92	-0.63
2	2466.0833	7.92	1.92	6.00
3	2470.3333	-0.10	1.92	-2.02

No.		Δ Frequency(MHz)	Δ Level(dB)
1	mk3-mk1	16.6666	-1.39



IEEE 802.11n HT 20 MHz mode / Chain 0

6dB Bandwidth (CH Low)

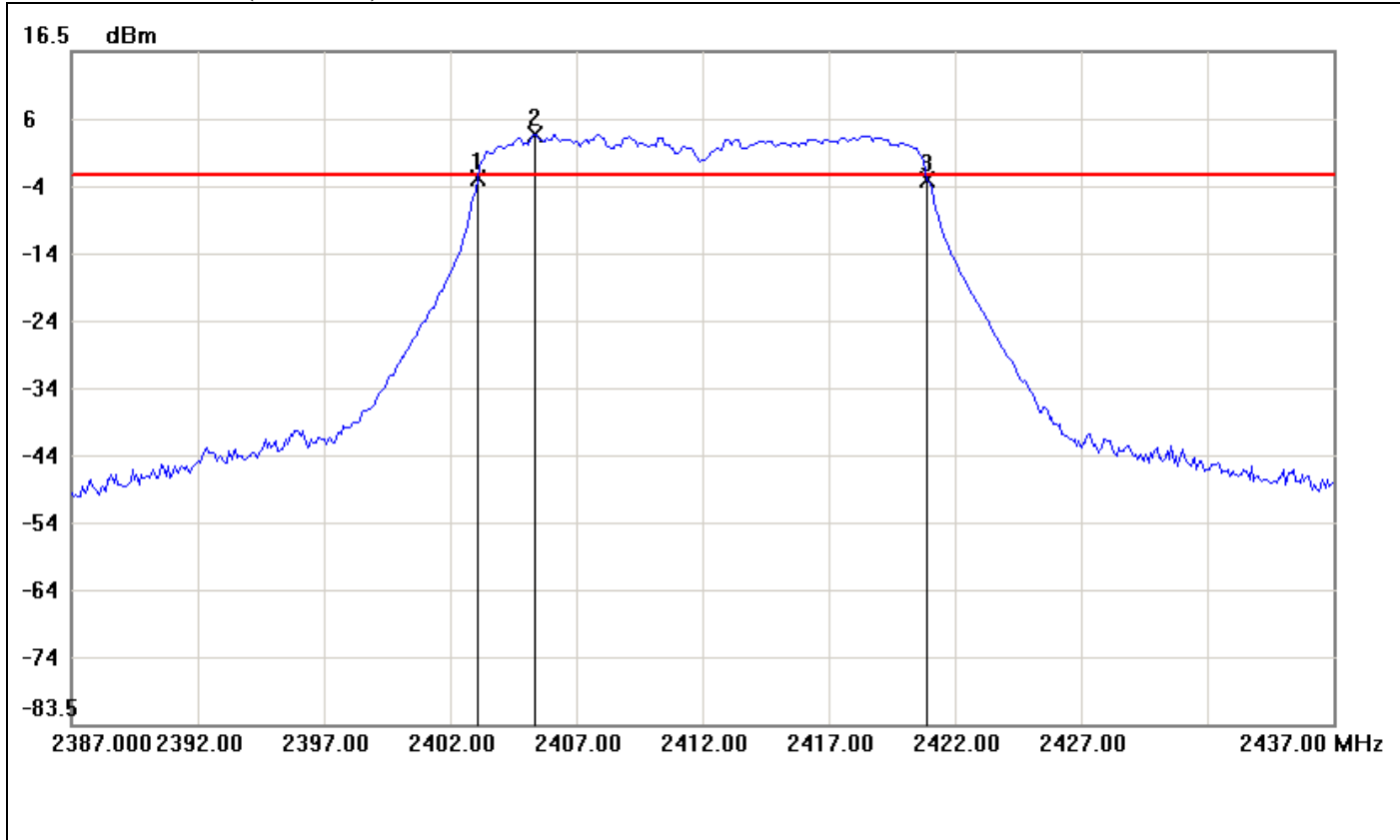

No.	Frequency(MHz)	Result(dBm)	Limit(dBm)	Margin(dBm)
1	2403.0833	-2.45	-1.81	-0.64
2	2405.3333	4.19	-1.81	6.00
3	2420.9167	-2.77	-1.81	-0.96

No.		Δ Frequency(MHz)	Δ Level(dB)
1	mk3-mk1	17.8334	-0.32



6dB Bandwidth (CH Mid)

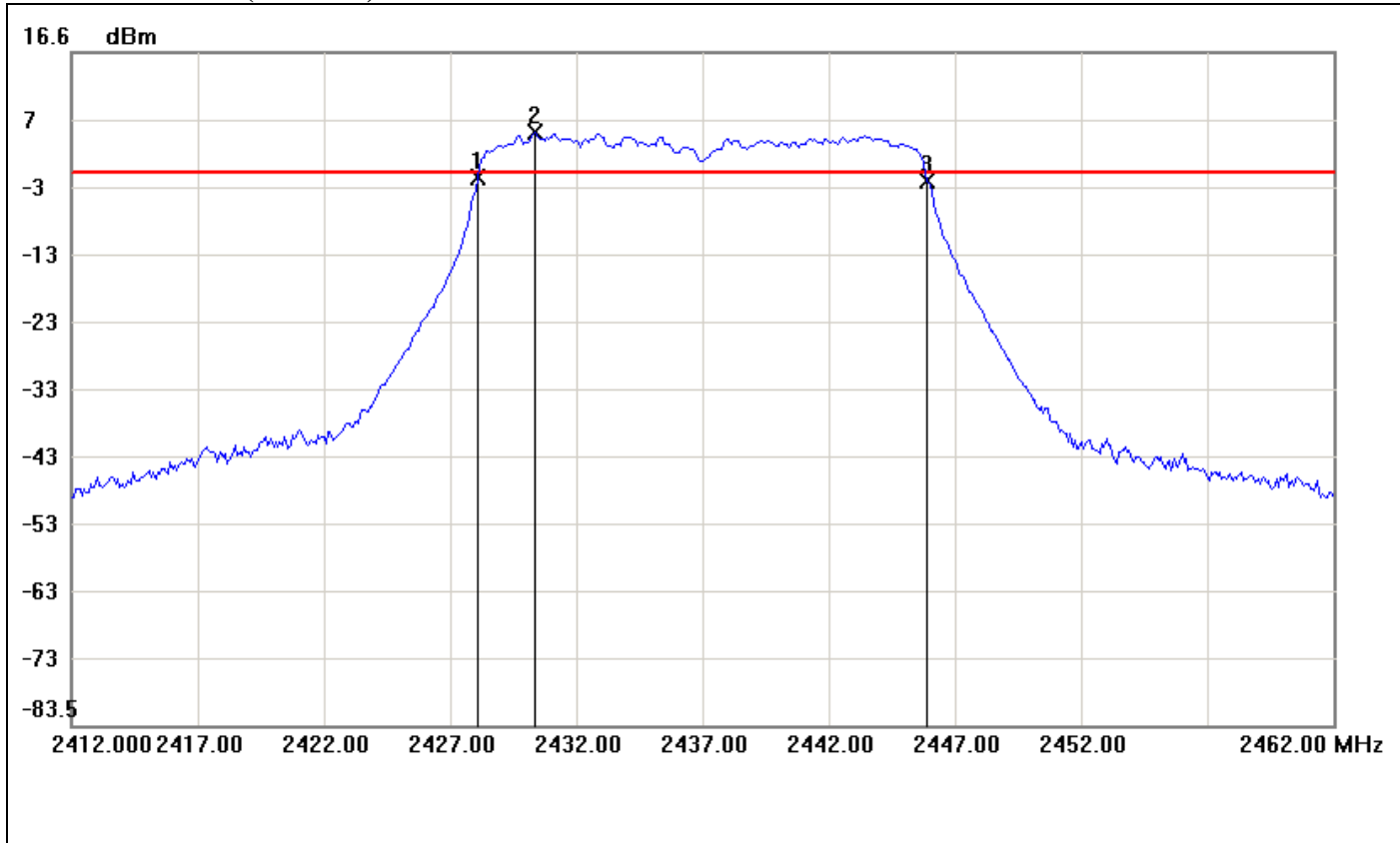

No.	Frequency(MHz)	Result(dBm)	Limit(dBm)	Margin(dBm)
1	2428.0833	-2.06	-1.42	-0.64
2	2430.3333	4.58	-1.42	6.00
3	2445.9167	-2.62	-1.42	-1.20

No.		Δ Frequency(MHz)	Δ Level(dB)
1	mk3-mk1	17.8334	-0.56



6dB Bandwidth (CH High)

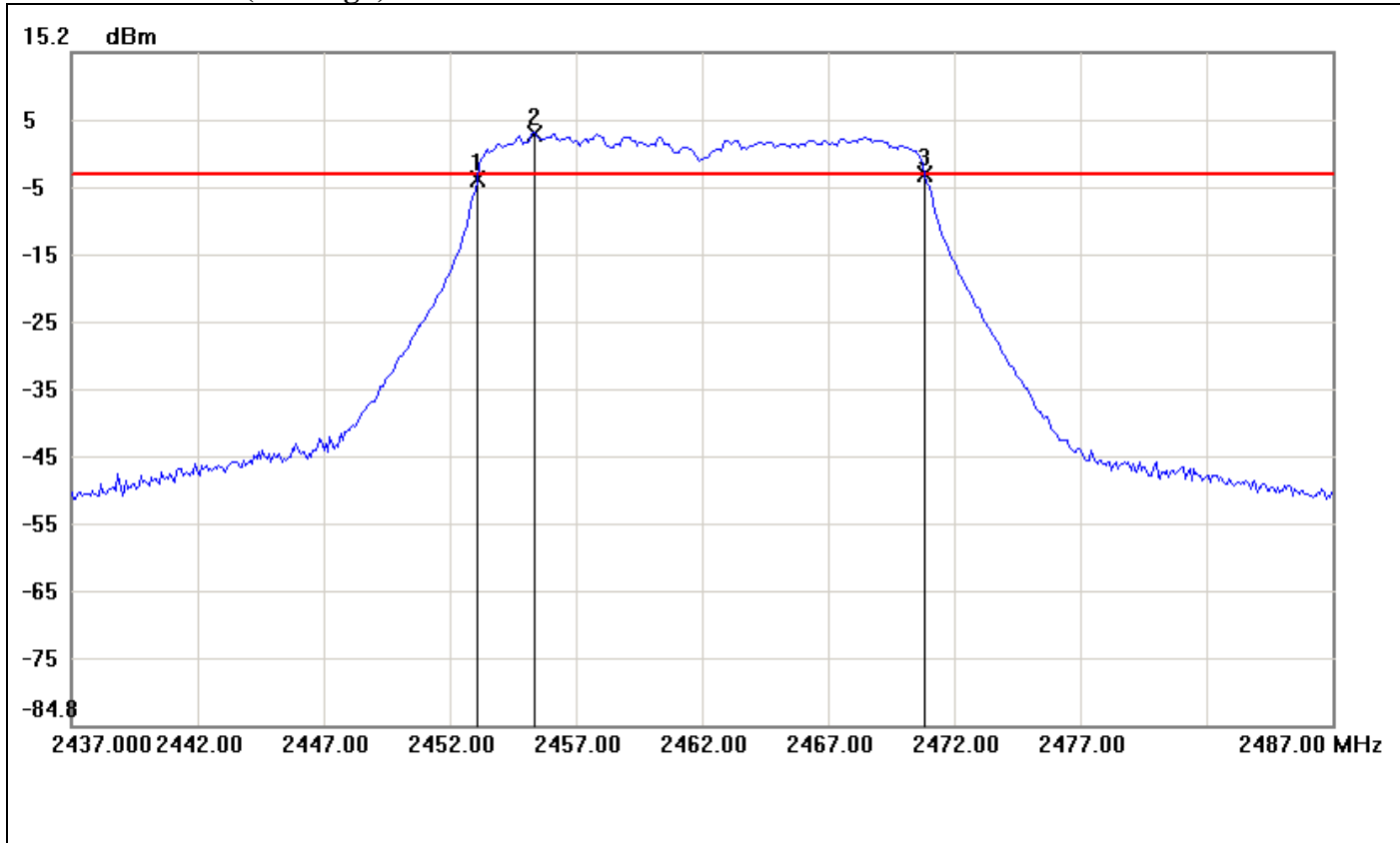

No.	Frequency(MHz)	Result(dBm)	Limit(dBm)	Margin(dBm)
1	2453.0833	-3.74	-2.81	-0.93
2	2455.3333	3.19	-2.81	6.00
3	2470.8333	-2.89	-2.81	-0.08

No.		Δ Frequency(MHz)	Δ Level(dB)
1	mk3-mk1	17.75	0.85



IEEE 802.11n HT 20 MHz mode / Chain 1

6dB Bandwidth (CH Low)

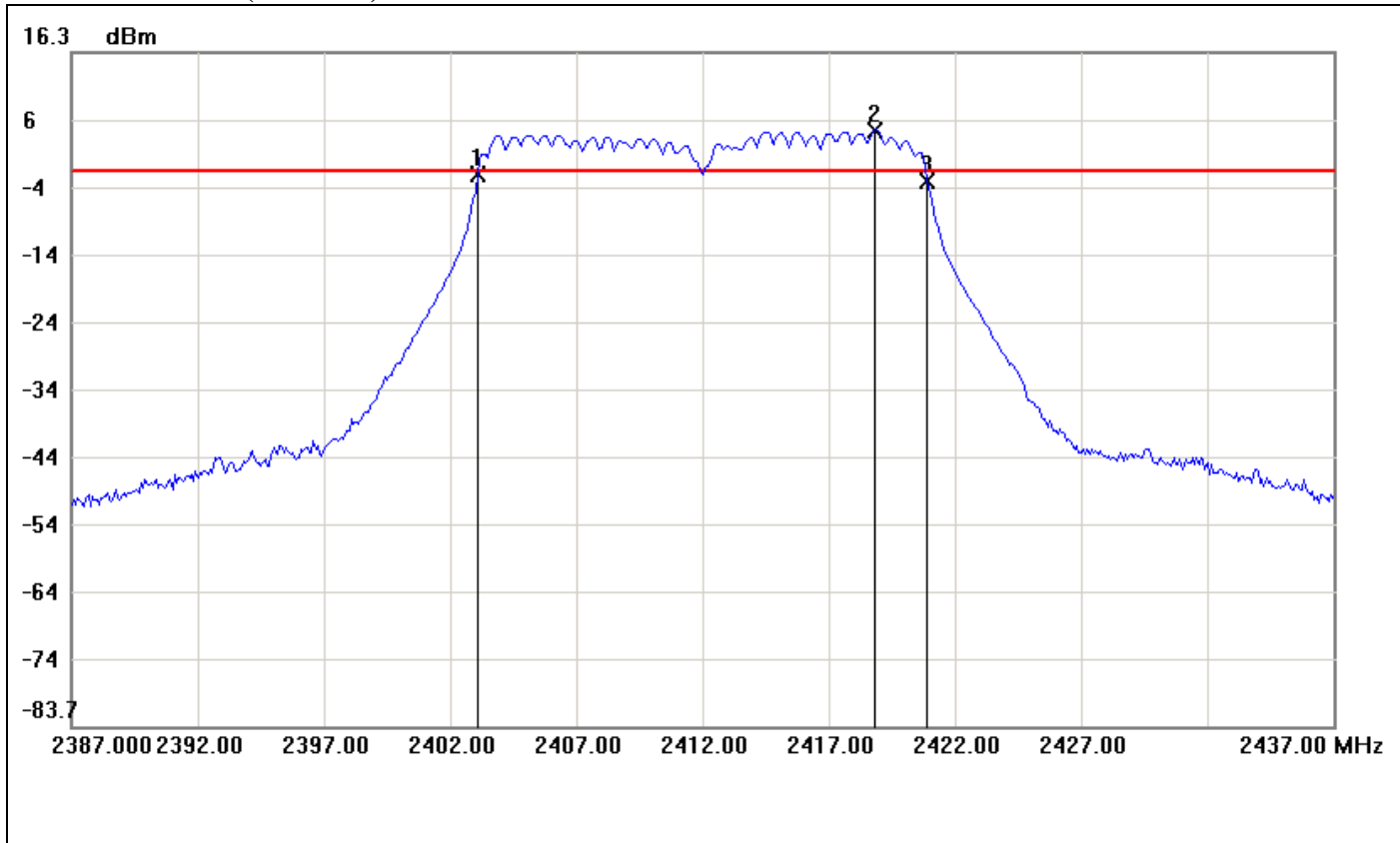

No.	Frequency(MHz)	Result(dBm)	Limit(dBm)	Margin(dBm)
1	2403.0833	-1.69	-1.19	-0.50
2	2418.8333	4.81	-1.19	6.00
3	2420.9167	-2.80	-1.19	-1.61

No.		Δ Frequency(MHz)	Δ Level(dB)
1	mk3-mk1	17.8334	-1.11



6dB Bandwidth (CH Mid)

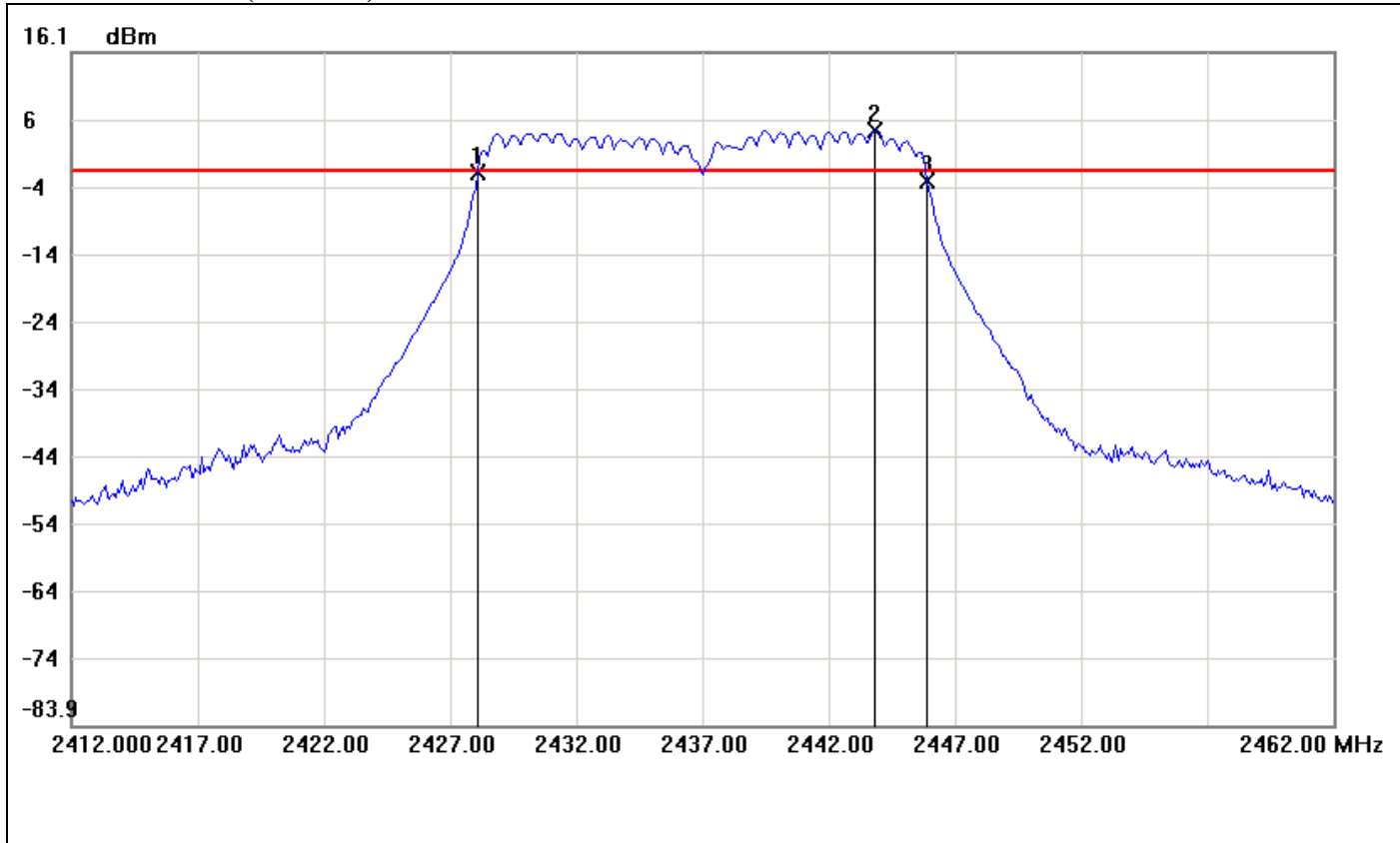

No.	Frequency(MHz)	Result(dBm)	Limit(dBm)	Margin(dBm)
1	2428.0833	-1.66	-1.44	-0.22
2	2443.8333	4.56	-1.44	6.00
3	2445.9167	-3.13	-1.44	-1.69

No.		Δ Frequency(MHz)	Δ Level(dB)
1	mk3-mk1	17.8334	-1.47



6dB Bandwidth (CH High)

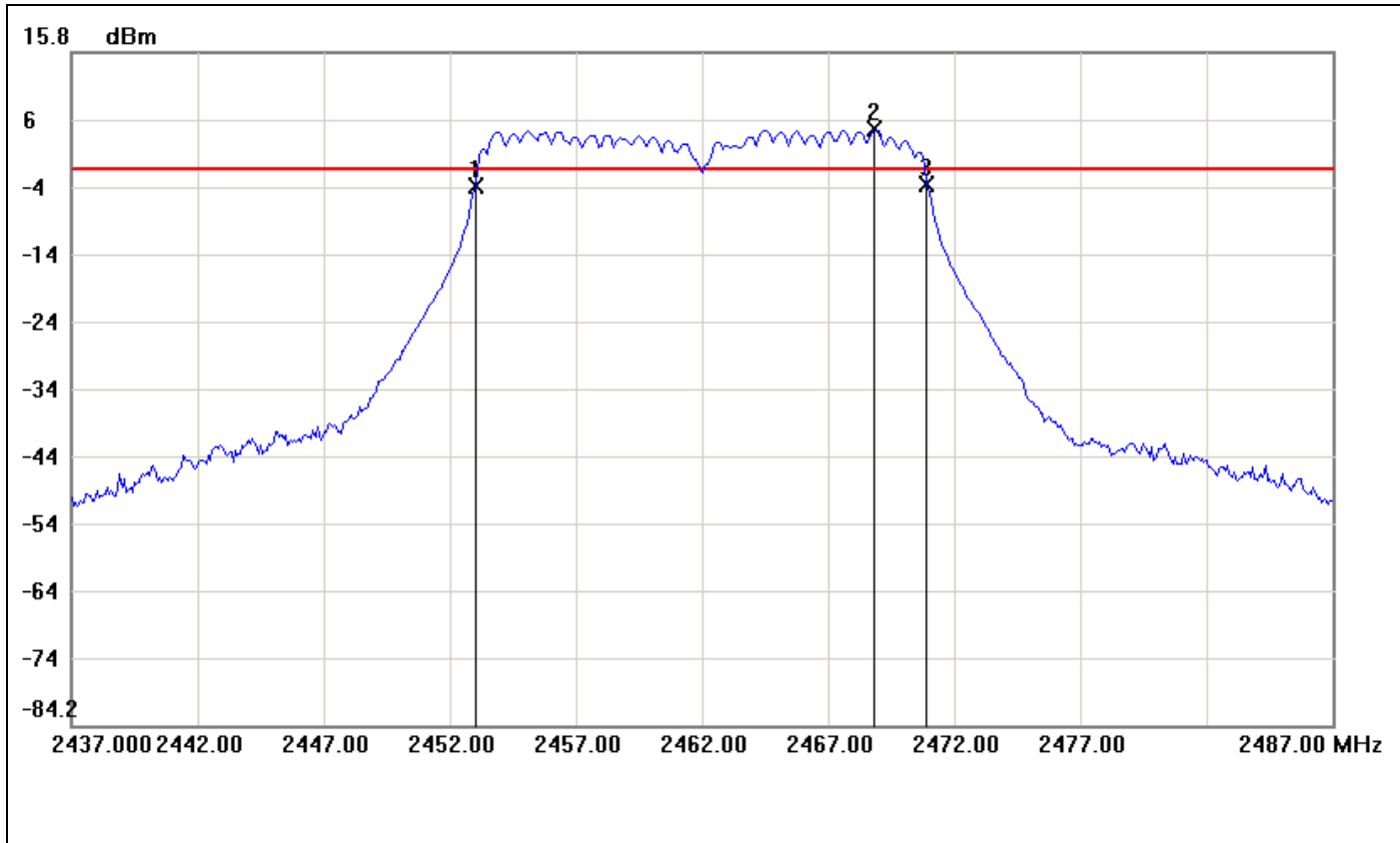

No.	Frequency(MHz)	Result(dBm)	Limit(dBm)	Margin(dBm)
1	2453.0000	-4.19	-1.70	-2.49
2	2468.8333	4.30	-1.70	6.00
3	2470.9167	-3.72	-1.70	-2.02

No.		Δ Frequency(MHz)	Δ Level(dB)
1	mk3-mk1	17.9167	0.47



IEEE 802.11n HT 40 MHz mode / Chain 0

6dB Bandwidth (CH Low)

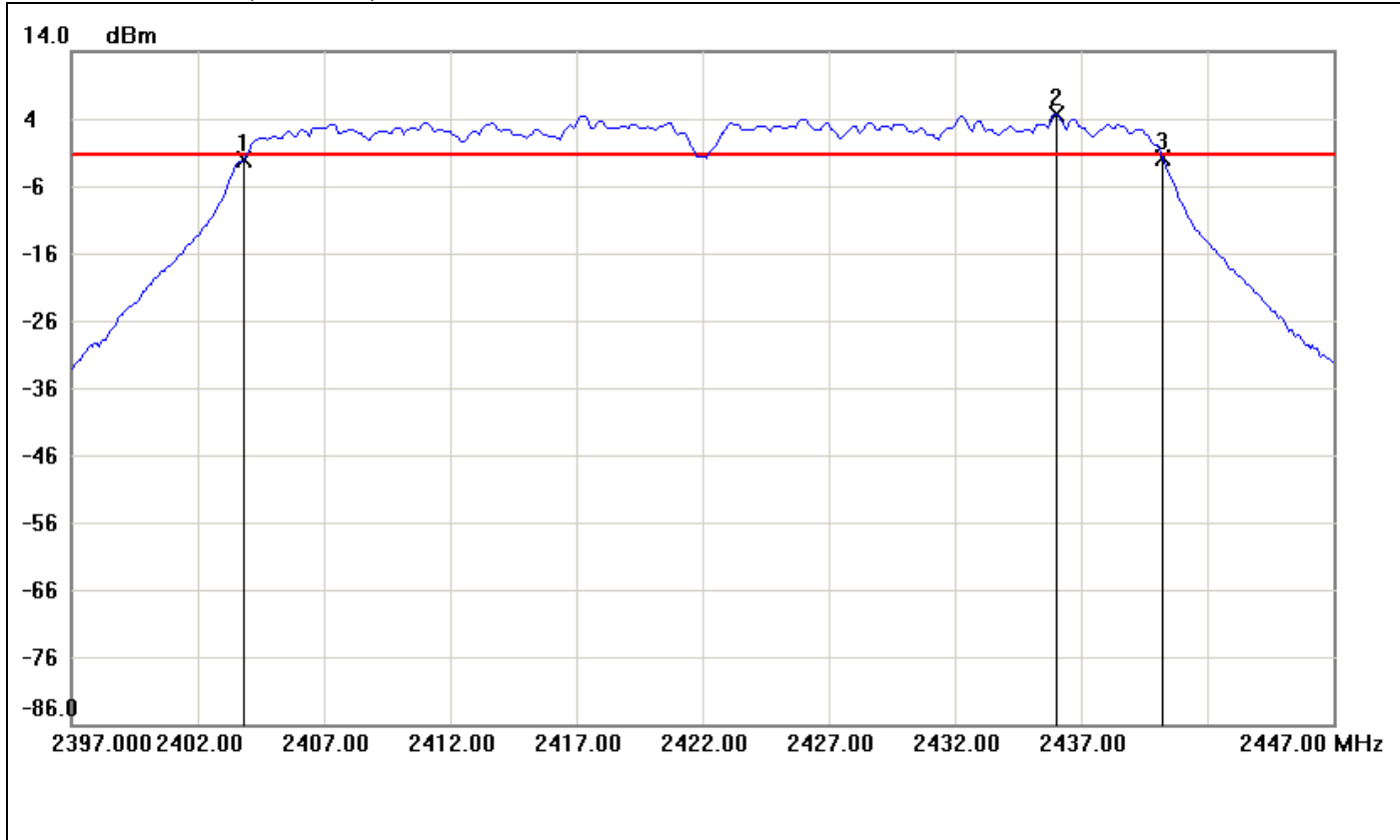

No.	Frequency(MHz)	Result(dBm)	Limit(dBm)	Margin(dBm)
1	2403.8333	-2.07	-1.49	-0.58
2	2436.0000	4.51	-1.49	6.00
3	2440.2500	-1.79	-1.49	-0.30

No.		Δ Frequency(MHz)	Δ Level(dB)
1	mk3-mk1	36.4167	0.28



6dB Bandwidth (CH Mid)

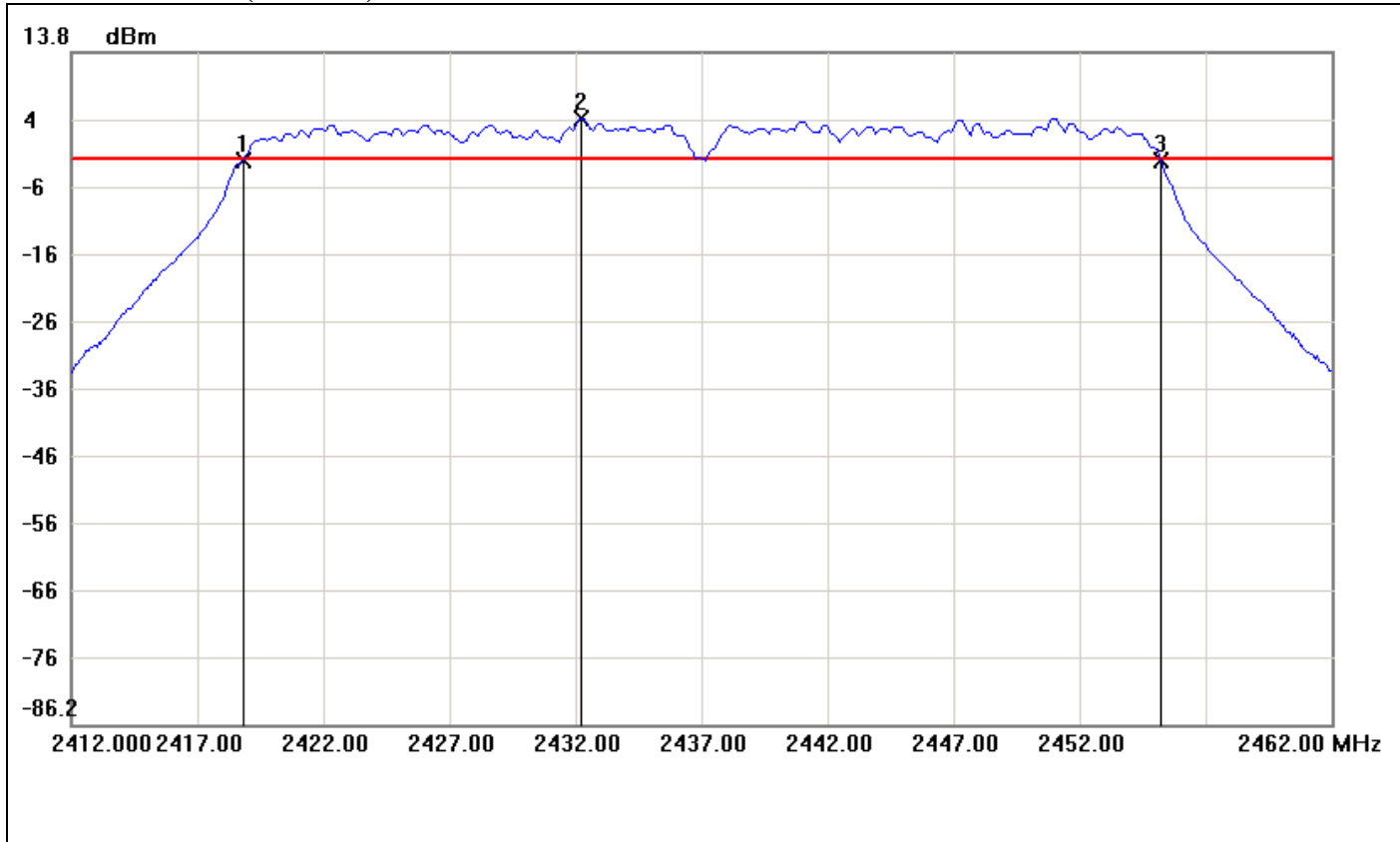

No.	Frequency(MHz)	Result(dBm)	Limit(dBm)	Margin(dBm)
1	2418.8333	-2.38	-2.05	-0.33
2	2432.2500	3.95	-2.05	6.00
3	2455.2500	-2.37	-2.05	-0.32

No.		Δ Frequency(MHz)	Δ Level(dB)
1	mk3-mk1	36.4167	0.01



6dB Bandwidth (CH High)

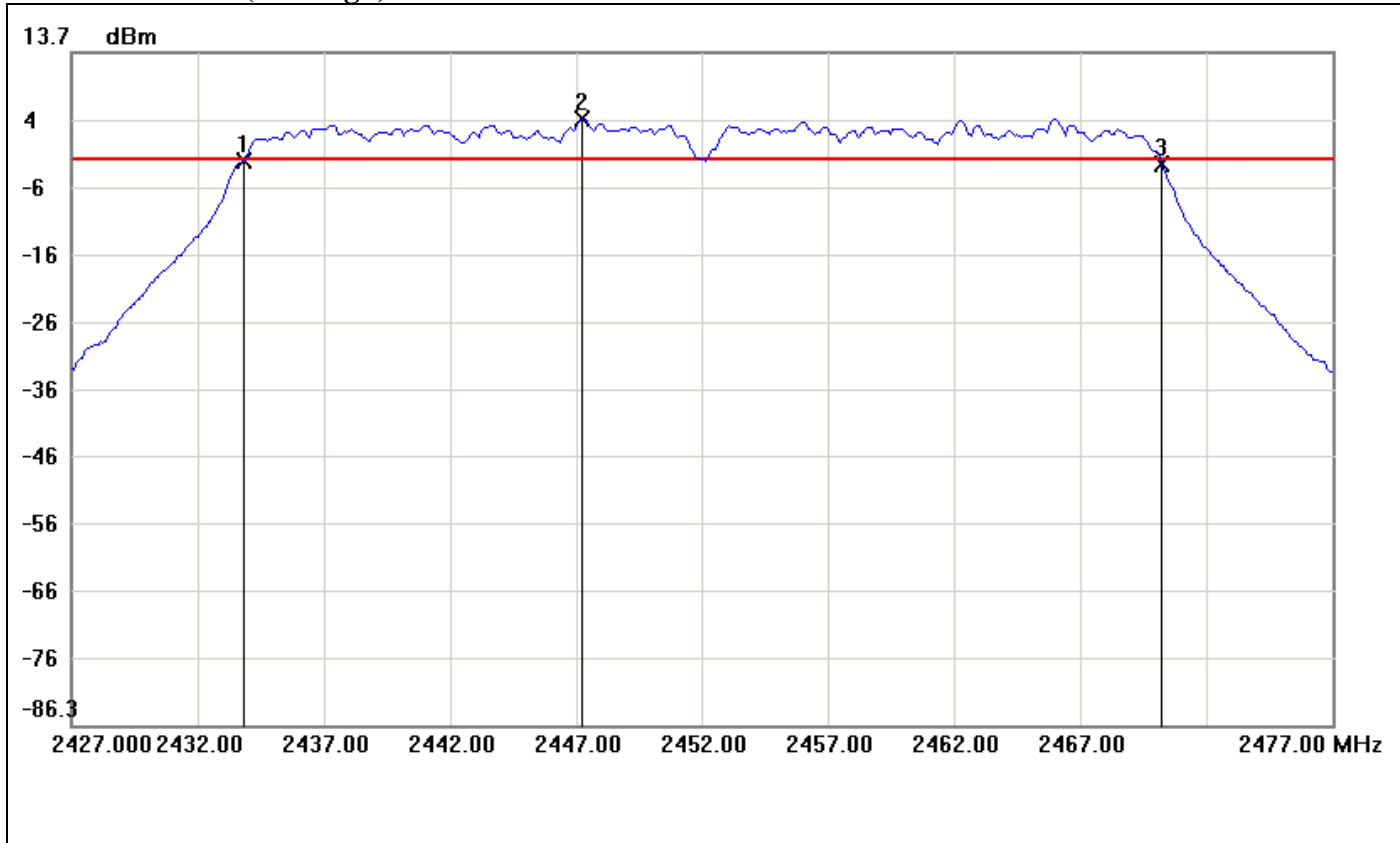

No.	Frequency(MHz)	Result(dBm)	Limit(dBm)	Margin(dBm)
1	2433.8333	-2.36	-2.16	-0.20
2	2447.2500	3.84	-2.16	6.00
3	2470.2500	-2.91	-2.16	-0.75

No.		Δ Frequency(MHz)	Δ Level(dB)
1	mk3-mk1	36.4167	-0.55



IEEE 802.11n HT 40 MHz mode / Chain 1

6dB Bandwidth (CH Low)

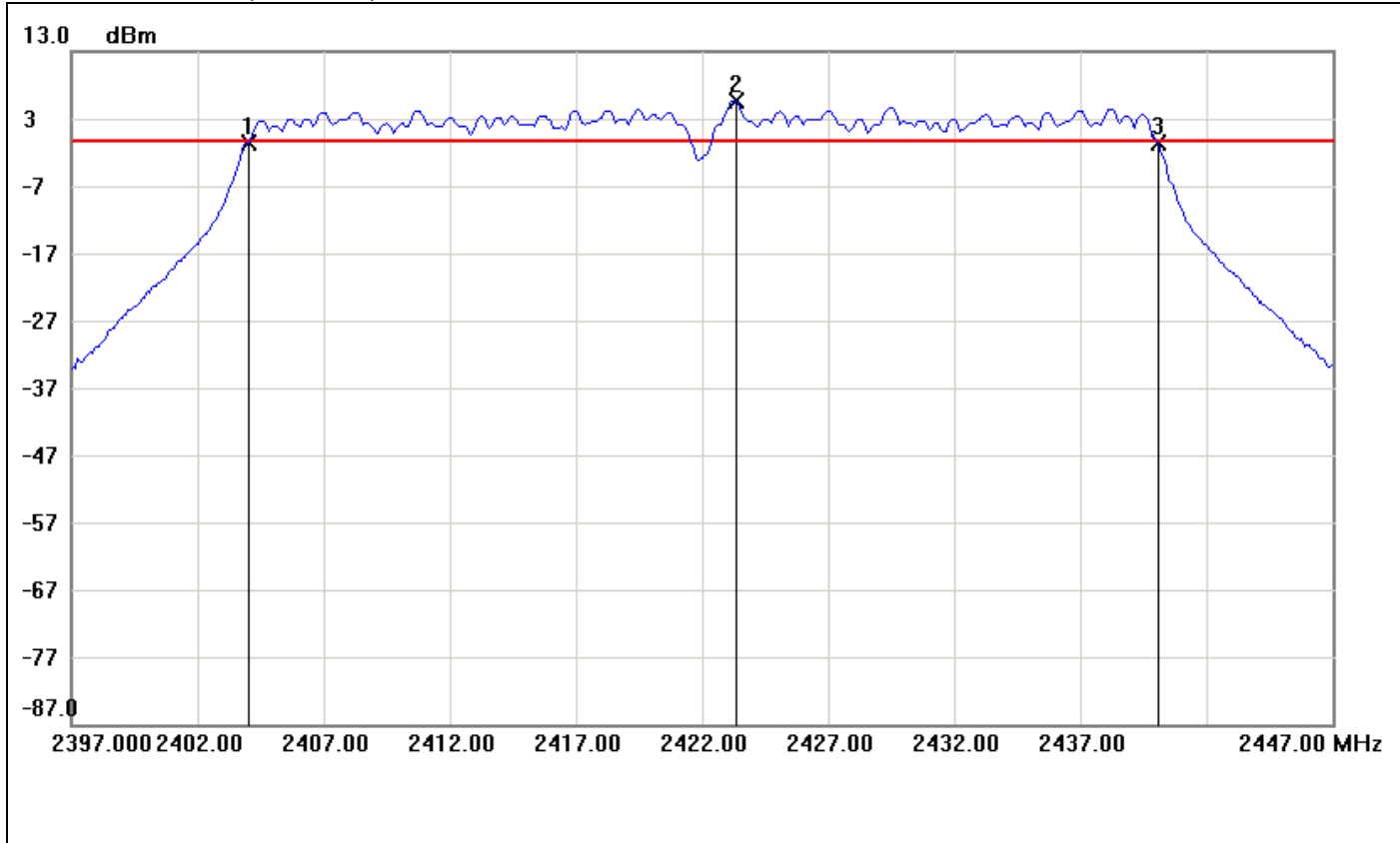

No.	Frequency(MHz)	Result(dBm)	Limit(dBm)	Margin(dBm)
1	2404.0000	-0.64	-0.31	-0.33
2	2423.3333	5.69	-0.31	6.00
3	2440.0833	-0.60	-0.31	-0.29

No.		Δ Frequency(MHz)	Δ Level(dB)
1	mk3-mk1	36.0833	0.04



6dB Bandwidth (CH Mid)

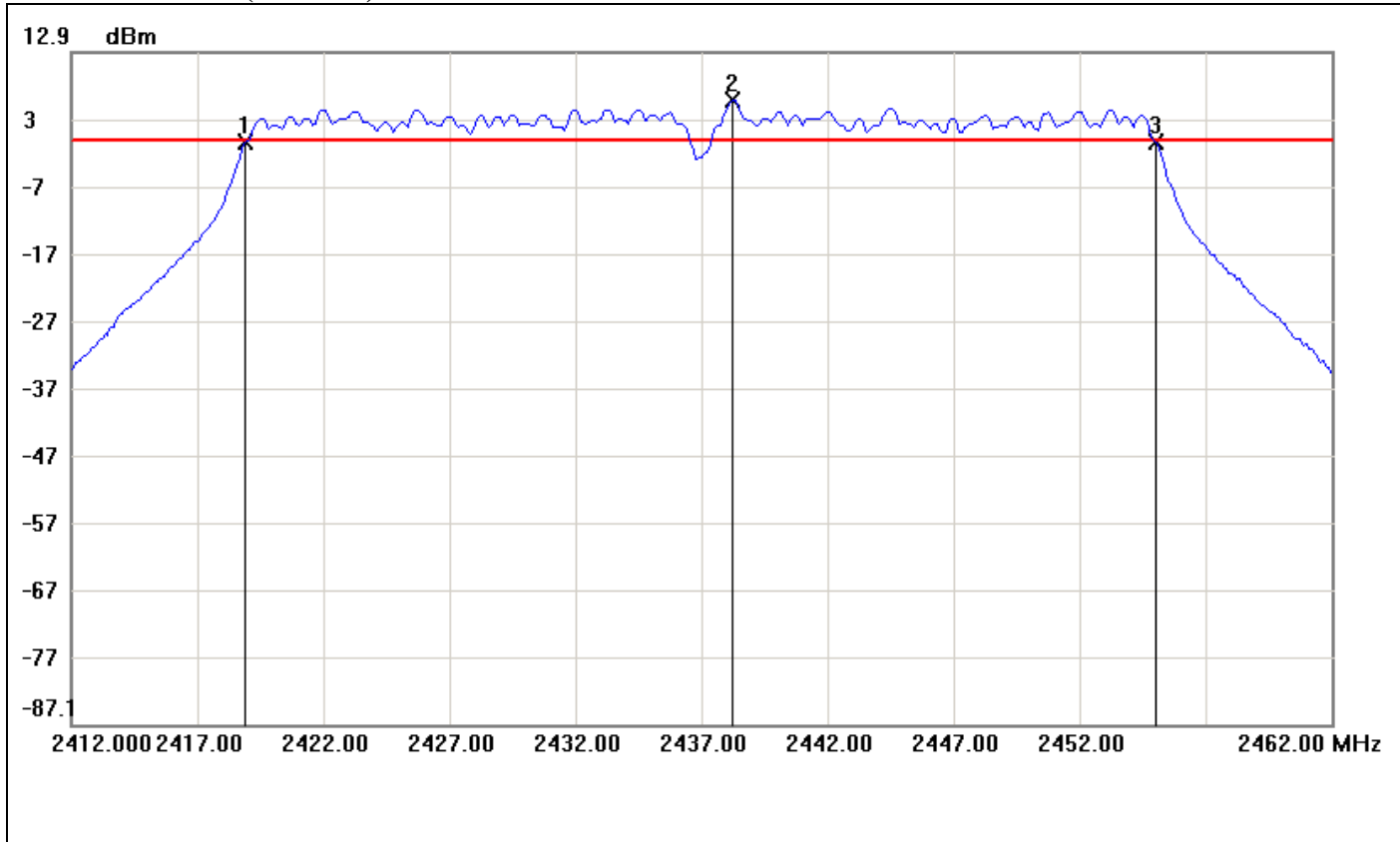

No.	Frequency(MHz)	Result(dBm)	Limit(dBm)	Margin(dBm)
1	2418.9167	-0.34	-0.24	-0.10
2	2438.2500	5.76	-0.24	6.00
3	2455.0000	-0.44	-0.24	-0.20

No.		Δ Frequency(MHz)	Δ Level(dB)
1	mk3-mk1	36.0833	-0.1



6dB Bandwidth (CH High)

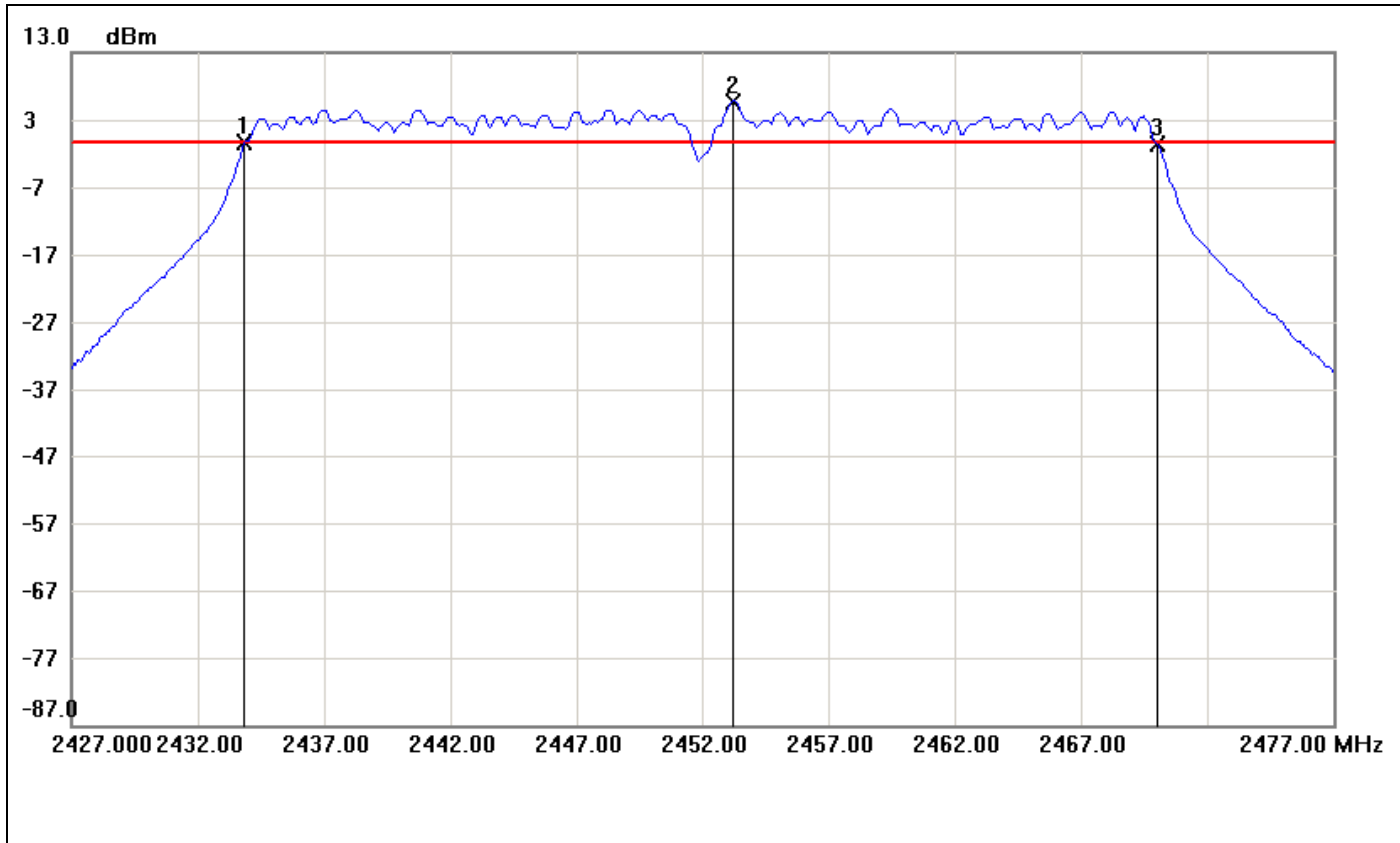

No.	Frequency(MHz)	Result(dBm)	Limit(dBm)	Margin(dBm)
1	2433.8333	-0.52	-0.29	-0.23
2	2453.2500	5.71	-0.29	6.00
3	2470.0000	-0.58	-0.29	-0.29

No.		Δ Frequency(MHz)	Δ Level(dB)
1	mk3-mk1	36.1667	-0.06



8.2 PEAK POWER

LIMIT

The maximum peak output power of the intentional radiator shall not exceed the following:

1. According to §15.247(b)(3), for systems using digital modulation in the bands of 902-928 MHz, 2400-2483.5 MHz, and 5725-5850 MHz: 1 Watt.
2. According to §15.247(b)(4), the conducted output power limit specified in paragraph (b) of this section is based on the use of antennas with directional gains that do not exceed 6 dBi. Except as shown in paragraph (c) of this section, if transmitting antennas of directional gain greater than 6 dBi are used, the conducted output power from the intentional radiator shall be reduced below the stated values in paragraphs (b)(1), (b)(2), and (b)(3) of this section, as appropriate, by the amount in dB that the directional gain of the antenna exceeds 6 dBi.
3. According to RSS-210 §A8.4(4), for systems employing digital modulation techniques operating in the bands 902-928 MHz, 2400-2483.5 MHz and 5725-5850 MHz, the maximum peak conducted output power shall not exceed 1 W.

Test Configuration

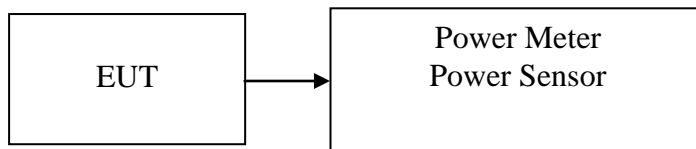

TEST PROCEDURE

The transmitter output is connected to the Power Meter. The Power Meter is set to the peak power detection.

TEST RESULTS

No non-compliance noted



Test Data

Test mode: IEEE 802.11b mode

Channel	Frequency (MHz)	Output Power (dBm)	Output Power (W)	Limit (W)	Result
Low	2412	19.50	0.0891	1.00	PASS
Mid	2442	*19.90	0.0977		PASS
High	2462	19.40	0.0871		PASS

Test mode: IEEE 802.11g mode

Channel	Frequency (MHz)	Output Power (dBm)	Output Power (W)	Limit (W)	Result
Low	2412	25.20	0.3311	1.00	PASS
Mid	2442	*25.50	0.3548		PASS
High	2462	25.00	0.3162		PASS

Test mode: IEEE 802.11n HT 20 MHz mode

Channel	Frequency (MHz)	Chain 0 Output Power (dBm)	Chain 1 Output Power (dBm)	Total Output Power (dBm)	Output Power (W)	Limit (W)	Result
Low	2412	23.00	22.20	25.63	0.3656	1.00	PASS
Mid	2442	22.90	22.60	*25.76	0.3767		PASS
High	2462	22.30	22.00	25.16	0.3281		PASS

Test mode: IEEE 802.11n HT 40 MHz mode

Channel	Frequency (MHz)	Chain 0 Output Power (dBm)	Chain 1 Output Power (dBm)	Total Output Power (dBm)	Output Power (W)	Limit (W)	Result
Low	2422	23.00	22.60	*25.81	0.3811	1.00	PASS
Mid	2442	22.40	22.40	25.41	0.3475		PASS
High	2452	22.90	22.60	25.76	0.3767		PASS

Remark: Total Output Power (w) = Chain 0 (10^(Output Power /10)/1000)+ Chain 1 (10^(Output Power /10)/1000)



8.3 AVERAGE POWER

LIMIT

None; for reporting purposes only.

Test Configuration

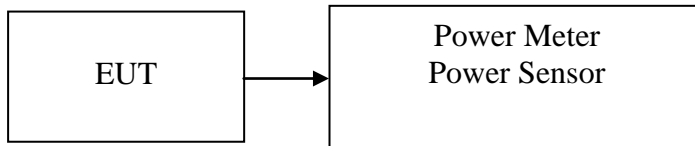

TEST PROCEDURE

The transmitter output is connected to the Power Meter. The Power Meter is set to the peak power detection.

TEST RESULTS

No non-compliance noted



Test Data

Test mode: IEEE 802.11b mode

Channel	Frequency (MHz)	Output Power (dBm)	Output Power (W)
Low	2412	17.20	0.0525
Mid	2442	17.60	0.0575
High	2462	17.00	0.0501

Test mode: IEEE 802.11g mode

Channel	Frequency (MHz)	Output Power (dBm)	Output Power (W)
Low	2412	17.20	0.0525
Mid	2442	17.70	0.0589
High	2462	16.90	0.0490

Test mode: IEEE 802.11n HT 20 MHz mode

Channel	Frequency (MHz)	Chain 0 Output Power (dBm)	Chain 1 Output Power (dBm)	Total Output Power (dBm)	Output Power (W)
Low	2412	14.00	13.47	16.75	0.0473
Mid	2442	13.70	13.90	16.81	0.0480
High	2462	13.20	13.40	16.31	0.0428

Test mode: IEEE 802.11n HT 40 MHz mode

Channel	Frequency (MHz)	Chain 0 Output Power (dBm)	Chain 1 Output Power (dBm)	Total Output Power (dBm)	Output Power (W)
Low	2422	14.00	13.90	16.96	0.0497
Mid	2442	13.30	13.60	16.46	0.0443
High	2452	14.10	14.15	17.14	0.0518

Remark: Total Output Power (w) = Chain 0 (10^{^(Output Power /10)}/1000)+ Chain 1 (10^{^(Output Power /10)}/1000)



8.4 BAND EDGES MEASUREMENT

LIMIT

According to §15.247(d) & RSS-210 §A8.5, in any 100 kHz bandwidth outside the frequency bands in which the spread spectrum intentional radiator is operating, the radio frequency power that is produced by the intentional radiator shall be at least 20 dB below that in the 100 kHz bandwidth within the band that contains the highest level of the desired power, based on either an RF conducted or a radiated measurement, provided the transmitter demonstrates compliance with the peak conducted power limits. In addition, radiated emissions which fall in the restricted bands, as defined in §15.205(a), must also comply with the radiated emission limits specified in 15.209(a) (see Section 15.205(c)).

Test Configuration

For Radiated

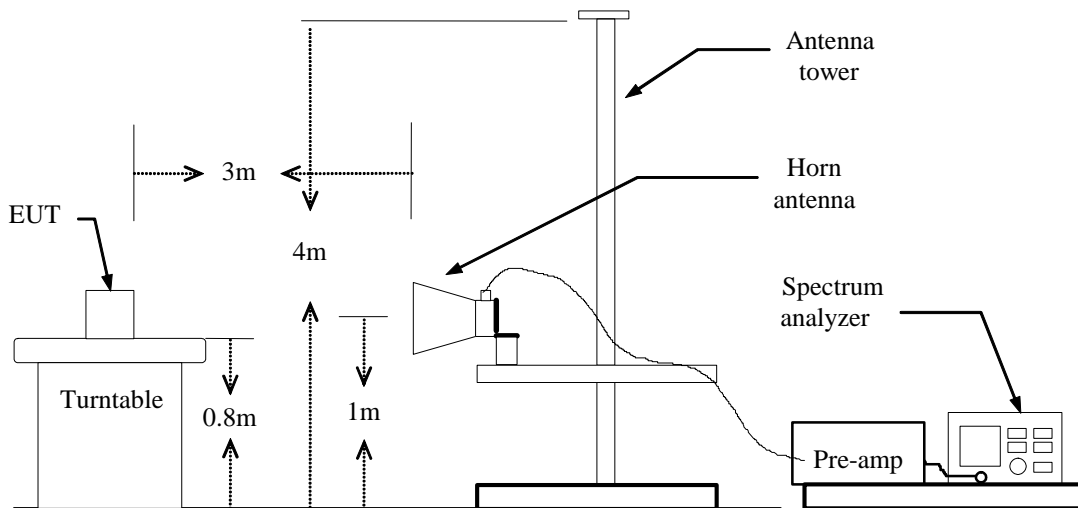

For Conducted

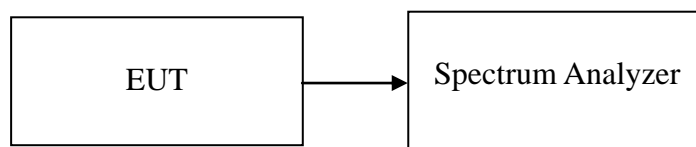



TEST PROCEDURE

For Radiated

1. The EUT is placed on a turntable, which is 0.8m above the ground plane.
2. The turntable shall be rotated for 360 degrees to determine the position of maximum emission level.
3. EUT is set 3m away from the receiving antenna, which is varied from 1m to 4m to find out the highest emission.
4. Set the spectrum analyzer in the following setting in order to capture the lower and upper band-edges of the emission:
 - (a) PEAK: RBW=VBW=1MHz / Sweep=AUTO
 - (b) AVERAGE: RBW=1MHz / VBW=300Hz / Sweep=AUTO
5. Repeat the procedures until all the PEAK and AVERAGE versus POLARIZATION are measured.

For Conducted

Conducted RF measurements of the transmitter output were made to confirm that the EUT antenna port conducted emissions meet the specified limit and to identify any spurious signals that require further investigation or measurements on the radiated emissions site.

The transmitter output is connected to the spectrum analyzer. The resolution bandwidth is set to 100 kHz. The video bandwidth is set to 100 kHz.

TEST RESULTS

Refer to attach spectrum analyzer data chart.



Band Edges (IEEE 802.11b mode / CH Low)

Detector mode: Peak

Polarity: Vertical

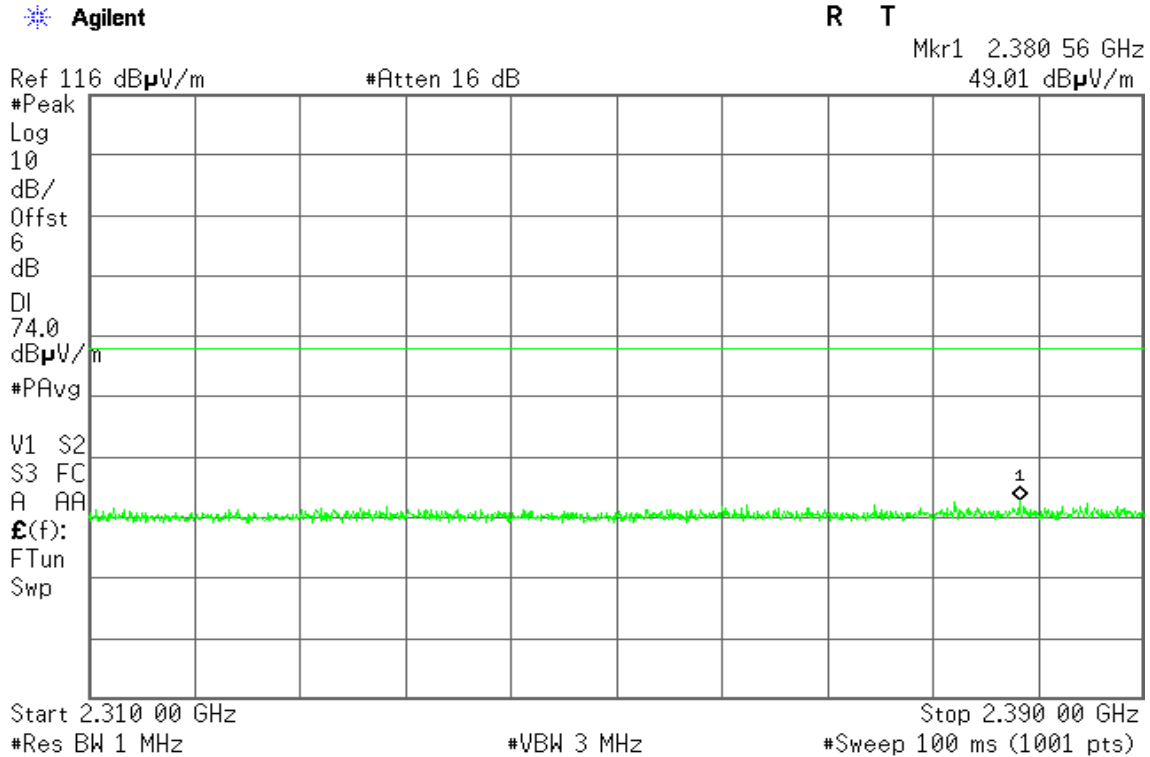

Detector mode: Average

Polarity: Vertical

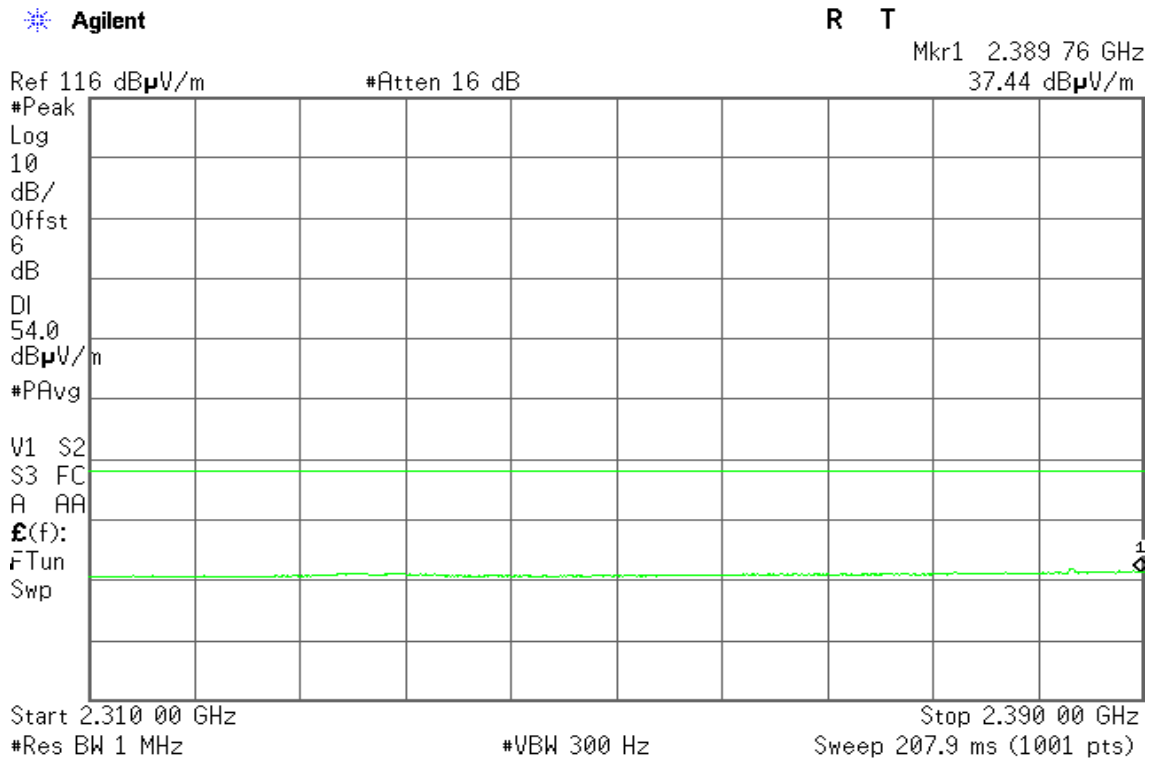



Detector mode: Peak

Polarity: Horizontal

Agilent

R T

Mkr1 2.389 92 GHz
55.28 dB μ V/m

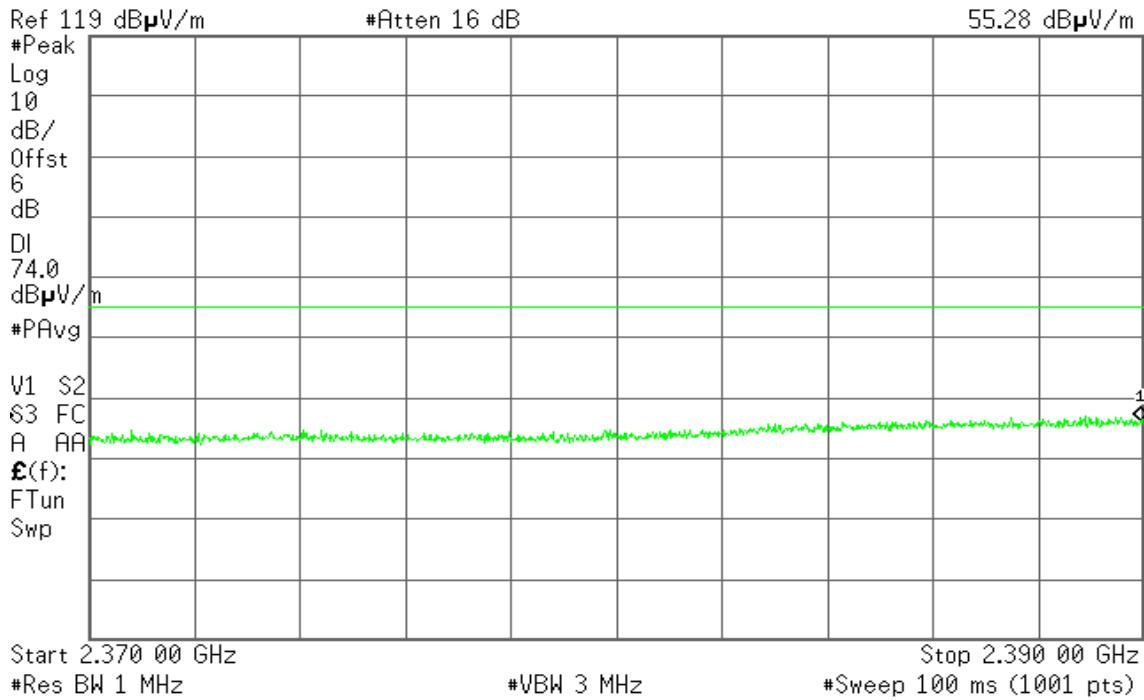

Detector mode: Average

Polarity: Horizontal

Agilent

R T

Mkr1 2.389 92 GHz
44.52 dB μ V/m

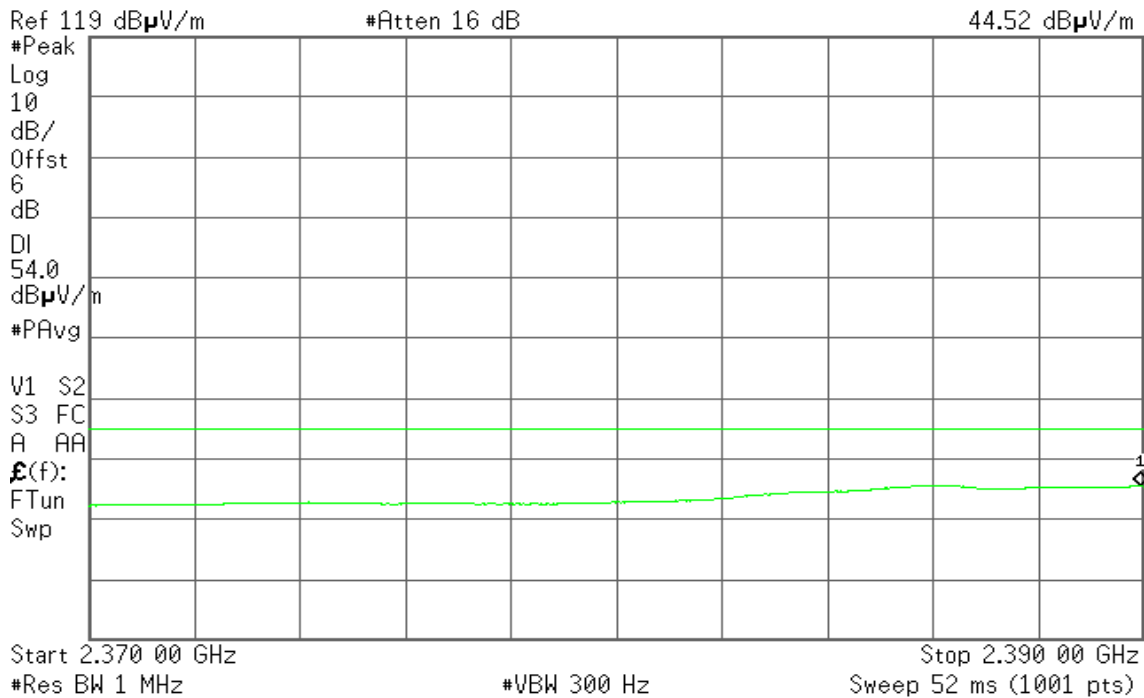



Band Edges (IEEE 802.11b mode / CH High)

Detector mode: Peak

Polarity: Vertical

Agilent

R T

Mkr1 2.484 64 GHz
50.10 dB μ V/m

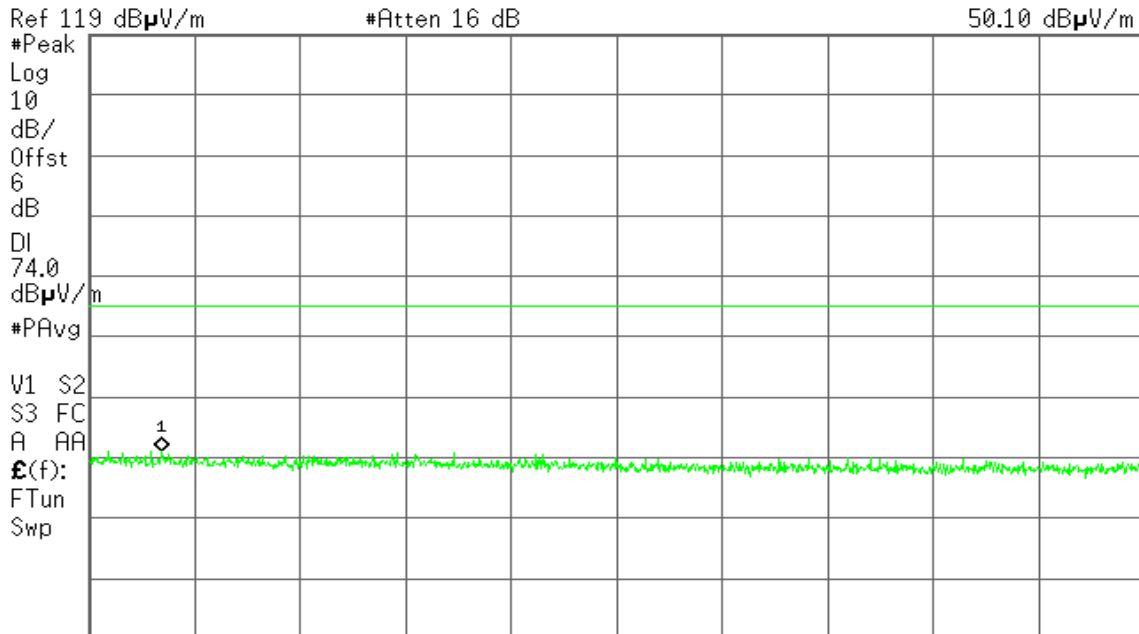

Start 2.483 50 GHz #Res BW 1 MHz #VBW 3 MHz Stop 2.500 00 GHz #Sweep 100 ms (1001 pts)

Detector mode: Average

Polarity: Vertical

Agilent

R T

Mkr1 2.483 52 GHz
39.35 dB μ V/m

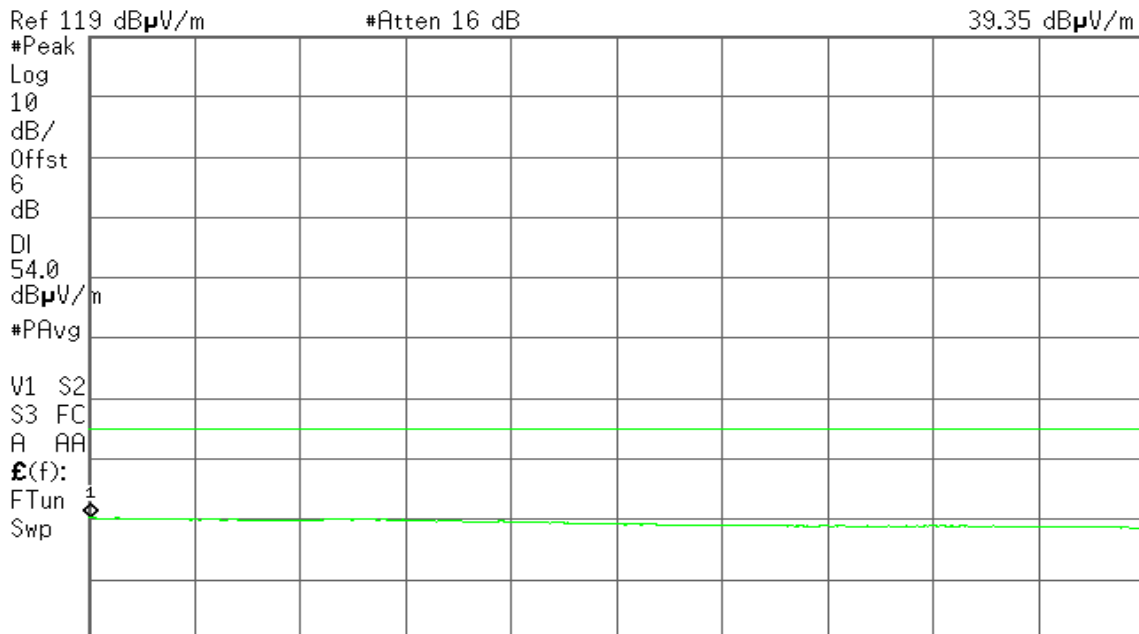

Start 2.483 50 GHz #Res BW 1 MHz #VBW 300 Hz Sweep 42.93 ms (1001 pts)



Detector mode: Peak

Polarity: Horizontal

Agilent

R T

Mkr1 2.499 85 GHz
45.56 dB μ V/m

Ref 119 dB μ V/m

#Atten 16 dB

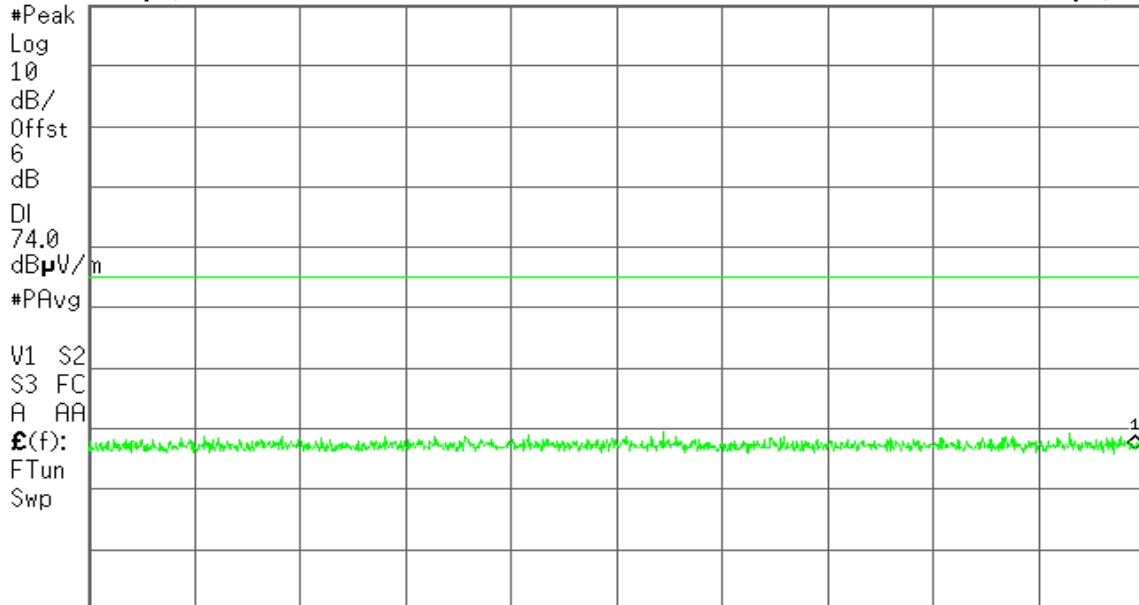

Start 2.483 50 GHz

Stop 2.500 00 GHz

#Res BW 1 MHz

#VBW 3 MHz

#Sweep 100 ms (1001 pts)

Detector mode: Average

Polarity: Horizontal

Agilent

R T

Mkr1 2.493 43 GHz
37.39 dB μ V/m

Ref 119 dB μ V/m

#Atten 16 dB

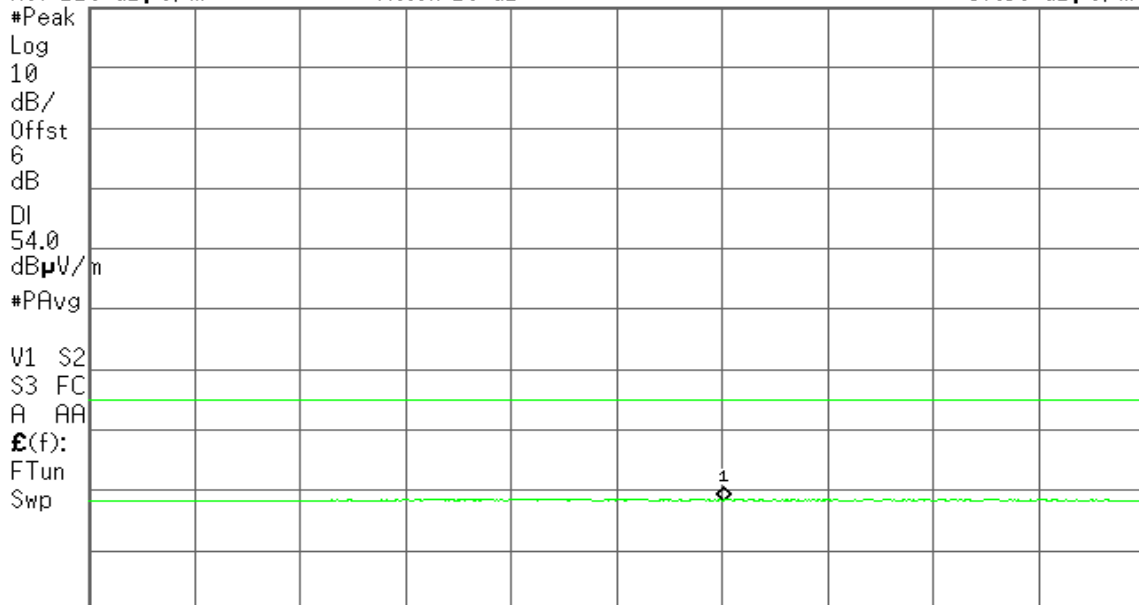

Start 2.483 50 GHz

Stop 2.500 00 GHz

#Res BW 1 MHz

#VBW 300 Hz

Sweep 42.93 ms (1001 pts)



Band Edges (IEEE 802.11g mode / CH Low)

Detector mode: Peak

Polarity: Vertical

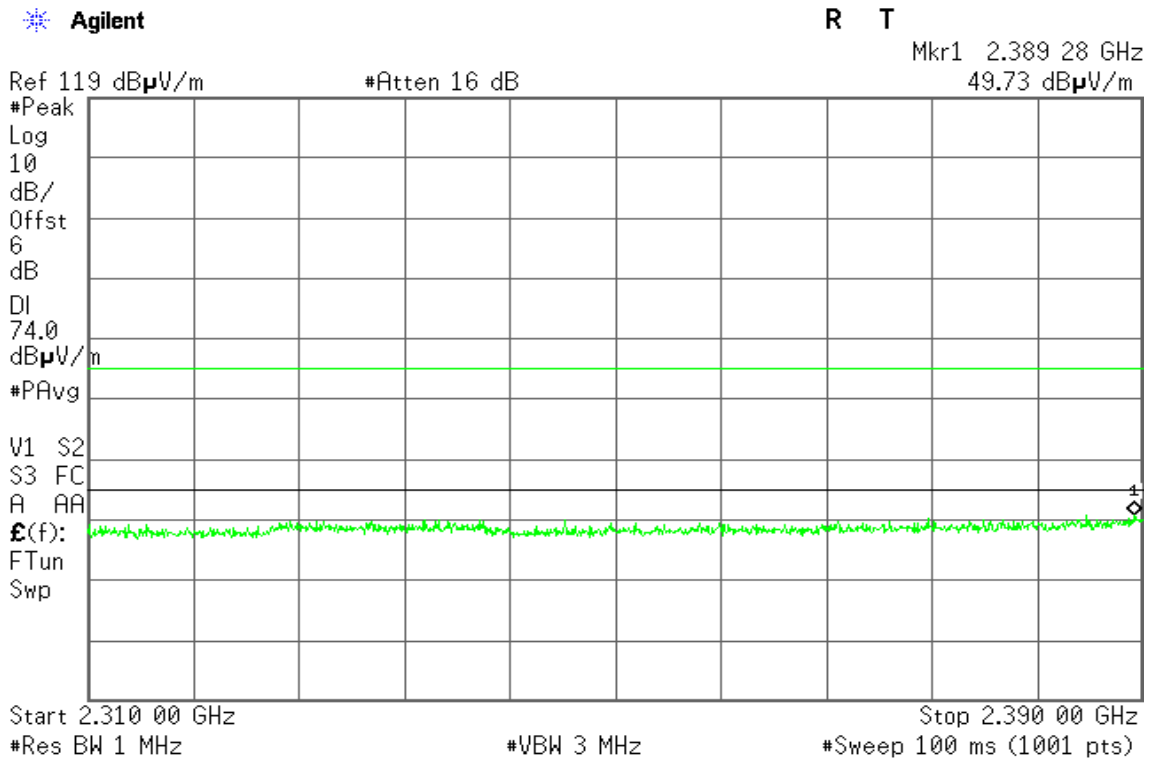

Detector mode: Average

Polarity: Vertical

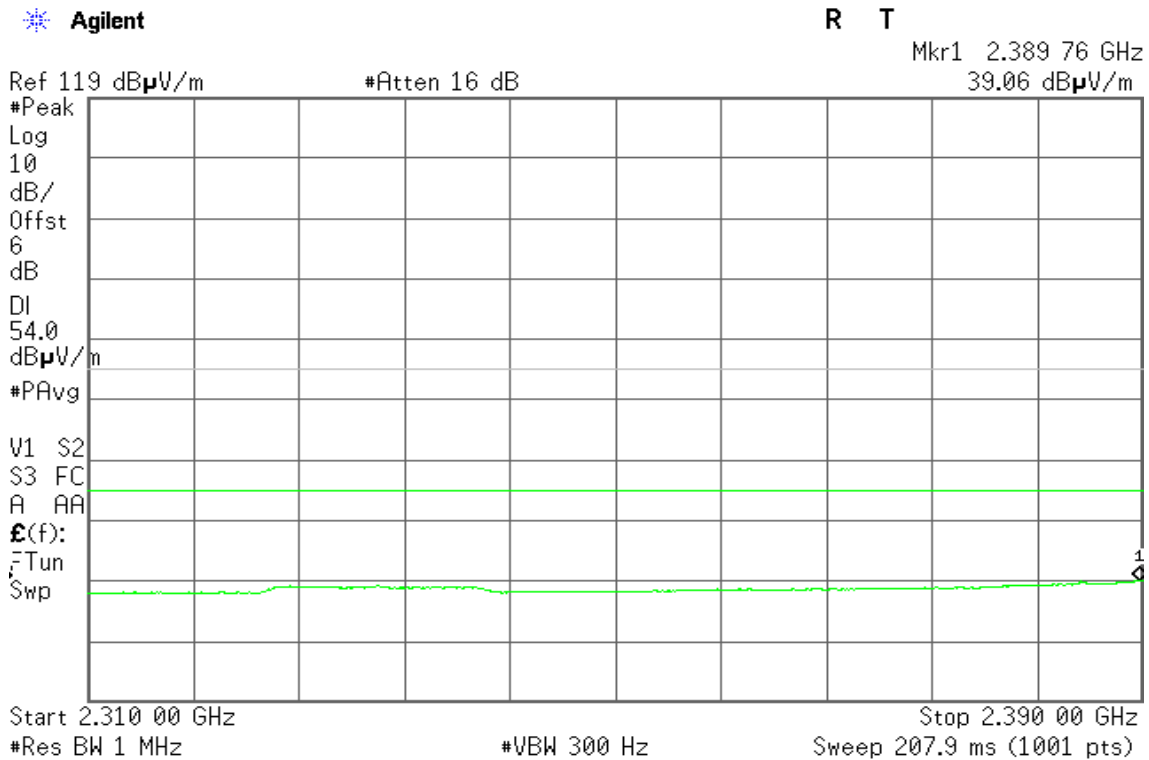



Detector mode: Peak

Polarity: Horizontal

Agilent

R T

Mkr1 2.389 92 GHz
52.16 dB μ V/m

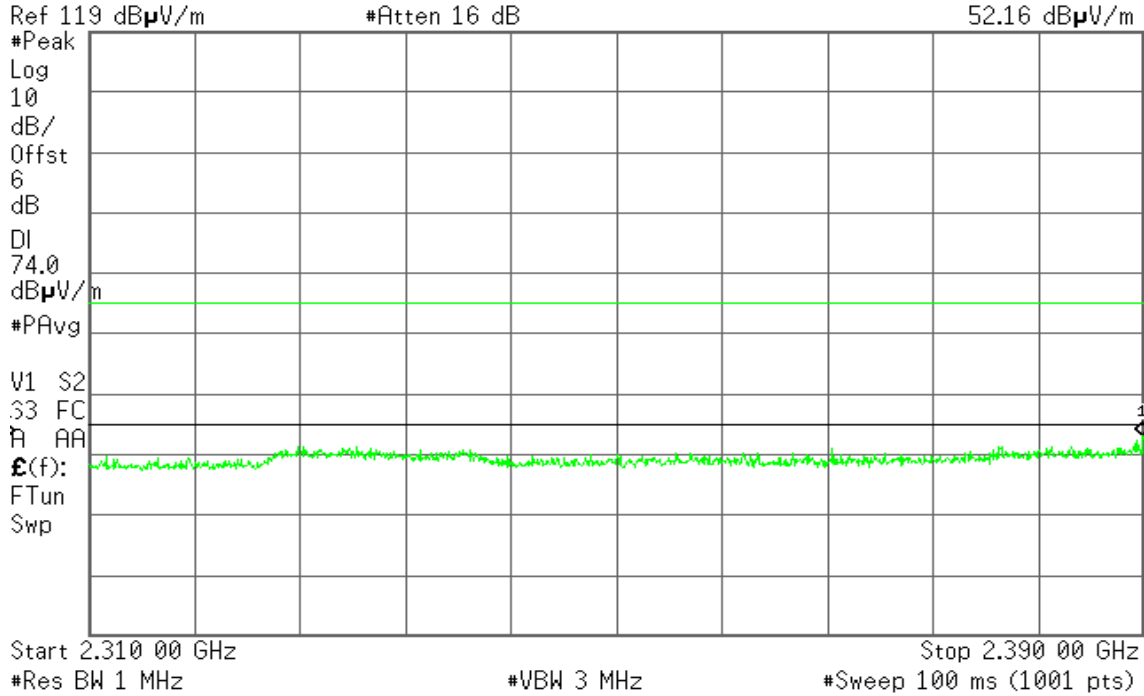

Detector mode: Average

Polarity: Horizontal

Agilent

R T

Mkr1 2.390 00 GHz
40.07 dB μ V/m

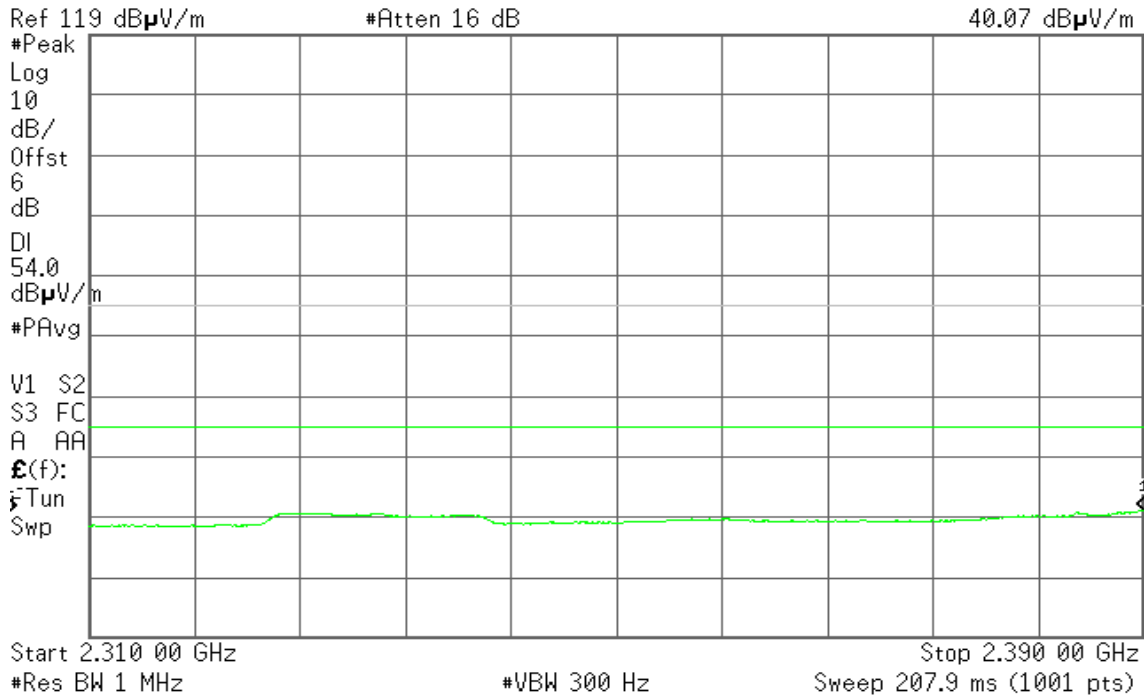



Band Edges (IEEE 802.11g mode / CH High)

Detector mode: Peak

Polarity: Vertical

Agilent

R T

Mkr1 2.483 52 GHz
68.51 dB μ V/m

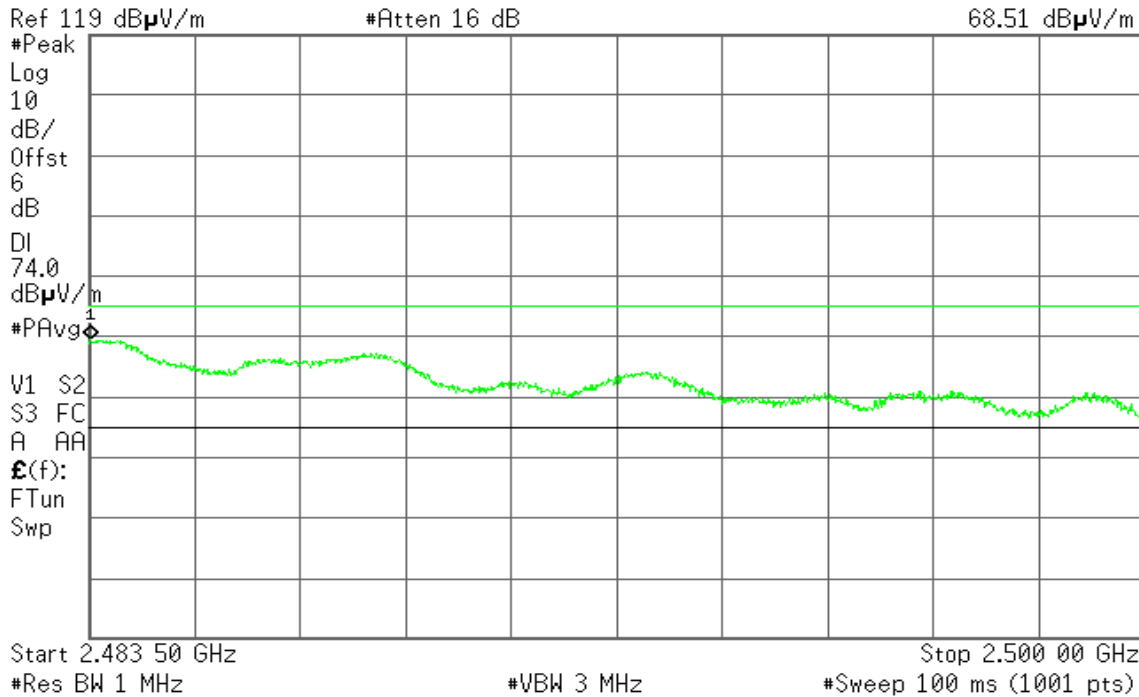

Detector mode: Average

Polarity: Vertical

Agilent

R T

Mkr1 2.483 50 GHz
52.81 dB μ V/m

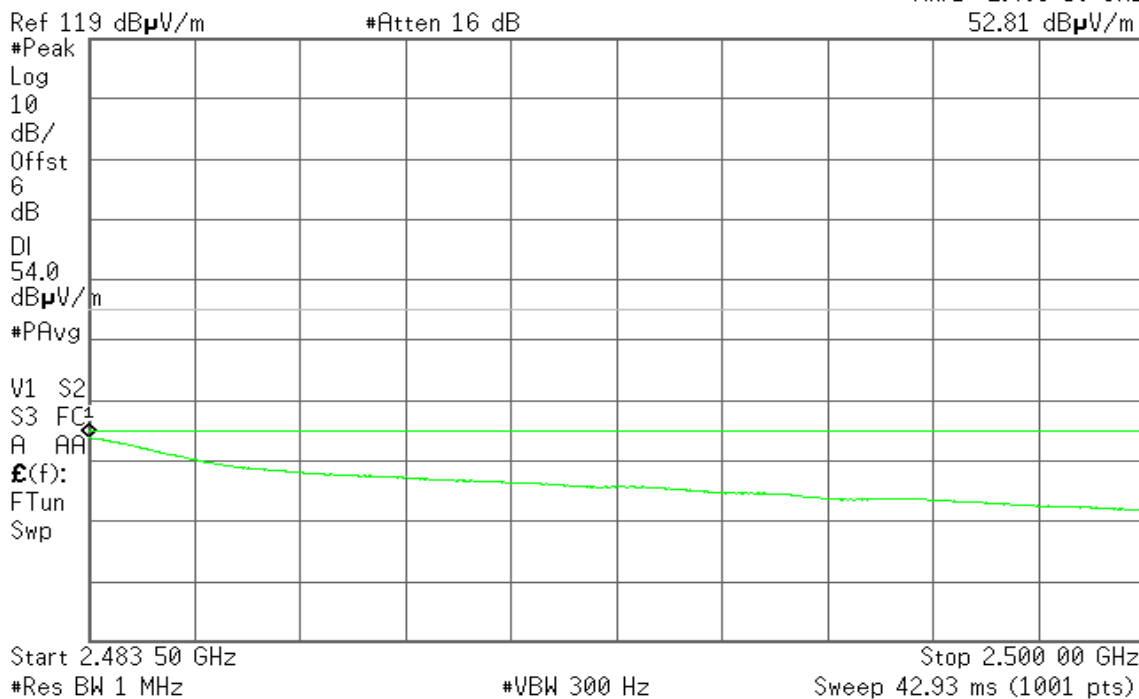



Detector mode: Peak

Polarity: Horizontal

Agilent

R T

Mkr1 2.483 53 GHz
69.22 dB μ V/m

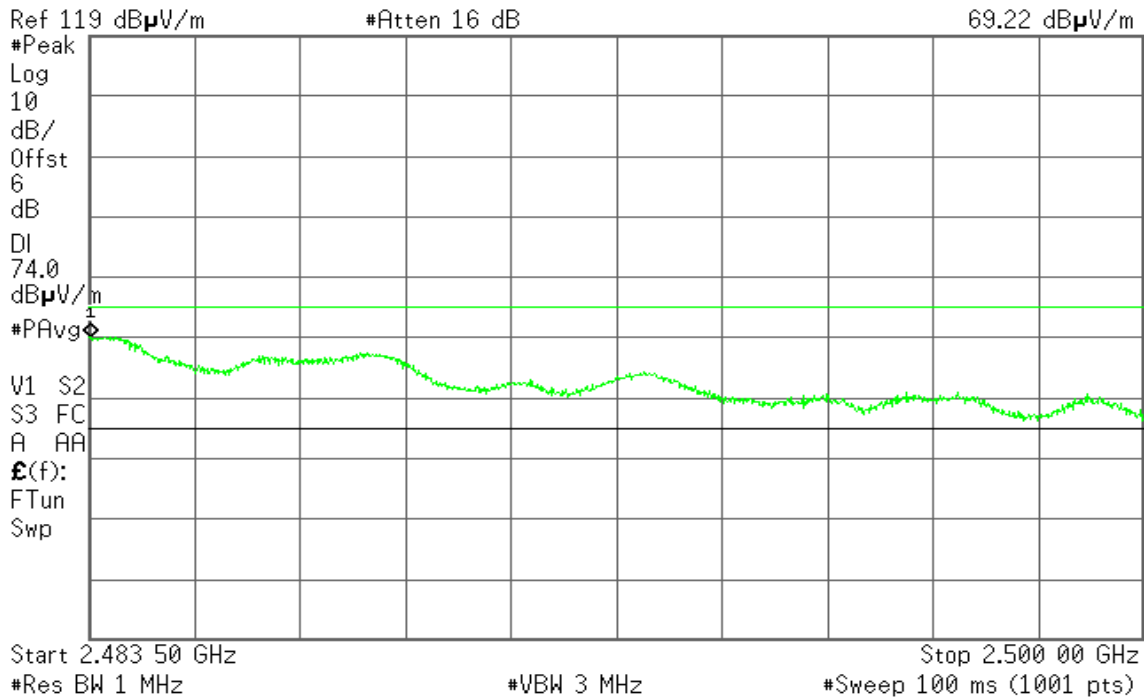

Detector mode: Average

Polarity: Horizontal

Agilent

R T

Mkr1 2.483 50 GHz
53.17 dB μ V/m

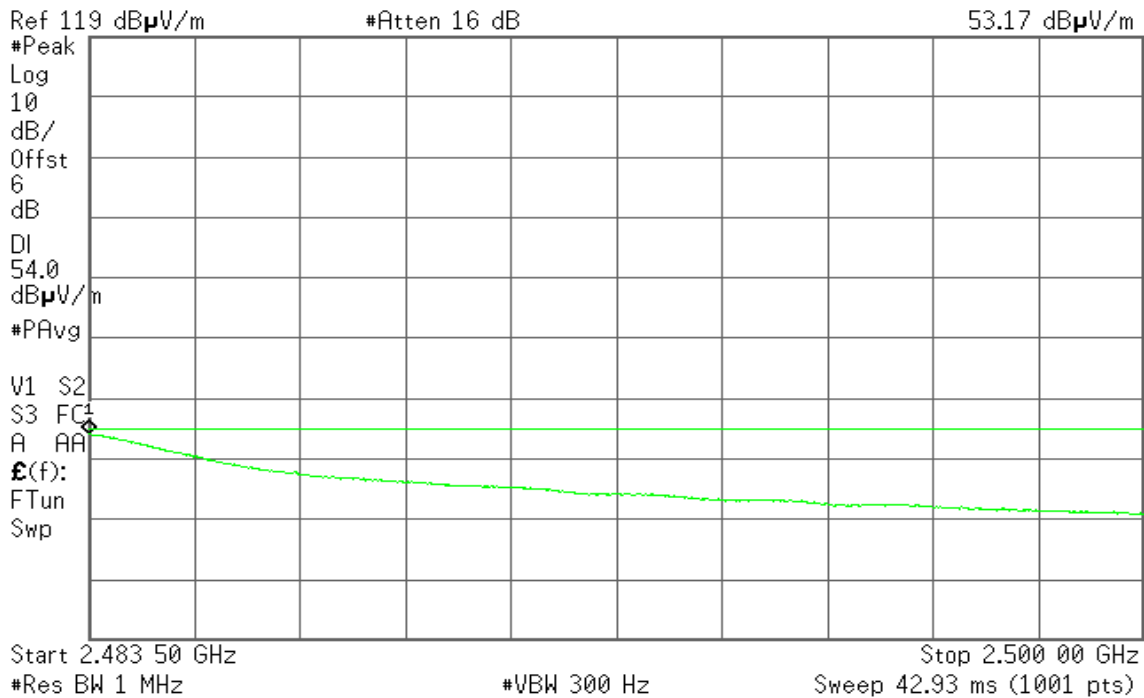



Band Edges (IEEE 802.11n HT 20 MHz mode / CH Low)

Detector mode: Peak

Polarity: Vertical

Agilent

R T

Mkr1 2.389 84 GHz
55.32 dB μ V/m

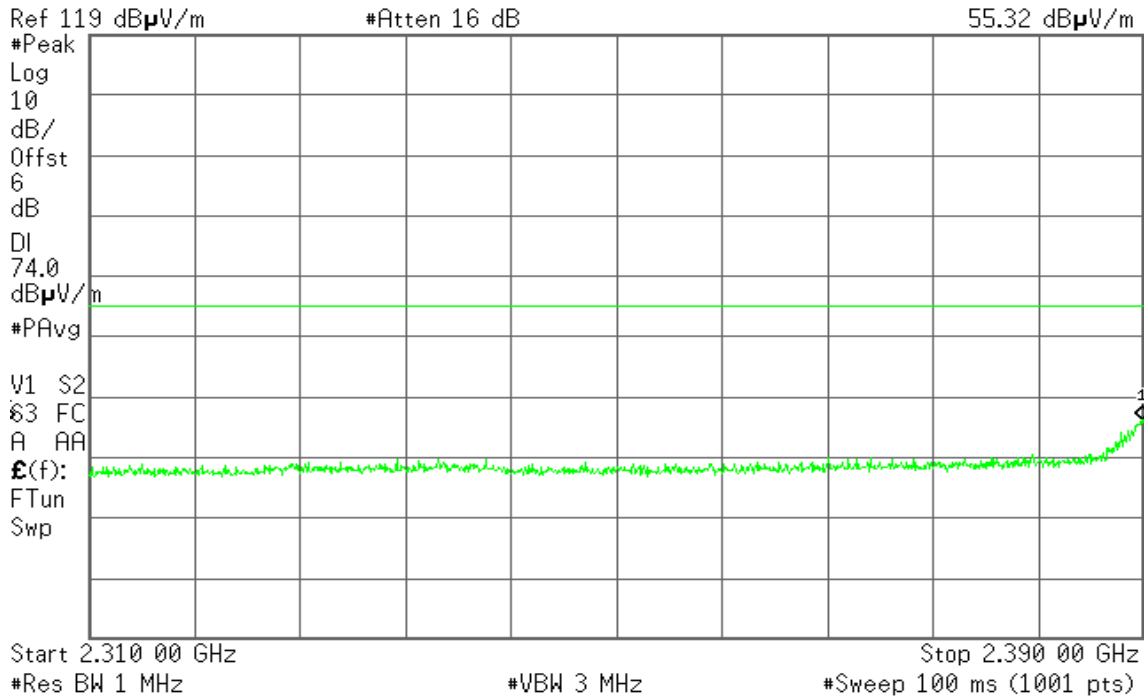

Detector mode: Average

Polarity: Vertical

Agilent

R T

Mkr1 2.390 00 GHz
44.56 dB μ V/m

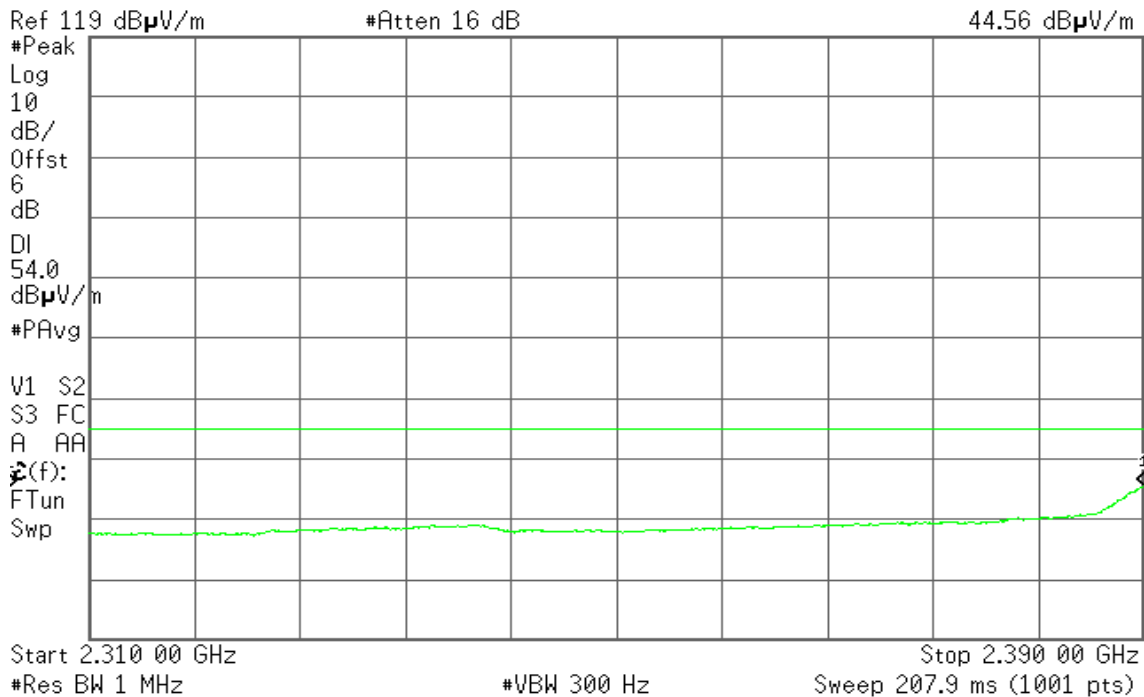



Detector mode: Peak

Polarity: Horizontal

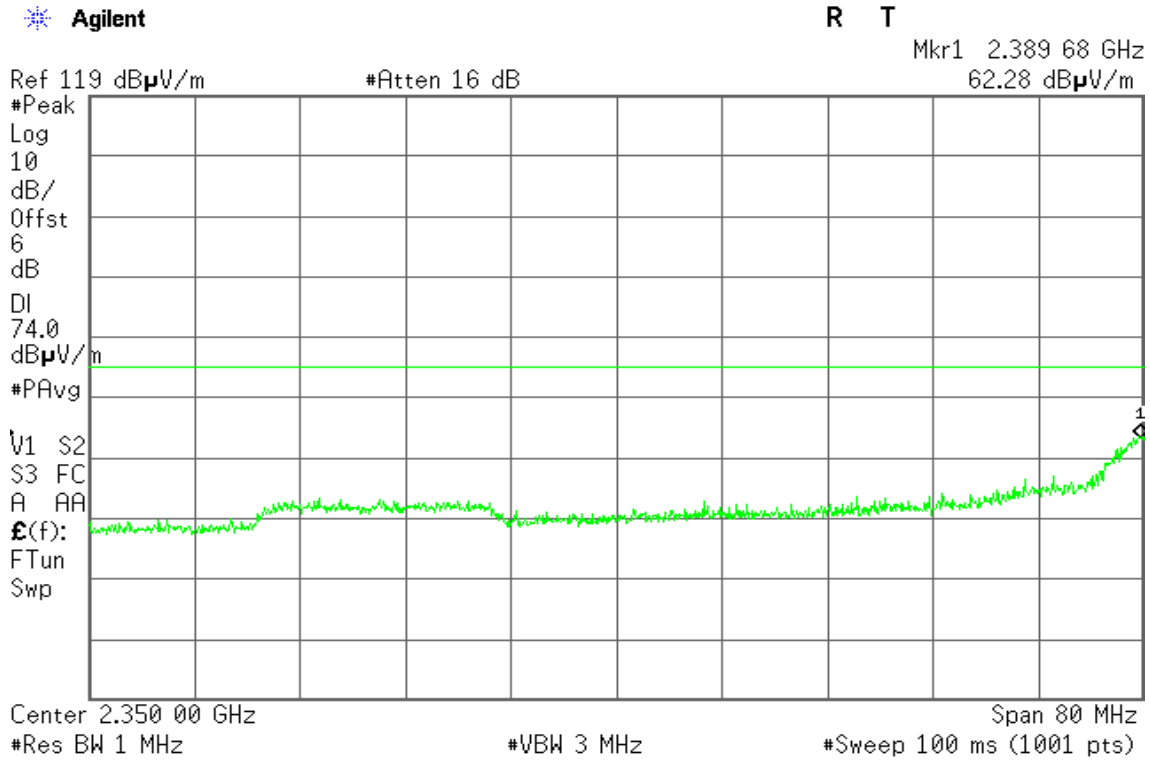

Detector mode: Average

Polarity: Horizontal

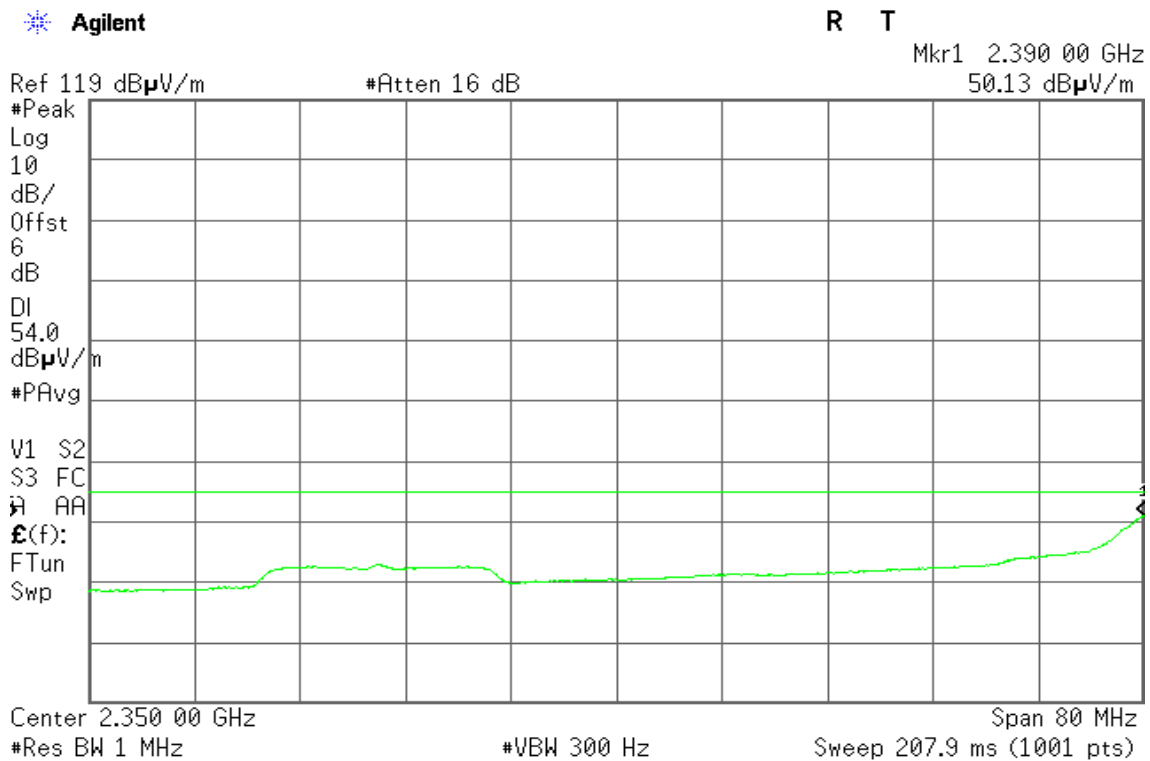



Band Edges (IEEE 802.11n HT 20 MHz mode / CH High)

Detector mode: Peak

Polarity: Vertical

Agilent

R T

Mkr1 2.483 55 GHz
50.33 dB μ V/m

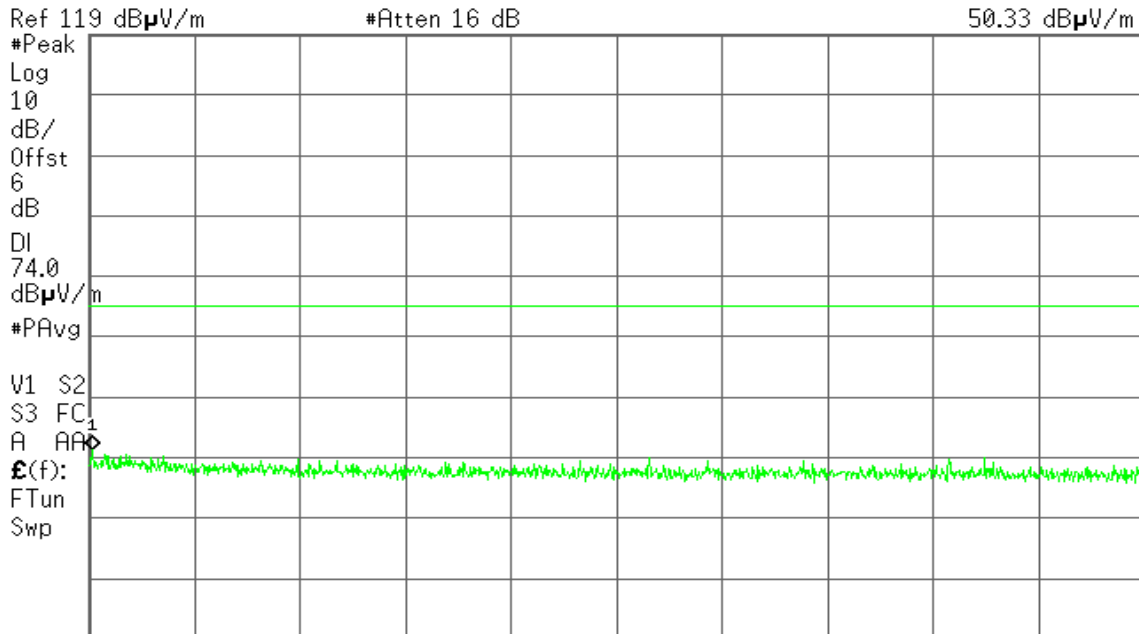

Start 2.483 50 GHz Stop 2.500 00 GHz
#Res BW 1 MHz #VBW 3 MHz #Sweep 100 ms (1001 pts)

Detector mode: Average

Polarity: Vertical

Agilent

R T

Mkr1 2.483 83 GHz
39.54 dB μ V/m

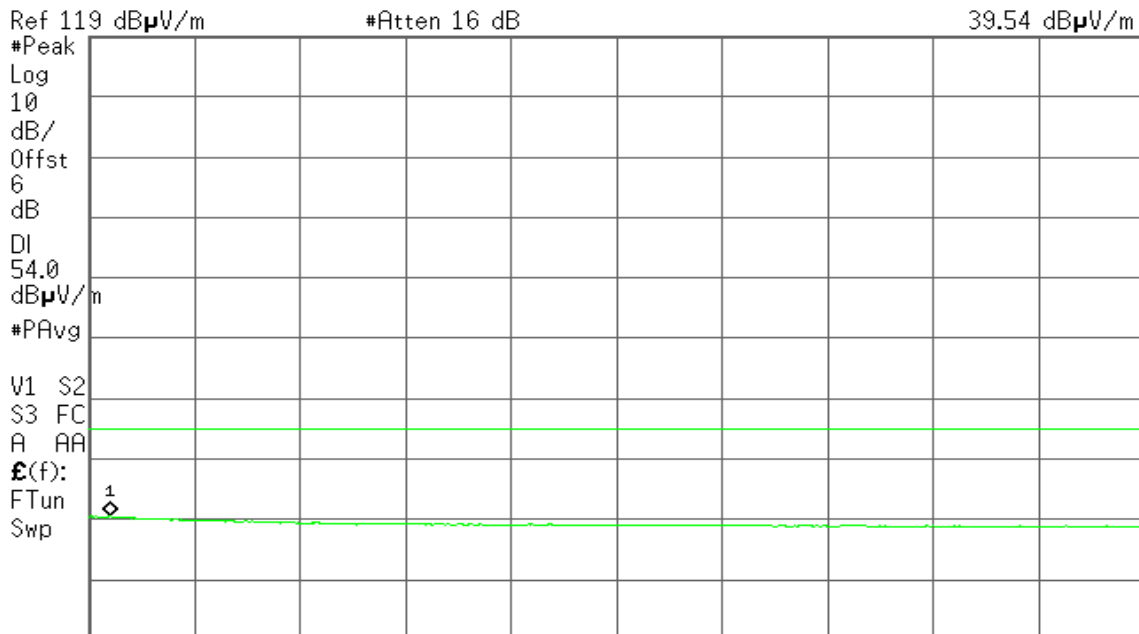

Start 2.483 50 GHz Stop 2.500 00 GHz
#Res BW 1 MHz #VBW 300 Hz Sweep 42.93 ms (1001 pts)



Detector mode: Peak

Polarity: Horizontal

Agilent

R T

Mkr1 2.484 28 GHz
52.52 dB μ V/m

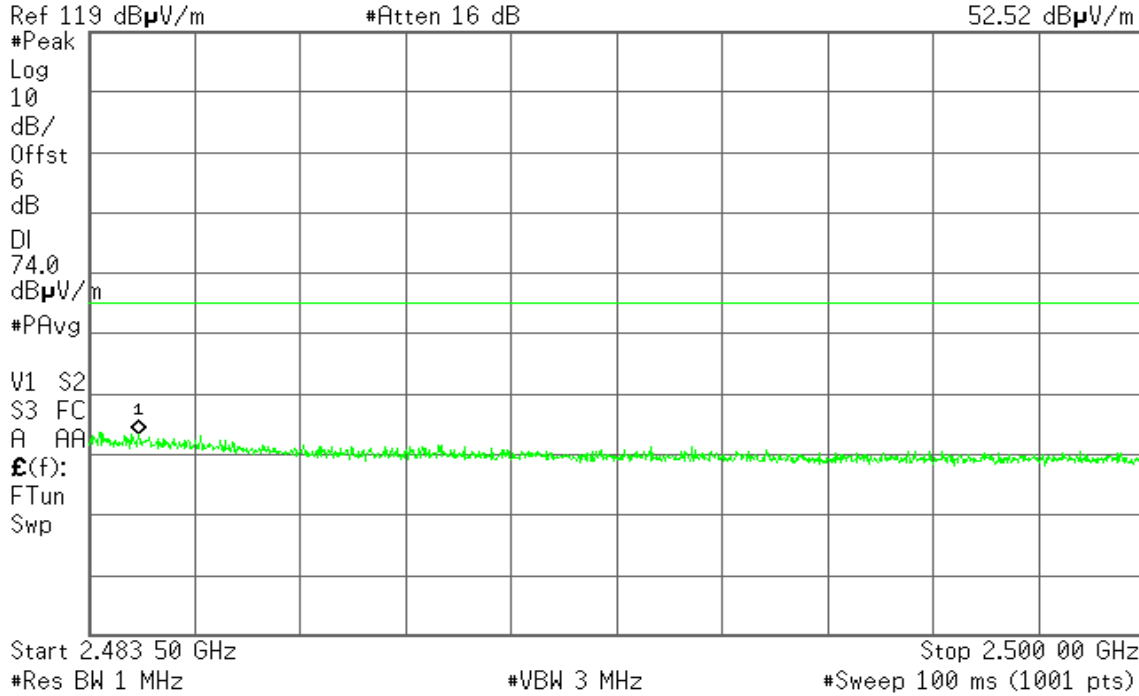

Detector mode: Average

Polarity: Horizontal

Agilent

R T

Mkr1 2.483 50 GHz
41.34 dB μ V/m

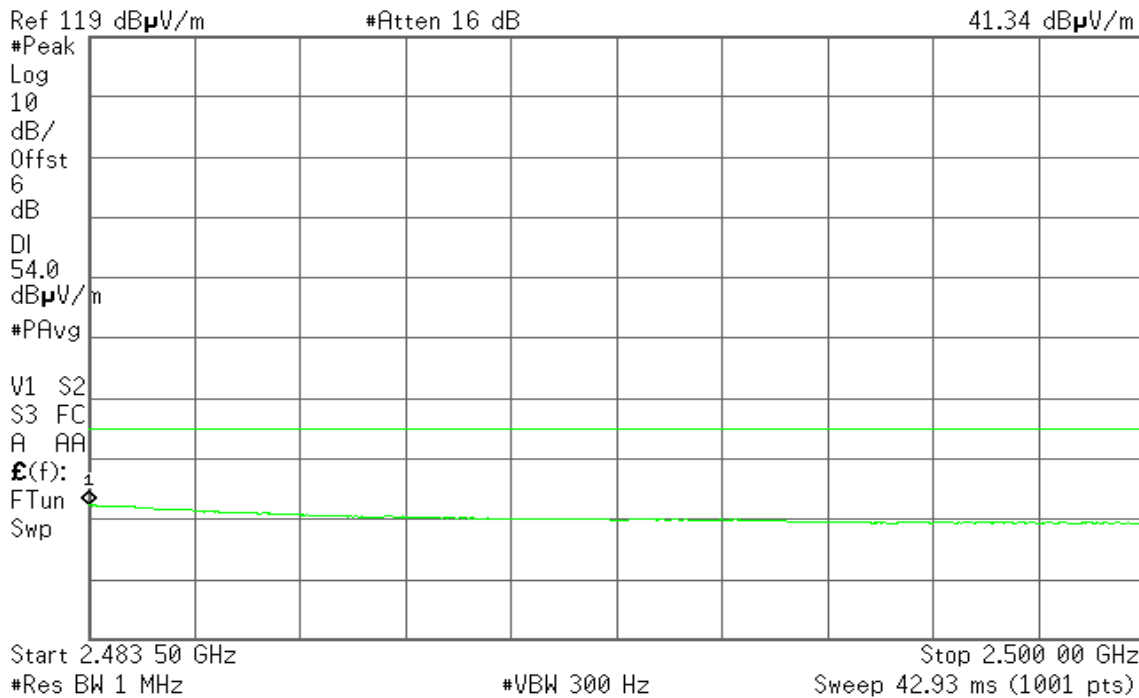



Band Edges (IEEE 802.11n HT 40 MHz mode / CH Low)

Detector mode: Peak

Polarity: Vertical

Agilent

R T

Mkr1 2.382 16 GHz
57.72 dB μ V/m

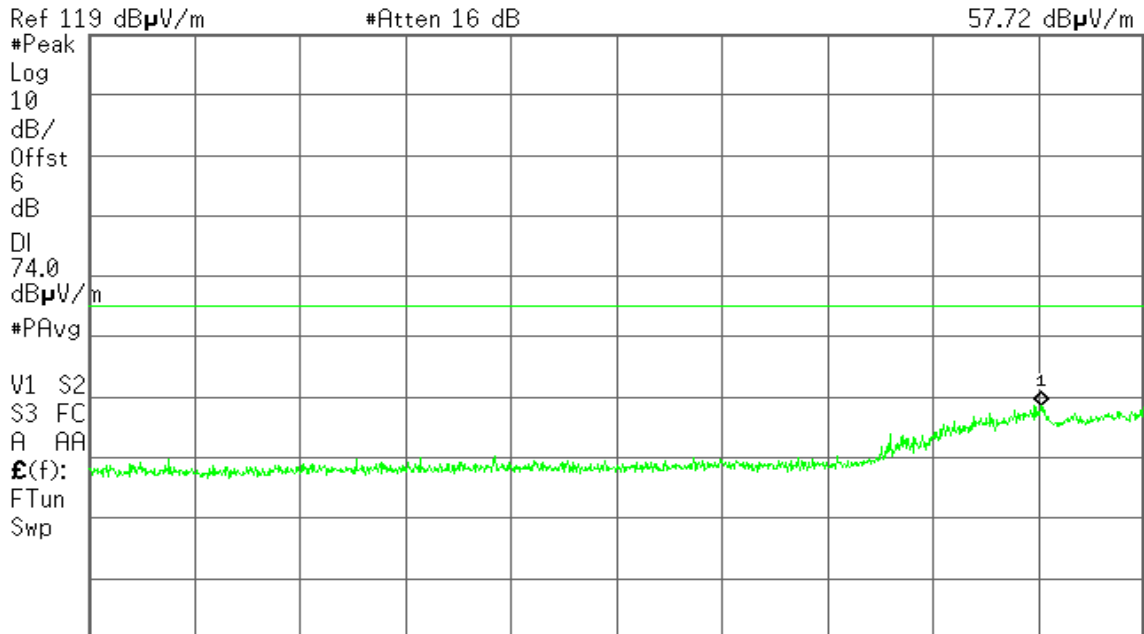

Start 2.310 00 GHz Stop 2.390 00 GHz
#Res BW 1 MHz #VBW 3 MHz #Sweep 100 ms (1001 pts)

Detector mode: Average

Polarity: Vertical

Agilent

R T

Mkr1 2.390 00 GHz
48.17 dB μ V/m

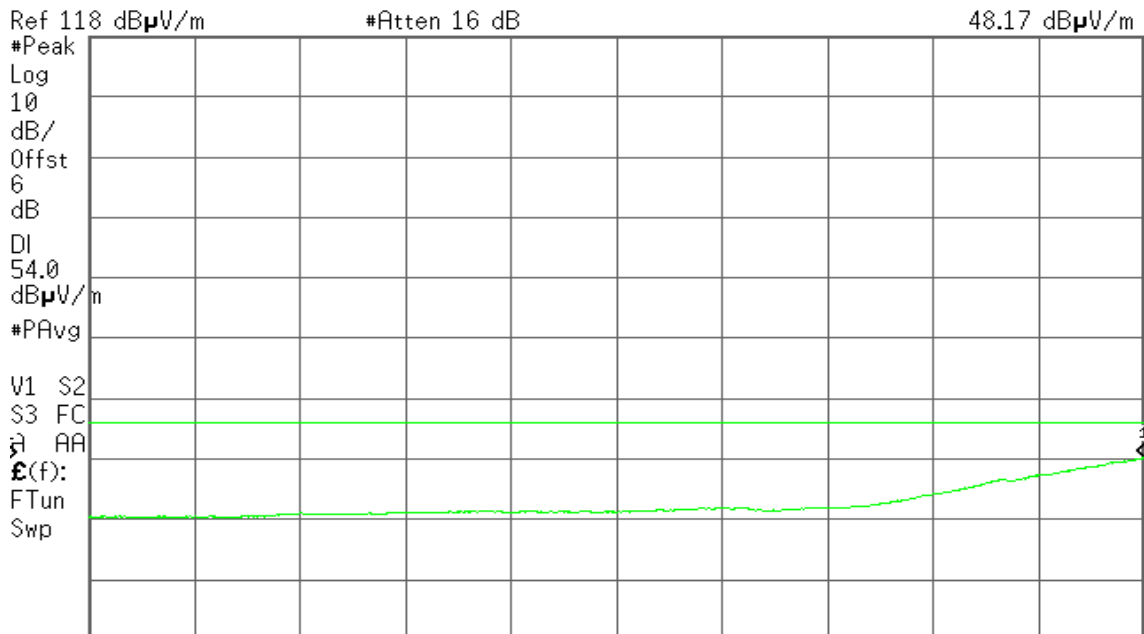

Start 2.310 00 GHz Stop 2.390 00 GHz
#Res BW 1 MHz #VBW 300 Hz Sweep 207.9 ms (1001 pts)



Detector mode: Peak

Polarity: Horizontal

Agilent

R T

Mkr1 2.382 40 GHz
65.06 dB μ V/m

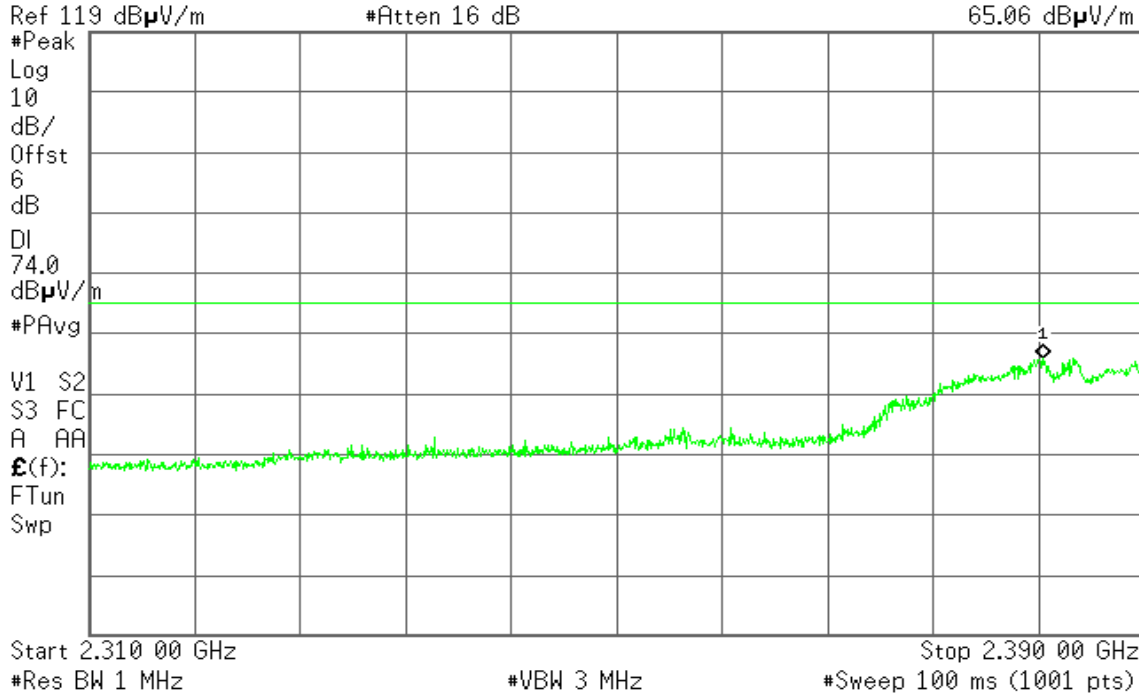

Detector mode: Average

Polarity: Horizontal

Agilent

R T

Mkr1 2.390 00 GHz
53.53 dB μ V/m

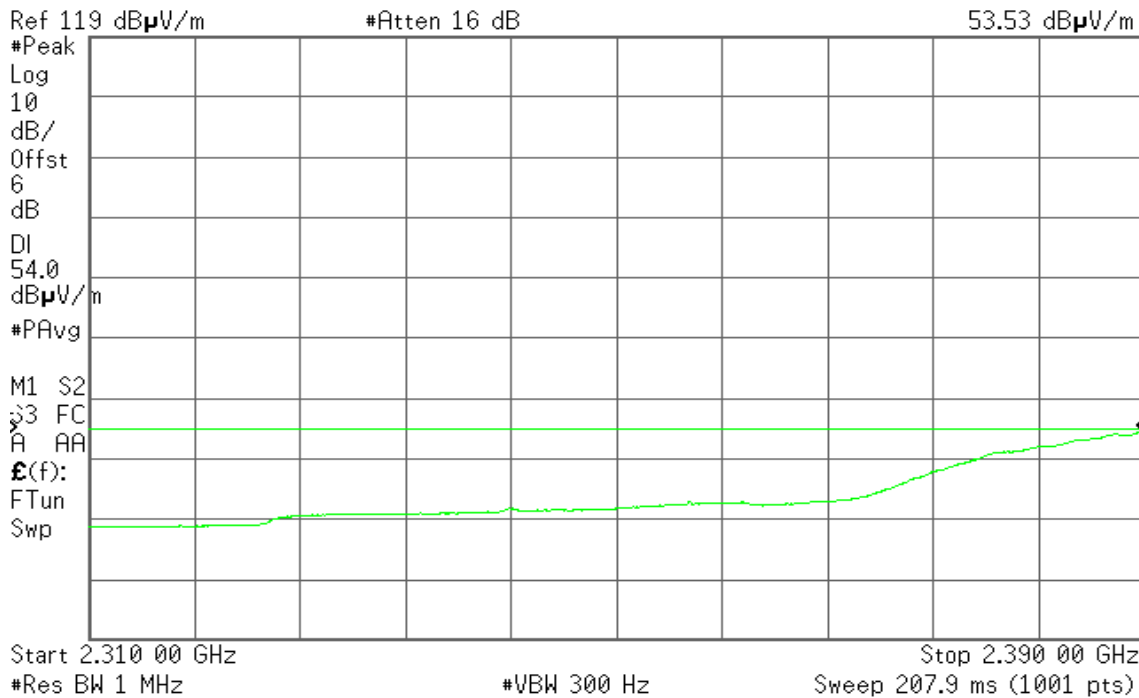



Band Edges (IEEE 802.11n HT 40 MHz mode / CH High)

Detector mode: Peak

Polarity: Vertical

Agilent

R T

Mkr1 2.484 00 GHz
54.30 dB μ V/m

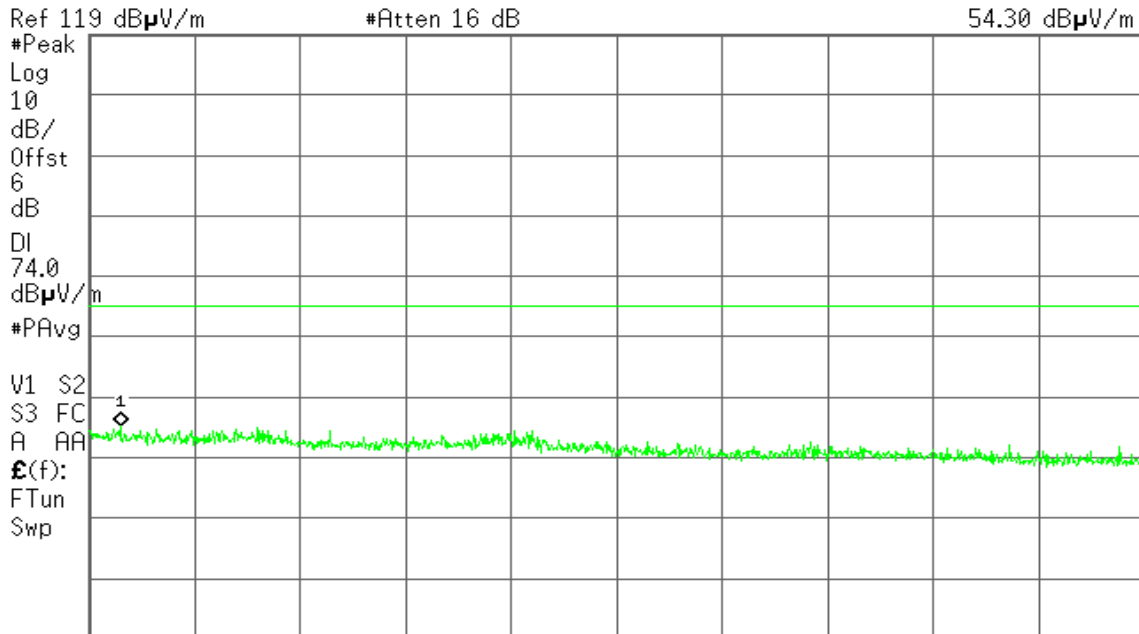

Start 2.483 50 GHz #Res BW 1 MHz #VBW 3 MHz Stop 2.500 00 GHz #Sweep 100 ms (1001 pts)

Detector mode: Average

Polarity: Vertical

Agilent

R T

Mkr1 2.483 57 GHz
42.67 dB μ V/m

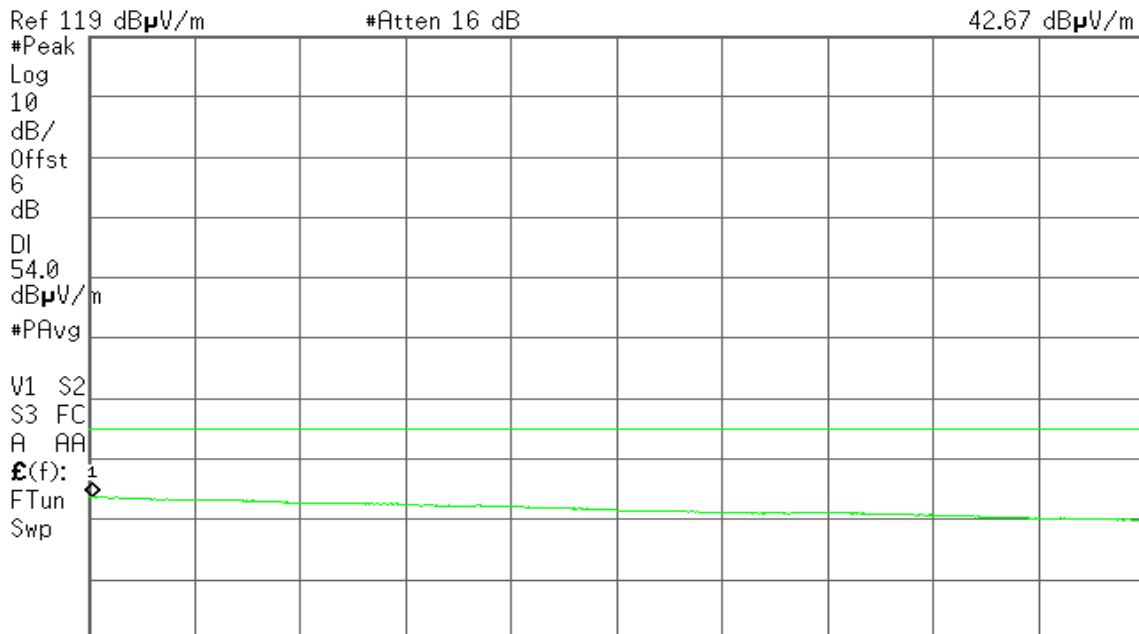

Start 2.483 50 GHz #Res BW 1 MHz #VBW 300 Hz Sweep 42.93 ms (1001 pts)



Detector mode: Peak

Polarity: Horizontal

Agilent

R T

Mkr1 2.483 58 GHz
57.33 dB μ V/m

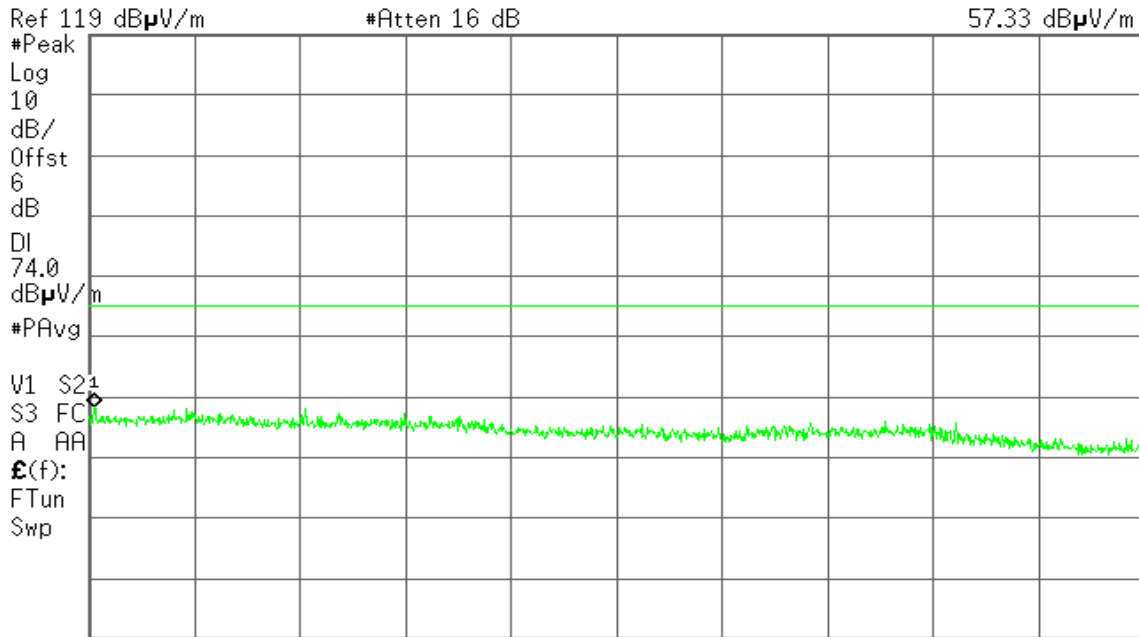

Start 2.483 50 GHz Stop 2.500 00 GHz
#Res BW 1 MHz #VBW 3 MHz #Sweep 100 ms (1001 pts)

Detector mode: Average

Polarity: Horizontal

Agilent

R T

Mkr1 2.483 62 GHz
44.66 dB μ V/m

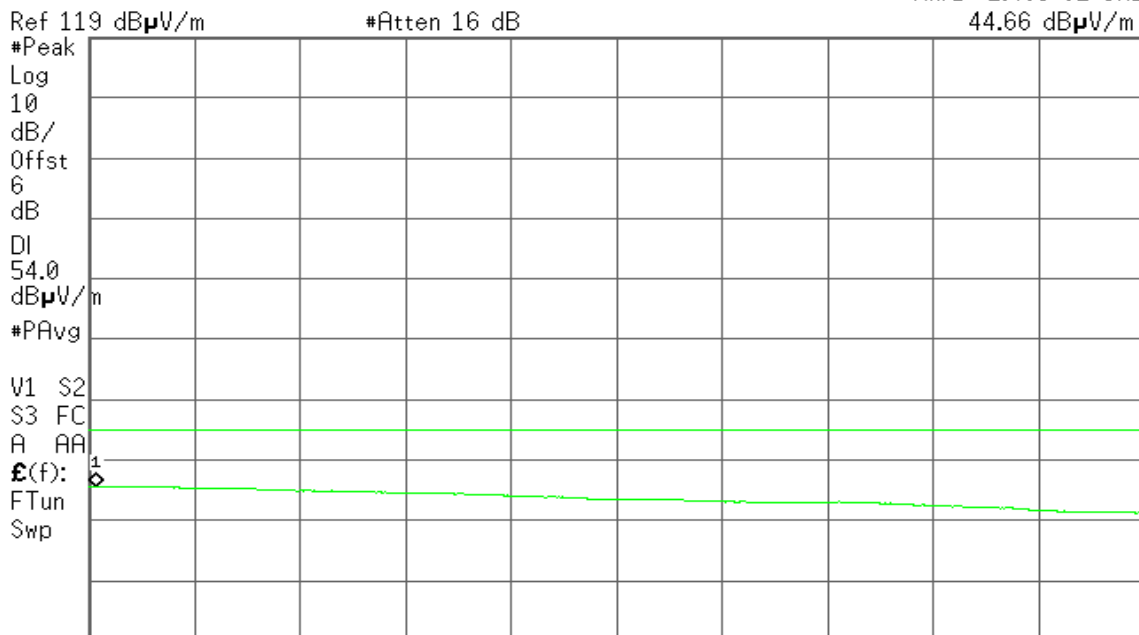

Start 2.483 50 GHz Stop 2.500 00 GHz
#Res BW 1 MHz #VBW 300 Hz Sweep 42.93 ms (1001 pts)



Test Plot
Conducted Band Edges (IEEE 802.11b mode / CH Low)

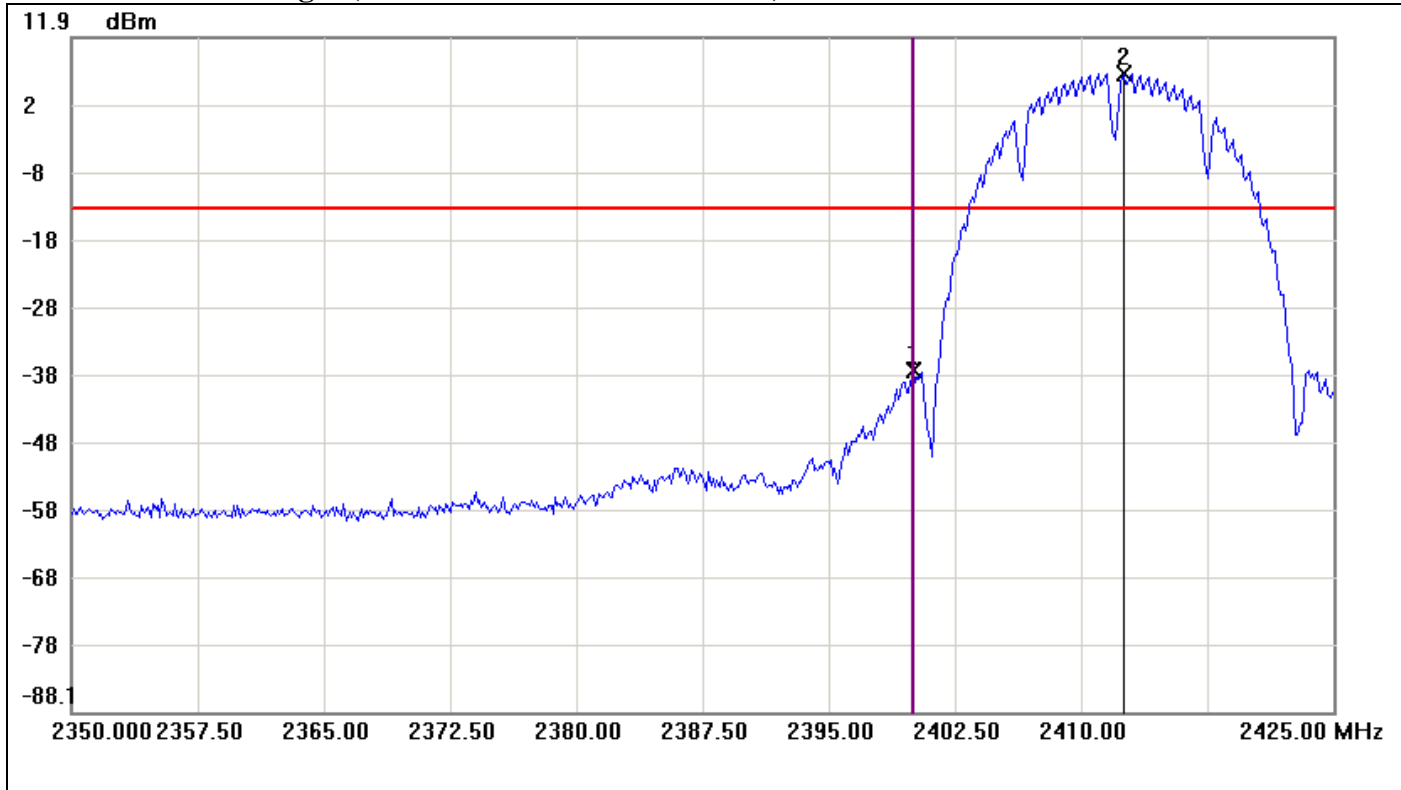

No.	Frequency(MHz)	Result(dBm)	Limit(dBm)	Margin(dBm)
1	2400.0000	-37.51	-13.45	-24.06
2	2412.5000	6.55	-13.45	20.00



Conducted Band Edges (IEEE 802.11b mode / CH High)

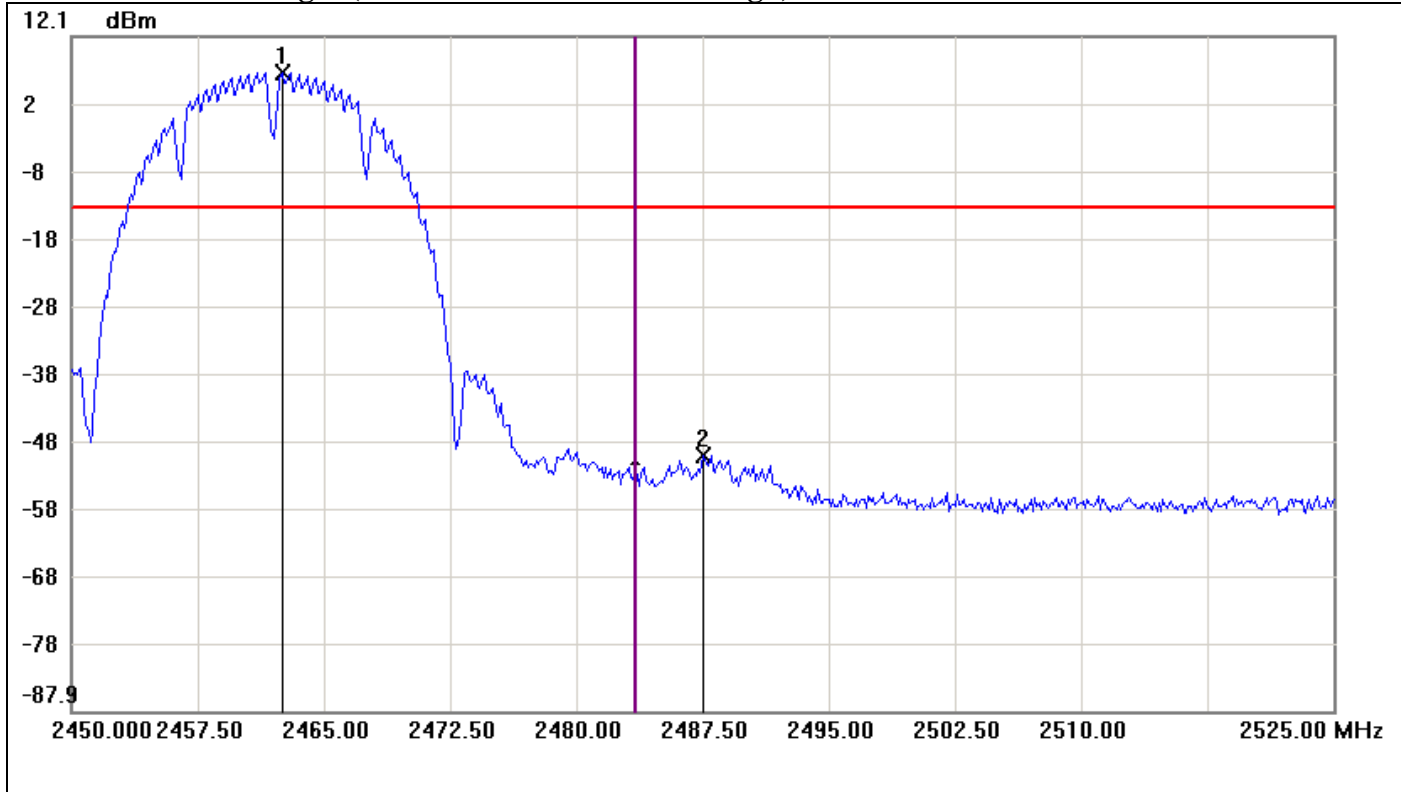

No.	Frequency(MHz)	Result(dBm)	Limit(dBm)	Margin(dBm)
1	2462.5000	6.83	-13.17	20.00
2	2487.5000	-50.09	-13.17	-36.92



Conducted Band Edges (IEEE 802.11g mode / CH Low)

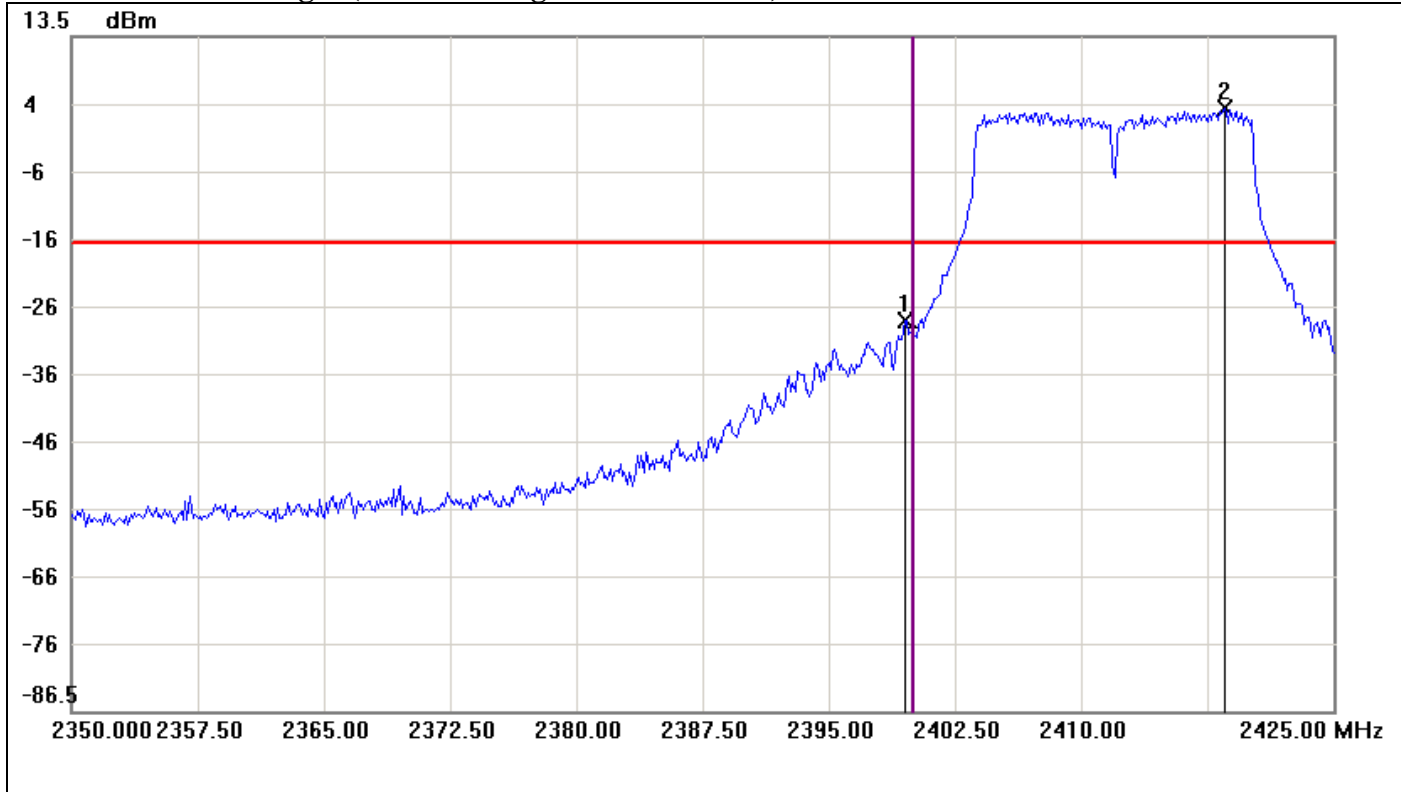

No.	Frequency(MHz)	Result(dBm)	Limit(dBm)	Margin(dBm)
1	2399.5000	-28.71	-17.21	-11.50
2	2418.5000	2.79	-17.21	20.00



Conducted Band Edges (IEEE 802.11g mode / CH High)

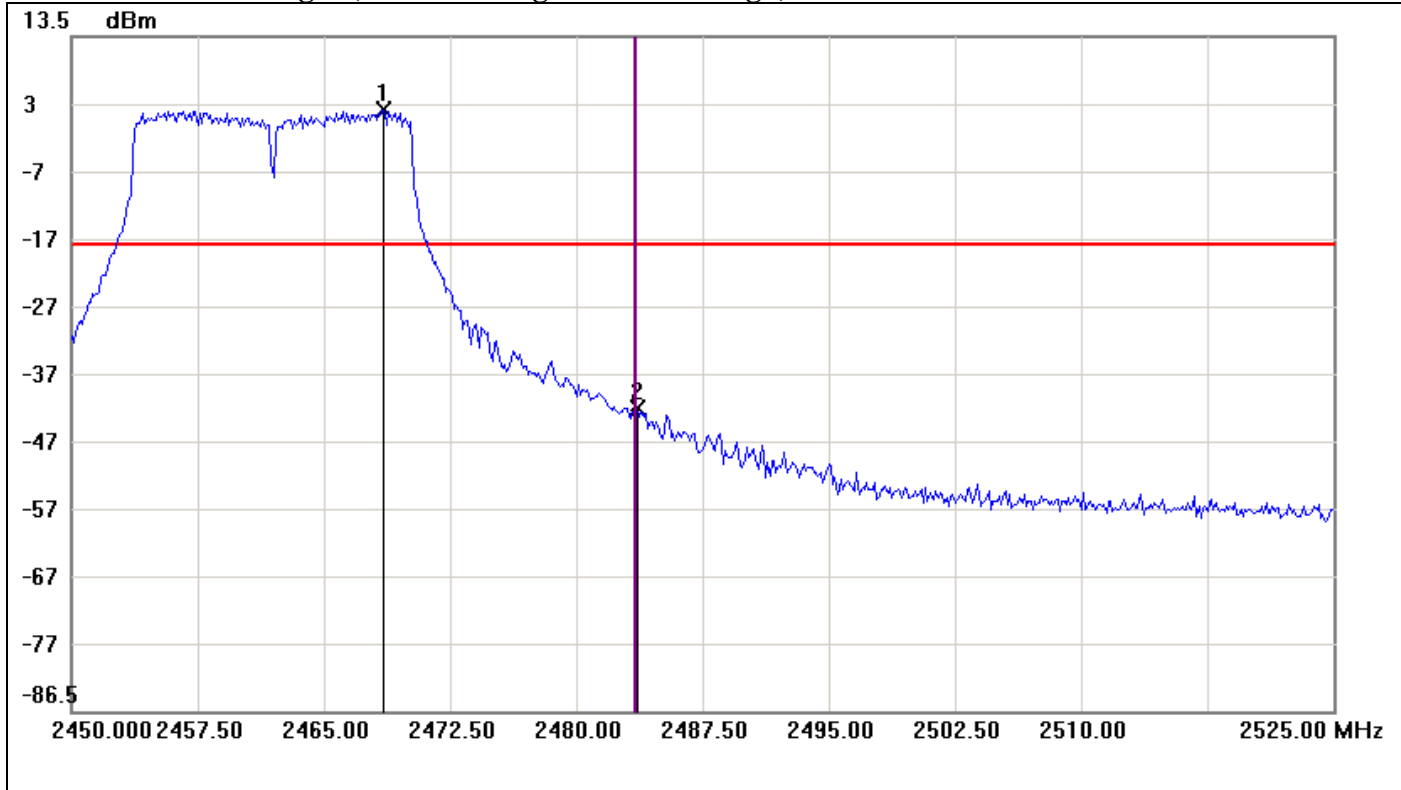

No.	Frequency(MHz)	Result(dBm)	Limit(dBm)	Margin(dBm)
1	2468.5000	2.56	-17.44	20.00
2	2483.6250	-41.74	-17.44	-24.30



Conducted Band Edges (IEEE 802.11n HT 20 MHz mode / CH Low / Chain 0)

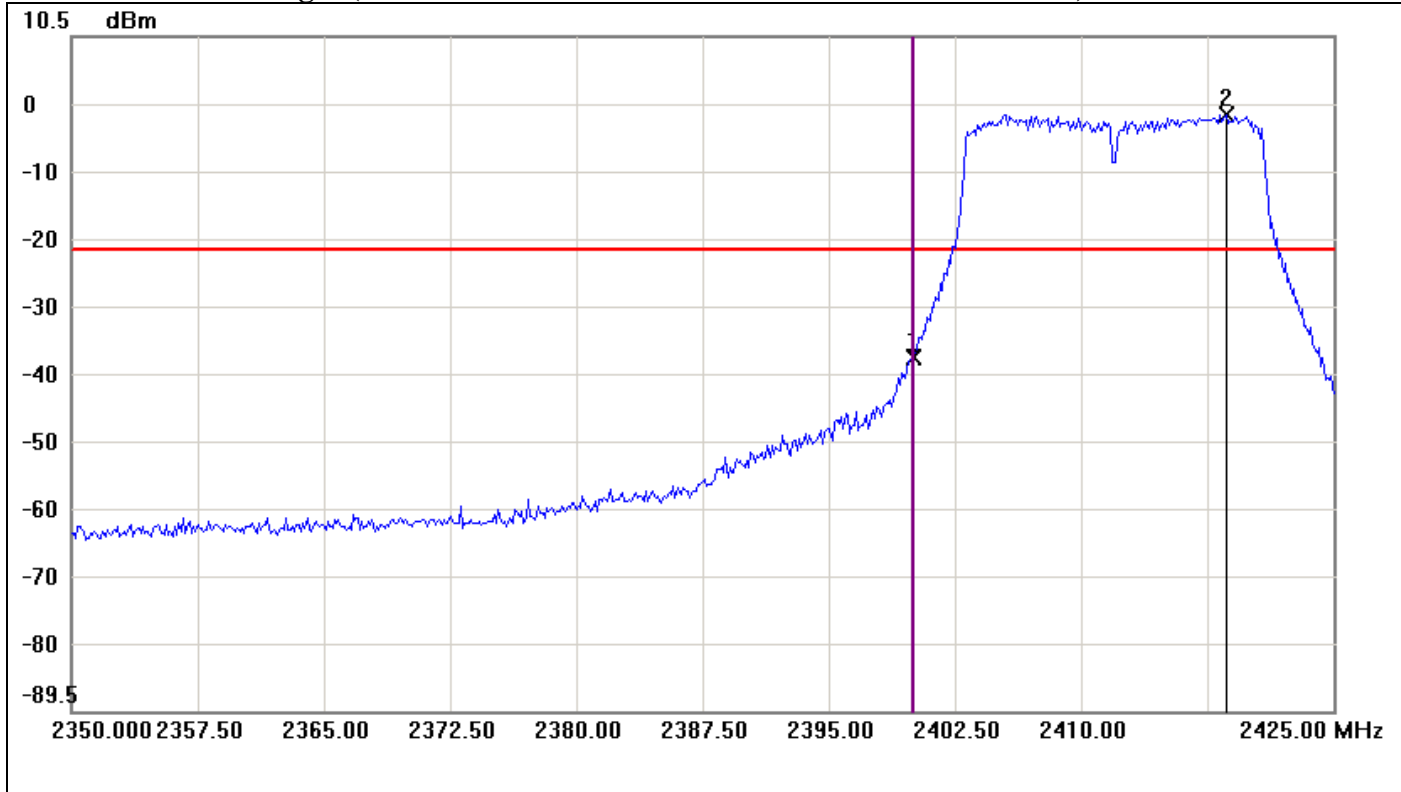

No.	Frequency(MHz)	Result(dBm)	Limit(dBm)	Margin(dBm)
1	2400.0000	-37.23	-21.02	-16.21
2	2418.6250	-1.02	-21.02	20.00



Conducted Band Edges (IEEE 802.11n HT 20 MHz mode / CH High / Chain 0)

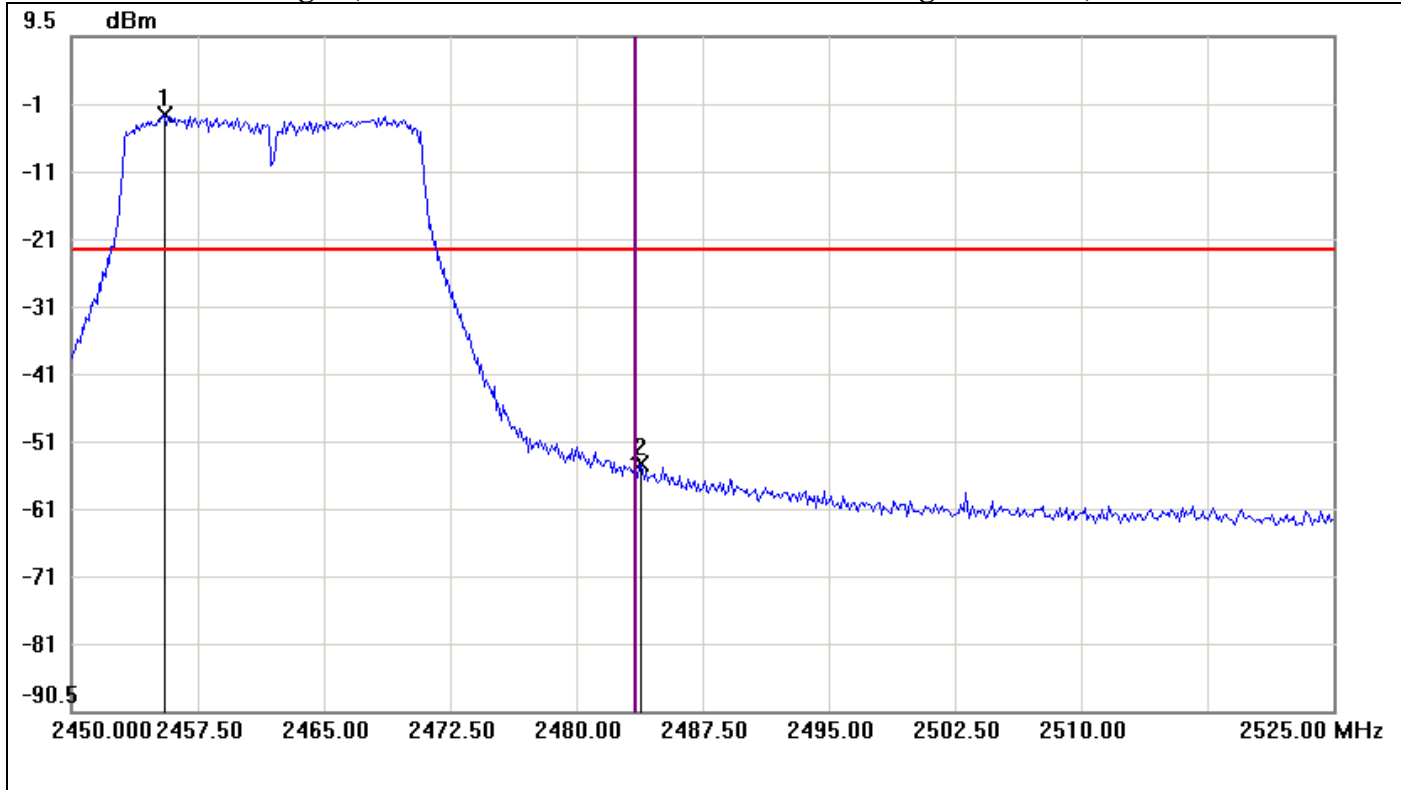

No.	Frequency(MHz)	Result(dBm)	Limit(dBm)	Margin(dBm)
1	2455.5000	-2.10	-22.10	20.00
2	2483.8750	-53.94	-22.10	-31.84



Conducted Band Edges (IEEE 802.11n HT 20 MHz mode / CH Low / Chain 1)

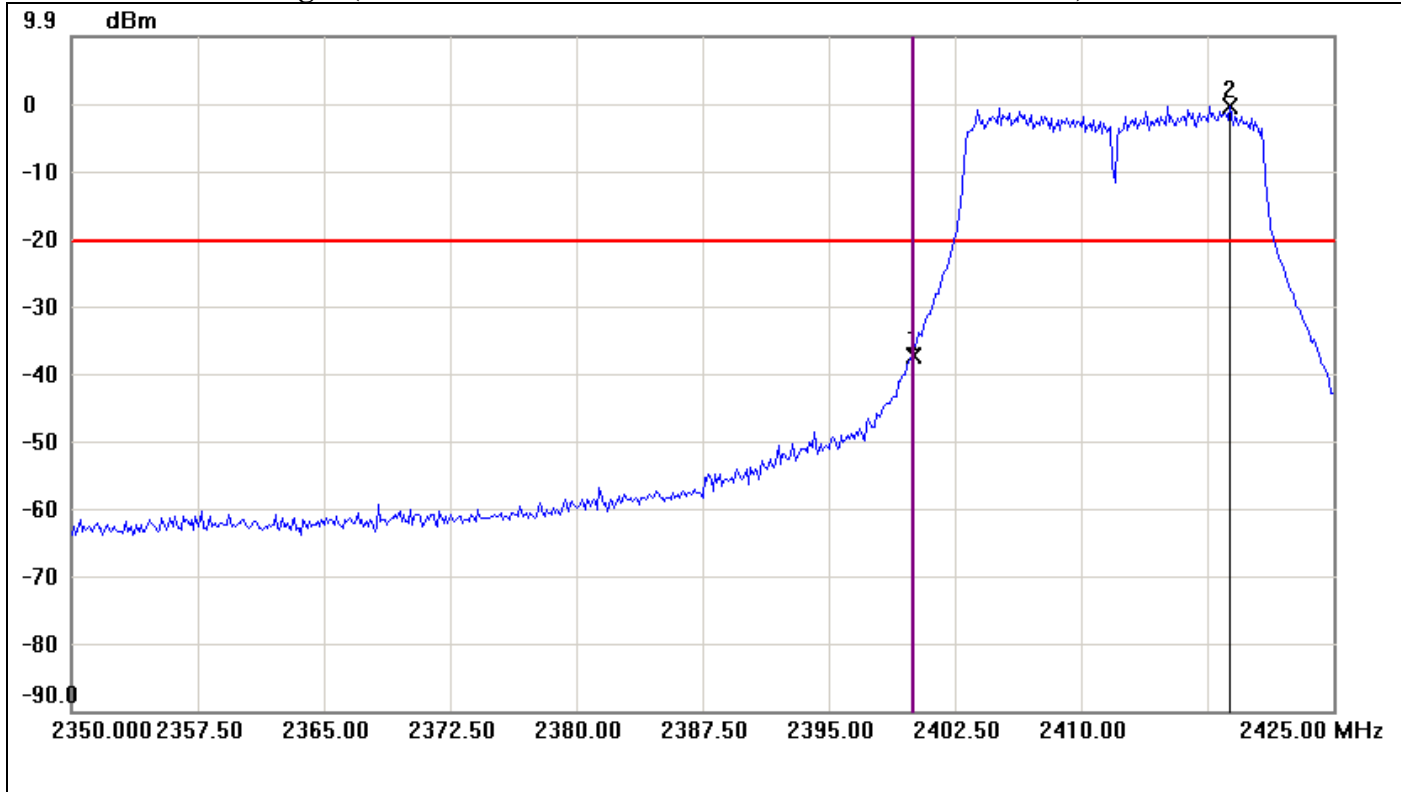

No.	Frequency(MHz)	Result(dBm)	Limit(dBm)	Margin(dBm)
1	2400.0000	-37.52	-20.36	-17.16
2	2418.8750	-0.36	-20.36	20.00



Conducted Band Edges (IEEE 802.11n HT 20 MHz mode / CH High / Chain 1)

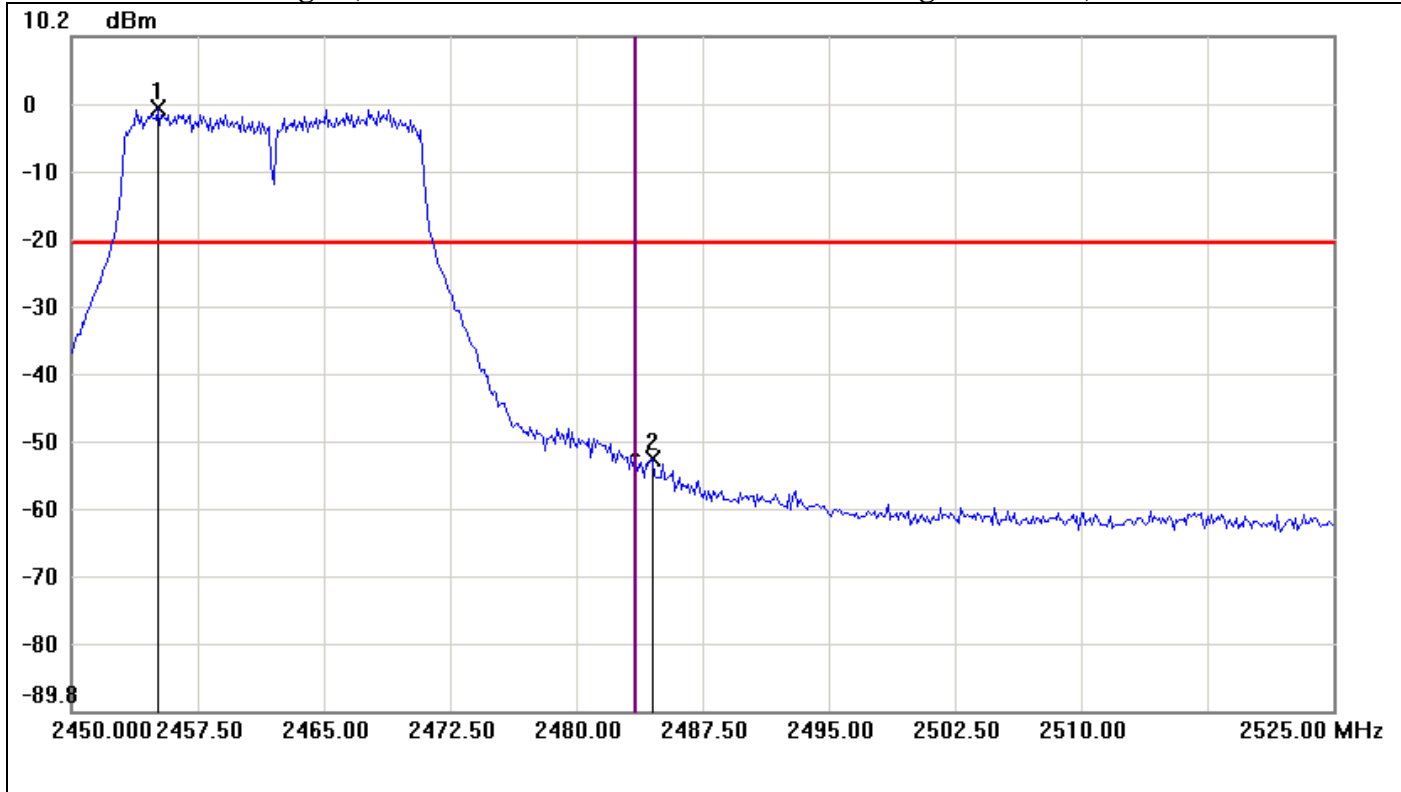

No.	Frequency(MHz)	Result(dBm)	Limit(dBm)	Margin(dBm)
1	2455.1250	-0.43	-20.43	20.00
2	2484.5000	-52.51	-20.43	-32.08



Conducted Band Edges (IEEE 802.11n HT 40 MHz mode / CH Low / Chain 0)

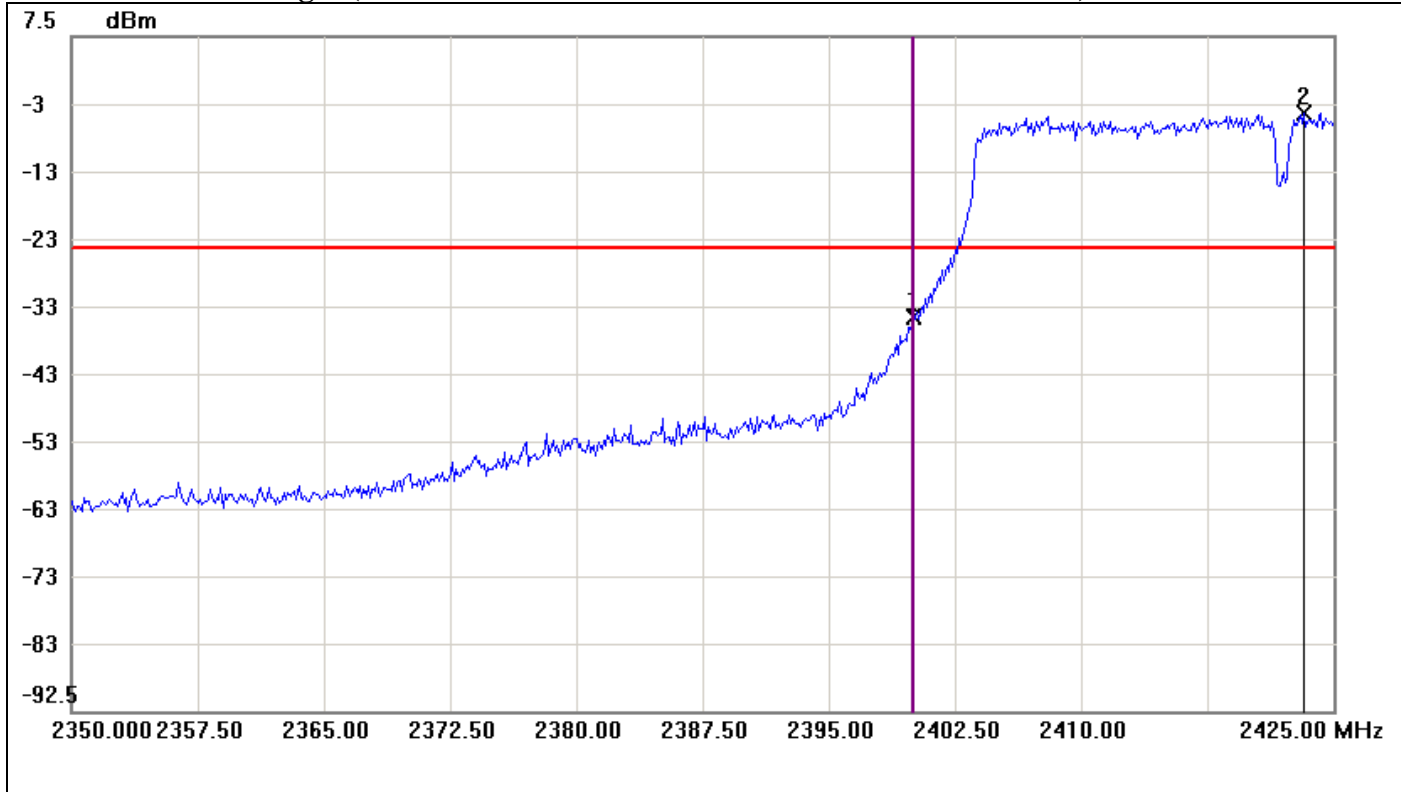

No.	Frequency(MHz)	Result(dBm)	Limit(dBm)	Margin(dBm)
1	2400.0000	-34.24	-23.94	-10.30
2	2423.2500	-3.94	-23.94	20.00



Conducted Band Edges (IEEE 802.11n HT 40 MHz mode / CH High / Chain 0)

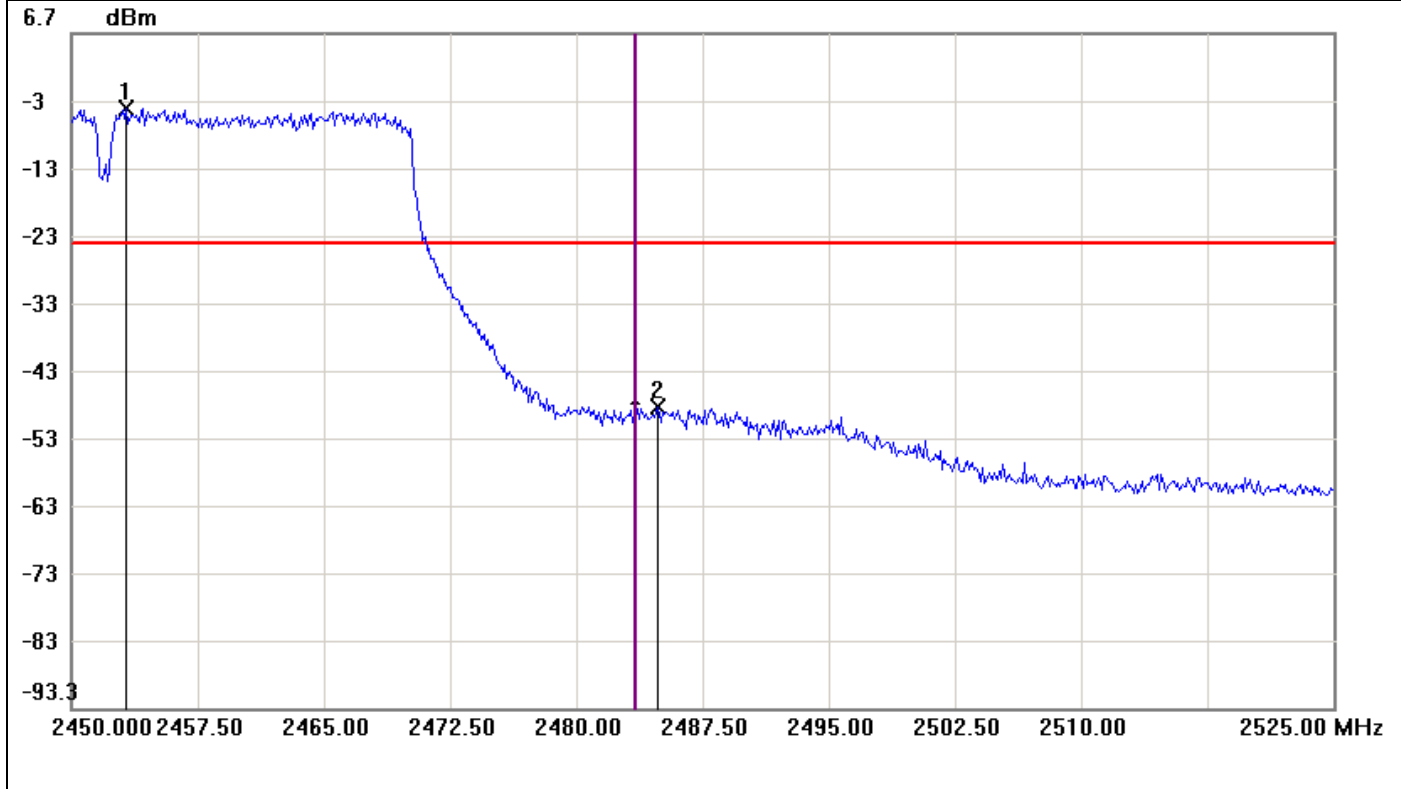

No.	Frequency(MHz)	Result(dBm)	Limit(dBm)	Margin(dBm)
1	2453.2500	-4.42	-24.42	20.00
2	2484.8750	-48.82	-24.42	-24.40



Conducted Band Edges (IEEE 802.11n HT 40 MHz mode / CH Low / Chain 1)

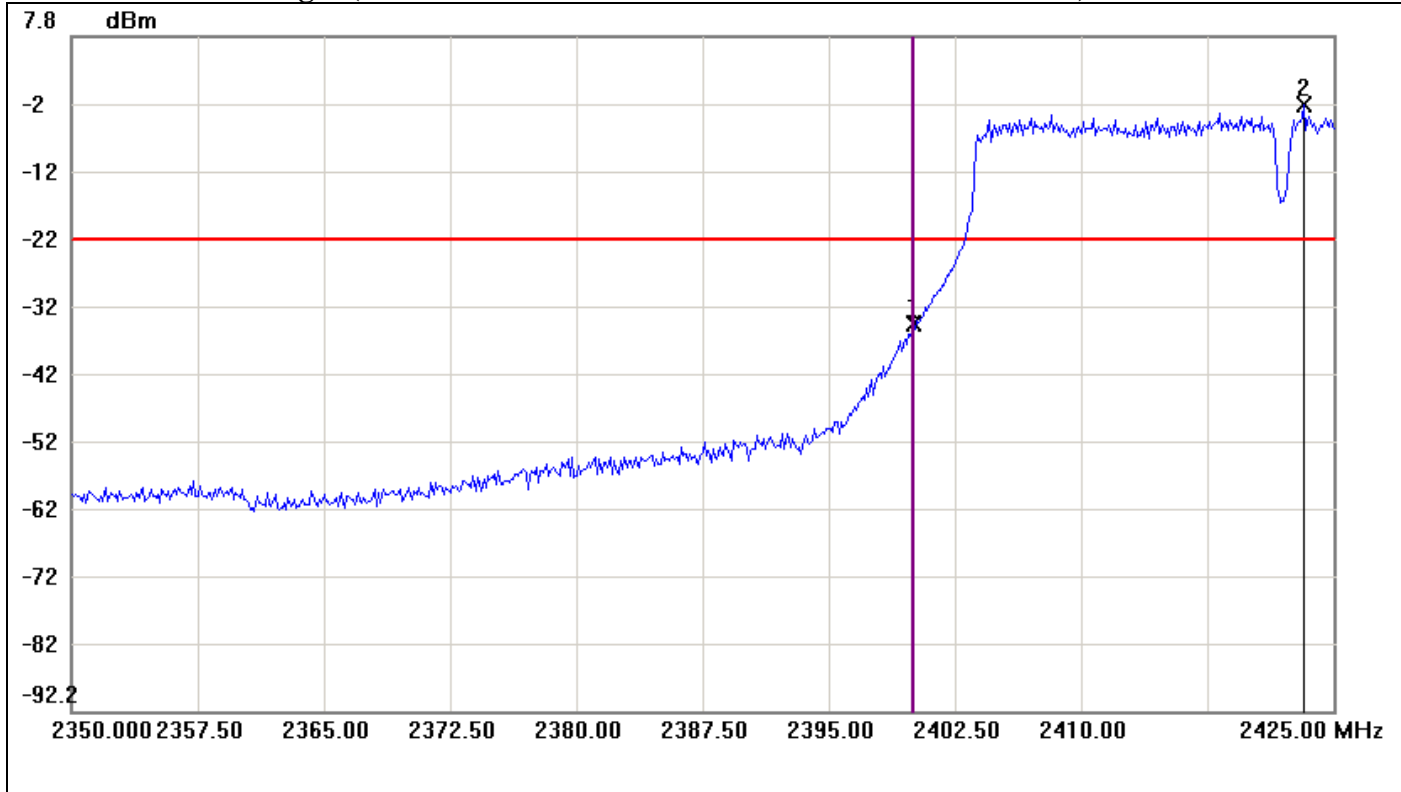

No.	Frequency(MHz)	Result(dBm)	Limit(dBm)	Margin(dBm)
1	2400.0000	-34.88	-22.40	-12.48
2	2423.2500	-2.40	-22.40	20.00



Conducted Band Edges (IEEE 802.11n HT 40 MHz mode / CH High / Chain 1)

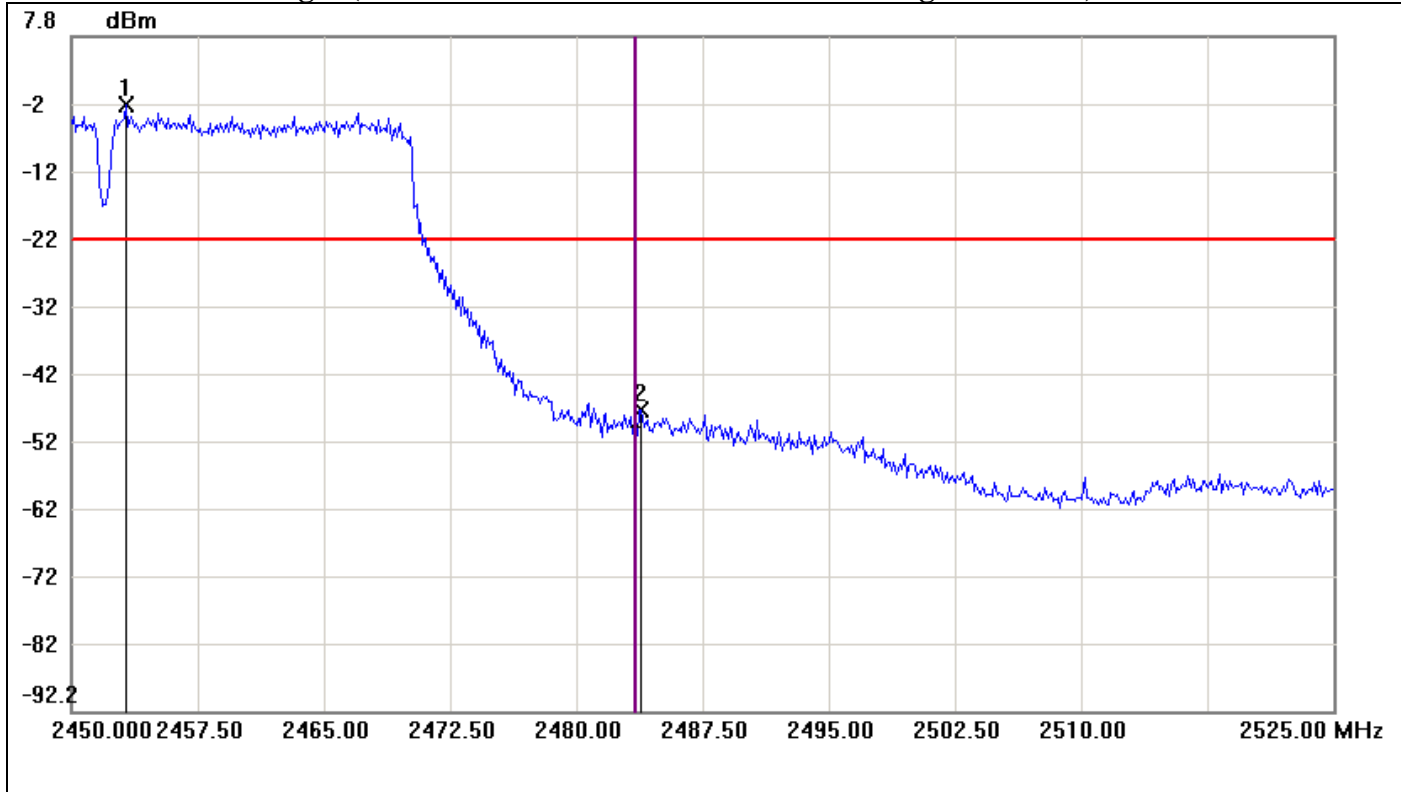

No.	Frequency(MHz)	Result(dBm)	Limit(dBm)	Margin(dBm)
1	2453.2500	-2.34	-22.34	20.00
2	2483.8750	-47.48	-22.34	-25.14



8.5 PEAK POWER SPECTRAL DENSITY

LIMIT

1. According to §15.247(e) & RSS-210 §A8.2, for digitally modulated systems, the power spectral density conducted from the intentional radiator to the antenna shall not be greater than 8 dBm in any 3 kHz band during any time interval of continuous transmission.
2. According to §15.247(f) & RSS-210 §A8.3, the digital modulation operation of the hybrid system, with the frequency hopping turned off, shall comply with the power density requirements of paragraph (d) of this section.

Test Configuration

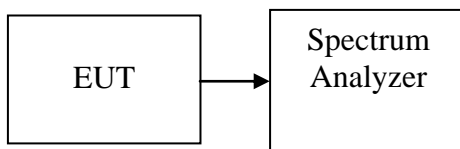

TEST PROCEDURE

1. Place the EUT on the table and set it in transmitting mode.
Remove the antenna from the EUT and then connect a low loss RF cable from the antenna port to the spectrum analyzer.
2. Set the spectrum analyzer as RBW=10kHz,VBW=100kHz,Span=1.5 times bandwidth,Sweep=auto
3. Record the max. reading.
4. Repeat the above procedure until the measurements for all frequencies are completed.

TEST RESULTS

No non-compliance noted



Test Data

Test mode: IEEE 802.11b mode

Channel	Frequency (MHz)	PPSD (dBm)	Limit (dBm)	Result
Low	2412	-3.12	8.00	PASS
Mid	2437	-2.85		PASS
High	2462	-2.91		PASS

Test mode: IEEE 802.11g mode

Channel	Frequency (MHz)	PPSD (dBm)	Limit (dBm)	Result
Low	2412	-4.67	8.00	PASS
Mid	2437	-4.39		PASS
High	2462	-4.92		PASS

Test mode: IEEE 802.11n HT 20 MHz mode

Channel	Frequency (MHz)	Chain 0 PPSD (dBm)	Chain 1 PPSD (dBm)	PPSD (dBm)	Limit (dBm)	Result
Low	2412	-7.86	-8.22	-5.03	3.7	PASS
Mid	2437	-7.63	-7.86	-4.73		PASS
High	2462	-8.90	-7.95	-5.39		PASS

Test mode: IEEE 802.11n HT 40 MHz mode

Channel	Frequency (MHz)	Chain 0 PPSD (dBm)	Chain 1 PPSD (dBm)	PPSD (dBm)	Limit (dBm)	Result
Low	2422	-9.32	-11.26	-7.17	3.7	PASS
Mid	2437	-10.80	-11.15	-7.96		PASS
High	2452	-10.97	-11.27	-8.11		PASS

Remark: 1. Total PPSD (dBm) = $10 * \text{LOG}(10^{\text{Chain 0 PPSD} / 10} + 10^{\text{Chain 1 PPSD} / 10})$

2. The maximum antenna gain is 6.37dBi; therefore the reduction due to antenna gain is 4.3dBi, so the limit is 3.7dBm



Test Plot

IEEE 802.11b mode

PPSD (CH Low)

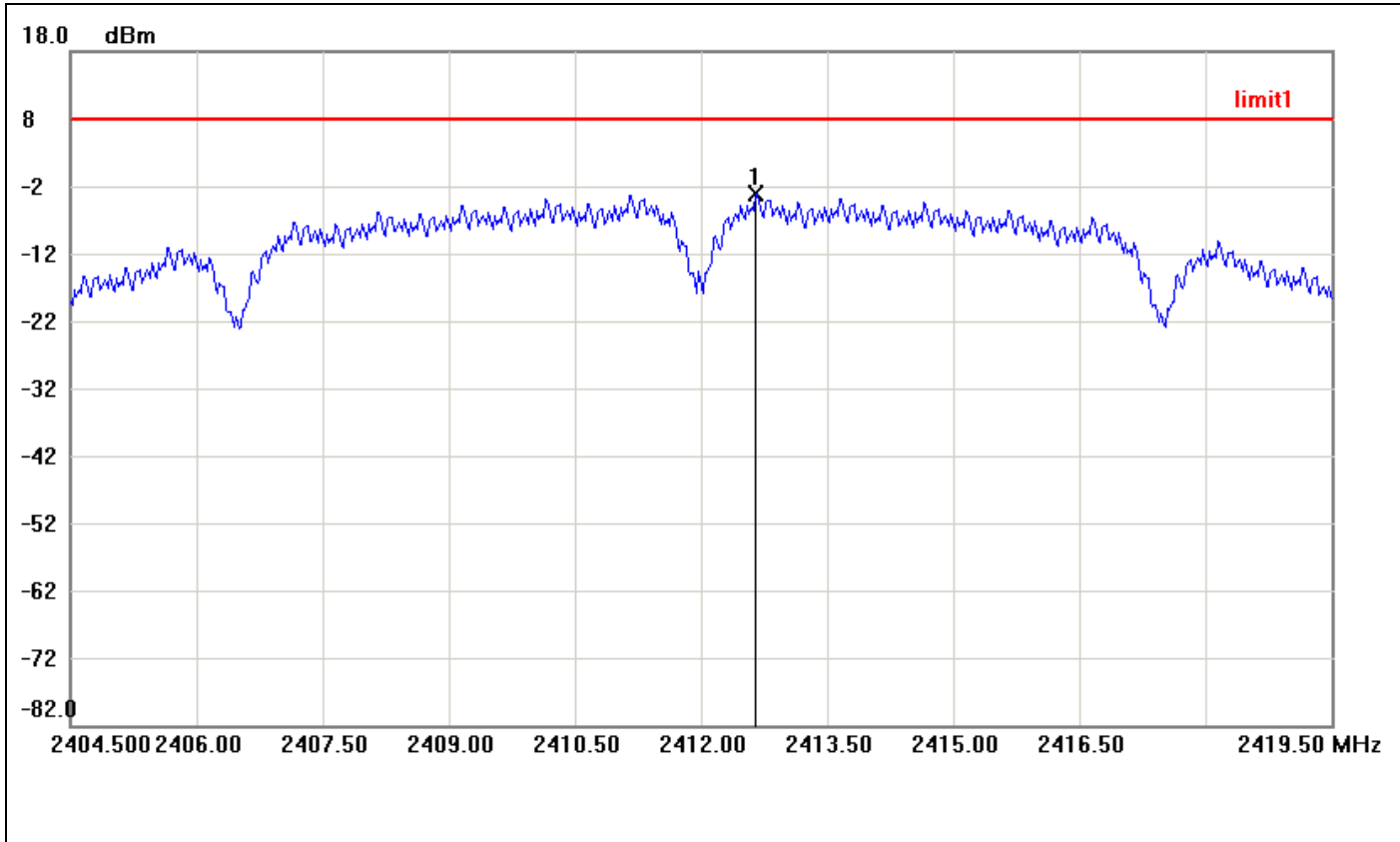

No.	Frequency(MHz)	Result(dBm)	Limit(dBm)	Margin(dBm)
1	2412.6500	-3.12	8.00	-11.12



PPSD (CH Mid)

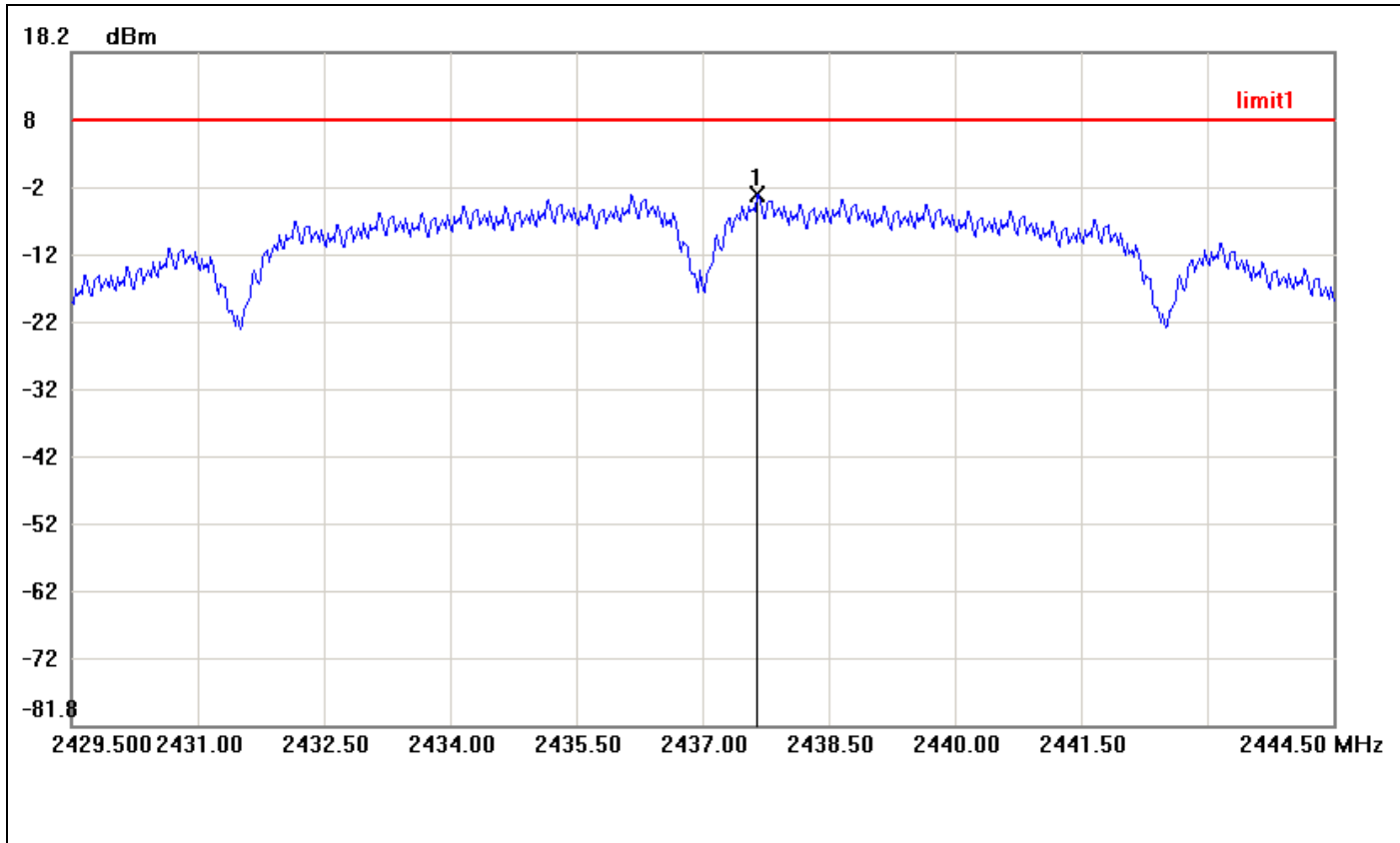

No.	Frequency(MHz)	Result(dBm)	Limit(dBm)	Margin(dBm)
1	2437.6500	-2.85	8.00	-10.85



PPSD (CH High)

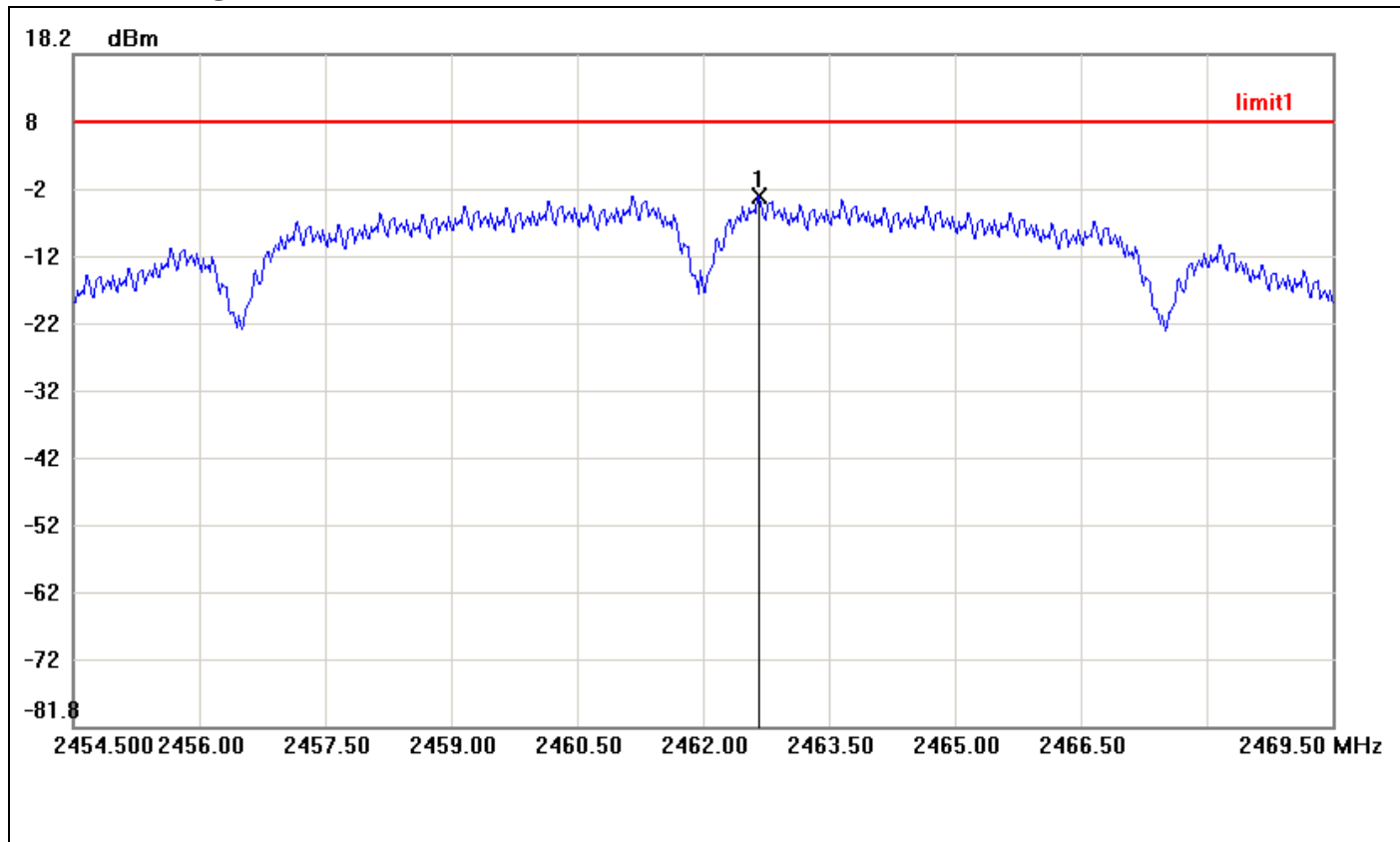

No.	Frequency(MHz)	Result(dBm)	Limit(dBm)	Margin(dBm)
1	2462.6750	-2.91	8.00	-10.91



IEEE 802.11g mode

PPSD (CH Low)

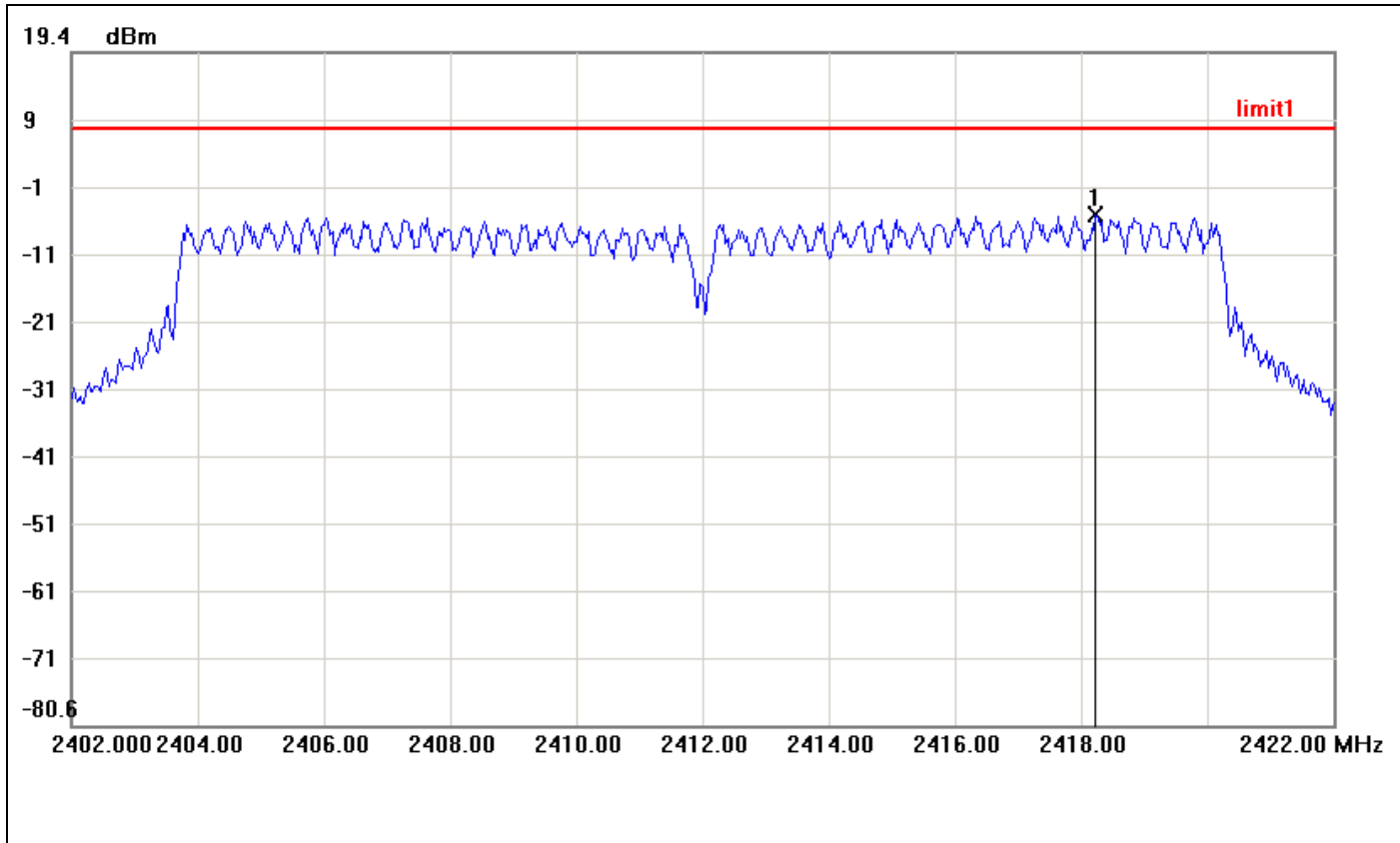

No.	Frequency(MHz)	Result(dBm)	Limit(dBm)	Margin(dBm)
1	2418.2333	-4.67	8.00	-12.67



PPSD (CH Mid)

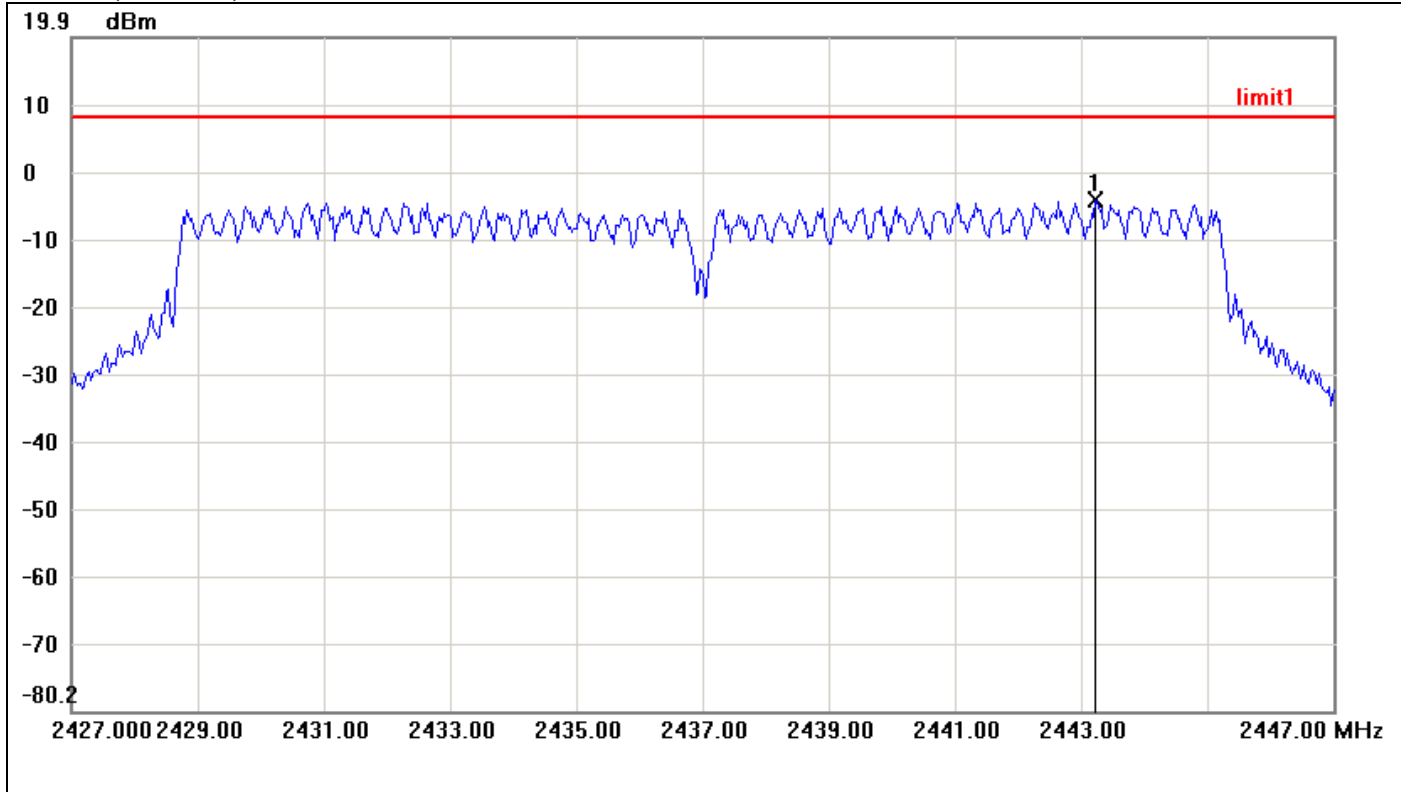

No.	Frequency(MHz)	Result(dBm)	Limit(dBm)	Margin(dBm)
1	2443.2333	-4.39	8.00	-12.39



PPSD (CH High)

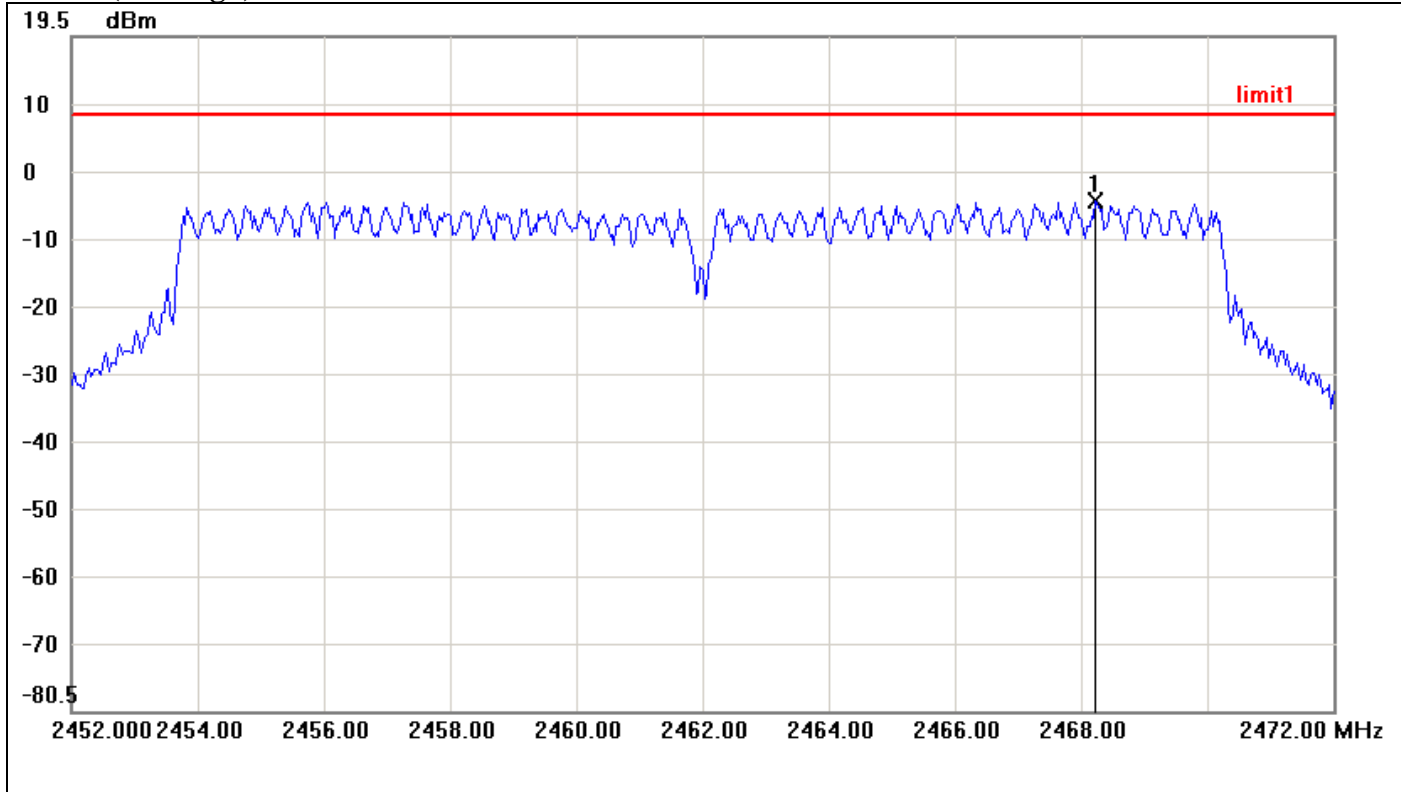

No.	Frequency(MHz)	Result(dBm)	Limit(dBm)	Margin(dBm)
1	2468.2333	-4.92	8.00	-12.92



IEEE 802.11n HT 20 MHz mode / Chain 0

PPSD (CH Low)

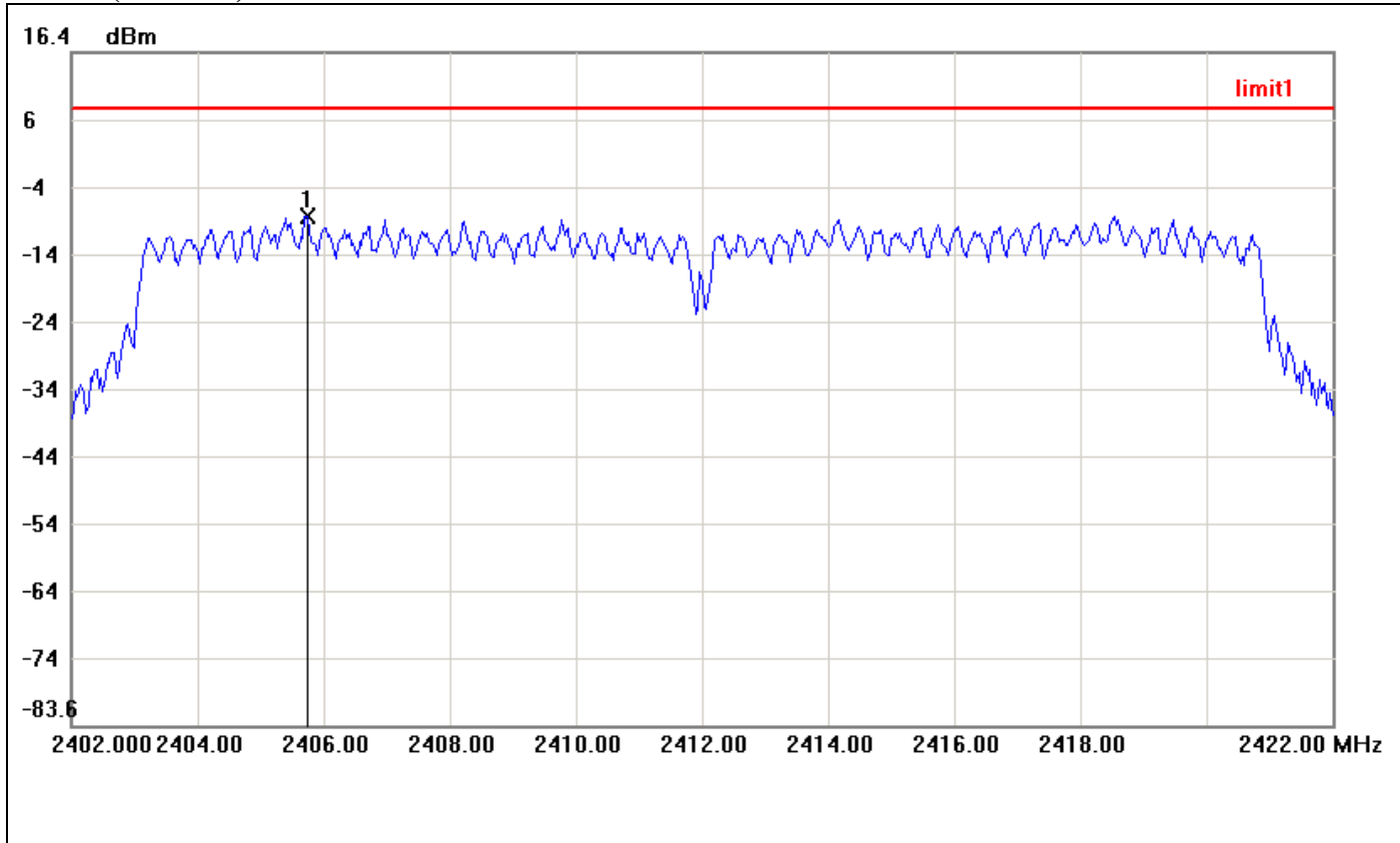

No.	Frequency(MHz)	Result(dBm)	Limit(dBm)	Margin(dBm)
1	2405.7333	-7.86	8.00	-15.86



PPSD (CH Mid)

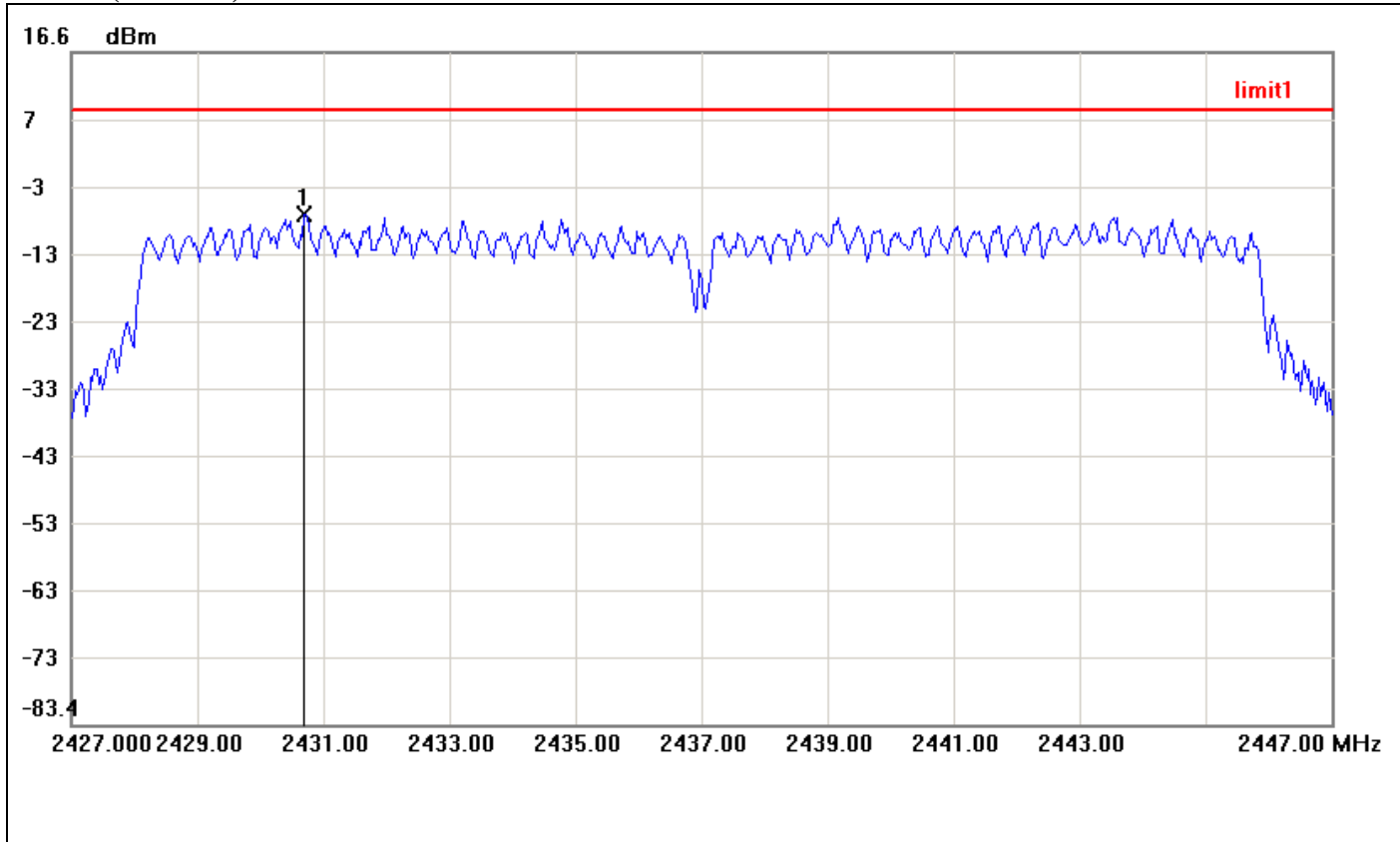

No.	Frequency(MHz)	Result(dBm)	Limit(dBm)	Margin(dBm)
1	2430.7000	-7.63	8.00	-15.63



PPSD (CH High)

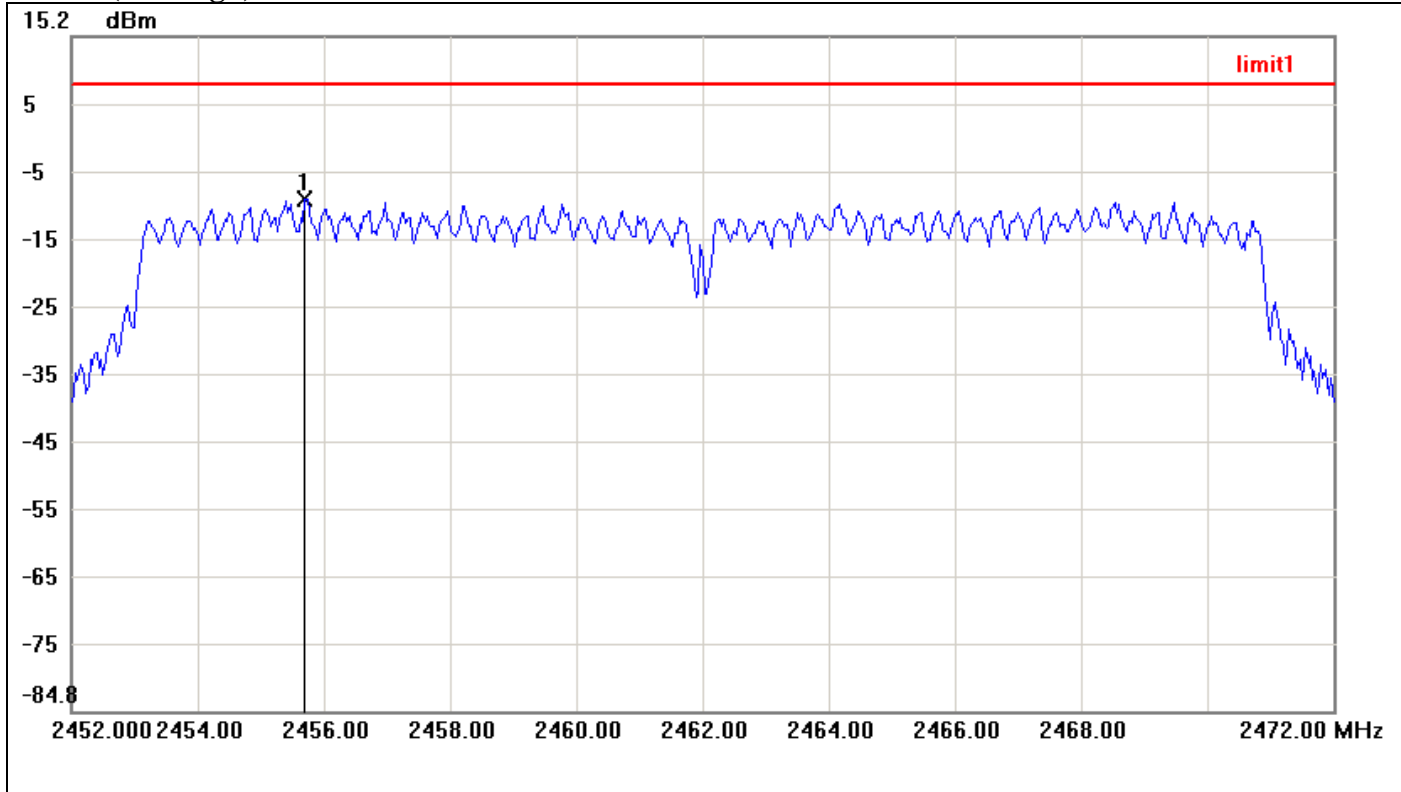

No.	Frequency(MHz)	Result(dBm)	Limit(dBm)	Margin(dBm)
1	2455.7000	-8.90	8.00	-16.90



IEEE 802.11n HT 20 MHz mode / Chain 1

PPSD (CH Low)

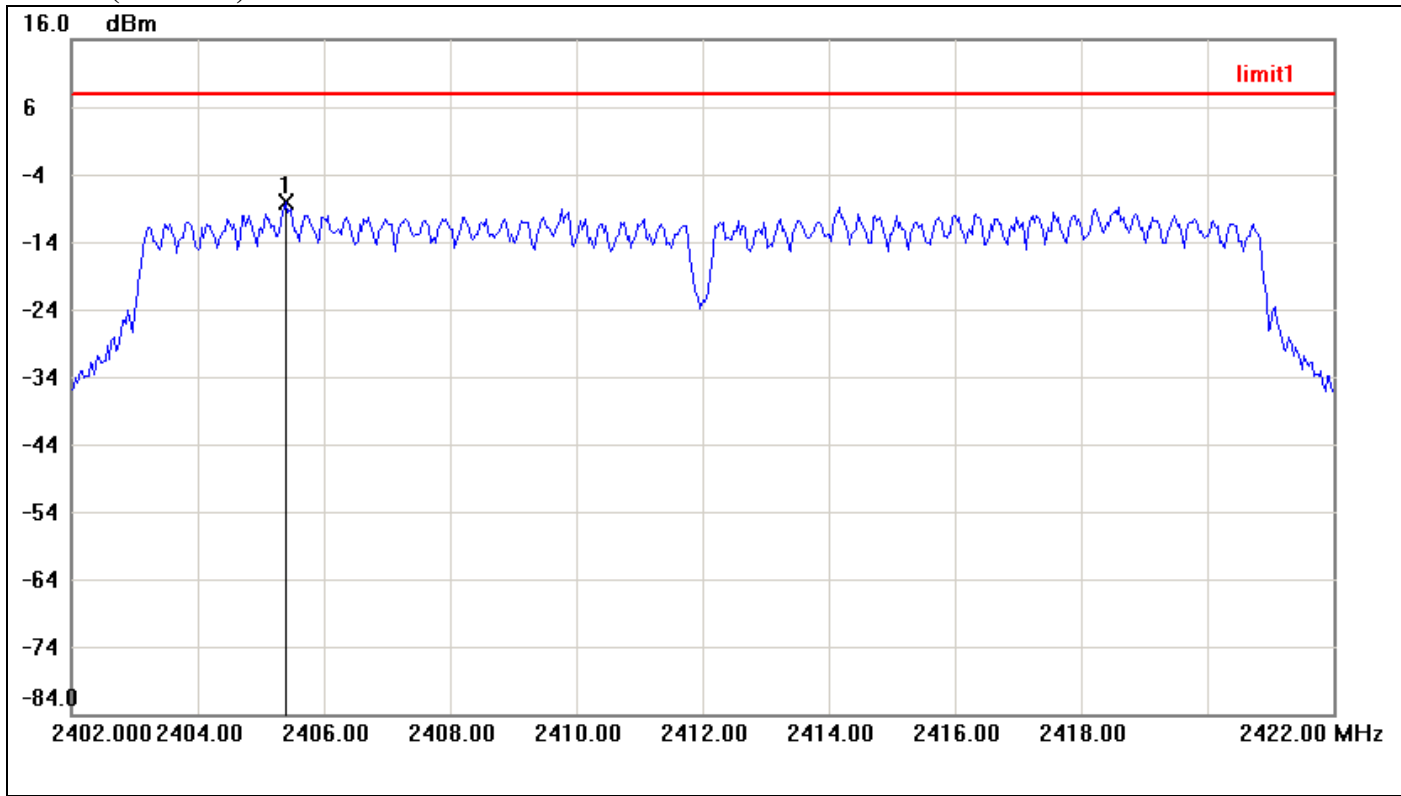

No.	Frequency(MHz)	Result(dBm)	Limit(dBm)	Margin(dBm)
1	2405.4000	-8.22	8.00	-16.22



PPSD (CH Mid)

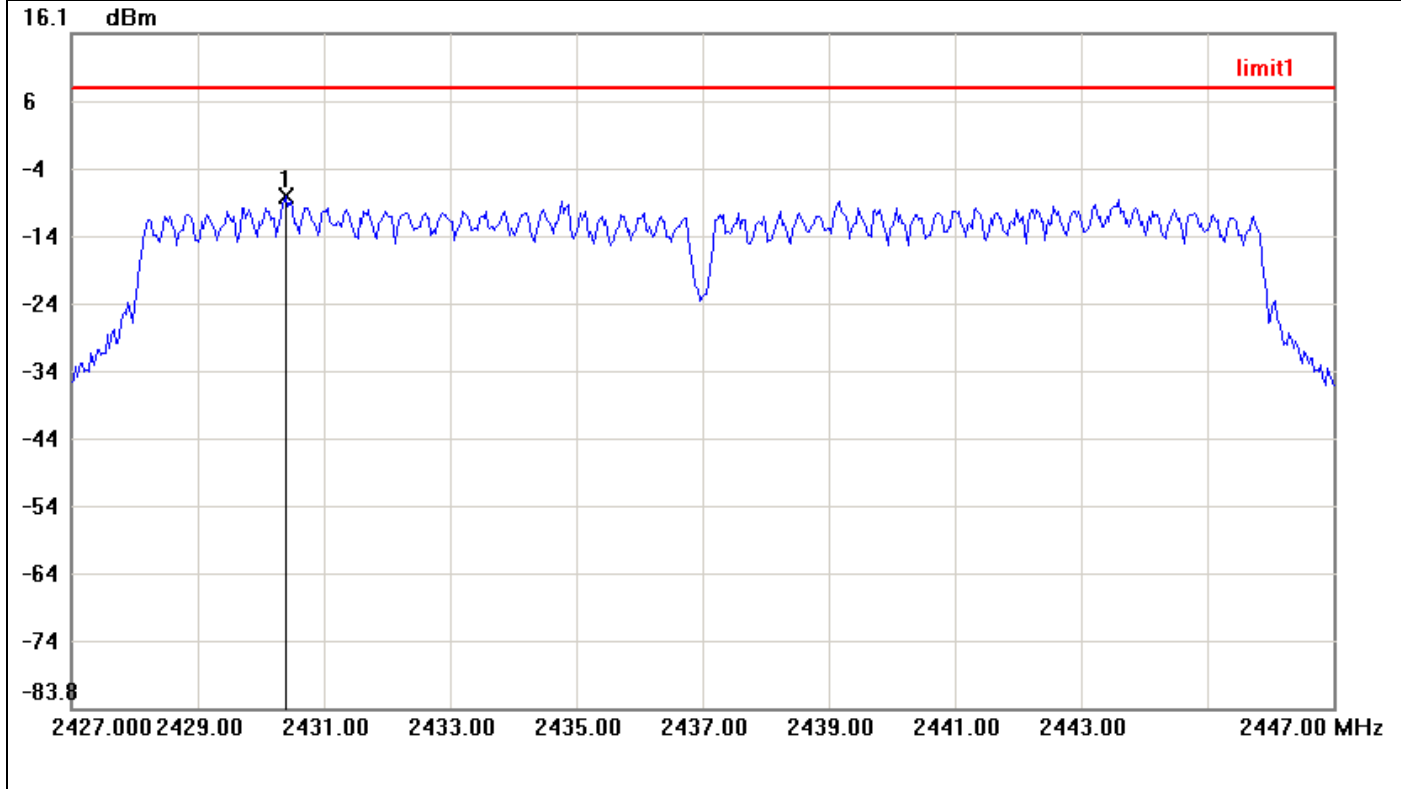

No.	Frequency(MHz)	Result(dBm)	Limit(dBm)	Margin(dBm)
1	2430.4000	-7.86	8.00	-15.86



PPSD (CH High)

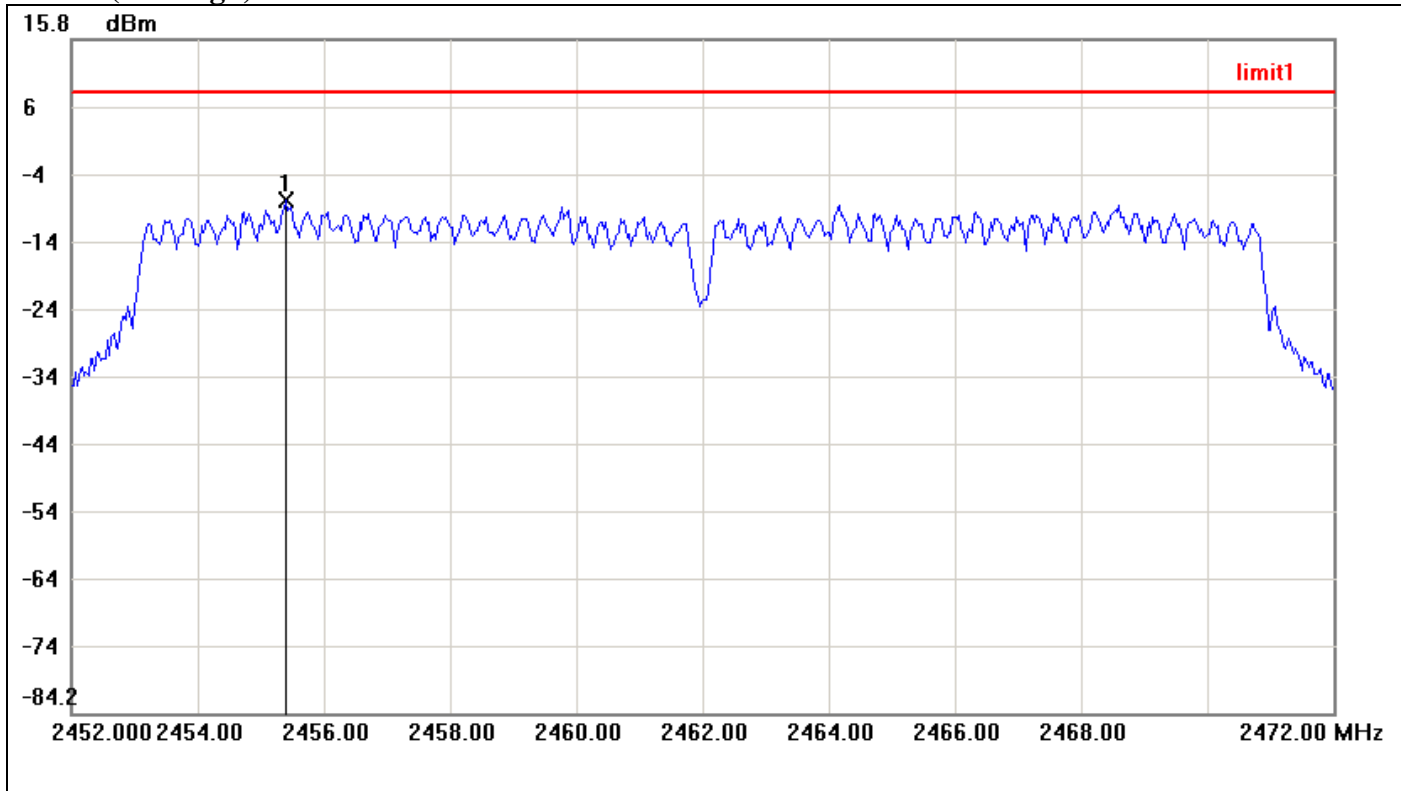

No.	Frequency(MHz)	Result(dBm)	Limit(dBm)	Margin(dBm)
1	2455.4000	-7.95	8.00	-15.95



IEEE 802.11n HT 40 MHz mode / Chain 0

PPSD (CH Low)

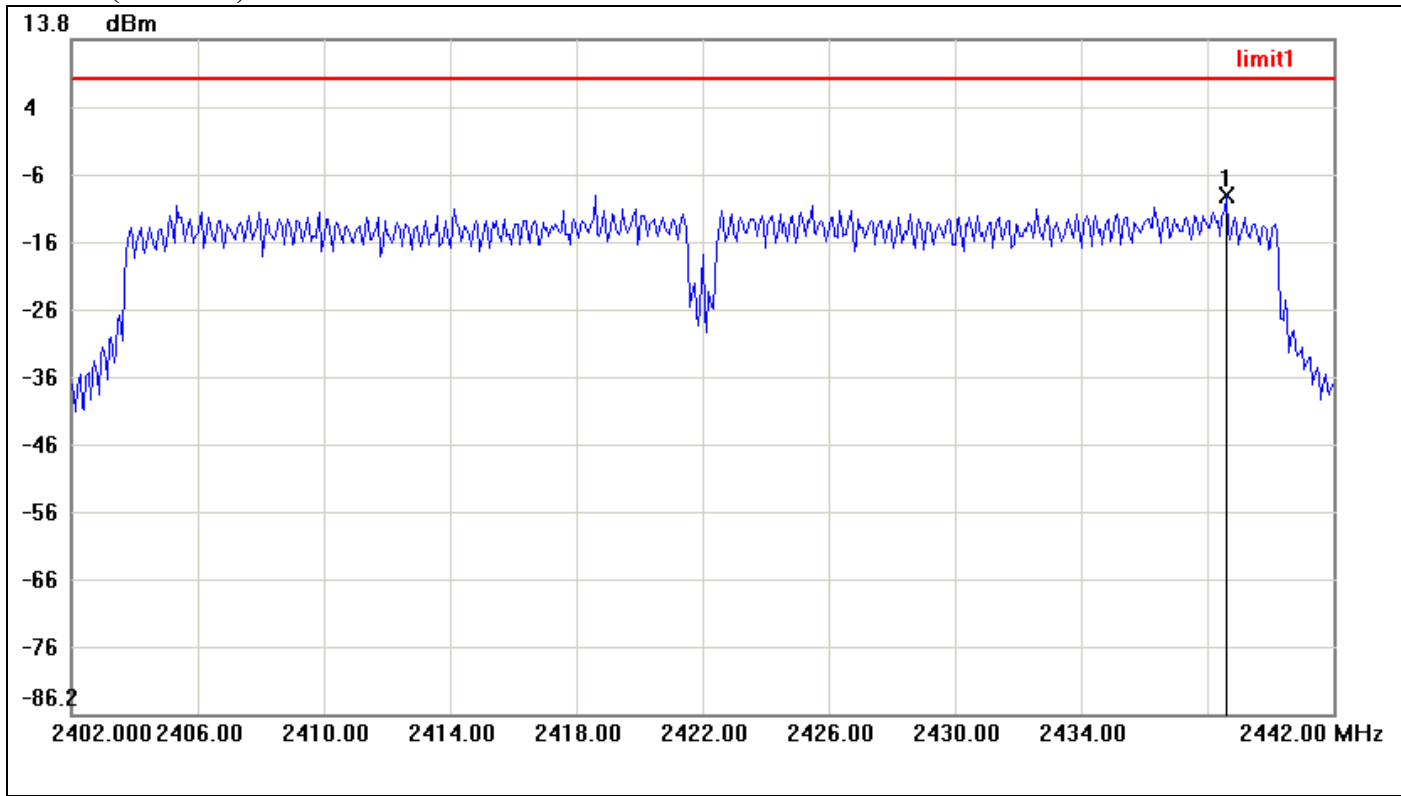

No.	Frequency(MHz)	Result(dBm)	Limit(dBm)	Margin(dBm)
1	2438.6000	-9.32	8.00	-17.32



PPSD (CH Mid)

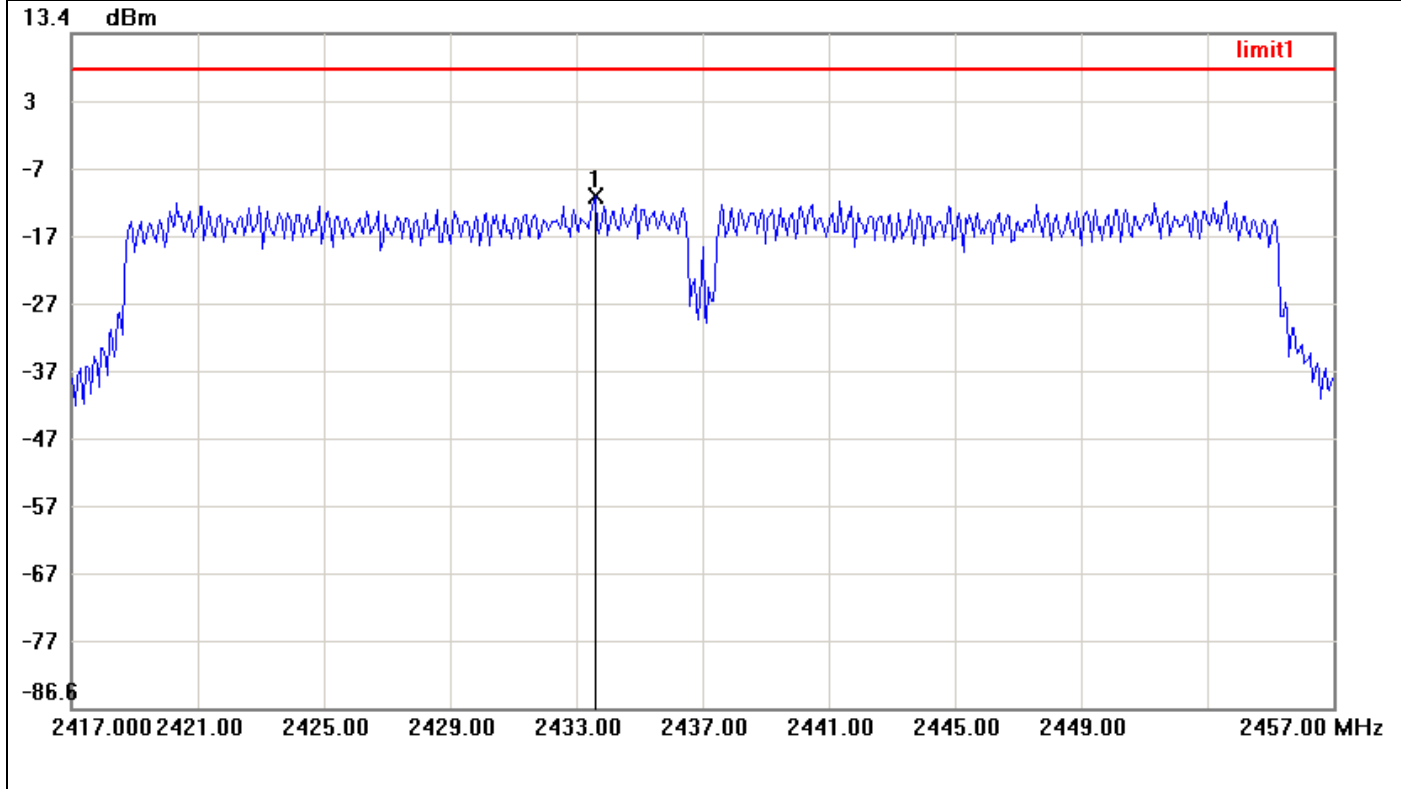

No.	Frequency(MHz)	Result(dBm)	Limit(dBm)	Margin(dBm)
1	2433.6000	-10.80	8.00	-18.80



PPSD (CH High)

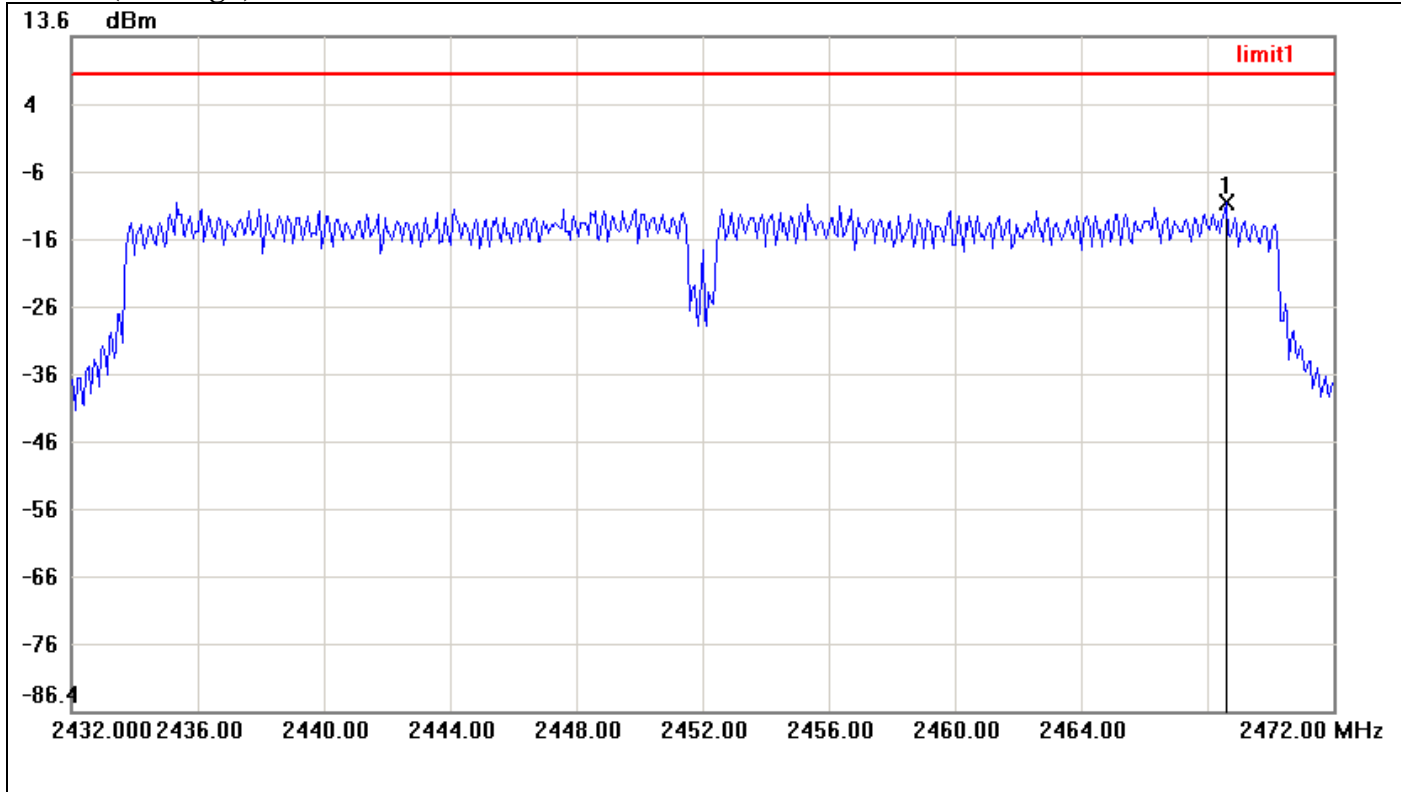

No.	Frequency(MHz)	Result(dBm)	Limit(dBm)	Margin(dBm)
1	2468.6000	-10.97	8.00	-18.97



IEEE 802.11n HT 40 MHz mode / Chain 1

PPSD (CH Low)

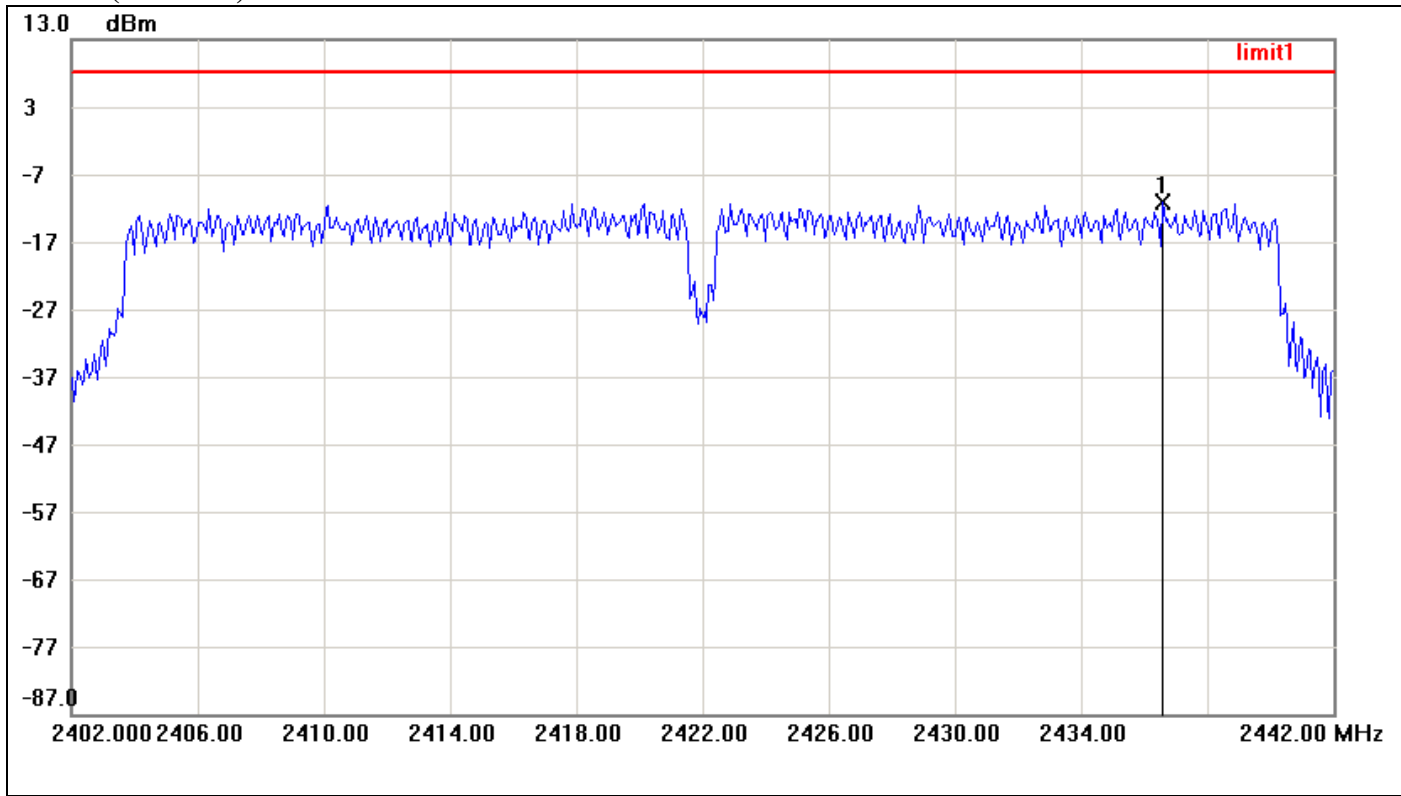

No.	Frequency(MHz)	Result(dBm)	Limit(dBm)	Margin(dBm)
1	2436.6000	-11.26	8.00	-19.26



PPSD (CH Mid)

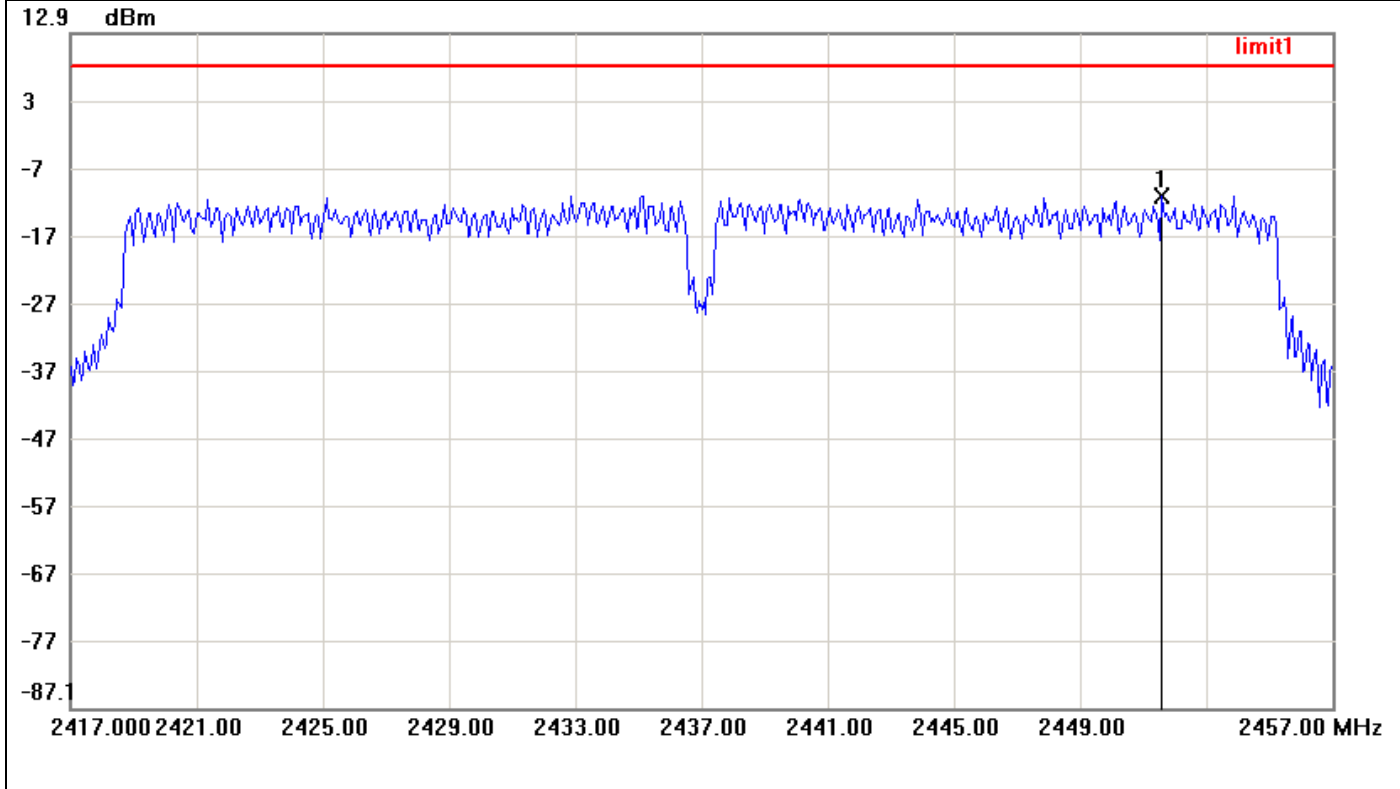

No.	Frequency(MHz)	Result(dBm)	Limit(dBm)	Margin(dBm)
1	2451.6000	-11.15	8.00	-19.15



PPSD (CH High)

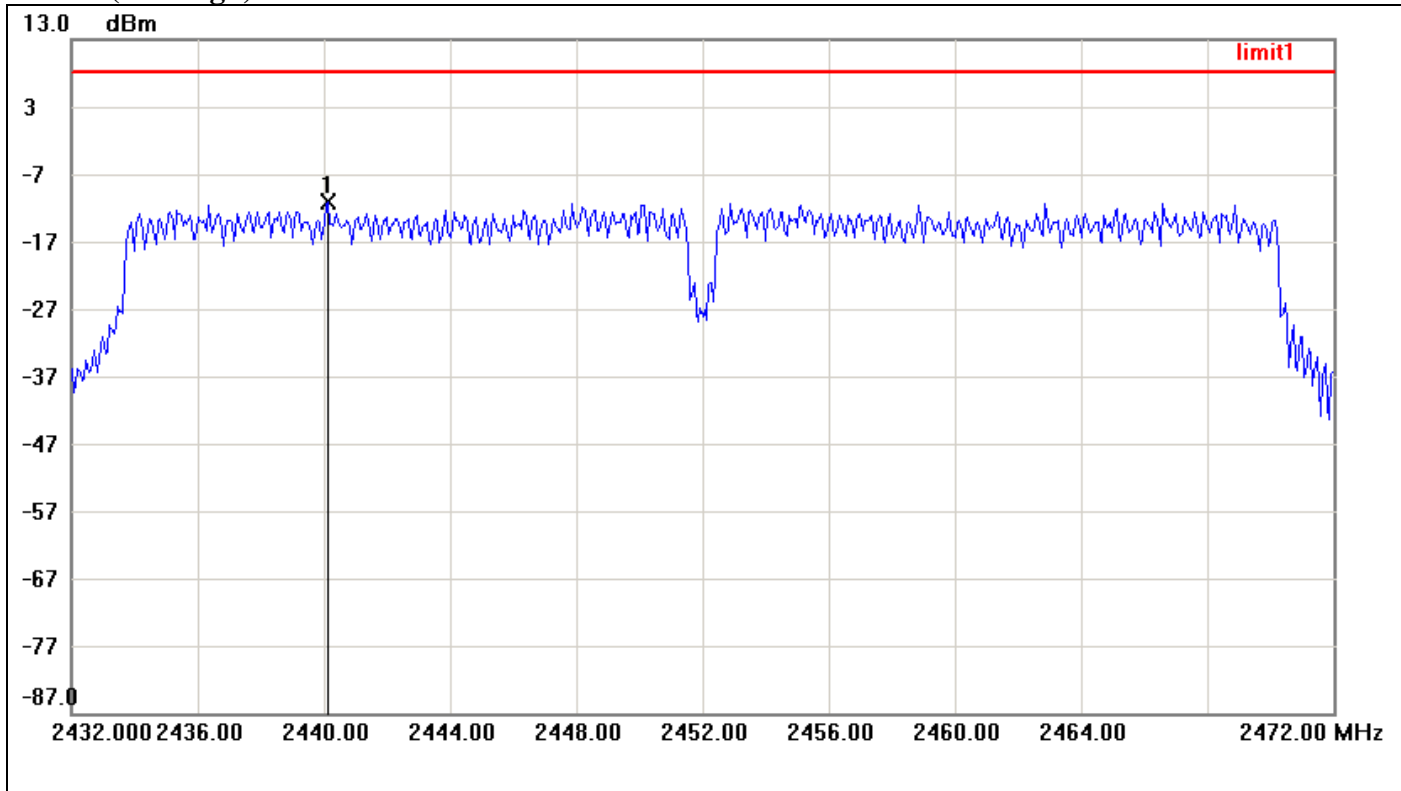

No.	Frequency(MHz)	Result(dBm)	Limit(dBm)	Margin(dBm)
1	2440.1333	-11.27	8.00	-19.27



8.6 SPURIOUS EMISSIONS

8.6.1 Conducted Measurement

LIMIT

According to §15.247(d) & RSS-210 §A8.5, in any 100 kHz bandwidth outside the frequency bands in which the spread spectrum intentional radiator is operating, the radio frequency power that is produced by the intentional radiator shall be at least 20 dB below that in the 100 kHz bandwidth within the band that contains the highest level of the desired power, based on either an RF conducted or a radiated measurement, provided the transmitter demonstrates compliance with the peak conducted power limits. In addition, radiated emissions which fall in the restricted bands, as defined in §15.205(a), must also comply with the radiated emission limits specified in 15.209(a) (see Section 15.205(c)).

Test Configuration

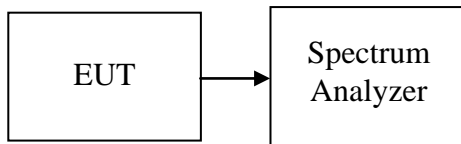

TEST PROCEDURE

Conducted RF measurements of the transmitter output were made to confirm that the EUT antenna port conducted emissions meet the specified limit and to identify any spurious signals that require further investigation or measurements on the radiated emissions site.

The transmitter output is connected to the spectrum analyzer. The resolution bandwidth is set to 100 kHz. The video bandwidth is set to 300 kHz.

Measurements are made over the 30MHz to 26GHz range for IEEE 802.11b/g, 30MHz to 40GHz range for IEEE 802.11a with the transmitter set to the lowest, middle, and highest channels.

TEST RESULTS

No non-compliance noted



Test Plot

IEEE 802.11b mode

CH Low

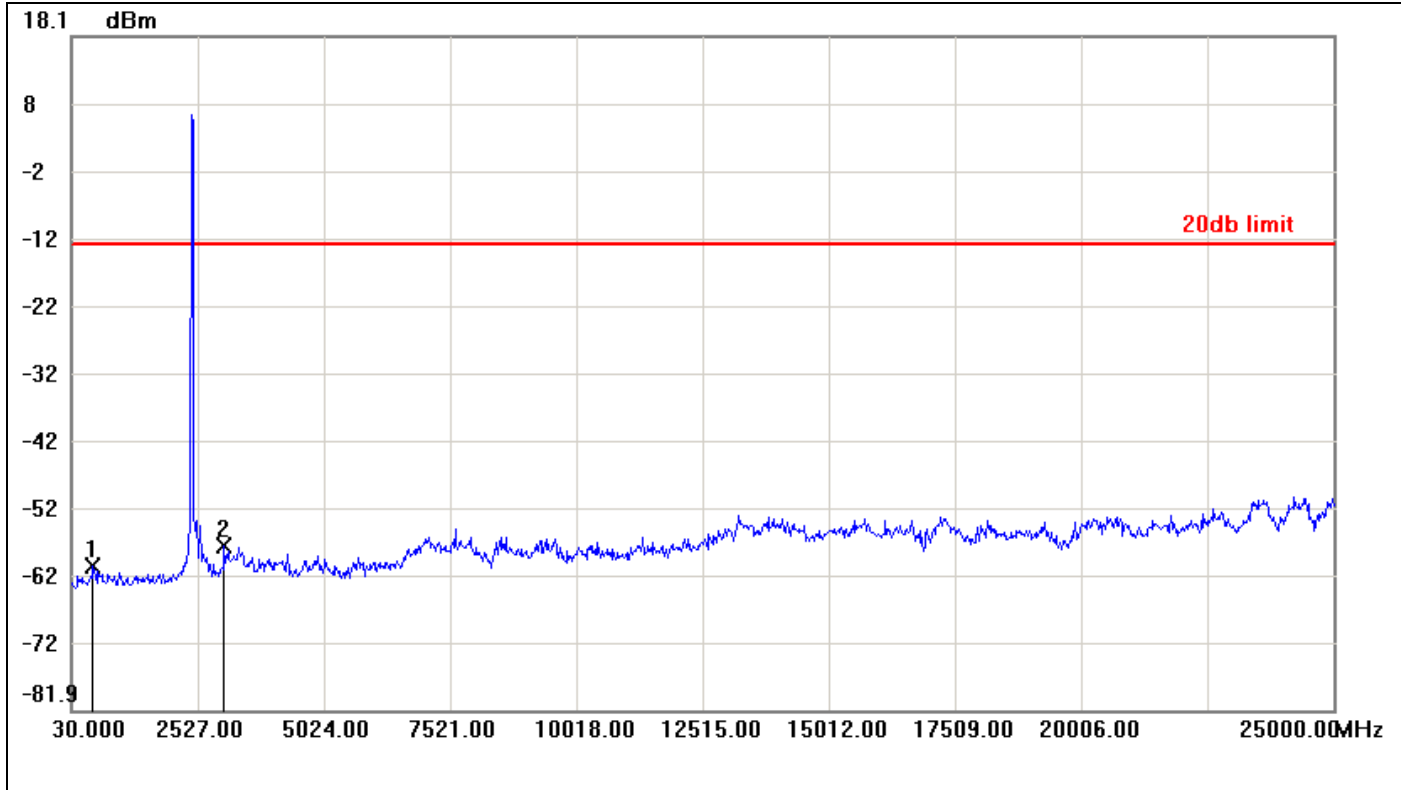

No.	Frequency(MHz)	Result(dBm)	Limit(dBm)	Margin(dBm)
1	454.4900	-60.61	-12.86	-47.75
2	3051.3700	-57.52	-12.86	-44.66



CH Mid

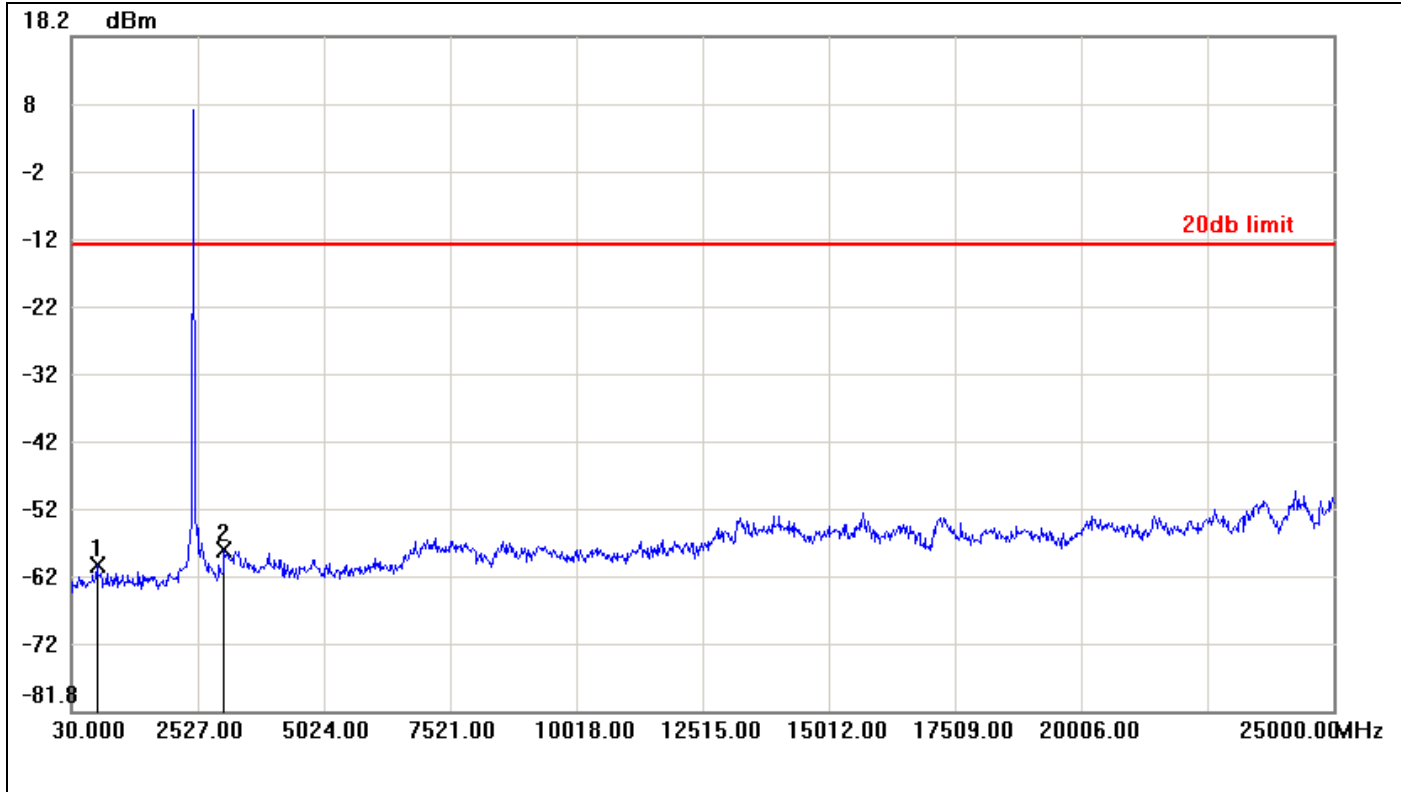

No.	Frequency(MHz)	Result(dBm)	Limit(dBm)	Margin(dBm)
1	529.4000	-60.19	-12.69	-47.50
2	3051.3700	-57.86	-12.69	-45.17



CH High

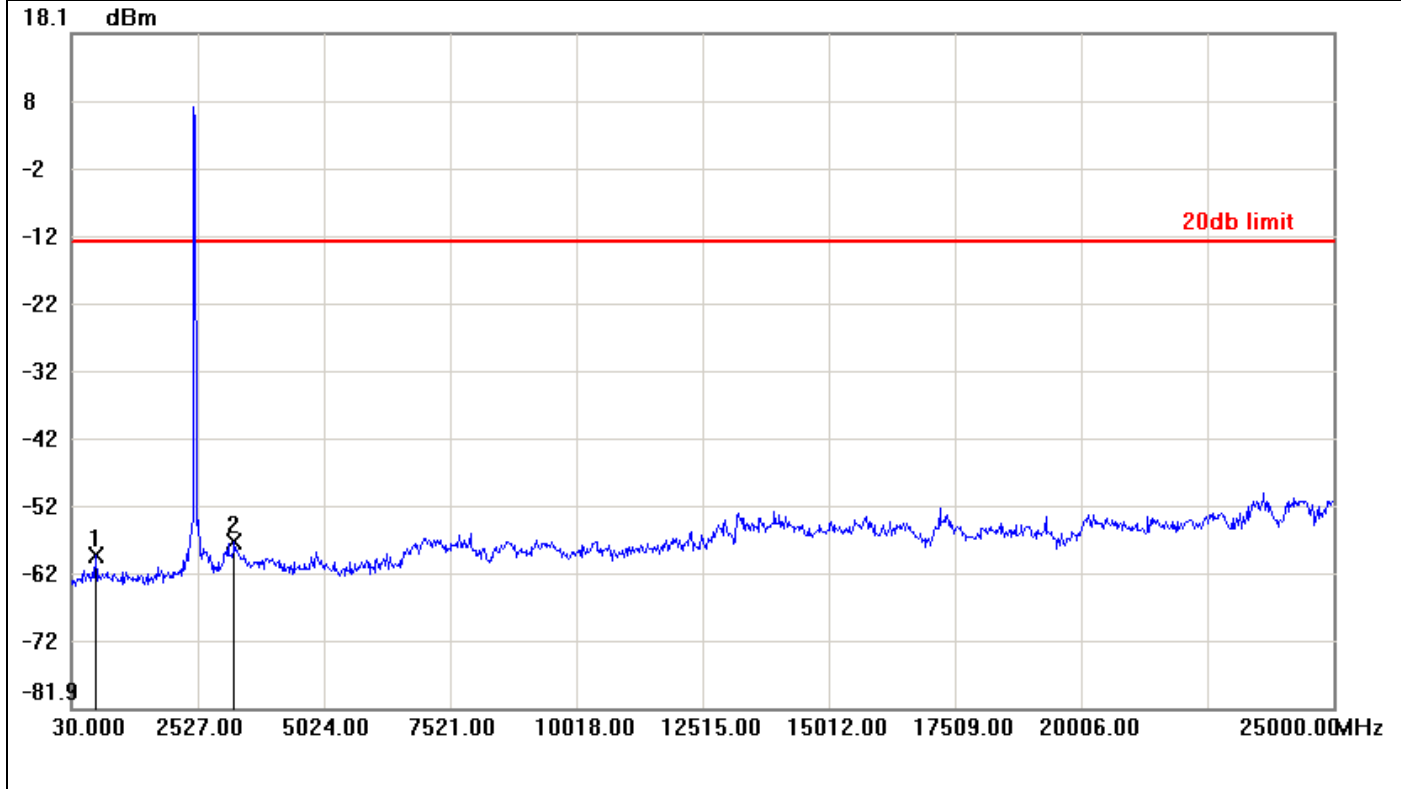

No.	Frequency(MHz)	Result(dBm)	Limit(dBm)	Margin(dBm)
1	504.4300	-59.24	-12.73	-46.51
2	3251.1300	-57.29	-12.73	-44.56



IEEE 802.11g mode

CH Low

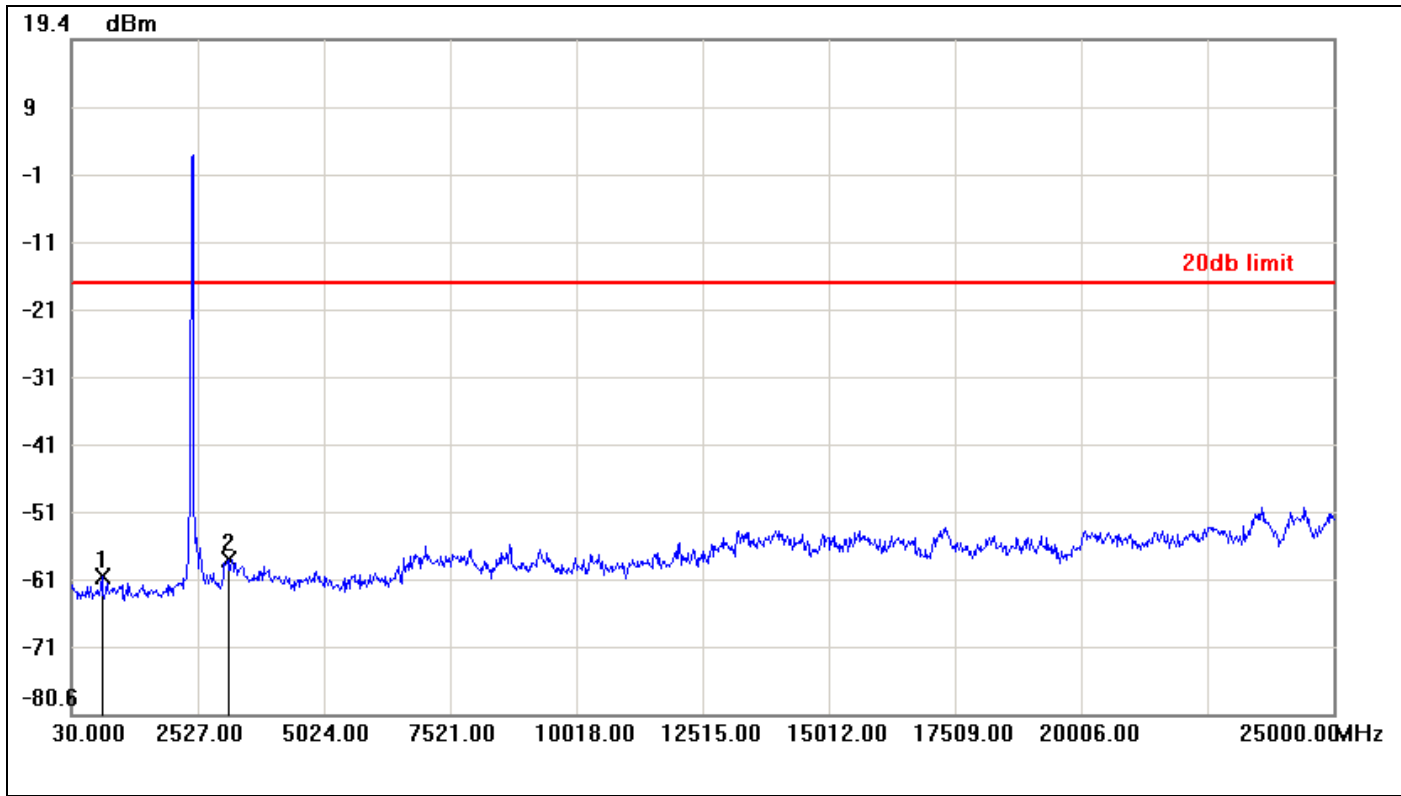

No.	Frequency(MHz)	Result(dBm)	Limit(dBm)	Margin(dBm)
1	629.2800	-60.29	-16.70	-43.59
2	3126.2800	-57.63	-16.70	-40.93



CH Mid

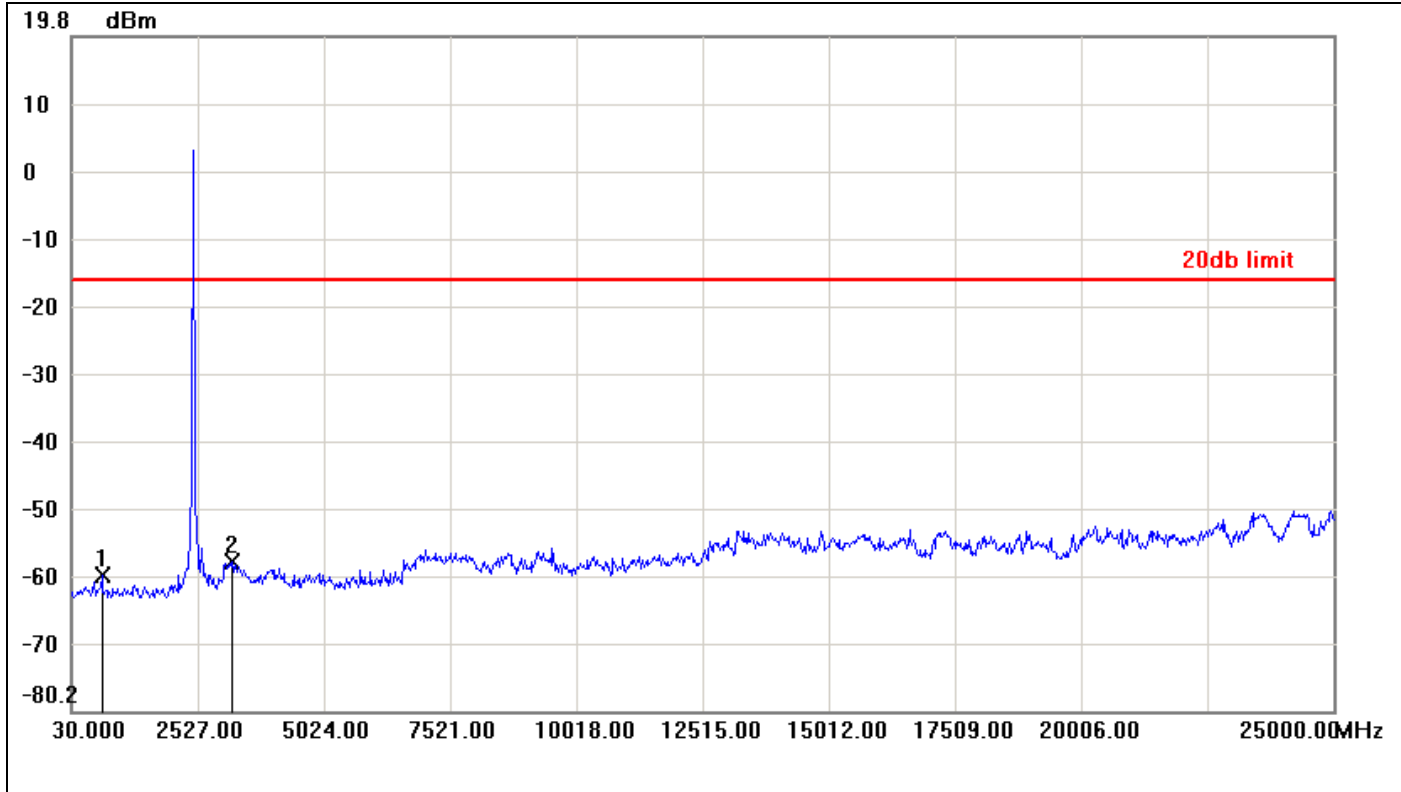

No.	Frequency(MHz)	Result(dBm)	Limit(dBm)	Margin(dBm)
1	629.2800	-60.10	-16.41	-43.69
2	3201.1900	-57.98	-16.41	-41.57



CH High

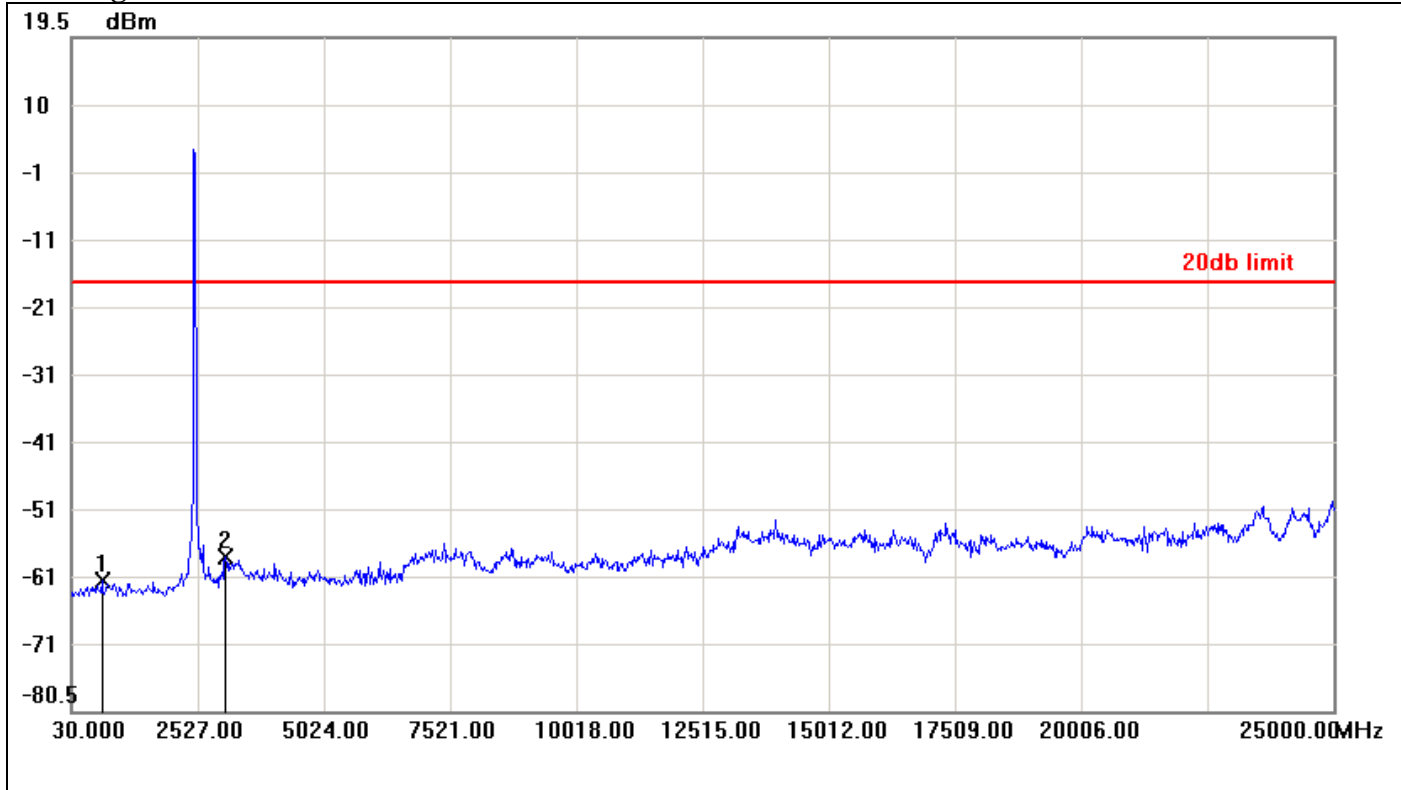

No.	Frequency(MHz)	Result(dBm)	Limit(dBm)	Margin(dBm)
1	629.2800	-61.16	-16.92	-44.24
2	3076.3400	-57.62	-16.92	-40.70



IEEE 802.11n HT 20 MHz mode / Chain 0

CH Low

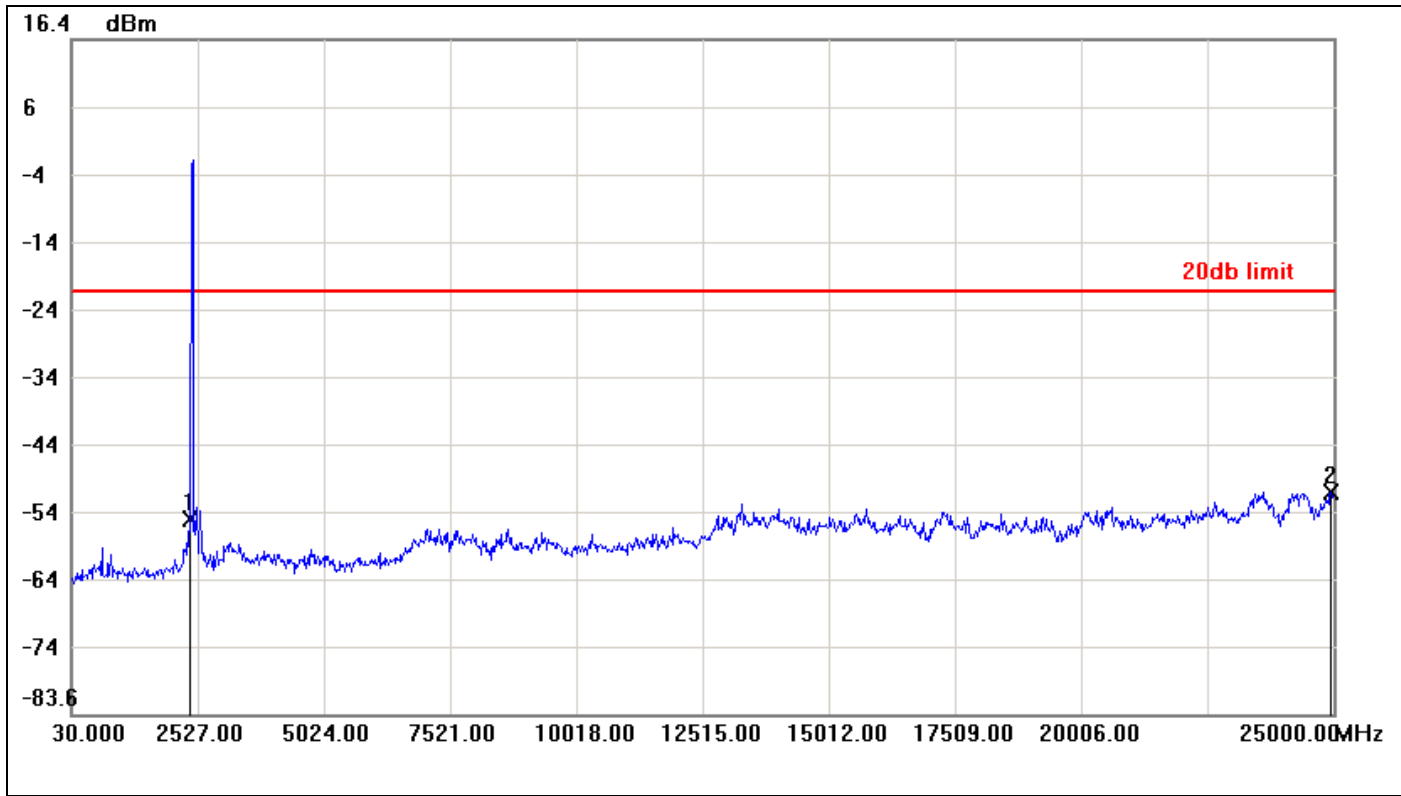

No.	Frequency(MHz)	Result(dBm)	Limit(dBm)	Margin(dBm)
1	2377.1800	-54.73	-20.96	-33.77
2	24950.0600	-50.67	-20.96	-29.71



CH Mid

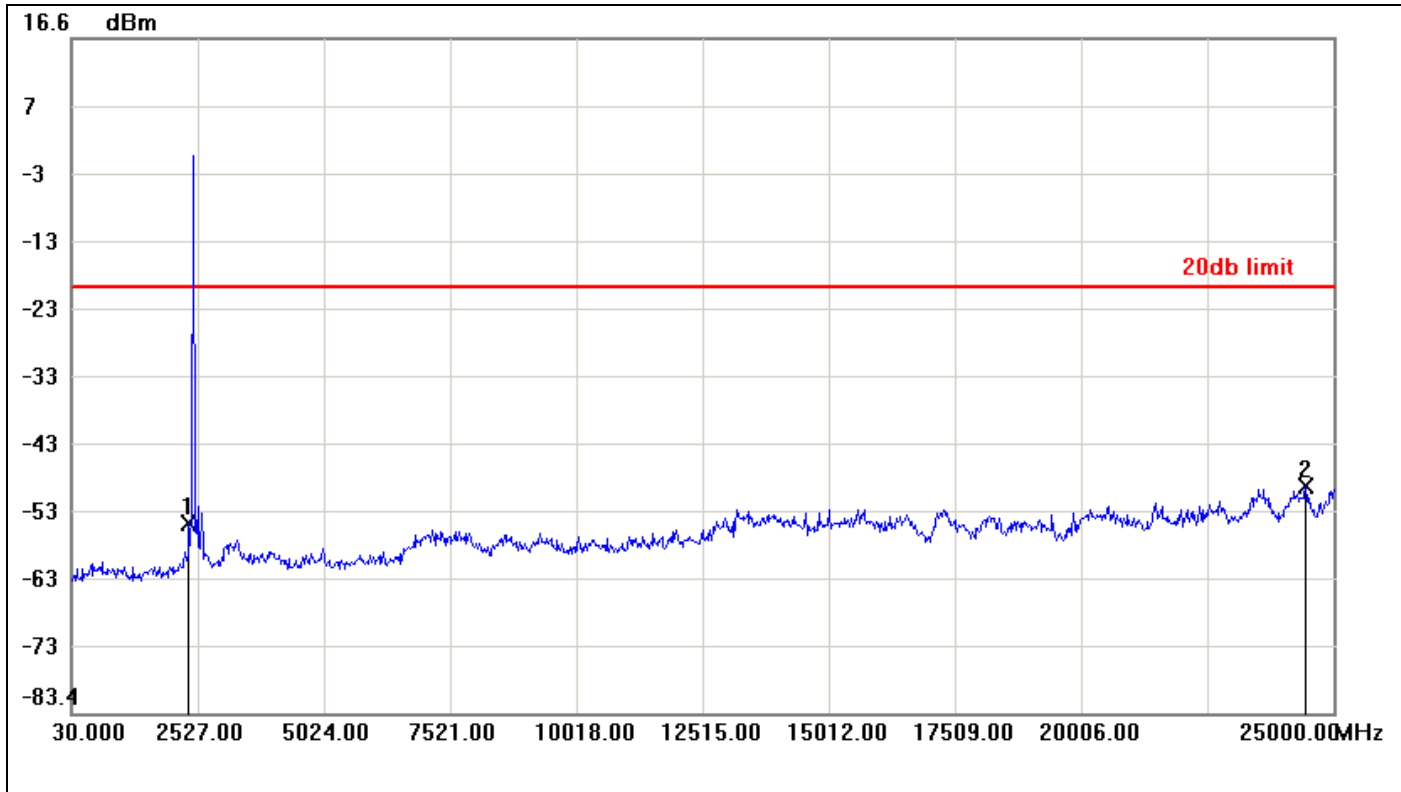

No.	Frequency(MHz)	Result(dBm)	Limit(dBm)	Margin(dBm)
1	2352.2100	-55.29	-20.20	-35.09
2	24450.6600	-49.70	-20.20	-29.50



CH High

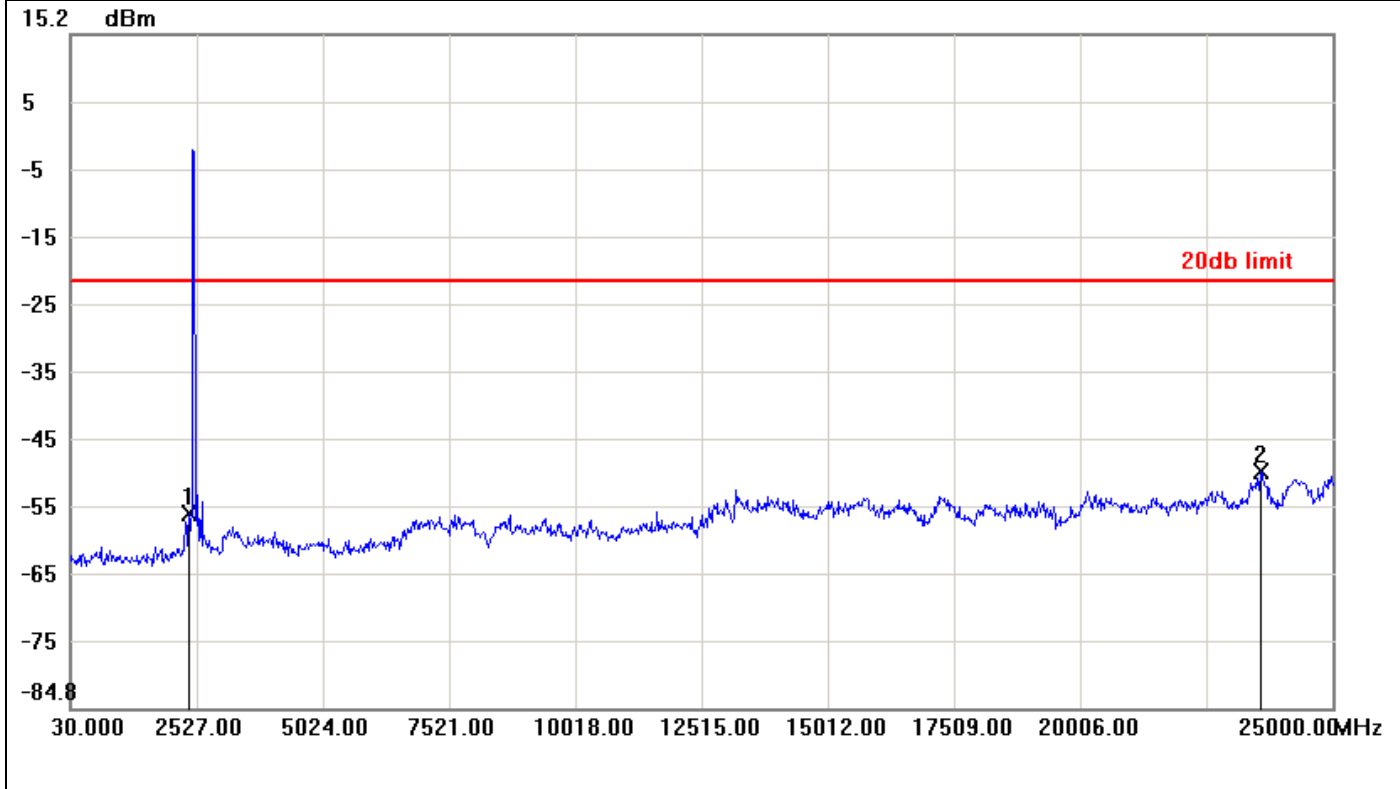

No.	Frequency(MHz)	Result(dBm)	Limit(dBm)	Margin(dBm)
1	2377.1800	-55.92	-21.47	-34.45
2	23576.7100	-49.66	-21.47	-28.19



IEEE 802.11n HT 20 MHz mode / Chain 1

CH Low

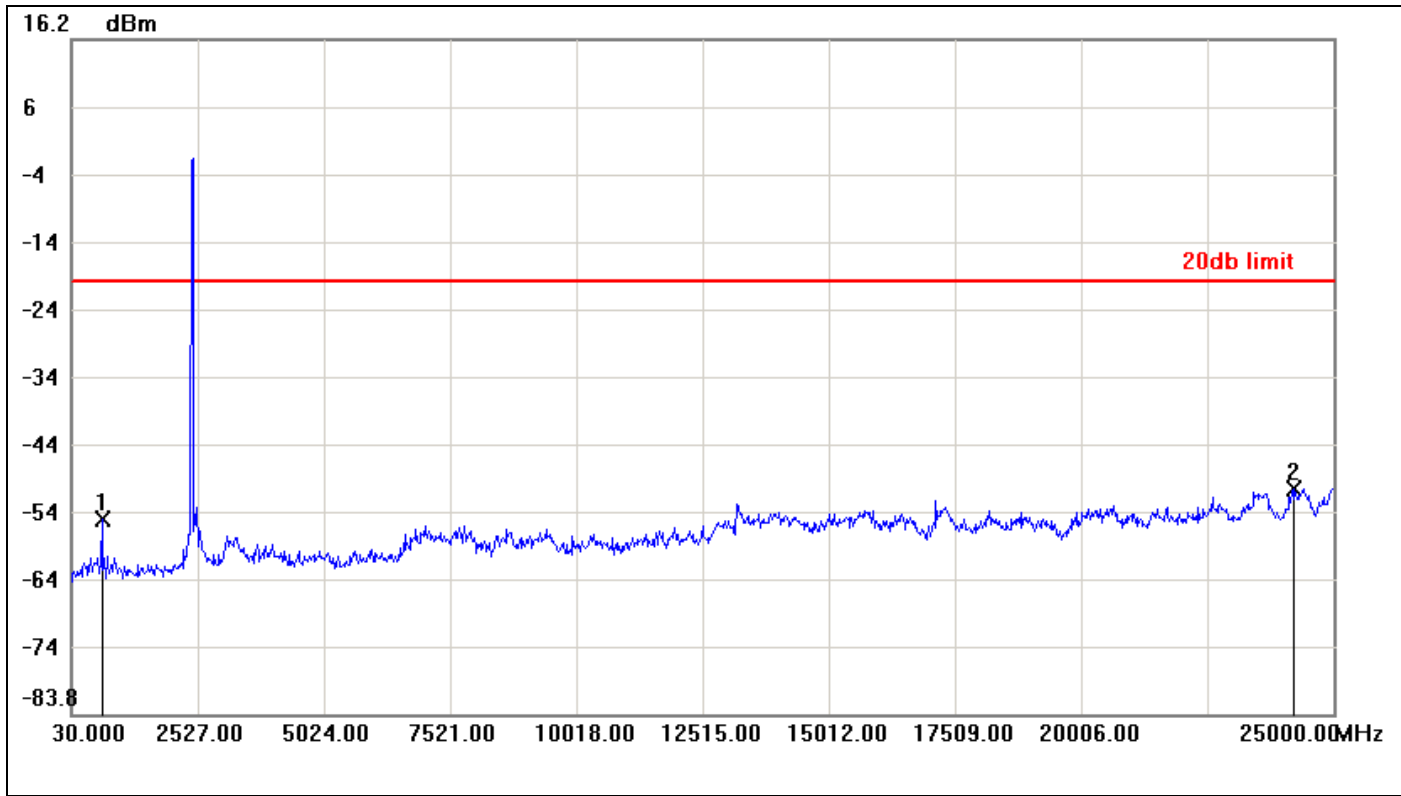

No.	Frequency(MHz)	Result(dBm)	Limit(dBm)	Margin(dBm)
1	629.2800	-55.05	-19.80	-35.25
2	24200.9600	-50.48	-19.80	-30.68



CH Mid

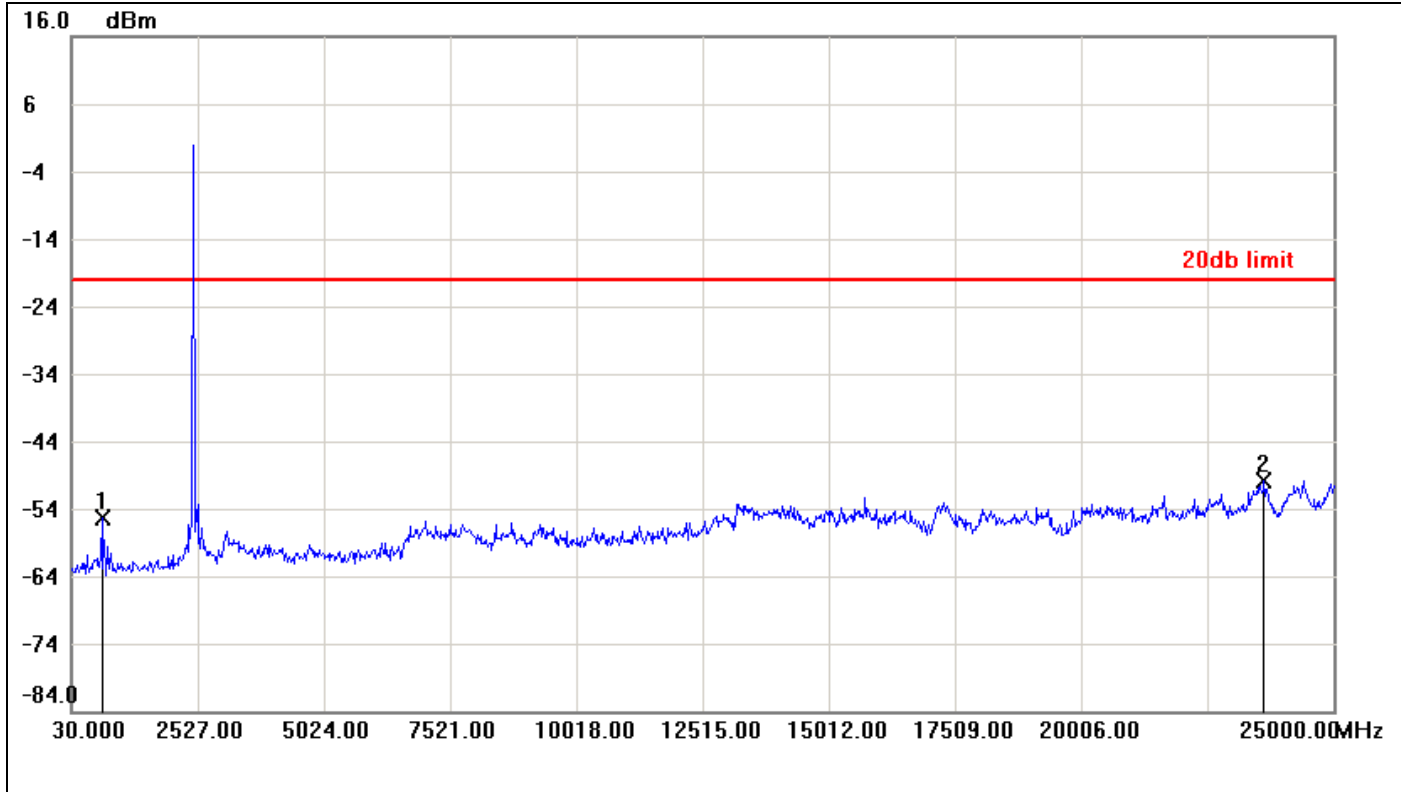

No.	Frequency(MHz)	Result(dBm)	Limit(dBm)	Margin(dBm)
1	629.2800	-55.51	-20.18	-35.33
2	23626.6500	-49.87	-20.18	-29.69



CH High

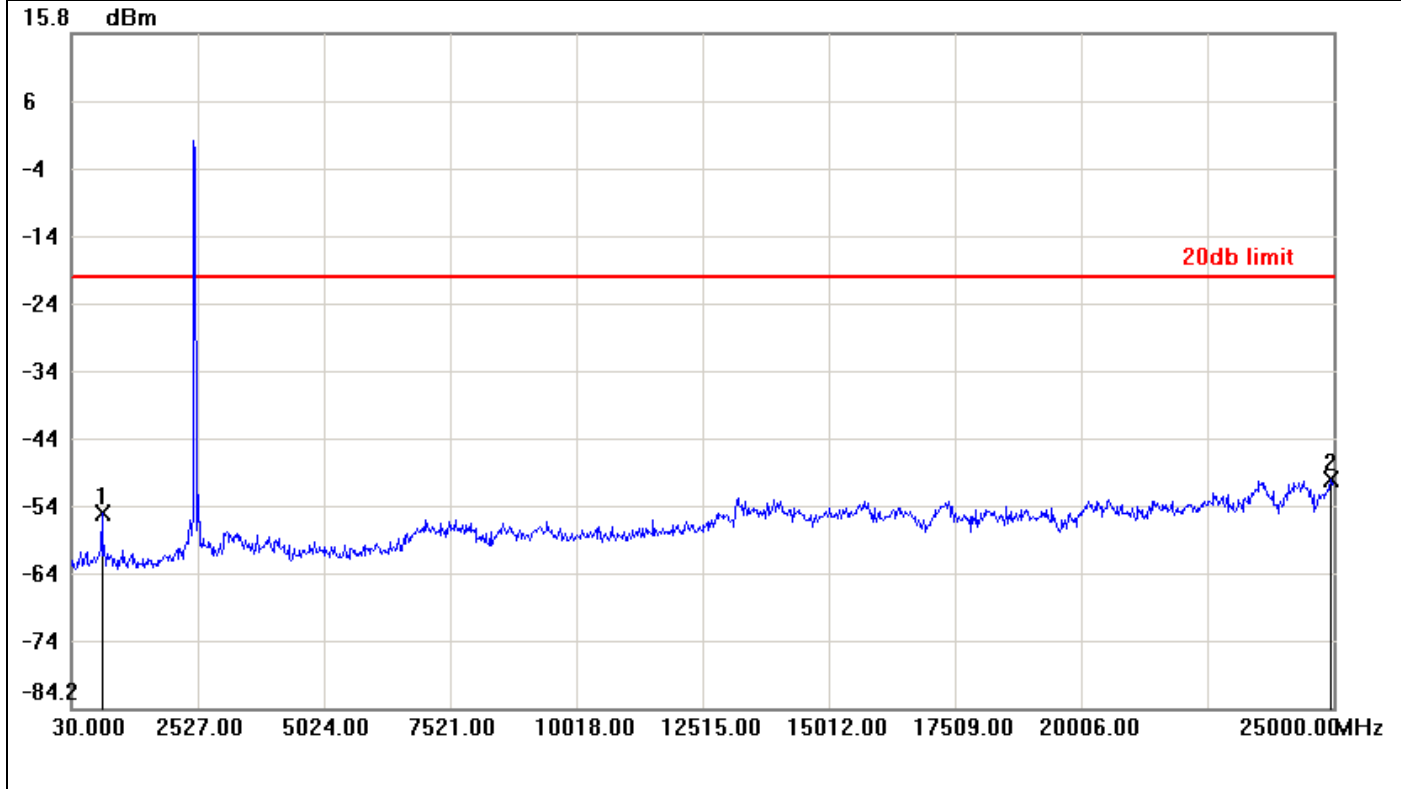

No.	Frequency(MHz)	Result(dBm)	Limit(dBm)	Margin(dBm)
1	629.2800	-55.34	-20.22	-35.12
2	24950.0600	-50.45	-20.22	-30.23



IEEE 802.11n HT 40 MHz mode / Chain 0

CH Low

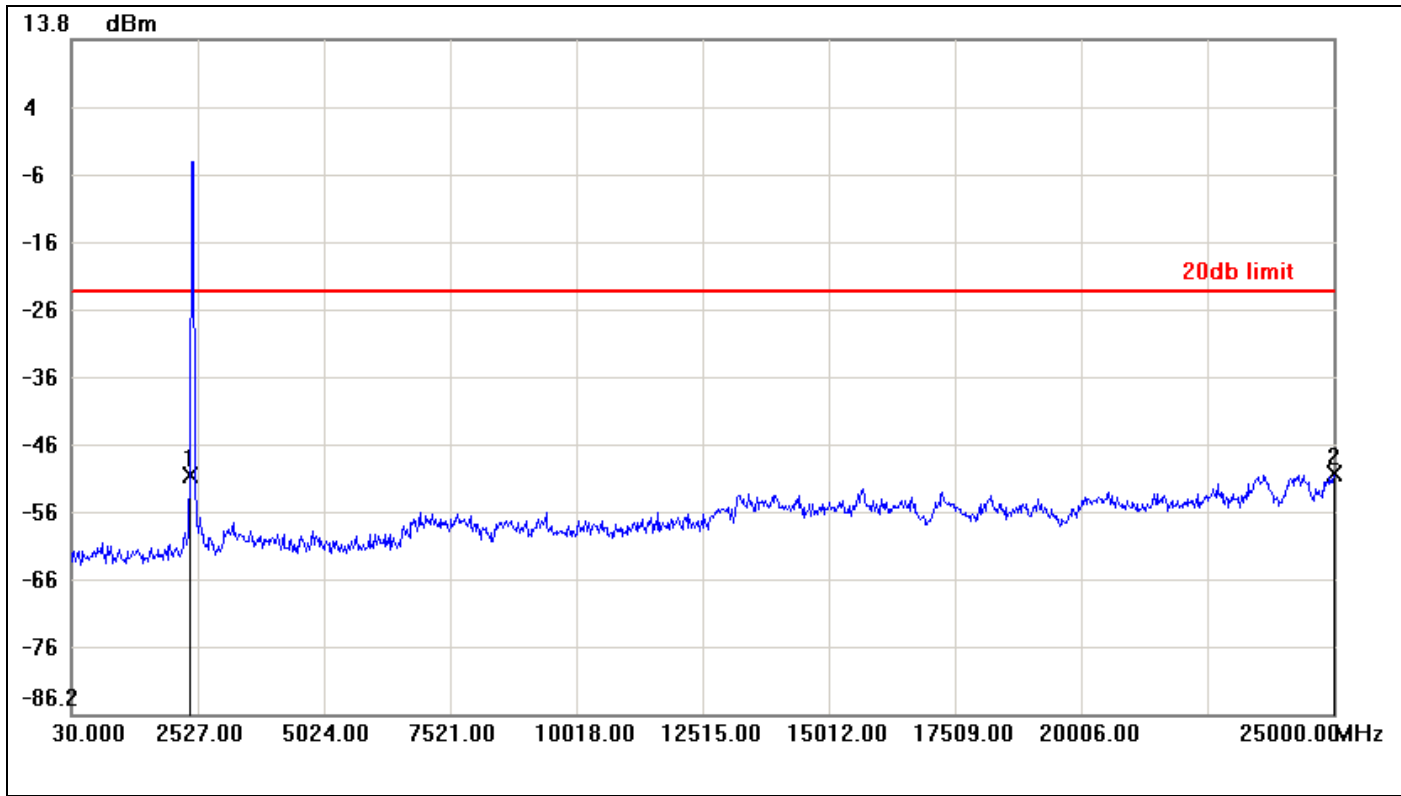

No.	Frequency(MHz)	Result(dBm)	Limit(dBm)	Margin(dBm)
1	2377.1800	-50.81	-23.65	-27.16
2	25000.0000	-50.66	-23.65	-27.01



CH Mid

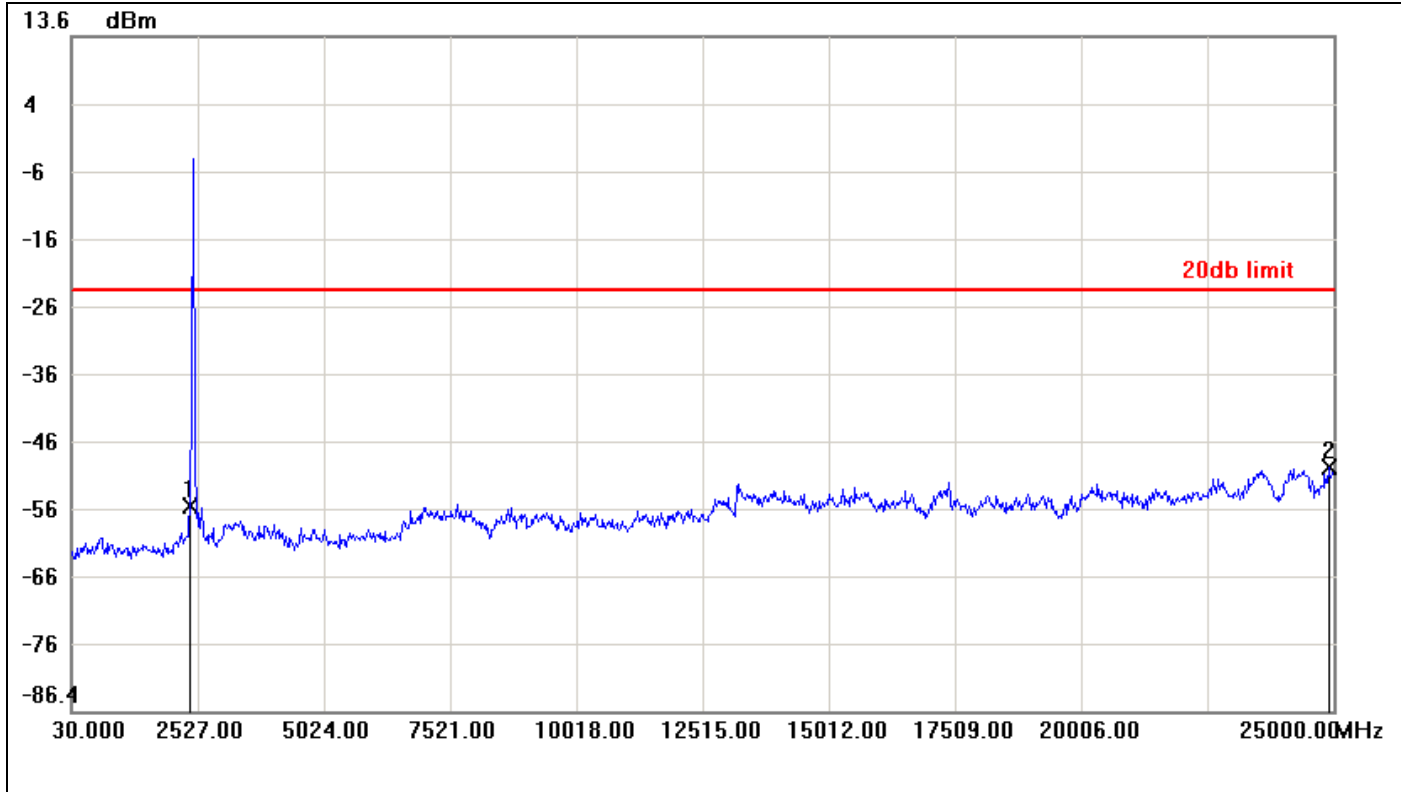

No.	Frequency(MHz)	Result(dBm)	Limit(dBm)	Margin(dBm)
1	2377.1800	-56.12	-24.00	-32.12
2	24900.1200	-50.32	-24.00	-26.32



CH High

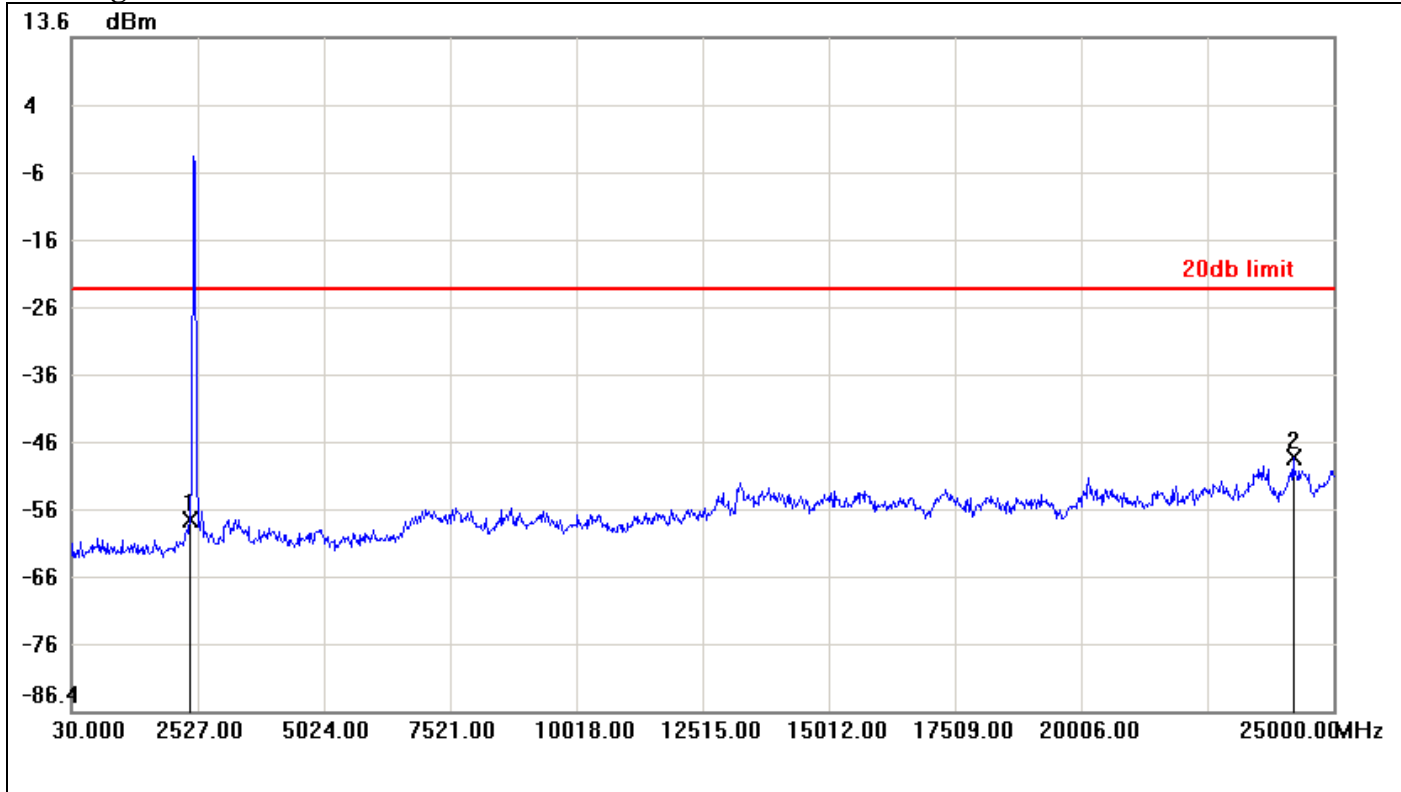

No.	Frequency(MHz)	Result(dBm)	Limit(dBm)	Margin(dBm)
1	2377.1800	-57.98	-23.85	-34.13
2	24200.9600	-48.82	-23.85	-24.97



IEEE 802.11n HT 40 MHz mode / Chain 1

CH Low

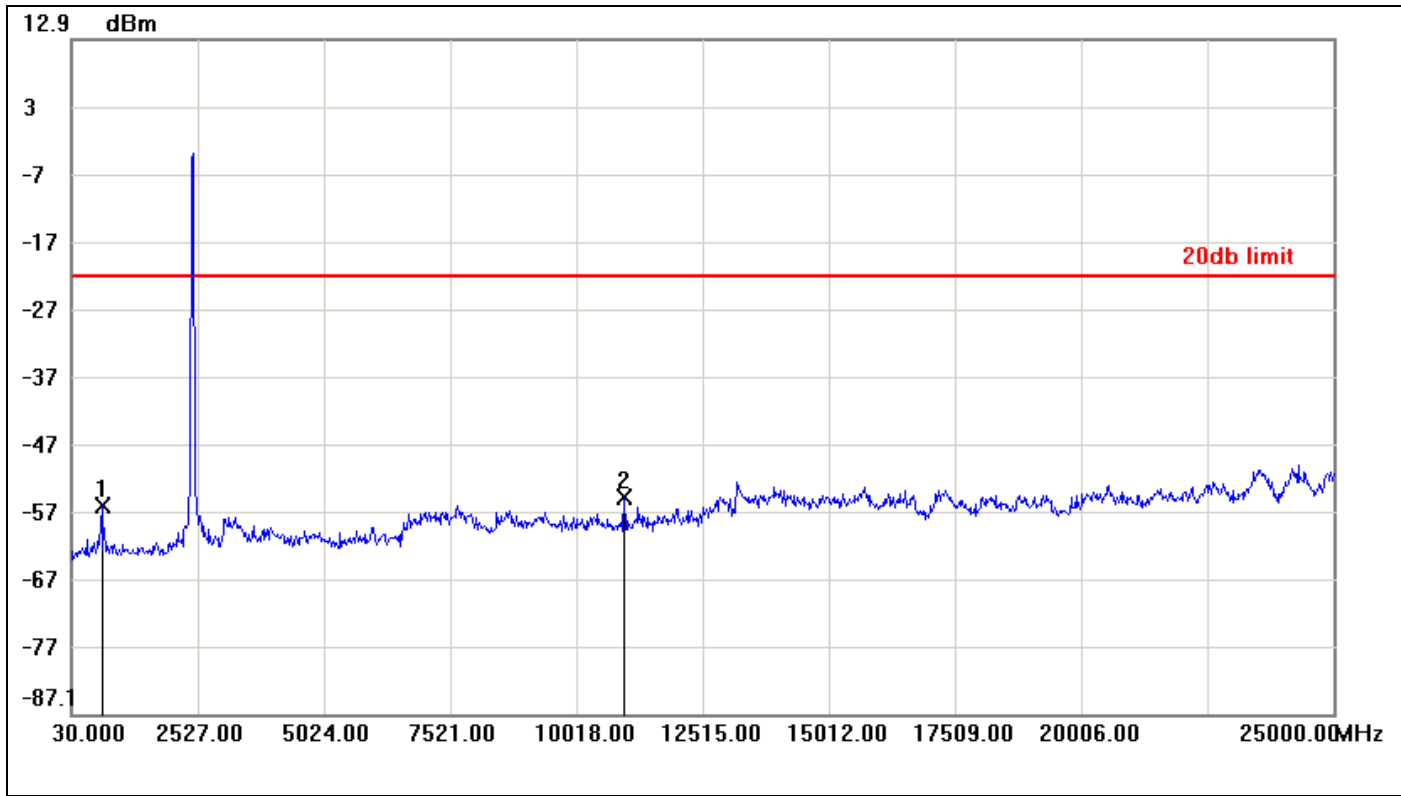

No.	Frequency(MHz)	Result(dBm)	Limit(dBm)	Margin(dBm)
1	629.2800	-56.12	-22.29	-33.83
2	10966.8600	-54.98	-22.29	-32.69



CH Mid

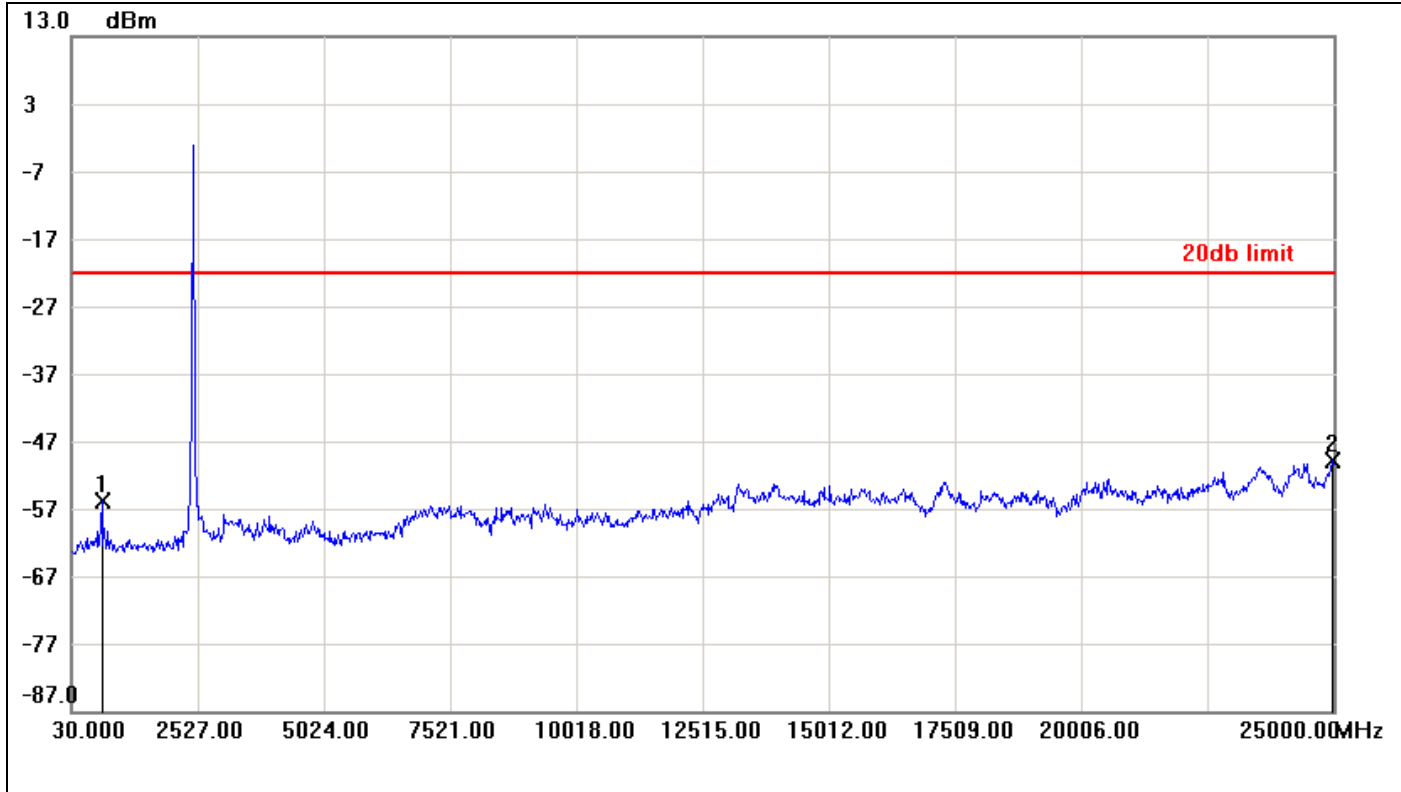

No.	Frequency(MHz)	Result(dBm)	Limit(dBm)	Margin(dBm)
1	629.2800	-55.87	-22.17	-33.70
2	24975.0300	-49.87	-22.17	-27.70



CH High

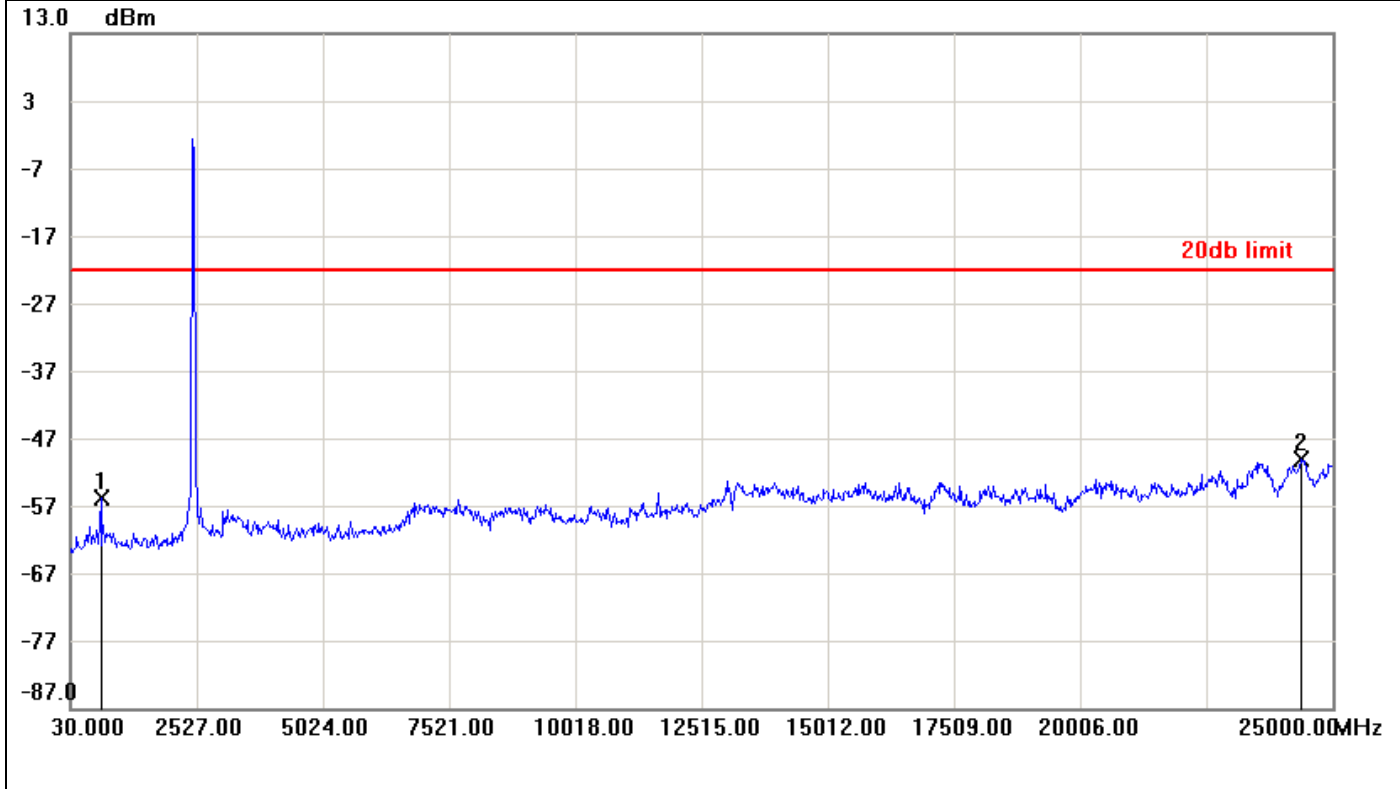

No.	Frequency(MHz)	Result(dBm)	Limit(dBm)	Margin(dBm)
1	629.2800	-55.80	-22.20	-33.60
2	24375.7500	-50.10	-22.20	-27.90



8.6.2 Radiated Emissions

LIMIT

All spurious emissions shall comply with the limits of §15.209(a) and RSS-Gen Table 2 & Table 5.

RSS-Gen Table 2 & Table 5: General Field Strength Limits for Transmitters and Receivers at Frequencies Above 30 MHz ^(Note)

Frequency (MHz)	Field Strength microvolts/m at 3 metres (watts, e.i.r.p.)	
	Transmitters	Receivers
30-88	100 (3 nW)	100 (3 nW)
88-216	150 (6.8 nW)	150 (6.8 nW)
216-960	200 (12 nW)	200 (12 nW)
Above 960	500 (75 nW)	500 (75 nW)

Note: *Measurements for compliance with limits in the above table may be performed at distances other than 3 metres, in accordance with Section 7.2.7.

Transmitting devices are not permitted in Table 1 bands or, unless stated otherwise, in TV bands (54-72 MHz, 76-88 MHz, 174-216 MHz, 470-608 MHz and 614-806 MHz).

RSS-Gen Table 6: General Field Strength Limits for Transmitters at Frequencies Below 30 MHz (Transmit)

Frequency	Field Strength (microvolts/m)	Magnetic H-Field (microamperes/m)	Measurement Distance (metres)
9-490 kHz	2,400/F (F in kHz)	2,400/377F (F in kHz)	3000
490-1,705 kHz	24,000/F (F in kHz)	24,000/377F (F in kHz)	30
1.705-30 MHz	30	N/A	30

Note: The emission limits for the bands 9-90 kHz and 110-490 kHz are based on measurements employing an average detector.



Test Configuration

9kHz ~ 30MHz

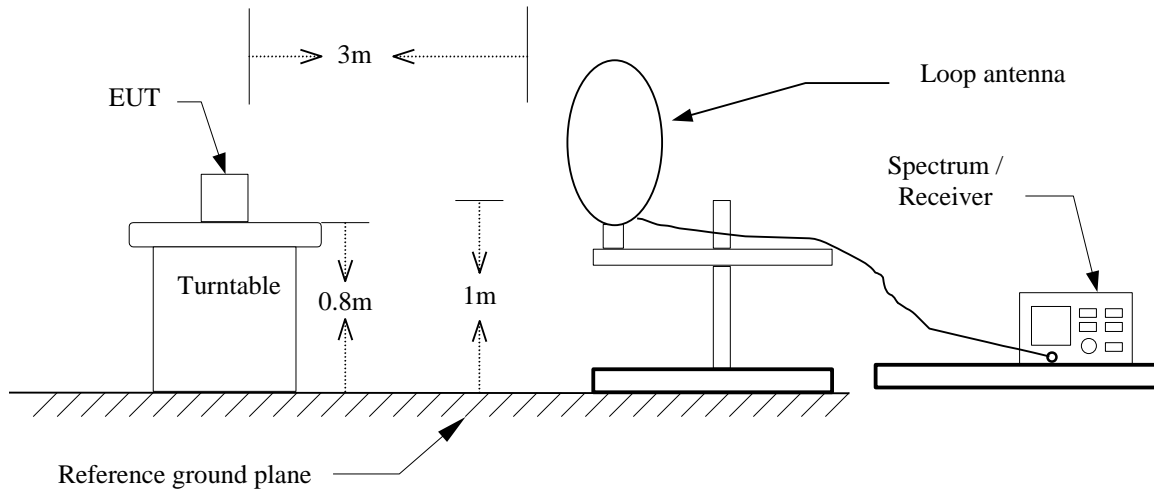

30MHz ~ 1GHz

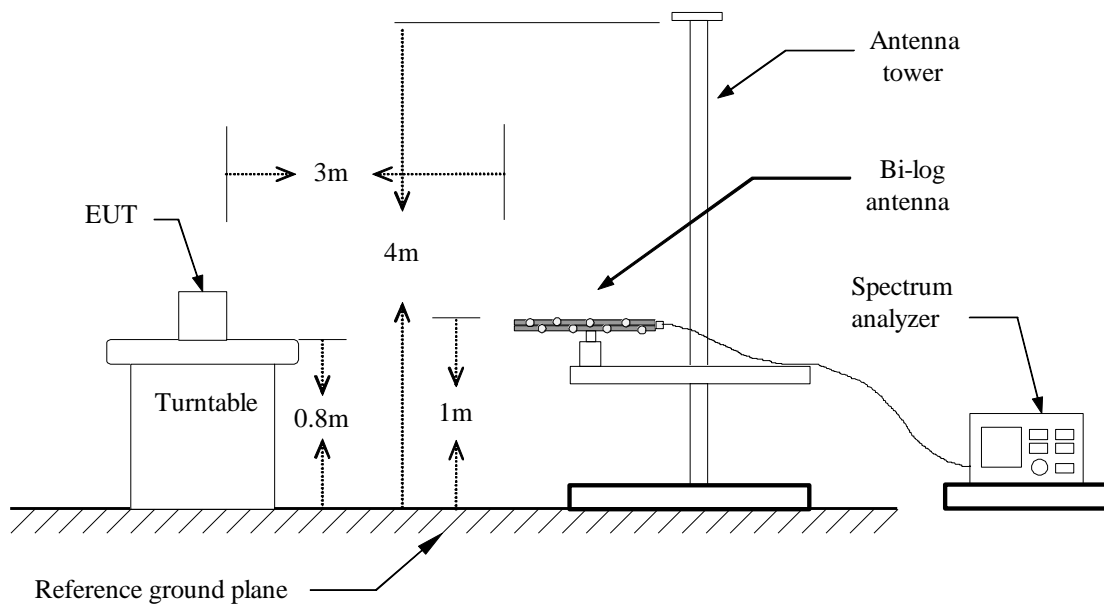



Above 1 GHz

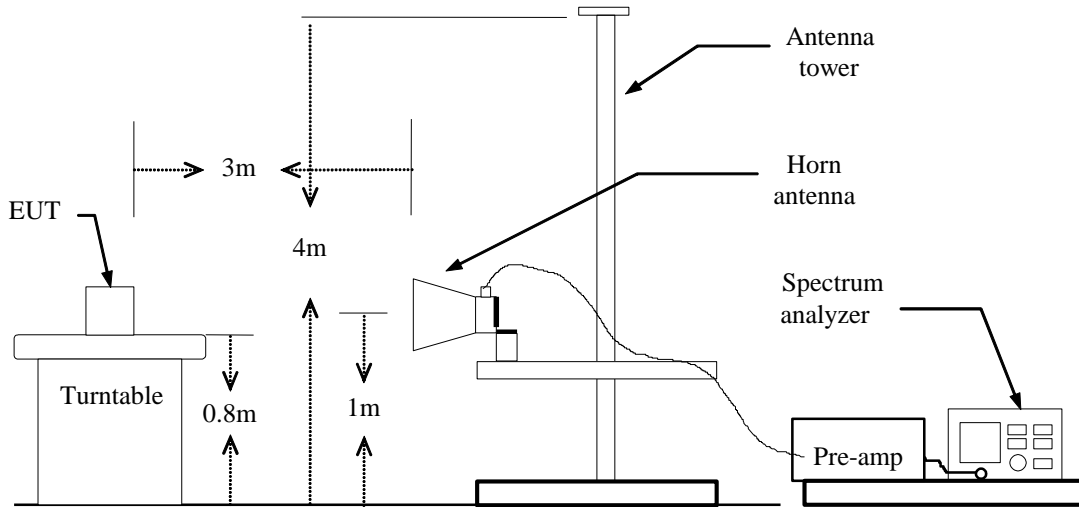



TEST PROCEDURE

1. The EUT is placed on a turntable, which is 0.8m above ground plane.
2. The turntable shall be rotated for 360 degrees to determine the position of maximum emission level.
3. EUT is set 3m away from the receiving antenna, which is varied from 1m to 4m to find out the highest emissions.
4. Maximum procedure was performed on the six highest emissions to ensure EUT compliance.
5. And also, each emission was to be maximized by changing the polarization of receiving antenna both horizontal and vertical.
6. Set the spectrum analyzer in the following setting as:
Below 1GHz:
RBW=100kHz / VBW=300kHz / Sweep=AUTO
Above 1GHz:
(a) PEAK: RBW=VBW=1MHz / Sweep=AUTO
(b) AVERAGE: RBW=1MHz / VBW=300Hz / Sweep=AUTO
7. Repeat above procedures until the measurements for all frequencies are complete.



Below 1 GHz

Operation Mode: Normal link

Test Date: April 22, 2014

Temperature: 27°C

Tested by: David Shu

Humidity: 53% RH

Polarity: Ver. / Hor.

Frequency (MHz)	Reading (dBuV)	Correction Factor (dB/m)	Result (dBuV/m)	Limit (dBuV/m)	Margin (dB)	Remark	Ant. Pol. (H/V)
30.9700	45.54	-10.58	34.96	40.00	-5.04	Peak	V
103.7200	51.76	-20.26	31.50	43.50	-12.00	Peak	V
216.2400	54.58	-18.72	35.86	46.00	-10.14	Peak	V
366.5900	43.62	-14.80	28.82	46.00	-17.18	Peak	V
499.4800	47.93	-11.84	36.09	46.00	-9.91	Peak	V
747.8000	42.88	-7.92	34.96	46.00	-11.04	Peak	V
57.1600	56.82	-23.64	33.18	40.00	-6.82	Peak	H
335.5500	51.36	-15.54	35.82	46.00	-10.18	Peak	H
531.4900	45.36	-11.31	34.05	46.00	-11.95	Peak	H
739.0700	47.10	-8.08	39.02	46.00	-6.98	Peak	H
804.0600	46.23	-7.33	38.90	46.00	-7.10	Peak	H
891.3600	44.61	-6.27	38.34	46.00	-7.66	Peak	H

Remark:

1. No emission found between lowest internal used/generated frequency to 30MHz (9kHz~30MHz).
2. Radiated emissions measured in frequency range from 30 MHz to 1000MHz were made with an instrument using peak/quasi-peak detector mode.
3. Quasi-peak test would be performed if the peak result were greater than the quasi-peak limit or as required by the applicant.
4. Measurements above show only up to 6 maximum emissions noted, or would be lesser, with " N/A " remark, if no specific emissions from the EUT are recorded (ie: margin>20dB from the applicable limit) and considered that's already beyond the background noise floor.
5. Margin (dB) = Remark result (dBuV/m) – Quasi-peak limit (dBuV/m).



Above 1 GHz

Operation Mode: TX / IEEE 802.11b mode / CH Low

Test Date: April 22, 2014

Temperature: 27°C

Tested by: David Shu

Humidity: 53 % RH

Polarity: Ver. / Hor.

Frequency (MHz)	Reading (dBuV)	Correction (dB/m)	Result (dBuV/m)	Limit (dBuV/m)	Margin (dB)	Remark	Ant.Pol. (H/V)
1802.000	51.46	-6.49	44.97	74.00	-29.03	peak	V
N/A							
1812.000	52.02	-6.14	45.88	74.00	-28.12	peak	H
N/A							

Remark:

1. Measuring frequencies from 1 GHz to the 10th harmonic of highest fundamental frequency.
2. Radiated emissions measured in frequency above 1000MHz were made with an instrument using peak/average detector mode.
3. Average test would be performed if the peak result were greater than the average limit.
4. Data of measurement within this frequency range shown “ --- ” in the table above means the reading of emissions are attenuated more than 20dB below the permissible limits or the field strength is too small to be measured.
5. Measurements above show only up to 6 maximum emissions noted, or would be lesser, with “ N/A ” remark, if no specific emissions from the EUT are recorded (ie: margin>20dB from the applicable limit) and considered that's already beyond the background noise floor.
6. Margin (dB) = Remark result (dBuV/m) – Average limit (dBuV/m).



Operation Mode: TX / IEEE 802.11b mode / CH Mid

Test Date: April 22, 2014

Temperature: 27°C

Tested by: David Shu

Humidity: 53 % RH

Polarity: Ver. / Hor.

Frequency (MHz)	Reading (dBuV)	Correction (dB/m)	Result (dBuV/m)	Limit (dBuV/m)	Margin (dB)	Remark	Ant.Pol. (H/V)
1736.000	51.76	-6.88	44.88	74.00	-29.12	peak	V
1720.000	51.88	-6.98	44.90	74.00	-29.10	peak	H
N/A							

Remark:

1. Measuring frequencies from 1 GHz to the 10th harmonic of highest fundamental frequency.
2. Radiated emissions measured in frequency above 1000MHz were made with an instrument using peak/average detector mode.
3. Average test would be performed if the peak result were greater than the average limit.
4. Data of measurement within this frequency range shown “ --- ” in the table above means the reading of emissions are attenuated more than 20dB below the permissible limits or the field strength is too small to be measured.
5. Measurements above show only up to 6 maximum emissions noted, or would be lesser, with “ N/A ” remark, if no specific emissions from the EUT are recorded (ie: margin>20dB from the applicable limit) and considered that's already beyond the background noise floor.
6. Margin (dB) = Remark result (dBuV/m) – Average limit (dBuV/m).



Operation Mode: TX / IEEE 802.11b mode / CH High

Test Date: April 22, 2014

Temperature: 27°C

Tested by: David Shu

Humidity: 53 % RH

Polarity: Ver. / Hor.

Frequency (MHz)	Reading (dBuV)	Correction (dB/m)	Result (dBuV/m)	Limit (dBuV/m)	Margin (dB)	Remark	Ant.Pol. (H/V)
1436.000	53.58	-8.72	44.86	74.00	-29.14	peak	V
N/A							
1720.000	55.10	-6.98	48.12	74.00	-25.88	peak	H
N/A							

Remark:

1. Measuring frequencies from 1 GHz to the 10th harmonic of highest fundamental frequency.
2. Radiated emissions measured in frequency above 1000MHz were made with an instrument using peak/average detector mode.
3. Average test would be performed if the peak result were greater than the average limit.
4. Data of measurement within this frequency range shown “ --- ” in the table above means the reading of emissions are attenuated more than 20dB below the permissible limits or the field strength is too small to be measured.
5. Measurements above show only up to 6 maximum emissions noted, or would be lesser, with “ N/A ” remark, if no specific emissions from the EUT are recorded (ie: margin>20dB from the applicable limit) and considered that's already beyond the background noise floor.
6. $Margin (dB) = Remark\ result (dBuV/m) - Average\ limit (dBuV/m)$.



Operation Mode: TX / IEEE 802.11g mode / CH Low

Test Date: April 22, 2014

Temperature: 27°C

Tested by: David Shu

Humidity: 53 % RH

Polarity: Ver. / Hor.

Frequency (MHz)	Reading (dBuV)	Correction (dB/m)	Result (dBuV/m)	Limit (dBuV/m)	Margin (dB)	Remark	Ant.Pol. (H/V)
1940.000	51.70	-5.36	46.34	74.00	-27.66	peak	V
N/A							
2012.000	52.16	-4.96	47.20	74.00	-26.80	peak	H
N/A							

Remark:

1. Measuring frequencies from 1 GHz to the 10th harmonic of highest fundamental frequency.
2. Radiated emissions measured in frequency above 1000MHz were made with an instrument using peak/average detector mode.
3. Average test would be performed if the peak result were greater than the average limit.
4. Data of measurement within this frequency range shown “ --- ” in the table above means the reading of emissions are attenuated more than 20dB below the permissible limits or the field strength is too small to be measured.
5. Measurements above show only up to 6 maximum emissions noted, or would be lesser, with “ N/A ” remark, if no specific emissions from the EUT are recorded (ie: margin>20dB from the applicable limit) and considered that's already beyond the background noise floor.
6. Margin (dB) = Remark result (dBuV/m) – Average limit (dBuV/m).



Operation Mode: TX / IEEE 802.11g mode / CH Mid

Test Date: April 22, 2014

Temperature: 27°C

Tested by: David Shu

Humidity: 53 % RH

Polarity: Ver. / Hor.

Frequency (MHz)	Reading (dBuV)	Correction (dB/m)	Result (dBuV/m)	Limit (dBuV/m)	Margin (dB)	Remark	Ant.Pol. (H/V)
1508.000	51.31	-8.01	43.30	74.00	-30.70	peak	V
N/A							
1442.000	51.78	-8.43	43.35	74.00	-30.65	peak	H
N/A							

Remark:

1. Measuring frequencies from 1 GHz to the 10th harmonic of highest fundamental frequency.
2. Radiated emissions measured in frequency above 1000MHz were made with an instrument using peak/average detector mode.
3. Average test would be performed if the peak result were greater than the average limit.
4. Data of measurement within this frequency range shown “ --- ” in the table above means the reading of emissions are attenuated more than 20dB below the permissible limits or the field strength is too small to be measured.
5. Measurements above show only up to 6 maximum emissions noted, or would be lesser, with “ N/A ” remark, if no specific emissions from the EUT are recorded (ie: margin > 20dB from the applicable limit) and considered that's already beyond the background noise floor.
6. $Margin (dB) = Remark\ result (dBuV/m) - Average\ limit (dBuV/m)$.



Operation Mode: TX / IEEE 802.11g mode / CH High

Test Date: April 22, 2014

Temperature: 27°C

Tested by: David Shu

Humidity: 53 % RH

Polarity: Ver. / Hor.

Frequency (MHz)	Reading (dBuV)	Correction (dB/m)	Result (dBuV/m)	Limit (dBuV/m)	Margin (dB)	Remark	Ant.Pol. (H/V)
1662.000	51.99	-7.07	44.92	74.00	-29.08	peak	V
N/A							
1896.000	51.82	-5.63	46.19	74.00	-27.81	peak	H
N/A							

Remark:

1. Measuring frequencies from 1 GHz to the 10th harmonic of highest fundamental frequency.
2. Radiated emissions measured in frequency above 1000MHz were made with an instrument using peak/average detector mode.
3. Average test would be performed if the peak result were greater than the average limit.
4. Data of measurement within this frequency range shown “ --- ” in the table above means the reading of emissions are attenuated more than 20dB below the permissible limits or the field strength is too small to be measured.
5. Measurements above show only up to 6 maximum emissions noted, or would be lesser, with “ N/A ” remark, if no specific emissions from the EUT are recorded (ie: margin > 20dB from the applicable limit) and considered that's already beyond the background noise floor.
6. $Margin (dB) = Remark\ result (dBuV/m) - Average\ limit (dBuV/m)$.



Operation Mode: TX / IEEE 802.11n HT 20 MHz mode / CH Low **Test Date:** April 22, 2014

Temperature: 27°C

Tested by: David Shu

Humidity: 53 % RH

Polarity: Ver. / Hor.

Frequency (MHz)	Reading (dBuV)	Correction (dB/m)	Result (dBuV/m)	Limit (dBuV/m)	Margin (dB)	Remark	Ant.Pol. (H/V)
1710.000	53.90	-6.77	47.13	74.00	-26.87	peak	V
N/A							
2140.000	51.62	-4.70	46.92	74.00	-27.08	peak	H
N/A							

Remark:

1. Measuring frequencies from 1 GHz to the 10th harmonic of highest fundamental frequency.
2. Radiated emissions measured in frequency above 1000MHz were made with an instrument using peak/average detector mode.
3. Average test would be performed if the peak result were greater than the average limit or as required by the applicant.
4. Data of measurement within this frequency range shown “ --- ” in the table above means the reading of emissions are attenuated more than 20dB below the permissible limits or the field strength is too small to be measured.
5. Measurements above show only up to 6 maximum emissions noted, or would be lesser, with “ N/A ” remark, if no specific emissions from the EUT are recorded (ie: margin>20dB from the applicable limit) and considered that's already beyond the background noise floor.
6. Margin (dB) = Remark result (dBuV/m) – Average limit (dBuV/m).



Operation Mode: TX / IEEE 802.11n HT 20 MHz mode / CH Mid **Test Date:** April 22, 2014

Temperature: 27°C

Tested by: David Shu

Humidity: 53 % RH

Polarity: Ver. / Hor.

Frequency (MHz)	Reading (dBuV)	Correction (dB/m)	Result (dBuV/m)	Limit (dBuV/m)	Margin (dB)	Remark	Ant.Pol. (H/V)
1474.000	52.07	-8.22	43.85	74.00	-30.15	peak	V
N/A							
1470.000	51.44	-8.25	43.19	74.00	-30.81	peak	H
N/A							

Remark:

1. Measuring frequencies from 1 GHz to the 10th harmonic of highest fundamental frequency.
2. Radiated emissions measured in frequency above 1000MHz were made with an instrument using peak/average detector mode.
3. Average test would be performed if the peak result were greater than the average limit or as required by the applicant.
4. Data of measurement within this frequency range shown “ --- ” in the table above means the reading of emissions are attenuated more than 20dB below the permissible limits or the field strength is too small to be measured.
5. Measurements above show only up to 6 maximum emissions noted, or would be lesser, with “ N/A ” remark, if no specific emissions from the EUT are recorded (ie: margin>20dB from the applicable limit) and considered that's already beyond the background noise floor.
6. Margin (dB) = Remark result (dBuV/m) – Average limit (dBuV/m).



Operation Mode: TX / IEEE 802.11n HT 20 MHz mode / CH High **Test Date:** April 22, 2014

Temperature: 27°C

Tested by: David Shu

Humidity: 53 % RH

Polarity: Ver. / Hor.

Frequency (MHz)	Reading (dBuV)	Correction (dB/m)	Result (dBuV/m)	Limit (dBuV/m)	Margin (dB)	Remark	Ant.Pol. (H/V)
1814.000	51.77	-6.13	45.64	74.00	-28.36	peak	V
N/A							
1754.000	52.10	-6.50	45.60	74.00	-28.40	peak	H
N/A							

Remark:

1. Measuring frequencies from 1 GHz to the 10th harmonic of highest fundamental frequency.
2. Radiated emissions measured in frequency above 1000MHz were made with an instrument using peak/average detector mode.
3. Average test would be performed if the peak result were greater than the average limit or as required by the applicant.
4. Data of measurement within this frequency range shown “ --- ” in the table above means the reading of emissions are attenuated more than 20dB below the permissible limits or the field strength is too small to be measured.
5. Measurements above show only up to 6 maximum emissions noted, or would be lesser, with “ N/A ” remark, if no specific emissions from the EUT are recorded (ie: margin>20dB from the applicable limit) and considered that's already beyond the background noise floor.
6. Margin (dB) = Remark result (dBuV/m) – Average limit (dBuV/m).



Operation Mode: TX / IEEE 802.11n HT 40 MHz mode
/ CH Low
Temperature: 27°C
Humidity: 53 % RH

Test Date: April 22, 2014
Tested by: David Shu
Polarity: Ver. / Hor.

Frequency (MHz)	Reading (dBuV)	Correction (dB/m)	Result (dBuV/m)	Limit (dBuV/m)	Margin (dB)	Remark	Ant.Pol. (H/V)
1708.000	52.54	-6.78	45.76	74.00	-28.24	peak	V
N/A							
2096.000	52.98	-4.79	48.19	74.00	-25.81	peak	H
N/A							

Remark:

1. Measuring frequencies from 1 GHz to the 10th harmonic of highest fundamental frequency.
2. Radiated emissions measured in frequency above 1000MHz were made with an instrument using peak/average detector mode.
3. Average test would be performed if the peak result were greater than the average limit or as required by the applicant.
4. Data of measurement within this frequency range shown “ --- ” in the table above means the reading of emissions are attenuated more than 20dB below the permissible limits or the field strength is too small to be measured.
5. Measurements above show only up to 6 maximum emissions noted, or would be lesser, with “ N/A ” remark, if no specific emissions from the EUT are recorded (ie: margin>20dB from the applicable limit) and considered that's already beyond the background noise floor.
6. Margin (dB) = Remark result (dBuV/m) – Average limit (dBuV/m).



Operation Mode: TX / IEEE 802.11n HT 40 MHz mode
/ CH Mid
Temperature: 27°C
Humidity: 53 % RH

Test Date: April 22, 2014
Tested by: David Shu
Polarity: Ver. / Hor.

Frequency (MHz)	Reading (dBuV)	Correction (dB/m)	Result (dBuV/m)	Limit (dBuV/m)	Margin (dB)	Remark	Ant.Pol. (H/V)
1496.000	51.58	-8.09	43.49	74.00	-30.51	peak	V
N/A							
1484.000	51.35	-8.16	43.19	74.00	-30.81	peak	H
N/A							

Remark:

1. Measuring frequencies from 1 GHz to the 10th harmonic of highest fundamental frequency.
2. Radiated emissions measured in frequency above 1000MHz were made with an instrument using peak/average detector mode.
3. Average test would be performed if the peak result were greater than the average limit or as required by the applicant.
4. Data of measurement within this frequency range shown “ --- ” in the table above means the reading of emissions are attenuated more than 20dB below the permissible limits or the field strength is too small to be measured.
5. Measurements above show only up to 6 maximum emissions noted, or would be lesser, with “ N/A ” remark, if no specific emissions from the EUT are recorded (ie: margin>20dB from the applicable limit) and considered that's already beyond the background noise floor.
6. Margin (dB) = Remark result (dBuV/m) – Average limit (dBuV/m).



Operation Mode: TX / IEEE 802.11n HT 40 MHz mode
/ CH High
Temperature: 27°C
Humidity: 53 % RH

Test Date: April 22, 2014
Tested by: David Shu
Polarity: Ver. / Hor.

Frequency (MHz)	Reading (dBuV)	Correction (dB/m)	Result (dBuV/m)	Limit (dBuV/m)	Margin (dB)	Remark	Ant.Pol. (H/V)
1432.000	52.80	-8.49	44.31	74.00	-29.69	peak	V
N/A							
1532.000	52.92	-7.86	45.06	74.00	-28.94	peak	H
N/A							

Remark:

1. Measuring frequencies from 1 GHz to the 10th harmonic of highest fundamental frequency.
2. Radiated emissions measured in frequency above 1000MHz were made with an instrument using peak/average detector mode.
3. Average test would be performed if the peak result were greater than the average limit or as required by the applicant.
4. Data of measurement within this frequency range shown “ --- ” in the table above means the reading of emissions are attenuated more than 20dB below the permissible limits or the field strength is too small to be measured.
5. Measurements above show only up to 6 maximum emissions noted, or would be lesser, with “ N/A ” remark, if no specific emissions from the EUT are recorded (ie: margin>20dB from the applicable limit) and considered that's already beyond the background noise floor.
6. Margin (dB) = Remark result (dBuV/m) – Average limit (dBuV/m).



8.7 POWERLINE CONDUCTED EMISSIONS

LIMIT

According to §15.207(a) & RSS-Gen §7.2.4, except when the requirements applicable to a given device state otherwise, for any licence-exempt radiocommunication device equipped to operate from the public utility AC power supply, either directly or indirectly, the radio frequency voltage that is conducted back onto the AC power lines in the frequency range of 0.15 MHz to 30 MHz shall not exceed the limits shown in Table 2. The tighter limit applies at the frequency range boundaries.

The conducted emissions shall be measured with a 50 ohm/50 microhenry line impedance stabilization network.

RSS-Gen Table 2 – AC Power Lines Conducted Emission Limits

Frequency Range (MHz)	Conducted limit (dBµV)	
	Quasi-peak	Average
0.15 to 0.5	66 to 56*	56 to 46*
0.5 to 5	56	46
5 to 30	60	50

**Decreases with the logarithm of the frequency*

Test Configuration

See test photographs attached in Appendix 1 for the actual connections between EUT and support equipment.

TEST PROCEDURE

1. The EUT was placed on a table, which is 0.8m above ground plane.
2. Maximum procedure was performed on the six highest emissions to ensure EUT compliance.
3. Repeat above procedures until all frequency measured were complete.



TEST RESULTS

The initial step in collecting conducted data is a spectrum analyzer peak scan of the measurement range. Significant peaks are then marked as shown on the following data page, and these signals are then quasi-peaked.

Test Data

Operation Mode: Normal Link **Test Date:** May 9, 2014
Temperature: 26°C **Tested by:** Sehni Hu
Humidity: 60% RH

Freq. (MHz)	QP Reading (dBuV)	AV Reading (dBuV)	Corr. factor (dB/m)	QP Result (dBuV)	AV Result (dBuV)	QP Limit (dBuV)	AV Limit (dBuV)	QP Margin (dB)	AV Margin (dB)	Note
0.1700	44.71	21.12	0.19	44.90	21.31	64.96	54.96	-20.06	-33.65	L1
0.3060	39.17	30.91	0.20	39.37	31.11	60.08	50.08	-20.71	-18.97	L1
0.5940	29.67	20.62	0.20	29.87	20.82	56.00	46.00	-26.13	-25.18	L1
2.6540	22.87	12.44	0.16	23.03	12.60	56.00	46.00	-32.97	-33.40	L1
3.7660	18.75	10.06	0.19	18.94	10.25	56.00	46.00	-37.06	-35.75	L1
13.7780	19.99	13.35	0.68	20.67	14.03	60.00	50.00	-39.33	-35.97	L1
0.1580	44.13	38.40	0.19	44.32	38.59	65.57	55.57	-21.25	-16.98	L2
0.1980	42.19	35.85	0.19	42.38	36.04	63.69	53.69	-21.31	-17.65	L2
0.2860	43.67	33.09	0.19	43.86	33.28	60.64	50.64	-16.78	-17.36	L2
0.3780	37.96	27.12	0.19	38.15	27.31	58.32	48.32	-20.17	-21.01	L2
0.4940	34.21	23.06	0.19	34.40	23.25	56.10	46.10	-21.70	-22.85	L2
13.9060	23.00	15.79	0.53	23.53	16.32	60.00	50.00	-36.47	-33.68	L2

Remark:

1. Measuring frequencies from 0.15 MHz to 30MHz.
2. The emissions measured in frequency range from 0.15 MHz to 30MHz were made with an instrument using Quasi-peak detector and average detector.
3. The IF bandwidth of SPA between 0.15MHz to 30MHz was 10kHz; the IF bandwidth of Test Receiver between 0.15MHz to 30MHz was 9kHz;
4. L1 = Line One (Live Line) / L2 = Line Two (Neutral Line)



Test Plots

Conducted emissions (Line 1)

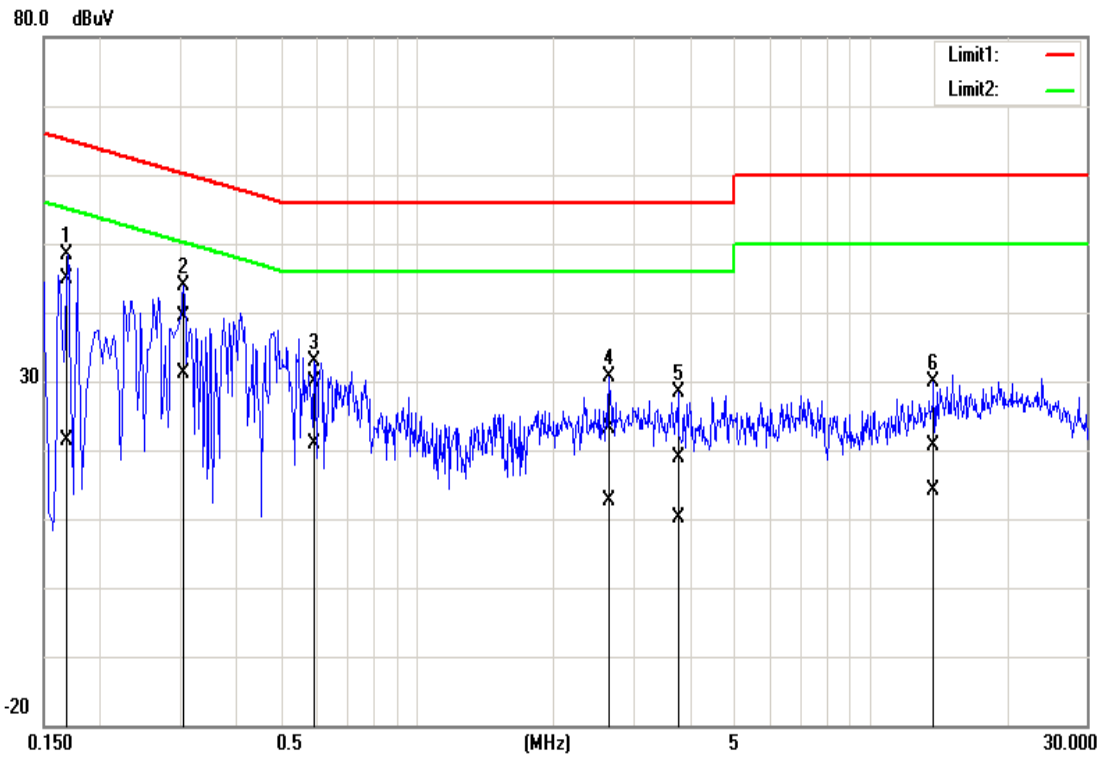

Conducted emissions (Line 2)

