



FCC TEST REPORT

CATEGORY : Mobile End Product
PRODUCT NAME : Wireless Instant Messenger
FCC ID. : PPQ-WL100BA51
FILING TYPE : Certification
BRAND NAME : LITE-ON, AERONIX
MODEL NAME : WL-100BA51/A1, Zipit
APPLICANT : **LITE-ON TECHNOLOGY CORP.**
2F, No. 6, Lane 359, Sec. 2, Chung-Shan Rd., Chung-Ho,
Taiwan, R.O.C.
MANUFACTURER : **DONGGUAN G-COM COMPUTER CO., LTD.**
1st Row Yin Shan Rd., Yin Hwu Industrial Area, Qingxi Town,
DongGuan City, Guang Dong, China
ISSUED BY : **SPORTON International Inc.**
6F, No. 106, Sec. 1, Hsin Tai Wu Rd., Hsi Chih, Taipei Hsien,
Taiwan, R.O.C.

Statements:

The test result in this report refers exclusively to the presented test model / sample.

Without written approval of SPORTON International Inc., the test report shall not be reproduced except in full.

Certificate or Test Report could not be used by the applicant to claim the product endorsement by CNLA, NVLAP or any agency of U.S. government.

The test equipment used to perform the test are calibrated and traceable to NML/ROC or NIST/USA.

Dr. Alan Lane
Vice General Manager
Sporton International Inc.



Lab Code: 200079-0



Table of Contents

History of this test report.....	ii
1. General Description of Equipment under Test.....	1
1.1. Applicant.....	1
1.2. Manufacturer	1
1.3. Basic Description of Equipment under Test	1
1.4. Features of Equipment under Test.....	1
1.5. Table for Carrier Frequencies	2
2. Test Configuration of the Equipment under Test.....	3
2.1. Description of the Test	3
2.2. Frequency Range Investigated	3
2.3. Description of Test Supporting Units.....	4
2.4. Connection Diagram of Test System	4
2.5. Test Software	5
3. Test Location and Standards	6
3.1. Test Location.....	6
3.2. Test Conditions	6
3.3. Standards for Methods of Measurement.....	6
3.4. DoC Statement.....	6
4. List of Measurements.....	7
4.1. Summary of the Test Results	7
5. Test Result	8
5.1. Test of 6dB Spectrum Bandwidth (DSSS System)	8
5.2. Test of Maximum Peak Output Power	11
5.3. Test of Peak Power Spectral Density.....	12
5.4. Test of Band Edges Emission	15
5.5. Test of AC Power Line Conducted Emission	17
5.6. Test of Spurious Radiated Emission	21
5.7. Antenna Requirements	28
6. List of Measuring Equipments Used	29
Appendix A. Photographs of EUT.....	A1 ~ A15



1. General Description of Equipment under Test

1.1. Applicant

LITE-ON TECHNOLOGY CORP.

2F, No. 6, Lane 359, Sec. 2, Chung-Shan Rd., Chung-Ho, Taiwan, R.O.C.

1.2. Manufacturer

DONGGUAN G-COM COMPUTER CO., LTD.

1st Row Yin Shan Rd., Yin Hwu Industrial Area, Qingxi Town, DongGuan City, Guang Dong, China

1.3. Basic Description of Equipment under Test

This product is a wireless instant messenger with IEEE 802.11b wireless module. The radio technical data has been listed on section "Features of Equipment under Test". This device is used to access the internet wirelessly and with compact size, easy to carry.

1.4. Features of Equipment under Test

ITEM	DESCRIPTION
Type of Modulation	DSSS (CCK / DQPSK / DBPSK)
Number of Channels	11
Frequency Band	2400MHz ~ 2483.5MHz
Carrier Frequency of Each Channel	Please reference table below.
Channel Bandwidth	11MHz
RF Conducted Output Power	CCK : 15.90dBm (peak)
Antenna Type / Gain	Monopole Antenna / 2dBi
Function Type	Transceiver
Duty Cycle	100%
Power Rating (DC/AC, Voltage)	110VAC / 12VDC (power adapter)
Temperature Range (Operating)	0 ~ 55



1.5. Table for Carrier Frequencies

Channel	Frequency	Channel	Frequency	Channel	Frequency
1	2412 MHz	5	2432 MHz	9	2452 MHz
2	2417 MHz	6	2437 MHz	10	2457 MHz
3	2422 MHz	7	2442 MHz	11	2462 MHz
4	2427 MHz	8	2447 MHz		



2. Test Configuration of the Equipment under Test

2.1. Description of the Test

- a. During testing, the equipment was placed on a non-conducting support.
- b. The following test modes were performed:
 - Mode 1 : CH 01 2412MHz
 - Mode 2 : CH 06 2437MHz
 - Mode 3 : CH 11 2462MHz
- c. Spurious emission below 1GHz is independent of channel selection, so only Channel 11 was tested.
- d. For spurious emission above 1GHz, lowest, middle and highest channel was tested.
- e. The EUT has been programmed to continuously transmit or receive during testing. The used peripherals as well as the configuration fulfill the requirements of ANSI C63.4:2001.
- f. The configuration is operated in a manner which tends to maximize its emission characteristics in a typical application.
- g. 3 meters measurement distance in semi-anechoic chamber was used in this test.

2.2. Frequency Range Investigated

- a. Conducted power line test: from 150 kHz to 30 MHz
- b. Radiated emission test: from 30 MHz to 25000 MHz

2.3. Description of Test Supporting Units

Support Unit 1. – Earphone

2.4. Connection Diagram of Test System

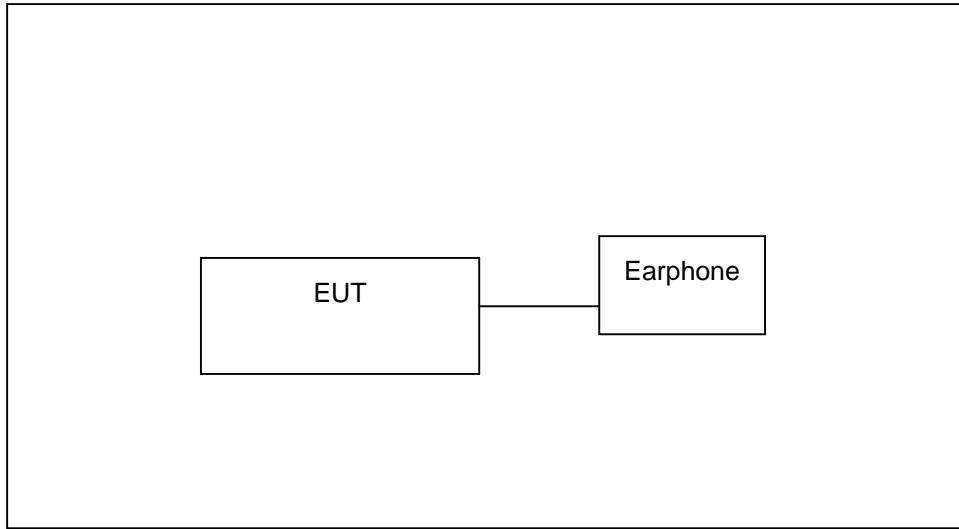



2.5. Test Software

The test software was installed inside the EUT. The channel shift can be reached by pressing the button of the EUT.



3. Test Location and Standards

3.1. Test Location

Test Location : Sporton Hwa Ya Testing Building

Address : No. 52, Hwa Ya 1st Rd., Hwa Ya Technology Park, Kwei-Shan Hsiang, Tao Yuan Hsien, Taiwan, R.O.C.
Tel: +886 3 327 3456 Fax: +886 3 318 0055

Test Site No. : CO03-HY, 03CH03-HY

3.2. Test Conditions

Normal Voltage : 110V/60Hz (power adapter)
Extreme Voltage : 138V and 102V (power adapter)
Normal Temperature : 20
Extreme Temperature : -20 and 55

3.3. Standards for Methods of Measurement

Here is the list of the standards followed in this test report.

ANSI C63.4-2001

47 CFR Part 15 Subpart C (Section 15.247)

3.4. DoC Statement

This EUT is also classified as a device of computer peripheral Class B which DoC has to be followed. It has been verified according to the rule of 47 CFR part 15 Subpart B, and found that all the requirements has been fulfilled.



4. List of Measurements

4.1. Summary of the Test Results

Applied Standard: 47 CFR Part 15 and Part 2			
Paragraph	FCC Rule	Description of Test	Result
5.1	15.247(a)(2)	6dB Spectrum Bandwidth (DSSS System)	Pass
5.2	15.247(b)	Maximum Peak Output Power	Pass
5.3	15.247(d)	Peak Power Spectral Density	Pass
5.4	15.247(c)	Band Edges Emission	Pass
5.5	15.107/15.207	AC Power Line Conducted Emission	Pass
5.6	15.209/15.247(c)	Spurious Radiated Emission	Pass
5.7	15.203	Antenna Requirement	Pass
5.8	2.1091/2.1093	Maximum Permissible Exposure for the EUT	Pass

5. Test Result

5.1. Test of 6dB Spectrum Bandwidth (DSSS System)

5.1.1 Measuring Instruments

Item 16 of the table on section 6.

5.1.2 Test Procedures

1. The transmitter output was connected to the spectrum analyzer through an attenuator.
2. Set RBW of spectrum analyzer to 100KHz and VBW to 100KHz.
3. The 6dB bandwidth is defined as the spectrum width with level higher than 6dB below the peak level.
4. Repeat above 1~3 points for the middle and highest channel of the EUT.

5.1.3 Test Setup Layout

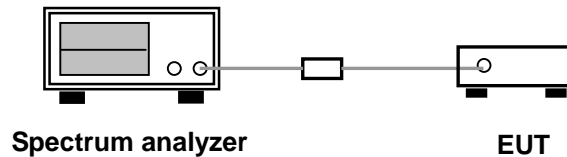

5.1.4 Test Result : See spectrum analyzer plots below

- Modulation Type: CCK
- Temperature: 25°C
- Relative Humidity: 65%
- Duty Cycle of the Equipment During the Test: 70%
- Test Engineer: Sam Lee

Channel	Frequency (MHz)	6dB Bandwidth (MHz)	Min. Limit (MHz)
01	2412	11.68	0.5
06	2437	11.68	0.5
11	2462	11.68	0.5



Modulation Type: CCK (Channel 01) :

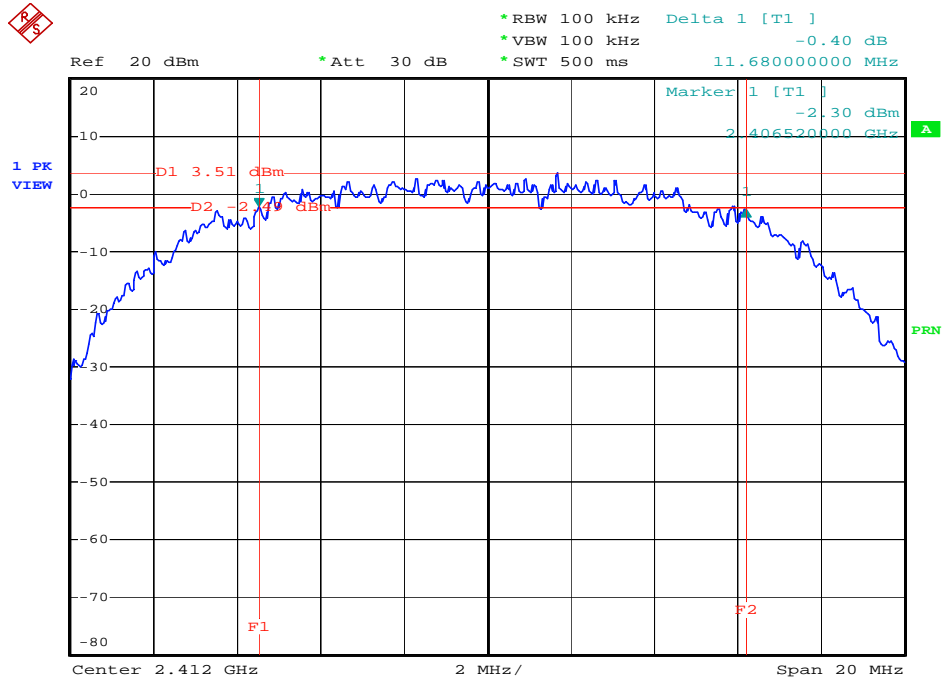

Date: 15.SEP.2004 20:48:36

Modulation Type: CCK (Channel 06) :

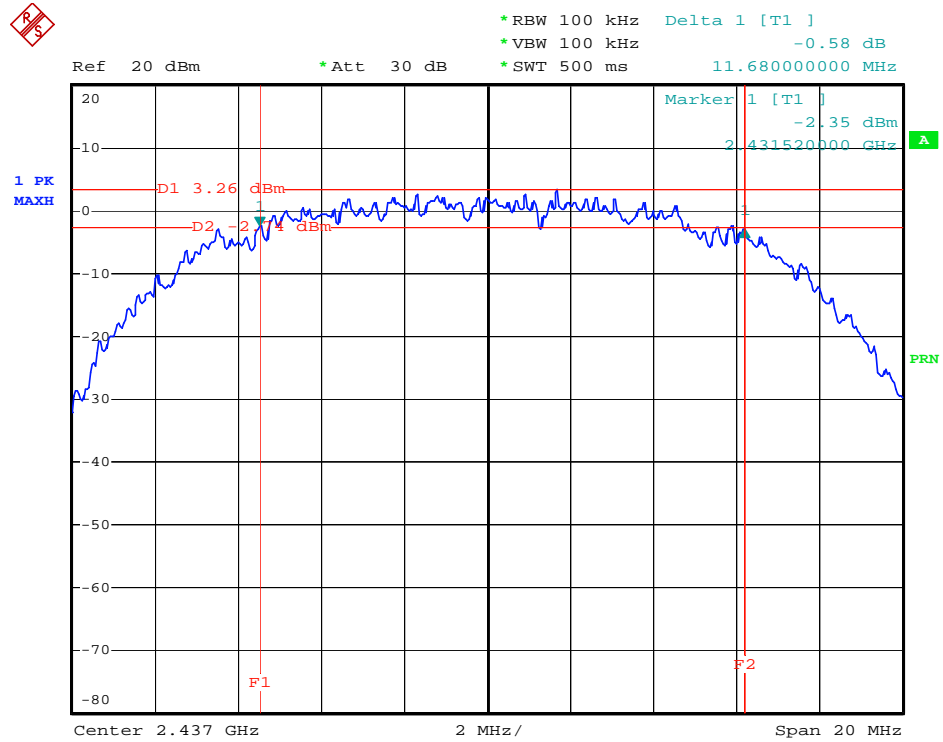

Date: 15.SEP.2004 20:50:45



Modulation Type: CCK (Channel 11) :

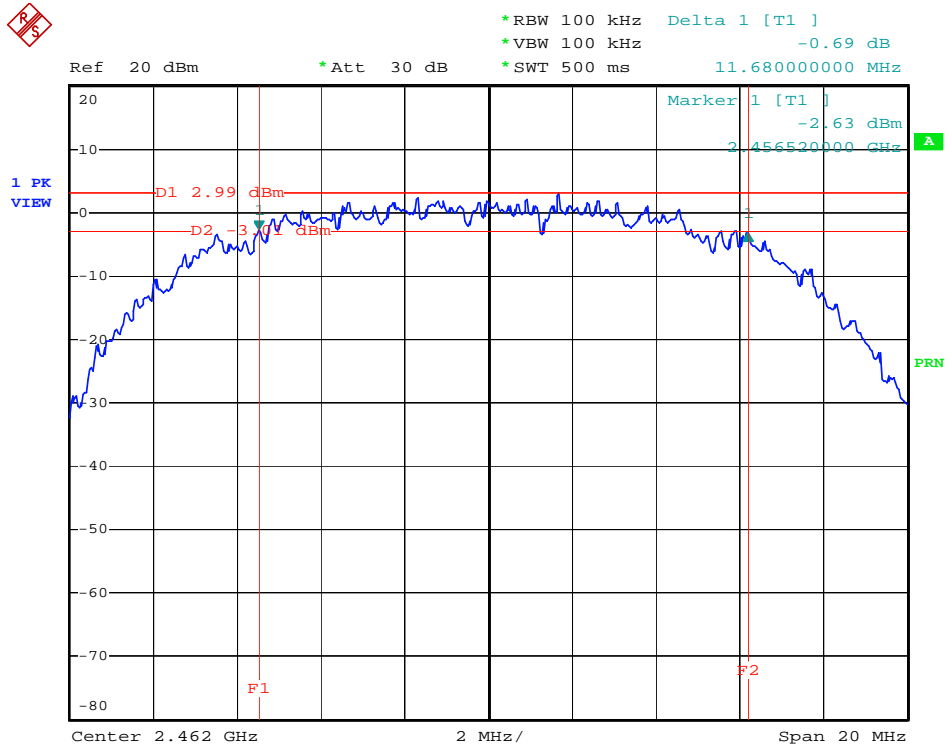

Date: 15.SEP.2004 20:56:23

5.2. Test of Maximum Peak Output Power

5.2.1 Measuring Instruments

Item 17, 19 of the table on section 6.

5.2.2 Test Procedures

1. The transmitter output was connected to the vertical channel of the oscilloscope through a detector.
2. Record peak value from the meter.
3. Repeated the 1~2 for the middle and highest channel of the EUT.

5.2.3 Test Setup Layout

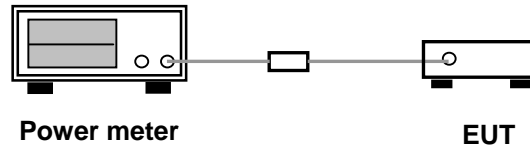

5.2.4 Test Result : See spectrum analyzer plots below

- Modulation Type: CCK
- Temperature: 25°C
- Relative Humidity: 65 %
- Duty Cycle of the Equipment During the Test: 70%
- Test Engineer: Sam Lee

Channel	Frequency (MHz)	Output Power (dBm)	Output Power (mWatt)	Limits (dBm)
01	2412	15.9	38.9	30 dBm
06	2437	15.6	36.3	30 dBm
11	2462	15.4	34.6	30 dBm

5.3. Test of Peak Power Spectral Density

5.3.1 Measuring Instruments

Item 16 of the table on section 6.

5.3.2 Test Procedures

1. The transmitter output is connected to the spectrum analyzer through an attenuator.
2. Set RBW of spectrum analyzer to 3kHz and VBW to 30kHz.
3. Mark the frequency with maximum peak power as the center of the display of the spectrum
4. Set the span to 1.5MHz and the sweep time to 500s and record the maximum peak value.
5. Repeated the 1~4 for the middle and highest channel of the EUT.

5.3.3 Test Setup Layout

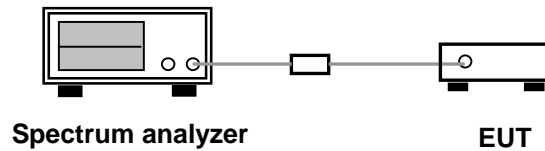

5.3.4 Test Result : See spectrum analyzer plots below

- Modulation Type: CCK
- Temperature: 25°C
- Relative Humidity: 65 %
- Duty Cycle of the Equipment During the Test: 70%
- Test Engineer: Sam Lee

Channel	Frequency (MHz)	Power Density (dBm)	Limits (dBm)
01	2412	-9.22	8
06	2437	-9.51	8
11	2462	-9.89	8



Modulation Type: CCK (Channel 01) :

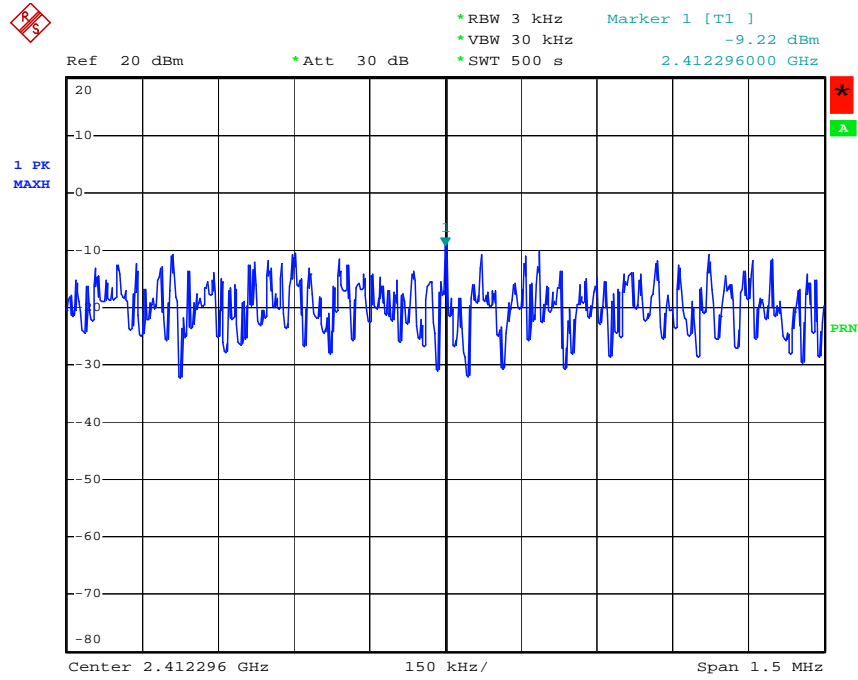

Date: 15.SEP.2004 21:00:11

Modulation Type: CCK (Channel 06) :

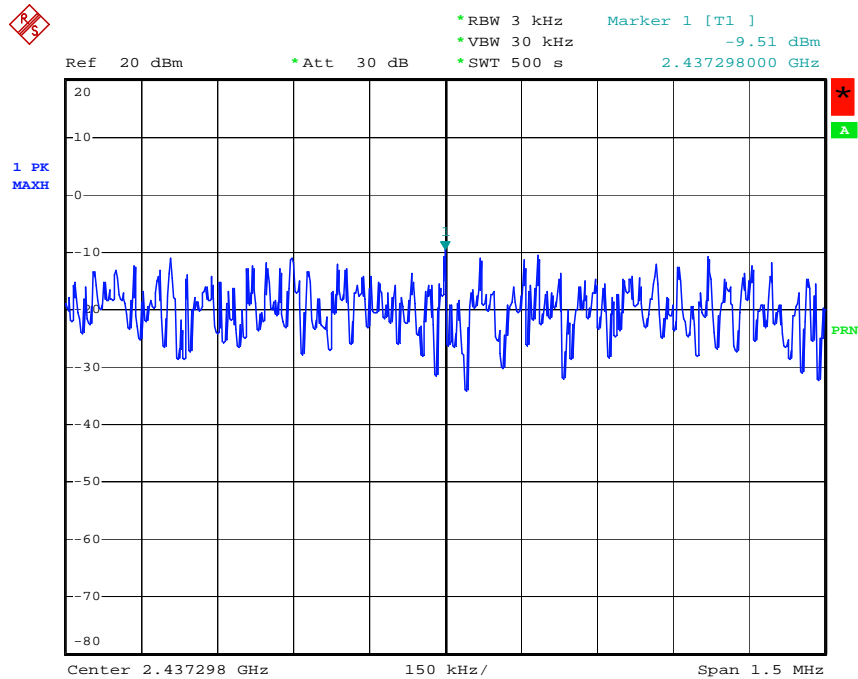

Date: 15.SEP.2004 20:59:23



Modulation Type: CCK (Channel 11) :

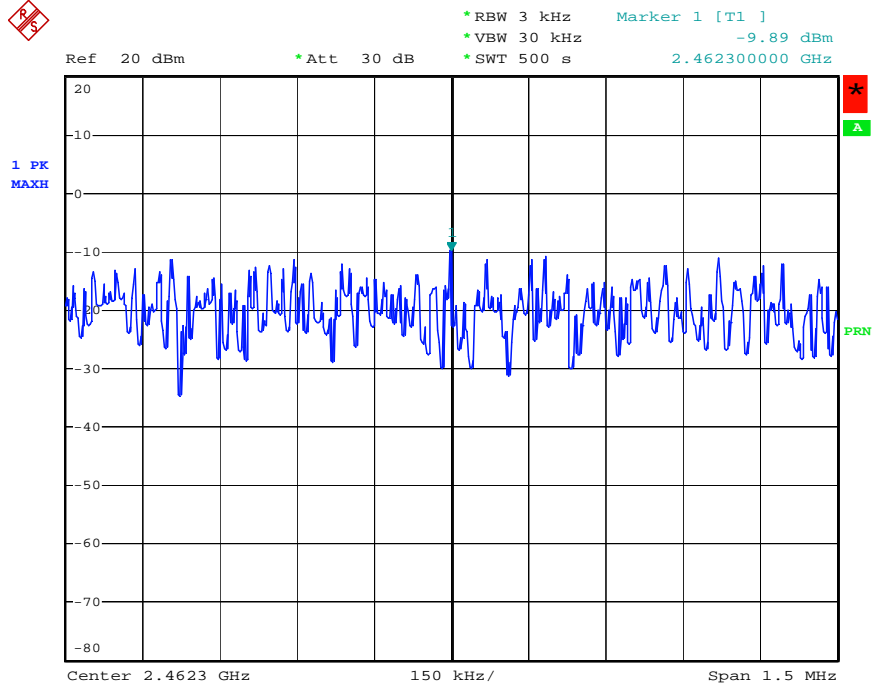

Date: 15.SEP.2004 20:57:51



5.4. Test of Band Edges Emission

5.4.1 Measuring Instruments

Item 16 of the table on section 6.

5.4.2 Test Procedures

1. The transmitter is set to the lowest channel.
2. The transmitter output was connected to the spectrum analyzer via a cable and cable loss is used as the offset of the spectrum analyzer.
3. Set both RBW and VBW of spectrum analyzer to 100KHz with convenient frequency span including 100MHz bandwidth from lower band edge.
4. The lowest band edges emission was measured and recorded.
5. The transmitter set to the highest channel and repeated 2-4.

5.4.3 Test Result :

- Modulation Type: CCK
- Test Engineer: Bunny Yao

(A) Left Edge

The band edge emission plot shows 50.83dB delta between carrier maximum power and local maximum emission in the restricted band.

CH01 Carrier power strength (dBuV/m)	Delta (dB)	The maximum field strength in restrict band (dBuV/m)	Limit (dBuV/m)	Margin (dB)
98.79	50.83	47.96	54.00	-6.04

(B) Right Edge

The band edge emission plot shows 57.76 dB delta between carrier maximum power and local maximum emission in the restricted band.

CH11 Carrier power strength (dBuV/m)	Delta (dB)	The maximum field strength in restrict band (dBuV/m)	Limit (dBuV/m)	Margin (dB)
97.52	54.12	43.40	54.00	-10.6

* The maximum field strength in restricted band is the emission of carrier power strength subtract to the delta between carrier maximum power and local maximum emission in the restricted band



Modulation Type: CCK (Channel 01) :

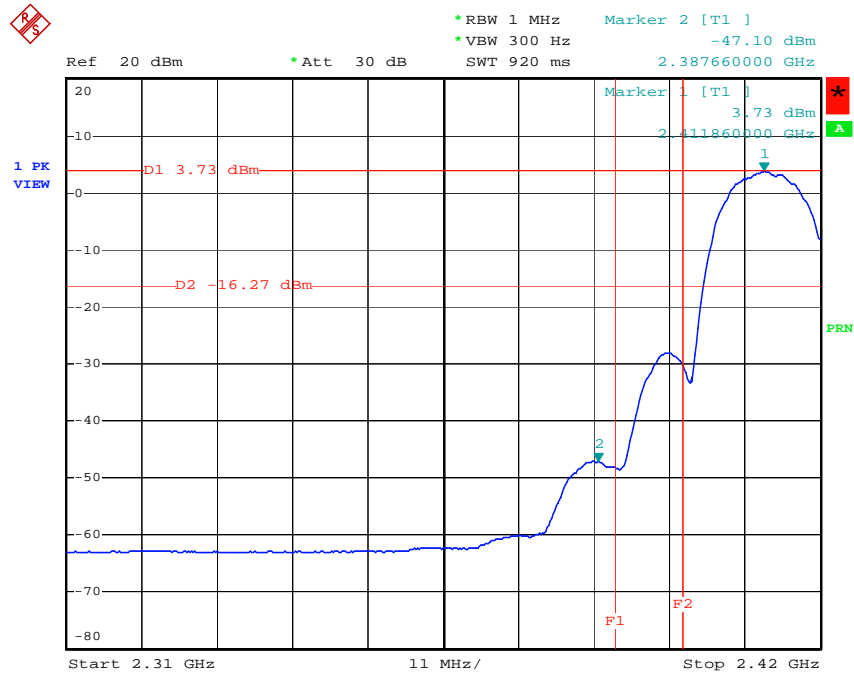

Date: 15.SEP.2004 21:03:42

Modulation Type: CCK (Channel 11) :

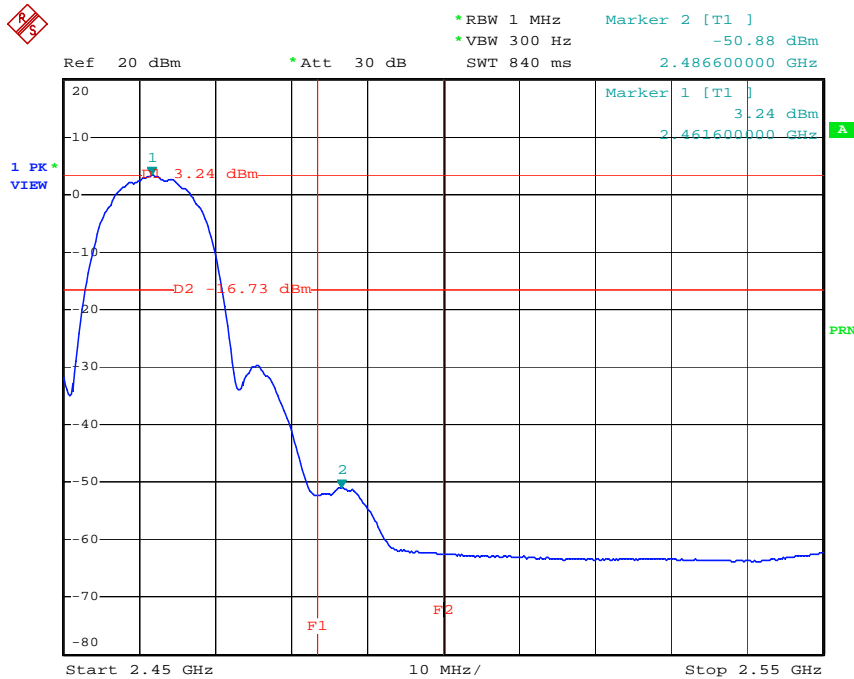

Date: 15.SEP.2004 21:06:02

Observation : All emissions in the 100kHz bandwidth are 20dB lower than the carrier strength.



5.5. Test of AC Power Line Conducted Emission

5.5.1 Measuring Instruments

Please reference item 1~4 in chapter 6 for the instruments used for testing.

5.5.2 Test Procedures

1. Configure the EUT according to ANSI C63.4.
2. The EUT has to be placed 0.4 meter far from the conducting wall of the shielding room and at least 80 centimeters from any other grounded conducting surface.
3. Connect EUT to the power mains through a line impedance stabilization network (LISN).
4. All the support units are connected to the other LISNs. The LISN should provides 50uH/50ohms coupling impedance.
5. The frequency range from 150 KHz to 30 MHz was searched.
6. Use the Channel & Power Controlling software to make the EUT working on selected channel and expected output power, then use the "H" Patter Generator software to make the supporting equipments stay on working condition.
7. Set the test-receiver system to Peak Detect Function and Specified Bandwidth with Maximum Hold Mode.
8. The measurement has to be done between each power line and ground at the power terminal for each RF channel. Only one RF channel has to be investigated since this test is independent with the RF channel selection.



5.5.3 Test Result of Conducted Emission

Test Mode	RF Link	Tested By	Hikaru Chan
Temperature / Humidity	26deg. C / 58%		

Line to Ground

	Freq	Level	Over Limit	Limit Line	Read Level	LISN Factor	Cable Loss	Remark
	MHz	dBuV	dB	dBuV	dBuV	dB	dB	
1	0.1540270	33.47	-32.31	65.78	33.36	0.10	0.01	QP
2	0.1540270	19.18	-36.60	55.78	19.07	0.10	0.01	Average
3	0.3083410	24.30	-35.72	60.02	24.18	0.10	0.02	QP
4	0.3083410	12.78	-37.24	50.02	12.66	0.10	0.02	Average
5	0.4351090	26.87	-30.28	57.15	26.75	0.10	0.02	QP
6	0.4351090	15.63	-31.52	47.15	15.51	0.10	0.02	Average
7	0.7670230	25.16	-30.84	56.00	25.03	0.10	0.03	QP
8	0.7670230	13.84	-32.16	46.00	13.71	0.10	0.03	Average
9	0.9839140	27.01	-28.99	56.00	26.87	0.10	0.04	QP
10	0.9839140	15.56	-30.44	46.00	15.42	0.10	0.04	Average
11	1.560	25.79	-30.21	56.00	25.66	0.10	0.03	QP
12	1.560	14.84	-31.16	46.00	14.71	0.10	0.03	Average

Neutral to Ground

	Freq	Level	Over Limit	Limit Line	Read Level	LISN Factor	Cable Loss	Remark
	MHz	dBuV	dB	dBuV	dBuV	dB	dB	
1	0.1540270	33.55	-32.23	65.78	33.44	0.10	0.01	QP
2	0.1540270	19.47	-36.31	55.78	19.36	0.10	0.01	Average
3	0.1996860	28.39	-35.23	63.62	28.28	0.10	0.01	QP
4	0.1996860	13.93	-39.69	53.62	13.82	0.10	0.01	Average
5	0.4811910	23.05	-33.27	56.32	22.93	0.10	0.02	QP
6	0.4811910	13.78	-32.54	46.32	13.66	0.10	0.02	Average
7	1.080	24.24	-31.76	56.00	24.10	0.10	0.04	QP
8	1.080	13.68	-32.32	46.00	13.54	0.10	0.04	Average
9	1.560	23.22	-32.78	56.00	23.09	0.10	0.03	QP
10	1.560	12.66	-33.34	46.00	12.53	0.10	0.03	Average
11	3.040	18.98	-37.02	56.00	18.83	0.10	0.05	QP
12	3.040	11.00	-35.00	46.00	10.85	0.10	0.05	Average

5.5.4 Photographs of Conducted Emission Test Configuration

- The photographs show the configuration that generates the maximum emission.

FRONT VIEW



REAR VIEW



SIDE VIEW

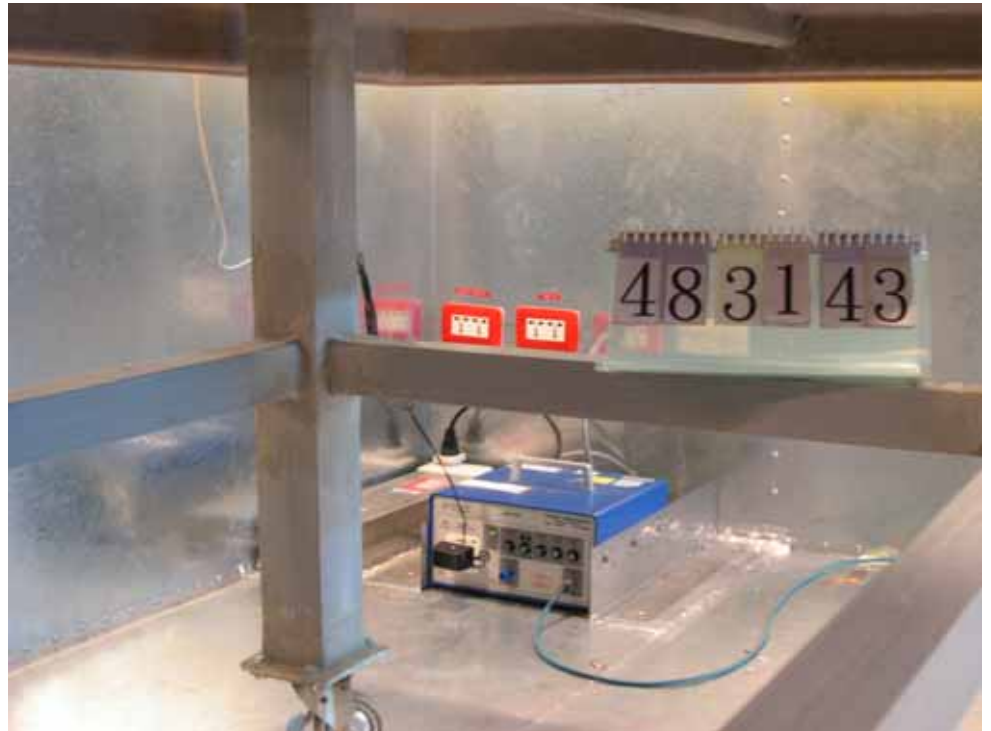



5.6. Test of Spurious Radiated Emission

5.6.1 Measuring Instruments

Please reference item 6~17 in chapter 6 for the instruments used for testing.

5.6.2 Test Procedures

1. Configure the EUT according to ANSI C63.4.
2. The EUT was placed on the top of the turn table 0.8 meter above ground.
3. The phase center of the receiving antenna mounted on the top of a height-variable antenna tower was placed 3 meters far away from the turn table.
4. Power on the EUT and all the supporting units.
5. The turn table was rotated by 360 degrees to determine the position of the highest radiation.
6. The height of the broadband receiving antenna was varied between one meter and four meters above ground to find the maximum emission field strength of both horizontal and vertical polarization.
7. For each suspected emission, the antenna tower was scan (from 1 M to 4 M) and then the turn table was rotated (from 0 degree to 360 degrees) to find the maximum reading.
8. Set the test-receiver system to Peak or CISPR quasi-peak Detect Function with specified bandwidth under Maximum Hold Mode.
9. For emission above 1GHz, use 1MHz VBW and RBW for peak reading. Then 1MHz RBW and 10Hz VBW for average reading in spectrum analyzer.
10. If the emission level of the EUT in peak mode was 3 dB lower than the average limit specified, then testing will be stopped and peak values of EUT will be reported, otherwise, the emissions which do not have 3 dB margin will be repeated one by one using the quasi-peak method for below 1GHz and average method for above the 1GHz. the reported.
11. For testing above 1GHz, the emission level of the EUT in peak mode was 20dB higher than average limit (that means the emission level in peak mode also complies with the limit in average mode), then testing will be stopped and peak values of EUT will be reported, otherwise, the emissions will be measured in average mode again and reported.

5.6.3 Test Setup Layout

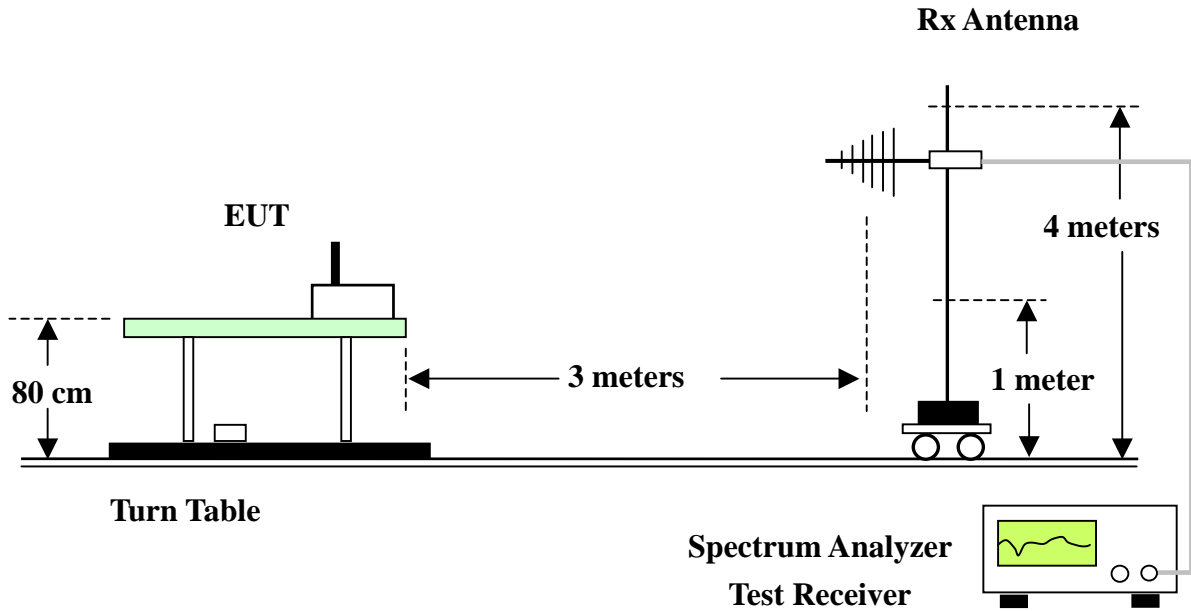



5.6.4 Test Results and Limit

Note:

Emission level (dBuV/m) = 20 log Emission level (uV/m)

Corrected Reading: Probe Factor + Cable Loss + Read Level - Preamp Factor = Level

Modulation Type	CKK				
Test Mode	CH 11	Temperature	25 deg. C	Tested By	Steve Chen
Freq. Range	30MHz~1GHz	Humidity	60%		

(A) Polarization: Horizontal

	Freq	Level	Over Limit	Limit Line	Read Level	Probe Factor	Cable Loss	Preamp Factor	Remark	Ant Pos	Table Pos
	MHz	dBuV/m	dB	dBuV/m	dBuV	dB	dB	dB		cm	deg
1	97.150	27.98	-15.52	43.50	45.32	8.85	1.71	27.90	Peak	---	---
2	152.060	28.42	-15.08	43.50	41.92	12.05	2.25	27.80	Peak	---	---
3	197.790	27.86	-15.64	43.50	37.39	15.62	2.55	27.70	Peak	---	---
1	406.400	35.34	-10.66	46.00	42.94	16.75	3.51	27.86	Peak	---	---
2	541.600	35.21	-10.79	46.00	41.98	17.84	4.13	28.74	Peak	---	---
3	768.000	36.35	-9.65	46.00	38.72	21.52	4.88	28.77	Peak	---	---

(B) Polarization: Vertical

	Freq	Level	Over Limit	Limit Line	Read Level	Probe Factor	Cable Loss	Preamp Factor	Remark	Ant Pos	Table Pos
	MHz	dBuV/m	dB	dBuV/m	dBuV	dB	dB	dB		cm	deg
1 !	33.740	34.14	-5.86	40.00	49.01	12.17	1.00	28.04	Peak	---	---
2 !	40.030	36.31	-3.69	40.00	50.66	12.60	1.07	28.02	Peak	113	94
3	44.790	33.95	-6.05	40.00	48.40	12.41	1.15	28.01	Peak	---	---
1 !	252.800	41.64	-4.36	46.00	53.88	12.40	2.85	27.49	Peak	---	---
2	361.600	38.34	-7.66	46.00	46.96	15.64	3.35	27.61	Peak	---	---
3	768.000	36.60	-9.40	46.00	38.97	21.52	4.88	28.77	Peak	---	---



Modulation Type	CCK				
Test Mode	CH 01 2412MHz	Temperature	25 deg. C	Tested By	Steve Chen
Freq. Range	1GHz~25GHz	Humidity	60%		

Horizontal

	Freq	Level	Over Limit	Limit Line	Read Level	Probe Factor	Cable Loss	Preamp Factor	Remark	Ant Pos	Table Pos
	MHz	dBuV/m	dB	dBuV/m	dBuV	dB	dB	dB		cm	deg
1	1766.000	33.13	-20.87	54.00	48.03	26.24	1.52	42.66	Average	---	---
2	1908.000	33.30	-20.70	54.00	47.63	26.78	1.57	42.68	Average	---	---
3	2012.000	33.64	-20.36	54.00	47.62	27.14	1.57	42.69	Average	---	---

Vertical

	Freq	Level	Over Limit	Limit Line	Read Level	Probe Factor	Cable Loss	Preamp Factor	Remark	Ant Pos	Table Pos
	MHz	dBuV/m	dB	dBuV/m	dBuV	dB	dB	dB		cm	deg
1	1902.000	33.32	-20.68	54.00	47.68	26.75	1.57	42.68	Average	---	---
2	2118.000	34.10	-19.90	54.00	47.67	27.42	1.68	42.67	Average	---	---
3	2790.000	36.60	-17.40	54.00	47.96	29.47	1.95	42.78	Average	---	---



Modulation Type	CCK				
Test Mode	CH 06 2437MHz	Temperature	25deg. C	Tested By	Steve Chen
Freq. Range	1GHz~25GHz	Humidity	60%		

Horizontal

	Freq	Level	Over Limit	Limit Line	Read Level	Probe Factor	Cable Loss	Preamp Factor	Remark	Ant Pos	Table Pos
	MHz	dBuV/m	dB	dBuV/m	dBuV	dB	dB	dB		cm	deg
1	1894.000	34.12	-19.88	54.00	48.50	26.72	1.58	42.68	Average	---	---
2	2582.000	36.67	-17.33	54.00	48.70	28.73	1.90	42.66	Average	---	---
3	2804.000	37.77	-16.23	54.00	49.10	29.51	1.95	42.79	Average	---	---

Vertical

	Freq	Level	Over Limit	Limit Line	Read Level	Probe Factor	Cable Loss	Preamp Factor	Remark	Ant Pos	Table Pos
	MHz	dBuV/m	dB	dBuV/m	dBuV	dB	dB	dB		cm	deg
1	1460.000	32.72	-21.28	54.00	48.71	25.13	1.46	42.58	Average	---	---
2	1574.000	32.91	-21.09	54.00	48.51	25.53	1.49	42.62	Average	---	---
3	1902.000	33.78	-20.22	54.00	48.14	26.75	1.57	42.68	Average	---	---
1	4180.000	39.67	-14.33	54.00	48.53	32.62	2.43	43.91	Average	---	---
2	4348.000	39.56	-14.44	54.00	48.66	32.56	2.36	44.02	Average	---	---
3	4468.000	40.31	-13.69	54.00	49.48	32.51	2.41	44.09	Average	157	33



Modulation Type	CCK				
Test Mode	CH 11 2462MHz	Temperature	25 deg. C	Tested By	Steve Chen
Freq. Range	1GHz~25GHz	Humidity	60%		

Horizontal

	Freq	Level	Over Limit	Limit Line	Read Level	Probe Factor	Cable Loss	Preamp Factor	Remark	Ant Pos	Table Pos
	MHz	dBuV/m	dB	dBuV/m	dBuV	dB	dB	dB		cm	deg
1	1878.000	33.76	-20.24	54.00	48.19	26.66	1.59	42.68	Average	---	---
2	2012.000	33.96	-20.04	54.00	47.94	27.14	1.57	42.69	Average	---	---
3	2126.000	34.57	-19.43	54.00	48.12	27.44	1.68	42.67	Average	---	---

Vertical

	Freq	Level	Over Limit	Limit Line	Read Level	Probe Factor	Cable Loss	Preamp Factor	Remark	Ant Pos	Table Pos
	MHz	dBuV/m	dB	dBuV/m	dBuV	dB	dB	dB		cm	deg
1	1676.000	32.27	-21.73	54.00	47.45	25.91	1.55	42.64	Average	---	---
2	2236.000	34.61	-19.39	54.00	47.82	27.73	1.71	42.65	Average	---	---
3	2348.000	35.75	-18.25	54.00	48.67	28.03	1.68	42.63	Average	---	---
1	3686.000	39.78	-14.22	54.00	49.55	31.85	1.81	43.43	Average	---	---
2	3972.000	40.09	-13.91	54.00	49.79	32.66	1.41	43.77	Average	---	---
3	4406.000	40.63	-13.37	54.00	49.71	32.53	2.44	44.05	Average	119	341

5.6.5 Photographs of Radiated Emission Test Configuration

- The photographs show the configuration that generates the maximum emission.

FRONT VIEW

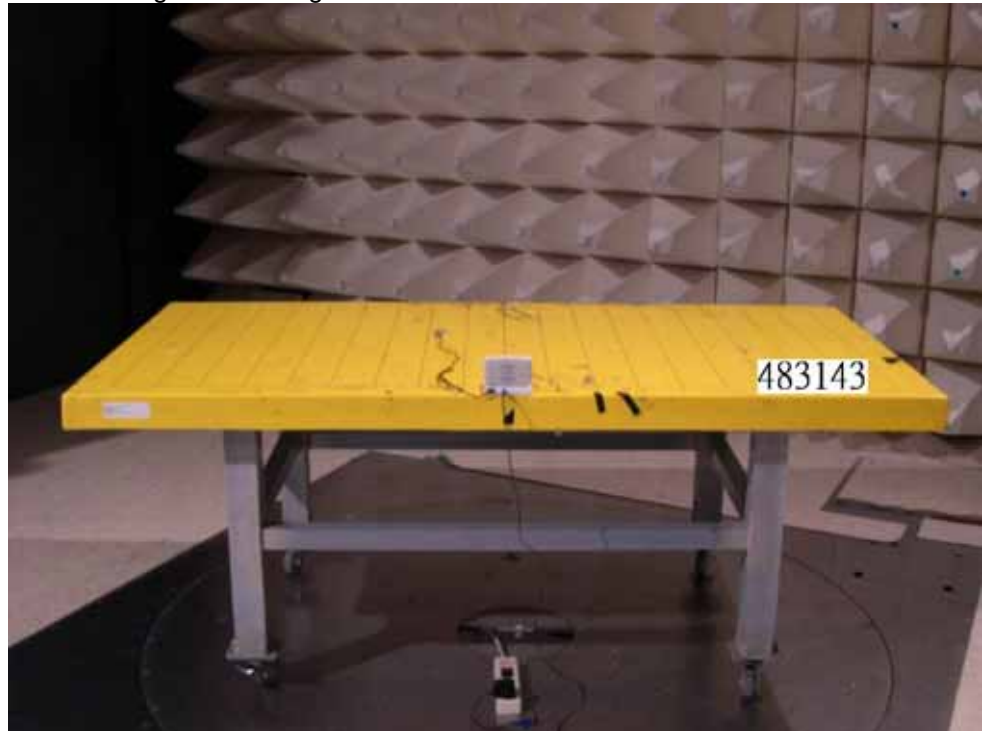

REAR VIEW





5.7. Antenna Requirements

5.7.1 Standard Applicable

47 CFR Part15 Section 15.203:

An intentional radiator shall be designed to ensure that no antenna other than that furnished by the responsible party shall be used with the device.

47 CFR Part15 Section 15.247 (b):

If transmitting antennas of directional gain greater than 6 dBi are used, the peak output power from the intentional radiator shall be reduced by the amount in dB that the directional gain of the antenna exceeds 6 dBi.

If the intentional radiator is used exclusively for fixed, point-to-point operations may employ transmitting antennas with directional gain greater than 6 dBi provided the maximum peak output power of the intentional radiator is reduced by 1 dB for every 3 dB that the directional gain of the antenna exceeds 6 dBi.

5.7.2 Antenna Connected Construction

The antenna used in this product is monopole Antenna, and there is no antenna connector.



6. List of Measuring Equipments Used

Items	Instrument	Manufacturer	Model No.	Serial No.	Characteristics	Calibration Date	Remark
1	EMC Receiver	R&S	ESCS 30	100174	9 KHz – 2.75 GHz	Feb. 16, 2004	Conduction (CO04-HY)
2	LISN	MessTec	NNB-2/16Z	2001/004	9 KHz – 30 MHz	Jun. 09, 2004	Conduction (CO04-HY)
3	LISN (Support Unit)	MessTec	NNB-2/16Z	99041	9 KHz – 30 MHz	Apr. 27, 2004	Conduction (CO04-HY)
4	EMI Filter	LINDGREN	LRE-2030	2651	< 450 Hz	N/A	Conduction (CO04-HY)
5	RF Cable-CON	UTIFLEX	3102-26886-4	CB044	9KHz~30MHz	Apr. 21, 2004	Conduction (CO04-HY)
6	3m Semi Anechoic Chamber	SIDT FRANKONIA	SAC-3M	03CH03-HY	30MHz~1GHz 3m	Jun. 21, 2004	Radiation (03CH03-HY)
7	Spectrum analyzer	R&S	FSP40	100004	9KHZ~40GHz	Aug. 22, 2004	Radiation (03CH03-HY)
8	Amplifier	HP	8447D	2944A09072	100KHz – 1.3GHz	Nov. 04, 2004	Radiation (03CH03-HY)
9	Biconical Antenna	SCHWARZBECK	VHBB 9124	301	30MHz –200MHz	Jul. 28, 2004	Radiation (03CH03-HY)
10	Log Antenna	SCHWARZBECK	VUSLP 9111	221	200MHz -1GHz	Jul. 28, 2004	Radiation (03CH03-HY)
11	RF Cable-R03m	Jye Bao	RG142	CB021	30MHz~1GHz	Dec. 03, 2003	Radiation (03CH03-HY)
12	Amplifier	MITEQ	AFS44	849984	100MHz~26.5GHz	Mar. 26, 2004	Radiation (03CH03-HY)
13	Horn Antenna	EMCO	3115	6821	1GHz – 18GHz	Sep. 11, 2004	Radiation (03CH03-HY)
14	Turn Table	HD	DS 420	420/650/00	0 ~ 360 degree	N/A	Radiation (03CH03-HY)
15	Antenna Mast	HD	MA 240	240/560/00	1 m - 4 m	N/A	Radiation (03CH03-HY)
16	Horn Antenna	Schwarzbeck	BBHA9170	154	15GHz~40GHz	Jun. 09, 2004	Radiation (03CH03-HY)
17	RF Cable-HIGH	Jye Bao	RG142	CB030-HIGH	1GHz~29.5GHz	Dec. 05, 2003	Radiation (03CH03-HY)

Calibration Interval of instruments listed above is one year.



Items	Instrument	Manufacturer	Model No.	Serial No.	Characteristics	Calibration Date	Remark
16	Spectrum analyzer	R&S	FSP7	838858/014	9KHZ~7GHZ	Sep. 02, 2004	Conducted (TH01-HY)
17	Power meter	R&S	NRVS	100967	DC~40GHz	Mar. 02, 2004	Conducted (TH01-HY)
18	Power sensor	R&S	NRV-Z51	100666	DC~40GHz	Mar 18, 2004	Conducted (TH01-HY)
19	Power Sensor	R&S	NRV-Z32	836953/060	30MHz-6GHz	Mar. 11, 2004	Conducted (TH01-HY)
20	AC power source	G.W.	GPC-6030D	C671845	DC 1V~60V	Nov. 06, 2003	Conducted (TH01-HY)
21	Temp. and Humidity Chamber	KSON	THS-C3L	612	N/A	Oct. 01, 2003	Conducted (TH01-HY)
22	RF CABLE-1m	Jye Bao	RG142	CB034-1m	20MHz~7GHz	Jan. 01, 2004	Conducted (TH01-HY)
23	RF CABLE-2m	Jye Bao	RG142	CB035-2m	20MHz~1GHz	Jan. 01, 2004	Conducted (TH01-HY)

Calibration Interval of instruments listed above is one year.