

**FCC 47 CFR PART 15 SUBPART E &
INDUSTRY CANADA RSS-247**

TEST REPORT

For

Wi-Fi (11a/b/g/n 2Tx2R)+BT (V4.1LE) USB Combo Module

Model:

WCBN4515R, WCBN4515R(Ext), WCBN4515R(Emb)

Trade Name: LITE-ON

Issued to

Lite-On Technology Corp.

**Bldg. C, 90, Chien 1 Road, Chung Ho, New Taipei City 23585, Taiwan,
R.O.C**

Issued by

Compliance Certification Services Inc.

**No.11, Wugong 6th Rd., Wugu Dist.,
New Taipei City 24891, Taiwan. (R.O.C.)**

<http://www.ccsrf.com>

service@ccsrf.com

Issued Date: September 30, 2016



Note: This report shall not be reproduced except in full, without the written approval of Compliance Certification Services Inc. This document may be altered or revised by Compliance Certification Services Inc. personnel only, and shall be noted in the revision section of the document.

Revision History

Rev.	Issue Date	Revisions	Effect Page	Revised By
00	September 30, 2016	Initial Issue	ALL	Doris Chu
01	December 10, 2016	<ol style="list-style-type: none">1. Add remark for Part 15.2032. Revised Antenna Spec "Printed to PCB"3. Revised Printed to PCB in test mode4. Revised UNII-1 Power Limit for IC EIRP.	P.5, P.8, P.78	Doris Chu

TABLE OF CONTENTS

1. TEST RESULT CERTIFICATION	4
2. EUT DESCRIPTION	5
3. TEST METHODOLOGY	6
3.1 EUT CONFIGURATION	6
3.2 FCC PART 15.205 RESTRICTED BANDS OF OPERATIONS	6
3.3 DESCRIPTION OF TEST MODES	7
3.4 THE WORST CASE POWER SETTING PARAMETER	9
4. INSTRUMENT CALIBRATION	12
4.1 MEASURING INSTRUMENT CALIBRATION	12
4.2 MEASUREMENT EQUIPMENT USED	12
4.3 MEASUREMENT UNCERTAINTY	13
5. FACILITIES AND ACCREDITATIONS	14
5.1 FACILITIES	14
5.2 EQUIPMENT	14
5.3 LABORATORY ACCREDITATIONS AND LISTING.....	14
5.4 TABLE OF ACCREDITATIONS AND LISTINGS.....	15
6. SETUP OF EQUIPMENT UNDER TEST	16
6.1 SETUP CONFIGURATION OF EUT	16
6.2 SUPPORT EQUIPMENT	16
7. FCC PART 15 REQUIREMENTS & RSS-247 REQUIREMENTS	17
7.1 99% BANDWIDTH.....	17
7.2 26 DB EMISSION BANDWIDTH.....	47
7.3 MAXIMUM CONDUCTED OUTPUT POWER.....	77
7.4 BAND EDGES MEASUREMENT.....	81
7.5 PEAK POWER SPECTRAL DENSITY.....	134
7.6 RADIATED UNDESIRABLE EMISSION	164
7.7 POWERLINE CONDUCTED EMISSIONS.....	220
7.8 FREQUENCY STABILITY	223
7.9 DYNAMIC FREQUENCY SELECTION.....	225
APPENDIX I PHOTOGRAPHS OF TEST SETUP	238

1. TEST RESULT CERTIFICATION

Applicant: Lite-On Technology Corp.
Bldg. C, 90, Chien 1 Road, Chung Ho, New Taipei City 23585,
Taiwan, R.O.C

Manufacturer: LITE-ON TECHNOLOGY (Changzhou) CO., LTD
A9 Building, No.88 Yanghu Road, Wujin Hi-Tech Industrial
Development Zone, Changzhou City,
Jiangsu Province 213100 China

Equipment Under Test: Wi-Fi (11a/b/g/n 2Tx2R)+BT (V4.1LE) USB Combo Module

Model Number: WCBN4515R, WCBN4515R(Ext), WCBN4515R(Emb)

Trade Name: LITE-ON

Date of Test: September 7 ~ 26, 2016

APPLICABLE STANDARDS	
STANDARD	TEST RESULT
FCC 47 CFR Part 15 Subpart E & Industry Canada RSS-247 Issue 1	No non-compliance noted

We hereby certify that:

Compliance Certification Services Inc. tested the above equipment. The test data, data evaluation, test procedures, and equipment configurations shown in this report were made in accordance with the procedures given in ANSI C63.10: 2013 and the energy emitted by the sample EUT tested as described in this report is in compliance with conducted and radiated emission limits of FCC Rules Part 15.407 and Industry Canada RSS-247 Issue 1.

The test results of this report relate only to the tested sample identified in this report.

Approved by:



Sam Chuang
Manager
Compliance Certification Services Inc.

Tested by:

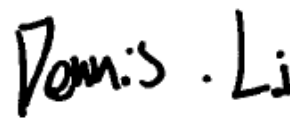

Dennis Li
Engineer
Compliance Certification Services Inc.

2. EUT DESCRIPTION

Product	Wi-Fi (11a/b/g/n 2Tx2R)+BT (V4.1LE) USB Combo Module					
Model Number	WCBN4515R, WCBN4515R(Ext), WCBN4515R(Emb)					
Trade Name	LITE-ON					
Model Discrepancy	WCBN4515R : PCB Antenna WCBN4515R(Ext) : WiFi PCB Antenna, BT PIFA Antenna WCBN4515R(Emb) : PCB Antenna					
Received Date	September 5, 2016					
Power supply	Power form host device.					
Operating Frequency Range & Number of Channels	U-NII-1	Mode	Frequency Range (MHz)	Number of Channels		
		IEEE 802.11a	5180 ~ 5240	4 Channels		
		IEEE 802.11n HT 20 MHz	5180 ~ 5240	4 Channels		
	U-NII-2A	IEEE 802.11n HT 40 MHz	5190 ~ 5230	2 Channels		
		IEEE 802.11a	5260 ~ 5320	4 Channels		
		IEEE 802.11n HT 20 MHz	5260 ~ 5320	4 Channels		
	U-NII-2C	IEEE 802.11n HT 40 MHz	5270 ~ 5310	2 Channels		
		IEEE 802.11a	5500 ~ 5700	8 Channels		
		IEEE 802.11n HT 20 MHz	5500 ~ 5700	8 Channels		
	Transmit Power	U-NII-1	Mode	Frequency Range (MHz)	Output Power (dBm)	Output Power (w)
			IEEE 802.11a	5180 ~ 5240	15.29	0.0338
			IEEE 802.11n HT 20 MHz	5180 ~ 5240	19.43	0.0877
U-NII-2A		IEEE 802.11n HT 40 MHz	5190 ~ 5230	17.90	0.0617	
		IEEE 802.11a	5260 ~ 5320	15.46	0.0352	
		IEEE 802.11n HT 20 MHz	5260 ~ 5320	19.37	0.0865	
U-NII-2C		IEEE 802.11n HT 40 MHz	5270 ~ 5310	17.89	0.0615	
		IEEE 802.11a	5500 ~ 5700	15.46	0.0352	
		IEEE 802.11n HT 20 MHz	5500 ~ 5700	19.33	0.0857	
IEEE 802.11n HT 40 MHz	5510 ~ 5670	17.88	0.0614			
Modulation Technique	OFDM (64QAM, 16QAM, QPSK, BPSK)					
Antenna Specification	PCB Antenna Ant1: Gain: 1.88dBi Ant2: Gain: -0.17dBi					
Product SW/HW version	3.3.0 / V00					
Radio SW version	3.3.0					
Radio HW version	V00					

Remark:

- The sample selected for test was engineering sample that approximated to production product and was provided by manufacturer.
- Antenna was meets the rule of Part 15.203 Antenna requirement.

Antenna Category	<input checked="" type="checkbox"/> Integral: antenna permanently attached <input type="checkbox"/> External dedicated antennas <input type="checkbox"/> External Unique antenna connector
-------------------------	--

3. TEST METHODOLOGY

The tests documented in this report were performed in accordance with ANSI C63.10: 2013 and FCC CFR 47 Part 15.207, 15.209, 15.407, KDB 644545 D03 v01, KDB 905462 D02 v02, KDB 905462 D03 v01r01/KDB 905462 D06 v02/KDB 905462 D07 v02, IC RSS-247 and IC RSS-Gen.

3.1 EUT CONFIGURATION

The EUT configuration for testing is installed for RF field strength measurement to meet the Commissions requirement, and is operated in a manner intended to generate the maximum emission in a continuous normal application.

3.2 FCC PART 15.205 RESTRICTED BANDS OF OPERATIONS

(a) Except as shown in paragraph (d) of this section, only spurious emissions are permitted in any of the frequency bands listed below:

MHz	MHz	MHz	GHz
0.090 - 0.110	16.42 - 16.423	399.9 - 410	4.5 - 5.15
¹ 0.495 - 0.505	16.69475 - 16.69525	608 - 614	5.35 - 5.46
2.1735 - 2.1905	16.80425 - 16.80475	960 - 1240	7.25 - 7.75
4.125 - 4.128	25.5 - 25.67	1300 - 1427	8.025 - 8.5
4.17725 - 4.17775	37.5 - 38.25	1435 - 1626.5	9.0 - 9.2
4.20725 - 4.20775	73 - 74.6	1645.5 - 1646.5	9.3 - 9.5
6.215 - 6.218	74.8 - 75.2	1660 - 1710	10.6 - 12.7
6.26775 - 6.26825	108 - 121.94	1718.8 - 1722.2	13.25 - 13.4
6.31175 - 6.31225	123 - 138	2200 - 2300	14.47 - 14.5
8.291 - 8.294	149.9 - 150.05	2310 - 2390	15.35 - 16.2
8.362 - 8.366	156.52475 -	2483.5 - 2500	17.7 - 21.4
8.37625 - 8.38675	156.52525	2655 - 2900	22.01 - 23.12
8.41425 - 8.41475	156.7 - 156.9	3260 - 3267	23.6 - 24.0
12.29 - 12.293	162.0125 - 167.17	3332 - 3339	31.2 - 31.8
12.51975 - 12.52025	167.72 - 173.2	3345.8 - 3358	36.43 - 36.5
12.57675 - 12.57725	240 - 285	3600 - 4400	(²)
13.36 - 13.41	322 - 335.4		

¹ Until February 1, 1999, this restricted band shall be 0.490-0.510 MHz.

² Above 38.6

(b) Except as provided in paragraphs (d) and (e), the field strength of emissions appearing within these frequency bands shall not exceed the limits shown in Section 15.209. At frequencies equal to or less than 1000 MHz, compliance with the limits in Section 15.209 shall be demonstrated using measurement instrumentation employing a CISPR quasi-peak detector. Above 1000 MHz, compliance with the emission limits in Section 15.209 shall be demonstrated based on the average value of the measured emissions. The provisions in Section 15.35 apply to these measurements.

3.3 DESCRIPTION OF TEST MODES

The EUT (model: WCBN4515R) had been tested under operating condition.

The EUT is a 2x2 configuration spatial MIMO (2Tx & 2Rx) without beam forming function that operate in double TX chains and double RX chains. The 2x2 configuration is implemented with two outside TX & RX chains (Chain 0 and 1).

Software used to control the EUT for staying in continuous transmitting mode was programmed.

After verification, all tests were carried out with the worst case test modes as shown below except radiated spurious emission below 1GHz, which worst case was in normal link mode only.

U-NII-1:

IEEE 802.11a for 5180 ~ 5240MHz:

Channel Low (5180MHz), Channel Mid (5220MHz) and Channel High (5240MHz) with 6Mbps data rate were chosen for full testing.

IEEE 802.11n HT 20 MHz for 5180 ~ 5240MHz:

Channel Low (5180MHz), Channel Mid (5220MHz) and Channel High (5240MHz) with 6.5Mbps data rate were chosen for full testing.

IEEE 802.11n HT 40 MHz for 5190 ~ 5230MHz:

Channel Low (5190MHz) and Channel High (5230MHz) with 13.5Mbps data rate were chosen for full testing.

U-NII-2A:

IEEE 802.11a for 5260 ~ 5320MHz:

Channel Low (5260MHz), Channel Mid (5280MHz) and Channel High (5320MHz) with 6Mbps data rate were chosen for full testing.

IEEE 802.11n HT 20 MHz for 5260 ~ 5320MHz:

Channel Low (5260MHz), Channel Mid (5280MHz) and Channel High (5320MHz) with 6.5Mbps data rate were chosen for full testing.

IEEE 802.11n HT 40 MHz for 5270 ~ 5310MHz:

Channel Low (5270MHz) and Channel High (5310MHz) with 13.5Mbps data rate were chosen for full testing.

U-NII-2C:

IEEE 802.11a for 5500 ~ 5700MHz:

Channel Low (5500MHz), Channel Mid (5580MHz) and Channel High (5700MHz) with 6Mbps data rate were chosen for full testing.

IEEE 802.11n HT 20 MHz for 5500 ~ 5700MHz:

Channel Low (5500MHz), Channel Mid (5580MHz) and Channel High (5700MHz) with 6.5Mbps data rate were chosen for full testing.

IEEE 802.11n HT 40 MHz for 5510 ~ 5670MHz:

Channel Low (5510MHz), Channel Mid (5550MHz) and Channel High (5670MHz) with 13.5Mbps data rate were chosen for full testing.

3.3.1 The worst mode of measurement

AC Conducted Emission	
Test Condition	AC Power line conducted emission for line and neutral
Voltage/Hz	120V/60Hz
Test Mode	Mode 1: PCB Antenna (EUT via USB link NB)
Worst Mode	<input checked="" type="checkbox"/> Mode 1 <input type="checkbox"/> Mode 2 <input type="checkbox"/> Mode 3 <input type="checkbox"/> Mode 4

Remark: The worst mode was record in this test report.

Radiated Emission Measurement	
Test Condition	Band edge, Emission for Unwanted and Fundamental
Voltage/Hz	120V/60Hz
Test Mode	Mode 1: PCB Antenna (EUT via USB link NB)
Worst Mode	<input checked="" type="checkbox"/> Mode 1 <input type="checkbox"/> Mode 2 <input type="checkbox"/> Mode 3 <input type="checkbox"/> Mode 4
Position	<input type="checkbox"/> Placed in fixed position. <input type="checkbox"/> Placed in fixed position at X-Plane (E2-Plane) <input checked="" type="checkbox"/> Placed in fixed position at Y-Plane (E1-Plane) <input type="checkbox"/> Placed in fixed position at Z-Plane (H-Plane)

Remark:

- 1. The worst mode was record in this test report.*
- 2. The EUT pre-scanned in three axis ,X,Y, Z and two polarity, Horizontal and Vertical for radiated measurement. The worst case (Y-Plane and Vertical) were recorded in this report.*

3.4 THE WORST CASE POWER SETTING PARAMETER

Test mode: IEEE 802.11a mode / 5180 ~ 5240MHz

Channel	Frequency (MHz)	RF power setting in TEST SW
Low	5180	1D
Mid	5220	1D
High	5240	1D

Test mode: IEEE 802.11n HT 20 MHz mode / 5180 ~ 5240MHz

Channel	Frequency (MHz)	RF power setting in TEST SW (Chin 0)	RF power setting in TEST SW (Chin 1)
Low	5180	20	1E
Mid	5220	1F	1E
High	5240	1F	1E

Test mode: IEEE 802.11n HT 40 MHz mode / 5190 ~ 5230MHz

Channel	Frequency (MHz)	RF power setting in TEST SW (Chin 0)	RF power setting in TEST SW (Chin 1)
Low	5190	21	20
High	5230	21	20

Test mode: IEEE 802.11a mode / 5260 ~ 5320MHz

Channel	Frequency (MHz)	RF power setting in TEST SW
Low	5260	1D
Mid	5280	1C
High	5320	1C

Test mode: IEEE 802.11n HT 20 MHz mode / 5260 ~ 5320MHz

Channel	Frequency (MHz)	RF power setting in TEST SW (Chin 0)	RF power setting in TEST SW (Chin 1)
Low	5260	20	1D
Mid	5280	20	1D
High	5320	21	1C

Test mode: IEEE 802.11n HT 40 MHz mode / 5270 ~ 5310MHz

Channel	Frequency (MHz)	RF power setting in TEST SW (Chin 0)	RF power setting in TEST SW (Chin 1)
Low	5270	21	1F
High	5310	22	1E

Test mode: IEEE 802.11a mode / 5500 ~ 5700MHz

Channel	Frequency (MHz)	RF power setting in TEST SW
Low	5500	1A
Mid	5580	1A
High	5700	1A

Test mode: IEEE 802.11n HT 20 MHz mode / 5500 ~ 5720MHz

Channel	Frequency (MHz)	RF power setting in TEST SW (Chin 0)	RF power setting in TEST SW (Chin 1)
Low	5500	20	1A
Mid	5580	20	1B
High	5700	20	1B

Test mode: IEEE 802.11n HT 40 MHz mode / 5510 ~ 5670MHz

Channel	Frequency (MHz)	RF power setting in TEST SW (Chin 0)	RF power setting in TEST SW (Chin 1)
Low	5510	22	1C
Mid	5550	22	1C
High	5670	21	1C

4. INSTRUMENT CALIBRATION

4.1 MEASURING INSTRUMENT CALIBRATION

The measuring equipment, which was utilized in performing the tests documented herein, has been calibrated in accordance with the manufacturer's recommendations for utilizing calibration equipment, which is traceable to recognized national standards.

4.2 MEASUREMENT EQUIPMENT USED

Equipment Used for Emissions Measurement

RF Conducted Test Site					
Name of Equipment	Manufacturer	Model	Serial Number	Calibration Date	Calibration Due
Power Meter	Anritsu	ML2495A	1012009	07/04/16	07/03/17
Power Meter	Anritsu	MA2411B	917072	07/04/16	07/03/17
Spectrum Analyzer	R&S	FSV 40	101073	08/01/16	07/31/17

Wugu 966 Chamber A					
Name of Equipment	Manufacturer	Model	Serial Number	Calibration Date	Calibration Due
Spectrum Analyzer	Agilent	E4446A	US42510252	12/08/15	12/07/16
Loop Ant	COM-POWER	AL-130	121051	02/25/16	02/24/17
Bilog Antenna	Sunol Sciences	JB3	A030105	07/03/16	07/02/17
Pre-Amplifier	EMEC	EM330	60609	06/08/16	06/07/17
Horn Antenna	ETC	MCTD 1209	DRH13M02003	09/02/16	09/01/17
Antenna Tower	CCS	CC-A-1F	N/A	N.C.R	N.C.R
Controller	CCS	CC-C-1F	N/A	N.C.R	N.C.R
Turn Table	CCS	CC-T-1F	N/A	N.C.R	N.C.R
Software	EZ-EMC (CCS-3A1RE)				

Conducted Emission Room # B					
Name of Equipment	Manufacturer	Model	Serial Number	Calibration Date	Calibration Due
LISN	SCHWARZBECK	NSLK 8127	8127-541	11/23/15	11/22/16
Receiver	R&S	ESCI	101073	08/20/16	08/19/17
Software	CCS-3A1-CE				

Remark:

- Each piece of equipment is scheduled for calibration once a year and Precision Dipole is scheduled for calibration once three years.
- N.C.R. = No Calibration Request.

4.3 MEASUREMENT UNCERTAINTY

PARAMETER	UNCERTAINTY
Powerline Conducted Emission	+/- 1.2575
3M Semi Anechoic Chamber / 30M~200M	+/- 4.0138
3M Semi Anechoic Chamber / 200M~1000M	+/- 3.9483
3M Semi Anechoic Chamber / 1G~8G	+/- 2.5975
3M Semi Anechoic Chamber / 8G~18G	+/- 2.6112
3M Semi Anechoic Chamber / 18G~26G	+/- 2.7389
3M Semi Anechoic Chamber / 26G~40G	+/- 2.9683

Remark: This uncertainty represents an expanded uncertainty expressed at approximately the 95% confidence level using a coverage factor of $k=2$.

5. FACILITIES AND ACCREDITATIONS

5.1 FACILITIES

All measurement facilities used to collect the measurement data are located at

- No.199, Chunghsen Road, Hsintien City, Taipei Hsien, Taiwan, R.O.C.
Tel: 886-2-2217-0894 / Fax: 886-2-2217-1029
- No.11, Wugong 6th Rd., Wugu Dist., New Taipei City 24891, Taiwan. (R.O.C.)
Tel: 886-2-2299-9720 / Fax: 886-2-2298-4045
- No.81-1, Lane 210, Bade 2nd Rd., Luchu Hsiang, Taoyuan Hsien 338, Taiwan
Tel: 886-3-324-0332 / Fax: 886-3-324-5235

The sites are constructed in conformance with the requirements of ANSI C63.7, ANSI C63.10: 2013 and CISPR Publication 22.

5.2 EQUIPMENT

Radiated emissions are measured with one or more of the following types of linearly polarized antennas: tuned dipole, biconical, log periodic, bi-log, ridged waveguide, horn and/or Loop. Spectrum analyzers with pre-selectors and quasi-peak detectors are used to perform radiated measurements.

Conducted emissions are measured with Line Impedance Stabilization Networks and EMI Test Receivers.



Calibrated wideband preamplifiers, coaxial cables, and coaxial attenuators are also used for making measurements.

All receiving equipment conforms to CISPR Publication 16-1, "Radio Interference Measuring Apparatus and Measurement Methods."

5.3 LABORATORY ACCREDITATIONS AND LISTING

The test facilities used to perform radiated and conducted emissions tests are accredited by American Association for Laboratory Accreditation Program for the specific scope accreditation under Lab Code: 0824-01 to perform Electromagnetic Interference tests according to FCC Part 15 and CISPR 22 requirements. In addition, the test facilities are listed with Industry Canada, Certification and Engineering Bureau, IC 2324G-1 for 3M Semi Anechoic Chamber A, 2324G-2 for 3M Semi Anechoic Chamber B.

5.4 TABLE OF ACCREDITATIONS AND LISTINGS

Country	Agency	Scope of Accreditation	Logo
USA	FCC	3M Semi Anechoic Chamber (FCC MRA: TW1039) to perform FCC Part 15 measurements	 FCC MRA: TW1039
Taiwan	TAF	LP0002, RTTE01, FCC Method-47 CFR Part 15 Subpart C, D, E, RSS-247, RSS-310 IDA TS SRD, AS/NZS 4268, AS/NZS 4771, TS 12.1 & 12.2, ETSI EN 300 440-1, ETSI EN 300 440-2, ETSI EN 300 328, ETSI EN 300 220-1, ETSI EN 300 220-2, ETSI EN 301 893, ETSI EN 301 489-1/3/7/17 FCC OET Bulletin 65 + Supplement C, EN 50360, EN 50361, EN 50371, RSS 102, EN 50383, EN 50385, EN 50392, IEC 62209, CNS 14958-1, CNS 14959 FCC Method -47 CFR Part 15 Subpart B IEC / EN 61000-3-2, IEC / EN 61000-3-3, IEC / EN 61000-4-2/3/4/5/6/8/11	 Testing Laboratory 1309
Canada	Industry Canada	3M Semi Anechoic Chamber (IC 2324G-1 / IC 2324G-2) to perform	 IC 2324G-1 IC 2324G-2

* No part of this report may be used to claim or imply product endorsement by A2LA or any agency of the US Government.

6. SETUP OF EQUIPMENT UNDER TEST

6.1 SETUP CONFIGURATION OF EUT

See test photographs attached in Appendix I for the actual connections between EUT and support equipment.

6.2 SUPPORT EQUIPMENT

No	Equipment	Brand	Model	Series No.	FCC ID	Data Cable	Power Cord
1	Notebook PC	ASUS	M5200AE	5BN0AG019631	PD9WM3B2100	N/A	AC I/P: Unshielded, 1.8m with a core DC O/P: Unshielded, 1.8m
2	Notebook PC	IBM	7663 (T61)	L3E9812	N/A	N/A	AC I/P: Unshielded, 1.8m DC O/P: Unshielded, 1.8m with a core

Remark:

1. All the equipment/cables were placed in the worst-case configuration to maximize the emission during the test.
2. Grounding was established in accordance with the manufacturer's requirements and conditions for the intended use.

7. FCC PART 15 REQUIREMENTS & RSS-247 REQUIREMENTS

7.1 99% BANDWIDTH

Test Configuration

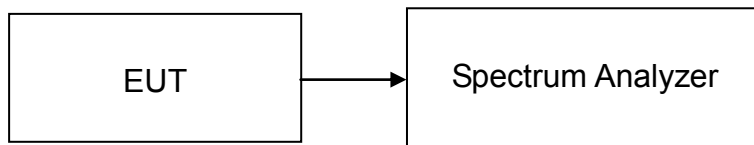

TEST PROCEDURE

The resolution bandwidth shall be set to as close to 1% of the selected span as is possible without being below 1%. The video bandwidth shall be set to 3 times the resolution bandwidth. Video averaging is not permitted. Where practical, a sampling detector shall be used since a peak or, peak hold.

LIMIT

For reporting purposes only.

TEST RESULTS

Test mode: IEEE 802.11a mode / 5180 ~ 5240MHz

Channel	Frequency (MHz)	99% Bandwidth (MHz)
Low	5180	17.0043
Mid	5220	17.0043
High	5240	17.0043

Test mode: IEEE 802.11n HT 20 MHz mode / 5180 ~ 5240MHz / Chain 0

Channel	Frequency (MHz)	99% Bandwidth (MHz)
Low	5180	17.8726
Mid	5220	17.8726
High	5240	17.8726

Test mode: IEEE 802.11n HT 20 MHz mode / 5180 ~ 5240MHz / Chain 1

Channel	Frequency (MHz)	99% Bandwidth (MHz)
Low	5180	17.8002
Mid	5220	17.8002
High	5240	17.8726

Test mode: IEEE 802.11n HT 40 MHz mode / 5190 ~ 5230MHz / Chain 0

Channel	Frequency (MHz)	99% Bandwidth (MHz)
Low	5190	36.7004
High	5230	36.8162

Test mode: IEEE 802.11n HT 40 MHz mode / 5190 ~ 5230MHz / Chain 1

Channel	Frequency (MHz)	99% Bandwidth (MHz)
Low	5190	36.7004
High	5230	36.8162

Test mode: IEEE 802.11a mode / 5260 ~ 5320MHz

Channel	Frequency (MHz)	99% Bandwidth (MHz)
Low	5260	17.0043
Mid	5280	17.0043
High	5320	17.0043

Test mode: IEEE 802.11n HT 20 MHz mode / 5260 ~ 5320MHz/ Chain 0

Channel	Frequency (MHz)	99% Bandwidth (MHz)
Low	5260	17.8726
Mid	5280	17.8726
High	5320	17.8726

Test mode: IEEE 802.11n HT 20 MHz mode / 5260 ~ 5320MHz/ Chain 1

Channel	Frequency (MHz)	99% Bandwidth (MHz)
Low	5260	17.8002
Mid	5280	17.8726
High	5320	17.8002

Test mode: IEEE 802.11n HT 40 MHz mode / 5270 ~ 5310MHz/ Chain 0

Channel	Frequency (MHz)	99% Bandwidth (MHz)
Low	5270	36.7004
High	5310	36.8162

Test mode: IEEE 802.11n HT 40 MHz mode / 5270 ~ 5310MHz/ Chain 1

Channel	Frequency (MHz)	99% Bandwidth (MHz)
Low	5270	36.5846
High	5310	36.7004

Test mode: IEEE 802.11a mode / 5500 ~ 5700MHz

Channel	Frequency (MHz)	99% Bandwidth (MHz)
Low	5500	17.0043
Mid	5580	17.0043
High	5700	17.0043

Test mode: IEEE 802.11n HT 20 MHz mode / 5500 ~ 5700MHz / Chain 0

Channel	Frequency (MHz)	99% Bandwidth (MHz)
Low	5500	17.9450
Mid	5580	17.8726
High	5700	18.0897

Test mode: IEEE 802.11n HT 20 MHz mode / 5500 ~ 5700MHz / Chain 1

Channel	Frequency (MHz)	99% Bandwidth (MHz)
Low	5500	17.8002
Mid	5580	17.7279
High	5700	17.8726

Test mode: IEEE 802.11n HT 40 MHz mode / 5510 ~ 5670MHz / Chain 0

Channel	Frequency (MHz)	99% Bandwidth (MHz)
Low	5510	36.8162
Mid	5550	36.7004
High	5670	36.9319

Test mode: IEEE 802.11n HT 40 MHz mode / 5510 ~ 5670MHz / Chain 1

Channel	Frequency (MHz)	99% Bandwidth (MHz)
Low	5510	36.7004
Mid	5550	36.5846
High	5670	36.7004

Test Plot

IEEE 802.11a mode / 5180 ~ 5240MHz

99% Bandwidth (CH Low)

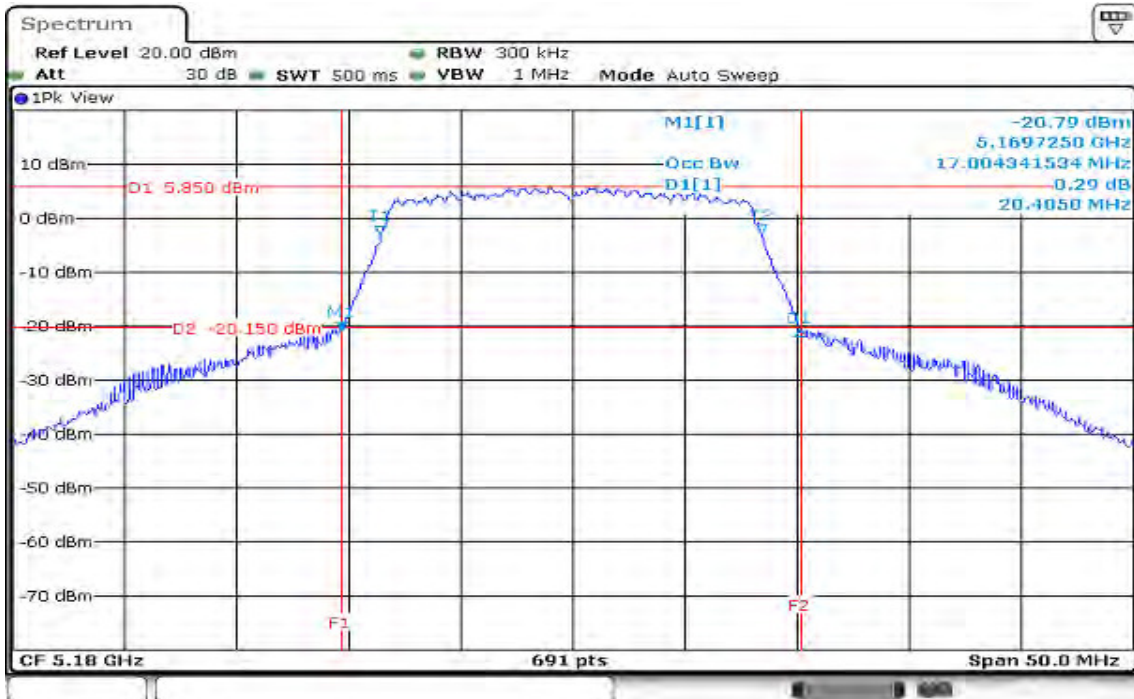

Date: 8 SEP 2016 16:52:27

99% Bandwidth (CH Mid)

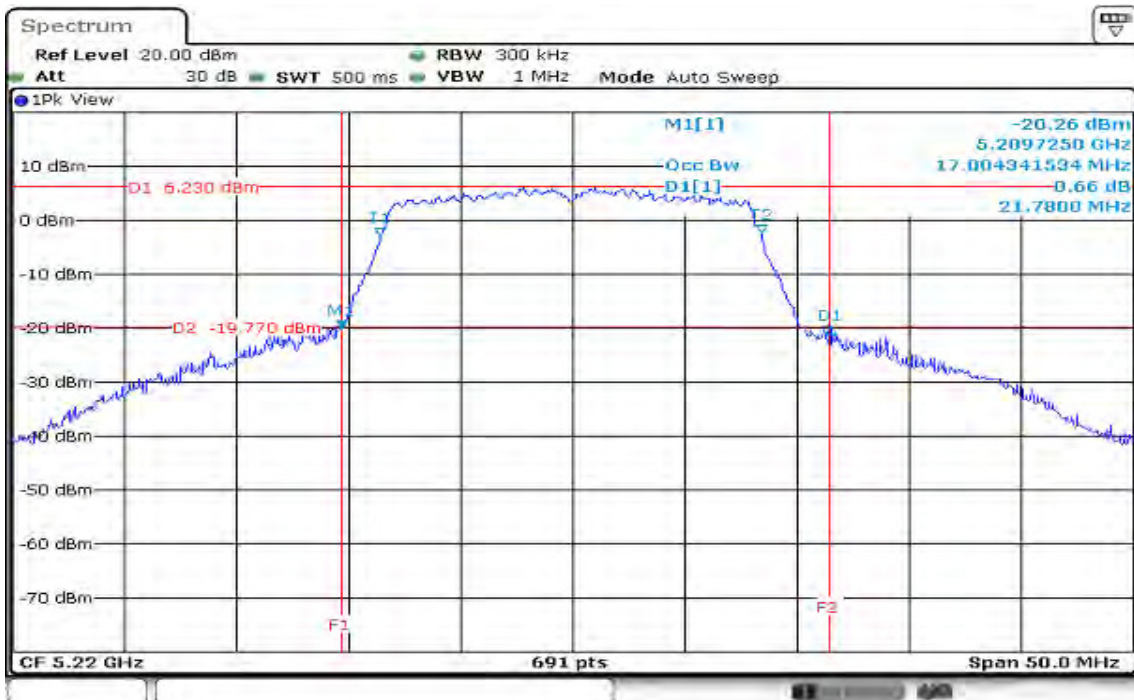

Date: 8 SEP 2016 16:05:08

99% Bandwidth (CH high)

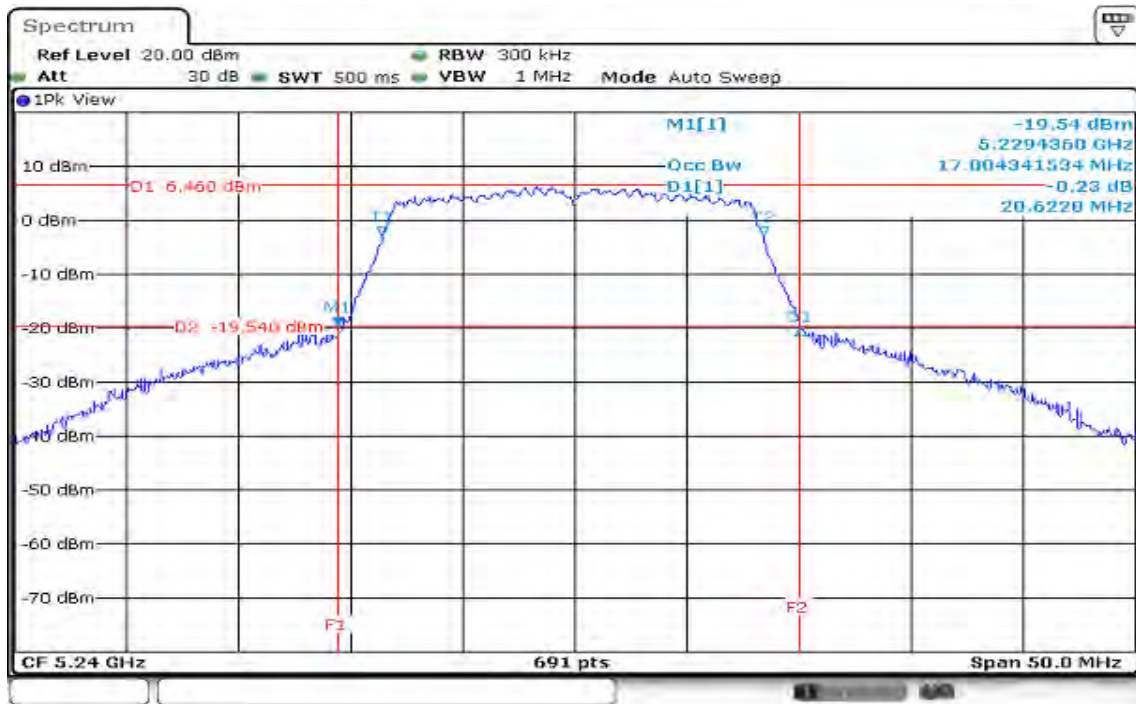

Date: 8 SEP 2016 16:13:31

IEEE 802.11n HT 20 MHz mode / 5180 ~ 5240MHz/ Chain 0

CH Low

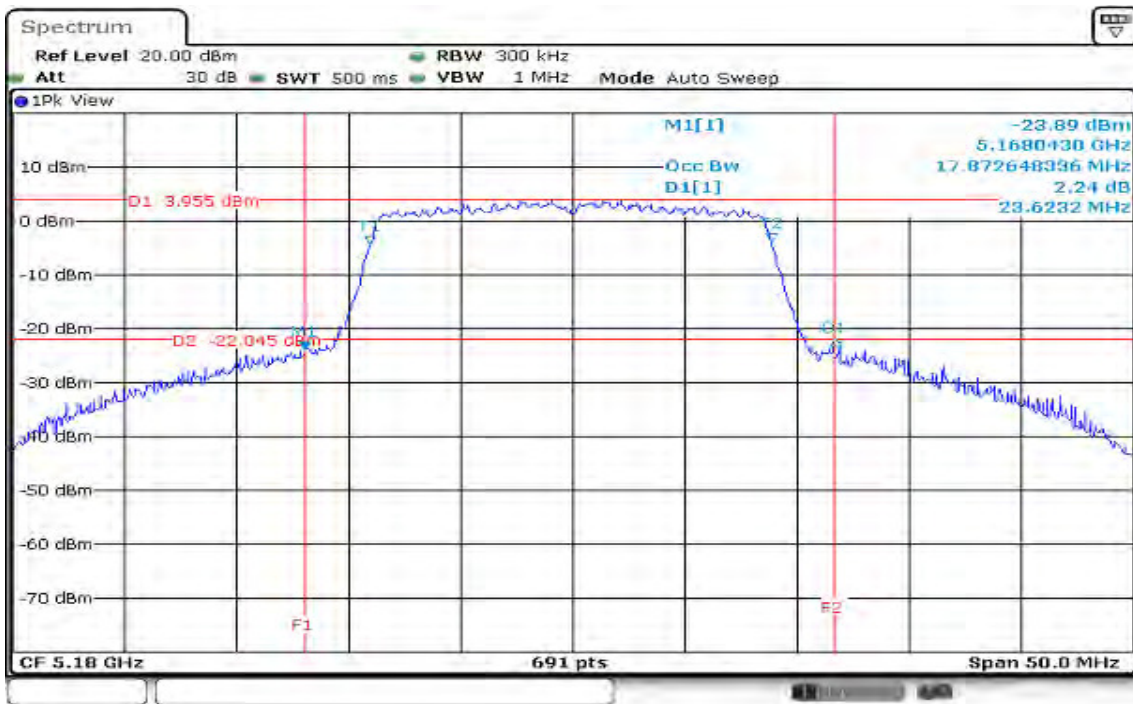

Date: 8 SEP 2016 16:27:04

CH Mid

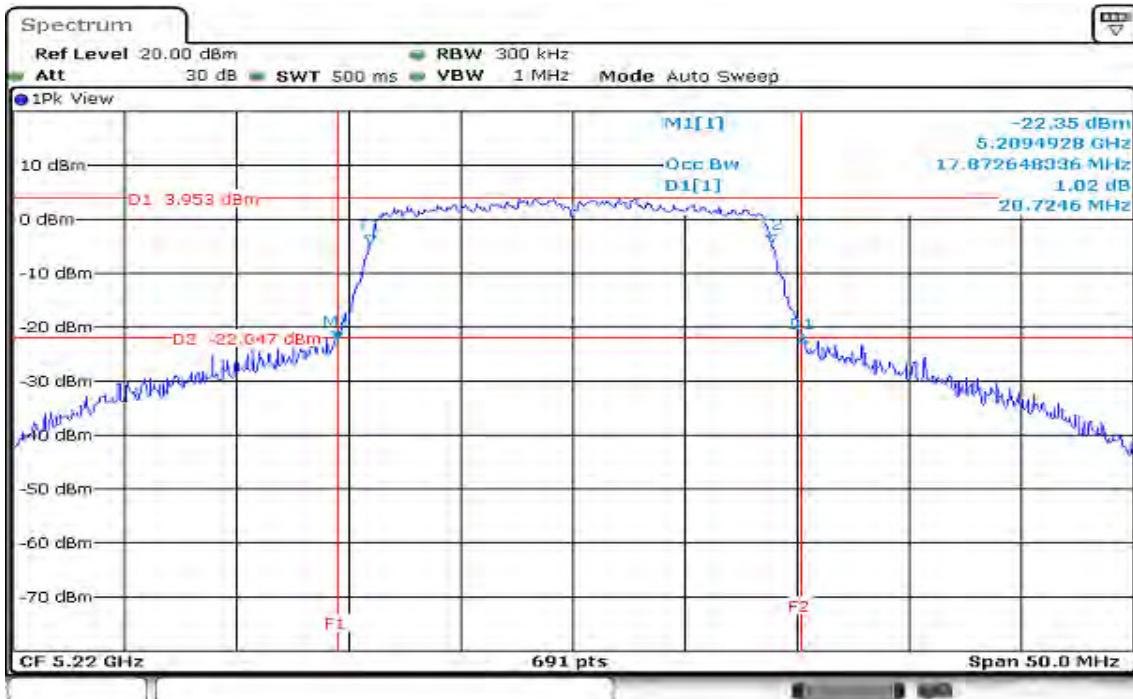

Date: 8 SEP 2016 16:31:33

CH High

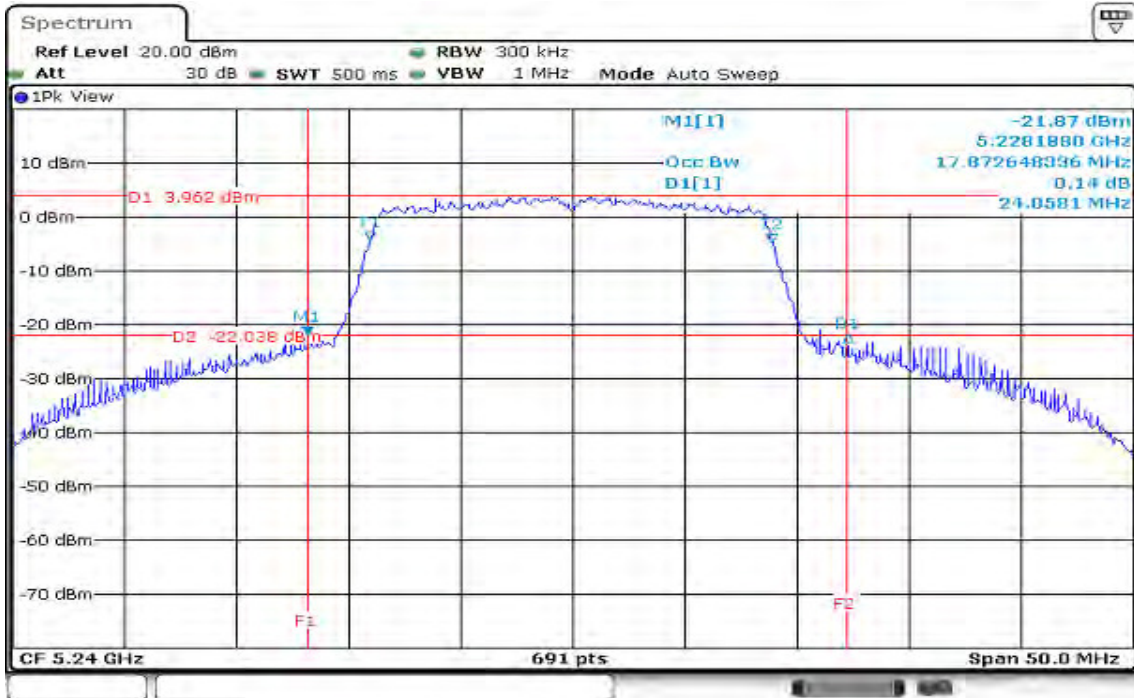

Date: 8 SEP 2016 16:42:33

IEEE 802.11n HT 20 MHz mode / 5180 ~ 5240MHz/ Chain 1

CH Low

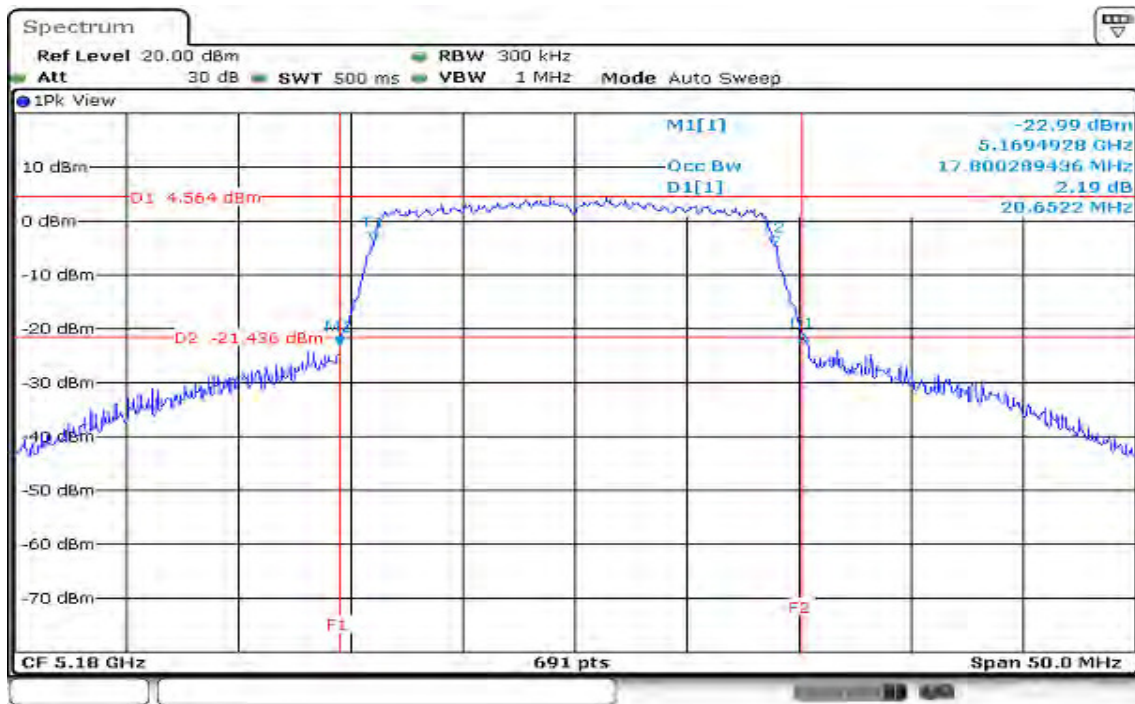

Date: 8 SEP 2016 16:22:23

CH Mid

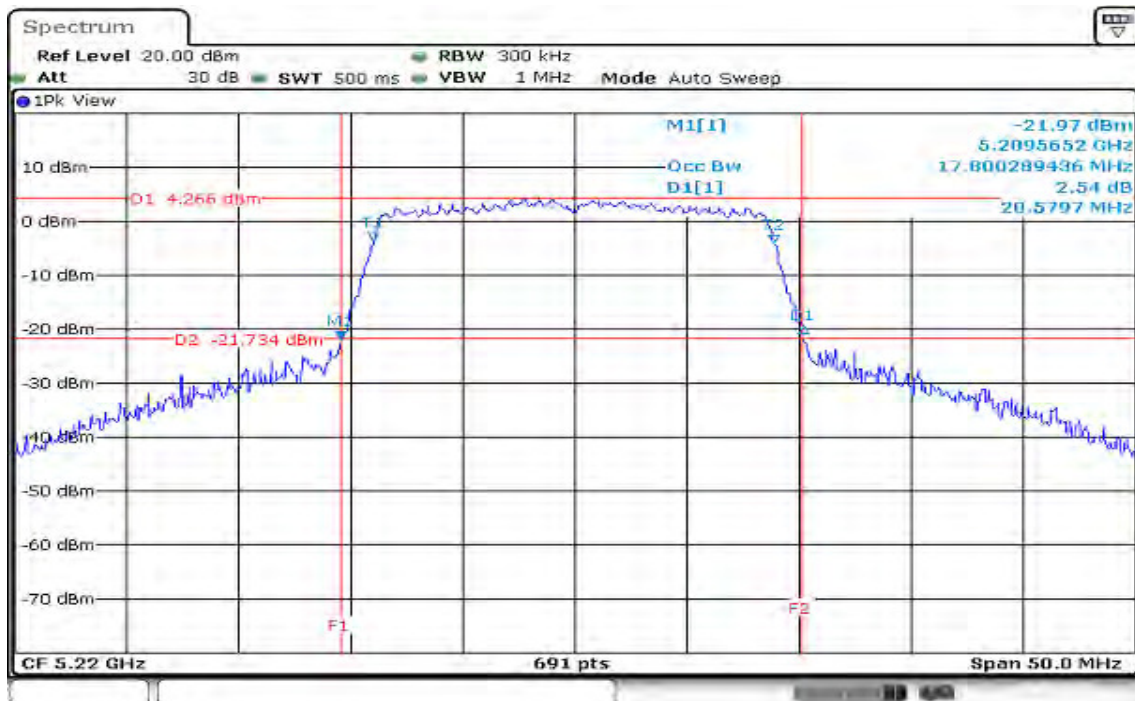

Date: 8 SEP 2016 16:24:54

CH High

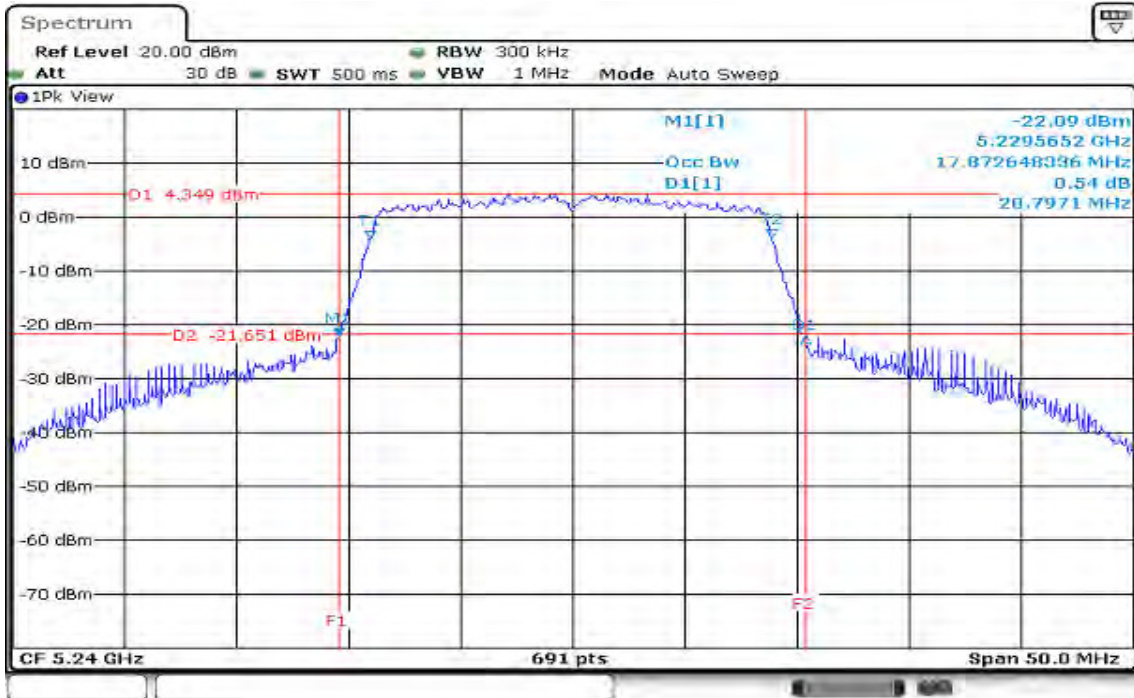

IEEE 802.11n HT 40 MHz mode / 5190 ~ 5230MHz/ Chain 0

CH Low

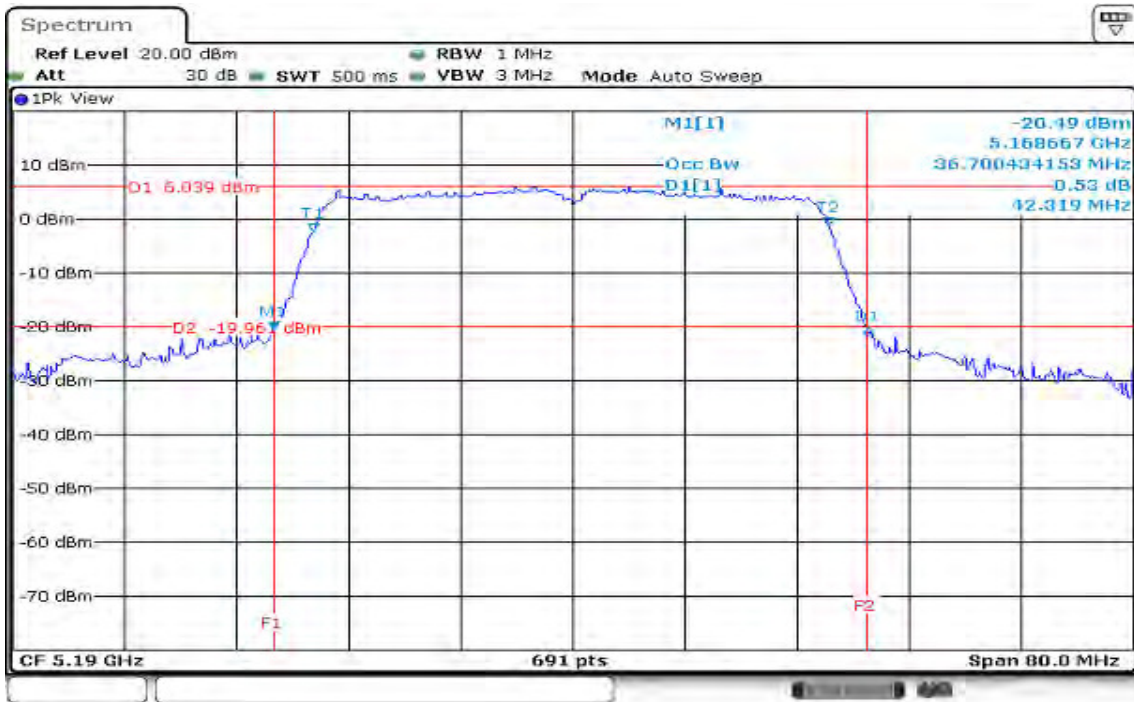

Date: 8 SEP 2016 16:46:35

CH High



Date: 8 SEP 2016 16:57:14

IEEE 802.11n HT 40 MHz mode / 5190 ~ 5230MHz/ Chain 1

CH Low

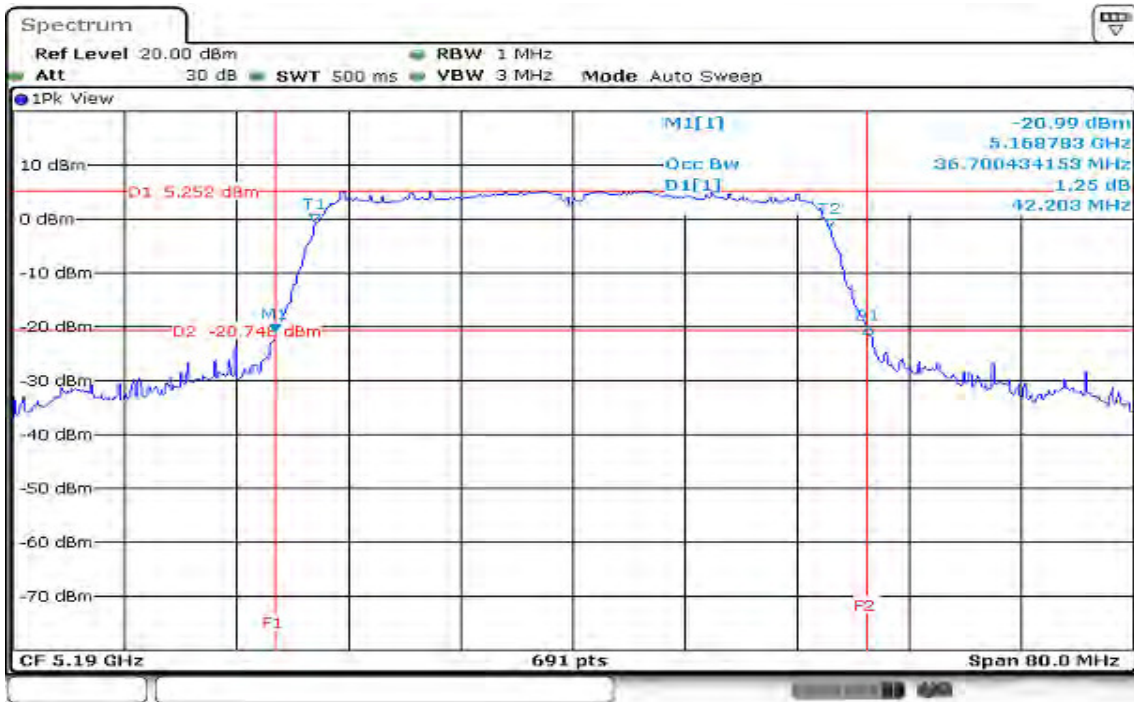

CH High

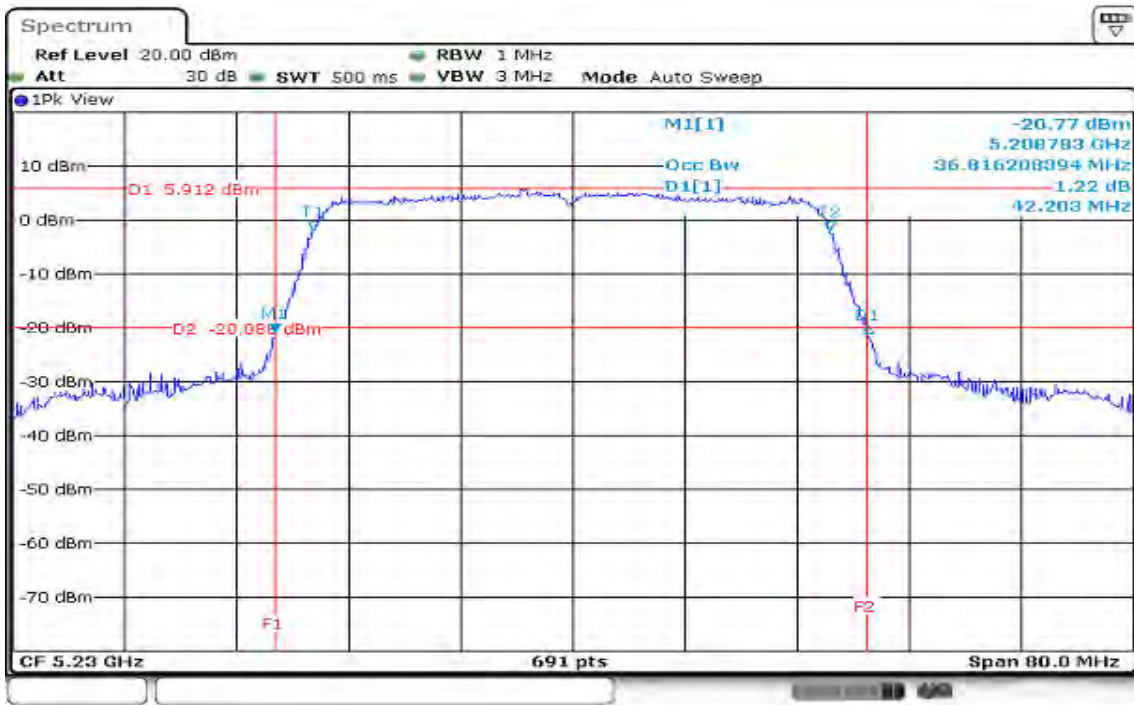

IEEE 802.11a mode / 5260 ~ 5320MHz

99% Bandwidth (CH Low)

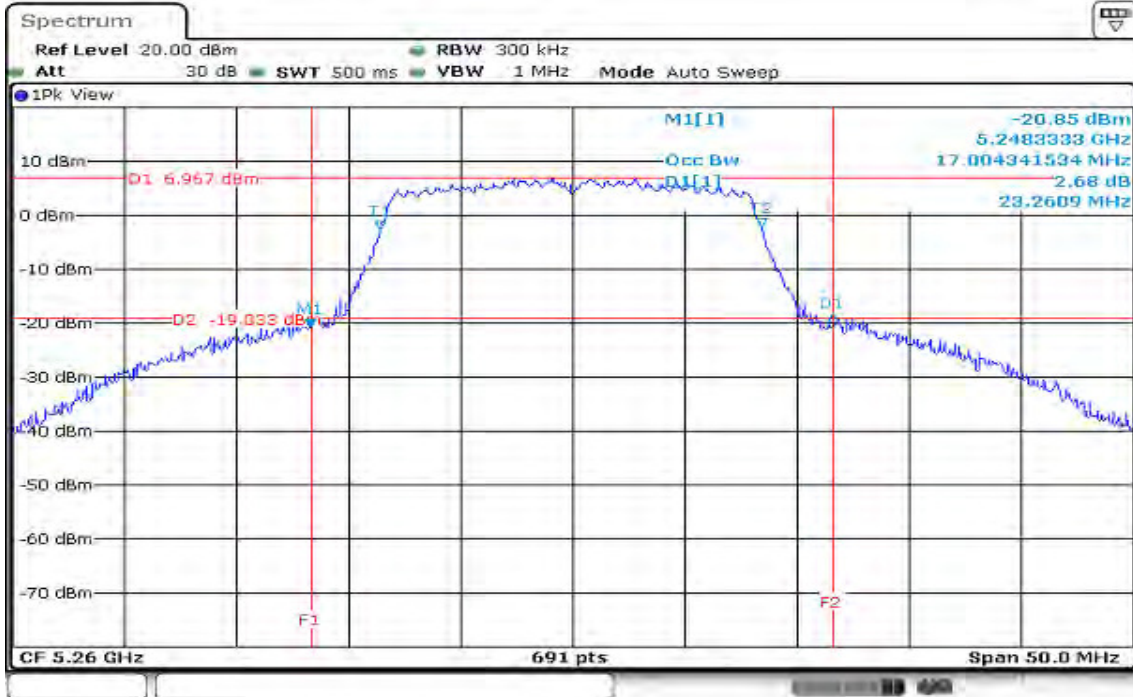

Date: 12 SEP 2016 09:23:19

99% Bandwidth (CH Mid)

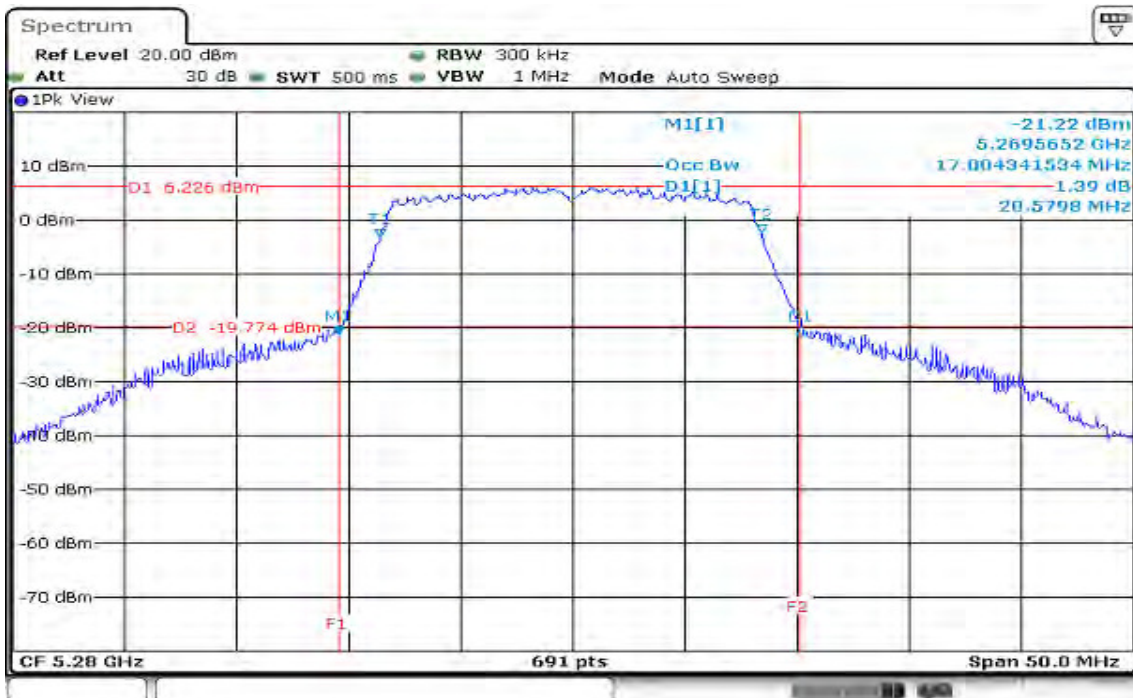

Date: 12 SEP 2016 09:48:27

99% Bandwidth (CH High)

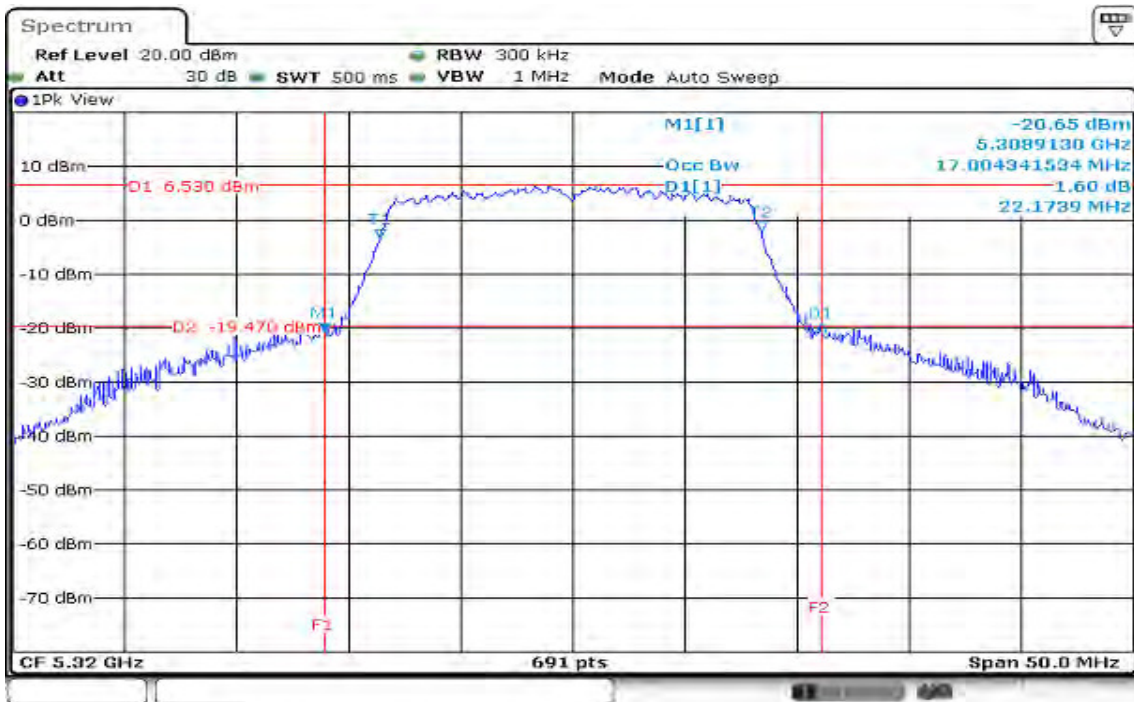

Date: 12/3/2016 09:54:28

IEEE 802.11n HT 20 MHz mode / 5260 ~ 5320MHz/ Chain 0

CH Low

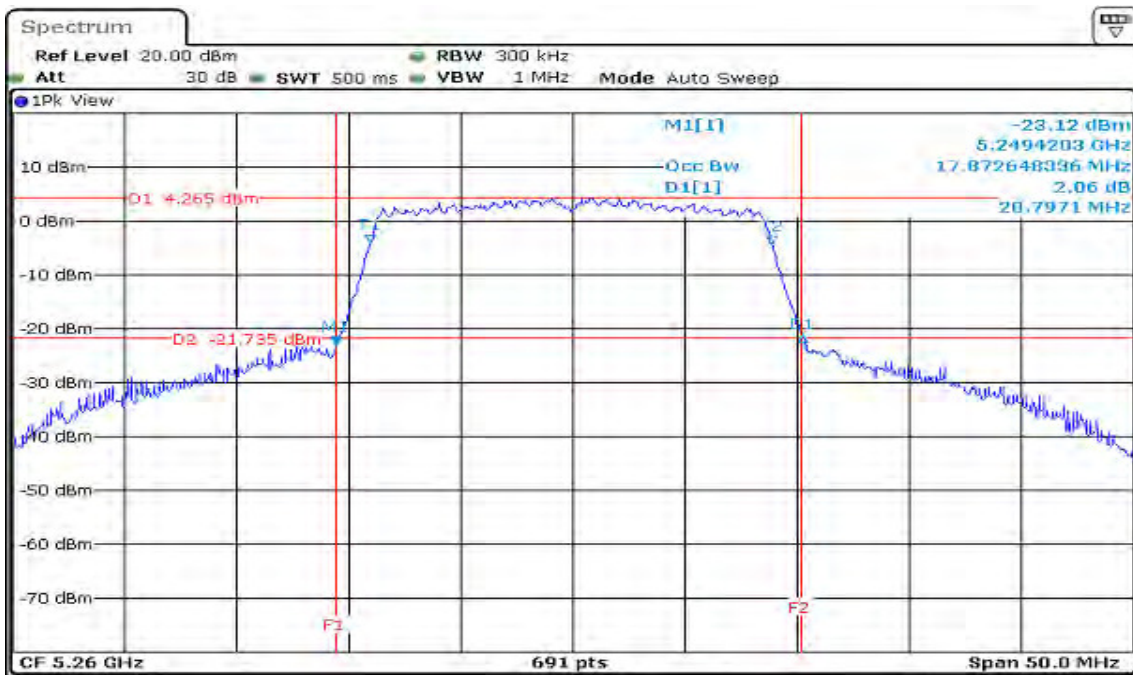

Date: 12 SEP 2016 10:03:12

CH Mid

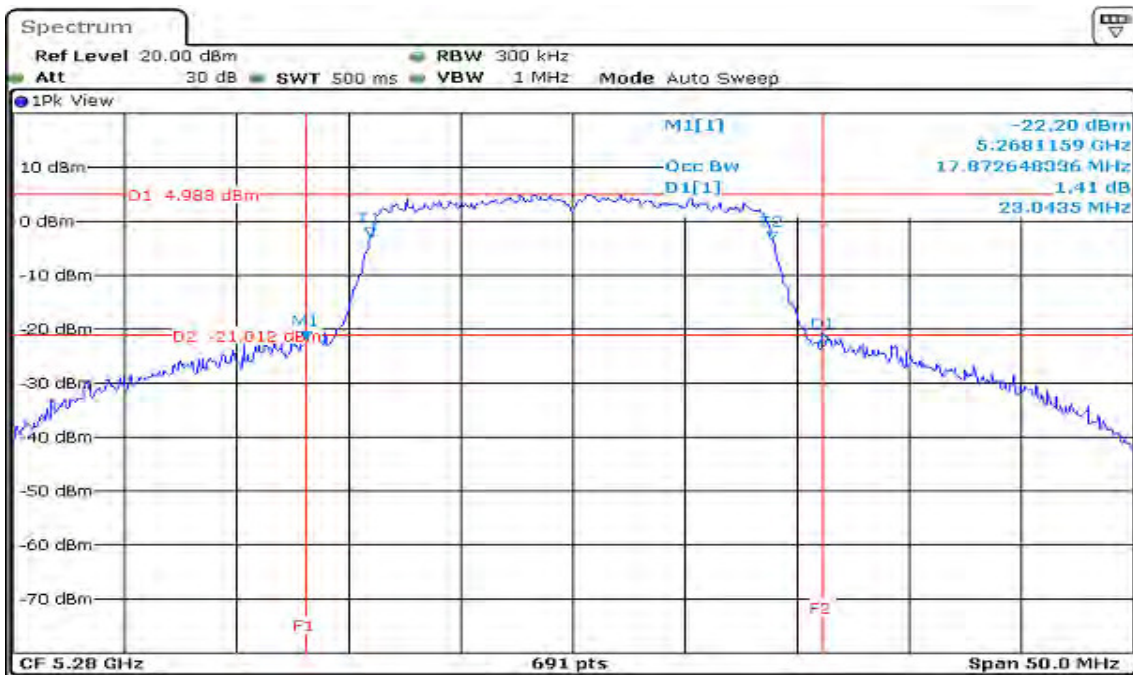

Date: 12 SEP 2016 10:05:45

CH High

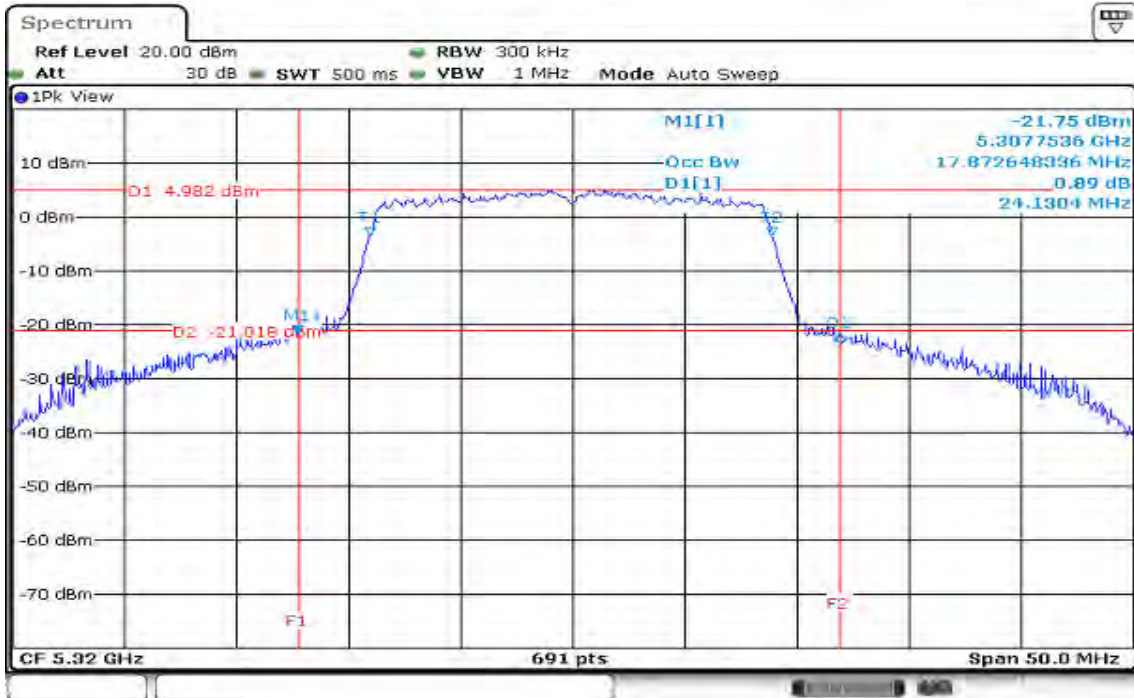

Date: 12 SEP 2016 10:17:05

IEEE 802.11n HT 20 MHz mode / 5260 ~ 5320MHz/ Chain 1

CH Low

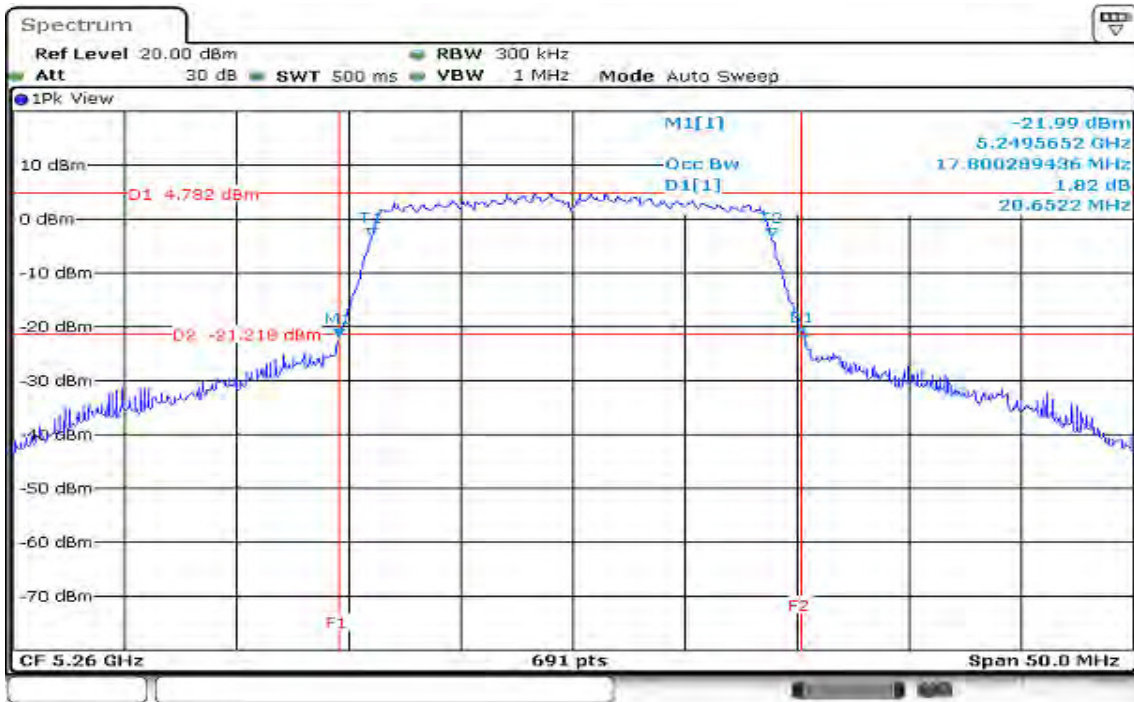

Date: 12 SEP 2016 09:58:01

CH Mid

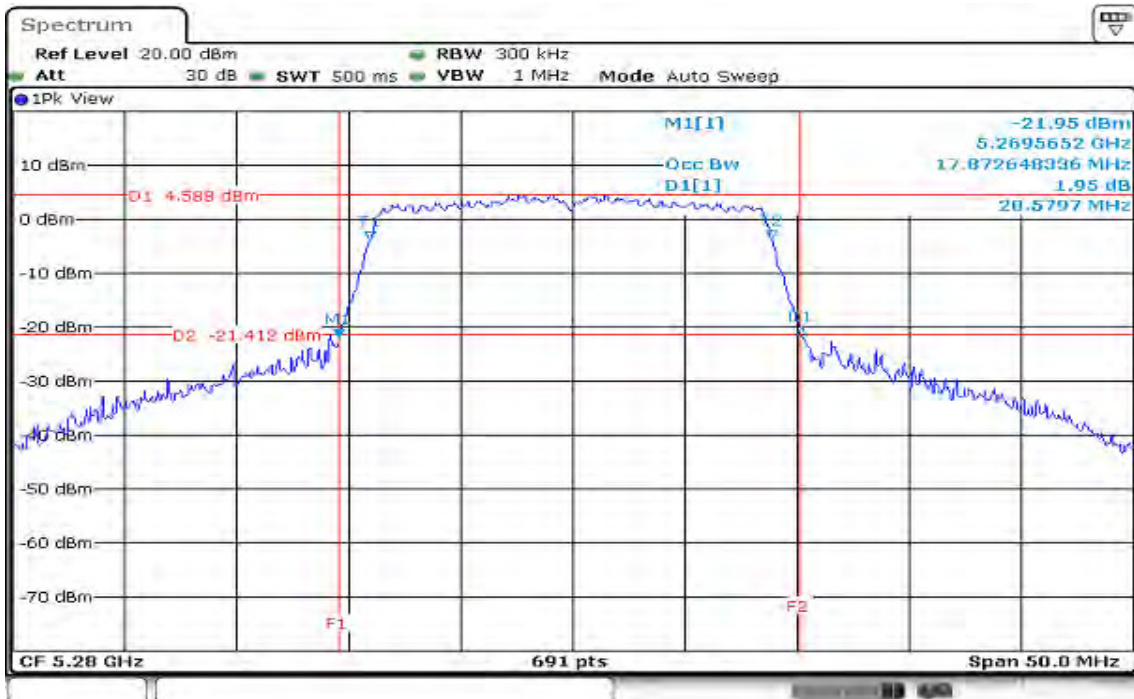

Date: 12 SEP 2016 10:08:41

CH High

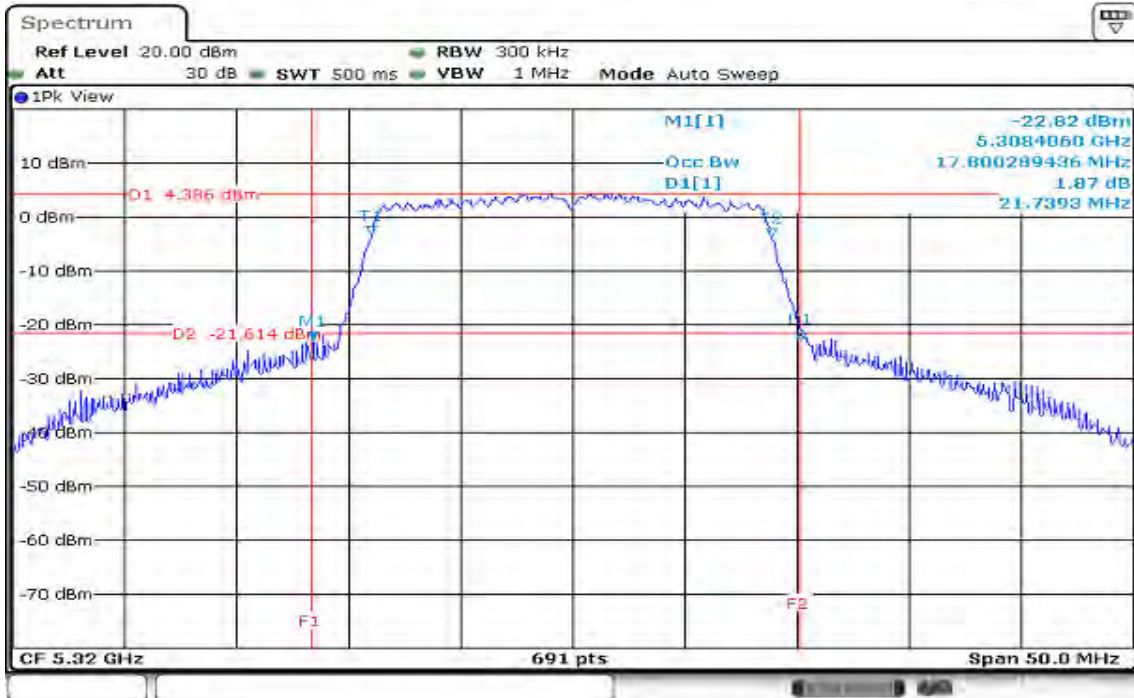

IEEE 802.11n HT 40 MHz mode / 5270 ~ 5310MHz/ Chain 0

CH Low



CH High



IEEE 802.11n HT 40 MHz mode / 5270 ~ 5310MHz/ Chain 1

CH Low



CH High

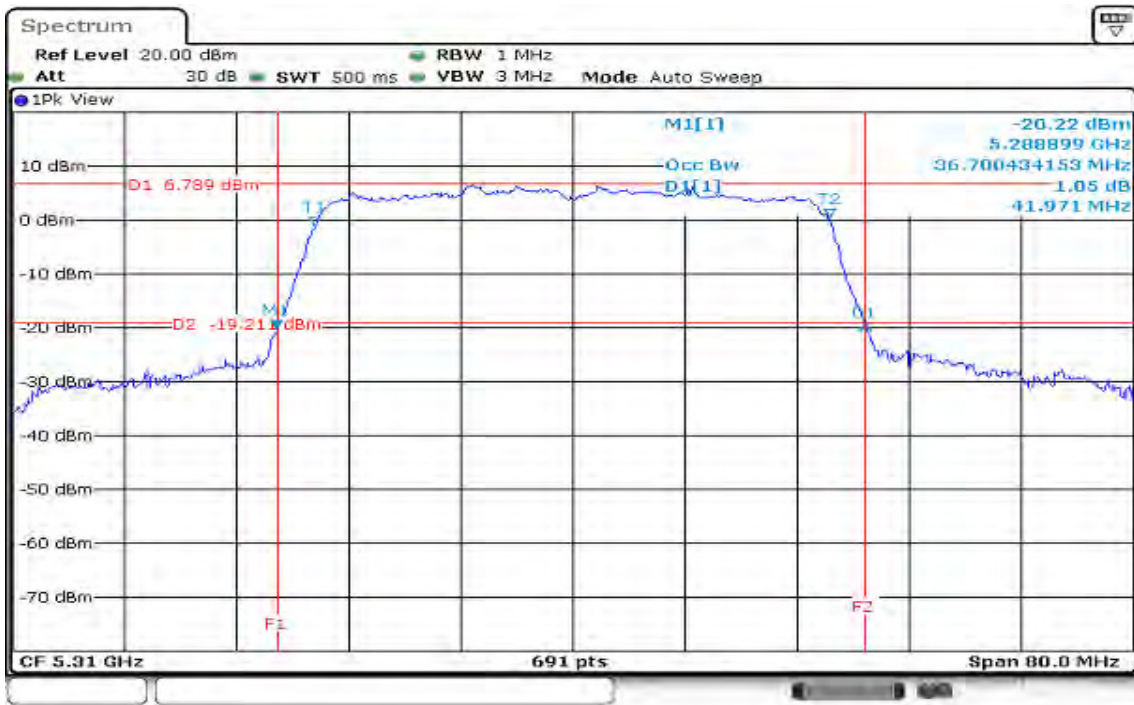

Test mode: IEEE 802.11a mode / 5500 ~ 5700MHz

99% Bandwidth (CH Low)

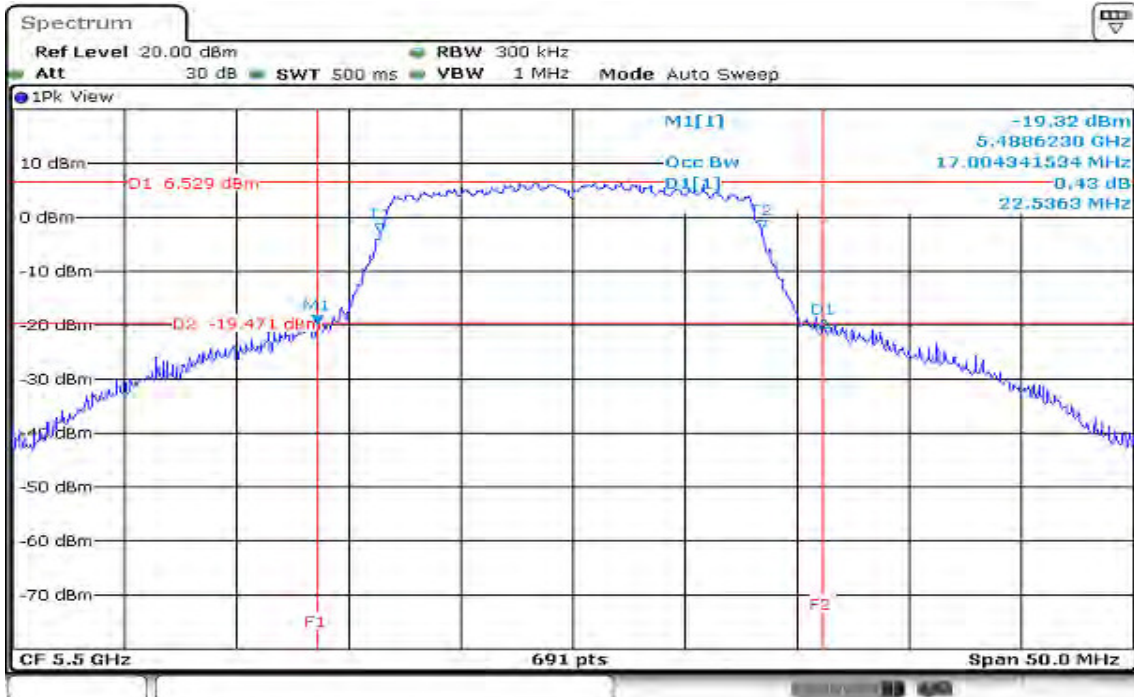

Date: 12 SEP 2016 10:51:22

99% Bandwidth (CH Mid)



Date: 12 SEP 2016 10:54:09

99% Bandwidth (CH High)

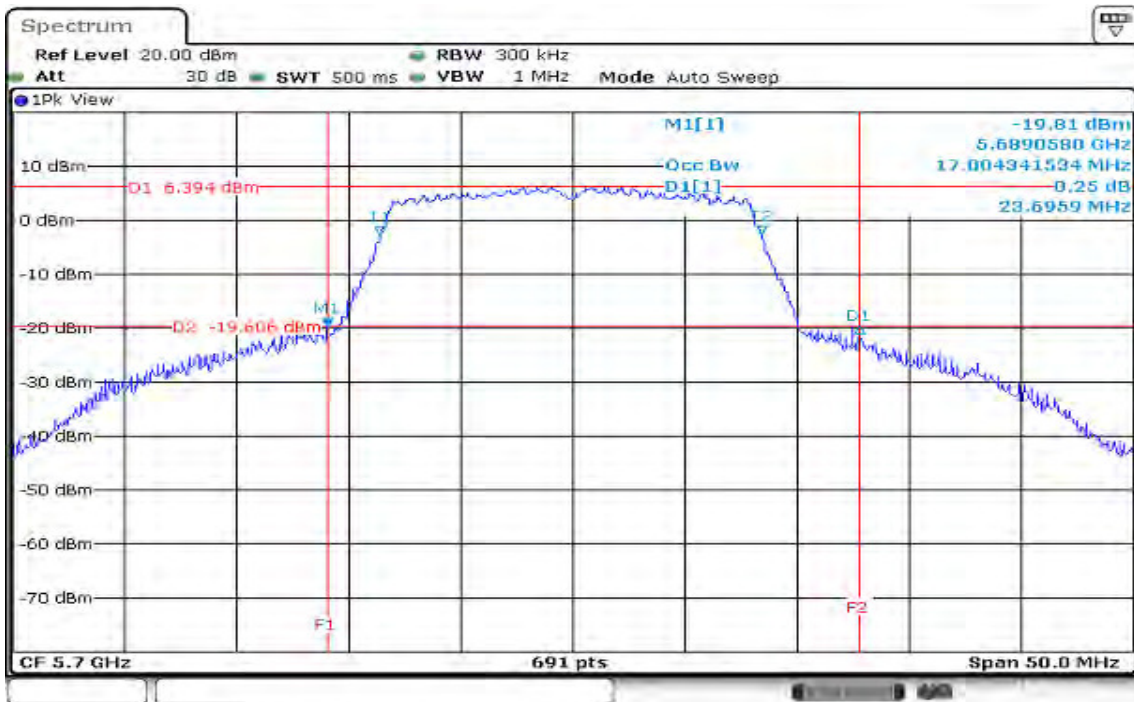

Date: 12/30/2016 11:08:53

IEEE 802.11n HT 20 MHz mode / 5500 ~ 5700MHz / Chain 0

CH Low

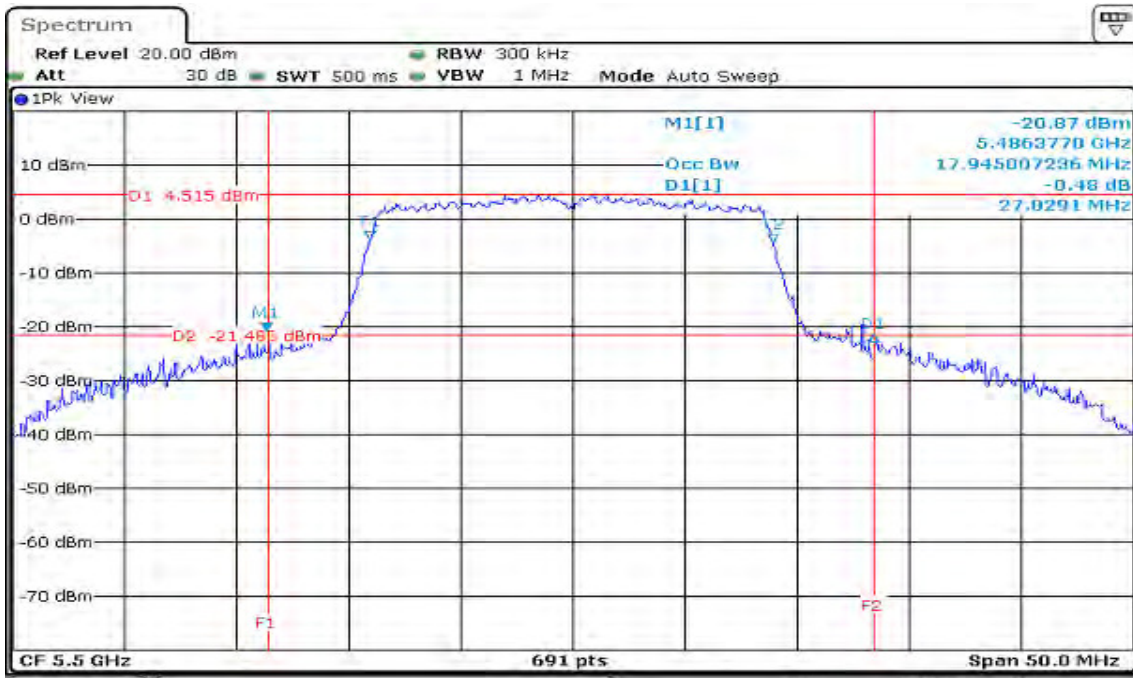

Date: 12 SEP 2016 11:24:43

CH Mid

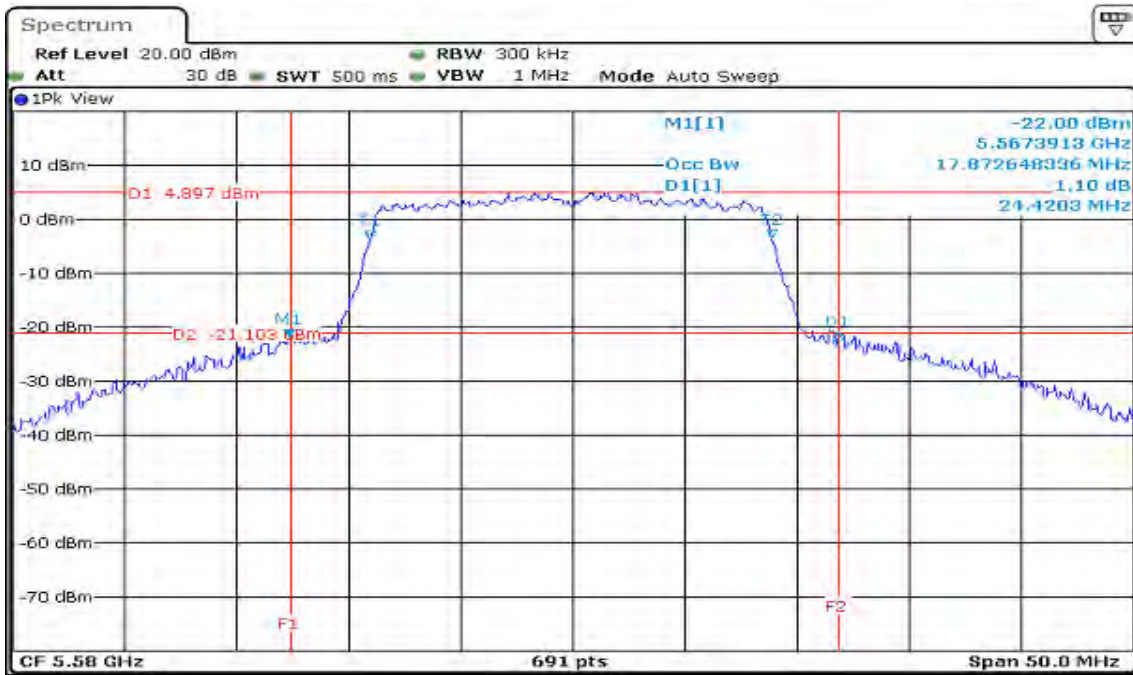

Date: 12 SEP 2016 11:31:23

CH High

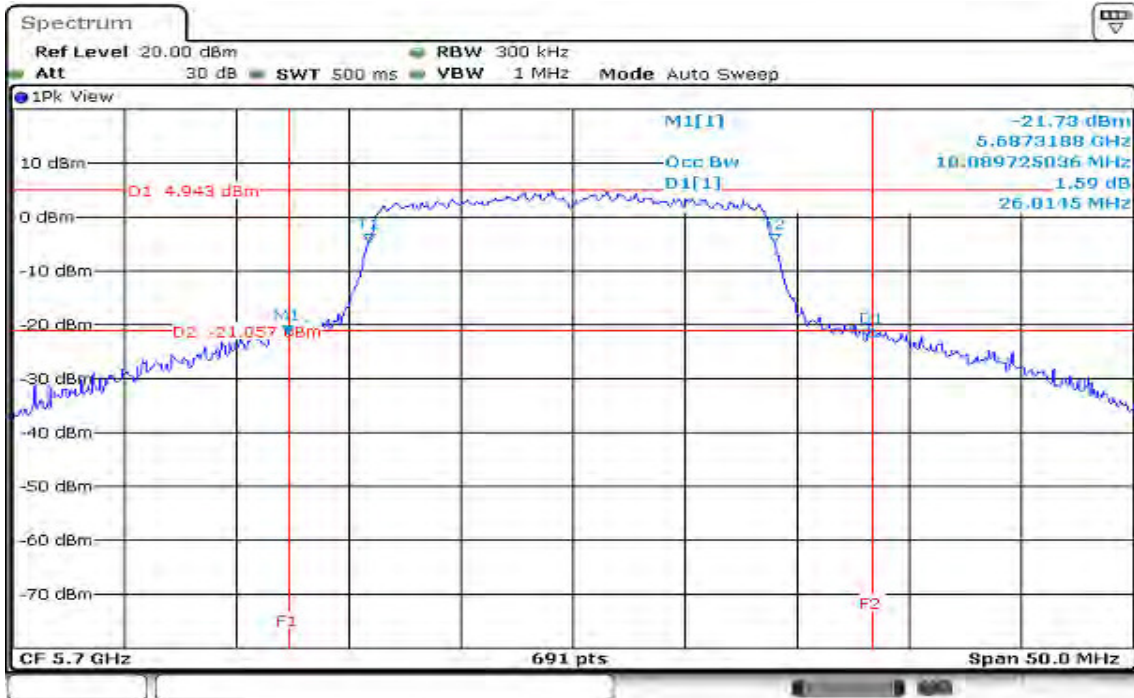

IEEE 802.11n HT 20 MHz mode / 5500 ~ 5700MHz / Chain 1

CH Low

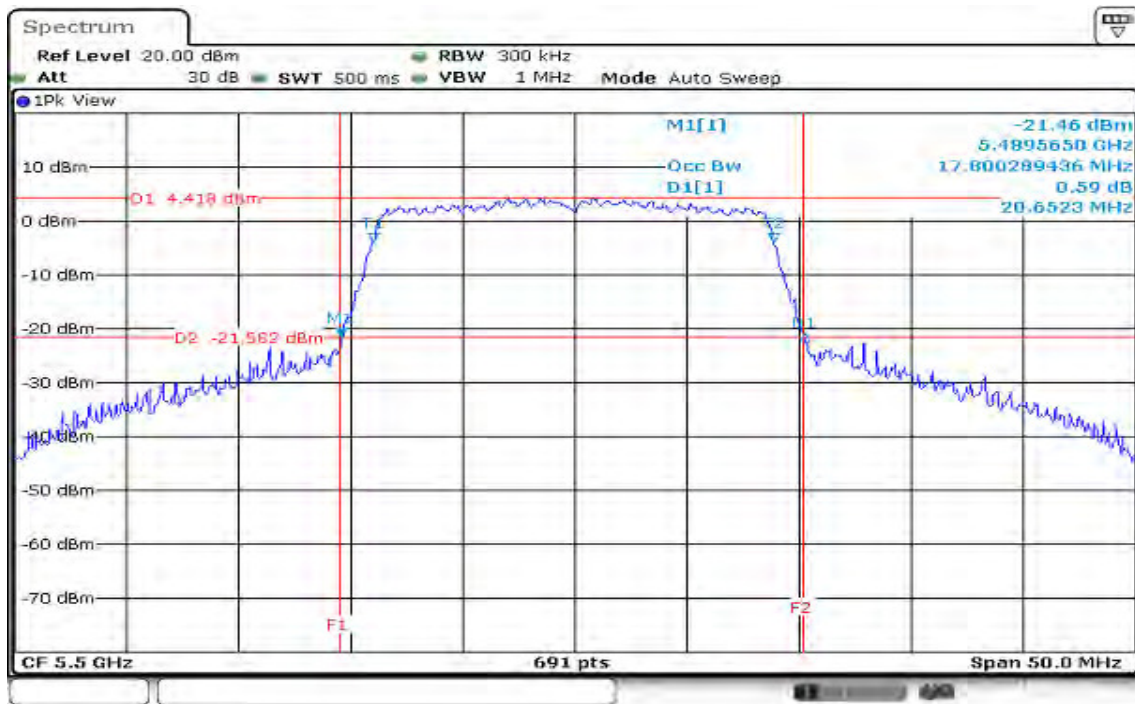

CH Mid

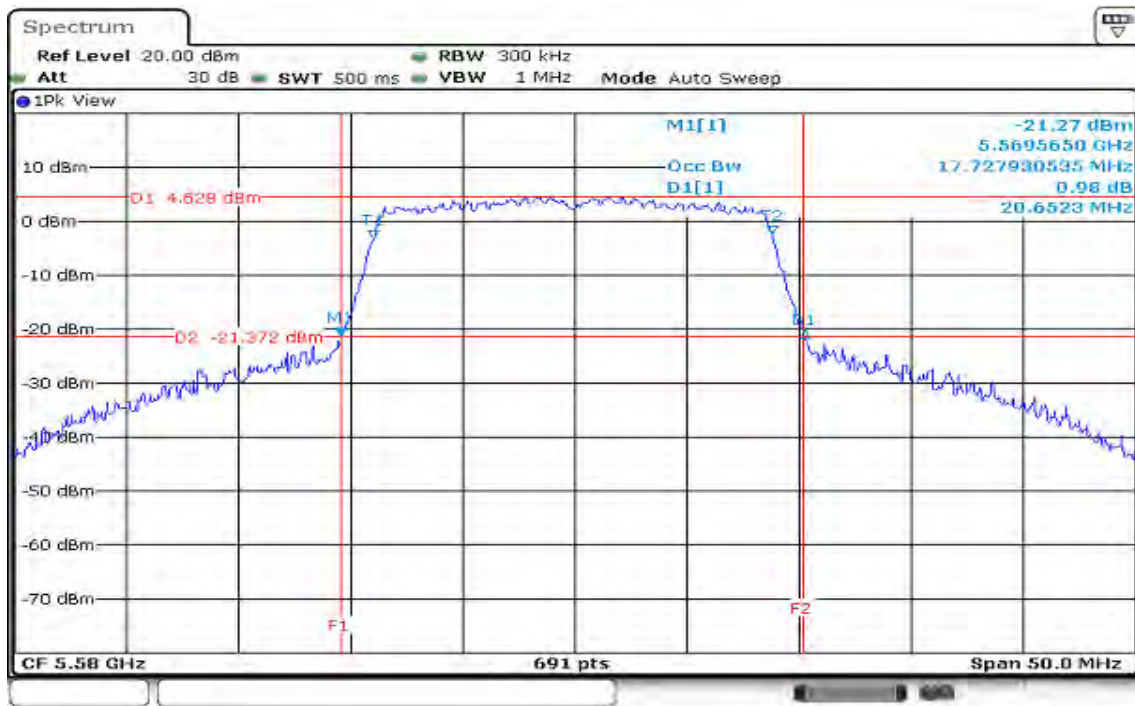

CH High

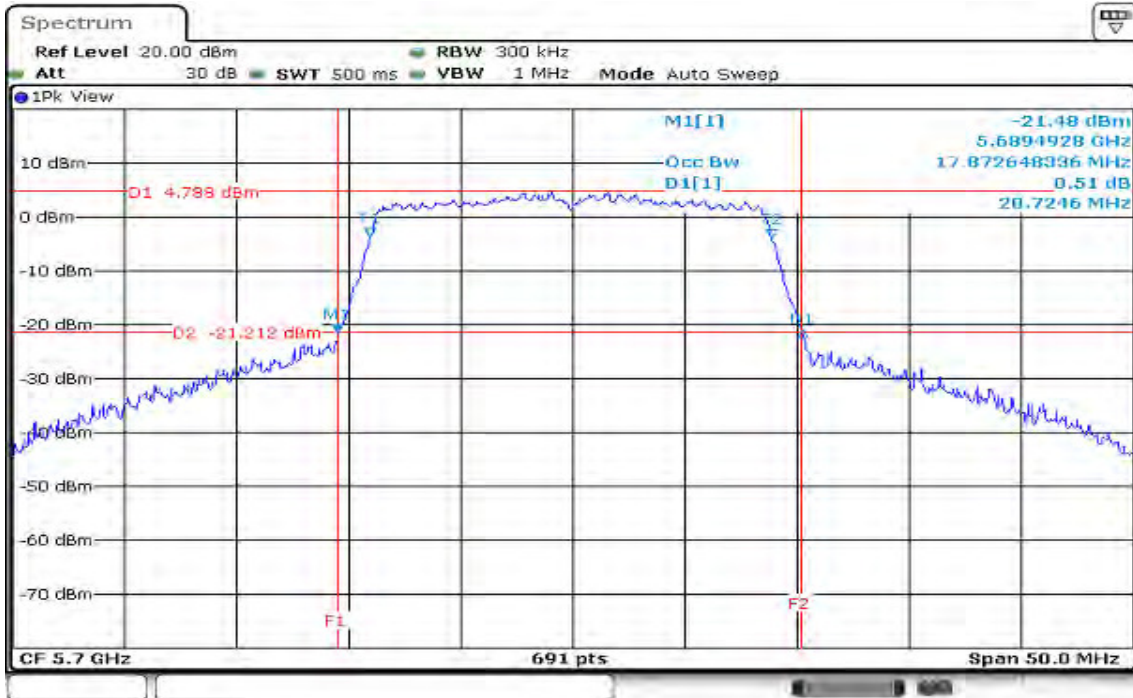

Date: 12 SEP 2016 11:29:24

IEEE 802.11n HT 40 MHz mode / 5510 ~ 5670MHz / Chain 0

CH Low

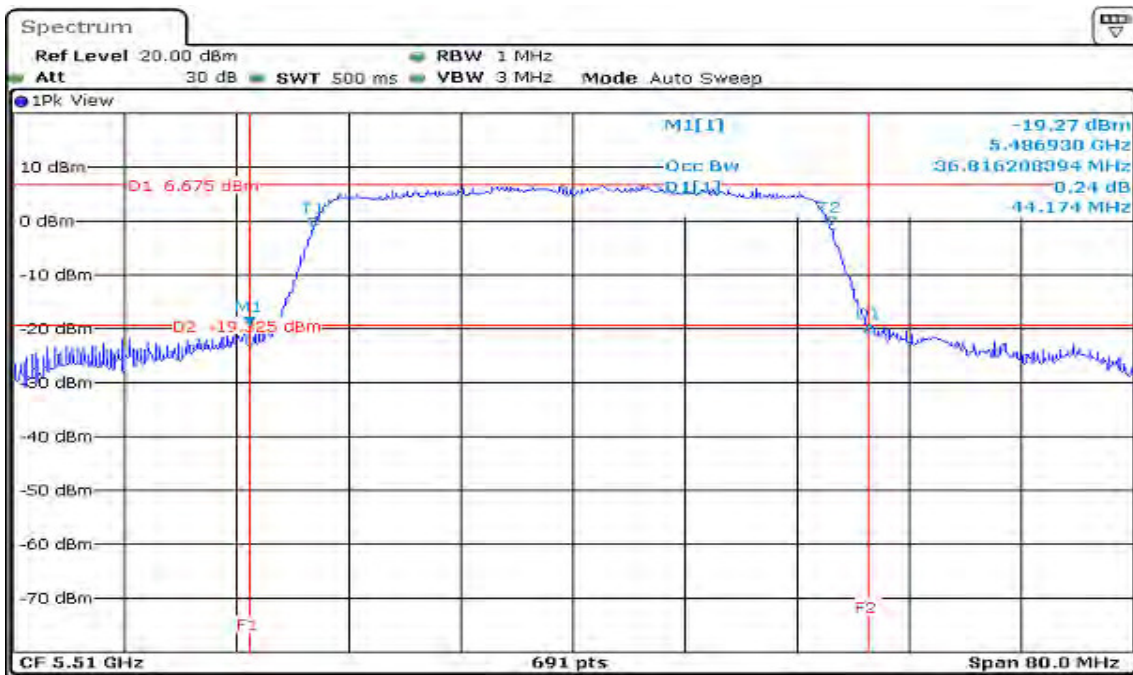

Date: 12/30/2016 11:48:19

CH Mid



Date: 12/30/2016 12:01:25

CH High

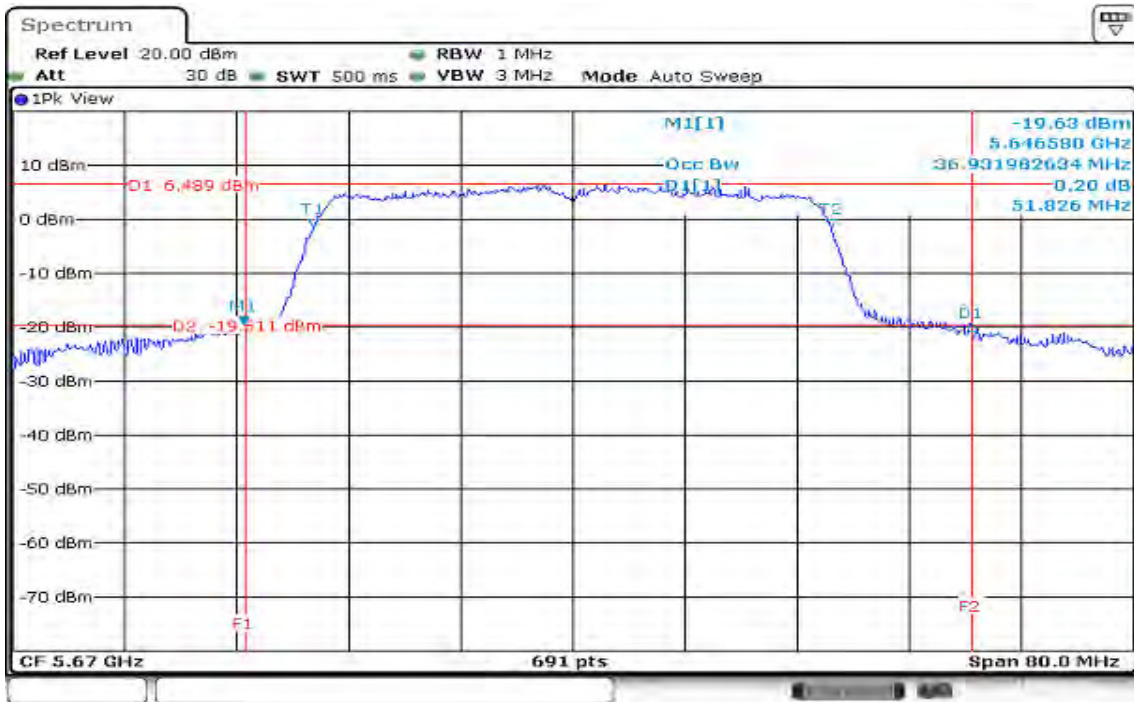

Date: 12 SEP 2016 13:09:52

IEEE 802.11n HT 40 MHz mode / 5510 ~ 5670MHz / Chain 1

CH Low

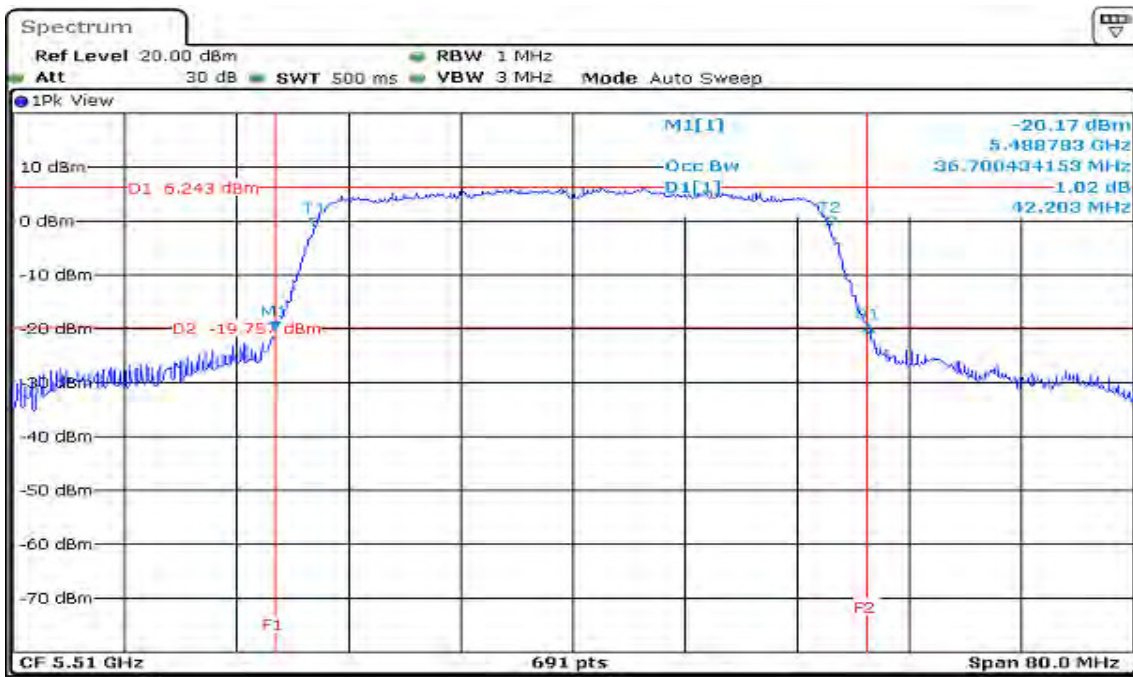

Date: 12 SEP 2016 11:52:25

CH Mid



Date: 12 SEP 2016 11:57:07

CH High



Date: 12 SEP 2016 13:07:34

7.2 26 dB EMISSION BANDWIDTH

LIMIT

Measure the maximum width of the emission that is 26 dB down from the maximum of the emission. Compare this with the RBW setting of the analyzer. Readjust RBW and repeat measurement as needed until the RBW/EBW ratio is approximately 1%.

Test Configuration

TEST PROCEDURE

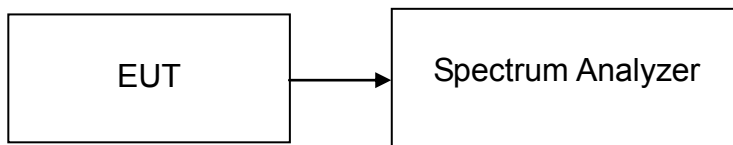

Test method Refer as KDB 789033 D02 v01r03 Section C, D, and ANSI 63.10:2013 clause 6.9.2,

1. The EUT RF output connected to the spectrum analyzer by RF cable.
2. Setting maximum power transmit of EUT
3. SA set RBW = 300kHz, VBW = 1MHz and Detector = Peak, to measurement 6 dB Bandwidth
4. Measure and record the result of 6 dB Bandwidth in the test report.

TEST RESULTS

No non-compliance noted

Test Data**Test mode: IEEE 802.11a mode / 5180 ~ 5240MHz**

Channel	Frequency (MHz)	26db Bandwidth (MHz)
Low	5180	20.4050
Mid	5220	21.7800
High	5240	20.6220

Test mode: IEEE 802.11n HT 20 MHz mode / 5180 ~ 5240MHz / Chain 0

Channel	Frequency (MHz)	26db Bandwidth (MHz)
Low	5180	23.6232
Mid	5220	20.7246
High	5240	24.0581

Test mode: IEEE 802.11n HT 20 MHz mode / 5180 ~ 5240MHz / Chain 1

Channel	Frequency (MHz)	26db Bandwidth (MHz)
Low	5180	20.6522
Mid	5220	20.5797
High	5240	20.7971

Test mode: IEEE 802.11n HT 40 MHz mode / 5190 ~ 5230MHz / Chain 0

Channel	Frequency (MHz)	26db Bandwidth (MHz)
Low	5190	42.3190
Mid	5230	42.2030

Test mode: IEEE 802.11n HT 40 MHz mode / 5190 ~ 5230MHz / Chain 1

Channel	Frequency (MHz)	26db Bandwidth (MHz)
Low	5190	42.2030
Mid	5230	42.2030

Test mode: IEEE 802.11a mode / 5260 ~ 5320MHz

Channel	Frequency (MHz)	26db Bandwidth (MHz)
Low	5260	23.2609
Mid	5280	20.5798
High	5320	22.1739

Test mode: IEEE 802.11n HT 20 MHz mode / 5260 ~ 5320MHz/ Chain 0

Channel	Frequency (MHz)	26db Bandwidth (MHz)
Low	5260	20.7971
Mid	5280	23.0435
High	5320	24.1304

Test mode: IEEE 802.11n HT 20 MHz mode / 5260 ~ 5320MHz/ Chain 1

Channel	Frequency (MHz)	26db Bandwidth (MHz)
Low	5260	20.6522
Mid	5280	20.5797
High	5320	21.7393

Test mode: IEEE 802.11n HT 40 MHz mode / 5270 ~ 5310MHz/ Chain 0

Channel	Frequency (MHz)	26db Bandwidth (MHz)
Low	5270	42.0870
Mid	5310	42.8990

Test mode: IEEE 802.11n HT 40 MHz mode / 5270 ~ 5310MHz/ Chain 1

Channel	Frequency (MHz)	26db Bandwidth (MHz)
Low	5270	41.9710
Mid	5310	41.9710

Test mode: IEEE 802.11a mode / 5500 ~ 5700MHz

Channel	Frequency (MHz)	26db Bandwidth (MHz)
Low	5500	22.5363
Mid	5580	20.5797
High	5700	23.6959

Test mode: IEEE 802.11n HT 20 MHz mode / 5500 ~ 5700MHz / Chain 0

Channel	Frequency (MHz)	26db Bandwidth (MHz)
Low	5500	27.0291
Mid	5580	24.4203
High	5700	26.0145

Test mode: IEEE 802.11n HT 20 MHz mode / 5500 ~ 5700MHz / Chain 1

Channel	Frequency (MHz)	26db Bandwidth (MHz)
Low	5500	20.6523
Mid	5580	20.6523
High	5700	20.7246

Test mode: IEEE 802.11n HT 40 MHz mode / 5510 ~ 5670MHz / Chain 0

Channel	Frequency (MHz)	26db Bandwidth (MHz)
Low	5510	44.1740
Mid	5550	42.5510
High	5670	51.8260

Test mode: IEEE 802.11n HT 40 MHz mode / 5510 ~ 5670MHz / Chain 1

Channel	Frequency (MHz)	26db Bandwidth (MHz)
Low	5510	42.2030
Mid	5550	42.2030
High	5670	42.2030

Test Plot

IEEE 802.11a for 5180 ~ 5240MHz

CH Low

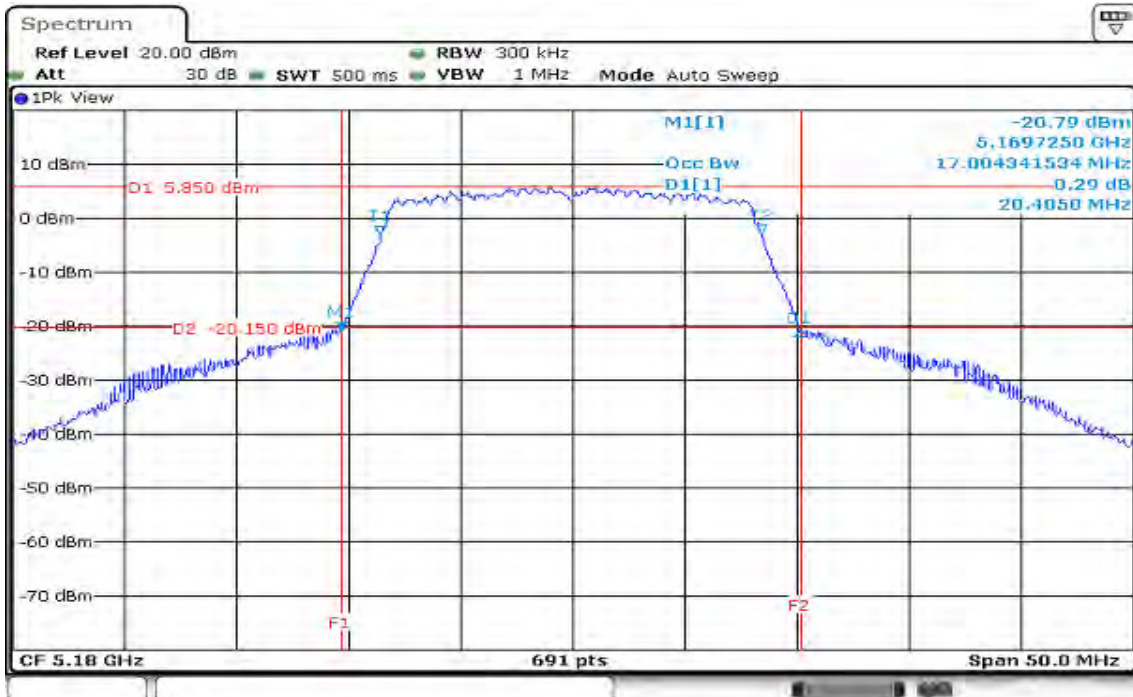

Date: 8 SEP 2016 15:52:27

CH Mid

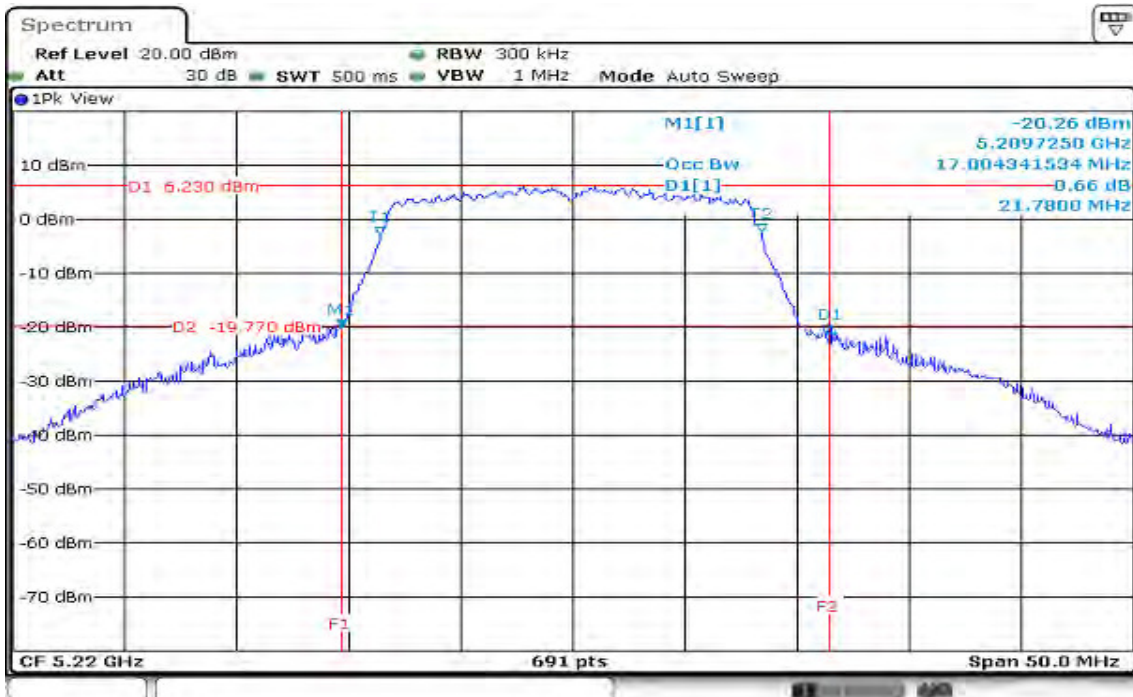

Date: 8 SEP 2016 16:05:08

CH High

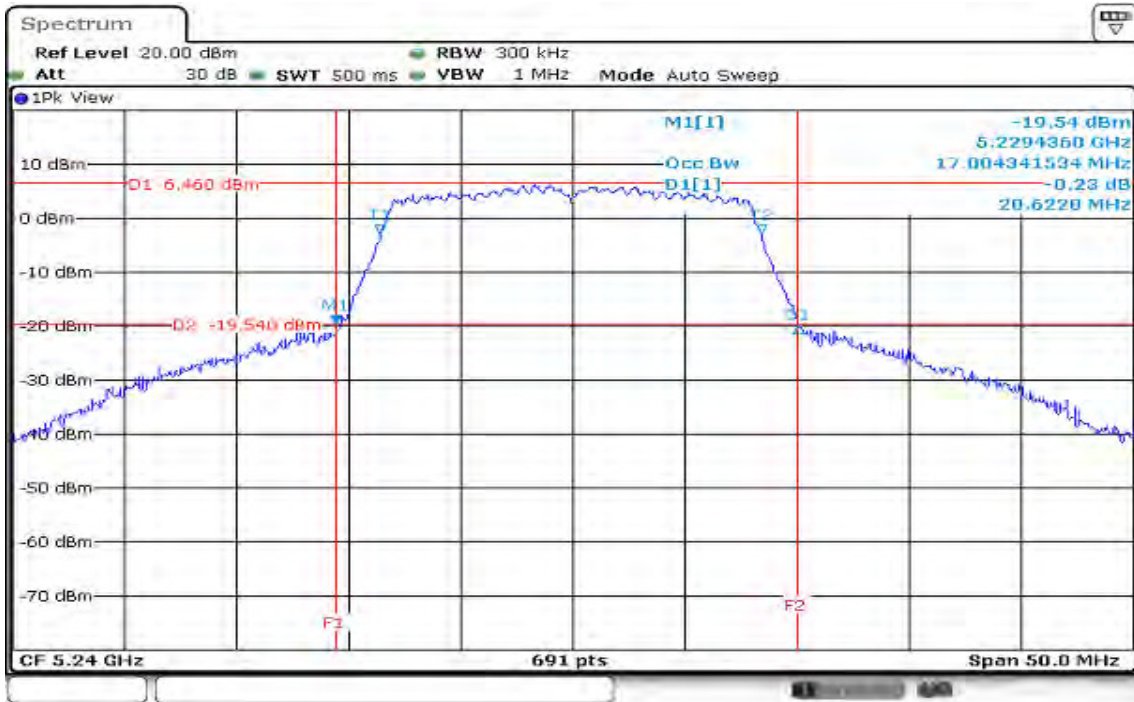

Date: 8 SEP 2016 16:13:21

IEEE 802.11n HT 20 MHz mode / 5180 ~ 5240MHz/ Chain 0

CH Low

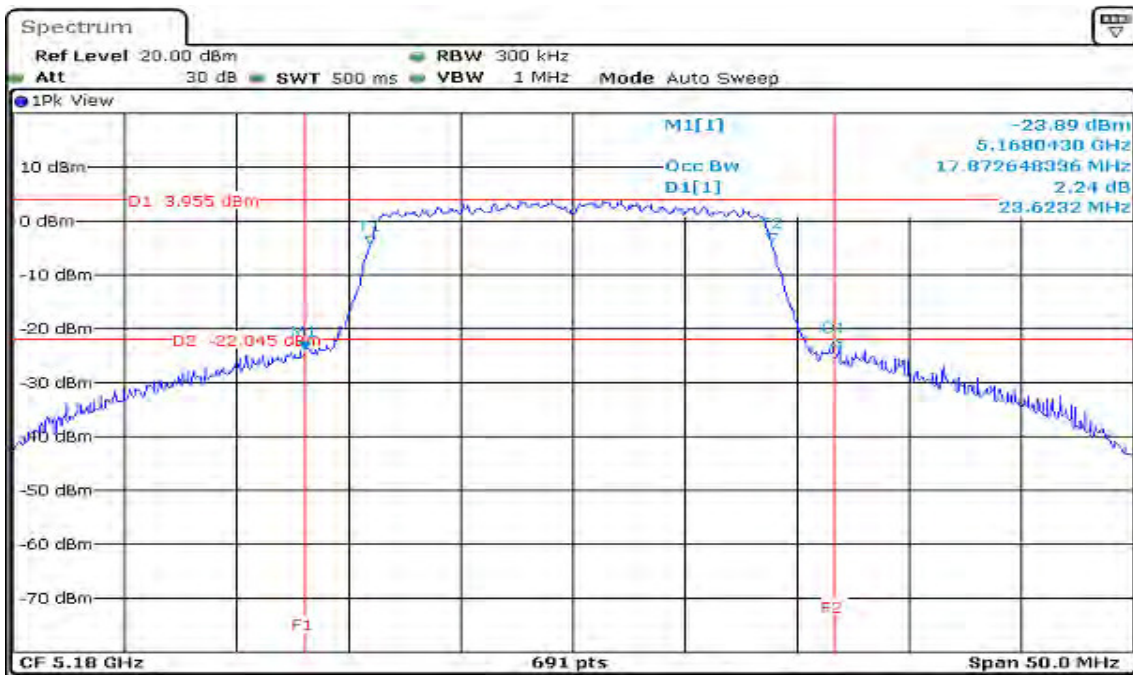

Date: 8 SEP 2016 16:27:04

CH Mid

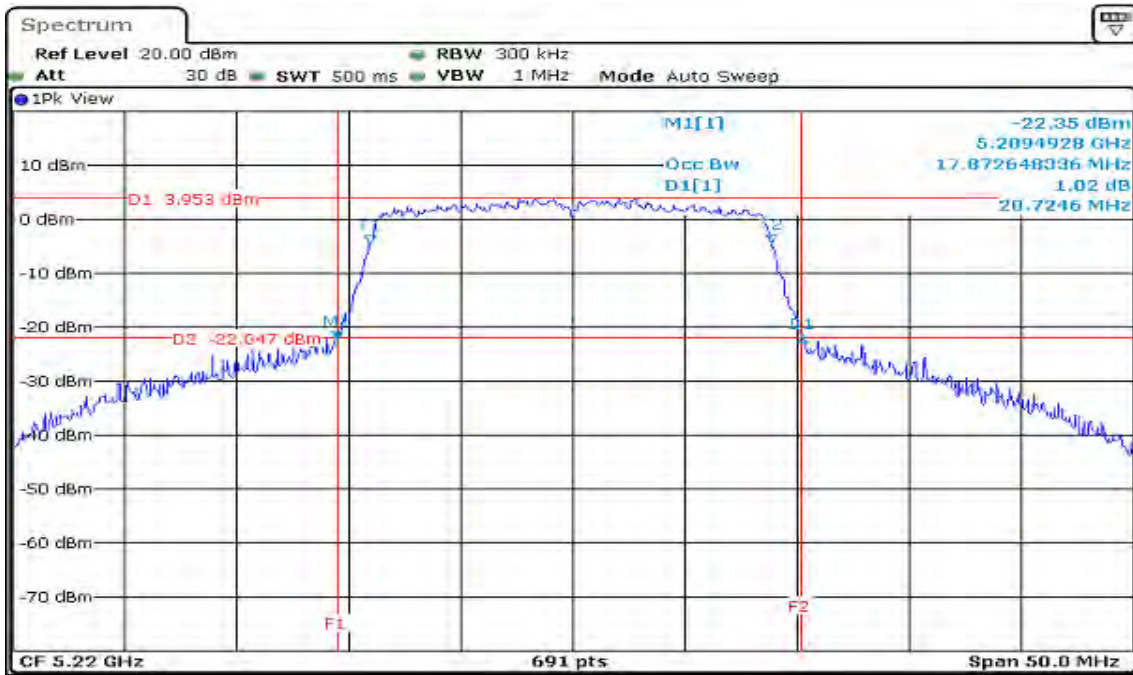

Date: 8 SEP 2016 16:31:33

CH High

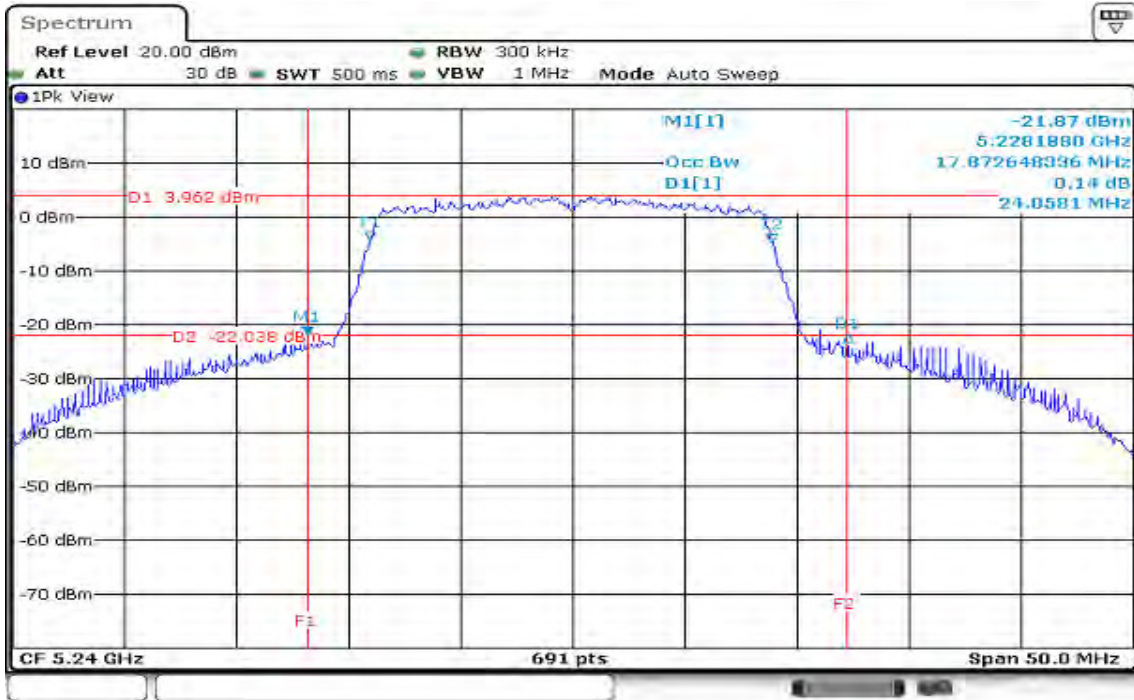

Date: 8 SEP 2016 16:42:33

IEEE 802.11n HT 20 MHz mode / 5180 ~ 5240MHz/ Chain 1

CH Low

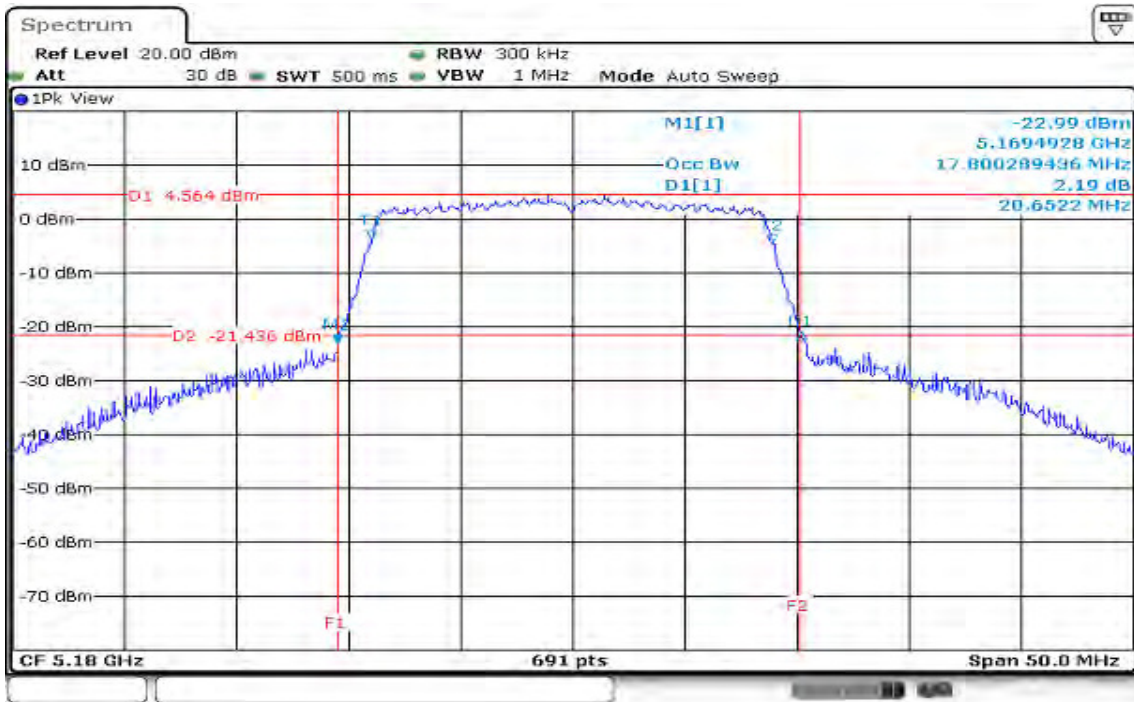

Date: 8 SEP 2016 16:22:23

CH Mid

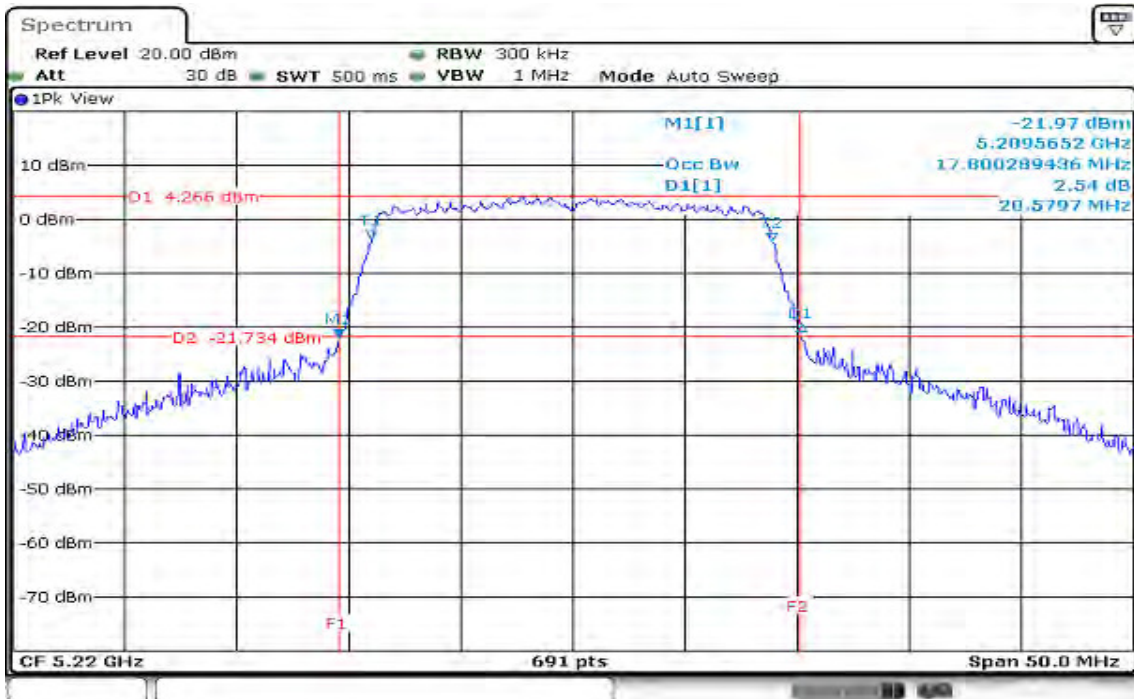

Date: 8 SEP 2016 16:24:54

CH High

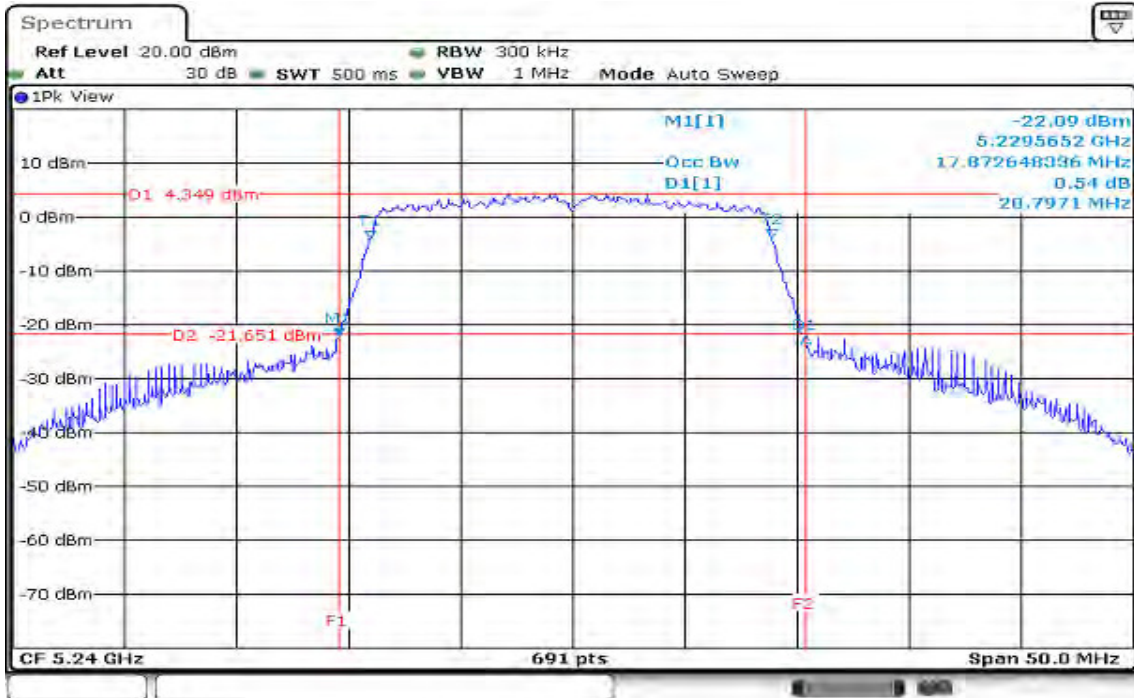

Date: 8 SEP 2016 16:28:48

IEEE 802.11n HT 40 MHz mode / 5190 ~ 5230MHz/ Chain 0

CH Low

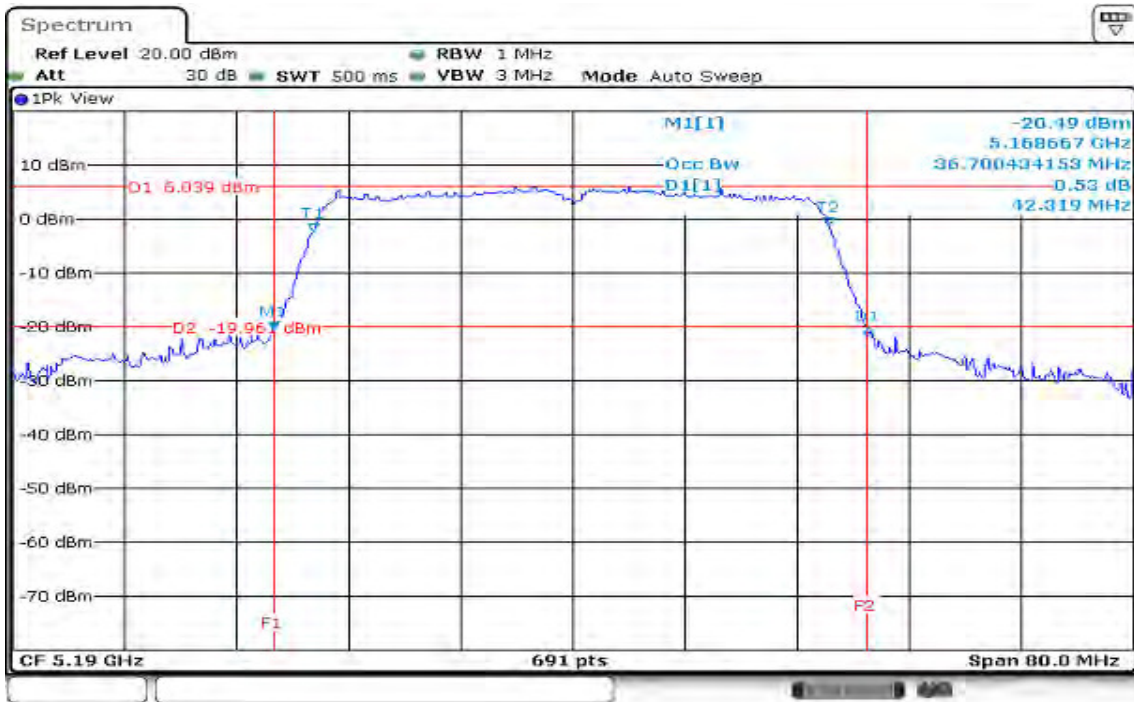

Date: 8 SEP 2016 16:46:35

CH High



Date: 8 SEP 2016 16:57:14

IEEE 802.11n HT 40 MHz mode / 5190 ~ 5230MHz/ Chain 1

CH Low

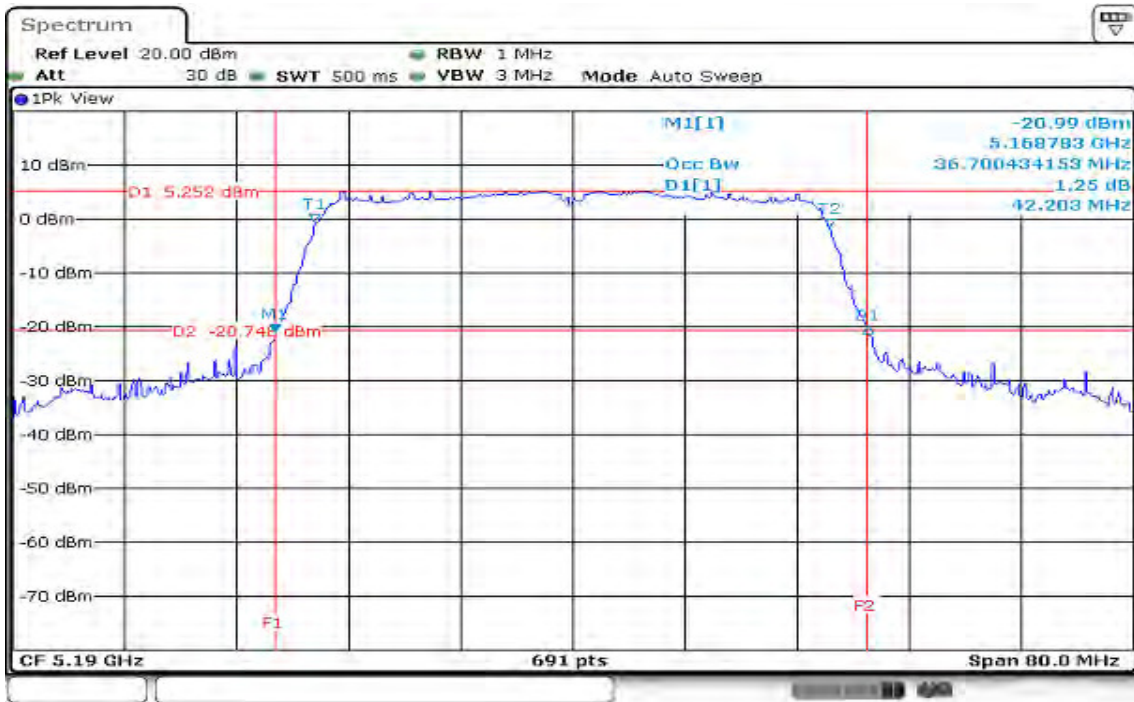

Date: 8 SEP 2016 16:50:08

CH High



Date: 8 SEP 2016 16:54:05

IEEE 802.11a mode / 5260 ~ 5320MHz

CH Low

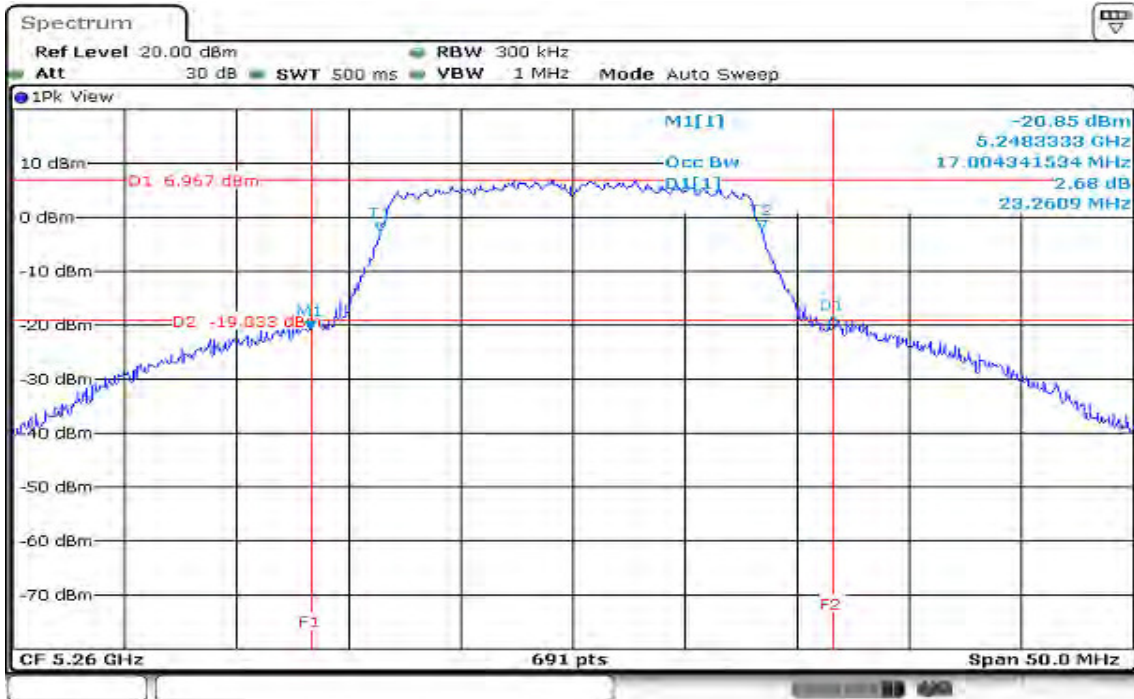

Date: 12/31/2016 09:23:19

CH Mid

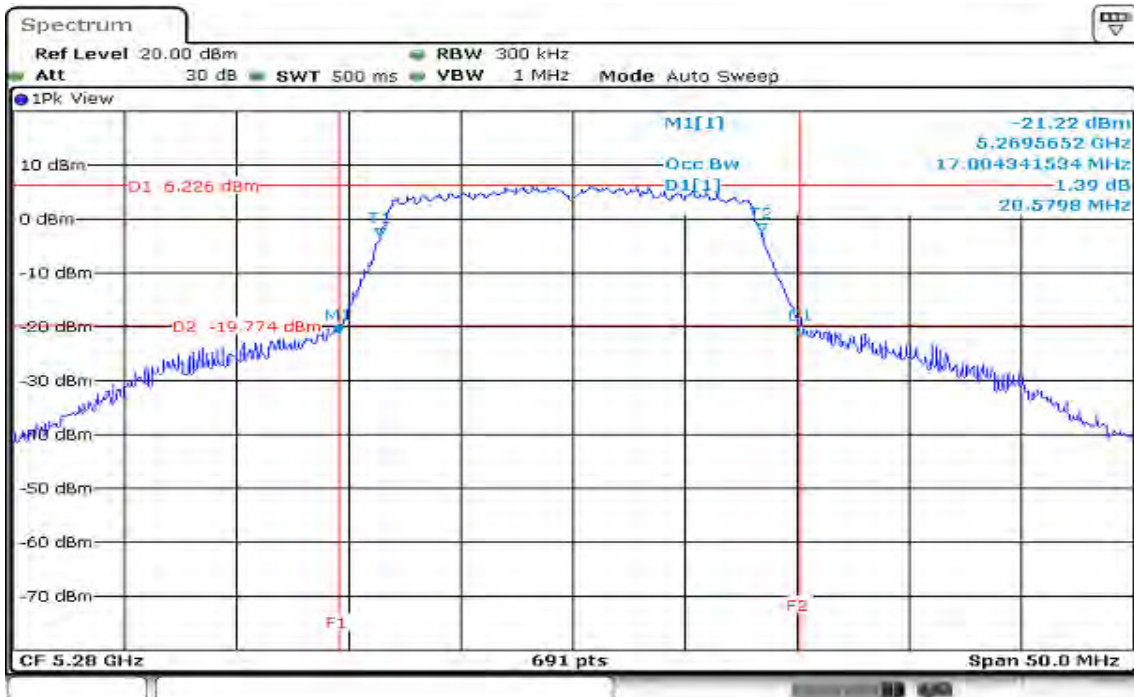

Date: 12/31/2016 09:48:27

CH High

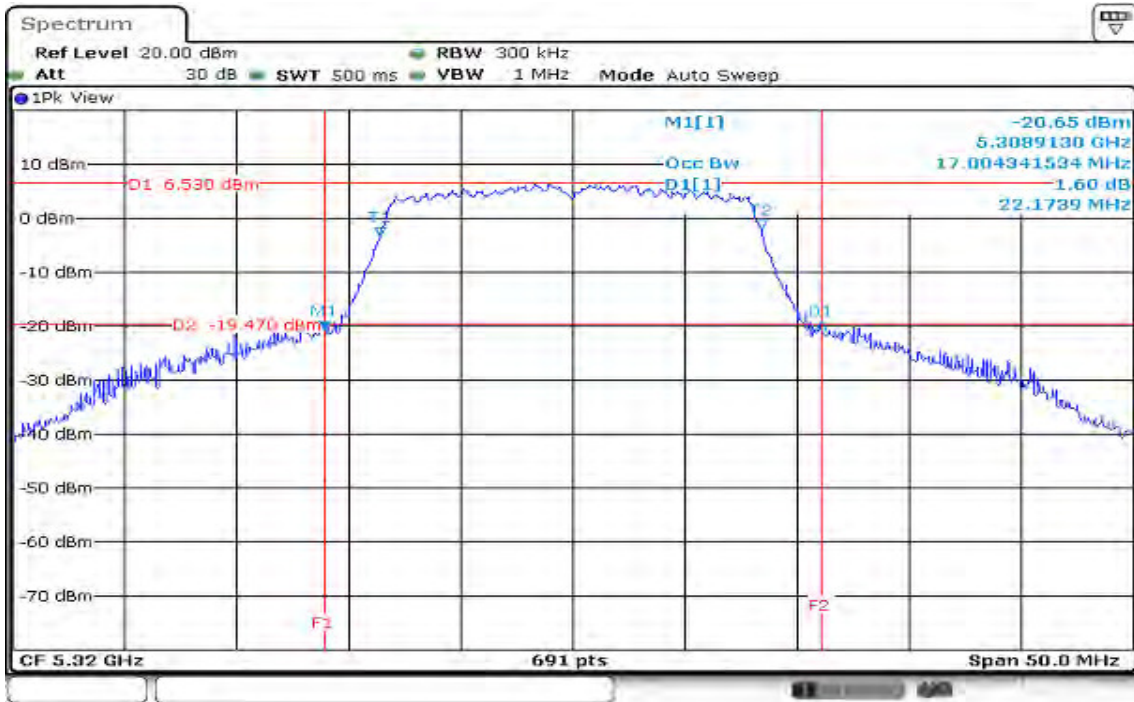

IEEE 802.11n HT 20 MHz mode / 5260 ~ 5320MHz/ Chain 0

CH Low

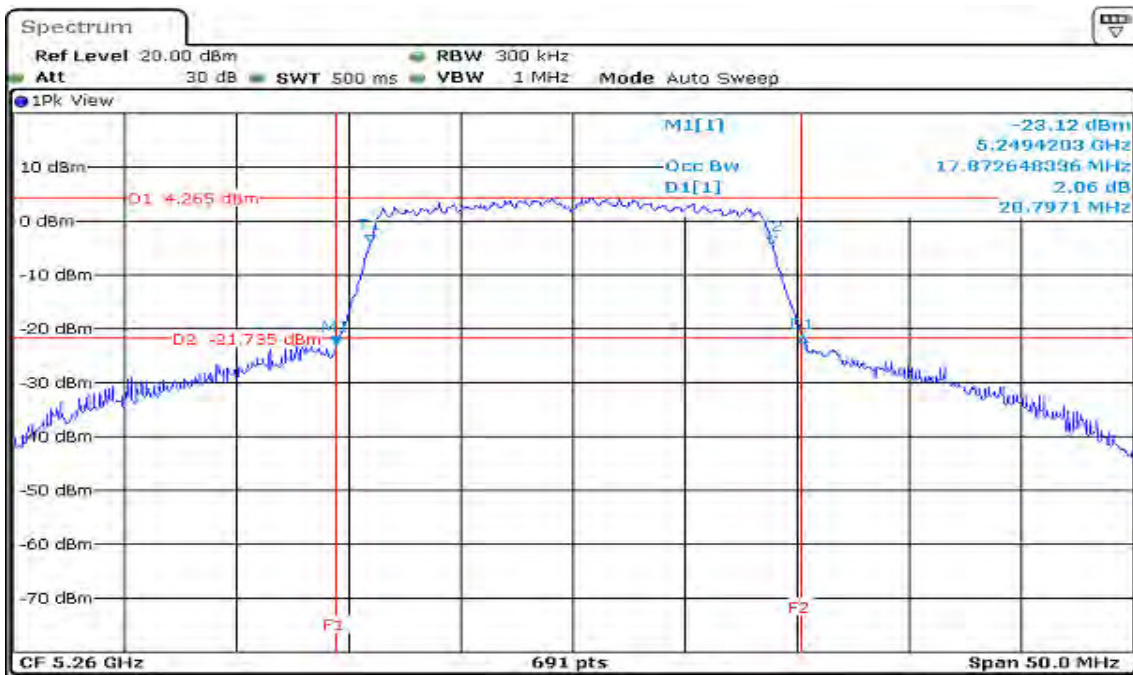

Date: 12 SEP 2016 10:03:12

CH Mid

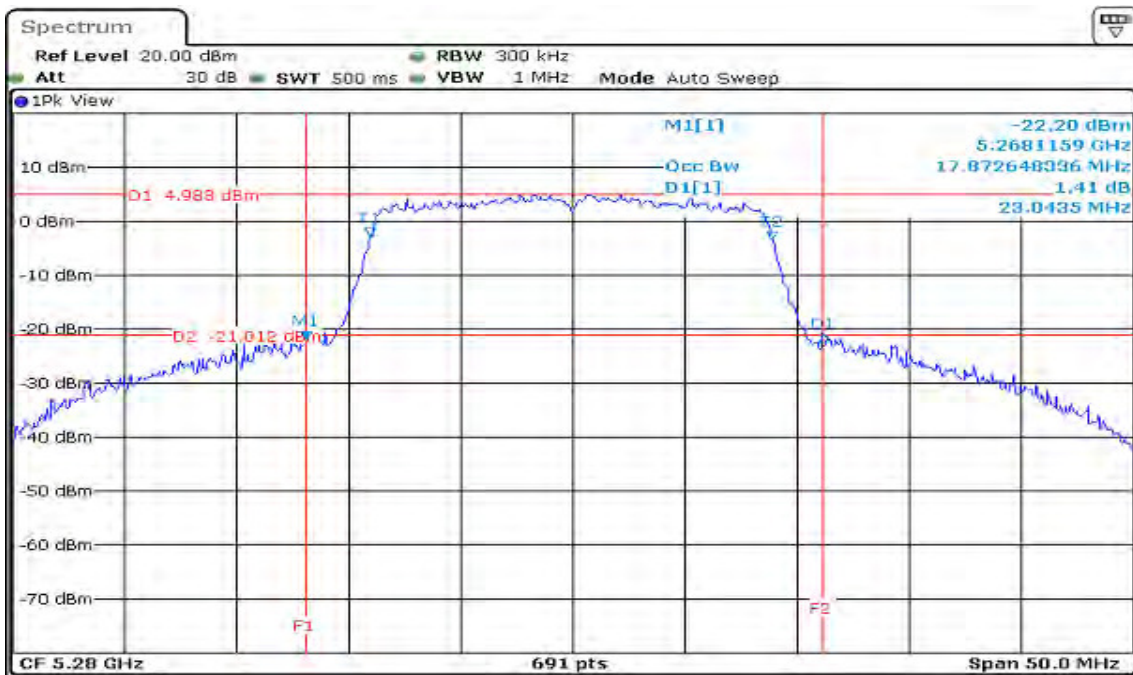

Date: 12 SEP 2016 10:05:45

CH High



IEEE 802.11n HT 20 MHz mode / 5260 ~ 5320MHz/ Chain 1

CH Low

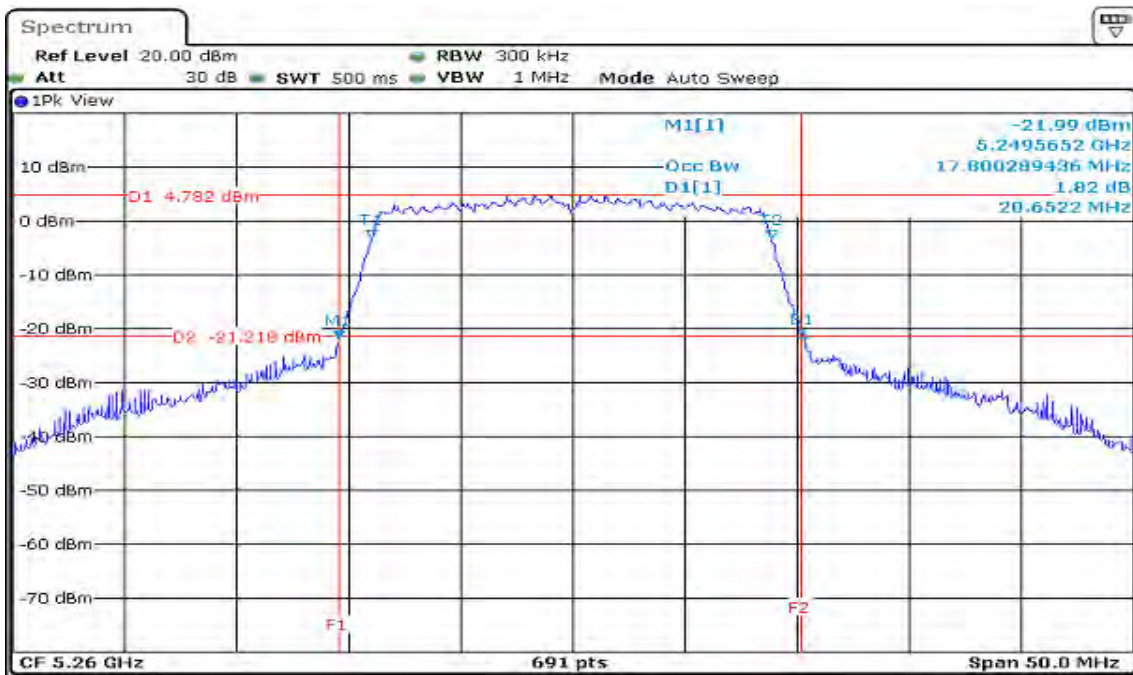

Date: 12 SEP 2016 09:58:01

CH Mid

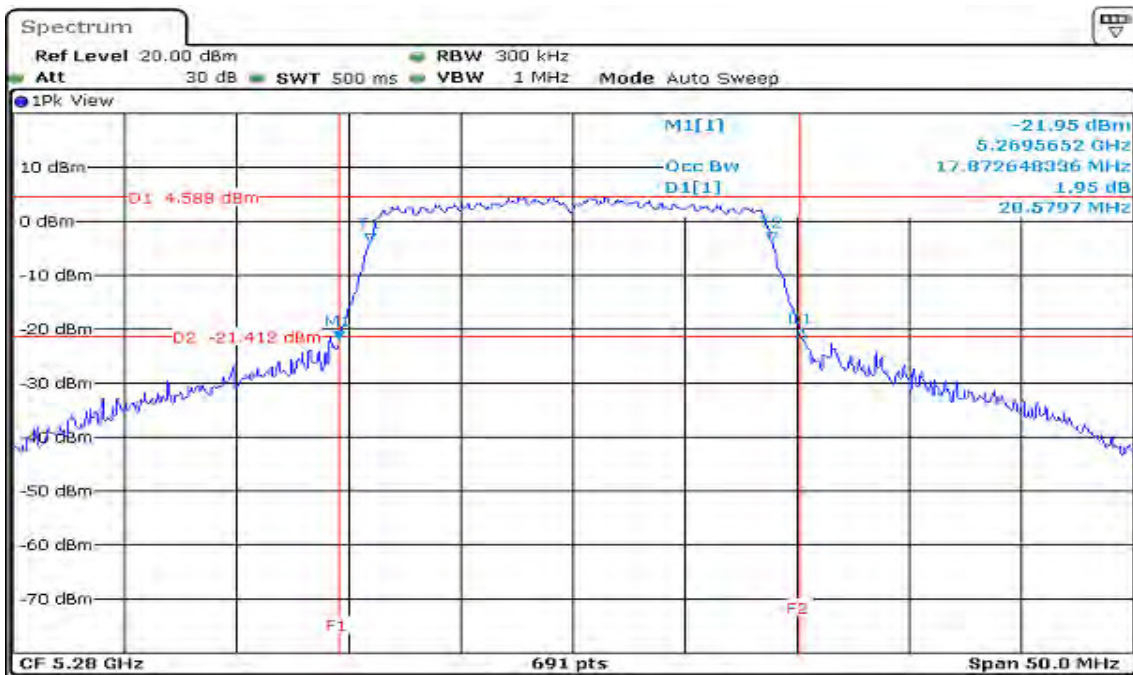

Date: 12 SEP 2016 10:08:41

CH High

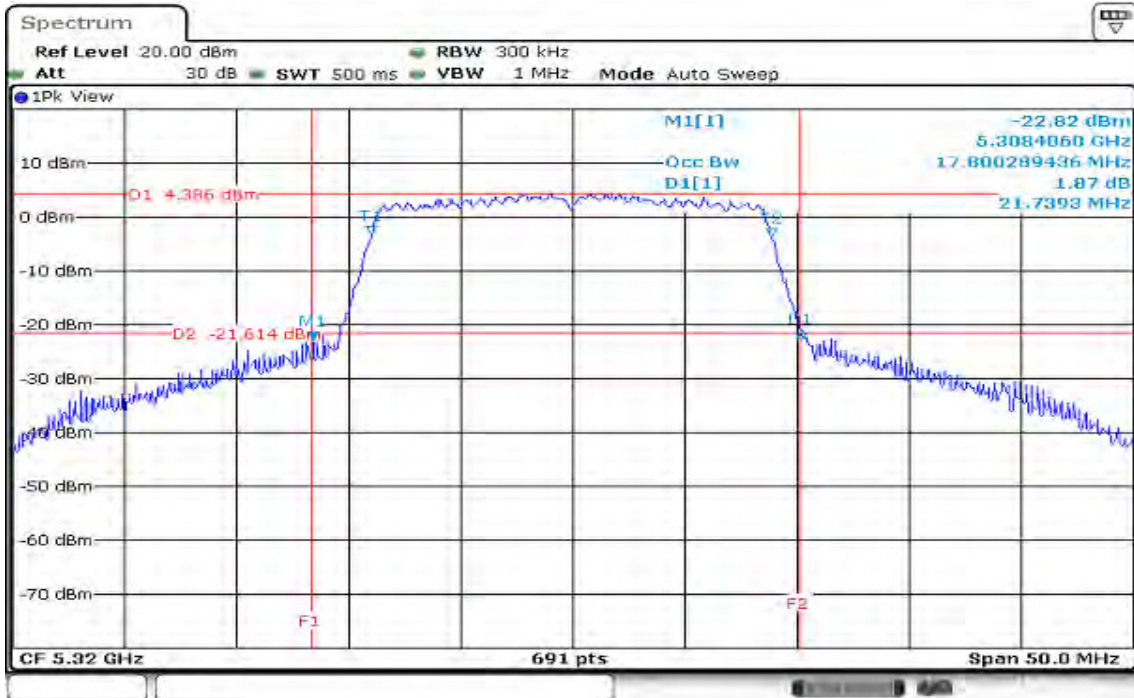

Date: 12 SEP 2016 10:13:58

IEEE 802.11n HT 40 MHz mode / 5270 ~ 5310MHz/ Chain 0

CH Low

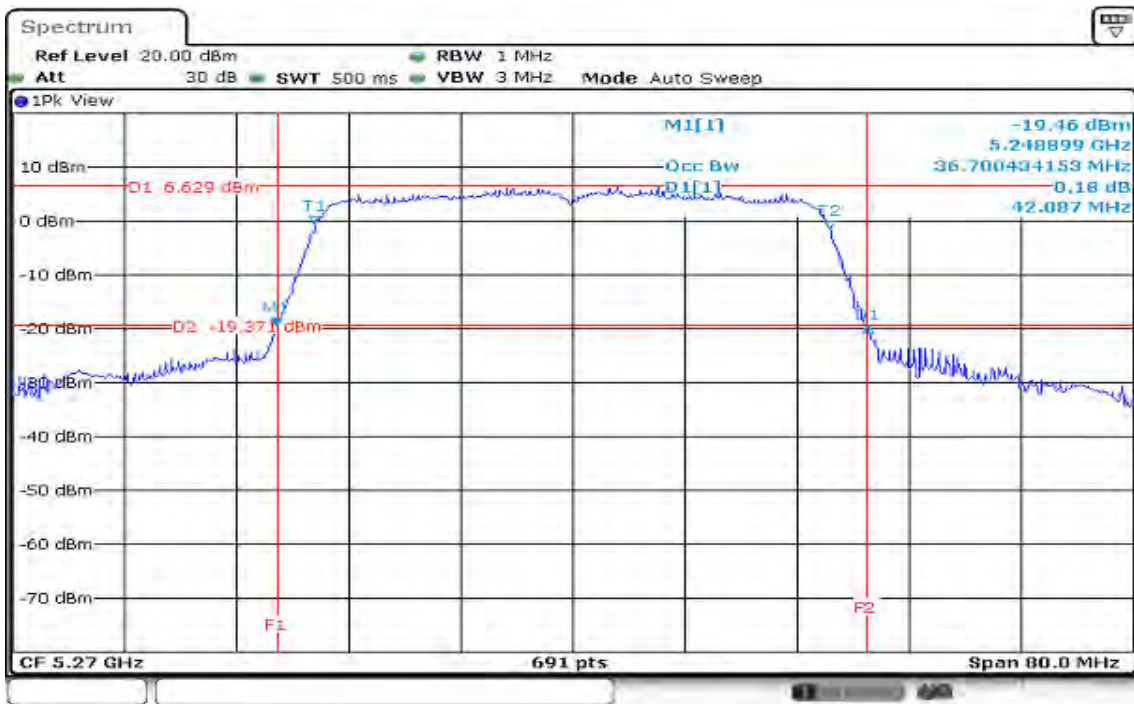

CH High



IEEE 802.11n HT 40 MHz mode / 5270 ~ 5310MHz/ Chain 1

CH Low

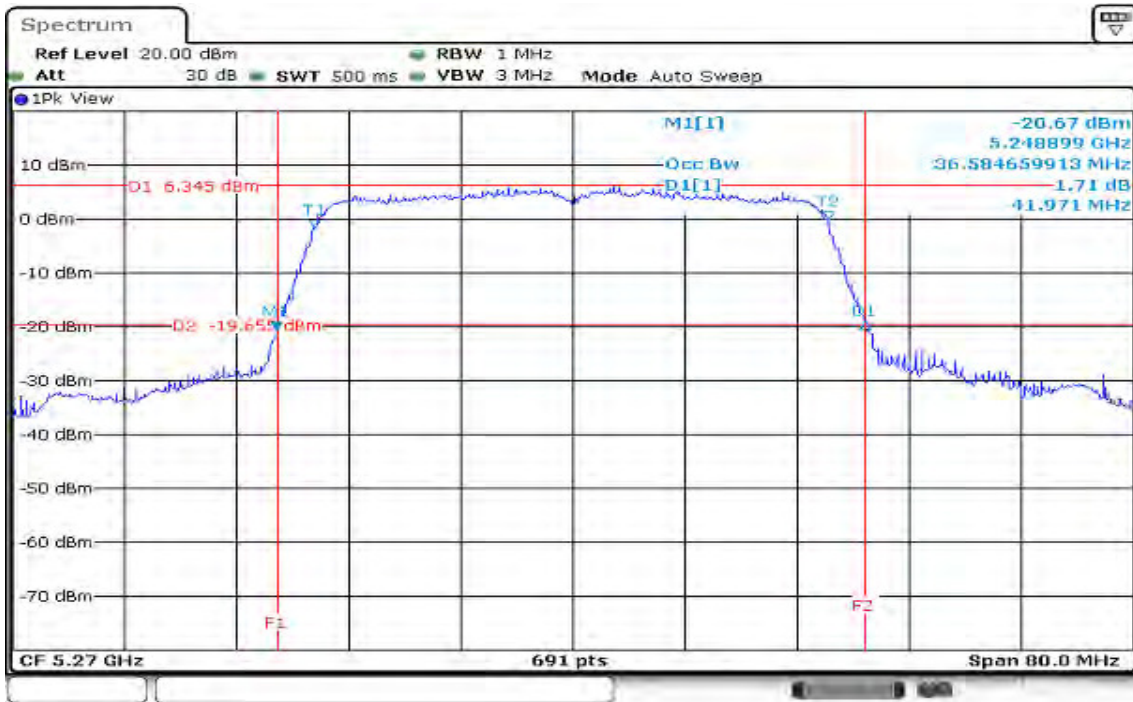

CH High

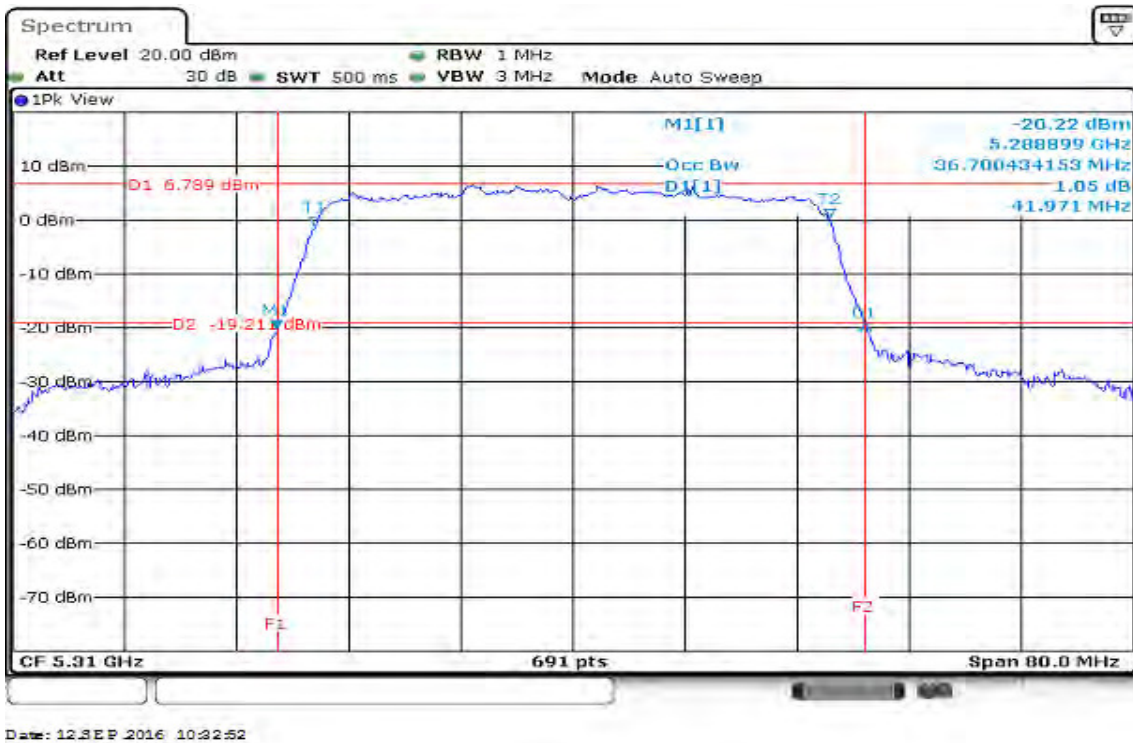

Test mode: IEEE 802.11a mode / 5500 ~ 5700MHz

CH Low

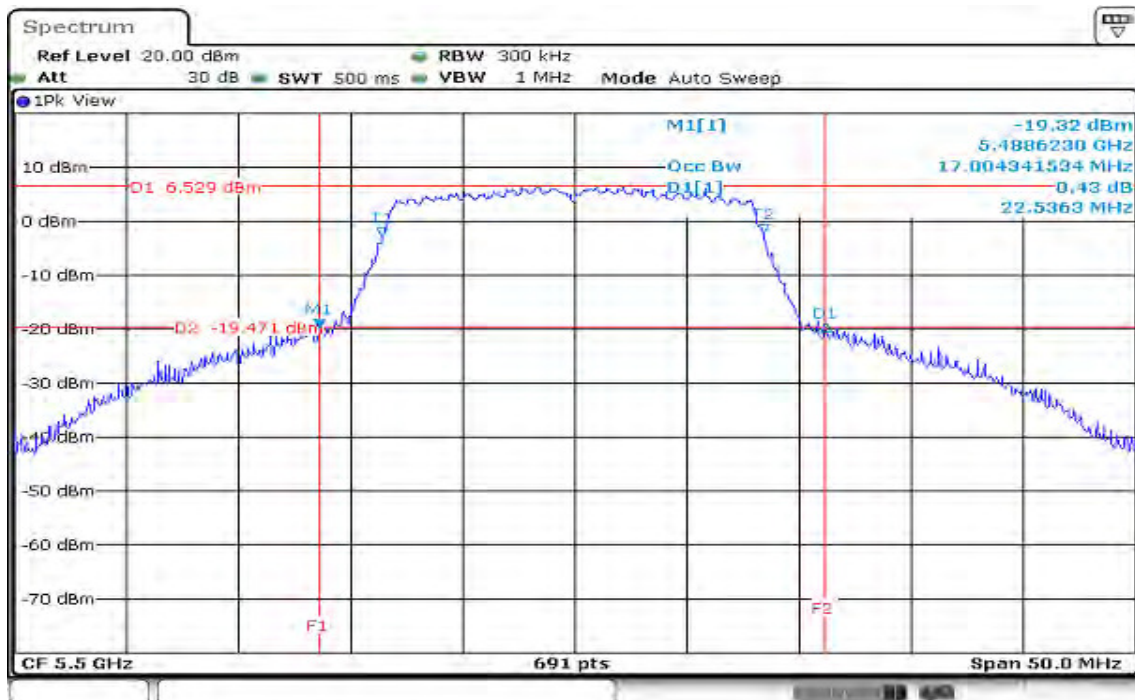

Date: 12.8.E.P. 2016 10:51:22

CH Mid

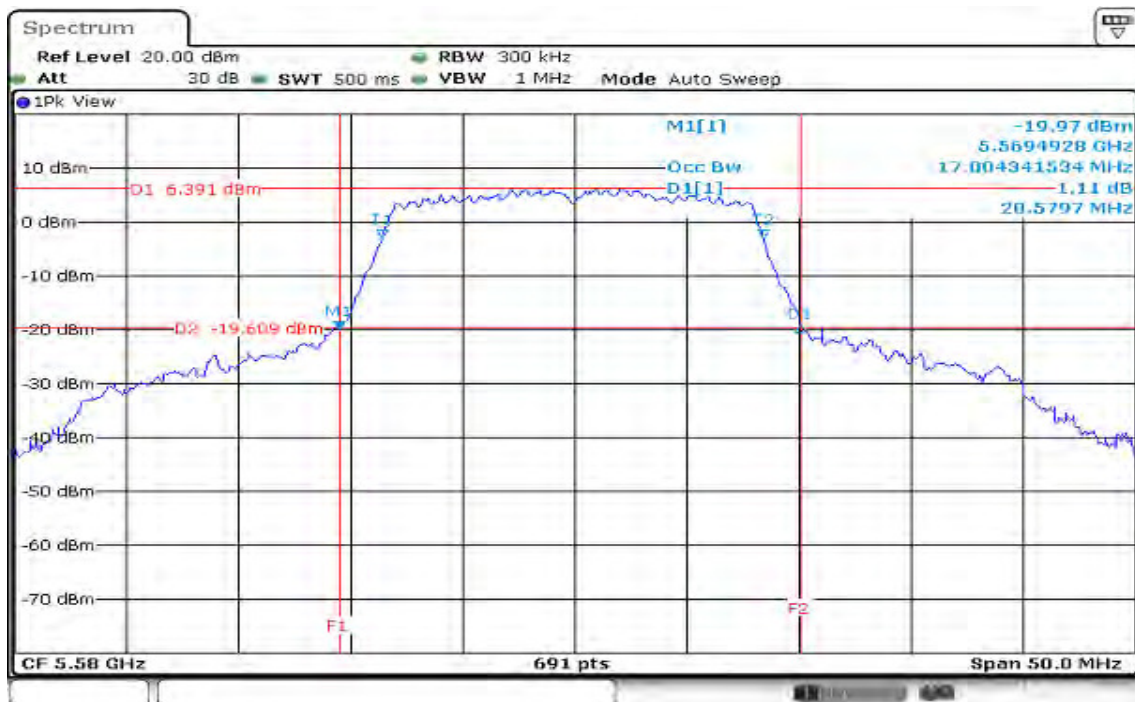

Date: 12.8.E.P. 2016 10:54:09

CH High

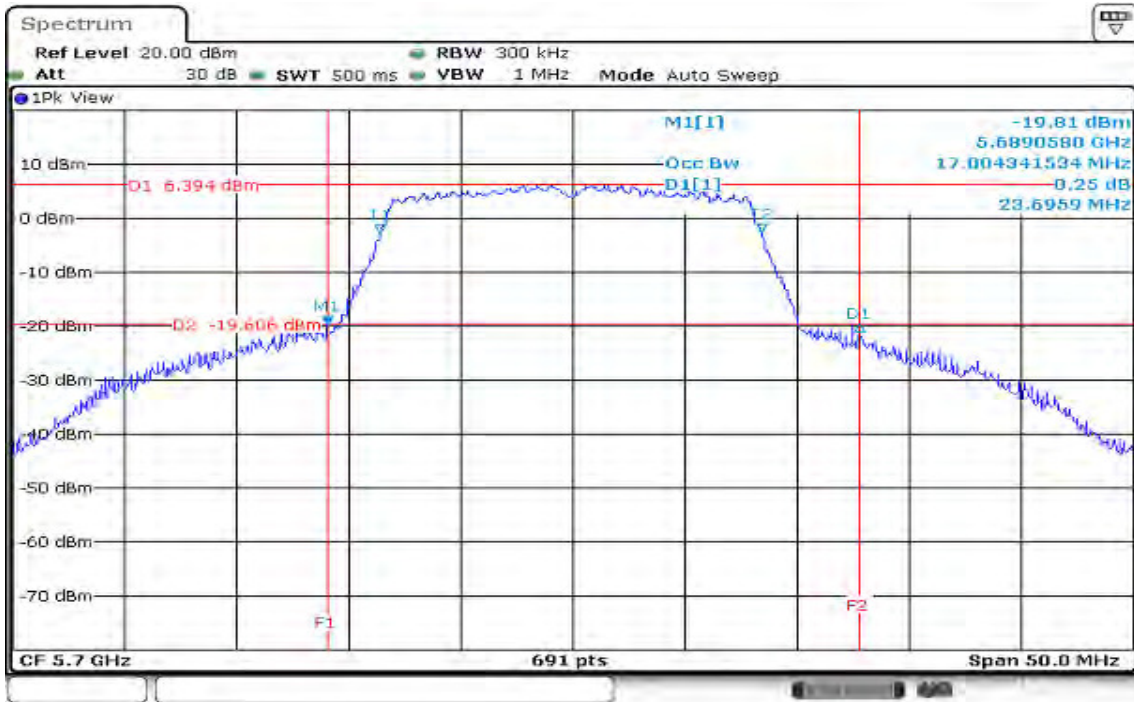

Date: 12 SEP 2016 11:08:59

IEEE 802.11n HT 20 MHz mode / 5500 ~ 5700MHz / Chain 0

CH Low

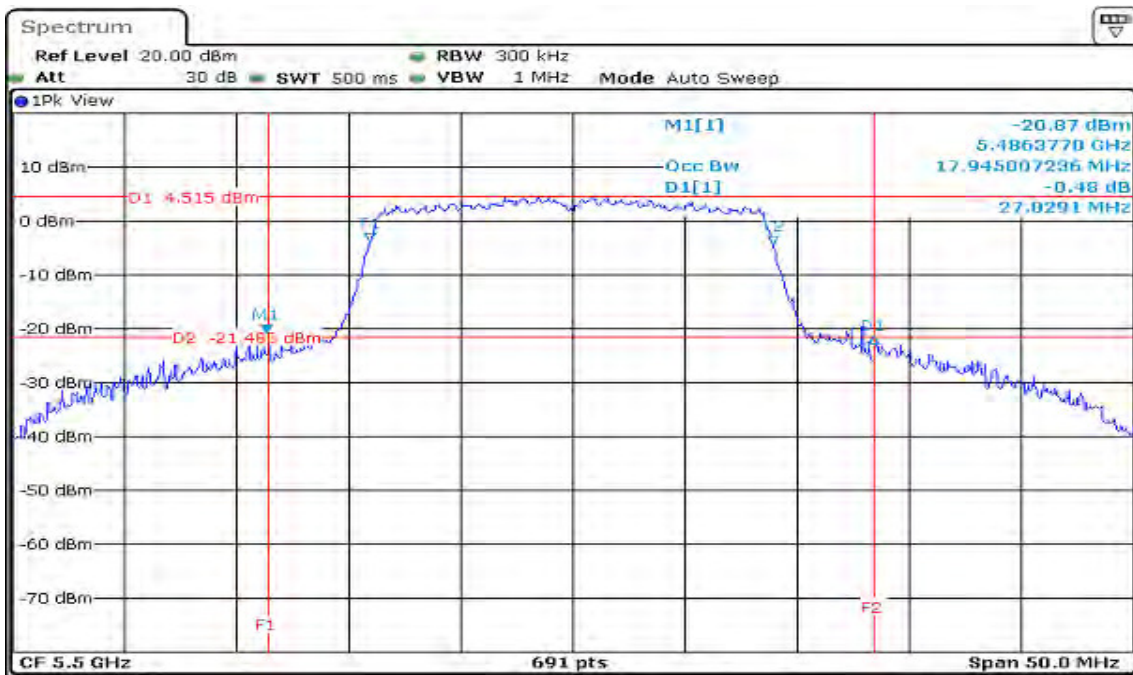

Date: 12 SEP 2016 11:24:43

CH Mid

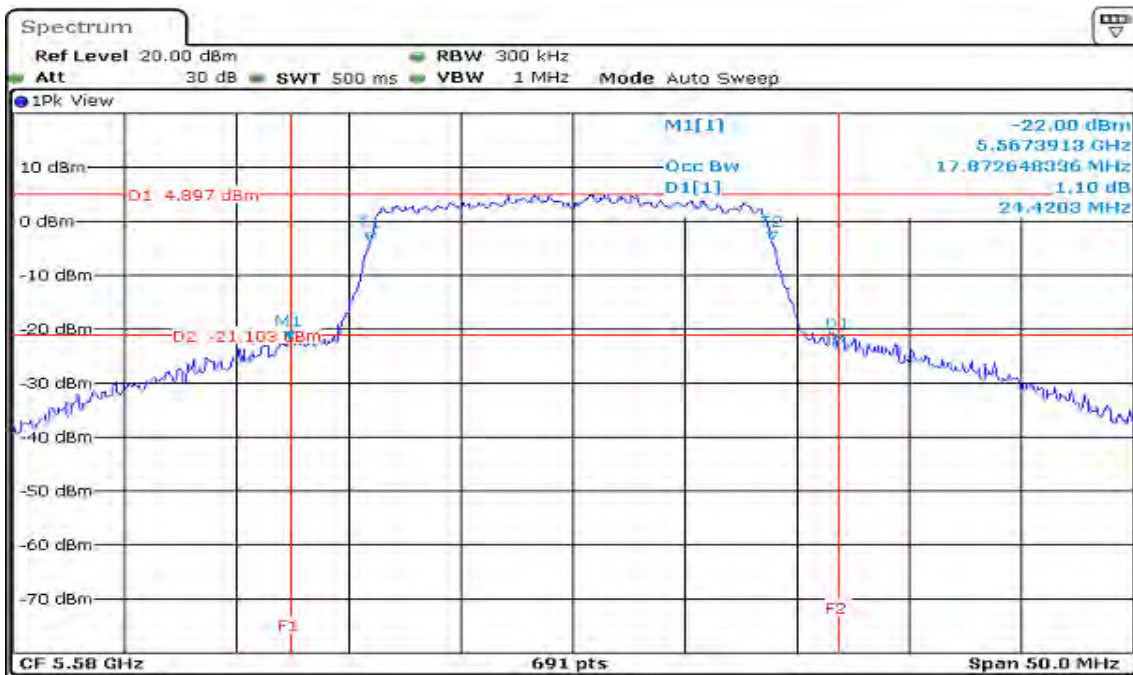

Date: 12 SEP 2016 11:31:23

CH High

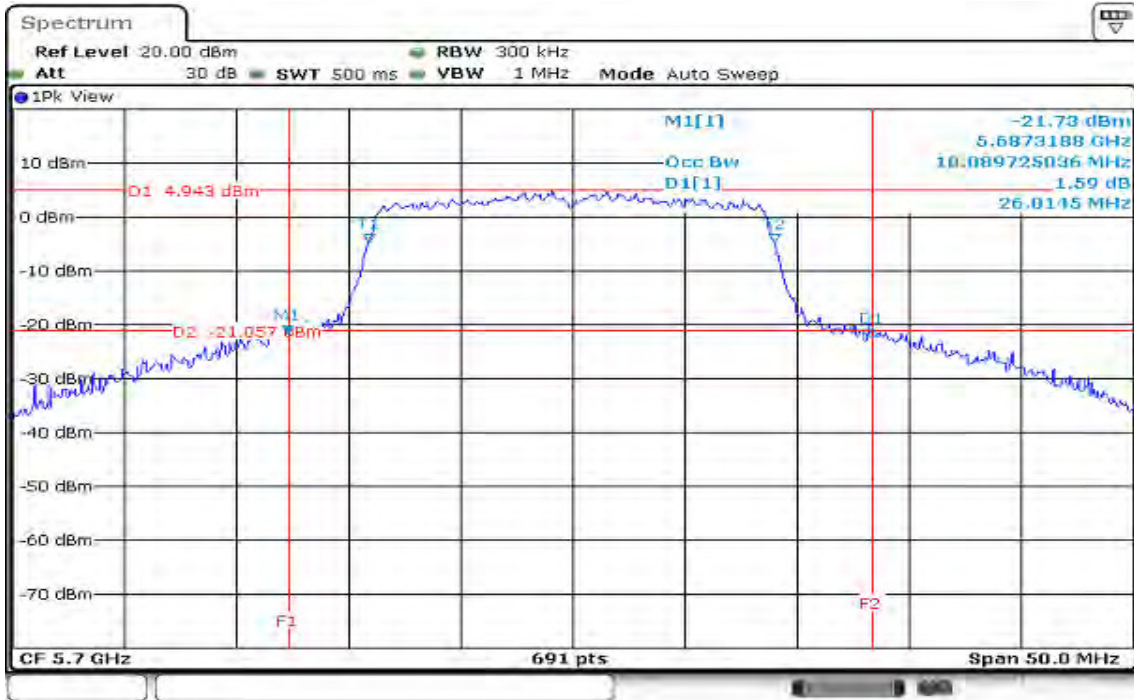

Date: 12 SEP 2016 11:44:10

IEEE 802.11n HT 20 MHz mode / 5500 ~ 5700MHz / Chain 1

CH Low

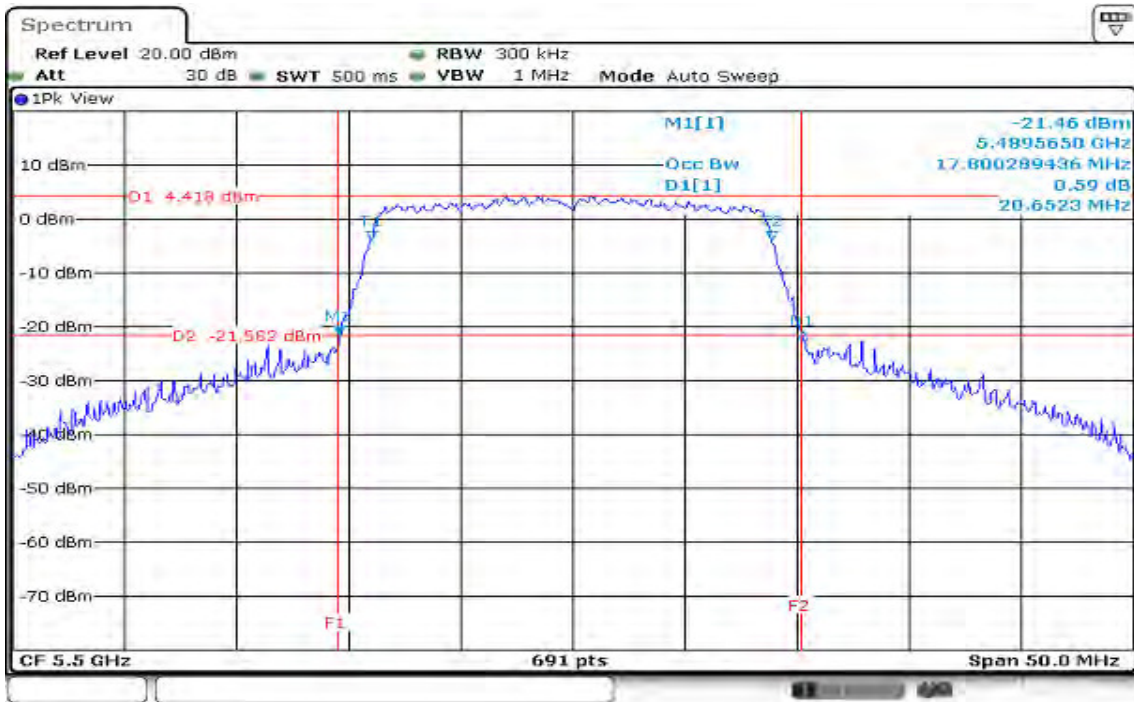

Date: 12 SEP 2016 11:20:16

CH Mid

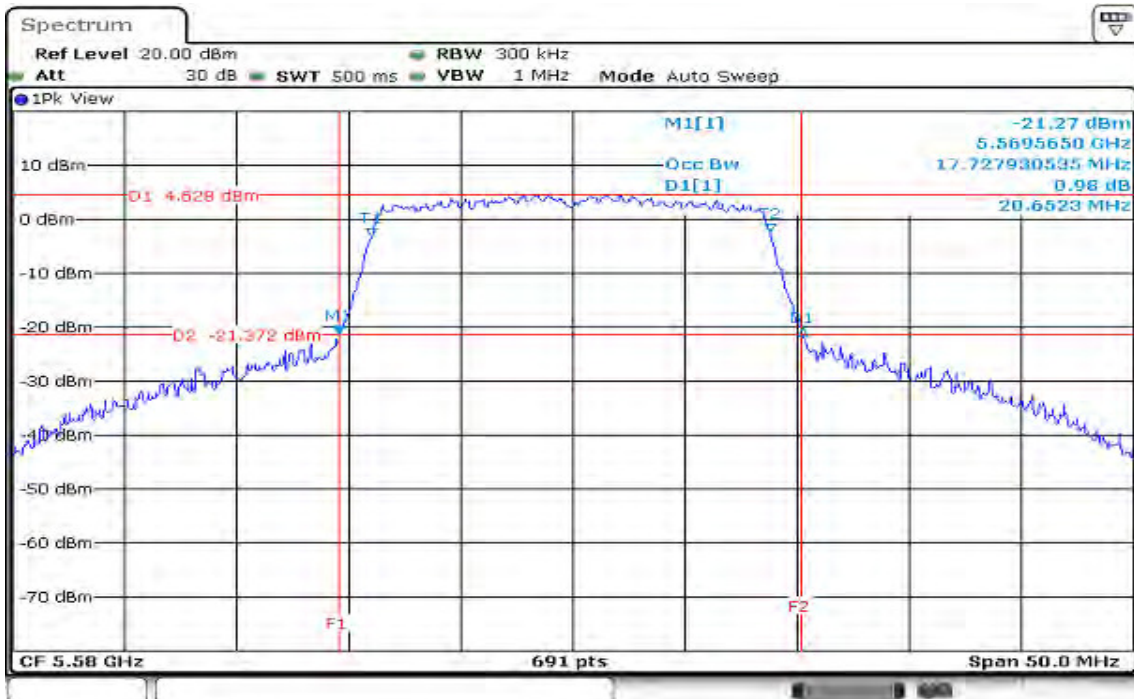

Date: 12 SEP 2016 11:26:07

CH High

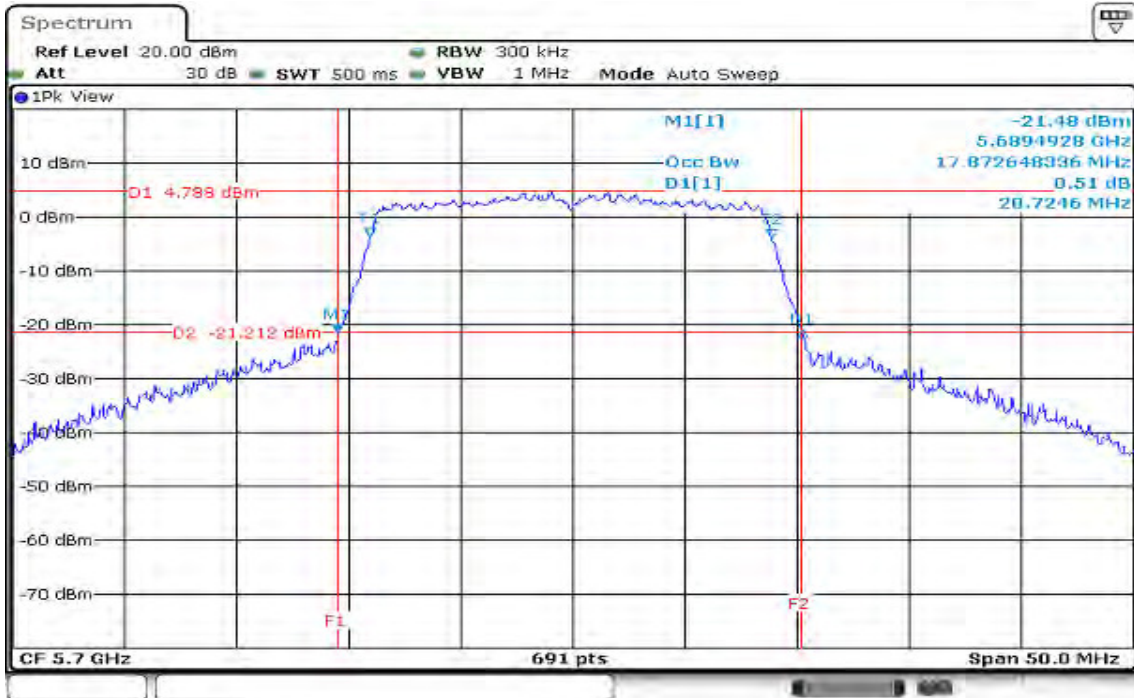

Date: 12 SEP 2016 11:29:24

IEEE 802.11n HT 40 MHz mode / 5510 ~ 5670MHz / Chain 0

CH Low



Date: 12/31/2016 11:48:19

CH Mid



Date: 12/31/2016 12:01:25

CH High

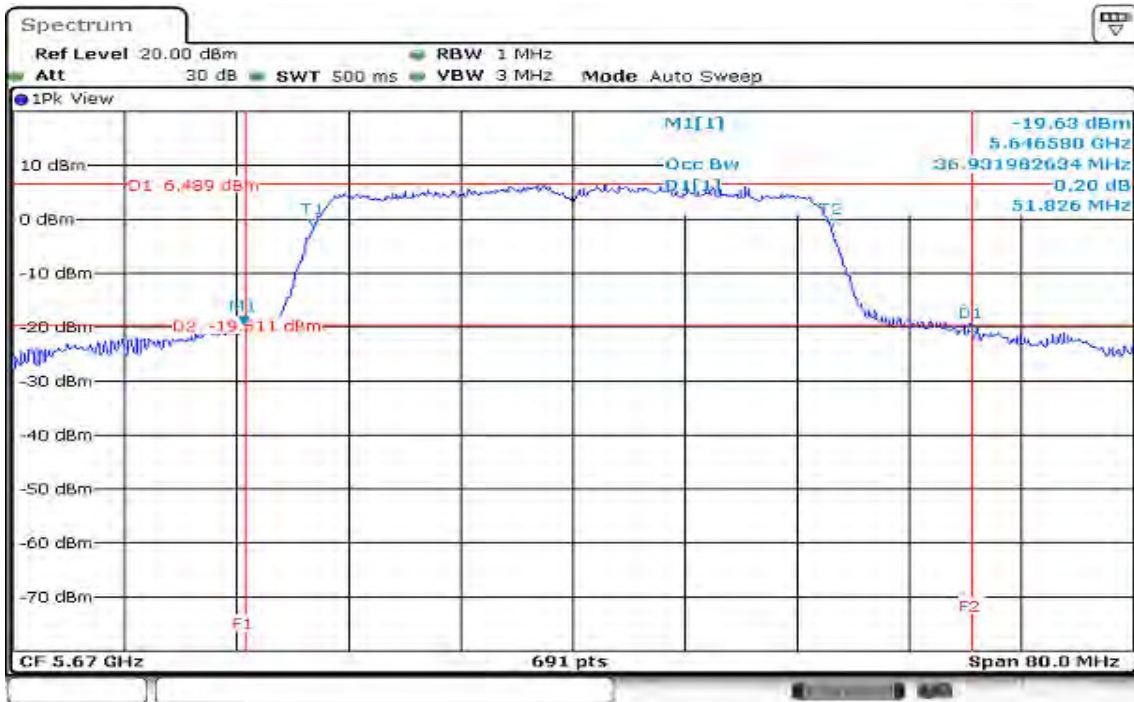

Date: 12 SEP 2016 13:09:52

IEEE 802.11n HT 40 MHz mode / 5510 ~ 5670MHz / Chain 1

CH Low

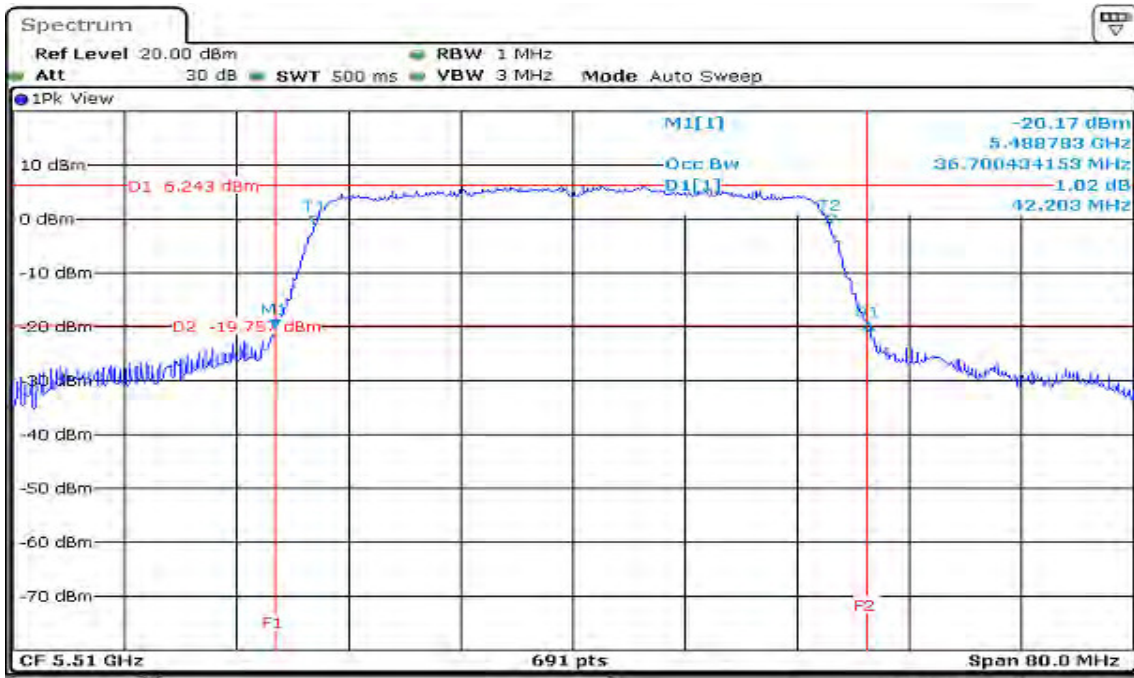

Date: 12 SEP 2016 11:52:25

CH Mid



Date: 12 SEP 2016 11:57:07

CH High

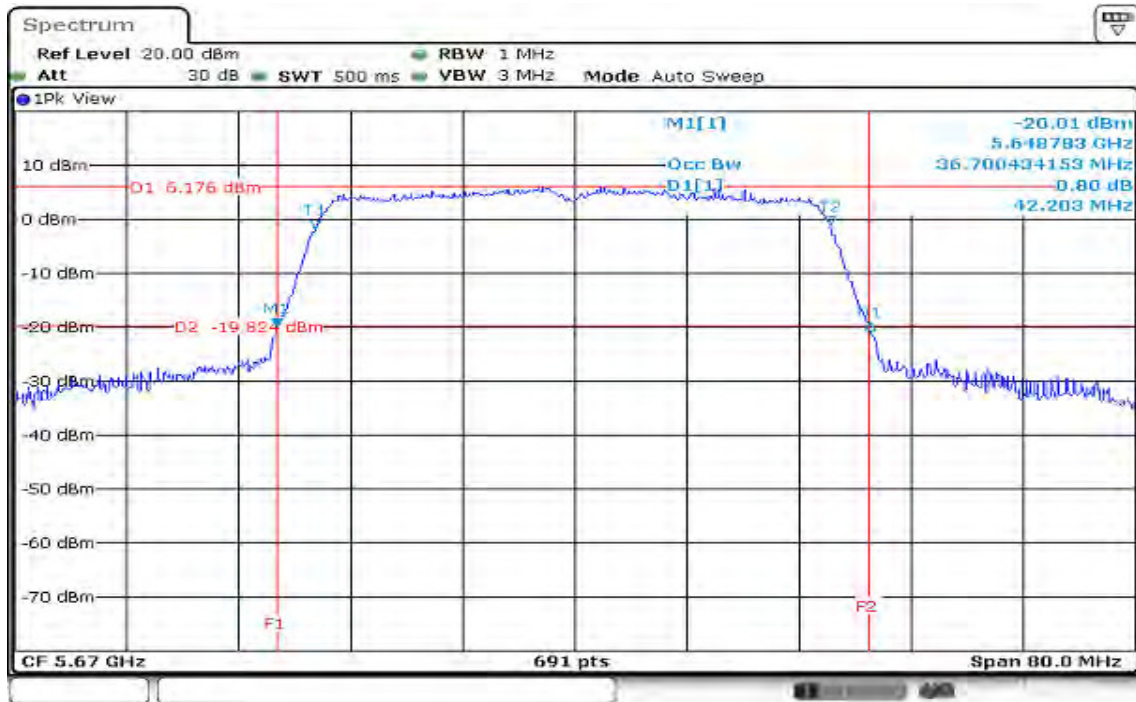

Date: 12 SEP 2016 13:07:34

7.3 MAXIMUM CONDUCTED OUTPUT POWER

LIMIT

1. According to §15.407(a)

For the band 5.15-5.25 GHz, 5.25-5.35 GHz and 5.47-5.725 GHz bands, the maximum conducted output power over the frequency band of operation shall not exceed the lesser of 250 mW or $11 \text{ dBm} + 10 \log B$, where B is the 26 dB emission bandwidth in MHz.

If transmitting antennas of directional gain greater than 6dBi are used, both the peak transmit power and the peak power spectral density shall be reduced by the amount in dB that the directional gain of the antenna exceeds 6dBi

2. According to RSS-247,

(1) For the band 5150-5250 MHz, the maximum equivalent isotropically radiated power (e.i.r.p.) shall not exceed 200 mW or $10 + 10 \log B$, dBm, whichever power is less. B is the 99% emission bandwidth in MHz. The e.i.r.p. spectral density shall not exceed 10 dBm in any 1.0 MHz band.

(2) For the band 5250-5350 MHz and 5470-5725 MHz, the maximum conducted output power shall not exceed 250 mW or $11 + 10 \log B$, dBm, whichever power is less. The power spectral density shall not exceed 11 dBm in any 1.0 MHz band. The maximum e.i.r.p. shall not exceed 1.0 W or $17 + 10 \log B$, dBm, whichever power is less. B is the 99% emission bandwidth in MHz.

In addition, devices with maximum e.i.r.p. greater than 500 mW shall implement TPC in order to have the capability to operate at least 6 dB below the maximum permitted e.i.r.p. of 1 W.

The peak power shall not exceed the limit as follow:

Test Configuration

The EUT was connected to a spectrum analyzer through a 50Ω RF cable.

TEST PROCEDURE

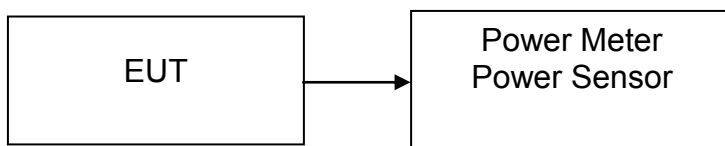

Set span to encompass the entire emission bandwidth (EBW) of the signal.

Set RBW = 1 MHz / Set VBW = 3 MHz.

Use sample detector mode if bin width (i.e., span/number of points in spectrum display) < 0.5 RBW. Otherwise use peak detector mode. Use a video trigger with the trigger level set to enable triggering only on full power pulses. Transmitter must operate at full control power for entire sweep of every sweep. If the device transmits continuously, with no off intervals or reduced power intervals, the trigger may be set to "free run". Trace average 100 traces in power averaging mode. Compute power by integrating the spectrum across the 26 dB EBW of the signal. The integration can be performed using the spectrum analyzer's band power measurement function with band limits set equal to the EBW band edges or by summing power levels in each 1 MHz band in linear power terms. The 1 MHz band power levels to be summed can be obtained by averaging, in linear power terms, power levels in each frequency bin across the 1 MHz.

TEST RESULTS

No non-compliance noted

Test Data

Test mode: IEEE 802.11a mode / 5180 ~ 5240MHz

Channel	Frequency (MHz)	Maximum Output Power (dBm)	Maximum Output Power (W)	Maximum EIRP Output Power (dBm)	EIRP IC limit (dBm)	FCC limit (dBm)
Low	5180	15.17	0.0329	16.14	23.00	24.00
Mid	5220	15.19	0.0330	16.16	23.00	24.00
High	5240	*15.29	0.0338	16.26	23.00	24.00

Test mode: IEEE 802.11n HT 20 MHz mode / 5180 ~ 5240MHz

Channel	Frequency (MHz)	Chain 0 Output Power (dBm)	Chain 1 Output Power (dBm)	Total Maximum Conducted Output Power (dBm)	Maximum Output Power (W)	Total Maximum EIRP Output Power (dBm)	EIRP IC limit (dBm)	FCC limit (dBm)
Low	5180	15.95	15.87	*19.43	0.0877	20.40	23.00	24.00
Mid	5220	15.82	15.68	19.37	0.0865	20.34	23.00	24.00
High	5240	15.71	15.76	19.26	0.0843	20.23	23.00	24.00

Test mode: IEEE 802.11n HT 40 MHz mode / 5190 ~ 5230MHz

Channel	Frequency (MHz)	Chain 0 Output Power (dBm)	Chain 1 Output Power (dBm)	Total Maximum Conducted Output Power (dBm)	Maximum Output Power (W)	Total Maximum EIRP Output Power (dBm)	EIRP IC limit (dBm)	FCC limit (dBm)
Low	5190	13.94	13.91	17.89	0.0615	18.86	23.00	24.00
High	5230	13.92	13.96	*17.90	0.0617	18.87	23.00	24.00

Remark:

1. Total Output Power (w) = Chain 0 (10^(Output Power /10)/1000)+ Chain 1 (10^(Output Power /10)/1000)

Test mode: IEEE 802.11a mode / 5260 ~ 5320MHz

Channel	Frequency (MHz)	Maximum Output Power (dBm)	Maximum Output Power (W)	E.I.R.P Power (dBm)	IC E.I.R.P Limit (dBm)	FCC Limit (dBm)
Low	5260	15.44	0.0350	17.32	30.00	24.00
Mid	5280	15.28	0.0337	17.16	30.00	24.00
High	5320	*15.46	0.0352	17.34	30.00	24.00

Test mode: IEEE 802.11n HT 20 MHz mode / 5260 ~ 5320MHz

Channel	Frequency (MHz)	Chain 0 Output Power (dBm)	Chain 1 Output Power (dBm)	Total Maximum Conducted Output Power (dBm)	Maximum Output Power (W)	E.I.R.P Power (dBm)	IC E.I.R.P Limit (dBm)	FCC Limit (dBm)
Low	5260	15.75	15.95	*19.37	0.0865	20.35	30.00	24.00
Mid	5280	15.79	15.85	19.34	0.0859	20.32	30.00	24.00
High	5320	15.6	15.65	19.15	0.0822	20.12	30.00	24.00

Test mode: IEEE 802.11n HT 40 MHz mode / 5270 ~ 5310MHz

Channel	Frequency (MHz)	Chain 0 Output Power (dBm)	Chain 1 Output Power (dBm)	Total Maximum Conducted Output Power (dBm)	Maximum Output Power (W)	E.I.R.P Power (dBm)	IC E.I.R.P Limit (dBm)	FCC Limit (dBm)
Low	5270	13.73	13.93	17.79	0.0601	18.77	30.00	24.00
High	5310	13.96	13.9	*17.89	0.0615	18.87	30.00	24.00

Remark:

1. Total Output Power (w) = Chain 0 (10^(Output Power /10)/1000)+ Chain 1 (10^(Output Power /10)/1000)

Test mode: IEEE 802.11a mode / 5500 ~ 5700MHz

Channel	Frequency (MHz)	Maximum Output Power (dBm)	Maximum Output Power (W)	E.I.R.P Power (dBm)	IC E.I.R.P Limit (dBm)	FCC Limit (dBm)
Low	5500	*15.46	0.0352	17.34	30.00	24.00
Mid	5580	15.24	0.0334	17.12	30.00	24.00
High	5700	15.27	0.0337	17.15	30.00	24.00

Test mode: IEEE 802.11n HT 20 MHz mode / 5500 ~ 5720MHz

Channel	Frequency (MHz)	Chain 0 Output Power (dBm)	Chain 1 Output Power (dBm)	Total Maximum Conducted Output Power (dBm)	Maximum Output Power (W)	E.I.R.P Power (dBm)	IC E.I.R.P Limit (dBm)	FCC Limit (dBm)
Low	5500	15.55	15.6	19.10	0.0813	20.07	30.00	24.00
Mid	5580	15.72	15.75	19.26	0.0843	20.23	30.00	24.00
High	5700	15.9	15.72	*19.33	0.0857	20.31	30.00	24.00

Test mode: IEEE 802.11n HT 40 MHz mode / 5510 ~ 5670MHz

Channel	Frequency (MHz)	Chain 0 Output Power (dBm)	Chain 1 Output Power (dBm)	Total Maximum Conducted Output Power (dBm)	Maximum Output Power (W)	E.I.R.P Power (dBm)	IC E.I.R.P Limit (dBm)	FCC Limit (dBm)
Low	5510	13.93	13.9	*17.88	0.0614	18.85	30.00	24.00
Mid	5550	13.53	13.87	17.67	0.0585	18.64	30.00	24.00
High	5670	13.78	13.78	17.74	0.0594	18.72	30.00	24.00

Remark:

1. Total Output Power (w) = Chain 0 (10^(Output Power /10)/1000)+ Chain 1 (10^(Output Power /10)/1000)

7.4 BAND EDGES MEASUREMENT

LIMIT

According 15.407(5)(b) and RSS-247

Undesirable emission limits. Except as shown in paragraph (b)(7) of this section, the maximum emissions outside of the frequency bands of operation shall be attenuated in accordance with the following limits:

For transmitters operating in the 5.15-5.25 GHz band: All emissions outside of the 5.15-5.35 GHz band shall not exceed an e.i.r.p. of -27 dBm/MHz.

For transmitters operating in the 5.25-5.35 GHz band: All emissions outside of the 5.15-5.35 GHz band shall not exceed an e.i.r.p. of -27 dBm/MHz.

For transmitters operating in the 5.47-5.725 GHz band: All emissions outside of the 5.47-5.725 GHz band shall not exceed an e.i.r.p. of -27 dBm/MHz.

Test Configuration

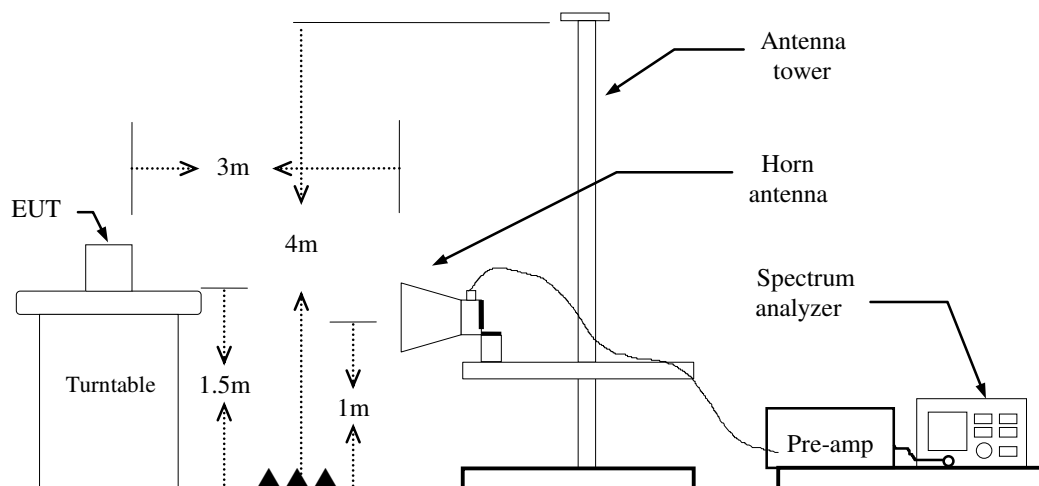

TEST PROCEDURE

1. The EUT is placed on a turntable, which is 1.5m above the ground plane.
2. The turntable shall be rotated for 360 degrees to determine the position of maximum emission level.
3. EUT is set 3m away from the receiving antenna, which is varied from 1m to 4m to find out the highest emission.
4. Set the spectrum analyzer in the following setting in order to capture the lower and upper band-edges of the emission:
 - (a) PEAK: RBW=VBW=1MHz / Sweep=AUTO
 - (b) AVERAGE: RBW=1MHz,
if duty cycle $\geq 98\%$, VBW=10Hz.
if duty cycle $< 98\%$ VBW=1/T.
IEEE 802.11a mode: =89%, VBW=750Hz
IEEE 802.11n HT 20 MHz mode: =88%, VBW=750Hz
IEEE 802.11n HT 40 MHz mode: =79%, VBW=1.5KHz
5. Repeat the procedures until all the PEAK and AVERAGE versus POLARIZATION are measured.
6. Result = Spectrum Reading + cable loss(spectrum to Amp) - Amp Gain + Cable loss(Amp to receive Ant)+ Receive Ant

Duty Cycle:

IEEE 802.11a mode:

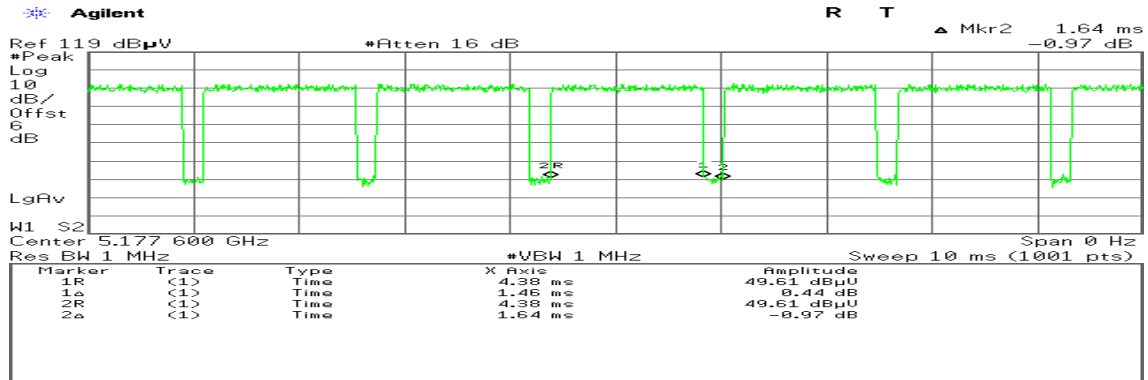

IEEE 802.11n HT 20 MHz mode:

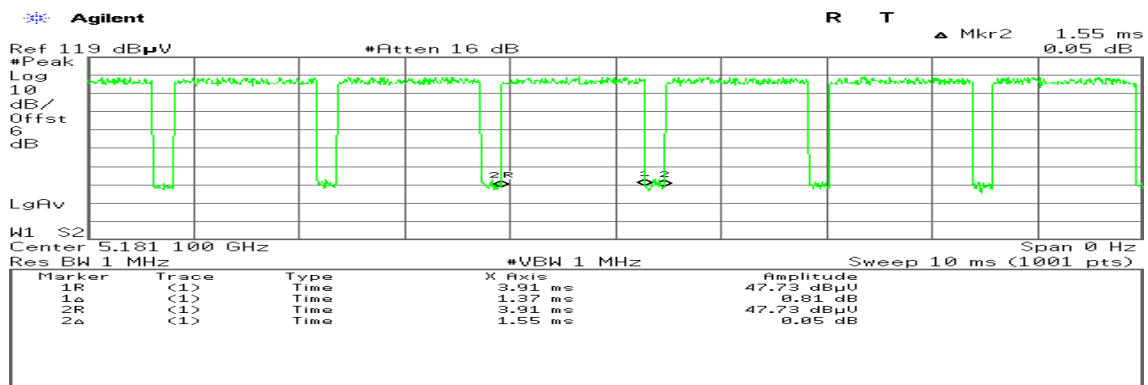

IEEE 802.11n HT 40 MHz mode:

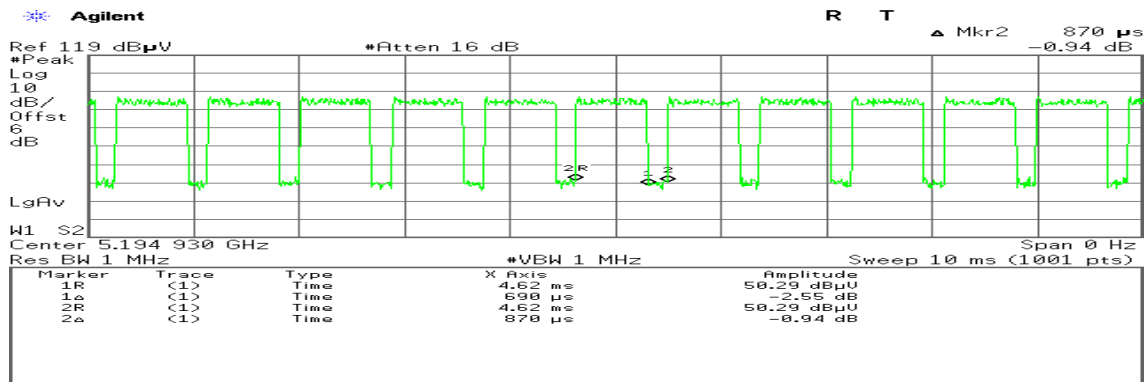

TEST RESULTS

Refer to attach spectrum analyzer data chart.

U-NII-1

IEEE 802.11a Mode / CH Low

Detector mode: Peak

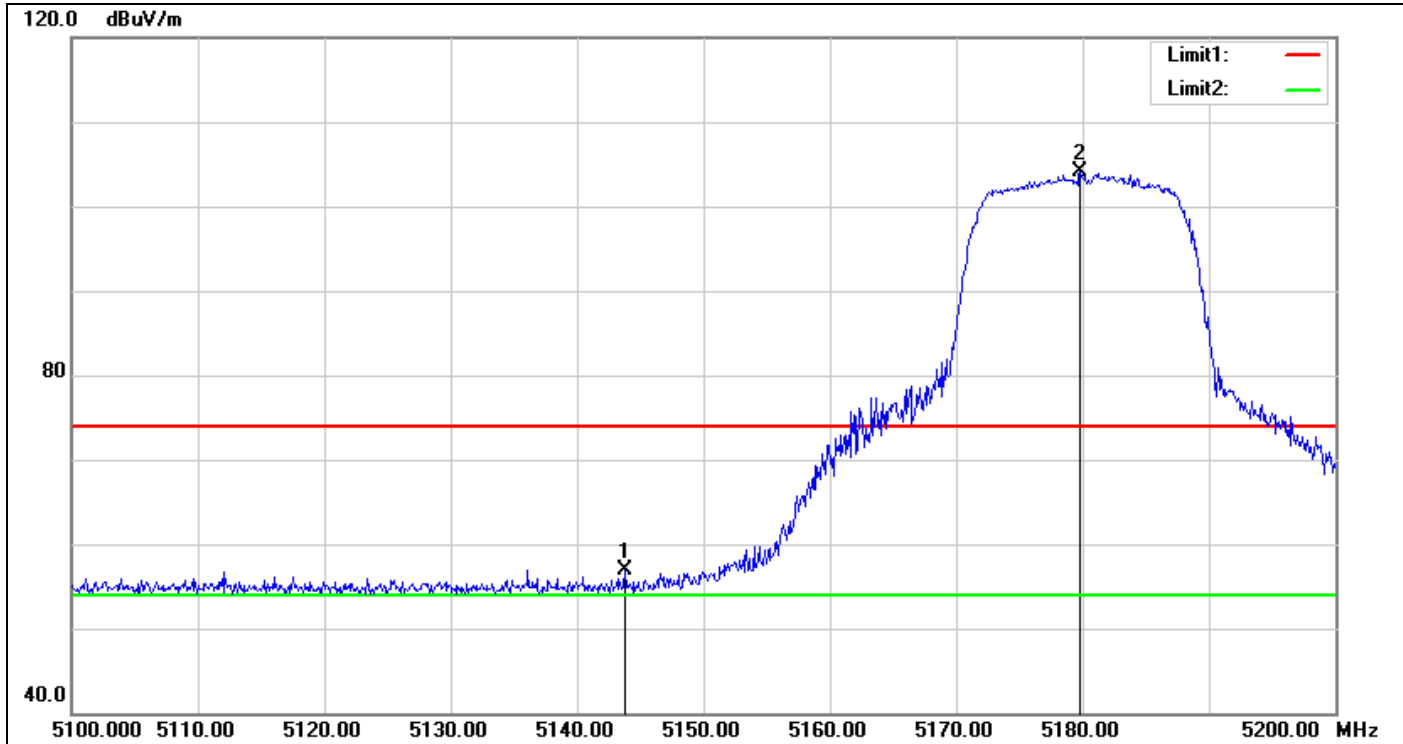

No.	Frequency (MHz)	Reading (dBuV)	Correct Factor(dB/m)	Result (dBuV/m)	Limit (dBuV/m)	Margin (dB)	Remark
1	5143.800	51.98	4.91	56.89	74.00	-17.11	peak
2	5179.800	99.14	4.98	104.12	-	-	peak

Detector mode: Average

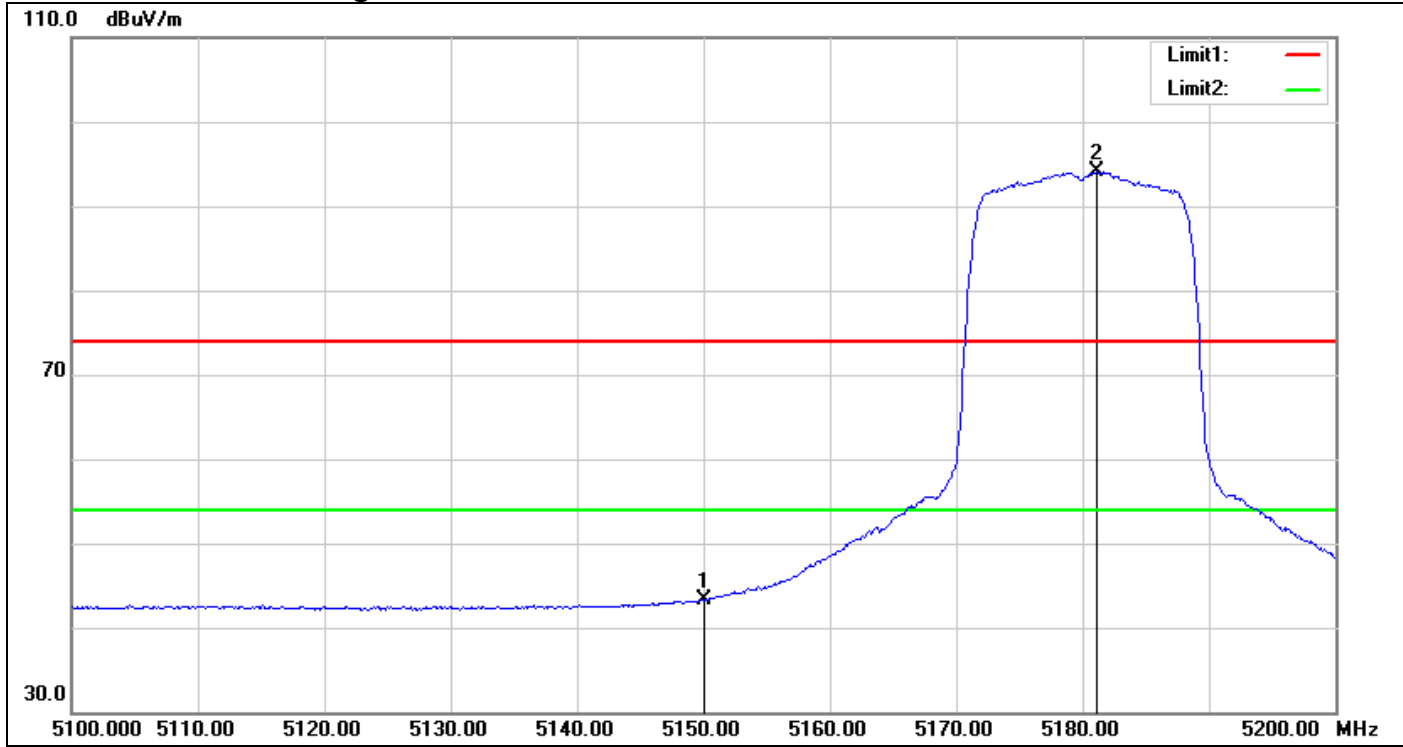

No.	Frequency (MHz)	Reading (dBuV)	Correct Factor(dB/m)	Result (dBuV/m)	Limit (dBuV/m)	Margin (dB)	Remark
1	5150.000	38.38	4.92	43.30	54.00	-10.70	AVG
2	5181.100	89.03	4.98	94.01	-	-	AVG

IEEE 802.11a Mode / CH Mid

Detector mode: Peak

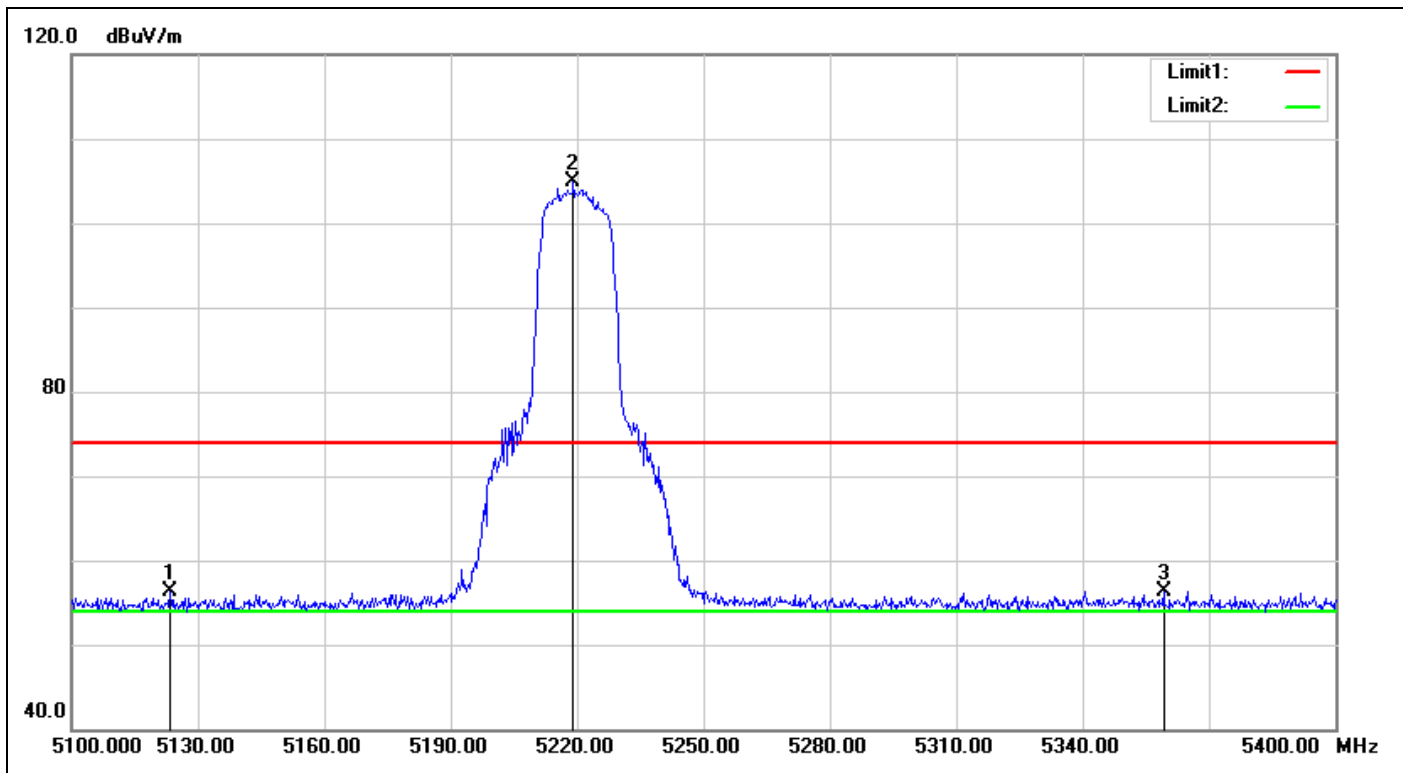

No.	Frequency (MHz)	Reading (dBuV)	Correct Factor(dB/m)	Result (dBuV/m)	Limit (dBuV/m)	Margin (dB)	Remark
1	5123.400	51.48	4.88	56.36	74.00	-17.64	peak
2	5219.100	99.82	5.06	104.88	-	-	peak
3	5359.200	50.75	5.51	56.26	74.00	-17.74	peak

Detector mode: Average

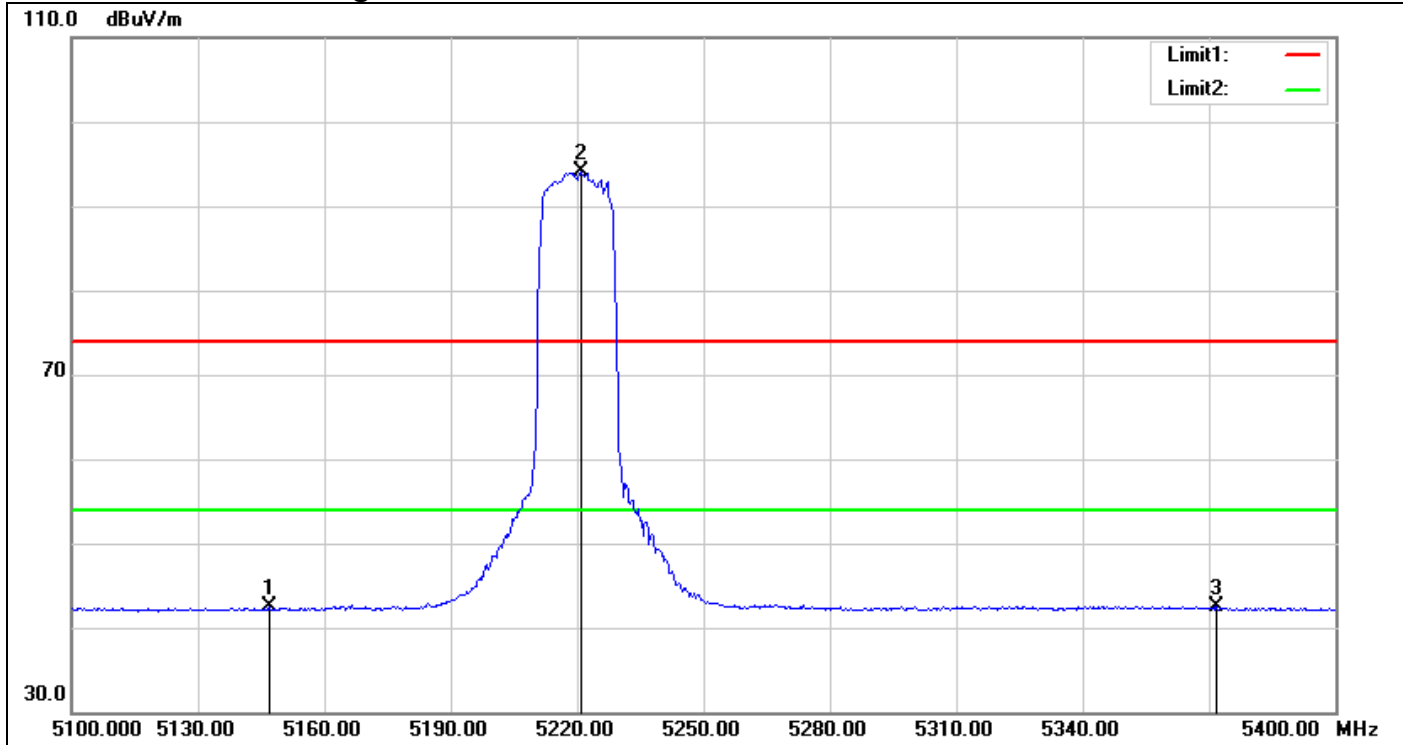

No.	Frequency (MHz)	Reading (dBuV)	Correct Factor(dB/m)	Result (dBuV/m)	Limit (dBuV/m)	Margin (dB)	Remark
1	5146.800	37.49	4.92	42.41	54.00	-11.59	AVG
2	5220.900	89.01	5.07	94.08	-	-	AVG
3	5371.800	37.03	5.49	42.52	54.00	-11.48	AVG

IEEE 802.11a Mode / CH High

Detector mode: Peak

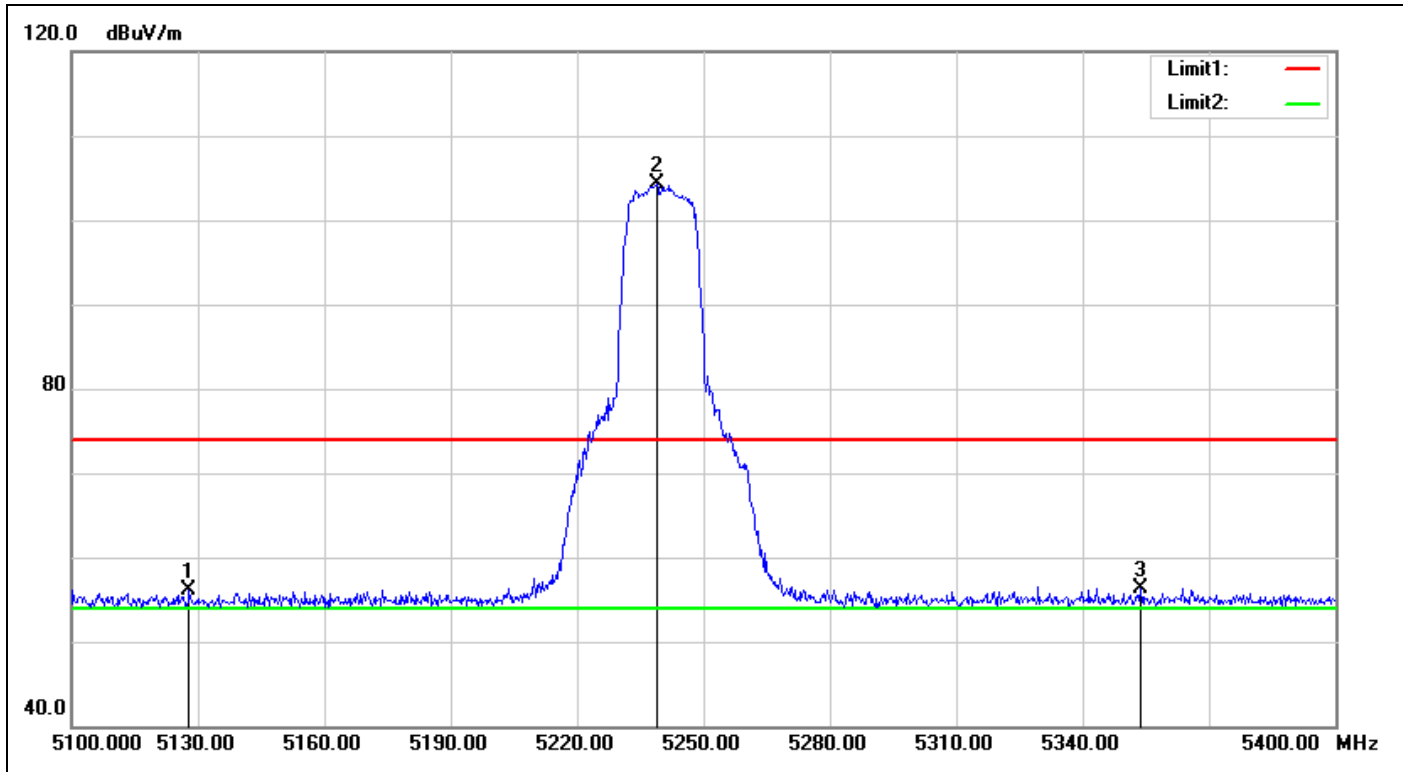

No.	Frequency (MHz)	Reading (dBuV)	Correct Factor(dB/m)	Result (dBuV/m)	Limit (dBuV/m)	Margin (dB)	Remark
1	5127.900	51.30	4.89	56.19	74.00	-17.81	peak
2	5238.900	99.16	5.11	104.27	-	-	peak
3	5353.800	50.80	5.51	56.31	74.00	-17.69	peak

Detector mode: Average

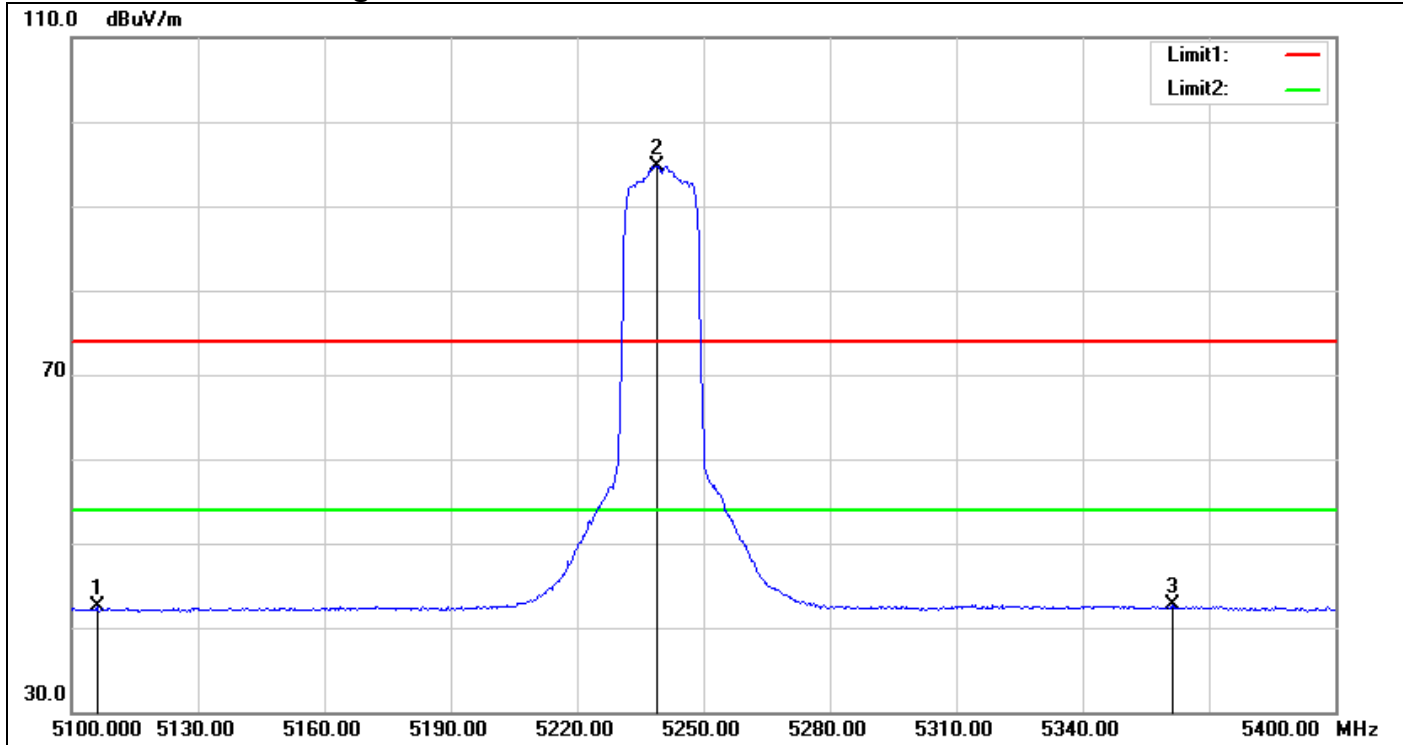

No.	Frequency (MHz)	Reading (dBuV)	Correct Factor(dB/m)	Result (dBuV/m)	Limit (dBuV/m)	Margin (dB)	Remark
1	5106.000	37.57	4.86	42.43	54.00	-11.57	AVG
2	5238.900	89.67	5.11	94.78	-	-	AVG
3	5361.300	37.13	5.50	42.63	54.00	-11.37	AVG

IEEE 802.11n HT 20 MHz Mode / CH Low

Detector mode: Peak

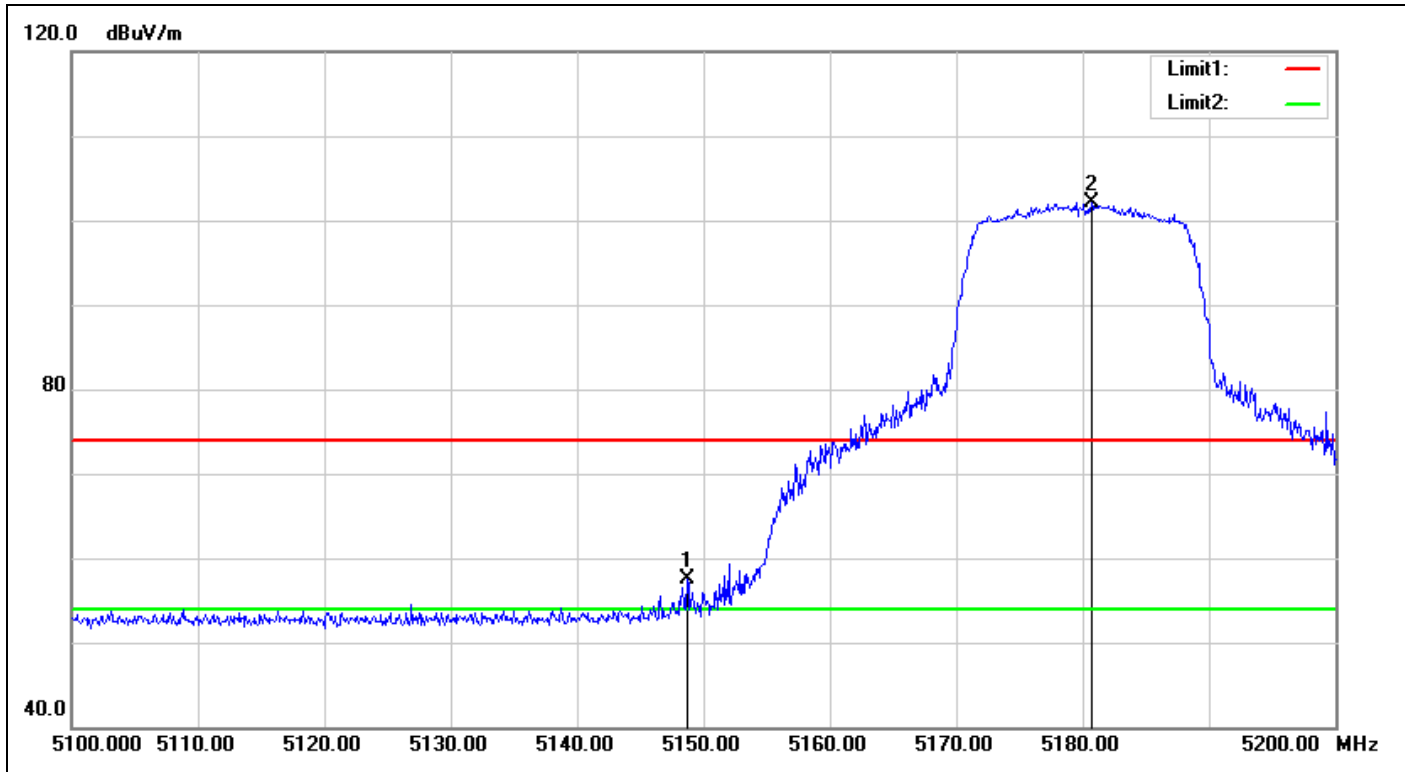

No.	Frequency (MHz)	Reading (dBuV)	Correct Factor(dB/m)	Result (dBuV/m)	Limit (dBuV/m)	Margin (dB)	Remark
1	5148.700	54.53	3.03	57.56	74.00	-16.44	peak
2	5180.700	98.22	3.93	102.15	-	-	peak

Detector mode: Average

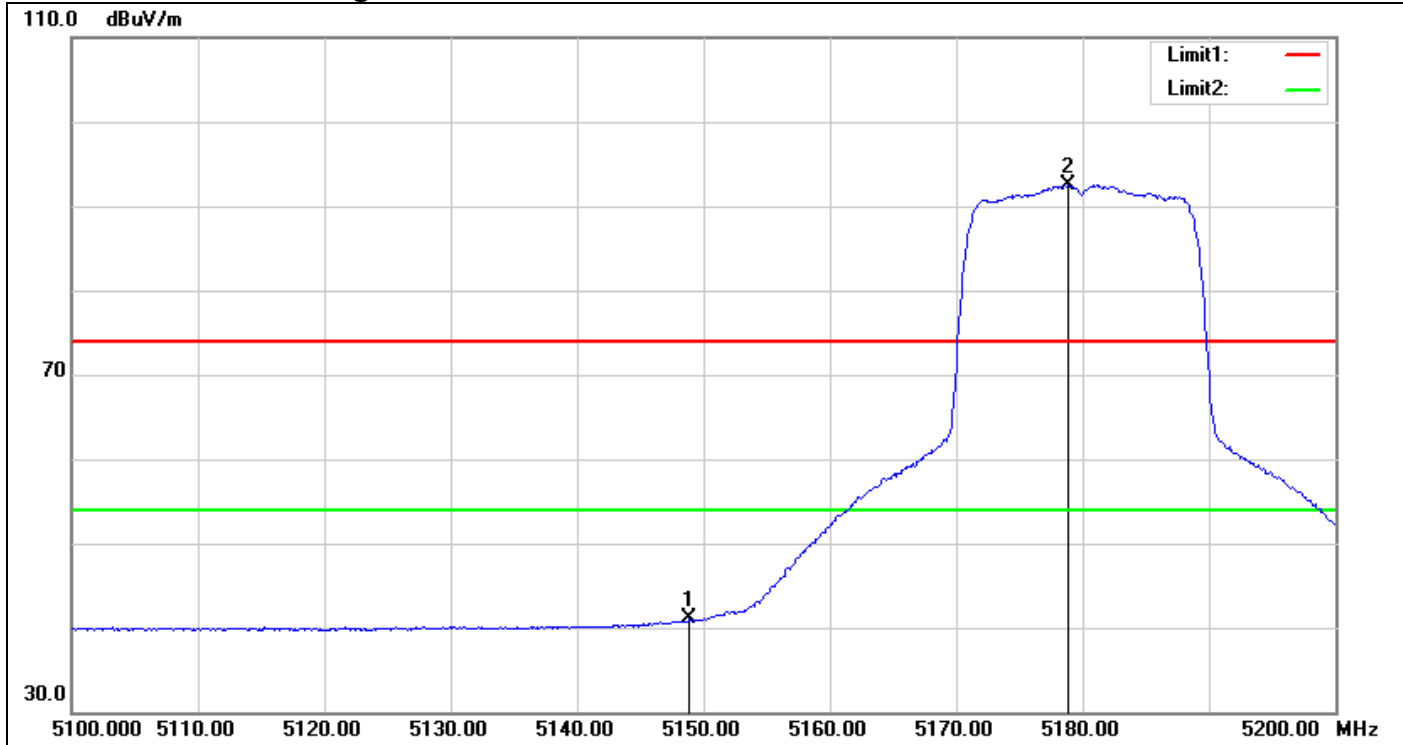

No.	Frequency (MHz)	Reading (dBuV)	Correct Factor(dB/m)	Result (dBuV/m)	Limit (dBuV/m)	Margin (dB)	Remark
1	5148.900	37.99	3.03	41.02	54.00	-12.98	AVG
2	5178.900	88.69	3.88	92.57	-	-	AVG

IEEE 802.11n HT 20 MHz Mode / CH Mid

Detector mode: Peak

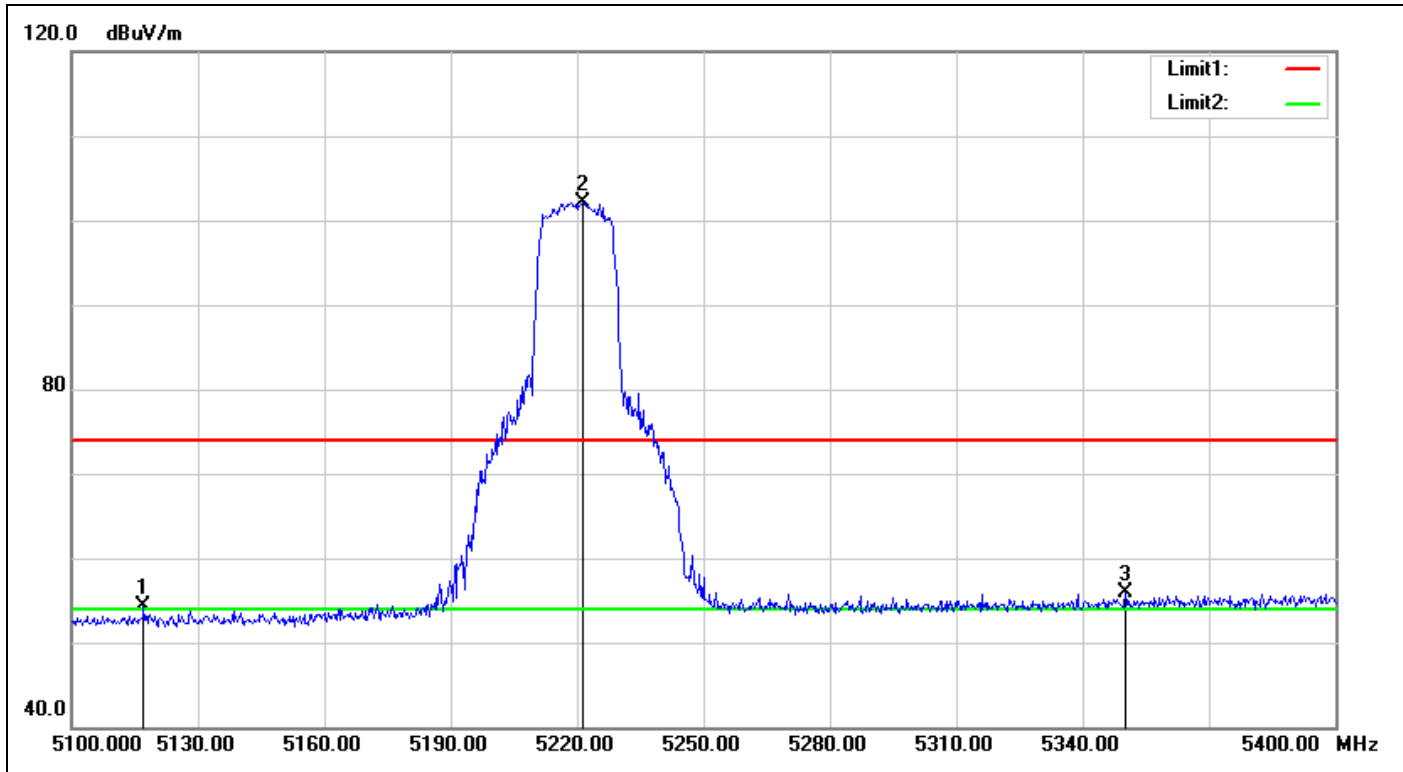

No.	Frequency (MHz)	Reading (dBuV)	Correct Factor(dB/m)	Result (dBuV/m)	Limit (dBuV/m)	Margin (dB)	Remark
1	5117.100	51.56	2.82	54.38	74.00	-19.62	peak
2	5221.200	97.62	4.56	102.18	-	-	peak
3	5350.200	50.57	5.31	55.88	74.00	-18.12	peak

Detector mode: Average

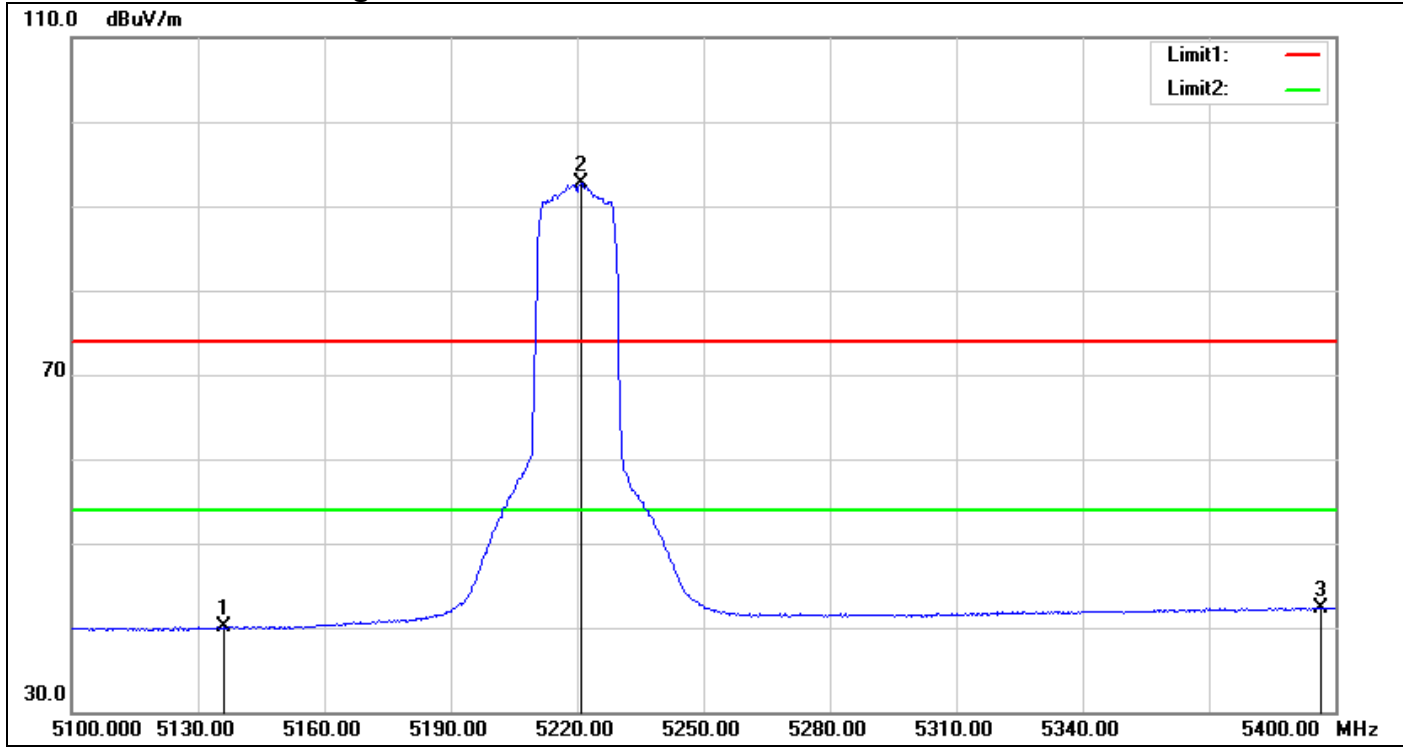

No.	Frequency (MHz)	Reading (dBuV)	Correct Factor(dB/m)	Result (dBuV/m)	Limit (dBuV/m)	Margin (dB)	Remark
1	5136.300	37.20	2.95	40.15	54.00	-13.85	AVG
2	5220.900	88.07	4.56	92.63	-	-	AVG
3	5396.400	36.70	5.69	42.39	54.00	-11.61	AVG

IEEE 802.11n HT 20 MHz Mode / CH High

Detector mode: Peak

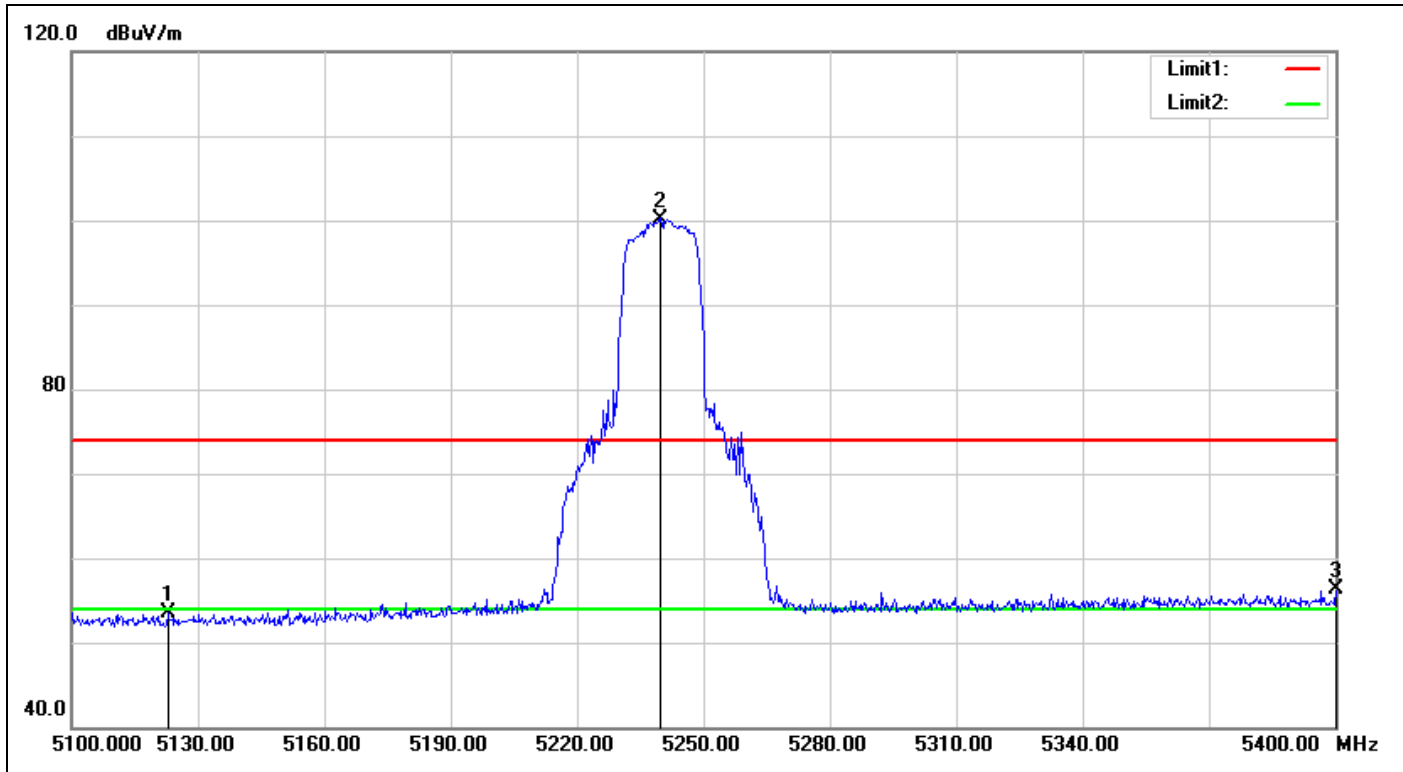

No.	Frequency (MHz)	Reading (dBuV)	Correct Factor(dB/m)	Result (dBuV/m)	Limit (dBuV/m)	Margin (dB)	Remark
1	5122.800	50.70	2.86	53.56	74.00	-20.44	peak
2	5239.800	95.57	4.63	100.20	-	-	peak
3	5400.000	50.55	5.72	56.27	74.00	-17.73	peak

Detector mode: Average

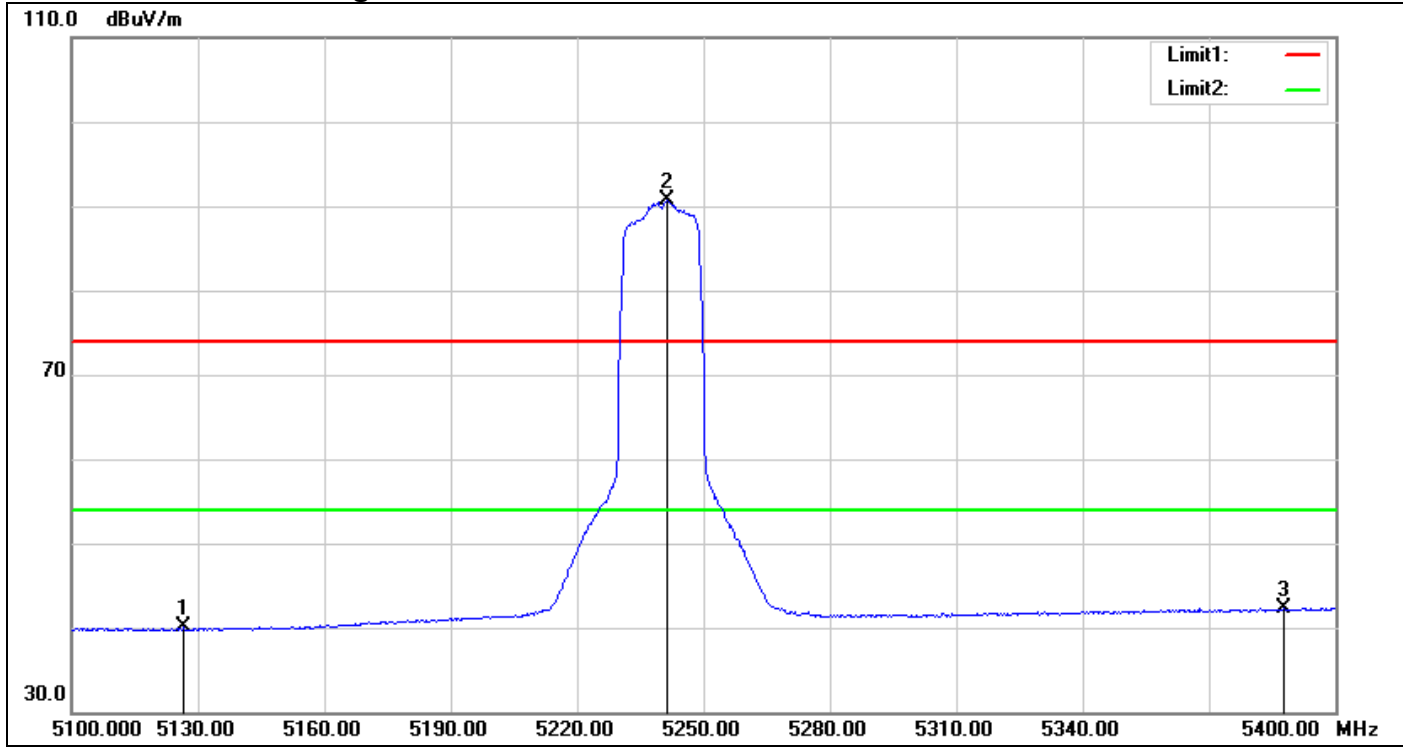

No.	Frequency (MHz)	Reading (dBuV)	Correct Factor(dB/m)	Result (dBuV/m)	Limit (dBuV/m)	Margin (dB)	Remark
1	5126.700	37.14	2.88	40.02	54.00	-13.98	AVG
2	5241.300	85.99	4.63	90.62	-	-	AVG
3	5387.700	36.71	5.62	42.33	54.00	-11.67	AVG

IEEE 802.11n HT 40 MHz Mode / CH Low

Detector mode: Peak

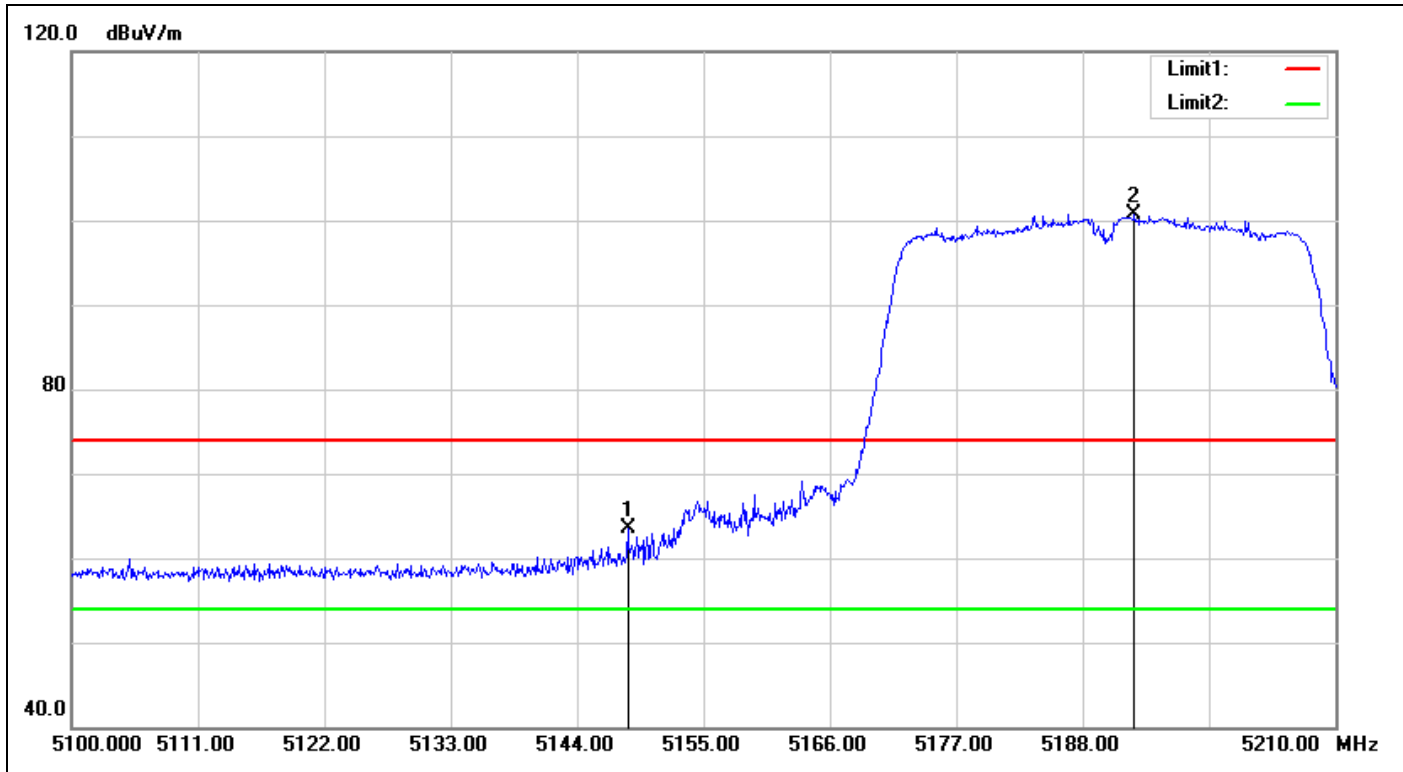

No.	Frequency (MHz)	Reading (dBuV)	Correct Factor(dB/m)	Result (dBuV/m)	Limit (dBuV/m)	Margin (dB)	Remark
1	5148.400	60.41	3.03	63.44	74.00	-10.56	peak
2	5192.510	96.41	4.27	100.68	-	-	peak

Detector mode: Average

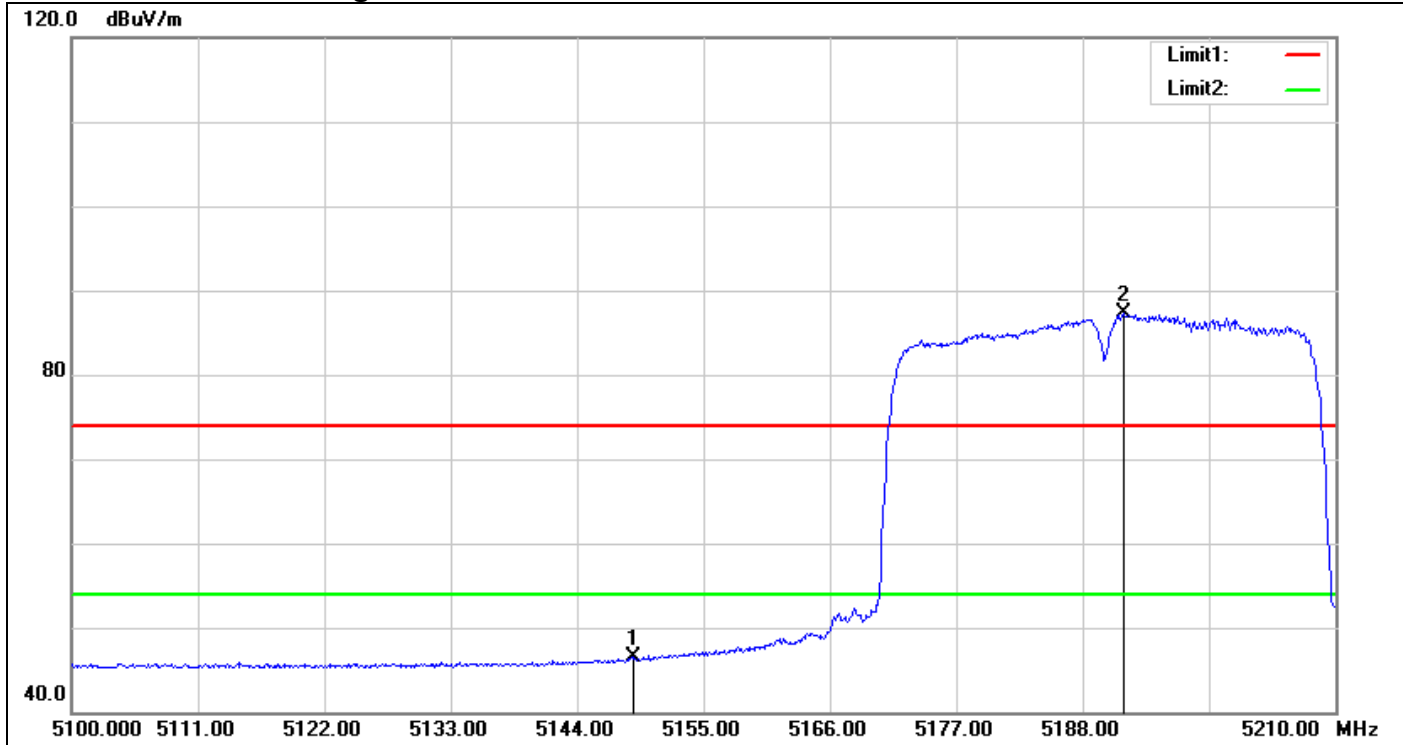

No.	Frequency (MHz)	Reading (dBuV)	Correct Factor(dB/m)	Result (dBuV/m)	Limit (dBuV/m)	Margin (dB)	Remark
1	5148.840	43.42	3.03	46.45	54.00	-7.55	AVG
2	5191.630	83.08	4.25	87.33	-	-	AVG

IEEE 802.11n HT 40 MHz Mode / CH High

Detector mode: Peak

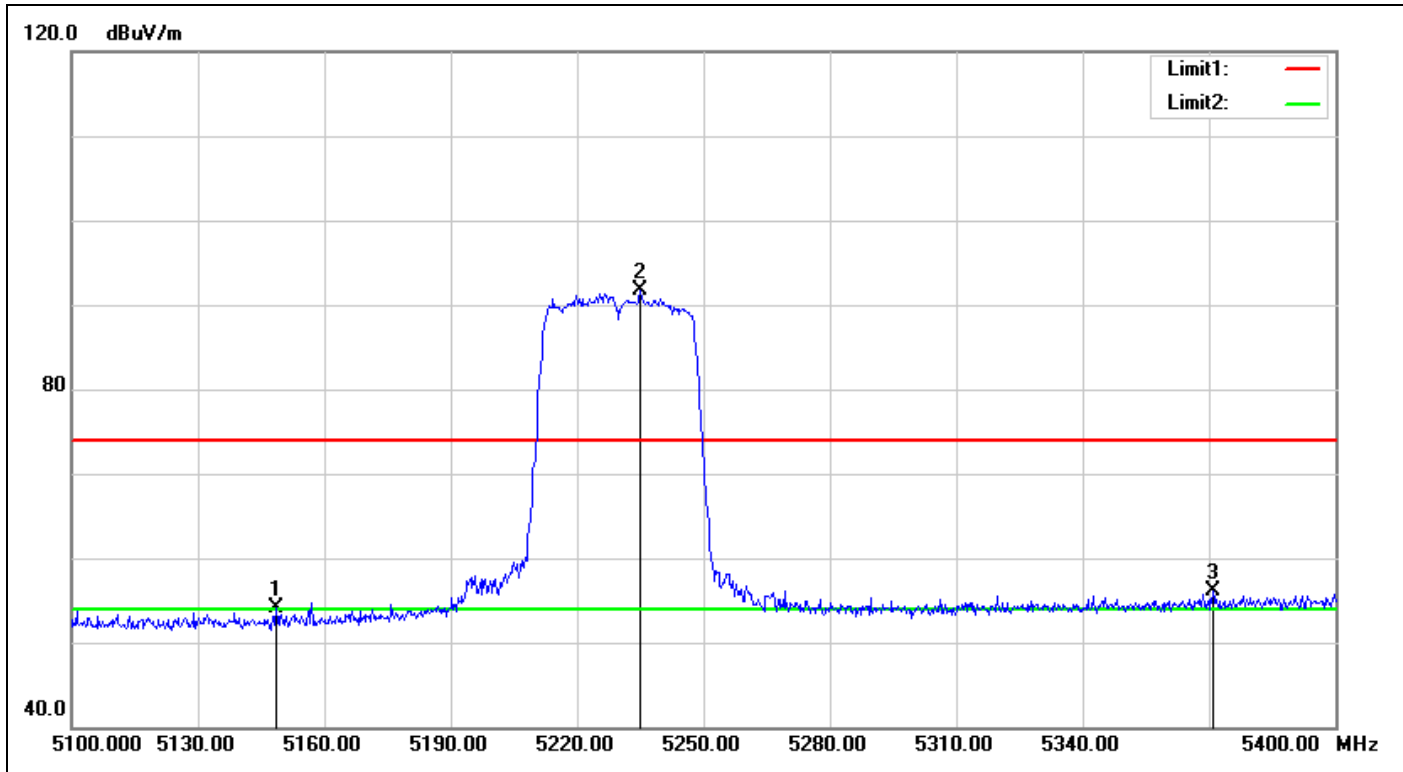

No.	Frequency (MHz)	Reading (dBuV)	Correct Factor(dB/m)	Result (dBuV/m)	Limit (dBuV/m)	Margin (dB)	Remark
1	5148.600	51.02	3.03	54.05	74.00	-19.95	peak
2	5235.000	87.09	4.61	91.70	-	-	peak
3	5370.900	50.66	5.48	56.14	74.00	-17.86	peak

Detector mode: Average

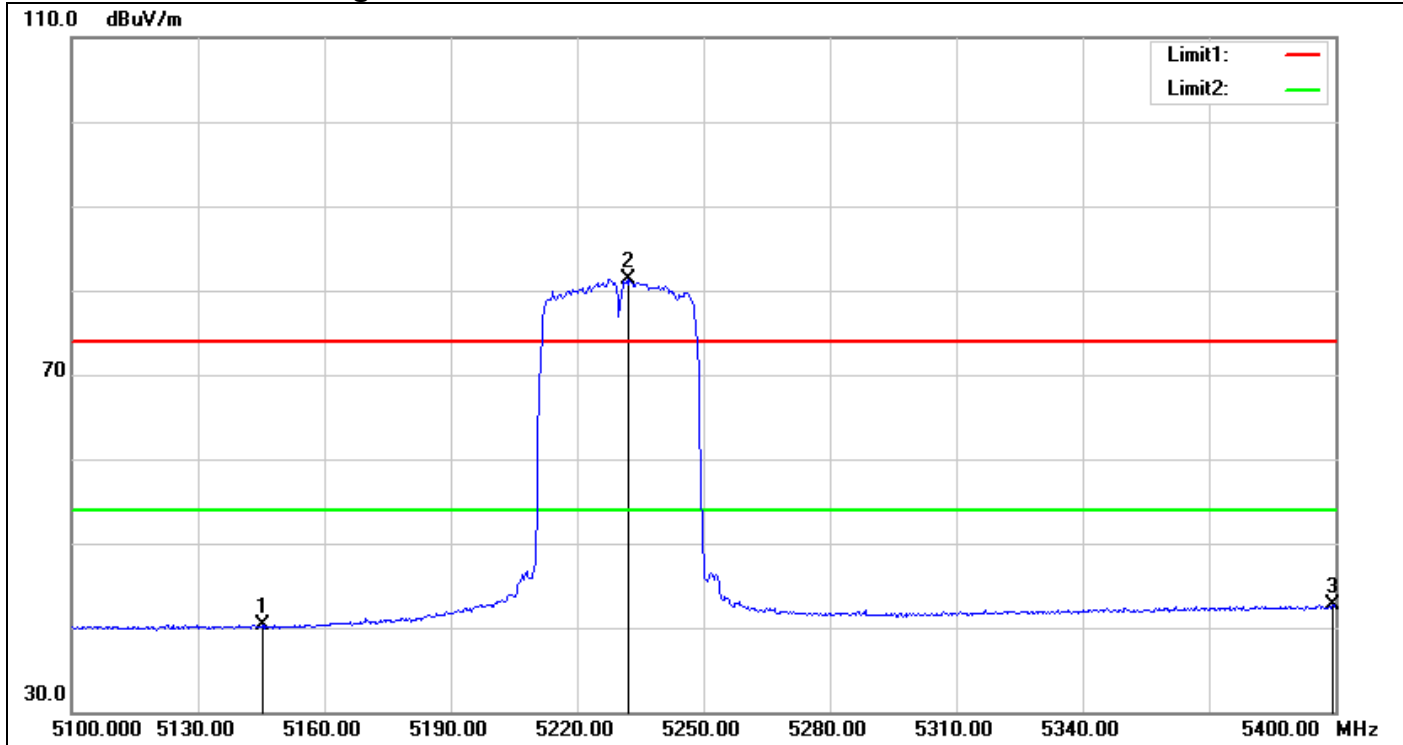

No.	Frequency (MHz)	Reading (dBuV)	Correct Factor(dB/m)	Result (dBuV/m)	Limit (dBuV/m)	Margin (dB)	Remark
1	5145.300	37.37	3.01	40.38	54.00	-13.62	AVG
2	5232.300	76.72	4.60	81.32	-	-	AVG
3	5399.400	37.07	5.72	42.79	54.00	-11.21	AVG

U-NII-2A

IEEE 802.11a Mode / CH Low

Detector mode: Peak

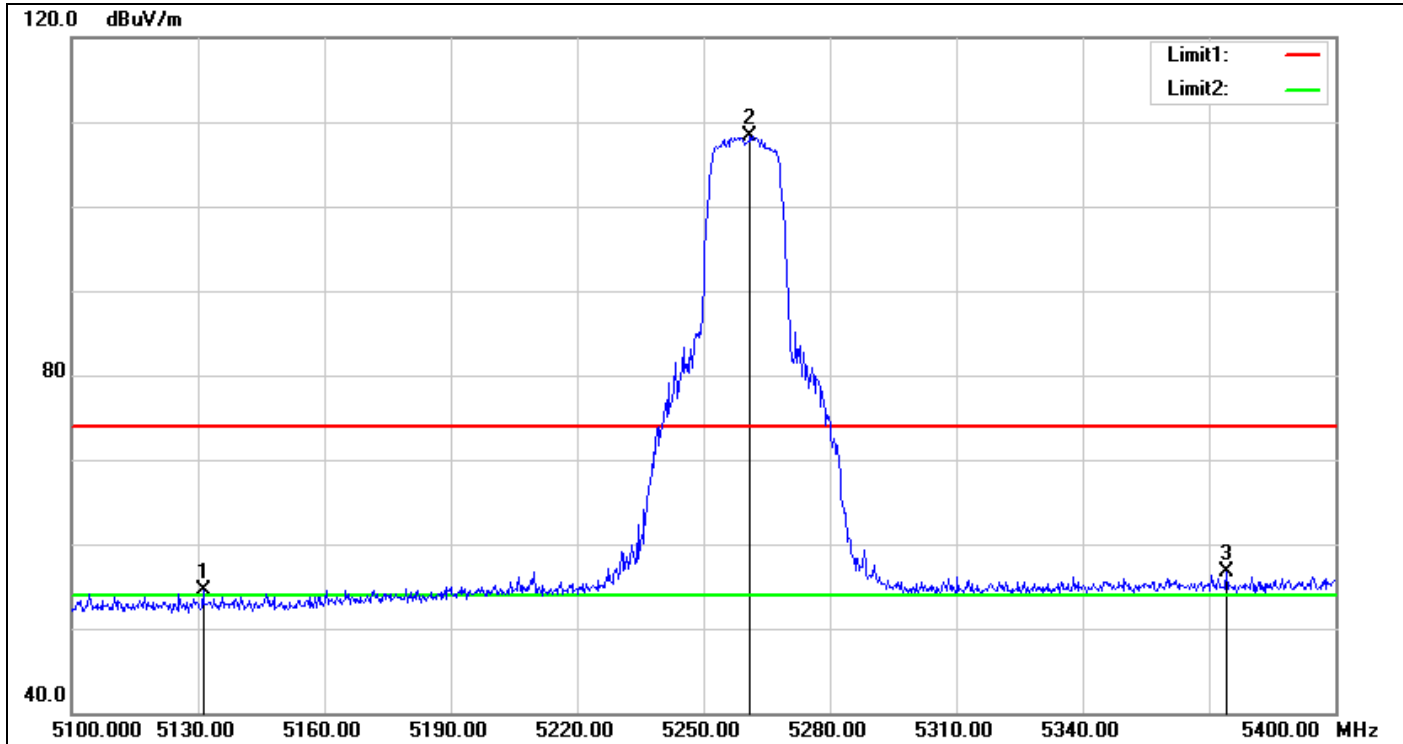

No.	Frequency (MHz)	Reading (dBuV)	Correct Factor(dB/m)	Result (dBuV/m)	Limit (dBuV/m)	Margin (dB)	Remark
1	5131.200	51.55	2.91	54.46	74.00	-19.54	peak
2	5261.100	103.53	4.70	108.23	-	-	peak
3	5374.200	51.22	5.51	56.73	74.00	-17.27	peak

Detector mode: Average

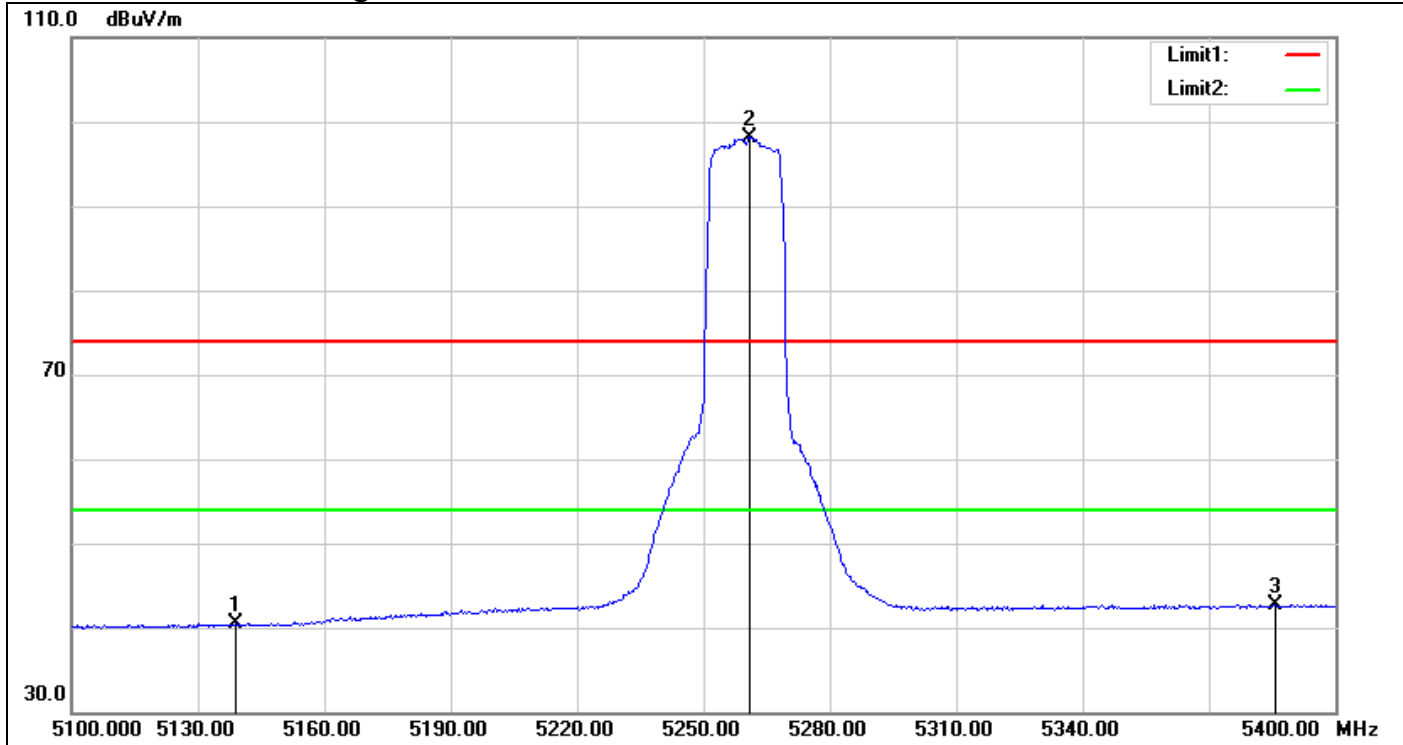

No.	Frequency (MHz)	Reading (dBuV)	Correct Factor(dB/m)	Result (dBuV/m)	Limit (dBuV/m)	Margin (dB)	Remark
1	5139.000	37.61	2.97	40.58	54.00	-13.42	AVG
2	5260.800	93.50	4.70	98.20	-	-	AVG
3	5385.900	37.17	5.60	42.77	54.00	-11.23	AVG

IEEE 802.11a Mode / CH Mid

Detector mode: Peak

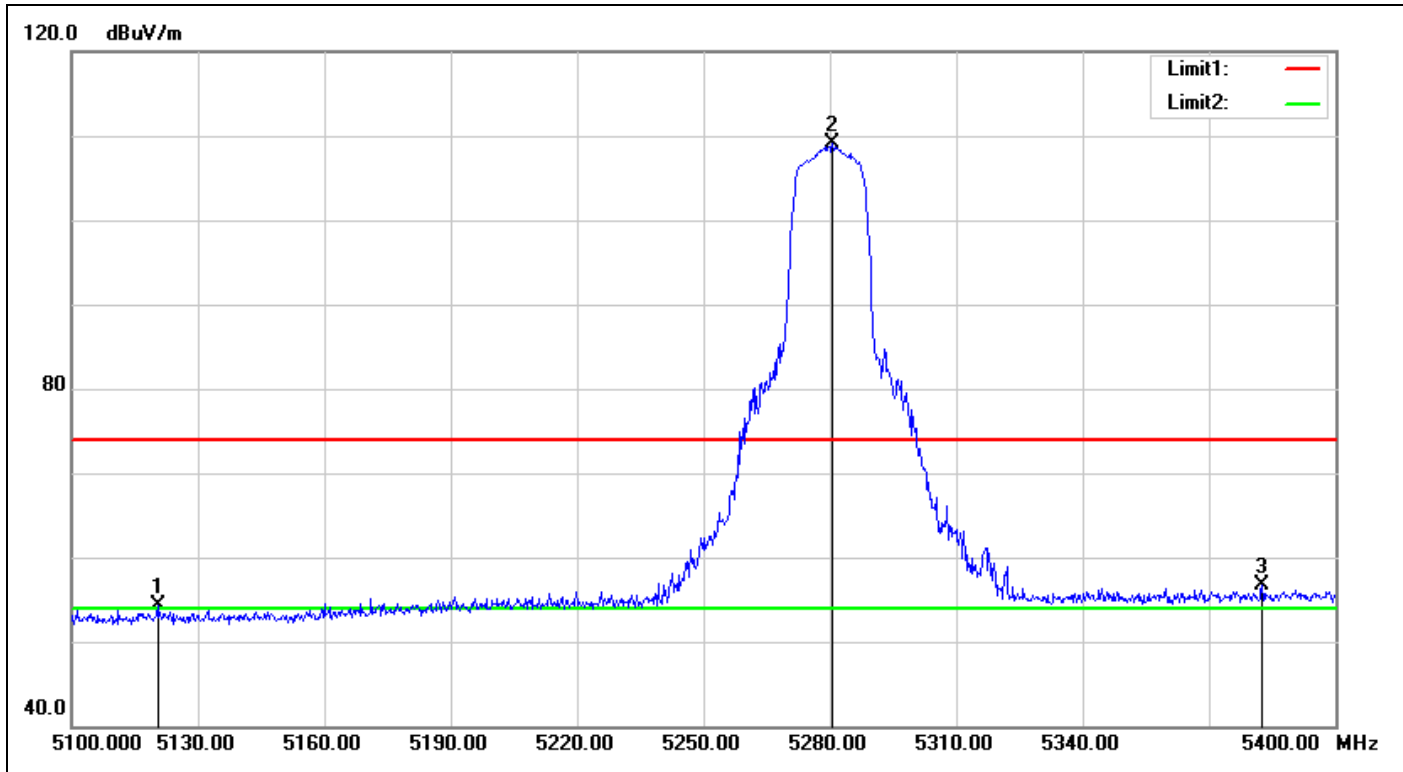

No.	Frequency (MHz)	Reading (dBuV)	Correct Factor(dB/m)	Result (dBuV/m)	Limit (dBuV/m)	Margin (dB)	Remark
1	5120.400	51.43	2.84	54.27	74.00	-19.73	peak
2	5280.600	104.41	4.76	109.17	-	-	peak
3	5382.600	51.04	5.58	56.62	74.00	-17.38	peak

Detector mode: Average

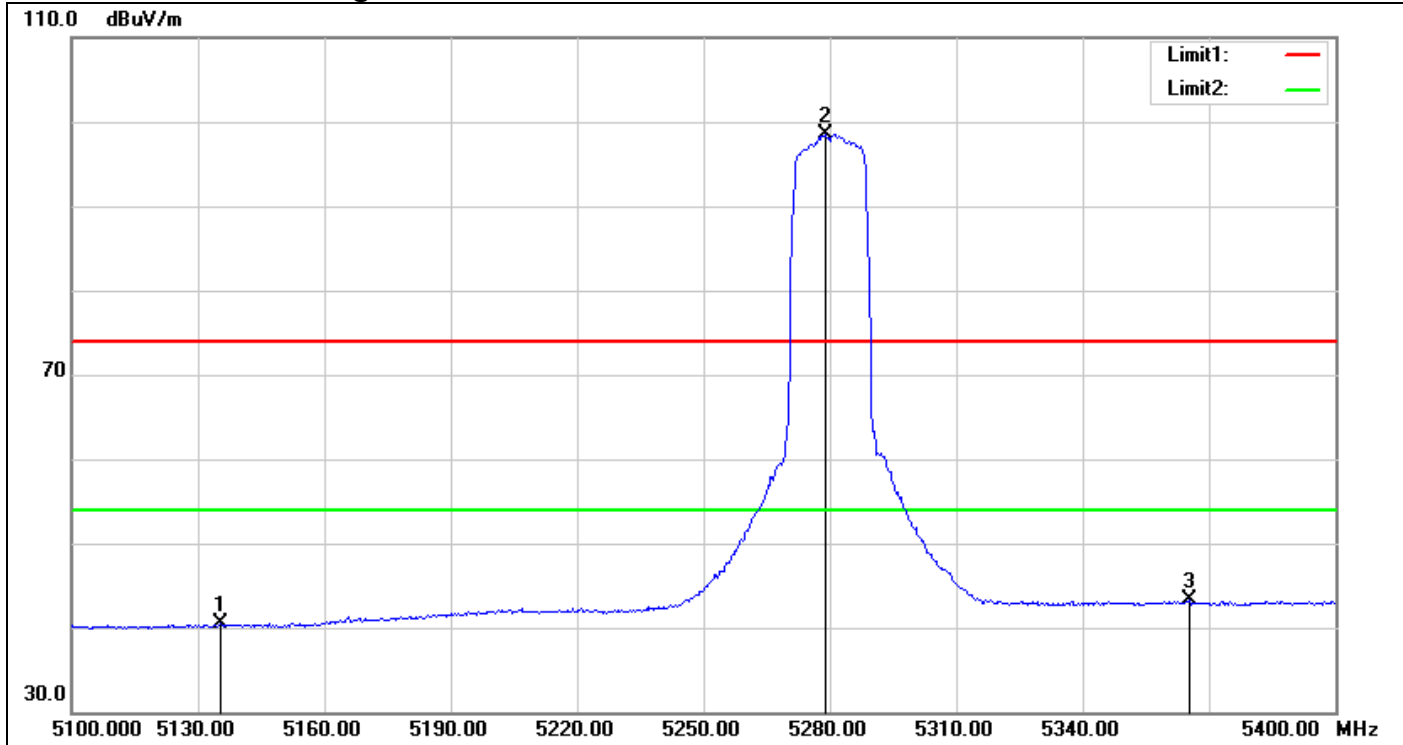

No.	Frequency (MHz)	Reading (dBuV)	Correct Factor(dB/m)	Result (dBuV/m)	Limit (dBuV/m)	Margin (dB)	Remark
1	5135.400	37.50	2.94	40.44	54.00	-13.56	AVG
2	5279.100	93.73	4.76	98.49	-	-	AVG
3	5365.200	37.86	5.43	43.29	54.00	-10.71	AVG

IEEE 802.11a Mode / CH High

Detector mode: Peak

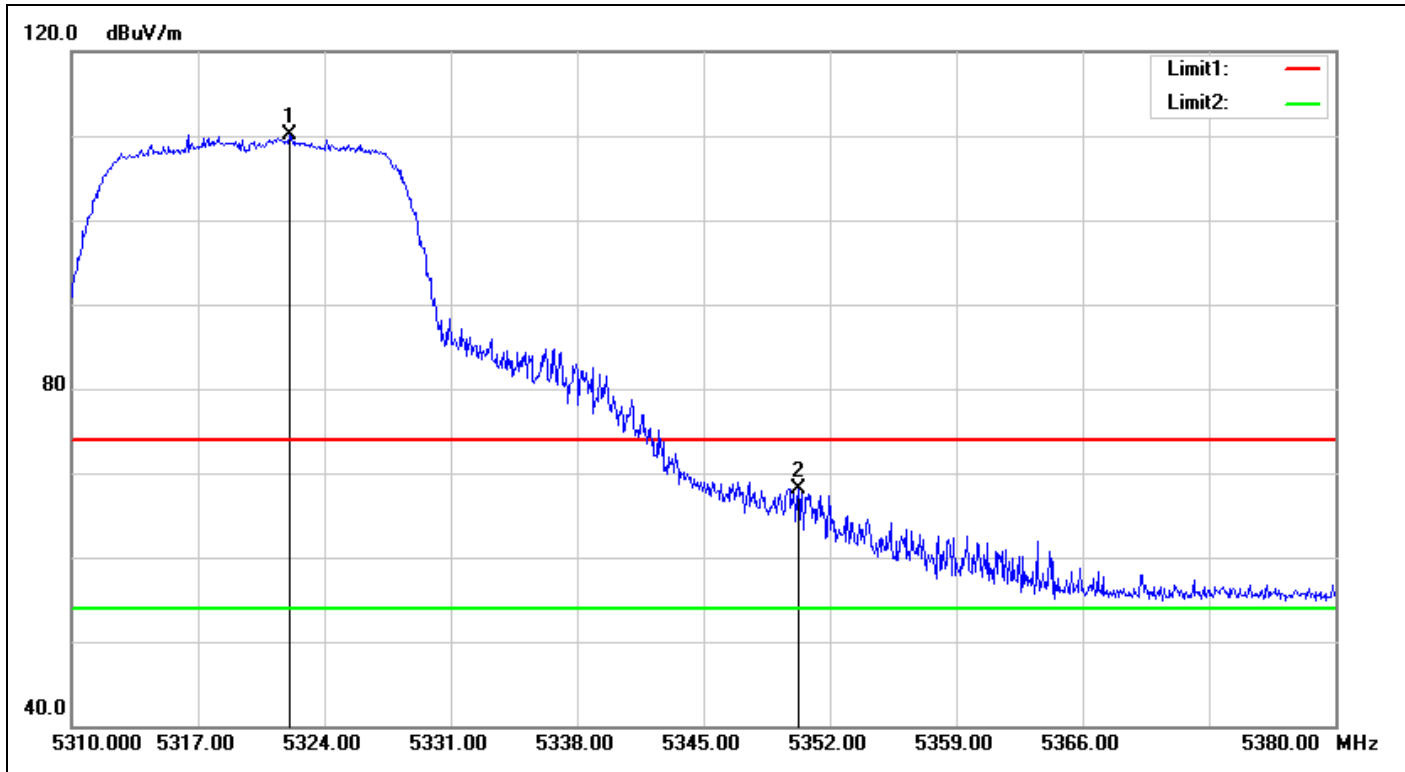

No.	Frequency (MHz)	Reading (dBuV)	Correct Factor(dB/m)	Result (dBuV/m)	Limit (dBuV/m)	Margin (dB)	Remark
1	5322.040	105.15	5.04	110.19	-	-	peak
2	5350.250	62.89	5.31	68.20	74.00	-5.80	peak

Detector mode: Average

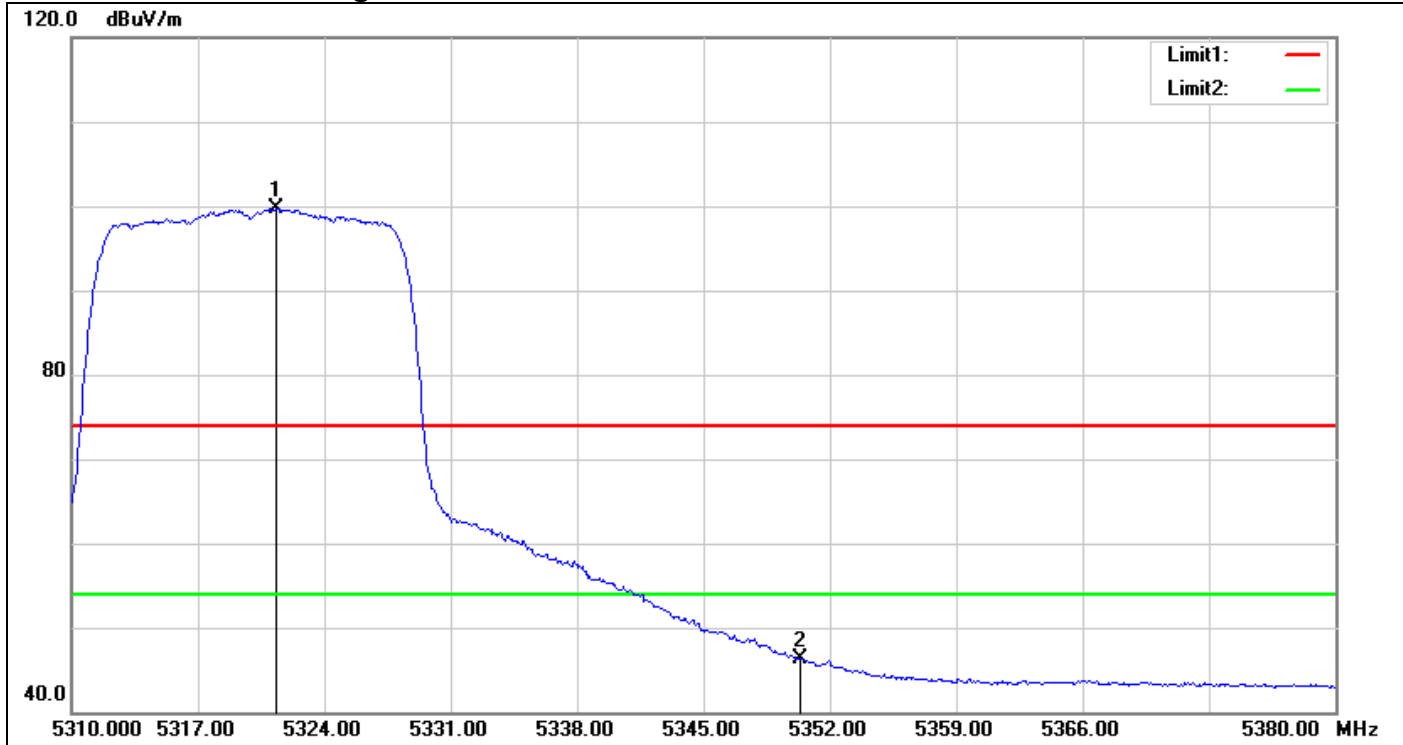

No.	Frequency (MHz)	Reading (dBuV)	Correct Factor(dB/m)	Result (dBuV/m)	Limit (dBuV/m)	Margin (dB)	Remark
1	5321.340	94.61	5.03	99.64	-	-	AVG
2	5350.320	41.07	5.31	46.38	54.00	-7.62	AVG

IEEE 802.11n HT 20 MHz Mode / CH Low

Detector mode: Peak

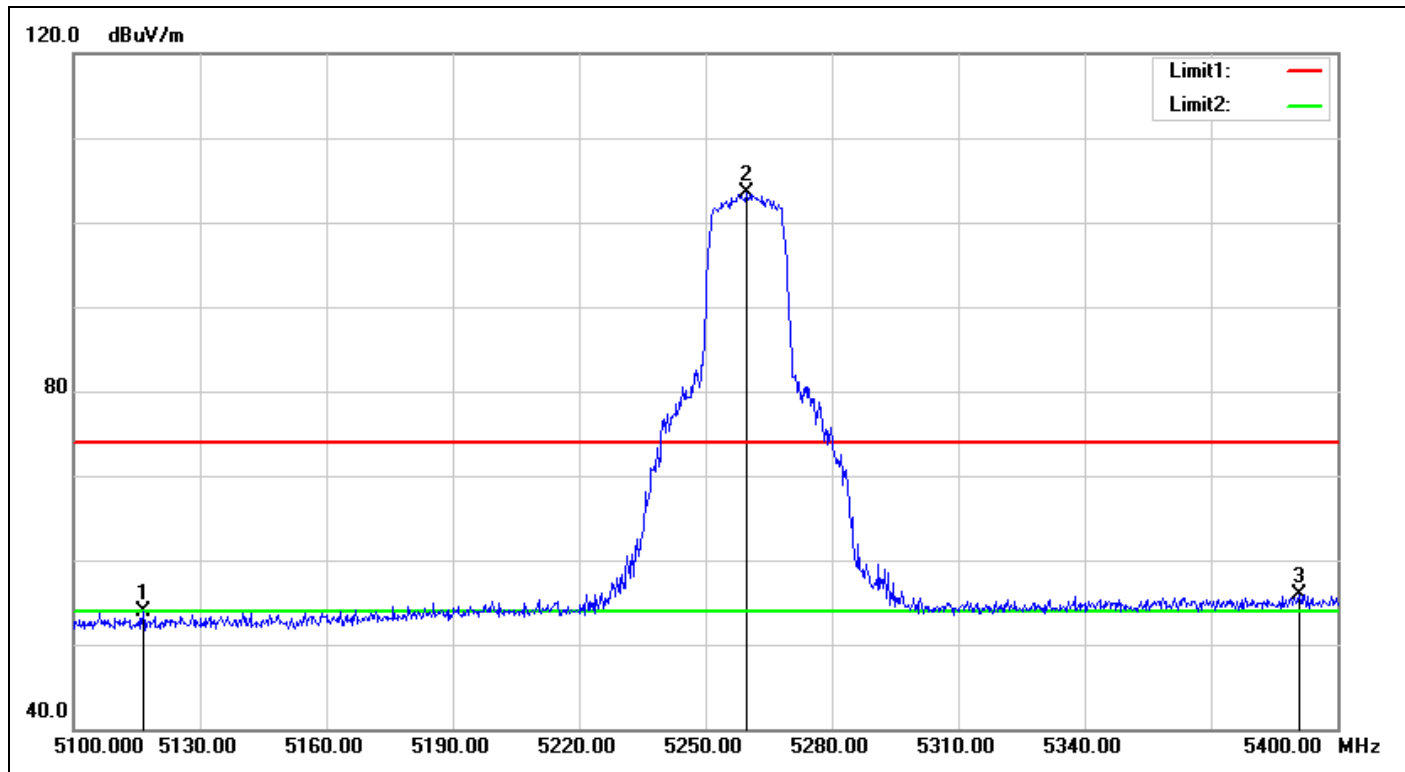

No.	Frequency (MHz)	Reading (dBuV)	Correct Factor(dB/m)	Result (dBuV/m)	Limit (dBuV/m)	Margin (dB)	Remark
1	5116.500	51.08	2.81	53.89	74.00	-20.11	peak
2	5259.600	98.84	4.69	103.53	-	-	peak
3	5391.000	50.31	5.65	55.96	74.00	-18.04	peak

Detector mode: Average

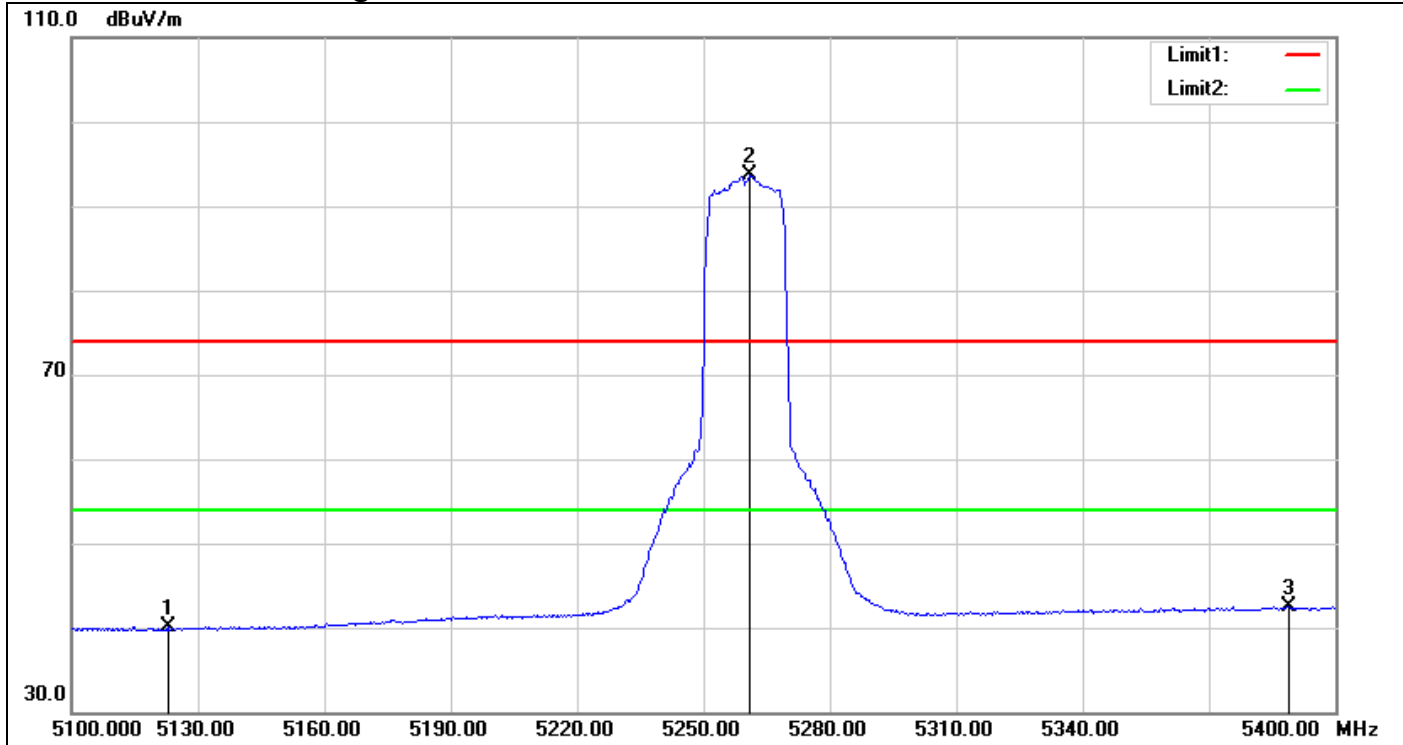

No.	Frequency (MHz)	Reading (dBuV)	Correct Factor(dB/m)	Result (dBuV/m)	Limit (dBuV/m)	Margin (dB)	Remark
1	5122.800	37.23	2.86	40.09	54.00	-13.91	AVG
2	5261.100	88.95	4.70	93.65	-	-	AVG
3	5388.900	36.85	5.63	42.48	54.00	-11.52	AVG

IEEE 802.11n HT 20 MHz Mode / CH Mid

Detector mode: Peak

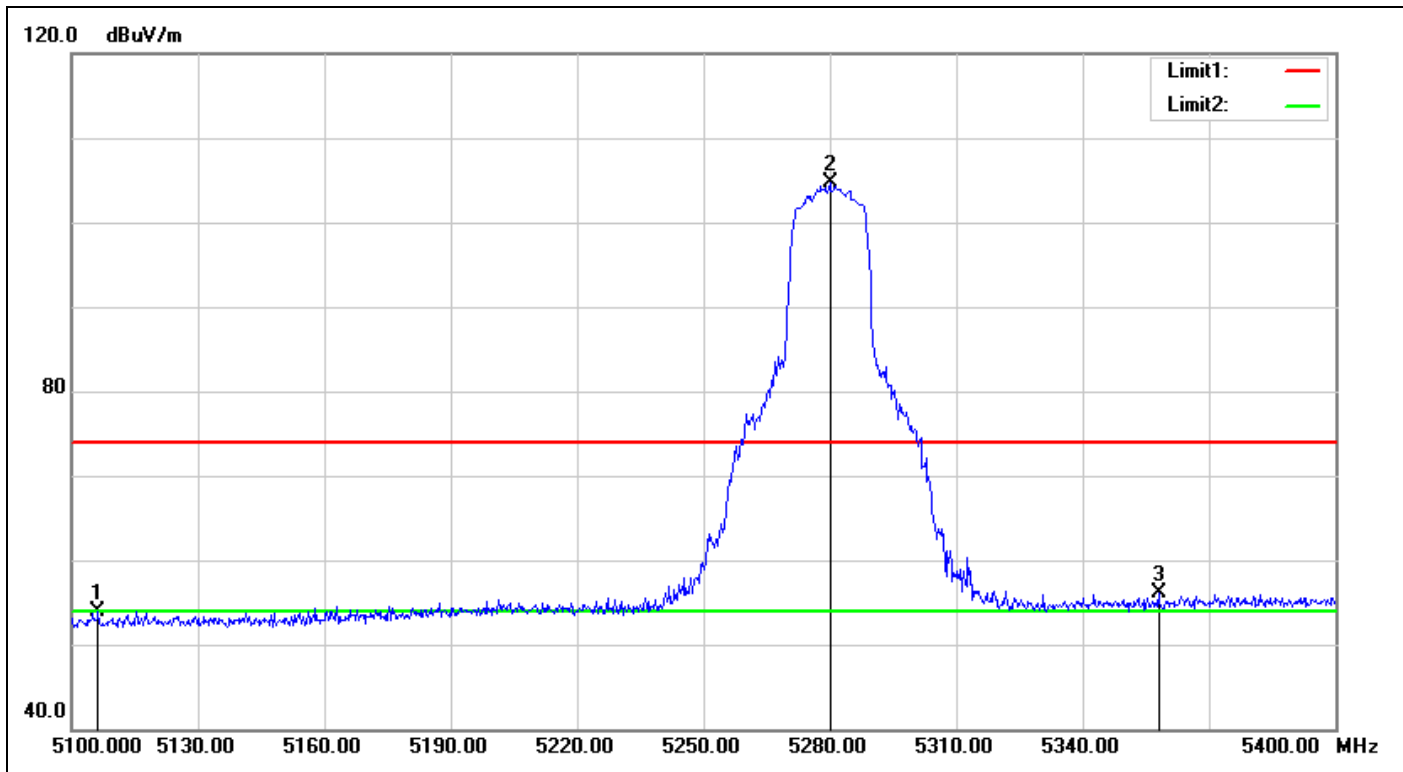

No.	Frequency (MHz)	Reading (dBuV)	Correct Factor(dB/m)	Result (dBuV/m)	Limit (dBuV/m)	Margin (dB)	Remark
1	5106.300	51.24	2.74	53.98	74.00	-20.02	peak
2	5280.000	100.02	4.76	104.78	-	-	peak
3	5358.000	50.76	5.38	56.14	74.00	-17.86	peak

Detector mode: Average

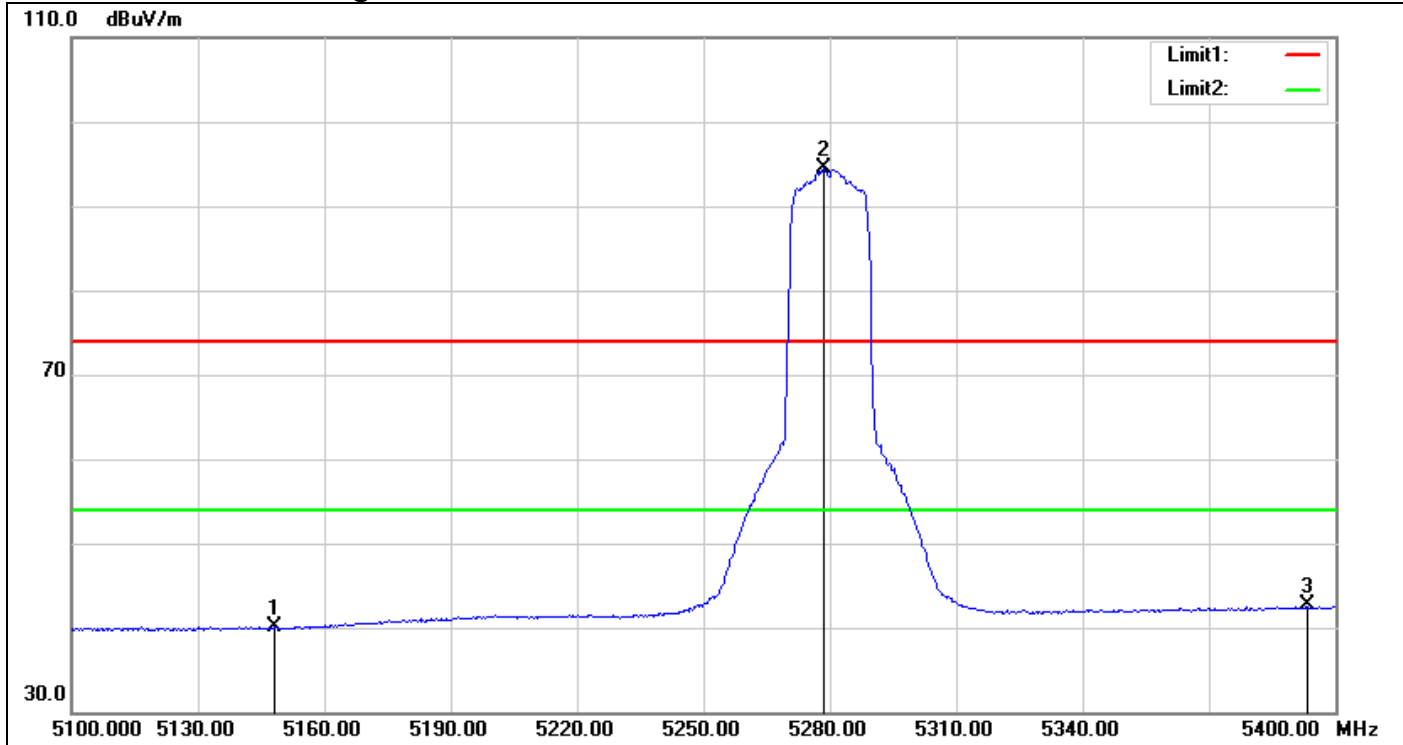

No.	Frequency (MHz)	Reading (dBuV)	Correct Factor(dB/m)	Result (dBuV/m)	Limit (dBuV/m)	Margin (dB)	Remark
1	5148.000	37.09	3.03	40.12	54.00	-13.88	AVG
2	5278.500	89.65	4.76	94.41	-	-	AVG
3	5393.400	36.93	5.67	42.60	54.00	-11.40	AVG

IEEE 802.11n HT 20 MHz Mode / CH High

Detector mode: Peak

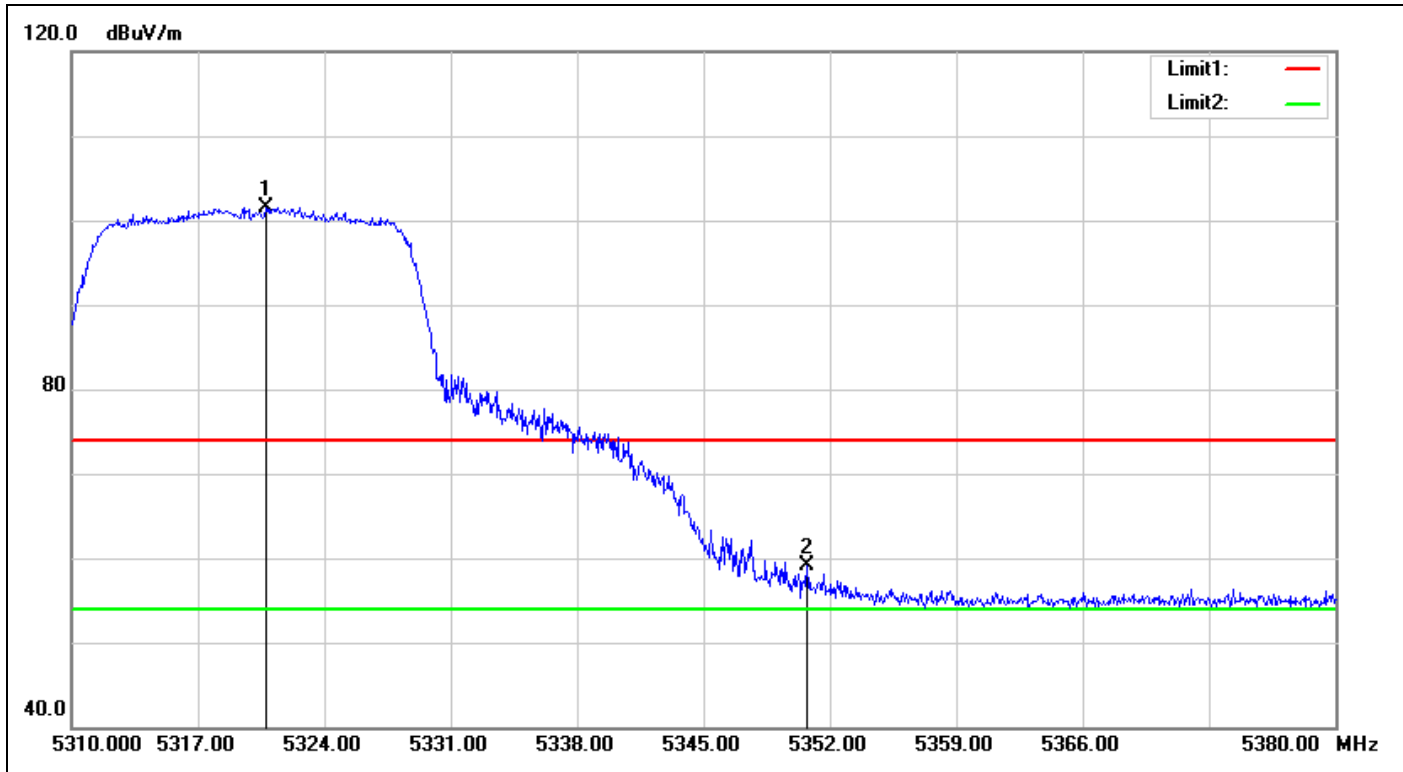

No.	Frequency (MHz)	Reading (dBuV)	Correct Factor(dB/m)	Result (dBuV/m)	Limit (dBuV/m)	Margin (dB)	Remark
1	5320.780	96.47	5.03	101.50	-	-	peak
2	5350.740	53.78	5.32	59.10	74.00	-14.90	peak

Detector mode: Average

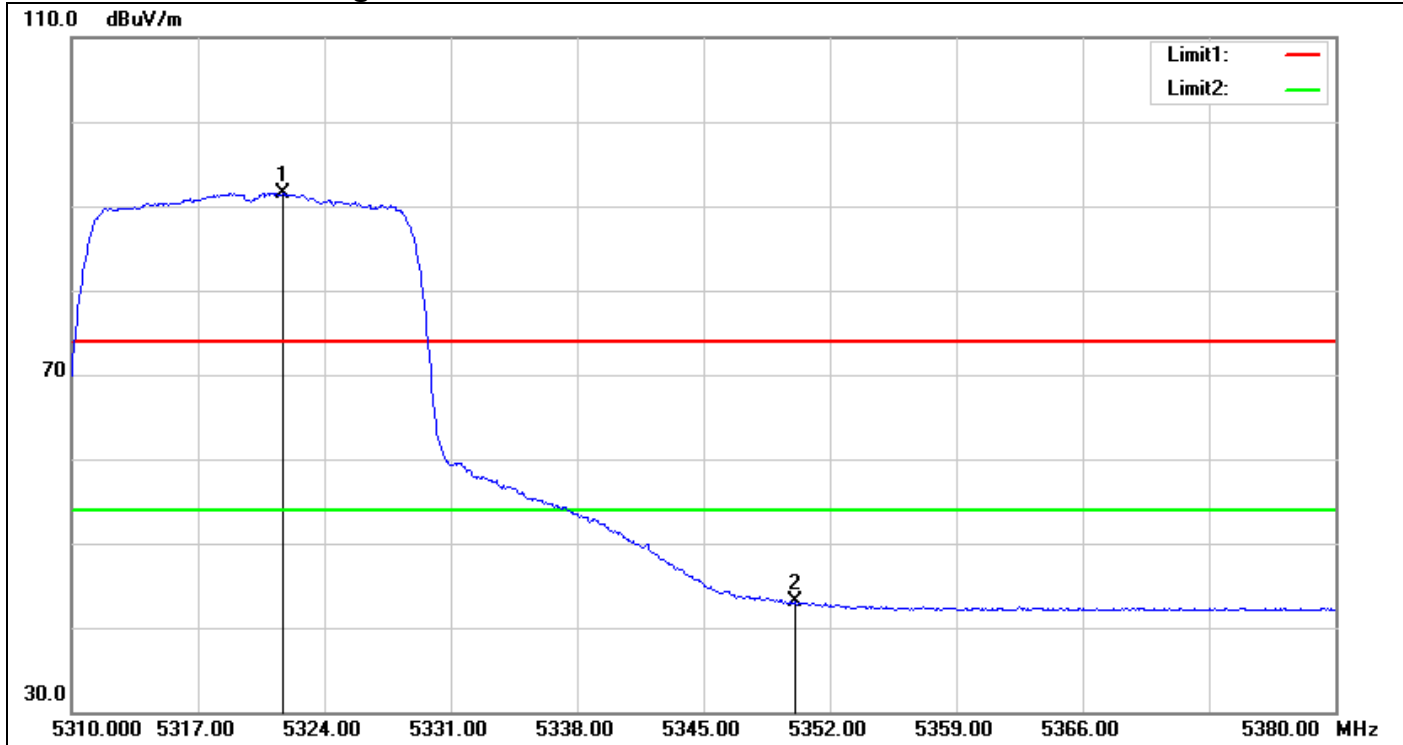

No.	Frequency (MHz)	Reading (dBuV)	Correct Factor(dB/m)	Result (dBuV/m)	Limit (dBuV/m)	Margin (dB)	Remark
1	5321.690	86.48	5.04	91.52	-	-	AVG
2	5350.110	37.71	5.31	43.02	54.00	-10.98	AVG

IEEE 802.11n HT 40 MHz Mode / CH Low

Detector mode: Peak

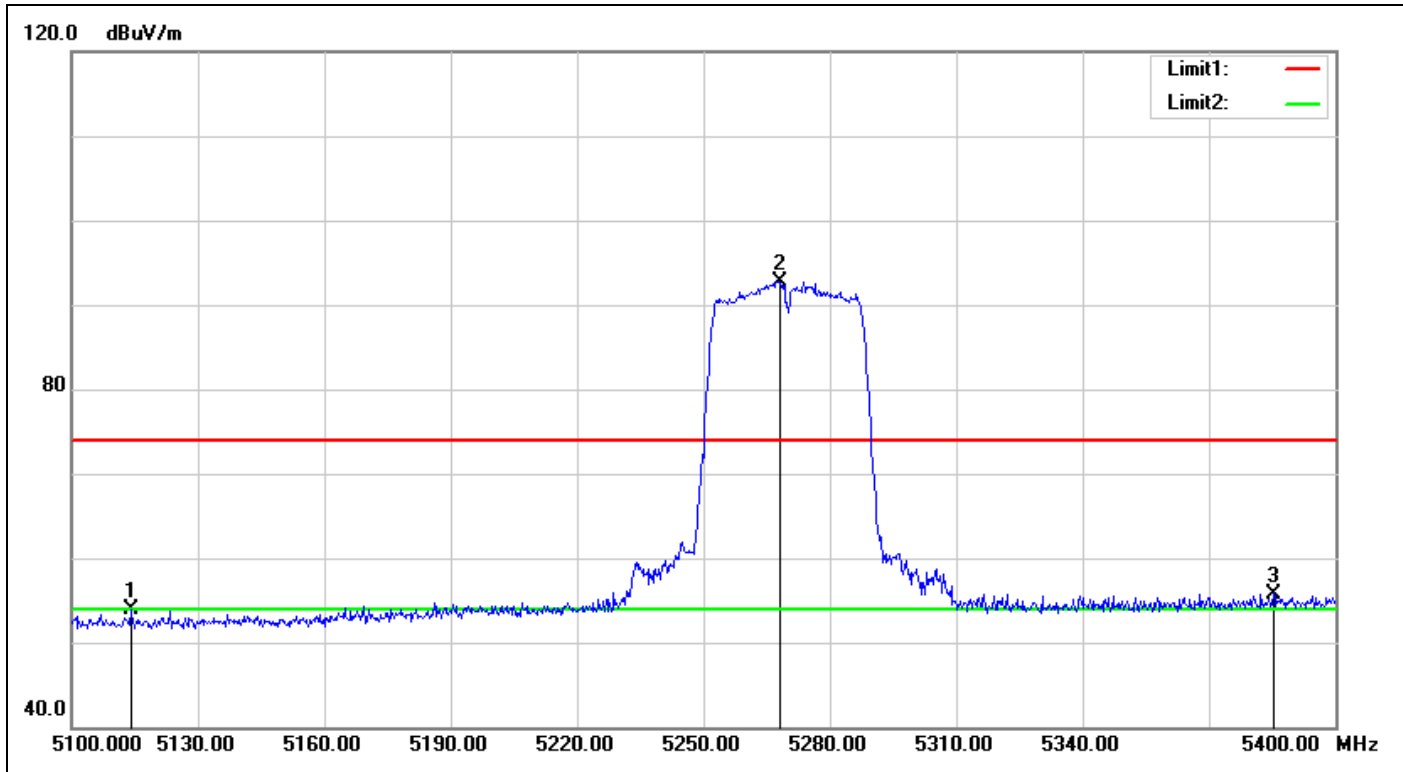

No.	Frequency (MHz)	Reading (dBuV)	Correct Factor(dB/m)	Result (dBuV/m)	Limit (dBuV/m)	Margin (dB)	Remark
1	5114.100	51.05	2.80	53.85	74.00	-20.15	peak
2	5268.000	88.00	4.72	92.72	-	-	peak
3	5385.300	50.20	5.60	55.80	74.00	-18.20	peak

Detector mode: Average

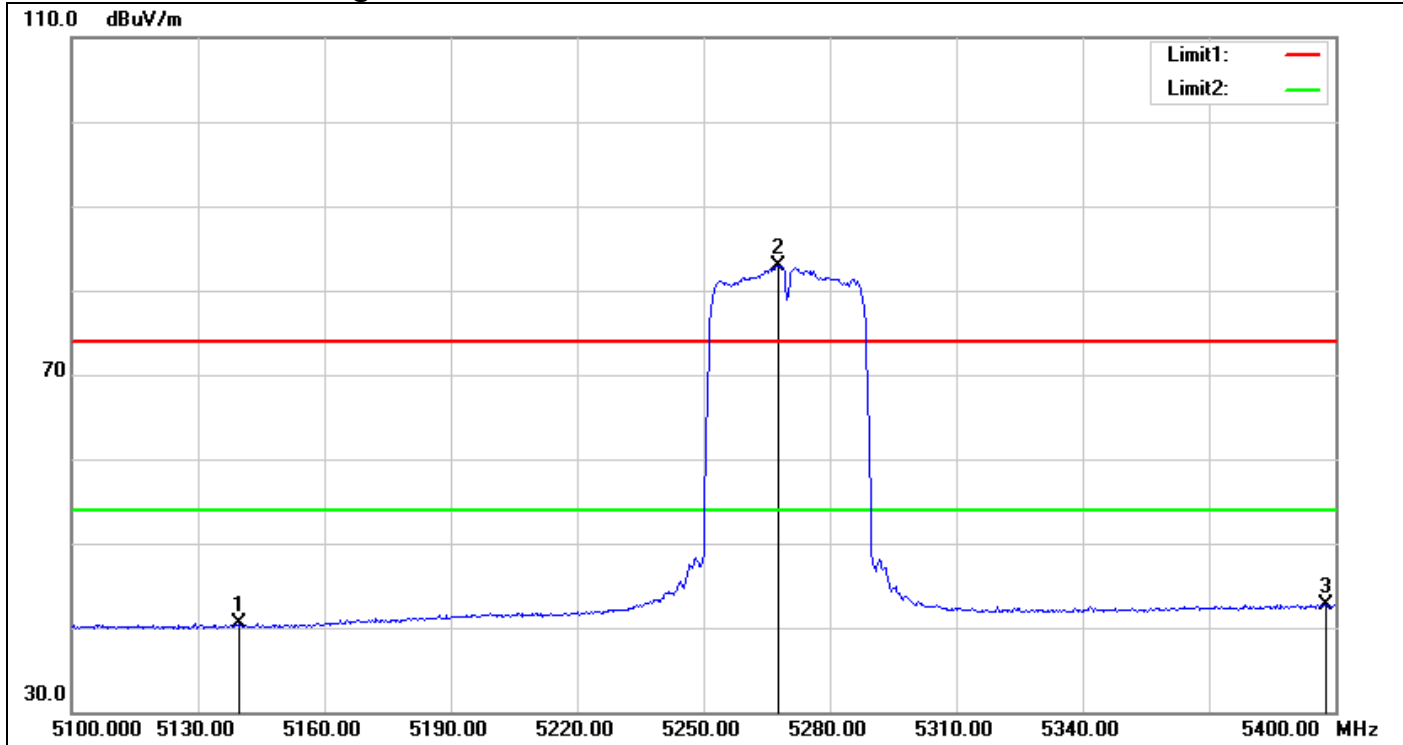

No.	Frequency (MHz)	Reading (dBuV)	Correct Factor(dB/m)	Result (dBuV/m)	Limit (dBuV/m)	Margin (dB)	Remark
1	5139.600	37.51	2.97	40.48	54.00	-13.52	AVG
2	5267.700	78.26	4.72	82.98	-	-	AVG
3	5397.600	36.99	5.70	42.69	54.00	-11.31	AVG

IEEE 802.11n HT 40 MHz Mode / CH High

Detector mode: Peak

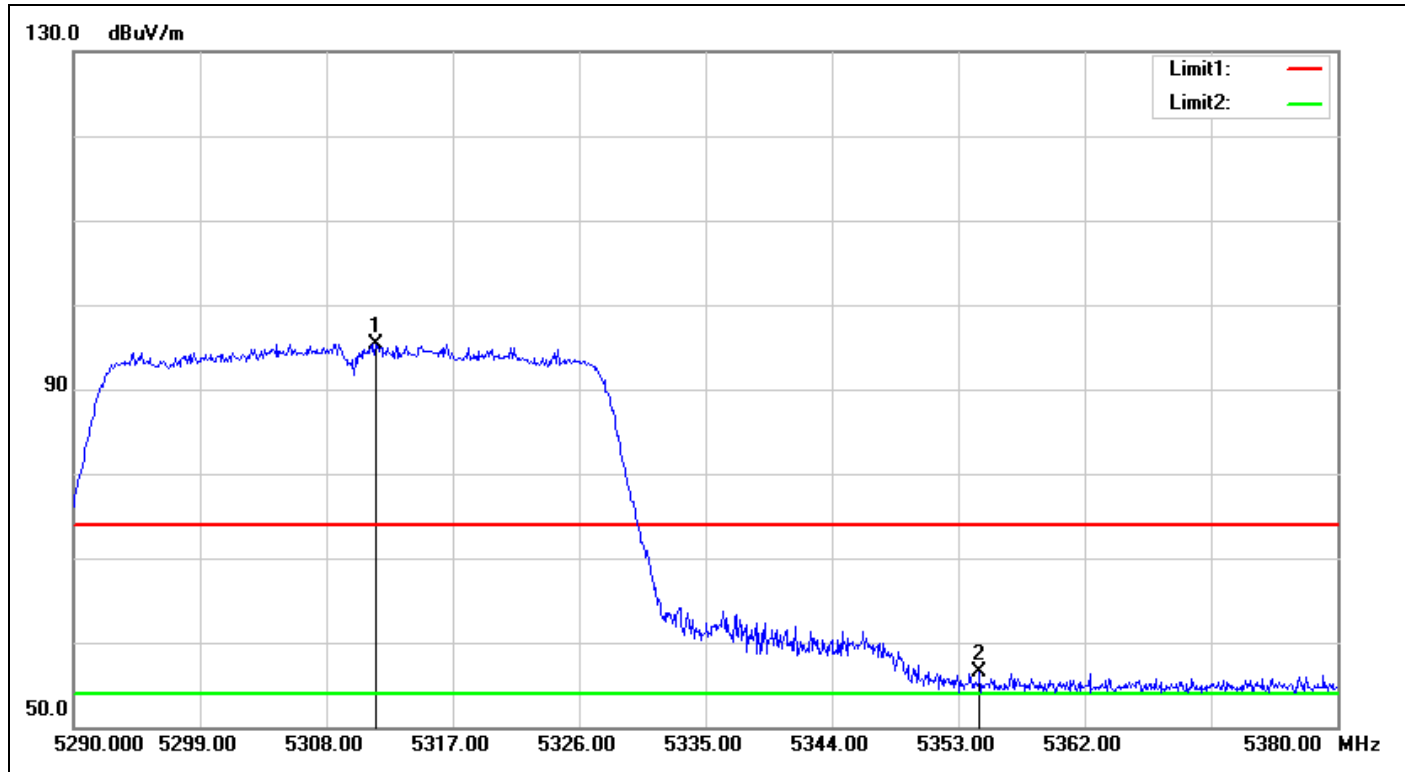

No.	Frequency (MHz)	Reading (dBuV)	Correct Factor(dB/m)	Result (dBuV/m)	Limit (dBuV/m)	Margin (dB)	Remark
1	5311.510	90.45	4.94	95.39	-	-	peak
2	5354.530	51.08	5.35	56.43	74.00	-17.57	peak

Detector mode: Average

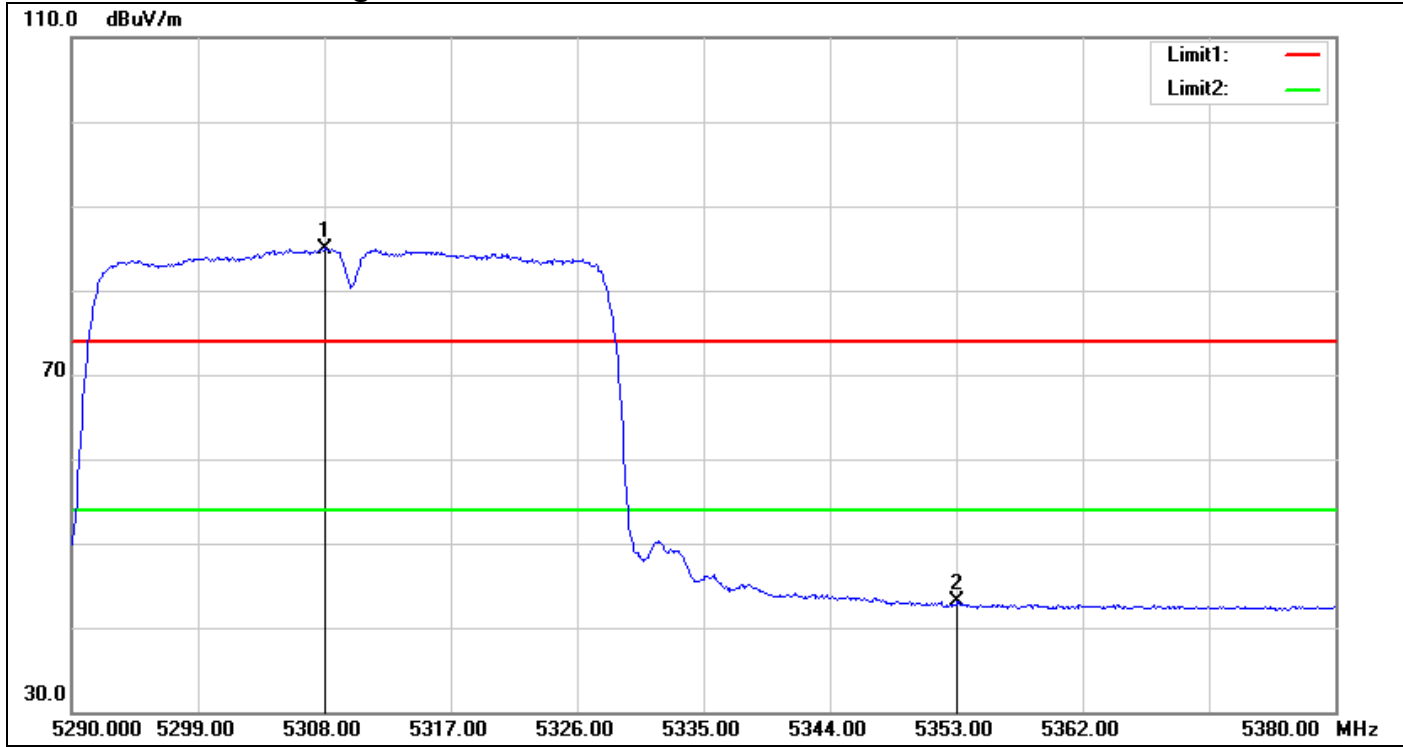

No.	Frequency (MHz)	Reading (dBuV)	Correct Factor(dB/m)	Result (dBuV/m)	Limit (dBuV/m)	Margin (dB)	Remark
1	5308.090	80.09	4.91	85.00	-	-	AVG
2	5353.090	37.75	5.34	43.09	54.00	-10.91	AVG

U-NII-2C

IEEE 802.11a Mode / CH Low

Detector mode: Peak

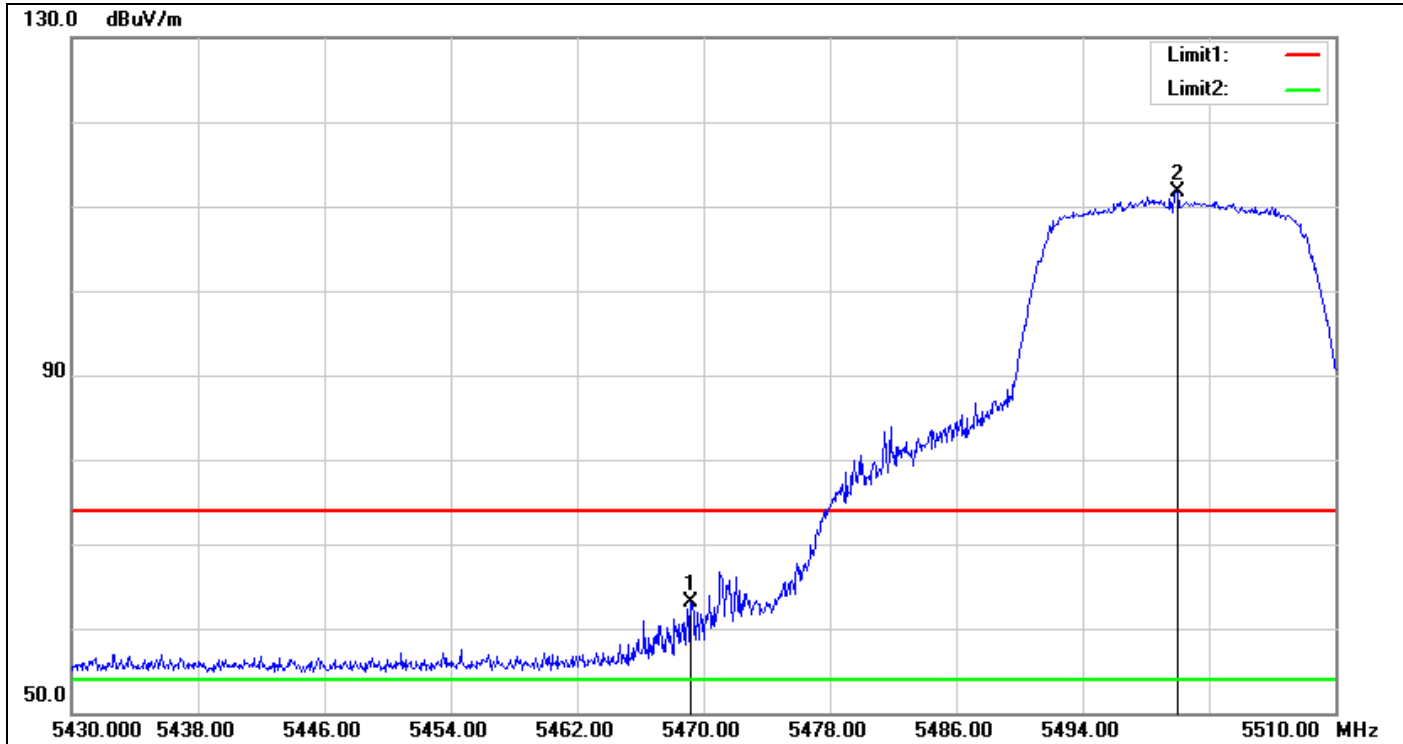

No.	Frequency (MHz)	Reading (dBuV)	Correct Factor(dB/m)	Result (dBuV/m)	Limit (dBuV/m)	Margin (dB)	Remark
1	5469.200	57.77	5.39	63.16	74.00	-10.84	peak
2	5500.000	106.46	5.25	111.71	-	-	peak

Detector mode: Average

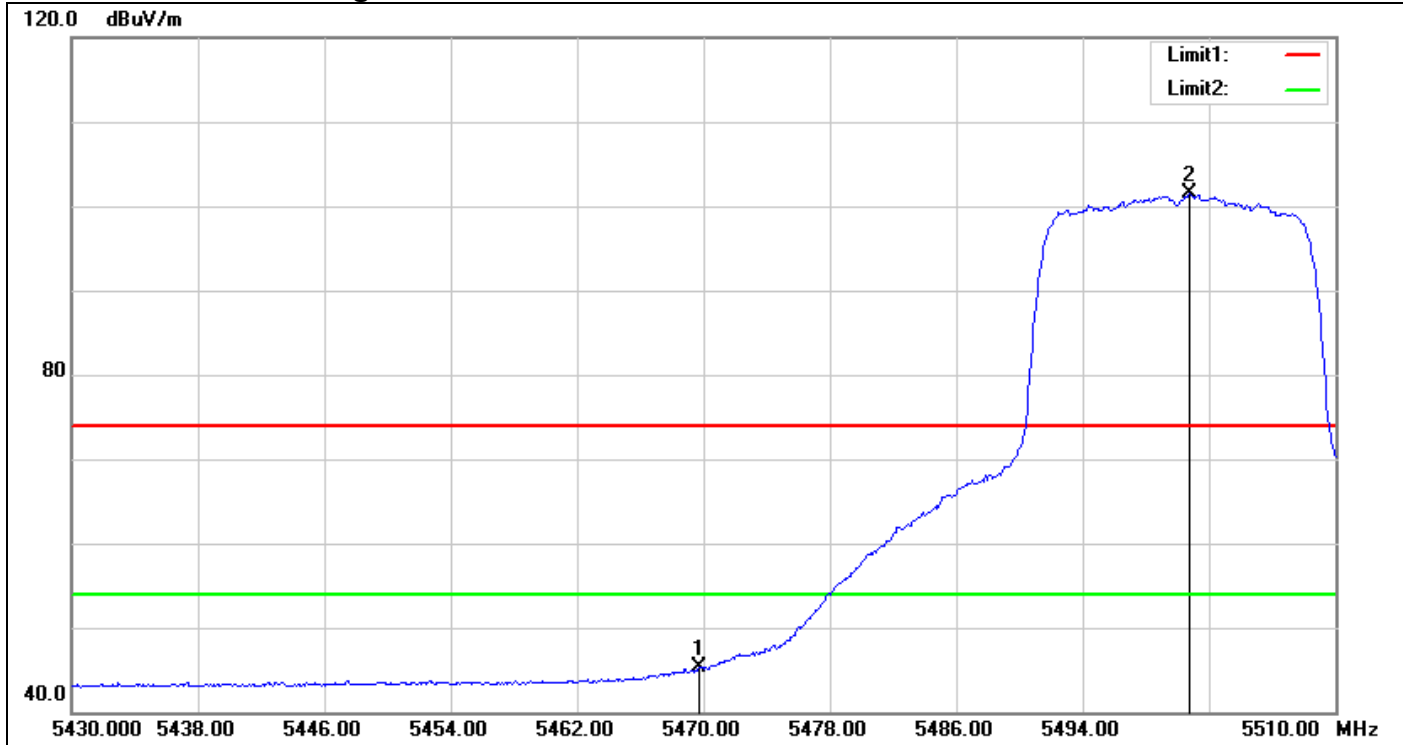

No.	Frequency (MHz)	Reading (dBuV)	Correct Factor(dB/m)	Result (dBuV/m)	Limit (dBuV/m)	Margin (dB)	Remark
1	5469.760	39.95	5.39	45.34	54.00	-8.66	AVG
2	5500.800	96.18	5.25	101.43	-	-	AVG

IEEE 802.11a Mode / CH Mid

Detector mode: Peak

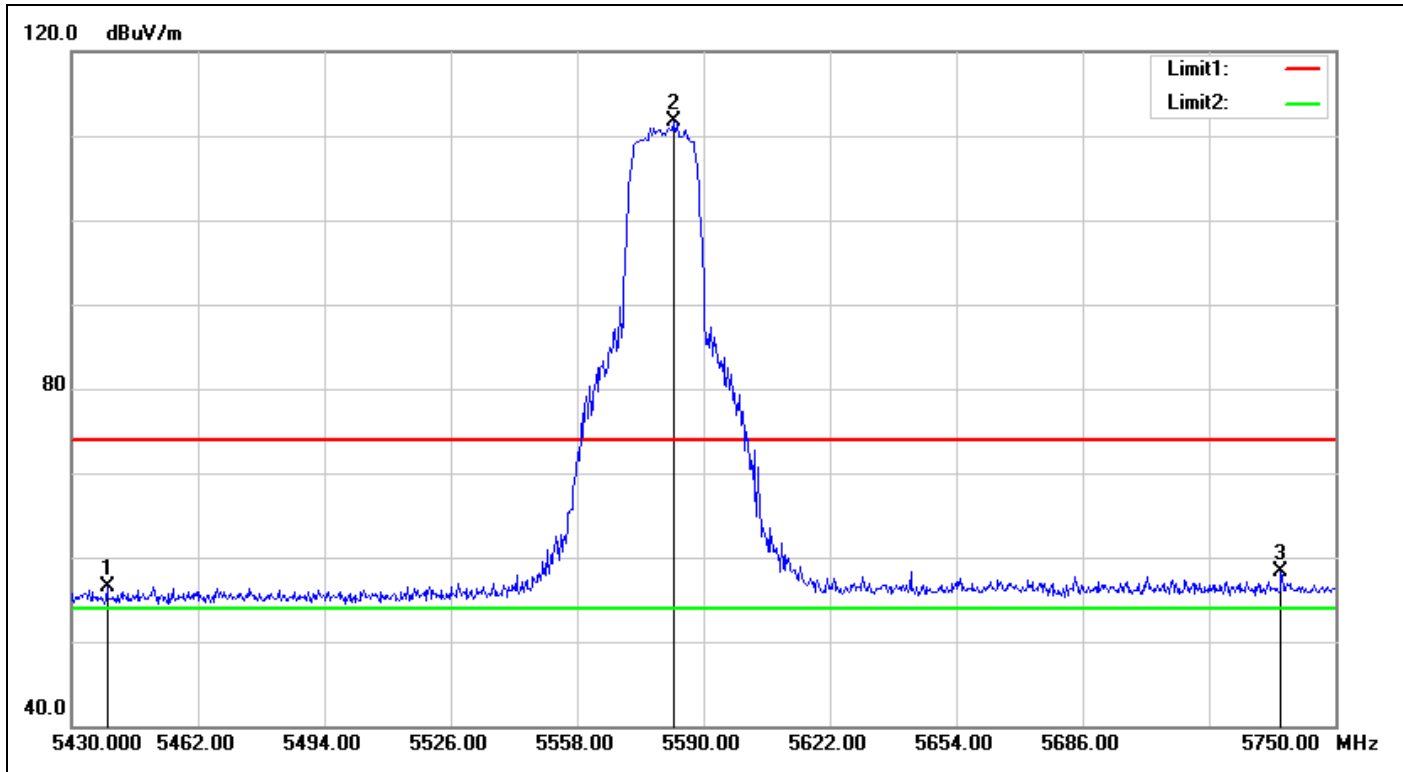

No.	Frequency (MHz)	Reading (dBuV)	Correct Factor(dB/m)	Result (dBuV/m)	Limit (dBuV/m)	Margin (dB)	Remark
1	5438.960	50.88	5.54	56.42	74.00	-17.58	peak
2	5582.320	106.05	5.60	111.65	-	-	peak
3	5736.240	52.09	6.26	58.35	74.00	-15.65	peak

Detector mode: Average

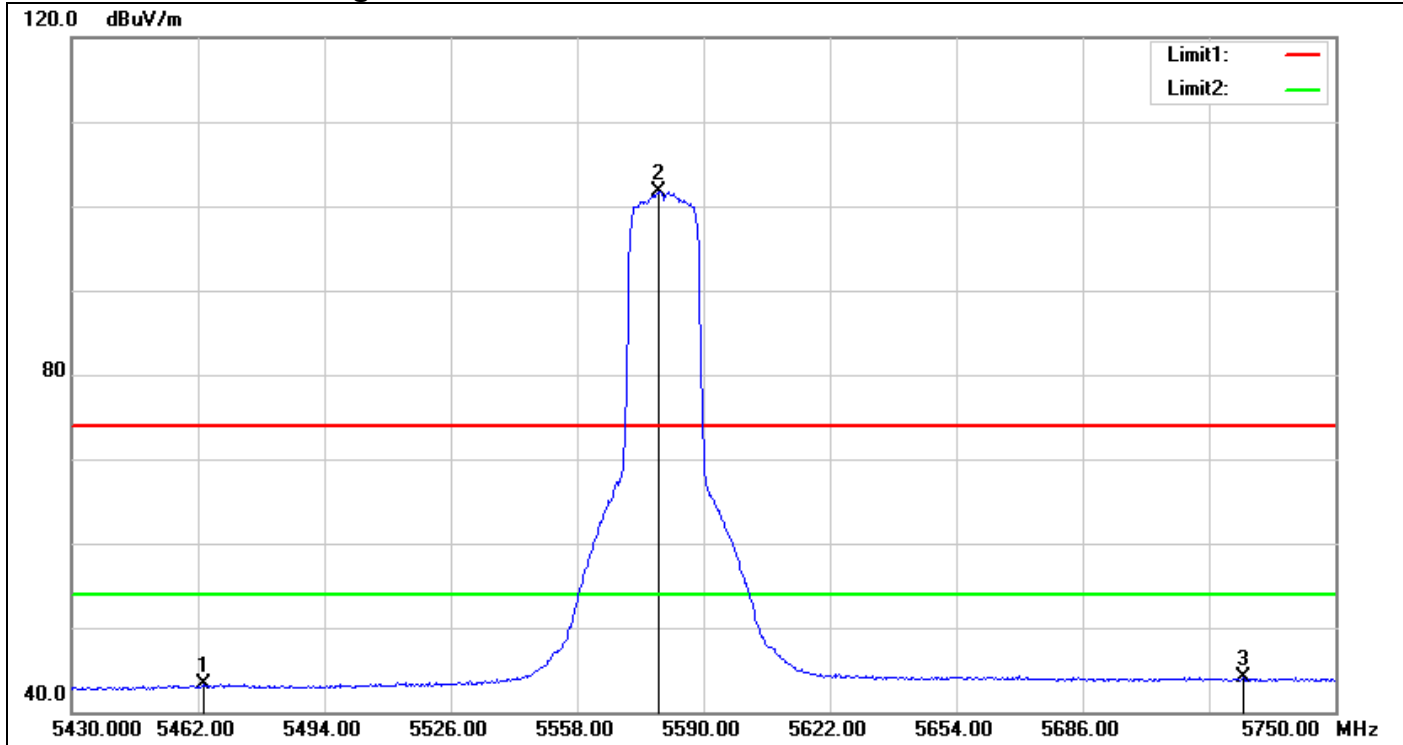

No.	Frequency (MHz)	Reading (dBuV)	Correct Factor (dB/m)	Result (dBuV/m)	Limit (dBuV/m)	Margin (dB)	Remark
1	5463.280	37.83	5.42	43.25	54.00	-10.75	AVG
2	5578.800	96.12	5.59	101.71	-	-	AVG
3	5726.640	37.84	6.22	44.06	54.00	-9.94	AVG

IEEE 802.11a Mode / CH High

Detector mode: Peak

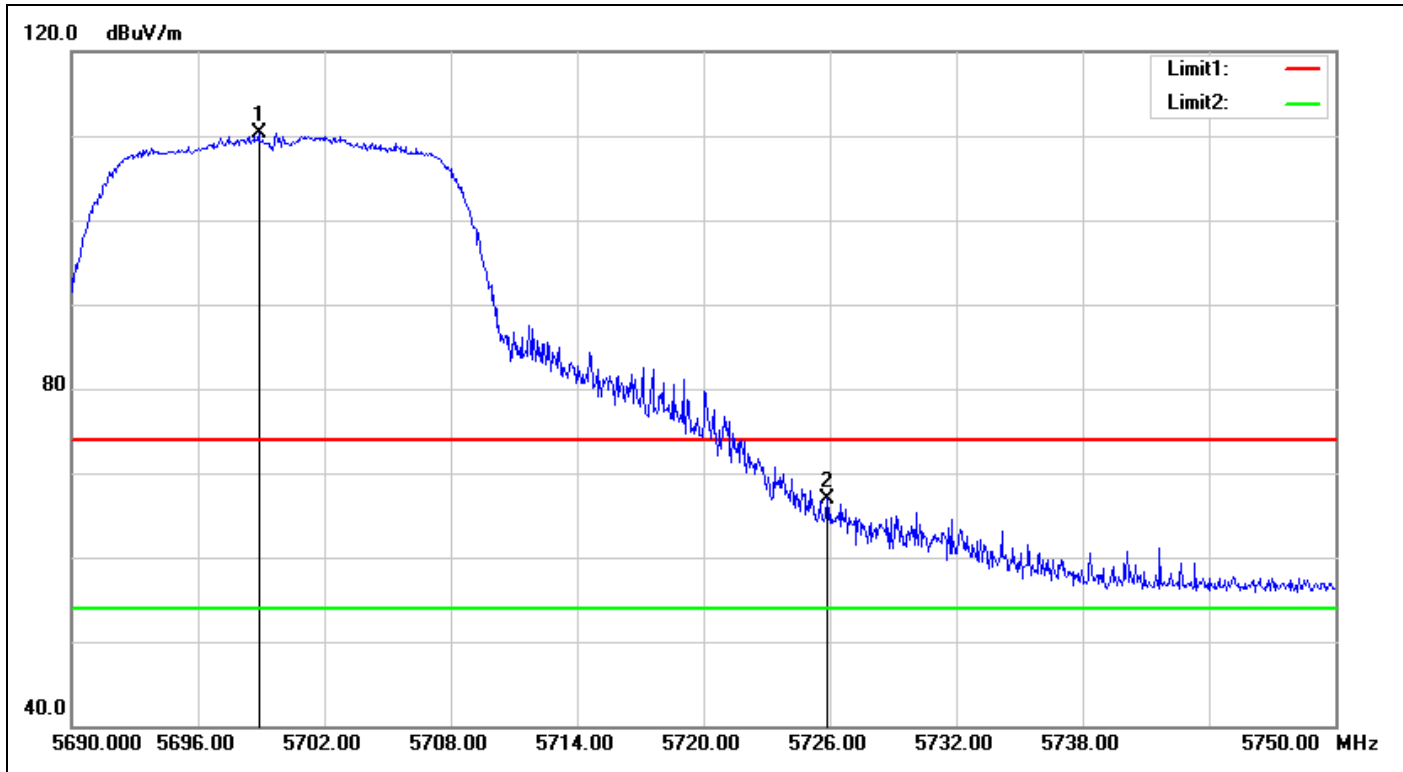

No.	Frequency (MHz)	Reading (dBuV)	Correct Factor(dB/m)	Result (dBuV/m)	Limit (dBuV/m)	Margin (dB)	Remark
1	5698.880	104.24	6.10	110.34	-	-	peak
2	5725.880	60.79	6.21	67.00	74.00	-7.00	peak

Detector mode: Average

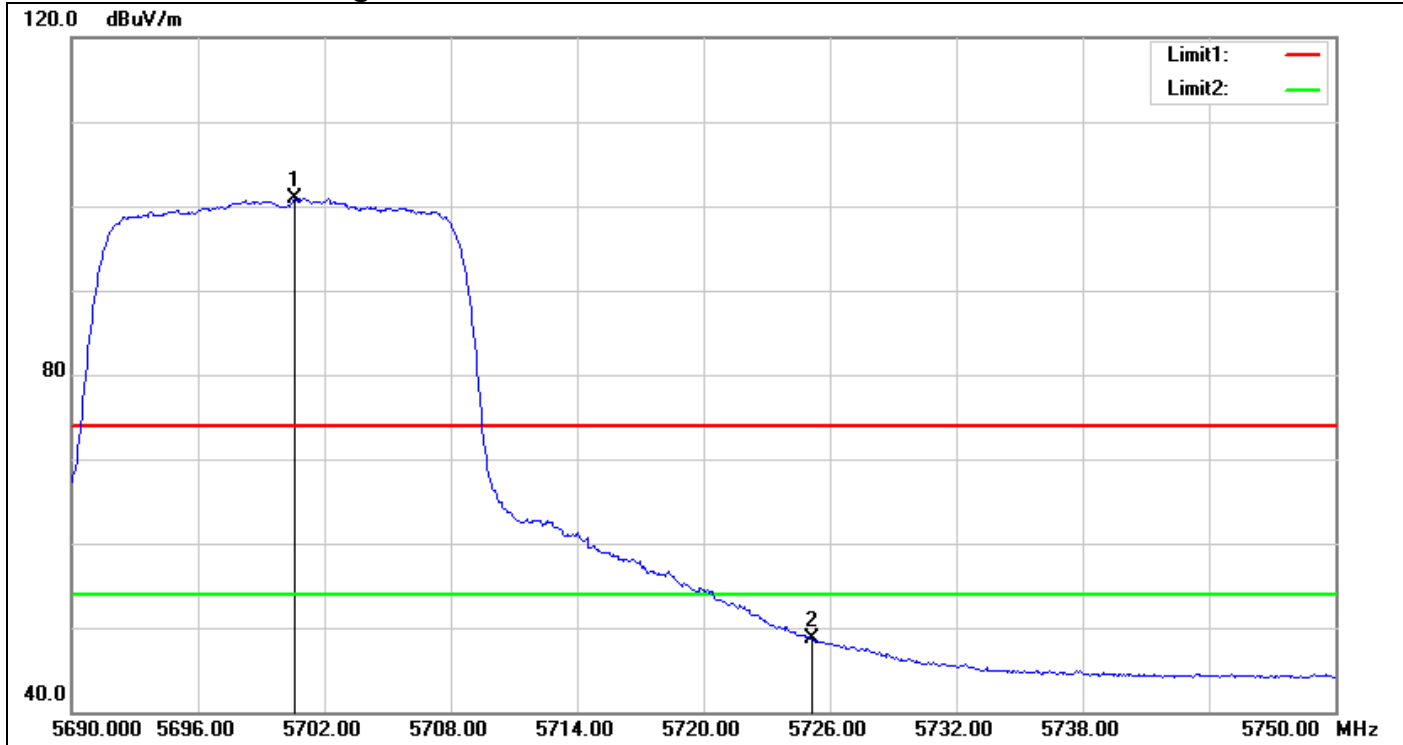

No.	Frequency (MHz)	Reading (dBuV)	Correct Factor(dB/m)	Result (dBuV/m)	Limit (dBuV/m)	Margin (dB)	Remark
1	5700.620	94.82	6.10	100.92	-	-	AVG
2	5725.160	42.53	6.21	48.74	54.00	-5.26	AVG

IEEE 802.11n HT 20 MHz Mode / CH Low

Detector mode: Peak

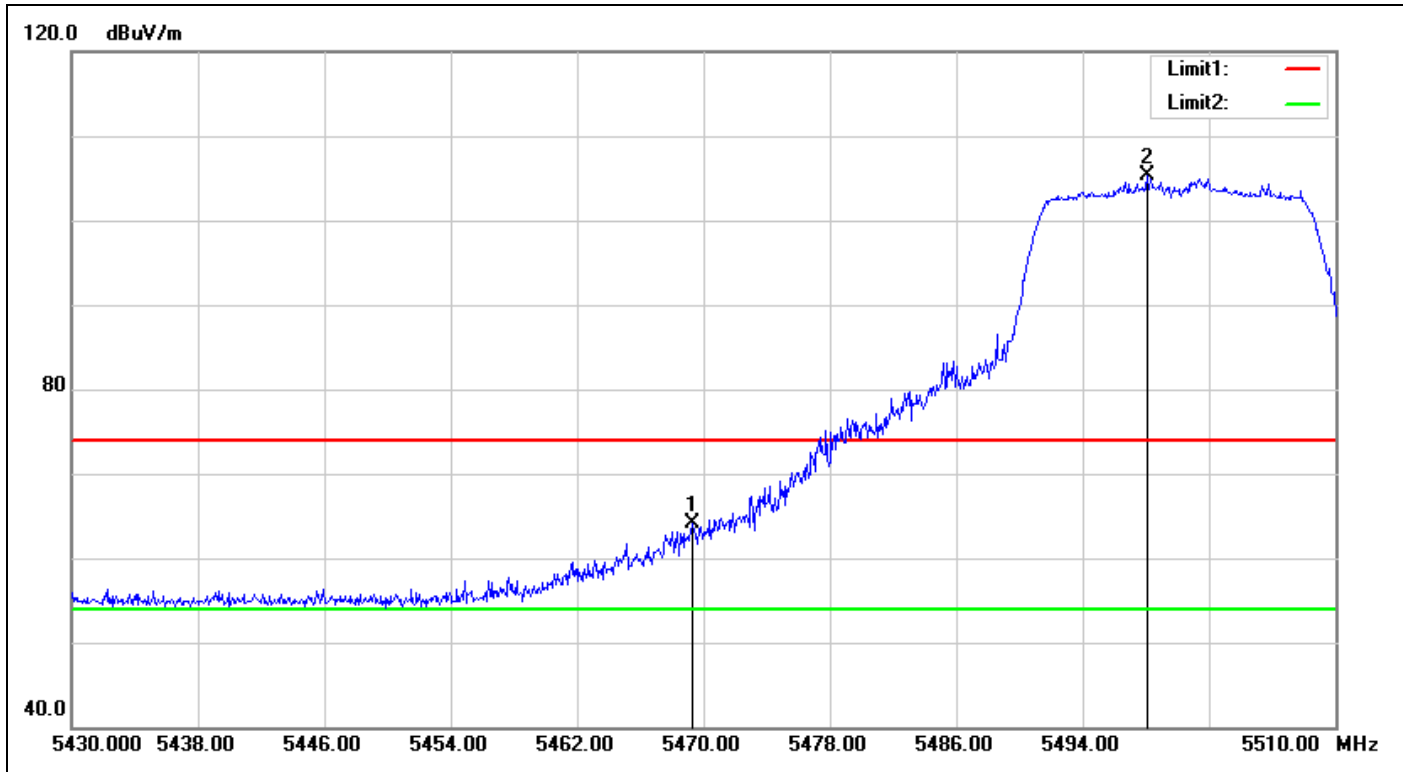

No.	Frequency (MHz)	Reading (dBuV)	Correct Factor(dB/m)	Result (dBuV/m)	Limit (dBuV/m)	Margin (dB)	Remark
1	5469.280	58.76	5.39	64.15	74.00	-9.85	peak
2	5498.080	100.03	5.26	105.29	-	-	peak

Detector mode: Average

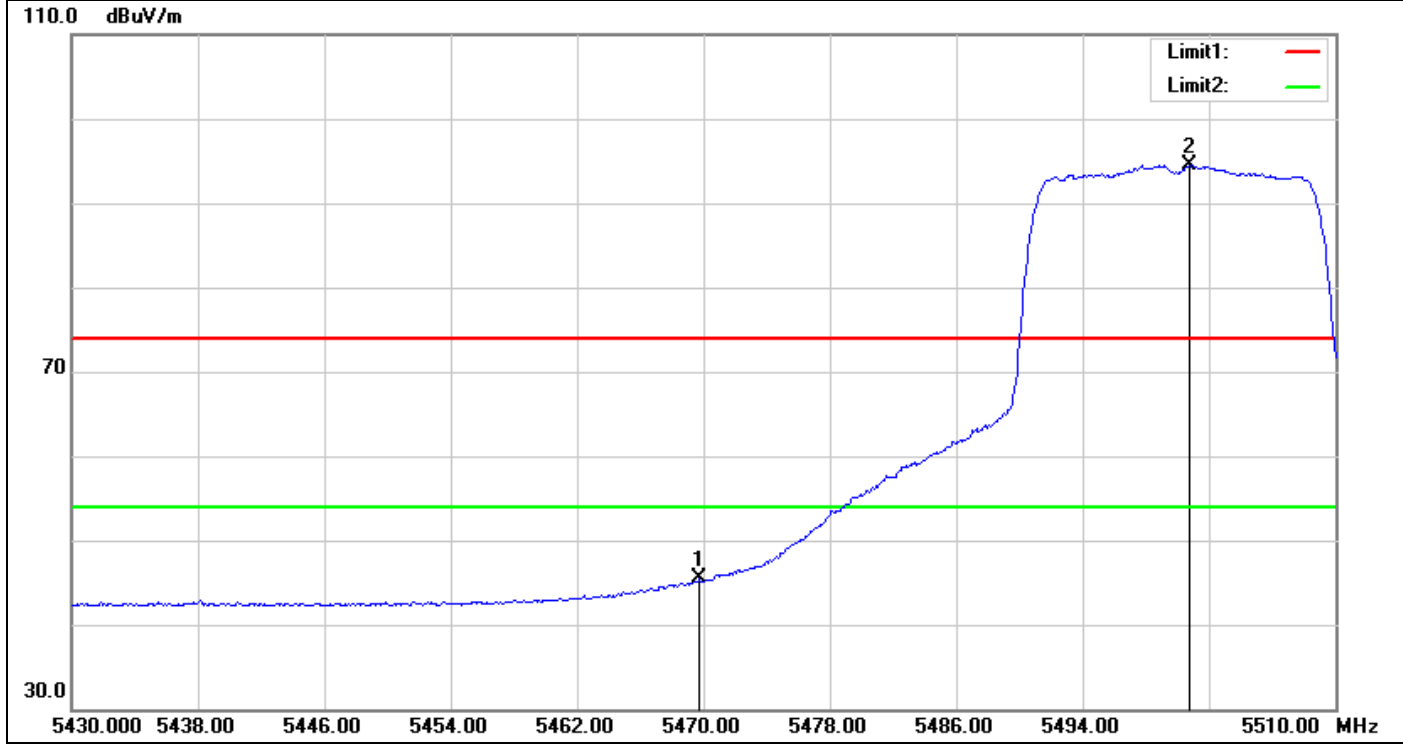

No.	Frequency (MHz)	Reading (dBuV)	Correct Factor(dB/m)	Result (dBuV/m)	Limit (dBuV/m)	Margin (dB)	Remark
1	5469.760	40.09	5.39	45.48	54.00	-8.52	AVG
2	5500.800	89.27	5.25	94.52	-	-	AVG

IEEE 802.11n HT 20 MHz Mode / CH Mid

Detector mode: Peak

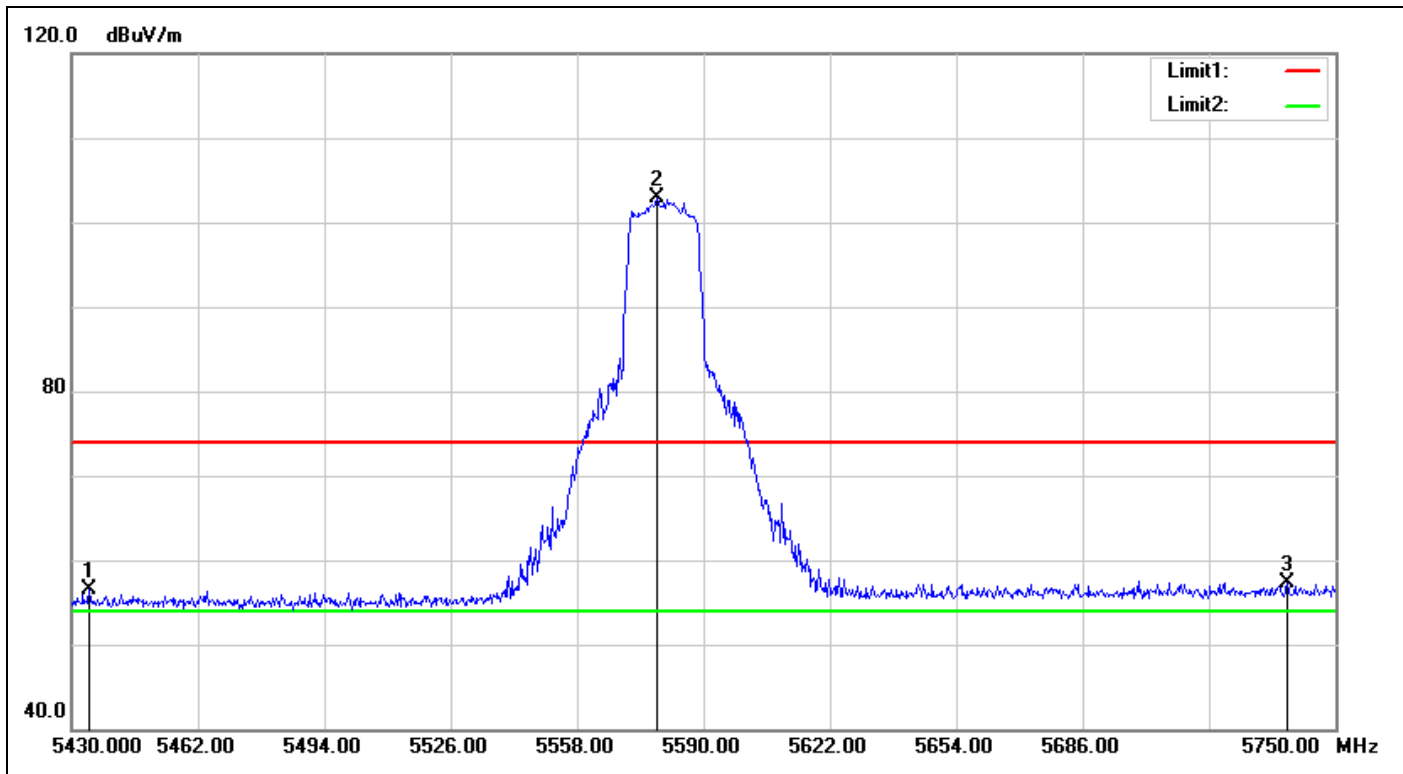

No.	Frequency (MHz)	Reading (dBuV)	Correct Factor(dB/m)	Result (dBuV/m)	Limit (dBuV/m)	Margin (dB)	Remark
1	5434.480	51.03	5.56	56.59	74.00	-17.41	peak
2	5578.160	97.32	5.58	102.90	-	-	peak
3	5737.840	51.02	6.26	57.28	74.00	-16.72	peak

Detector mode: Average

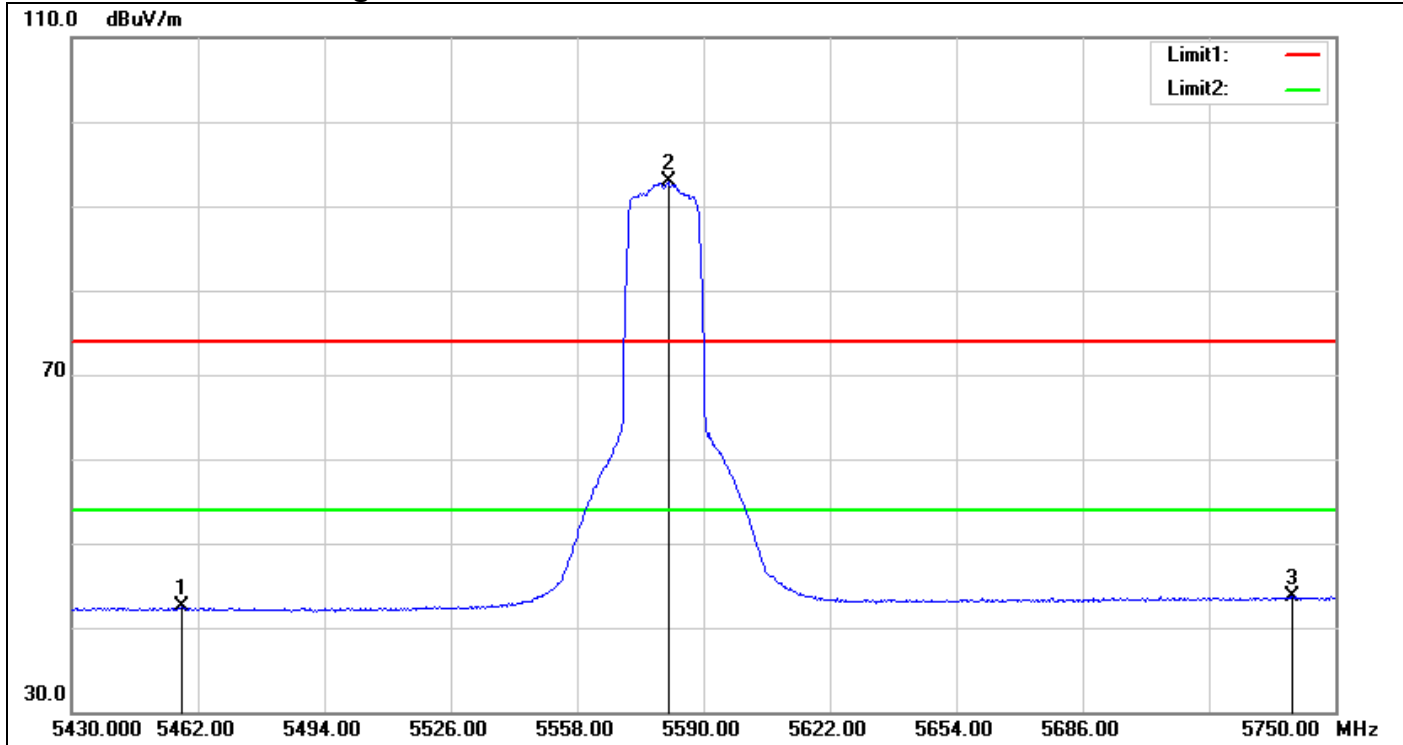

No.	Frequency (MHz)	Reading (dBuV)	Correct Factor(dB/m)	Result (dBuV/m)	Limit (dBuV/m)	Margin (dB)	Remark
1	5457.840	37.01	5.45	42.46	54.00	-11.54	AVG
2	5581.040	87.27	5.60	92.87	-	-	AVG
3	5739.120	37.39	6.27	43.66	54.00	-10.34	AVG

IEEE 802.11n HT 20 MHz Mode / CH High

Detector mode: Peak

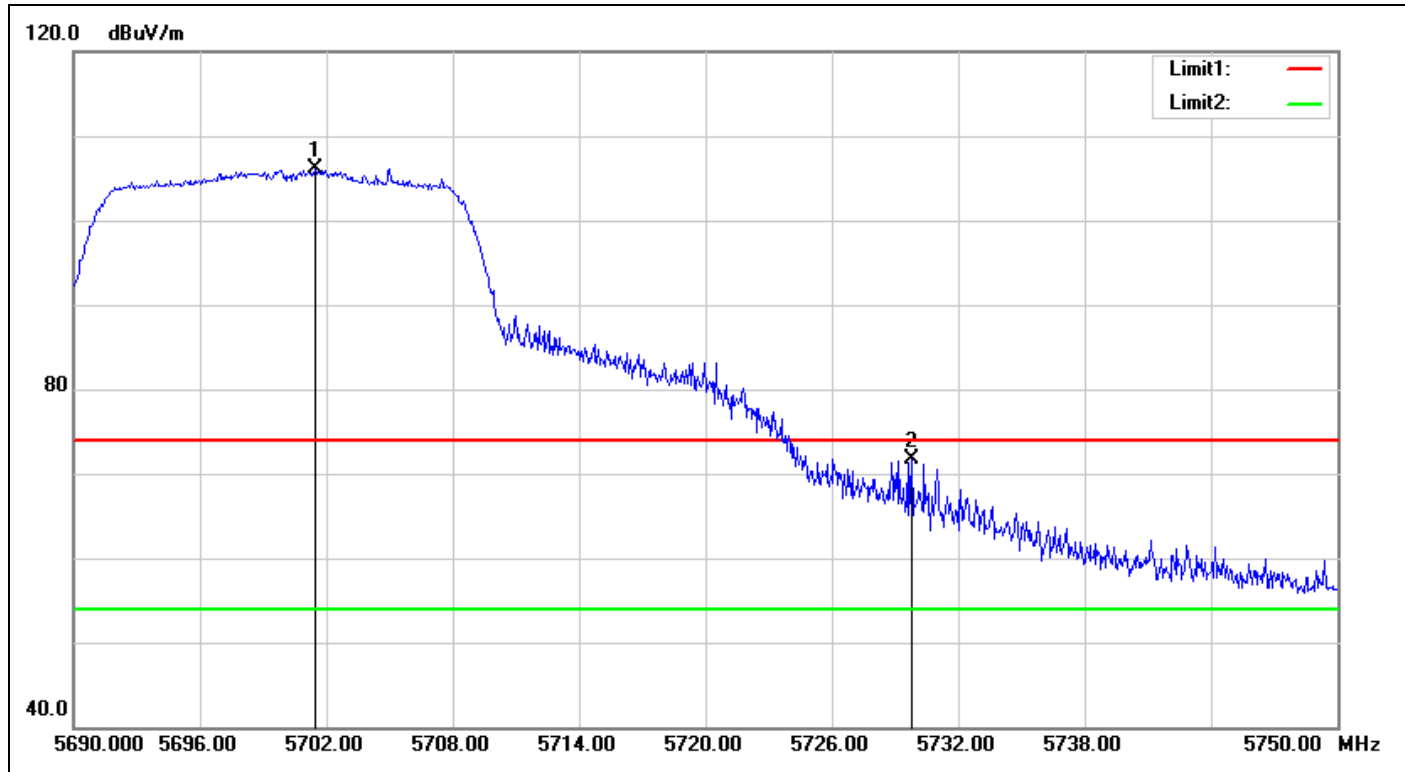

No.	Frequency (MHz)	Reading (dBuV)	Correct Factor(dB/m)	Result (dBuV/m)	Limit (dBuV/m)	Margin (dB)	Remark
1	5701.460	100.03	6.11	106.14	-	-	peak
2	5729.780	65.38	6.23	71.61	74.00	-2.39	peak

Detector mode: Average

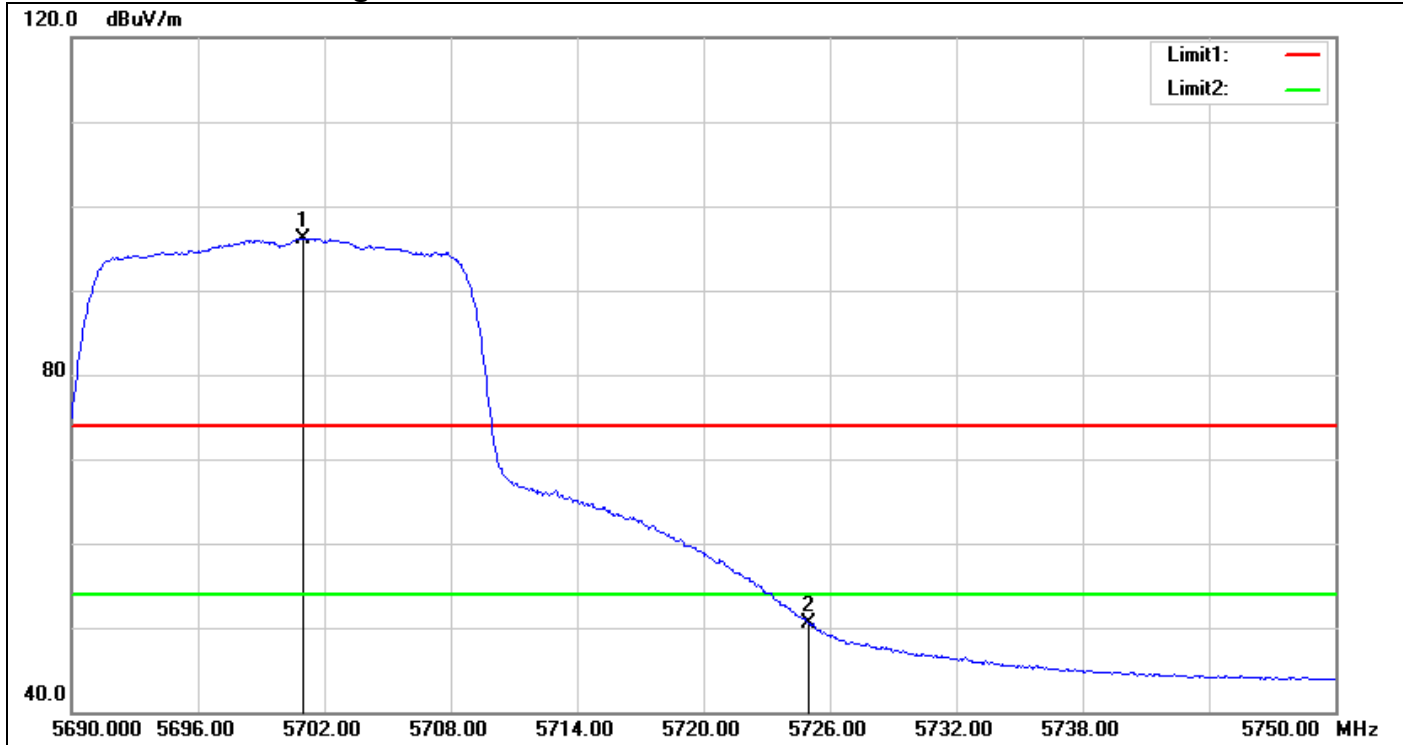

No.	Frequency (MHz)	Reading (dBuV)	Correct Factor(dB/m)	Result (dBuV/m)	Limit (dBuV/m)	Margin (dB)	Remark
1	5700.980	90.08	6.11	96.19	-	-	peak
2	5725.000	44.32	6.21	50.53	74.00	-23.47	peak

IEEE 802.11n HT 40 MHz Mode / CH Low

Detector mode: Peak

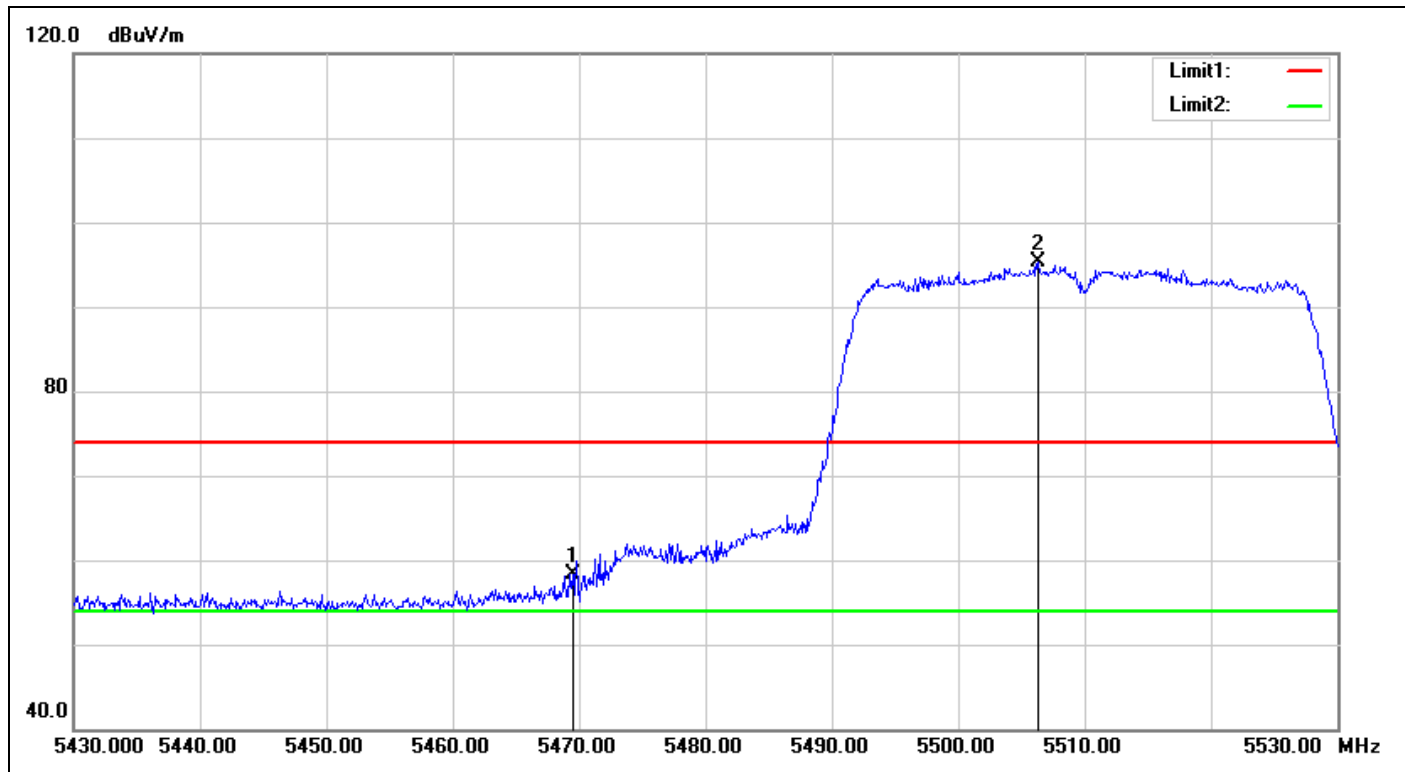

No.	Frequency (MHz)	Reading (dBuV)	Correct Factor(dB/m)	Result (dBuV/m)	Limit (dBuV/m)	Margin (dB)	Remark
1	5469.500	52.93	5.39	58.32	74.00	-15.68	peak
2	5506.300	90.08	5.28	95.36	-	-	peak

Detector mode: Average

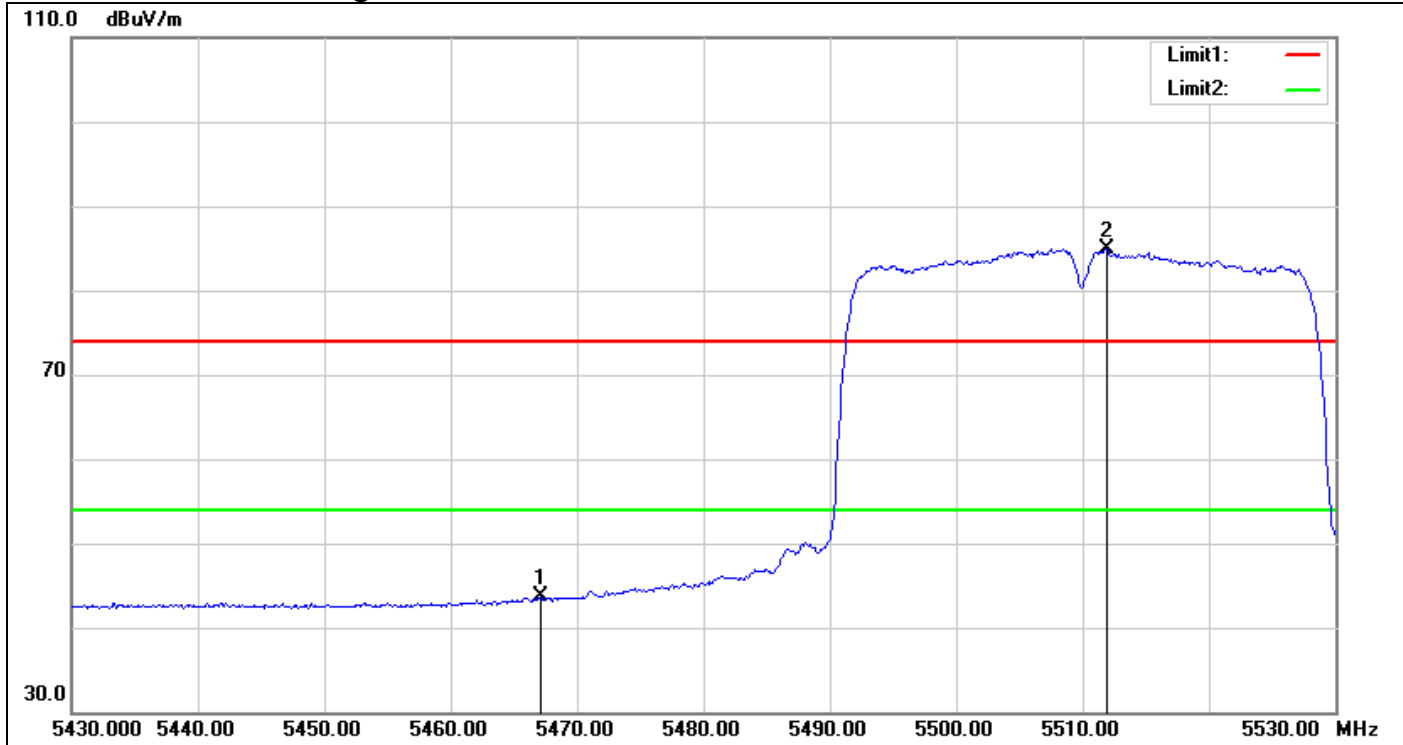

No.	Frequency (MHz)	Reading (dBuV)	Correct Factor(dB/m)	Result (dBuV/m)	Limit (dBuV/m)	Margin (dB)	Remark
1	5467.100	38.32	5.40	43.72	54.00	-10.28	AVG
2	5511.900	79.66	5.30	84.96	-	-	AVG

IEEE 802.11n HT 40 MHz Mode / CH Mid

Detector mode: Peak

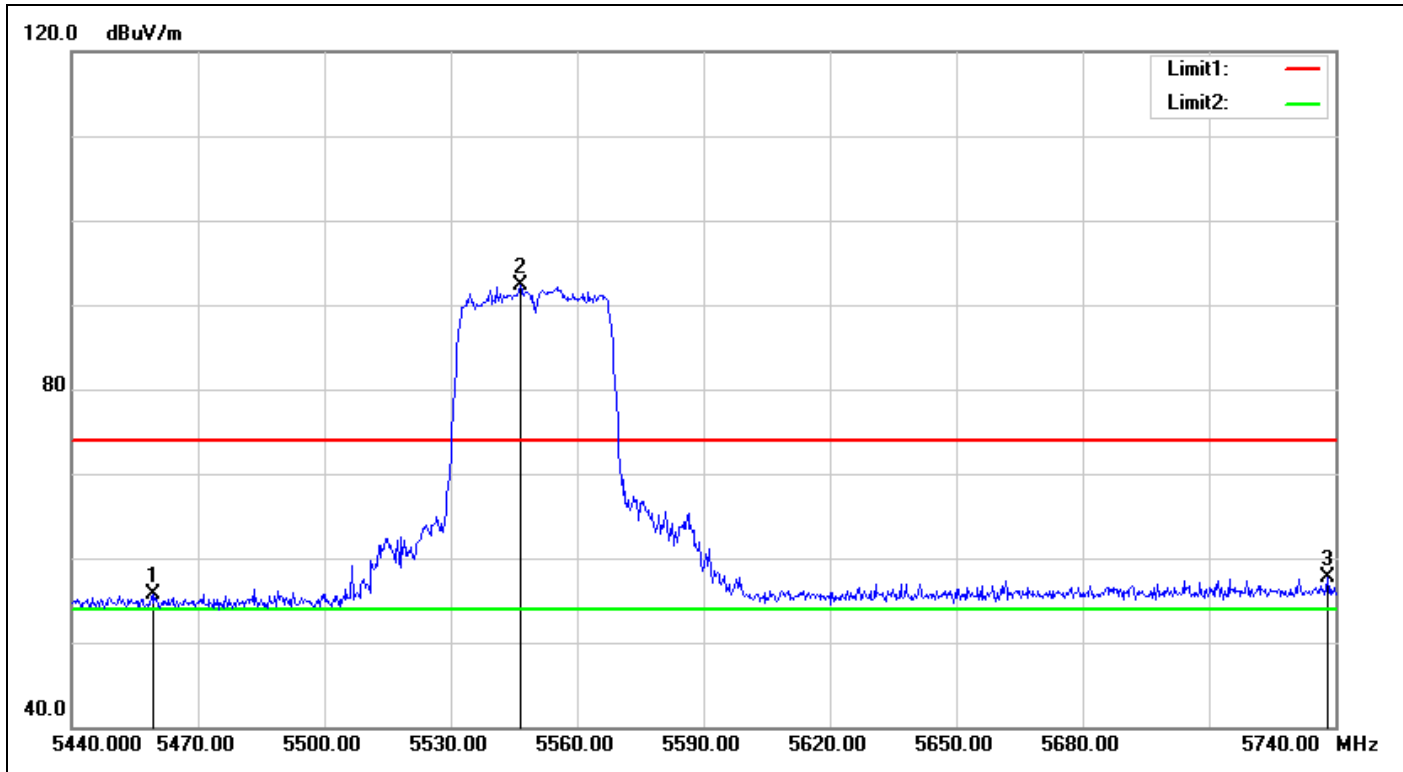

No.	Frequency (MHz)	Reading (dBuV)	Correct Factor(dB/m)	Result (dBuV/m)	Limit (dBuV/m)	Margin (dB)	Remark
1	5459.200	50.30	5.44	55.74	74.00	-18.26	peak
2	5546.500	86.80	5.45	92.25	-	-	peak
3	5738.200	51.45	6.26	57.71	74.00	-16.29	peak

Detector mode: Average

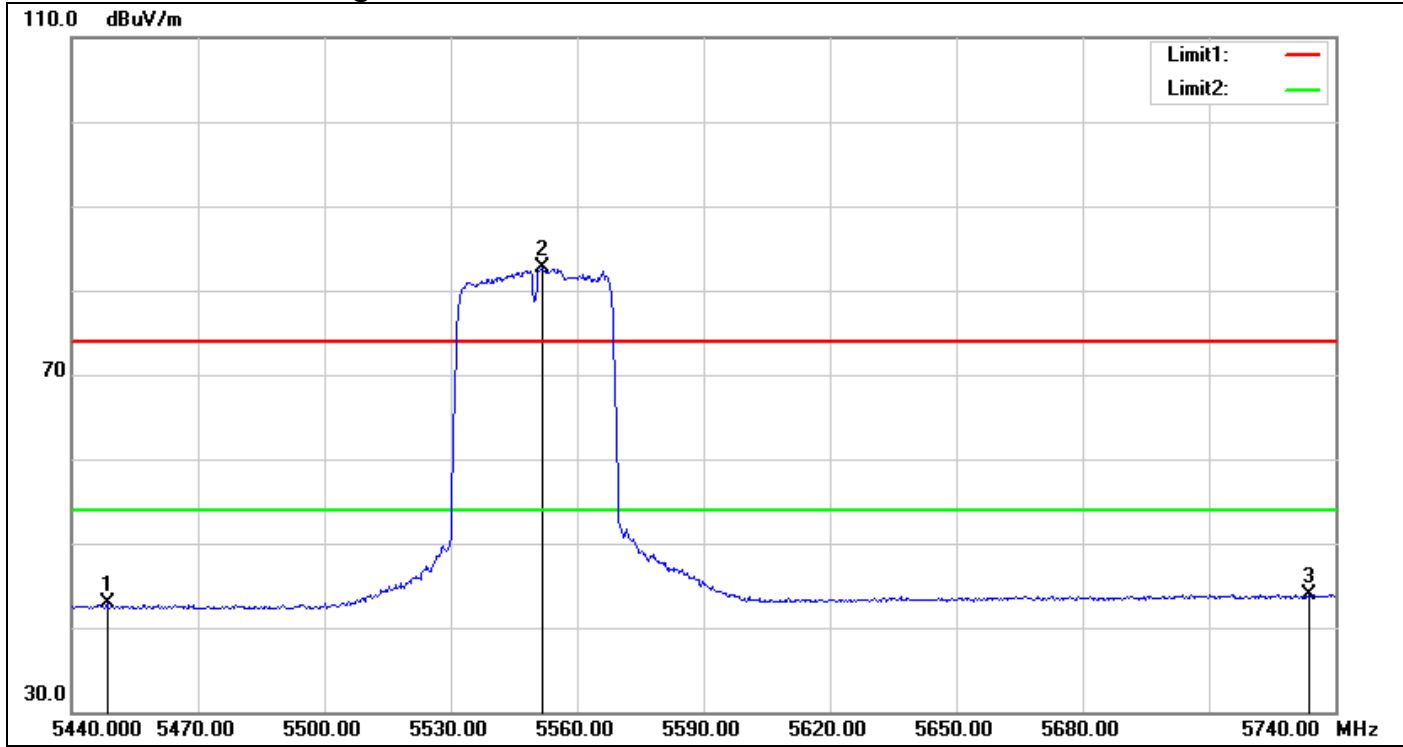

No.	Frequency (MHz)	Reading (dBuV)	Correct Factor(dB/m)	Result (dBuV/m)	Limit (dBuV/m)	Margin (dB)	Remark
1	5448.400	37.33	5.49	42.82	54.00	-11.18	AVG
2	5551.600	77.22	5.47	82.69	-	-	AVG
3	5733.700	37.64	6.25	43.89	54.00	-10.11	AVG

IEEE 802.11n HT 40 MHz Mode / CH High

Detector mode: Peak

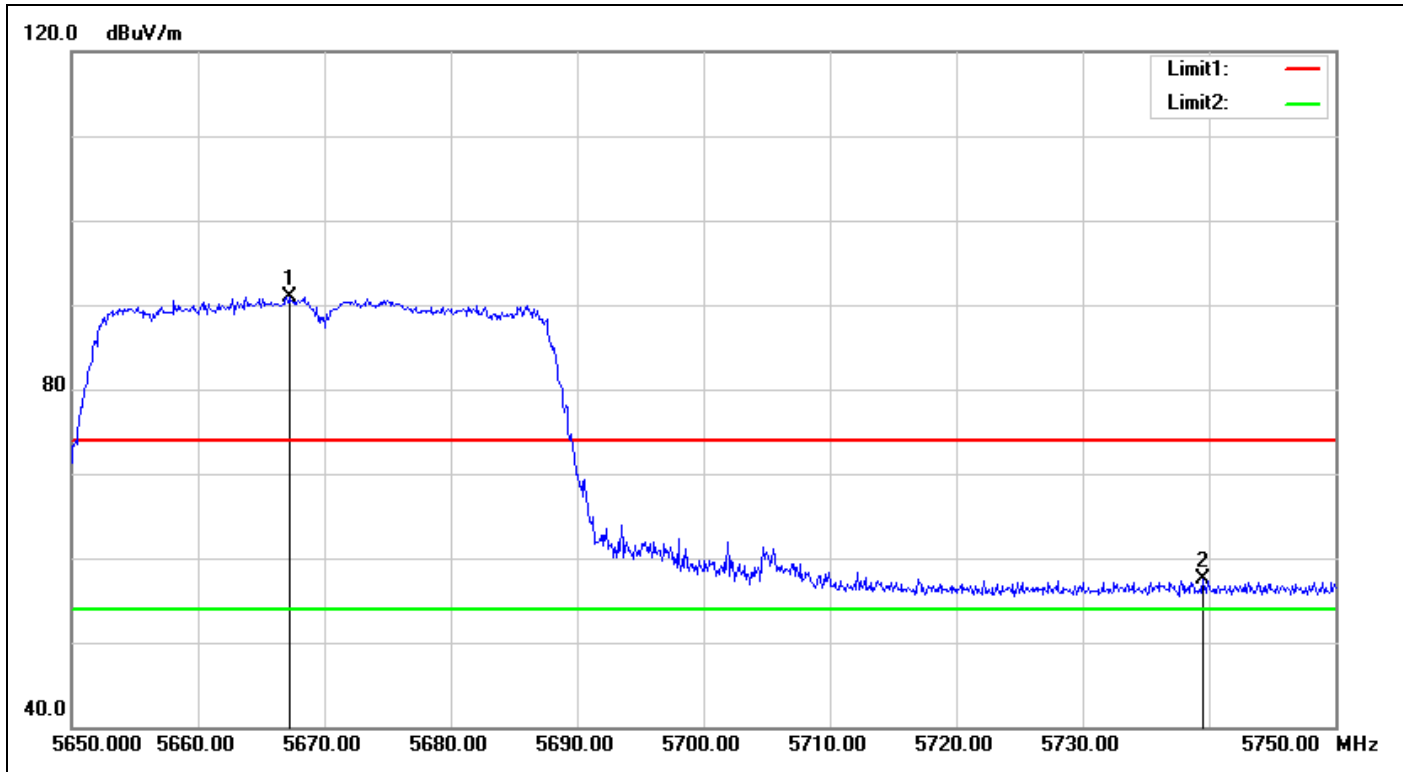

No.	Frequency (MHz)	Reading (dBuV)	Correct Factor(dB/m)	Result (dBuV/m)	Limit (dBuV/m)	Margin (dB)	Remark
1	5667.300	85.00	5.96	90.96	-	-	peak
2	5739.500	51.31	6.27	57.58	74.00	-16.42	peak

Detector mode: Average

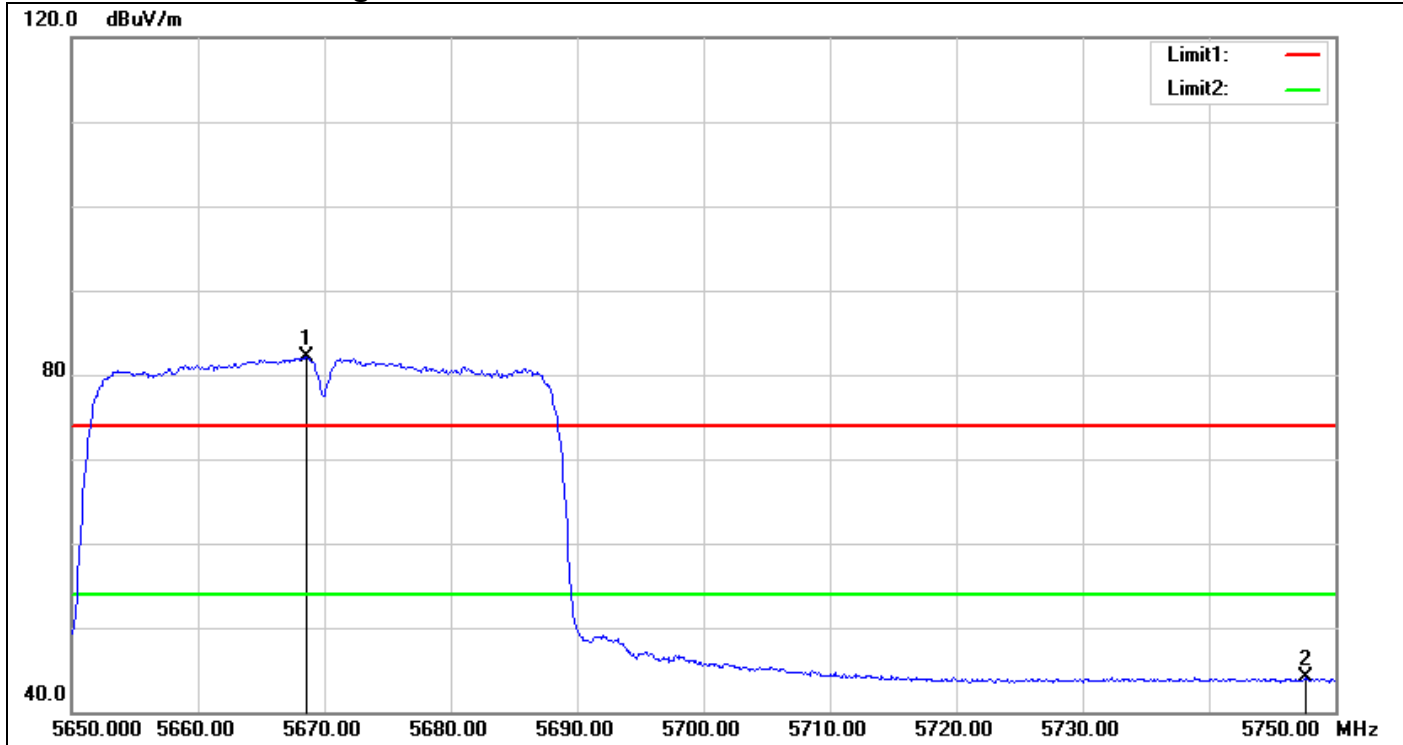

No.	Frequency (MHz)	Reading (dBuV)	Correct Factor(dB/m)	Result (dBuV/m)	Limit (dBuV/m)	Margin (dB)	Remark
1	5668.600	76.16	5.97	82.13	-	-	AVG
2	5747.600	37.79	6.30	44.09	54.00	-9.91	AVG

7.5 PEAK POWER SPECTRAL DENSITY

LIMIT

According to §15.407(a)

- (1) For the band 5.15-5.25 GHz, the peak power spectral density shall not exceed 11dBm in any 1MHz band.
- (2) For the band 5.25-5.35 GHz, the peak power spectral density shall not exceed 11dBm in any 1MHz band.

According to RSS-247,

- (1) The e.i.r.p. spectral density shall not exceed 10 dBm in any 1.0 MHz band.
- (2) The power spectral density shall not exceed 11 dBm in any 1.0 MHz band.

If transmitting antennas of directional gain greater than 6dBi are used, both the peak transmit power and the peak power spectral density shall be reduced by the amount in dB that the directional gain of the antenna exceeds 6dBi.

Test Configuration

TEST PROCEDURE

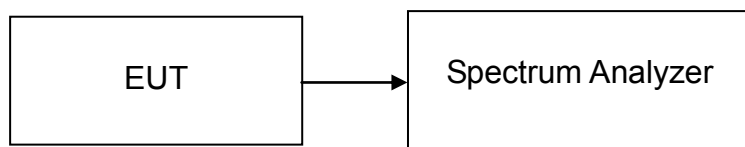

1. Place the EUT on the table and set it in transmitting mode. Remove the antenna from the EUT and then connect a low loss RF cable from the antenna port to the spectrum analyzer.
2. Set the spectrum analyzer as RBW = 1MHz, VBW = 3MHz, Span = Sweep= AUTO
3. Record the max. reading.
4. Repeat the above procedure until the measurements for all frequencies are completed

TEST RESULTS

No non-compliance noted

Test Data

Test mode: IEEE 802.11a mode / 5180 ~ 5240MHz

Channel	Frequency (MHz)	PPSD (dBm)	PPSD E.I.R.P (dBm)	IC E.I.R.P limit (dBm)	FCC limit (dBm)
Low	5180	4.77	6.65	10.00	11.00
Mid	5220	4.77	6.65	10.00	11.00
High	5240	4.81	6.69	10.00	11.00

Test mode: IEEE 802.11n HT 20 MHz mode / 5180 ~ 5240MHz

Channel	Frequency (MHz)	Chain 0 PPSD (dBm)	Chain 1 PPSD (dBm)	PPSD (dBm)	PPSD E.I.R.P (dBm)	IC E.I.R.P limit (dBm)	FCC limit (dBm)
Low	5180	5.20	5.04	8.13	9.10	10.00	11.00
Mid	5220	4.47	5.68	8.13	9.10	10.00	11.00
High	5240	4.41	5.52	8.01	8.98	10.00	11.00

Test mode: IEEE 802.11n HT 40 MHz mode / 5190 ~ 5230MHz

Channel	Frequency (MHz)	Chain 0 PPSD (dBm)	Chain 1 PPSD (dBm)	PPSD (dBm)	PPSD E.I.R.P (dBm)	IC E.I.R.P limit (dBm)	FCC limit (dBm)
Low	5190	0.81	1.46	4.16	5.13	10.00	11.00
High	5230	0.25	1.25	3.79	4.76	10.00	11.00

Remark:

1. Total PPSD (dBm) = $10 * \text{LOG}(10^{(\text{Chain 0 PPSD} / 10)} + 10^{(\text{Chain 1 PPSD} / 10)})$

Test mode: IEEE 802.11a mode/ 5260 ~ 5320MHz

Channel	Frequency (MHz)	PPSD (dBm)	IC/FCC Limit (dBm)
Low	5260	5.79	11.00
Mid	5280	5.42	11.00
High	5320	5.65	11.00

Test mode: IEEE 802.11n HT 20 MHz mode / 5260 ~ 5320MHz

Channel	Frequency (MHz)	Chain 0 PPSD (dBm)	Chain 1 PPSD (dBm)	PPSD (dBm)	IC/FCC Limit (dBm)
Low	5260	4.81	5.49	8.17	11.00
Mid	5280	4.81	5.43	8.14	11.00
High	5320	4.86	5.09	7.99	11.00

Test mode: IEEE 802.11n HT 40 MHz mode / 5270 ~ 5310MHz

Channel	Frequency (MHz)	Chain 0 PPSD (dBm)	Chain 1 PPSD (dBm)	PPSD (dBm)	IC/FCC Limit (dBm)
Low	5270	-0.07	1.33	3.70	11.00
High	5310	0.20	0.61	3.42	11.00

Remark:

1. Total PPSD (dBm) = $10 * \text{LOG}(10^{(\text{Chain 0 PPSD} / 10)} + 10^{(\text{Chain 1 PPSD} / 10)})$

Test mode: IEEE 802.11a mode / 5500 ~ 5700MHz

Channel	Frequency (MHz)	PPSD (dBm)	IC/FCC Limit (dBm)
Low	5500	5.46	11.00
Mid	5580	5.49	11.00
High	5700	4.63	11.00

Test mode: IEEE 802.11n HT 20 MHz mode / 5500 ~ 5700MHz

Channel	Frequency (MHz)	Chain 0 PPSD (dBm)	Chain 1 PPSD (dBm)	PPSD (dBm)	IC/FCC Limit (dBm)
Low	5500	4.43	5.28	7.89	11.00
Mid	5580	5.07	5.53	8.32	11.00
High	5700	4.90	5.85	8.41	11.00

Test mode: IEEE 802.11n HT 40 MHz mode / 5510 ~ 5670MHz

Channel	Frequency (MHz)	Chain 0 PPSD (dBm)	Chain 1 PPSD (dBm)	PPSD (dBm)	IC/FCC Limit (dBm)
Low	5510	0.48	1.02	3.77	11.00
Mid	5550	0.77	1.13	3.96	11.00
High	5670	-0.19	1.13	3.53	11.00

Remark:

1. Total PPSD (dBm) = $10 * \text{LOG}(10^{(\text{Chain 0 PPSD} / 10)} + 10^{(\text{Chain 1 PPSD} / 10)})$

Test Plot

IEEE 802.11a mode / 5180 ~ 5240MHz

CH Low



Date: 8 SEP 2016 16:00:04

CH Mid



Date: 8 SEP 2016 16:06:20

CH High



Date: 8 SEP 2016 16:15:52

IEEE 802.11n HT 20 MHz mode / 5180 ~ 5240MHz / Chain 0

CH Low



Date: 20 SEP 2016 13:51:52

CH Mid



Date: 20 SEP 2016 14:09:46

CH High



Date: 20 SEP 2016 14:06:24

IEEE 802.11n HT 20 MHz mode / 5180 ~ 5240MHz / Chain 1

CH Low



Date: 20 SEP 2016 13:59:49

CH Mid



Date: 20 SEP 2016 14:14:50

CH High



Date: 20 SEP 2016 14:13:02

IEEE 802.11n HT 40 MHz mode / 5190 ~ 5230MHz / Chain 0

CH Low

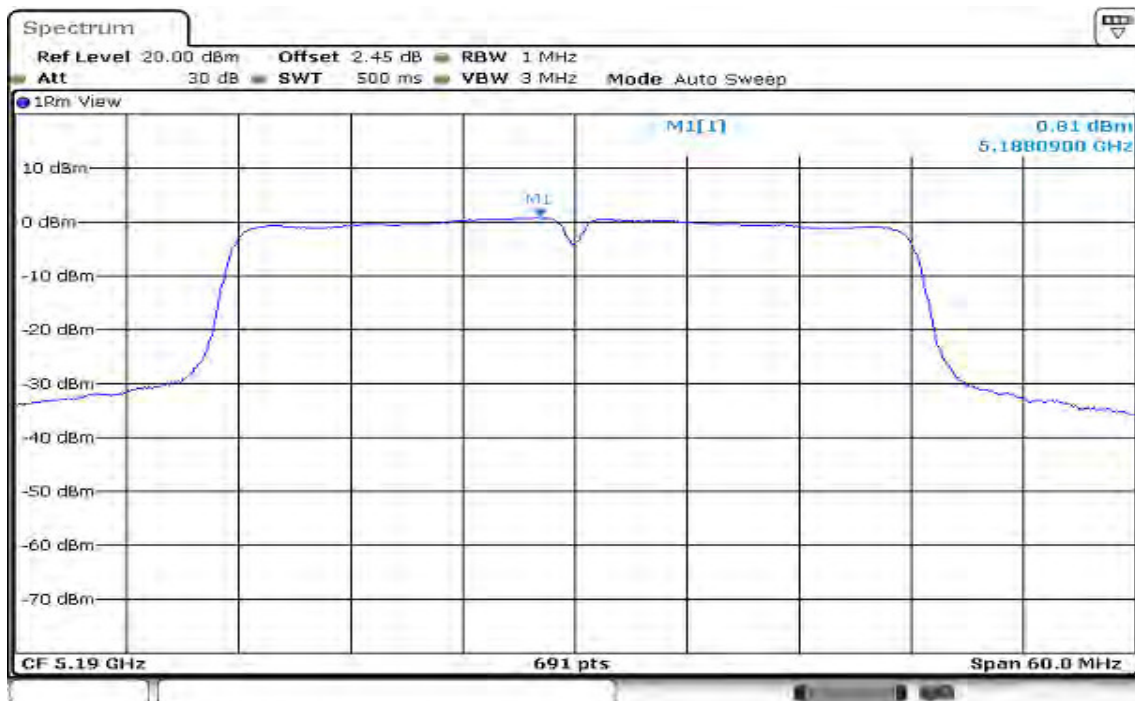

CH High



IEEE 802.11a mode / 5260 ~ 5320MHz

CH Low

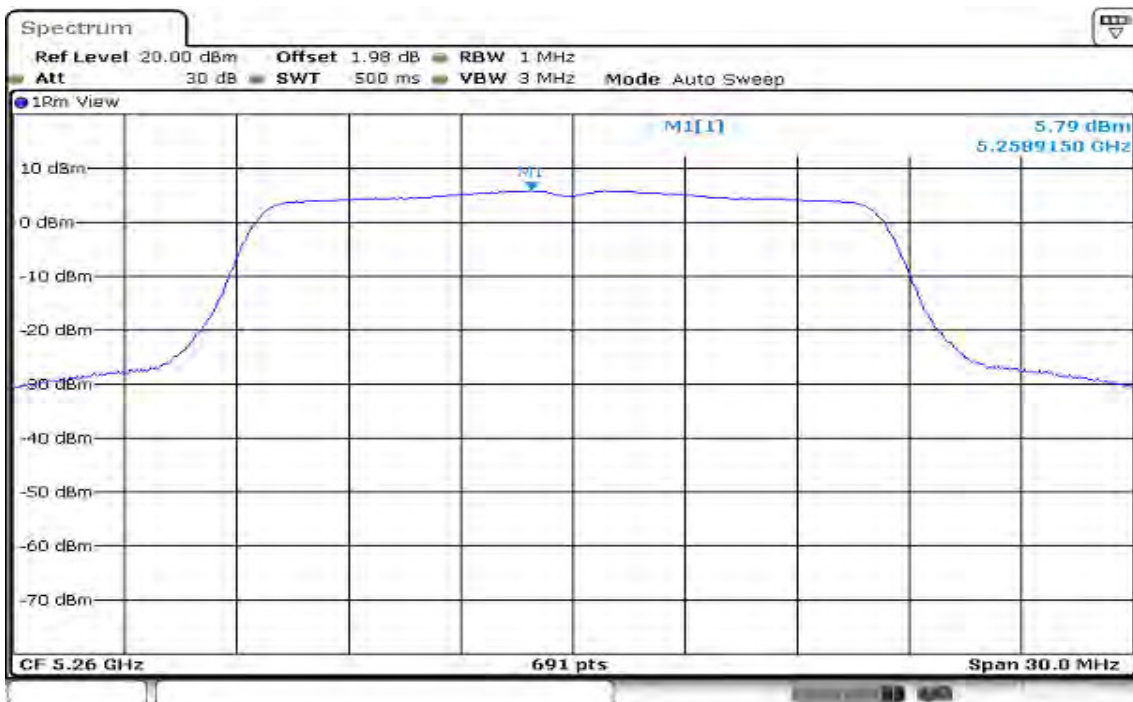

Date: 12 SEP 2016 09:38:24

CH Mid



Date: 12 SEP 2016 09:49:26

CH High



Date: 12 SEP 2016 09:55:45

IEEE 802.11n HT 20 MHz mode / 5260 ~ 5320MHz/ Chain 0

CH Low



Date: 20 SEP 2016 10:55:04

CH Mid



Date: 20 SEP 2016 11:22:42

CH High



Date: 20 SEP 2016 11:25:48

IEEE 802.11n HT 20 MHz mode / 5260 ~ 5320MHz/ Chain 1

CH Low



Date: 20 SEP 2016 11:18:46

CH Mid



Date: 20 SEP 2016 11:21:09

CH High



Date: 20 SEP 2016 11:28:44

IEEE 802.11n HT 40 MHz mode / 5270 ~ 5310MHz/ Chain 0

CH Low

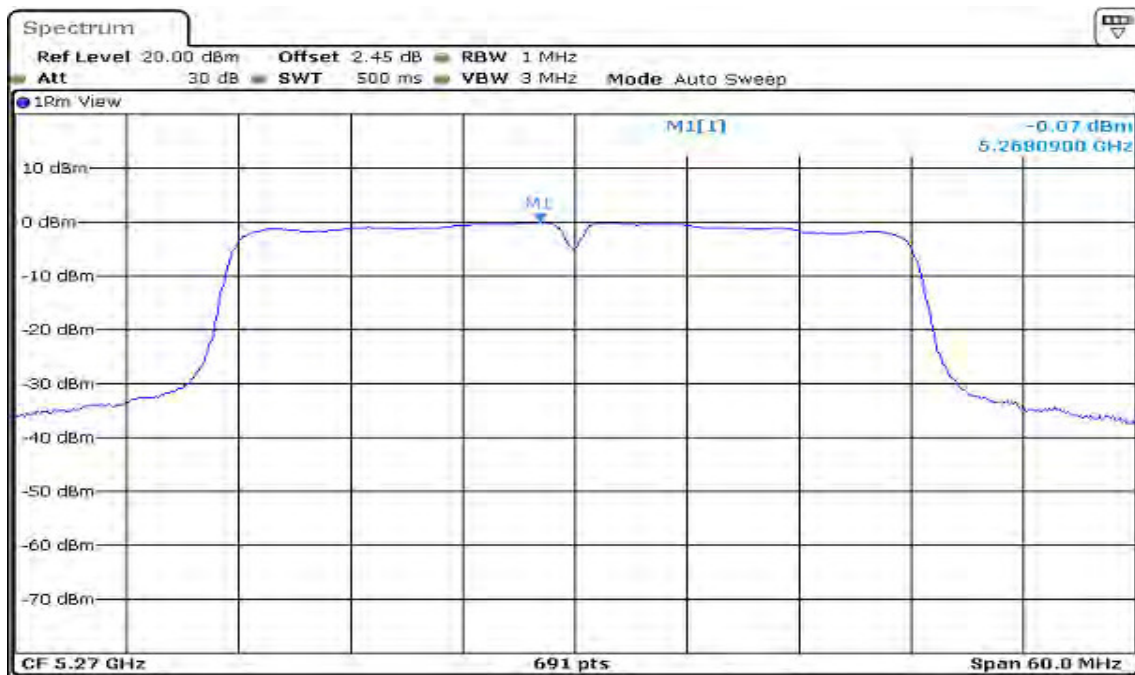

Date: 20 SEP 2016 11:22:19

CH High

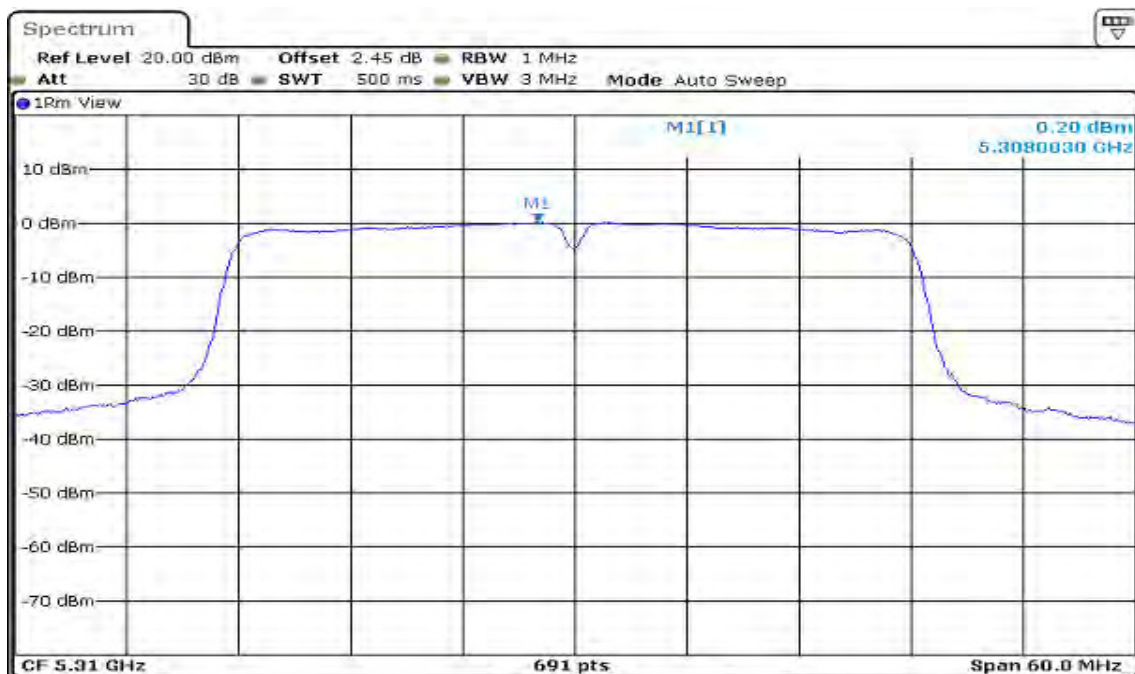

Date: 20 SEP 2016 11:24:13

IEEE 802.11n HT 40 MHz mode / 5270 ~ 5310MHz/ Chain 1

CH Low



Date: 20 SEP 2016 11:30:57

CH High



Date: 20 SEP 2016 11:36:40

Test mode: IEEE 802.11a mode / 5500 ~ 5700MHz

CH Low



Date: 12 SEP 2016 10:52:19

CH Mid



Date: 12 SEP 2016 10:55:05

CH High

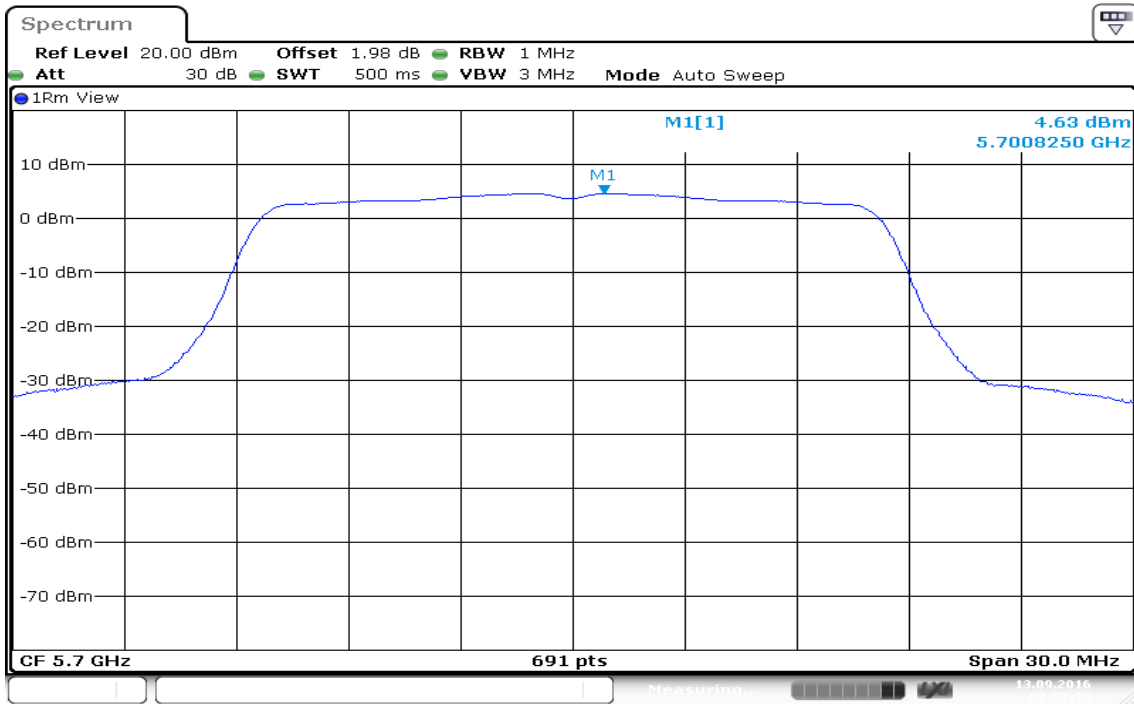

Date: 13.SEP.2016 09:52:39

IEEE 802.11n HT 20 MHz mode / 5500 ~ 5700MHz/ Chain 0

CH Low



Date: 20 SEP 2016 11:43:22

CH Mid



Date: 20 SEP 2016 11:54:49

CH High



Date: 20 SEP 2016 13:10:24

IEEE 802.11n HT 20 MHz mode / 5500 ~ 5700MHz/ Chain 1

CH Low



Date: 20 SEP 2016 11:41:10

CH Mid



Date: 20 SEP 2016 11:51:38

CH High



Date: 20 SEP 2016 13:11:52

IEEE 802.11n HT 40 MHz mode / 5510 ~ 5670MHz / Chain 0

CH Low

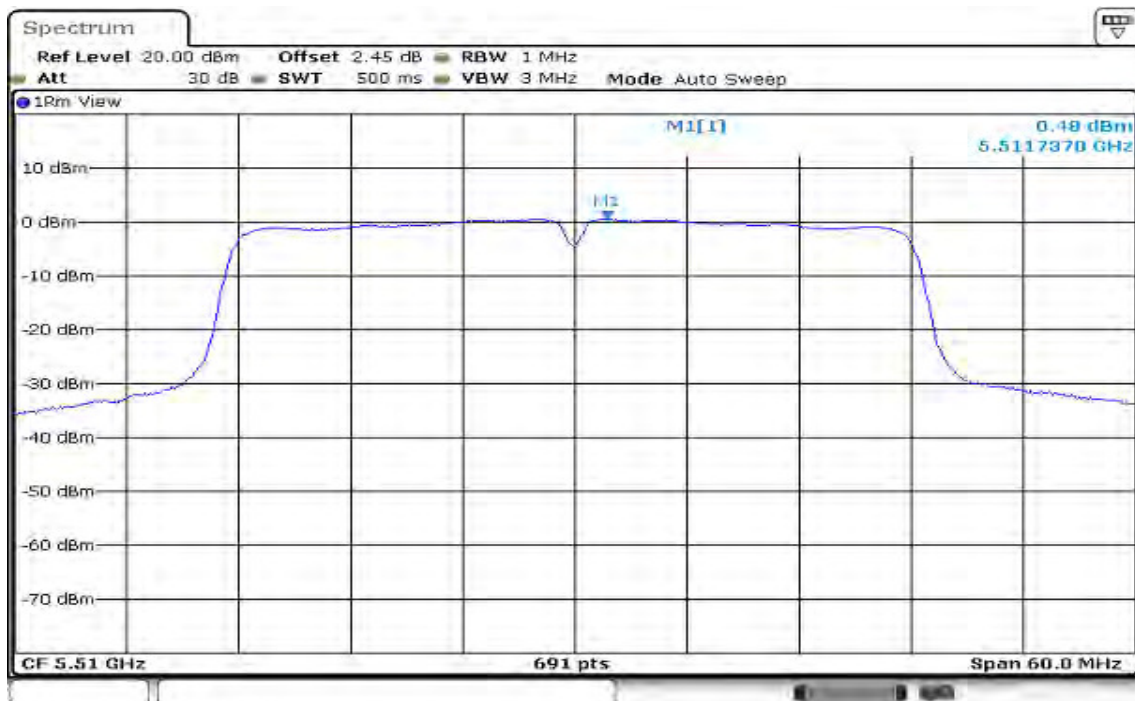

Date: 20 SEP 2016 13:15:45

CH Mid



Date: 20 SEP 2016 13:17:39

CH High

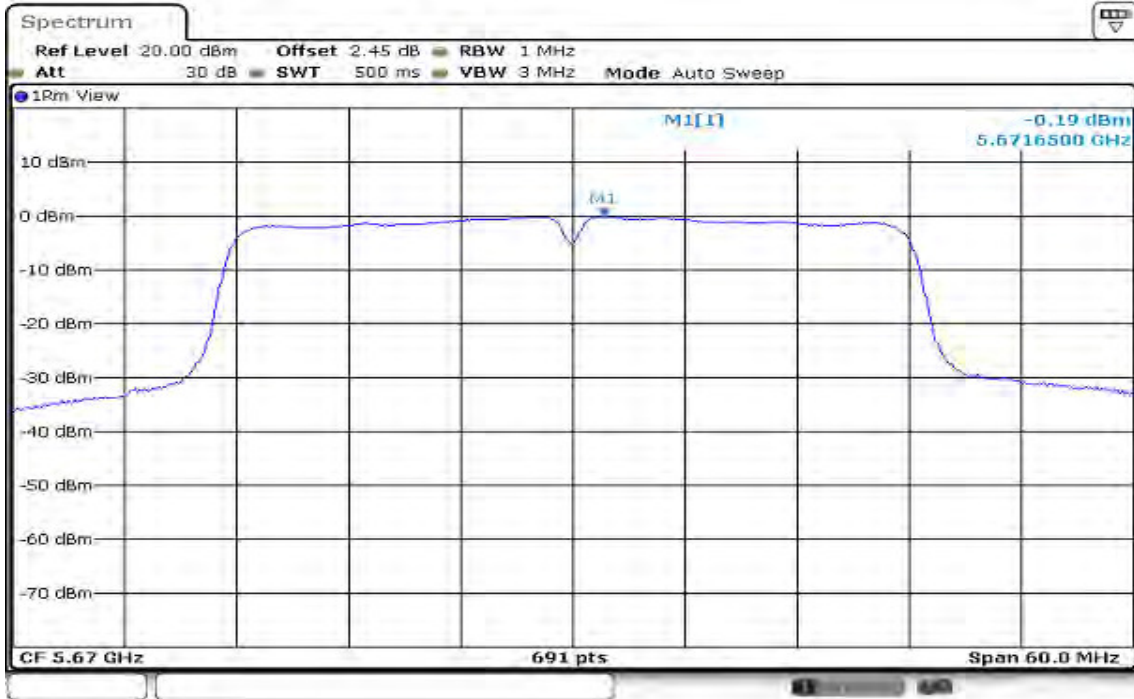

Date: 20 SEP 2016 13:28:29

IEEE 802.11n HT 40 MHz mode / 5510 ~ 5670MHz / Chain 1

CH Low



Date: 20 SEP 2016 13:14:11

CH Mid



Date: 20 SEP 2016 13:20:26

CH High

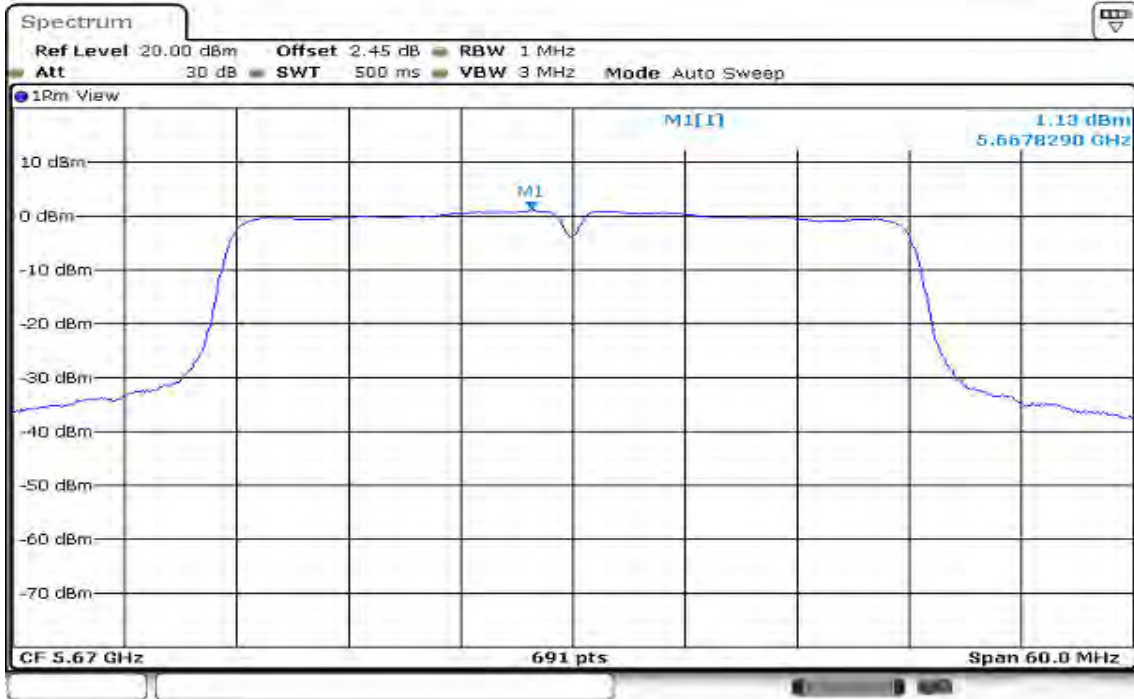

Date: 20 SEP 2016 13:26:50

7.6 RADIATED UNDESIRABLE EMISSION

Limit

All spurious emissions shall comply with the limits of §15.209(a) and RSS-Gen Table 2 & Table 4.

RSS-Gen Table 2 & Table 4: General Field Strength Limits for Transmitters and Receivers at Frequencies Above 30 MHz ^(Note)

Frequency (MHz)	Field Strength microvolts/m at 3 metres (watts, e.i.r.p.)	
	Transmitters	Receivers
30-88	100 (3 nW)	100 (3 nW)
88-216	150 (6.8 nW)	150 (6.8 nW)
216-960	200 (12 nW)	200 (12 nW)
Above 960	500 (75 nW)	500 (75 nW)

Note: *Measurements for compliance with limits in the above table may be performed at distances other than 3 metres, in accordance with Section 6.5.

Transmitting devices are not permitted in Table 1 bands or, unless stated otherwise, in TV bands (54-72 MHz, 76-88 MHz, 174-216 MHz, 470-608 MHz and 614-806 MHz).

RSS-Gen Table 5: General Field Strength Limits for Transmitters at Frequencies Below 30 MHz (Transmit)

Frequency	Field Strength (microvolts/m)	Magnetic H-Field (microamperes/m)	Measurement Distance (metres)
9-490 kHz	2,400/F (F in kHz)	2,400/377F (F in kHz)	3000
490-1,705 kHz	24,000/F (F in kHz)	24,000/377F (F in kHz)	30
1.705-30 MHz	30	N/A	30

Note: The emission limits for the bands 9-90 kHz and 110-490 kHz are based on measurements employing an average detector.

Test Configuration

9kHz ~ 30MHz

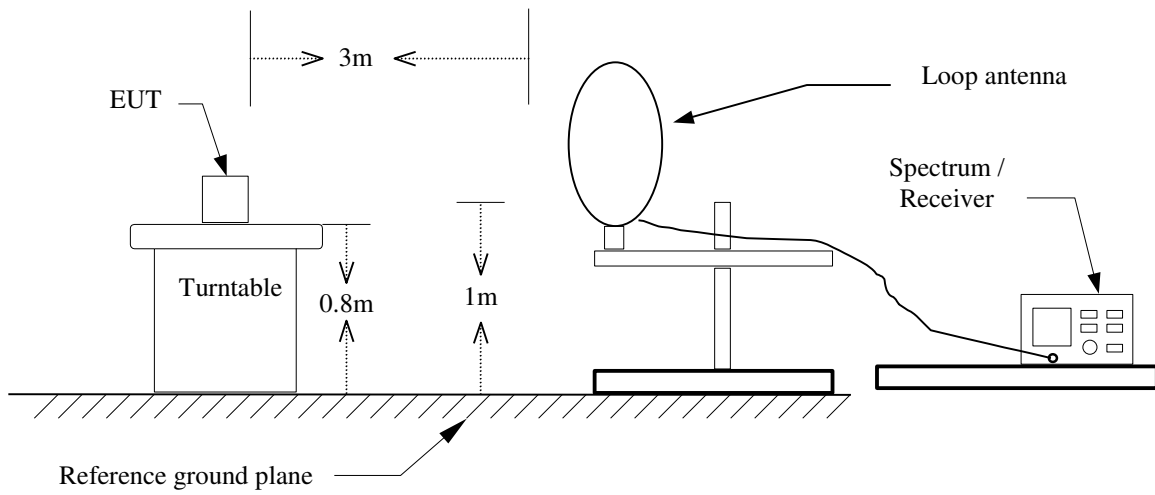

30MHz ~ 1GHz

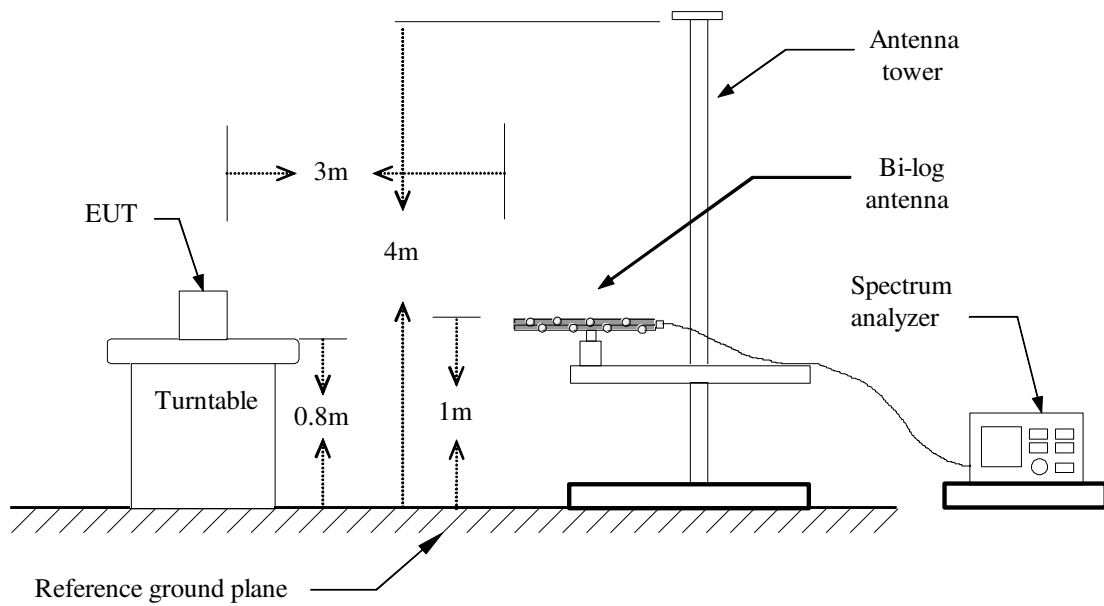

Above 1 GHz

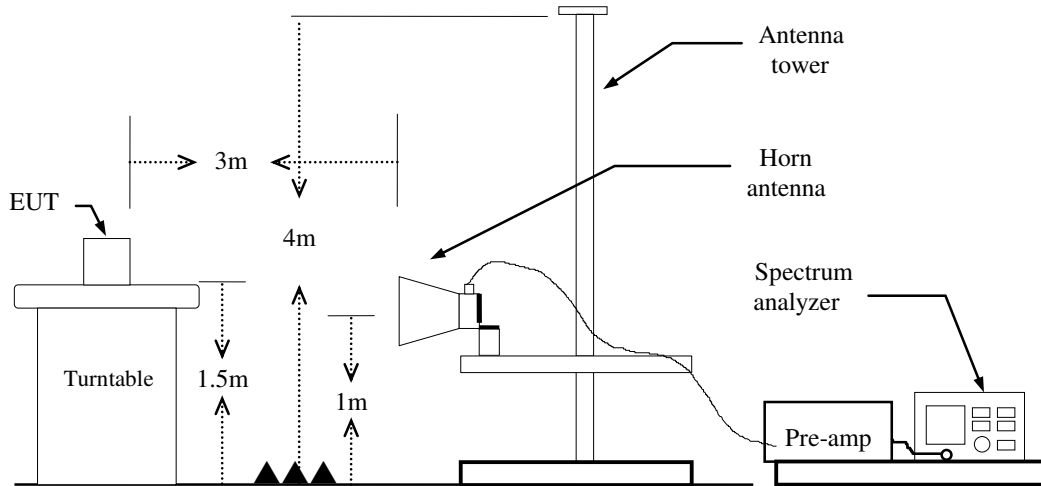

TEST PROCEDURE

1. The EUT is placed on a turntable, Above 1 GHz is 1.5m high and below 1 GHz is 0.8m high above ground plane.
2. The turntable shall be rotated for 360 degrees to determine the position of maximum emission level.
3. EUT is set 3m away from the receiving antenna, which is varied from 1m to 4m to find out the highest emissions.
4. Maximum procedure was performed on the six highest emissions to ensure EUT compliance.
5. And also, each emission was to be maximized by changing the polarization of receiving antenna both horizontal and vertical.
6. Set the spectrum analyzer in the following setting as:

Below 1GHz:

RBW=100kHz / VBW=300kHz / Sweep=AUTO

Above 1GHz:

(a) PEAK: RBW=VBW=1MHz / Sweep=AUTO

(b) AVERAGE: RBW=1MHz,
if duty cycle $\geq 98\%$, VBW=10Hz.

if duty cycle $< 98\%$ VBW=1/T.

IEEE 802.11a mode: =89%, VBW=750Hz

IEEE 802.11n HT 20 MHz mode: =88%, VBW=750Hz

IEEE 802.11n HT 40 MHz mode: =79%, VBW=1.5KHz

7. Repeat above procedures until the measurements for all frequencies are complete.
8. Result = Spectrum Reading + cable loss(spectrum to Amp) - Amp Gain + Cable loss(Amp to receive Ant)+ Receive Ant

Note: We checked every harmonics frequencies from Fundamental frequencies with reduced VBW, and we mark a point to prove pass or not if we find any emission. For this case, there are no emissions hidden in the noise floor.

Below 1 GHz

Operation Mode: Normal Link

Test Date: September 13, 2016

Temperature: 27°C

Tested by: Dennis Li

Humidity: 53% RH

Polarity: Ver. / Hor.

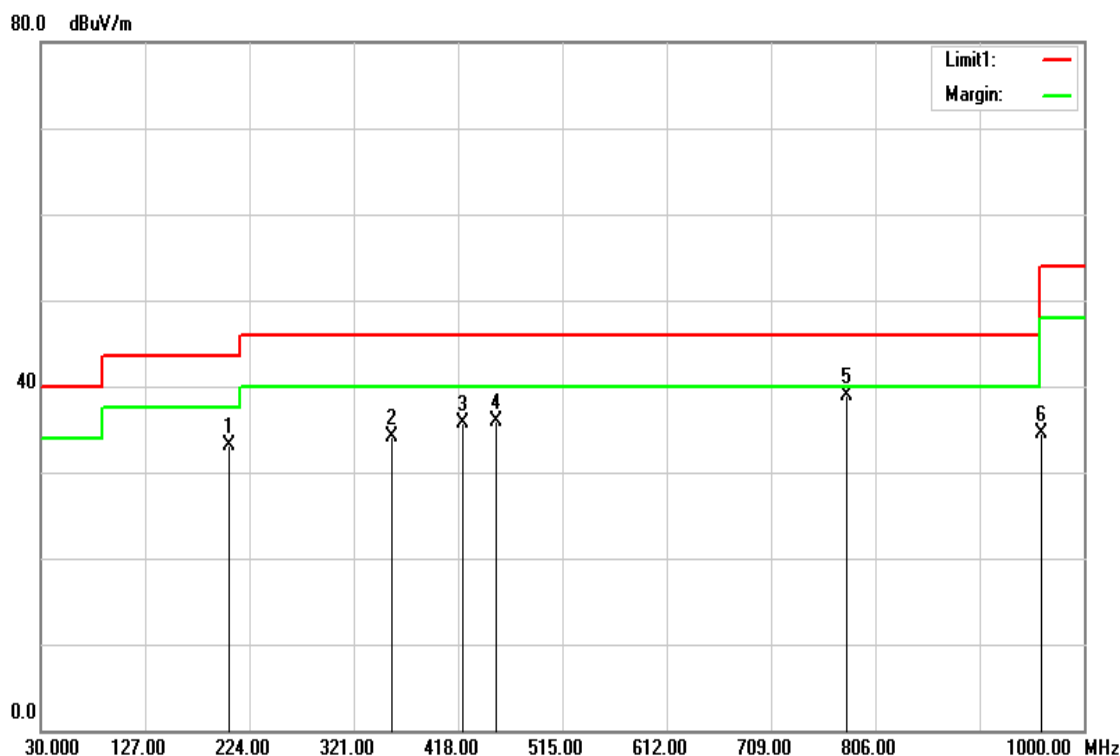

Frequency (MHz)	Reading (dBuV)	Correction Factor (dB/m)	Result (dBuV/m)	Limit (dBuV/m)	Margin (dB)	Remark	Ant.Pol. (H/V)
205.5700	49.12	-15.94	33.18	43.50	-10.32	peak	V
356.8900	46.74	-12.73	34.01	46.00	-11.99	peak	V
421.8800	46.74	-11.04	35.70	46.00	-10.30	peak	V
452.9200	46.08	-10.13	35.95	46.00	-10.05	QP	V
779.8100	43.62	-4.67	38.95	46.00	-7.05	peak	V
960.2300	36.70	-2.23	34.47	54.00	-19.53	peak	V

Remark:

- 1 Measuring frequencies from 30 MHz to the 1GHz.
- 2 Radiated emissions measured in frequency range from 30 MHz to 1000MHz were made with an instrument using peak/quasi-peak detector mode.
- 3 Quasi-peak test would be performed if the peak result were greater than the quasi-peak limit or as required by the applicant.
- 4 Measurements above show only up to 6 maximum emissions noted, or would be lesser, with " N/A " remark, if no specific emissions from the EUT are recorded (ie: margin>20dB from the applicable limit) and considered that's already beyond the background noise floor.
- 5 Margin (dB) = Remark result (dBuV/m) – Quasi-peak limit (dBuV/m).

Operation Mode: Normal Link

Test Date: September 13, 2016

Temperature: 27°C

Tested by: Dennis Li

Humidity: 53% RH

Polarity: Hor.

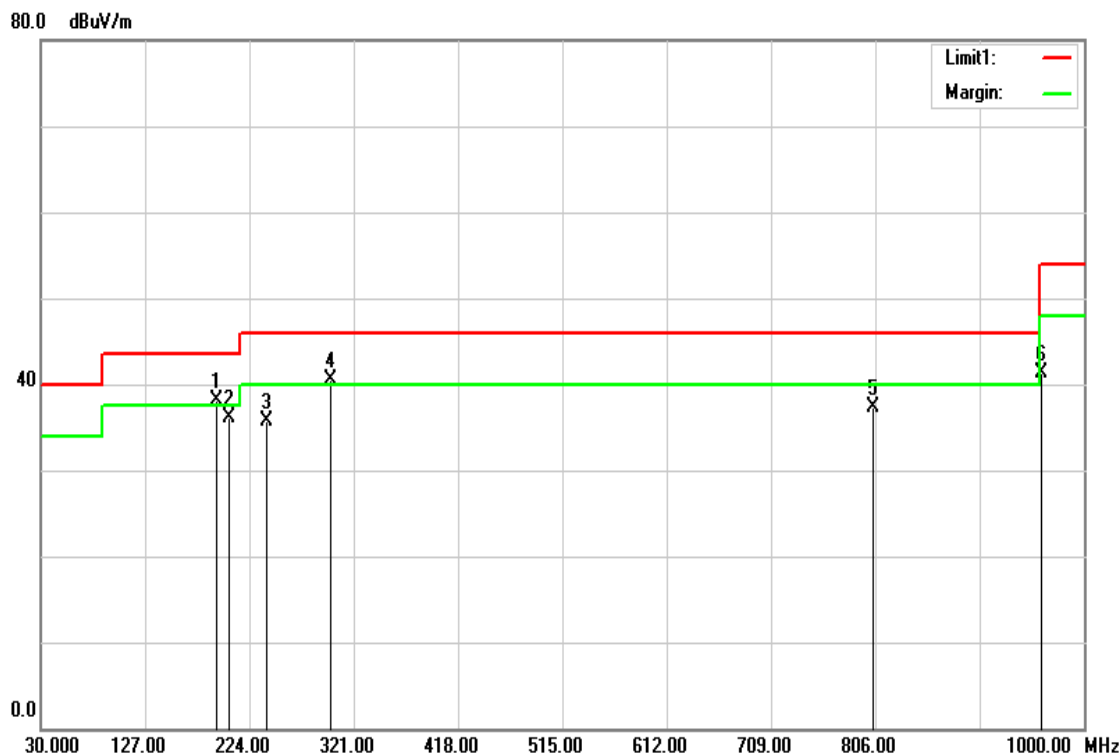

Frequency (MHz)	Reading (dBuV)	Correction Factor (dB/m)	Result (dBuV/m)	Limit (dBuV/m)	Margin (dB)	Remark	Ant.Pol. (H/V)
193.9300	54.27	-16.09	38.18	43.50	-5.32	QP	H
205.5700	52.12	-15.94	36.18	43.50	-7.32	QP	H
239.5200	52.18	-16.52	35.66	46.00	-10.34	QP	H
299.6600	54.78	-14.25	40.53	46.00	-5.47	QP	H
804.0600	41.74	-4.44	37.30	46.00	-8.70	QP	H
960.2300	43.45	-2.23	41.22	54.00	-12.78	peak	H

Remark:

1. No emission found between lowest internal used/generated frequency to 30MHz (9kHz~30MHz).
2. Radiated emissions measured in frequency range from 30 MHz to 1000MHz were made with an instrument using peak/quasi-peak detector mode.
3. Quasi-peak test would be performed if the peak result were greater than the quasi-peak limit or as required by the applicant.
4. Measurements above show only up to 6 maximum emissions noted, or would be lesser, with " N/A " remark, if no specific emissions from the EUT are recorded (ie: margin>20dB from the applicable limit) and considered that's already beyond the background noise floor.
5. Margin (dB) = Remark result (dBuV/m) – Quasi-peak limit (dBuV/m).

Above 1 GHz

U-NII-1

Tx / IEEE 802.11a mode / CH Low

Polarity: Vertical

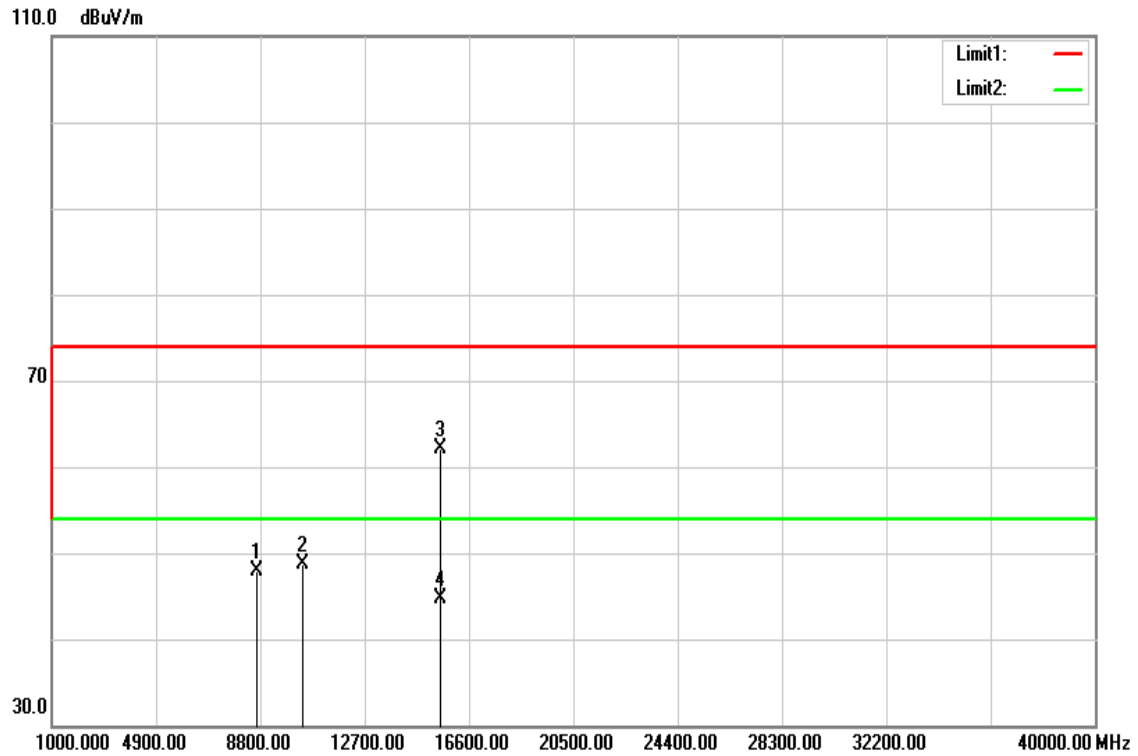

Polarity: Horizontal

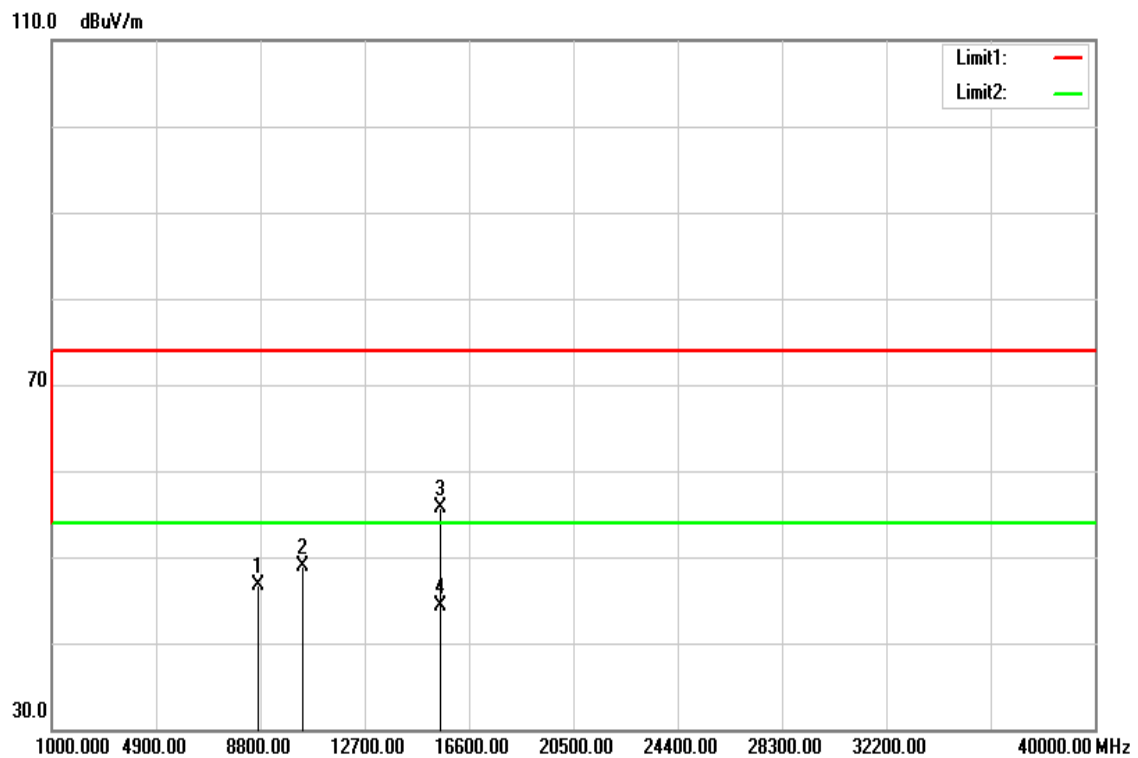

Operation Mode: Tx / IEEE 802.11a mode / CH Low

Test Date: September 8, 2016

Temperature: 27°C

Tested by: Dennis Li

Humidity: 53% RH

Polarity: Ver. / Hor.

Frequency (MHz)	Reading (dBuV)	Correction (dB/m)	Result (dBuV/m)	Limit (dBuV/m)	Margin (dB)	Remark	Ant.Pol. (H/V)
8670.000	33.75	14.11	47.86	74.00	-26.14	peak	V
10360.000	32.17	16.51	48.68	74.00	-25.32	peak	V
15540.000	42.31	19.84	62.15	74.00	-11.85	peak	V
15540.000	24.96	19.84	44.80	54.00	-9.20	AVG	V
N/A							
8740.000	32.51	14.20	46.71	74.00	-27.29	peak	H
10360.000	32.48	16.51	48.99	74.00	-25.01	peak	H
15540.000	35.84	19.84	55.68	74.00	-18.32	peak	H
15540.000	24.42	19.84	44.26	54.00	-9.74	AVG	H
N/A							

Remark:

1. Measuring frequencies from 1 GHz to the 10th harmonic of highest fundamental frequency.
2. Radiated emissions measured in frequency above 1000MHz were made with an instrument using peak/average detector mode.
3. Average test would be performed if the peak result were greater than the average limit.
4. Data of measurement within this frequency range shown " --- " in the table above means the reading of emissions are attenuated more than 20dB below the permissible limits or the field strength is too small to be measured.
5. Measurements above show only up to 6 maximum emissions noted, or would be lesser, with " N/A " remark, if no specific emissions from the EUT are recorded (ie: margin>20dB from the applicable limit) and considered that's already beyond the background noise floor.
6. Margin (dB) = Remark result (dBuV/m) – Average limit (dBuV/m).

Tx / IEEE 802.11a mode / CH Mid

Polarity: Vertical

110.0 dBuV/m

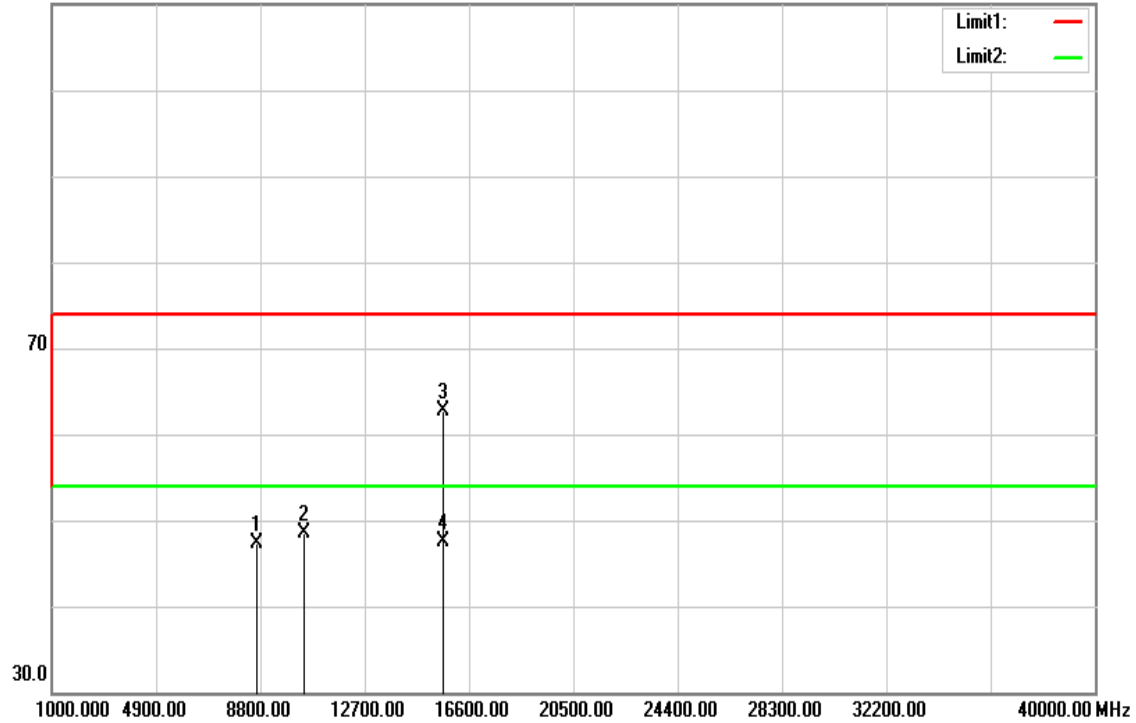

Polarity: Horizontal

110.0 dBuV/m

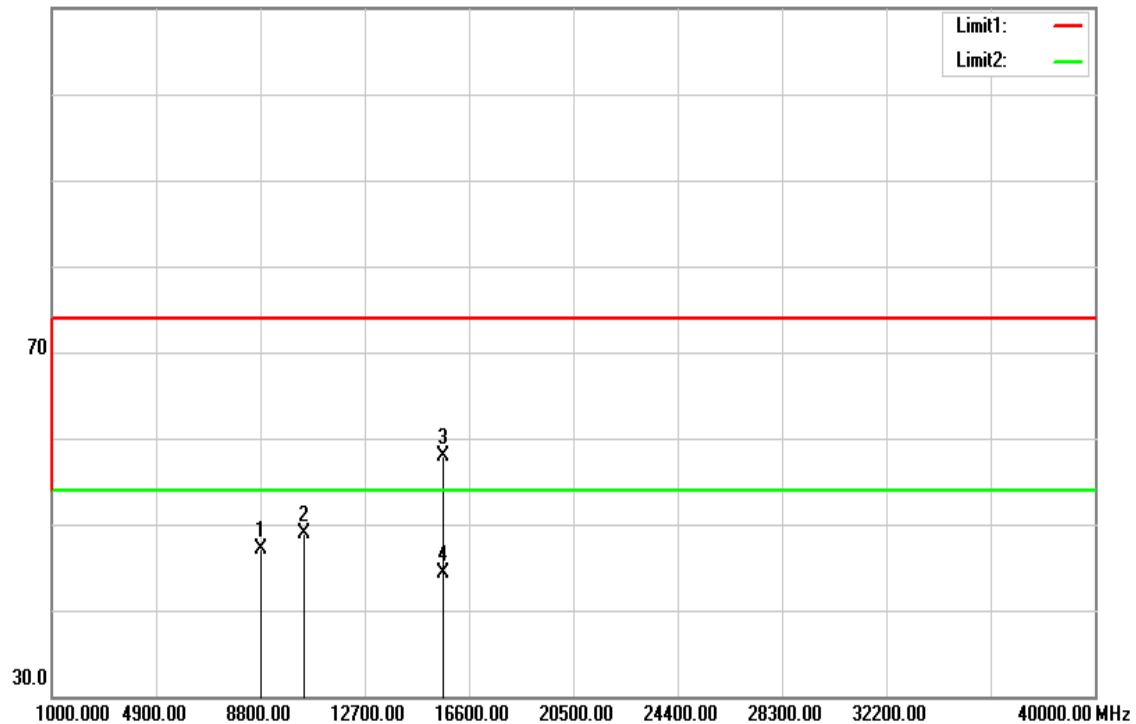

Operation Mode: Tx / IEEE 802.11a mode / CH Mid

Test Date: September 8, 2016

Temperature: 27°C

Tested by: Dennis Li

Humidity: 53% RH

Polarity: Ver. / Hor.

Frequency (MHz)	Reading (dBuV)	Correction (dB/m)	Result (dBuV/m)	Limit (dBuV/m)	Margin (dB)	Remark	Ant.Pol. (H/V)
8690.000	33.10	14.14	47.24	74.00	-26.76	peak	V
10440.000	31.83	16.66	48.49	74.00	-25.51	peak	V
15660.000	42.52	20.23	62.75	74.00	-11.25	peak	V
15660.000	27.32	20.23	47.55	54.00	-6.45	AVG	V
N/A							
8850.000	32.72	14.34	47.06	74.00	-26.94	peak	H
10440.000	32.22	16.66	48.88	74.00	-25.12	peak	H
15660.000	37.62	20.23	57.85	74.00	-16.15	peak	H
15660.000	24.05	20.23	44.28	54.00	-9.72	AVG	H
N/A							

Remark:

1. Measuring frequencies from 1 GHz to the 10th harmonic of highest fundamental frequency.
2. Radiated emissions measured in frequency above 1000MHz were made with an instrument using peak/average detector mode.
3. Average test would be performed if the peak result were greater than the average limit.
4. Data of measurement within this frequency range shown “ --- ” in the table above means the reading of emissions are attenuated more than 20dB below the permissible limits or the field strength is too small to be measured.
5. Measurements above show only up to 6 maximum emissions noted, or would be lesser, with “ N/A ” remark, if no specific emissions from the EUT are recorded (ie: margin>20dB from the applicable limit) and considered that's already beyond the background noise floor.
6. Margin (dB) = Remark result (dBuV/m) – Average limit (dBuV/m).

Tx / IEEE 802.11a mode / CH High

Polarity: Vertical

110.0 dBuV/m

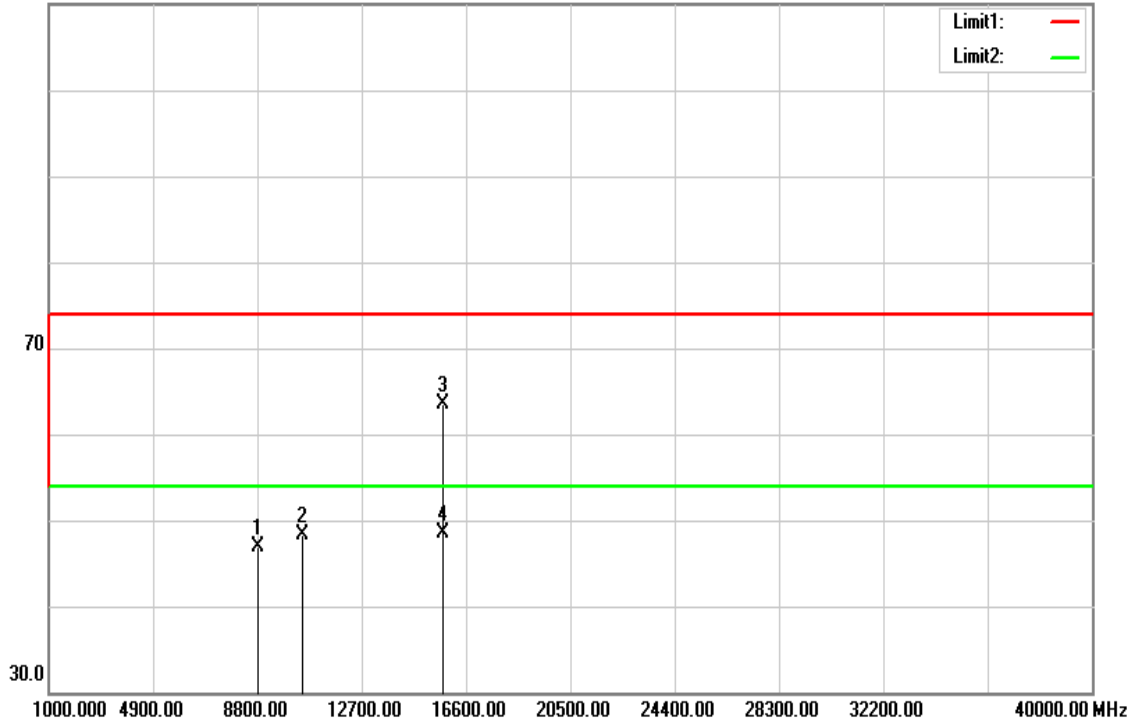

Polarity: Horizontal

110.0 dBuV/m

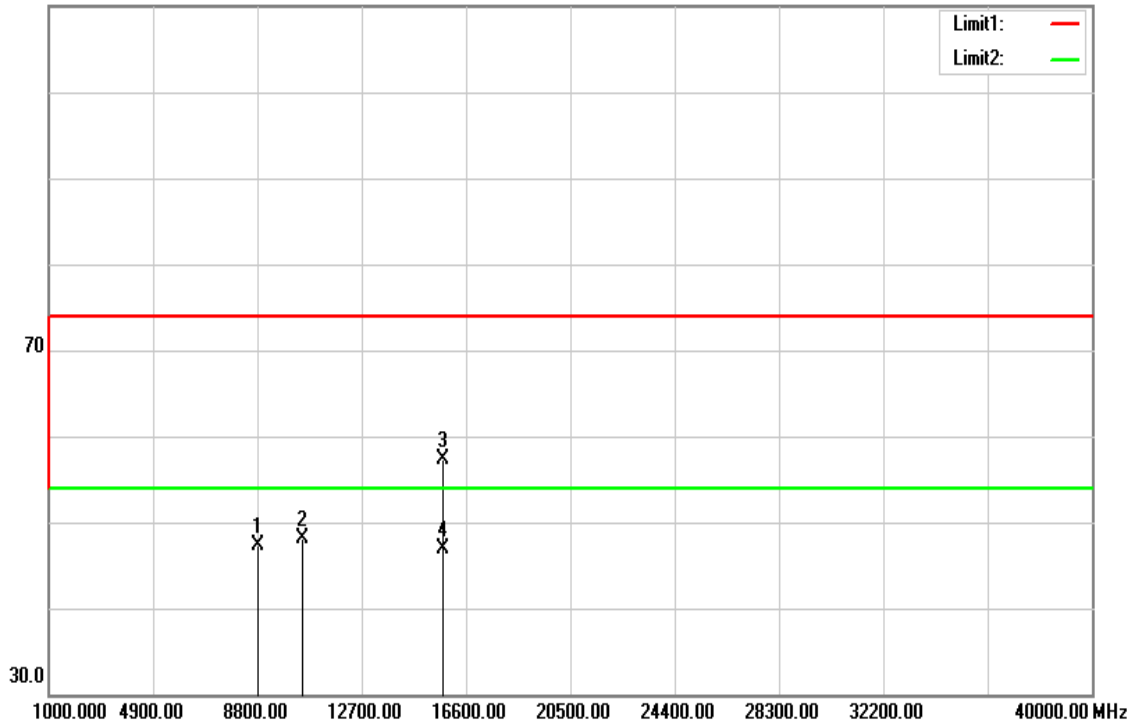

Operation Mode: Tx / IEEE 802.11a mode / CH High

Test Date: September 8, 2016

Temperature: 27°C

Tested by: Dennis Li

Humidity: 53% RH

Polarity: Ver. / Hor.

Frequency (MHz)	Reading (dBuV)	Correction (dB/m)	Result (dBuV/m)	Limit (dBuV/m)	Margin (dB)	Remark	Ant.Pol. (H/V)
8850.000	32.53	14.34	46.87	74.00	-27.13	peak	V
10480.000	31.66	16.73	48.39	74.00	-25.61	peak	V
15720.000	43.15	20.43	63.58	74.00	-10.42	peak	V
15720.000	27.99	20.43	48.42	54.00	-5.58	AVG	V
N/A							
8850.000	33.00	14.34	47.34	74.00	-26.66	peak	H
10480.000	31.45	16.73	48.18	74.00	-25.82	peak	H
15720.000	36.85	20.43	57.28	74.00	-16.72	peak	H
15720.000	26.42	20.43	46.85	54.00	-7.15	AVG	H
N/A							

Remark:

1. *Measuring frequencies from 1 GHz to the 10th harmonic of highest fundamental frequency.*
2. *Radiated emissions measured in frequency above 1000MHz were made with an instrument using peak/average detector mode.*
3. *Average test would be performed if the peak result were greater than the average limit.*
4. *Data of measurement within this frequency range shown “ --- ” in the table above means the reading of emissions are attenuated more than 20dB below the permissible limits or the field strength is too small to be measured.*
5. *Measurements above show only up to 6 maximum emissions noted, or would be lesser, with “ N/A ” remark, if no specific emissions from the EUT are recorded (ie: margin>20dB from the applicable limit) and considered that's already beyond the background noise floor.*
6. *Margin (dB) = Remark result (dBuV/m) – Average limit (dBuV/m).*

Tx / IEEE 802.11n HT 20 MHz mode / CH Low

Polarity: Vertical

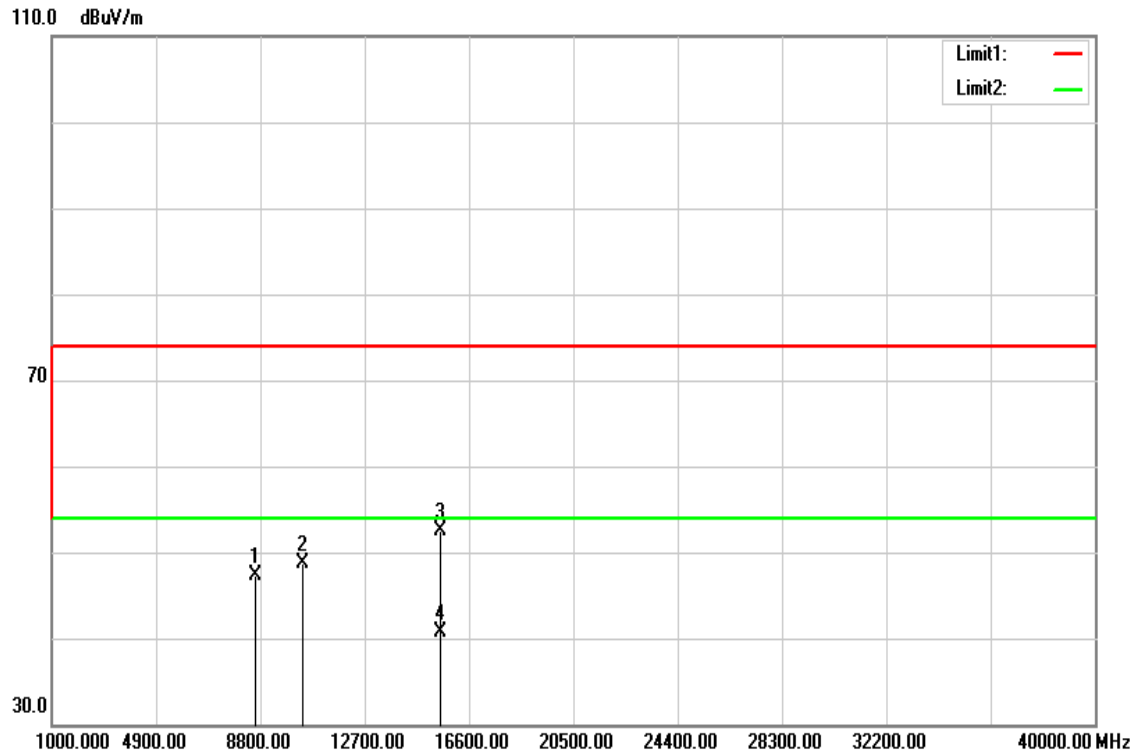

Polarity: Horizontal

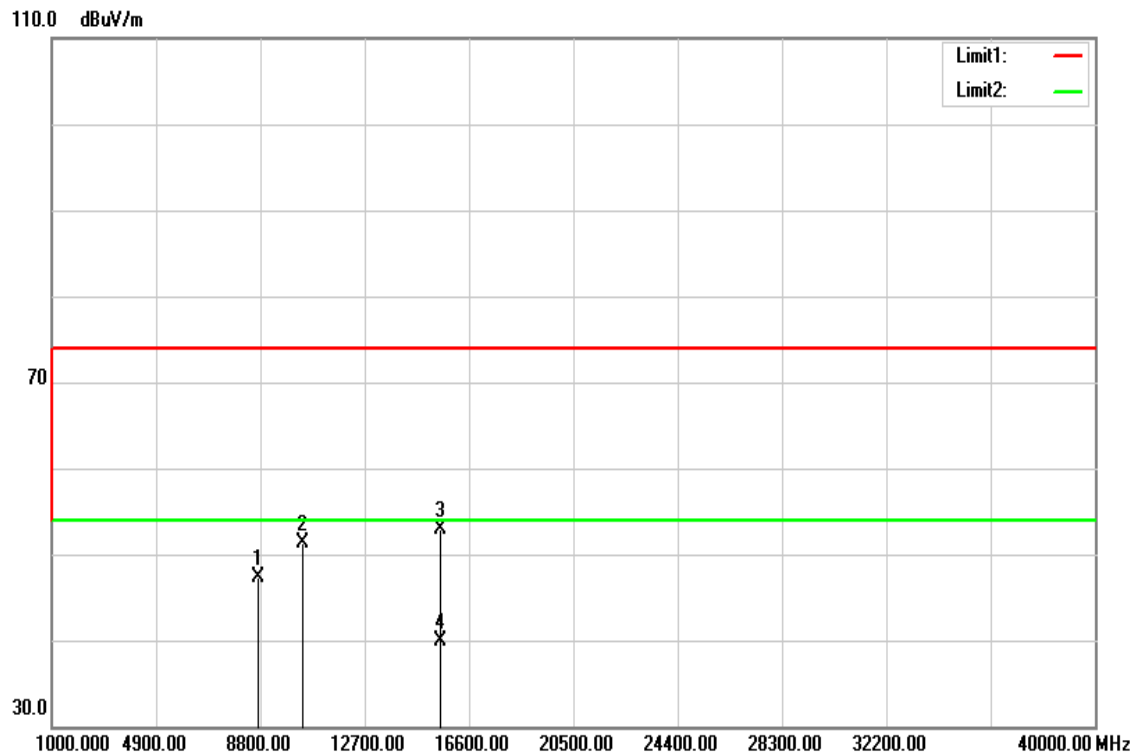

Operation Mode: Tx / IEEE 802.11n HT 20 MHz mode / CH Low **Test Date:** September 14, 2016

Temperature: 27°C

Tested by: Dennis Li

Humidity: 53% RH

Polarity: Ver. / Hor.

Frequency (MHz)	Reading (dBuV)	Correction (dB/m)	Result (dBuV/m)	Limit (dBuV/m)	Margin (dB)	Remark	Ant.Pol. (H/V)
8600.000	33.71	13.69	47.40	74.00	-26.60	peak	V
10360.000	32.14	16.52	48.66	74.00	-25.34	peak	V
15540.000	33.40	19.04	52.44	74.00	-21.56	peak	V
15540.000	21.73	19.04	40.77	54.00	-13.23	AVG	V
N/A							
8700.000	33.53	13.73	47.26	74.00	-26.74	peak	H
10360.000	34.75	16.52	51.27	74.00	-22.73	peak	H
15540.000	33.91	19.04	52.95	74.00	-21.05	peak	H
15540.000	20.86	19.04	39.90	54.00	-14.10	AVG	H
N/A							

Remark:

1. Measuring frequencies from 1 GHz to the 10th harmonic of highest fundamental frequency.
2. Radiated emissions measured in frequency above 1000MHz were made with an instrument using peak/average detector mode.
3. Average test would be performed if the peak result were greater than the average limit.
4. Data of measurement within this frequency range shown " --- " in the table above means the reading of emissions are attenuated more than 20dB below the permissible limits or the field strength is too small to be measured.
5. Measurements above show only up to 6 maximum emissions noted, or would be lesser, with " N/A " remark, if no specific emissions from the EUT are recorded (ie: margin>20dB from the applicable limit) and considered that's already beyond the background noise floor.
6. Margin (dB) = Remark result (dBuV/m) – Average limit (dBuV/m).

Tx / IEEE 802.11n HT 20 MHz mode / CH Mid

Polarity: Vertical

110.0 dBuV/m

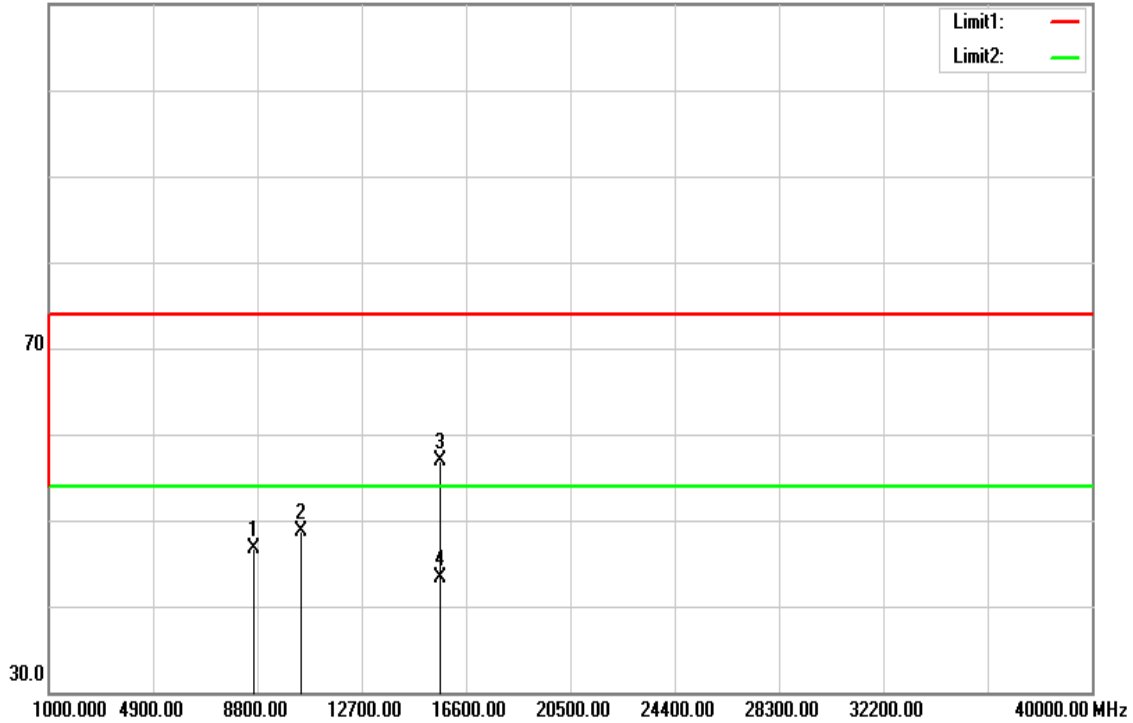

Polarity: Horizontal

110.0 dBuV/m

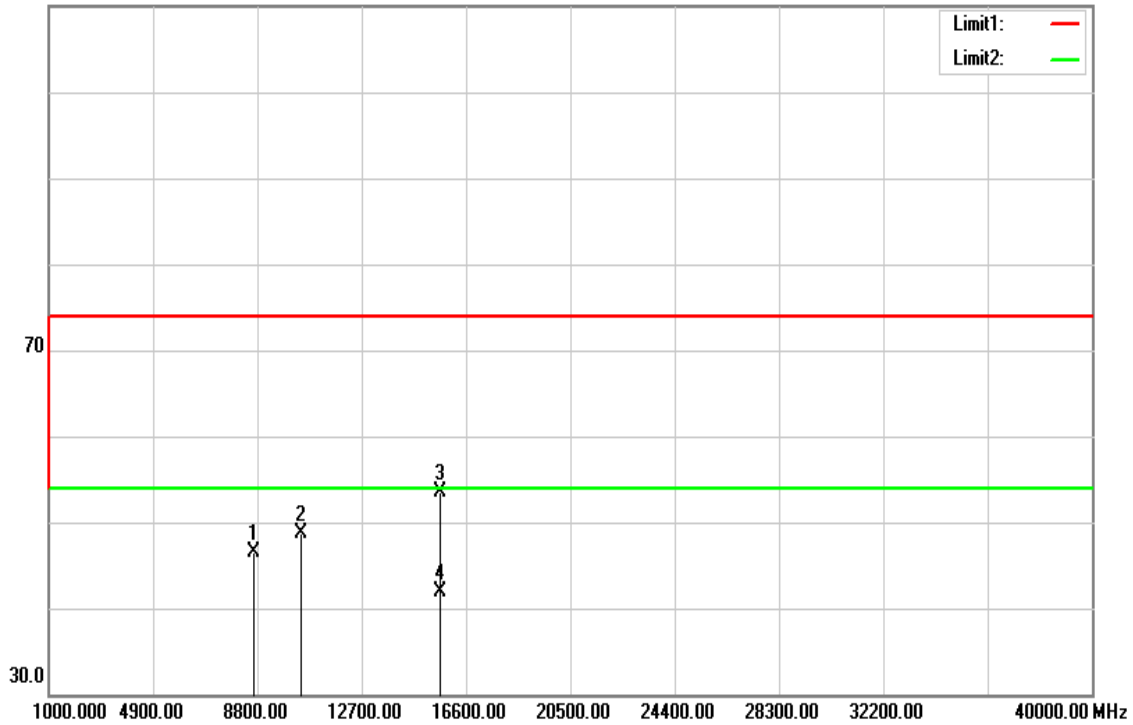

Operation Mode:Tx / IEEE 802.11n HT 20 MHz mode / CH Mid**Test Date:** September 14, 2016

Temperature: 27°C

Tested by:Dennis Li

Humidity: 53% RH

Polarity: Ver. / Hor.

Frequency (MHz)	Reading (dBuV)	Correction (dB/m)	Result (dBuV/m)	Limit (dBuV/m)	Margin (dB)	Remark	Ant.Pol. (H/V)
8650.000	33.08	13.71	46.79	74.00	-27.21	peak	V
10440.000	31.72	16.89	48.61	74.00	-25.39	peak	V
15660.000	37.74	19.14	56.88	74.00	-17.12	peak	V
15660.000	24.14	19.14	43.28	54.00	-10.72	AVG	V
N/A							
8650.000	32.81	13.71	46.52	74.00	-27.48	peak	H
10440.000	31.78	16.89	48.67	74.00	-25.33	peak	H
15660.000	34.42	19.14	53.56	74.00	-20.44	peak	H
15660.000	22.78	19.14	41.92	54.00	-12.08	AVG	H
N/A							

Remark:

1. Measuring frequencies from 1 GHz to the 10th harmonic of highest fundamental frequency.
2. Radiated emissions measured in frequency above 1000MHz were made with an instrument using peak/average detector mode.
3. Average test would be performed if the peak result were greater than the average limit.
4. Data of measurement within this frequency range shown “ --- ” in the table above means the reading of emissions are attenuated more than 20dB below the permissible limits or the field strength is too small to be measured.
5. Measurements above show only up to 6 maximum emissions noted, or would be lesser, with “ N/A ” remark, if no specific emissions from the EUT are recorded (ie: margin>20dB from the applicable limit) and considered that's already beyond the background noise floor.
6. Margin (dB) = Remark result (dBuV/m) – Average limit (dBuV/m).

Tx / IEEE 802.11n HT 20 MHz mode / CH High

Polarity: Vertical

110.0 dBuV/m

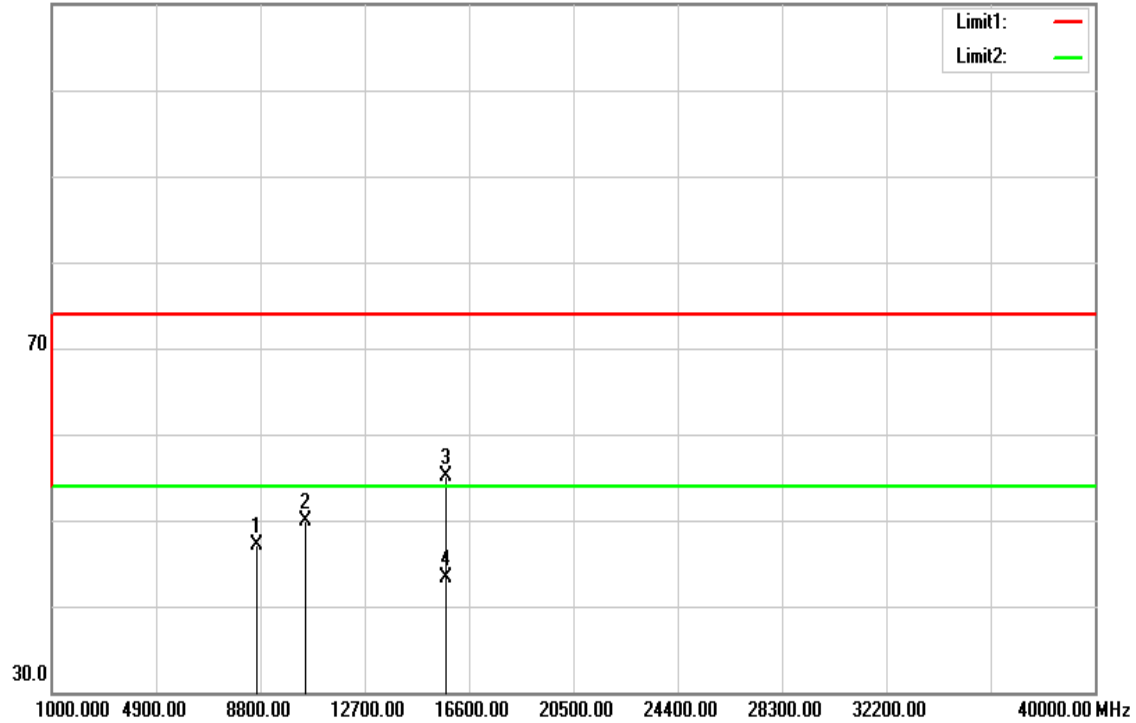

Polarity: Horizontal

110.0 dBuV/m

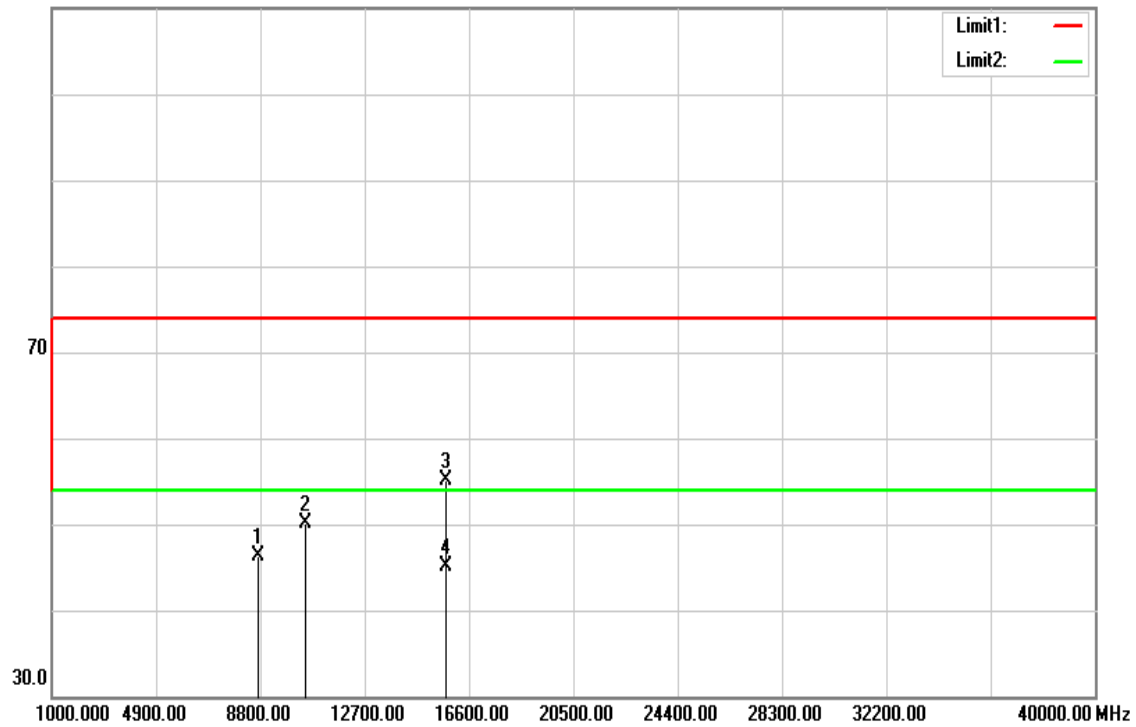

Operation Mode: Tx / IEEE 802.11n HT 20 MHz mode / CH High **Test Date:** September 14, 2016

Temperature: 27°C

Tested by: Dennis Li

Humidity: 53% RH

Polarity: Ver. / Hor.

Frequency (MHz)	Reading (dBuV)	Correction (dB/m)	Result (dBuV/m)	Limit (dBuV/m)	Margin (dB)	Remark	Ant.Pol. (H/V)
8650.000	33.34	13.71	47.05	74.00	-26.95	peak	V
10480.000	32.93	17.07	50.00	74.00	-24.00	peak	V
15720.000	35.84	19.19	55.03	74.00	-18.97	peak	V
15720.000	24.21	19.19	43.40	54.00	-10.60	AVG	V
N/A							
8700.000	32.61	13.73	46.34	74.00	-27.66	peak	H
10480.000	33.03	17.07	50.10	74.00	-23.90	peak	H
15720.000	35.83	19.19	55.02	74.00	-18.98	peak	H
15720.000	25.92	19.19	45.11	54.00	-8.89	AVG	H
N/A							

Remark:

1. Measuring frequencies from 1 GHz to the 10th harmonic of highest fundamental frequency.
2. Radiated emissions measured in frequency above 1000MHz were made with an instrument using peak/average detector mode.
3. Average test would be performed if the peak result were greater than the average limit.
4. Data of measurement within this frequency range shown " --- " in the table above means the reading of emissions are attenuated more than 20dB below the permissible limits or the field strength is too small to be measured.
5. Measurements above show only up to 6 maximum emissions noted, or would be lesser, with " N/A " remark, if no specific emissions from the EUT are recorded (ie: margin>20dB from the applicable limit) and considered that's already beyond the background noise floor.
6. Margin (dB) = Remark result (dBuV/m) – Average limit (dBuV/m).

Tx / IEEE 802.11n HT 40 MHz mode / CH Low

Polarity: Vertical

110.0 dBuV/m

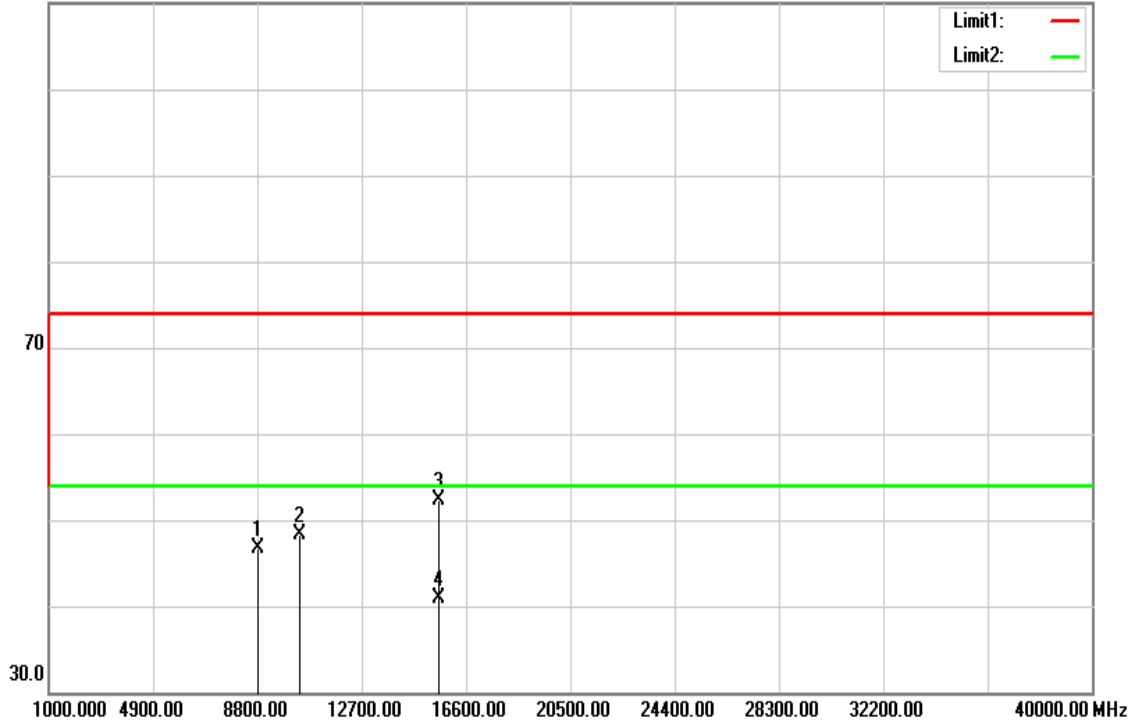

Polarity: Horizontal

110.0 dBuV/m

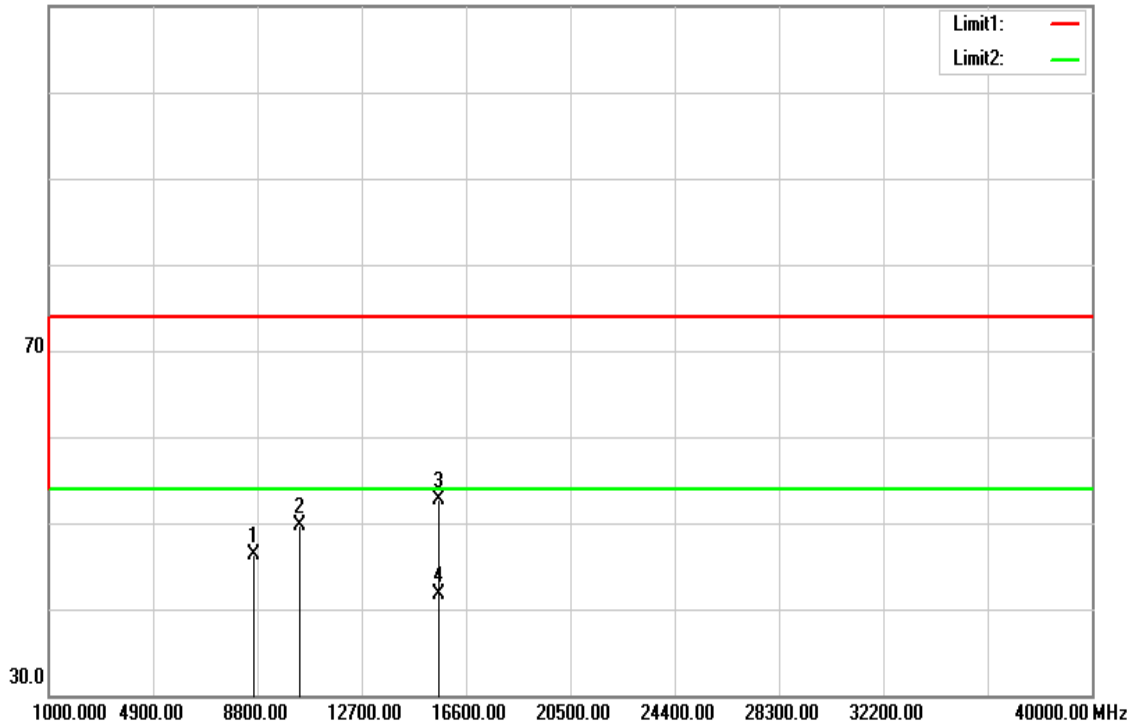

Operation Mode: Tx / IEEE 802.11n HT 40 MHz mode / CH Low **Test Date:** September 14, 2016

Temperature: 27°C

Tested by: Dennis Li

Humidity: 53% RH

Polarity: Ver. / Hor.

Frequency (MHz)	Reading (dBuV)	Correction (dB/m)	Result (dBuV/m)	Limit (dBuV/m)	Margin (dB)	Remark	Ant.Pol. (H/V)
8800.000	33.01	13.78	46.79	74.00	-27.21	peak	V
10380.000	31.73	16.62	48.35	74.00	-25.65	peak	V
15570.000	33.19	19.07	52.26	74.00	-21.74	peak	V
15570.000	21.82	19.07	40.89	54.00	-13.11	AVG	V
N/A							
8650.000	32.63	13.71	46.34	74.00	-27.66	peak	H
10380.000	33.17	16.62	49.79	74.00	-24.21	peak	H
15570.000	33.71	19.07	52.78	74.00	-21.22	peak	H
15570.000	22.59	19.07	41.66	54.00	-12.34	AVG	H
N/A							

Remark:

1. *Measuring frequencies from 1 GHz to the 10th harmonic of highest fundamental frequency.*
2. *Radiated emissions measured in frequency above 1000MHz were made with an instrument using peak/average detector mode.*
3. *Average test would be performed if the peak result were greater than the average limit.*
4. *Data of measurement within this frequency range shown “ --- ” in the table above means the reading of emissions are attenuated more than 20dB below the permissible limits or the field strength is too small to be measured.*
5. *Measurements above show only up to 6 maximum emissions noted, or would be lesser, with “ N/A ” remark, if no specific emissions from the EUT are recorded (ie: margin>20dB from the applicable limit) and considered that's already beyond the background noise floor.*
6. *Margin (dB) = Remark result (dBuV/m) – Average limit (dBuV/m).*

Tx / IEEE 802.11n HT 40 MHz mode / CH High

Polarity: Vertical

110.0 dBuV/m

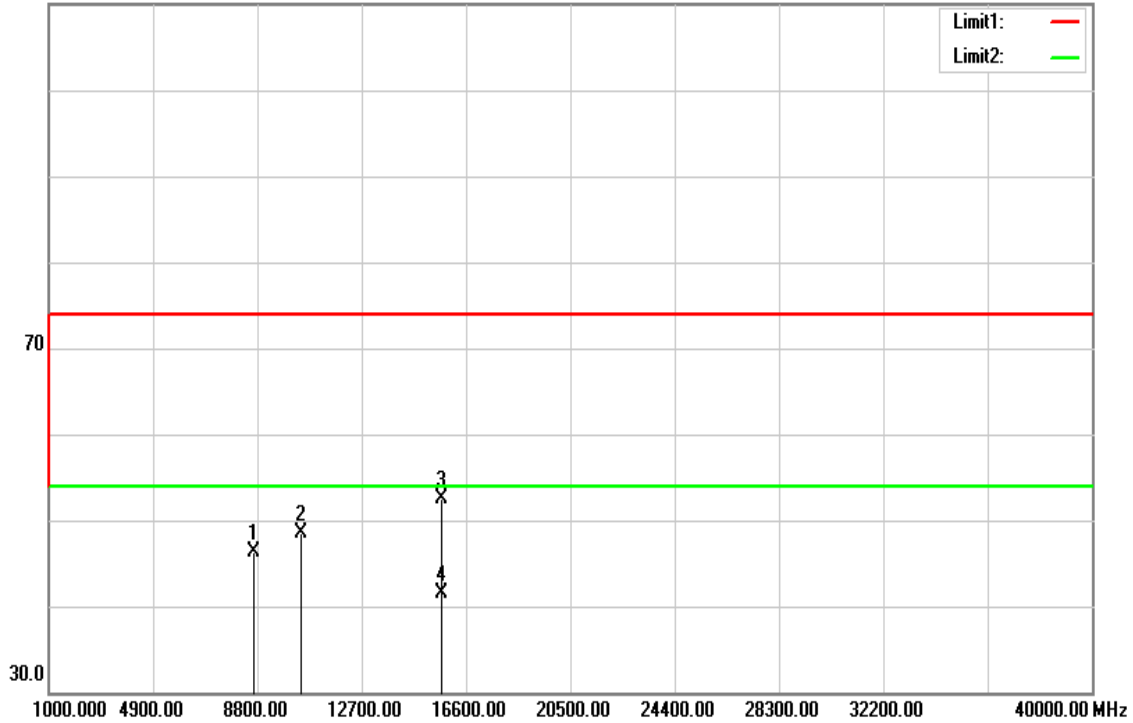

Polarity: Horizontal

110.0 dBuV/m

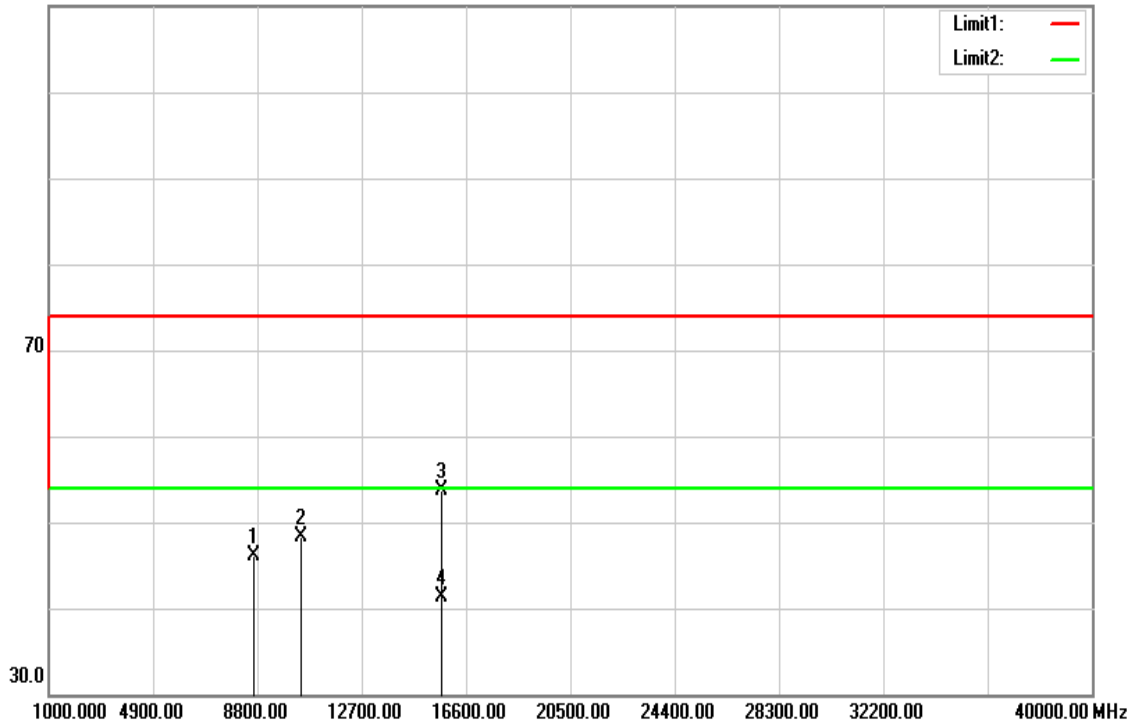

Operation Mode: Tx / IEEE 802.11n HT 40 MHz mode / CH High **Test Date:** September 14, 2016

Temperature: 27°C

Tested by: Dennis Li

Humidity: 53% RH

Polarity: Ver. / Hor.

Frequency (MHz)	Reading (dBuV)	Correction (dB/m)	Result (dBuV/m)	Limit (dBuV/m)	Margin (dB)	Remark	Ant.Pol. (H/V)
8660.000	32.59	13.71	46.30	74.00	-27.70	peak	V
10460.000	31.46	16.98	48.44	74.00	-25.56	peak	V
15690.000	33.27	19.17	52.44	74.00	-21.56	peak	V
15690.000	22.27	19.17	41.44	54.00	-12.56	AVG	V
N/A							
8690.000	32.33	13.73	46.06	74.00	-27.94	peak	H
10460.000	31.41	16.98	48.39	74.00	-25.61	peak	H
15690.000	34.51	19.17	53.68	74.00	-20.32	peak	H
15690.000	22.08	19.17	41.25	54.00	-12.75	AVG	H
N/A							

Remark:

1. *Measuring frequencies from 1 GHz to the 10th harmonic of highest fundamental frequency.*
2. *Radiated emissions measured in frequency above 1000MHz were made with an instrument using peak/average detector mode.*
3. *Average test would be performed if the peak result were greater than the average limit.*
4. *Data of measurement within this frequency range shown “ --- ” in the table above means the reading of emissions are attenuated more than 20dB below the permissible limits or the field strength is too small to be measured.*
5. *Measurements above show only up to 6 maximum emissions noted, or would be lesser, with “ N/A ” remark, if no specific emissions from the EUT are recorded (ie: margin>20dB from the applicable limit) and considered that's already beyond the background noise floor.*
6. *Margin (dB) = Remark result (dBuV/m) – Average limit (dBuV/m).*

U-NII-2A

Tx / IEEE 802.11a mode / CH Low

Polarity: Vertical

110.0 dBuV/m

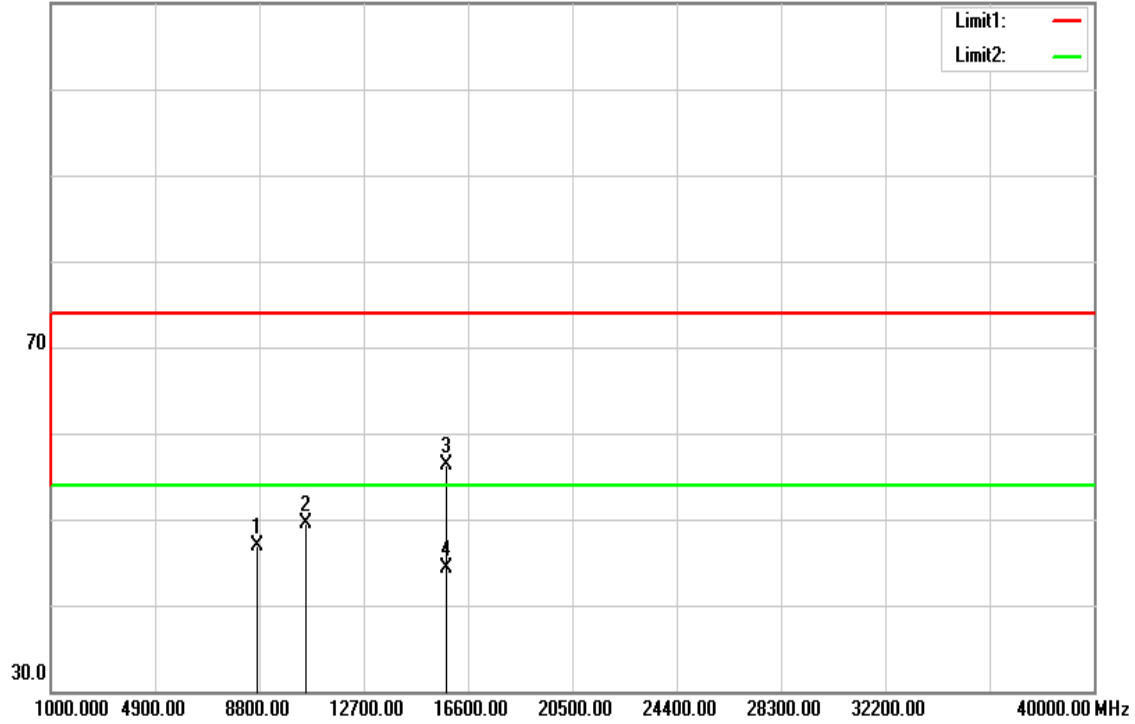

Polarity: Horizontal

110.0 dBuV/m

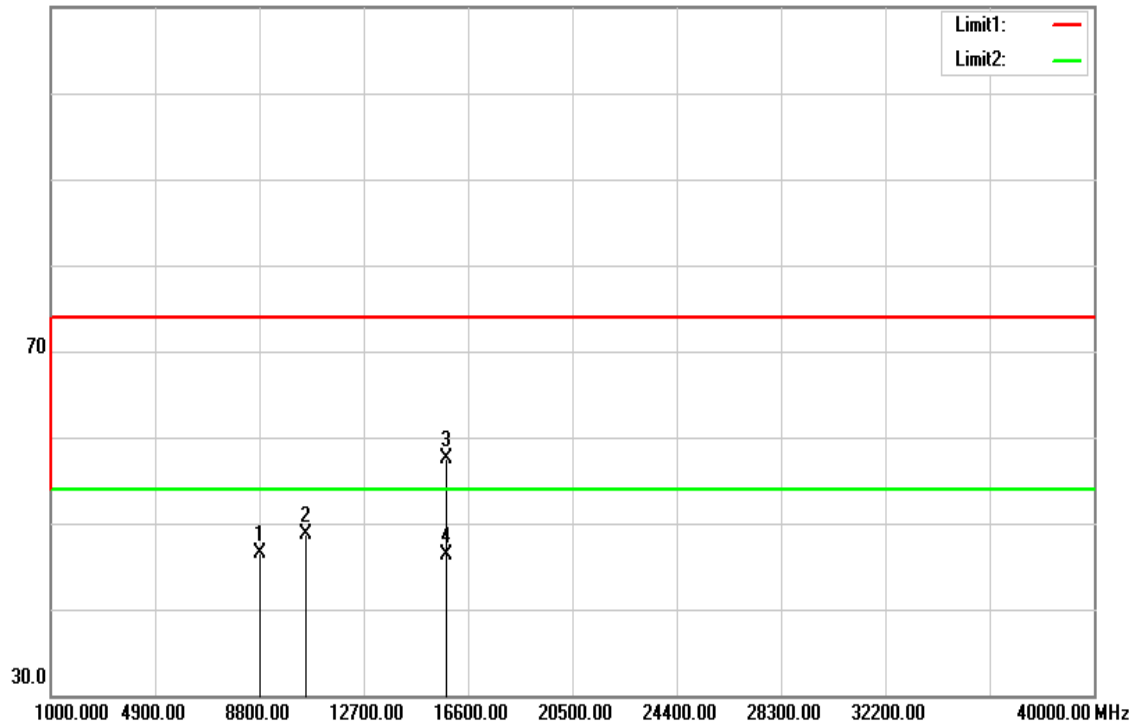

Operation Mode: Tx / IEEE 802.11a mode / CH Low

Test Date: September 12, 2016

Temperature: 27°C

Tested by: Dennis Li

Humidity: 53% RH

Polarity: Ver. / Hor.

Frequency (MHz)	Reading (dBuV)	Correction (dB/m)	Result (dBuV/m)	Limit (dBuV/m)	Margin (dB)	Remark	Ant.Pol. (H/V)
8740.000	33.14	13.75	46.89	74.00	-27.11	peak	V
10520.000	32.43	17.14	49.57	74.00	-24.43	peak	V
15780.000	37.07	19.25	56.32	74.00	-17.68	peak	V
15780.000	25.11	19.25	44.36	54.00	-9.64	AVG	V
N/A							
8850.000	32.74	13.80	46.54	74.00	-27.46	peak	H
10520.000	31.60	17.14	48.74	74.00	-25.26	peak	H
15780.000	38.23	19.25	57.48	74.00	-16.52	peak	H
15780.000	27.12	19.25	46.37	54.00	-7.63	AVG	H
N/A							

Remark:

1. Measuring frequencies from 1 GHz to the 10th harmonic of highest fundamental frequency.
2. Radiated emissions measured in frequency above 1000MHz were made with an instrument using peak/average detector mode.
3. Average test would be performed if the peak result were greater than the average limit.
4. Data of measurement within this frequency range shown " --- " in the table above means the reading of emissions are attenuated more than 20dB below the permissible limits or the field strength is too small to be measured.
5. Measurements above show only up to 6 maximum emissions noted, or would be lesser, with " N/A " remark, if no specific emissions from the EUT are recorded (ie: margin>20dB from the applicable limit) and considered that's already beyond the background noise floor.
6. Margin (dB) = Remark result (dBuV/m) – Average limit (dBuV/m).

Tx / IEEE 802.11a mode / CH Mid

Polarity: Vertical

110.0 dBuV/m

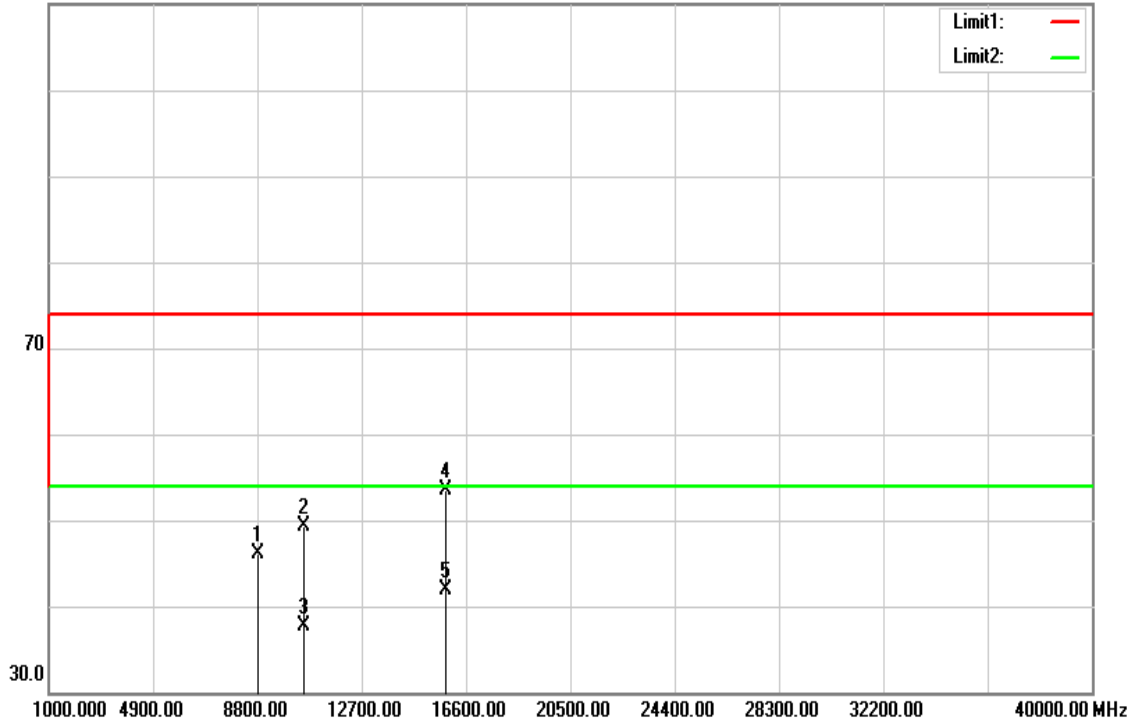

Polarity: Horizontal

110.0 dBuV/m

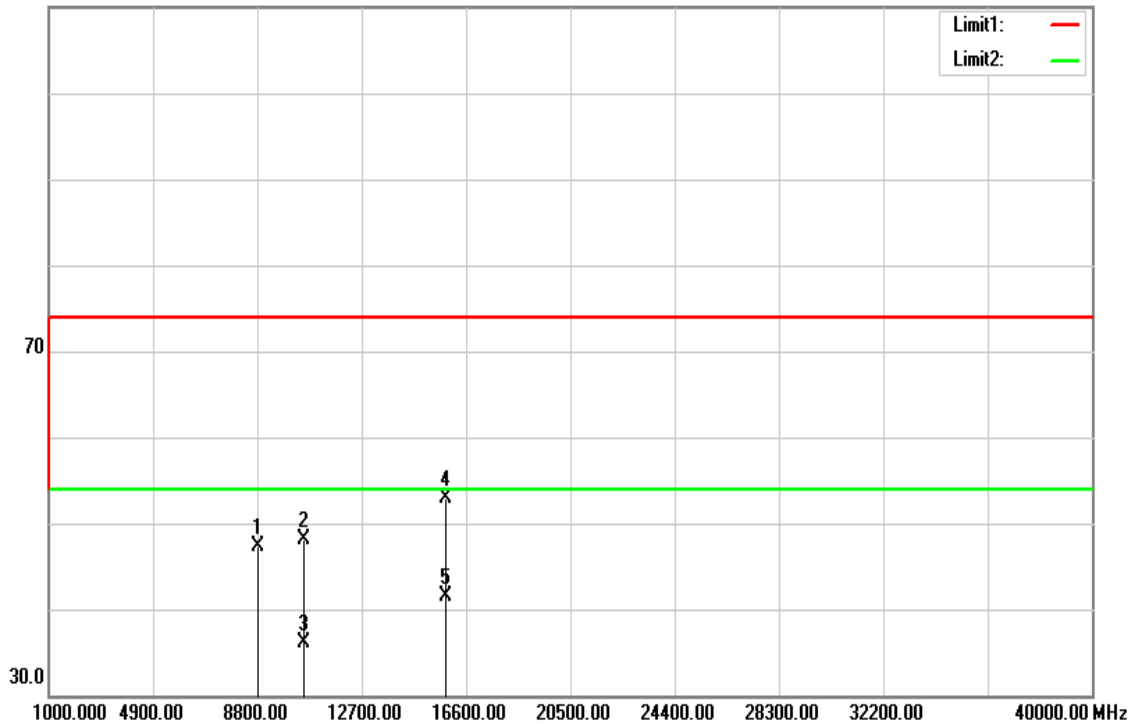

Operation Mode: Tx / IEEE 802.11a mode / CH Mid

Test Date: September 12, 2016

Temperature: 27°C

Tested by: Dennis Li

Humidity: 53% RH

Polarity: Ver. / Hor.

Frequency (MHz)	Reading (dBuV)	Correction (dB/m)	Result (dBuV/m)	Limit (dBuV/m)	Margin (dB)	Remark	Ant.Pol. (H/V)
8840.000	32.37	13.80	46.17	74.00	-27.83	peak	V
10560.000	32.26	17.11	49.37	74.00	-24.63	peak	V
10560.000	20.52	17.11	37.63	54.00	-16.37	AVG	V
15840.000	34.23	19.30	53.53	74.00	-20.47	peak	V
15840.000	22.55	19.30	41.85	54.00	-12.15	AVG	V
N/A							
8820.000	33.42	13.79	47.21	74.00	-26.79	peak	H
10560.000	30.91	17.11	48.02	74.00	-25.98	peak	H
10560.000	18.94	17.11	36.05	54.00	-17.95	AVG	H
15840.000	33.64	19.30	52.94	74.00	-21.06	peak	H
15840.000	22.18	19.30	41.48	54.00	-12.52	AVG	H
N/A							

Remark:

1. Measuring frequencies from 1 GHz to the 10th harmonic of highest fundamental frequency.
2. Radiated emissions measured in frequency above 1000MHz were made with an instrument using peak/average detector mode.
3. Average test would be performed if the peak result were greater than the average limit.
4. Data of measurement within this frequency range shown " --- " in the table above means the reading of emissions are attenuated more than 20dB below the permissible limits or the field strength is too small to be measured.
5. Measurements above show only up to 6 maximum emissions noted, or would be lesser, with " N/A " remark, if no specific emissions from the EUT are recorded (ie: margin>20dB from the applicable limit) and considered that's already beyond the background noise floor.
6. Margin (dB) = Remark result (dBuV/m) – Average limit (dBuV/m).

Tx / IEEE 802.11a mode / CH High

Polarity: Vertical

110.0 dBuV/m

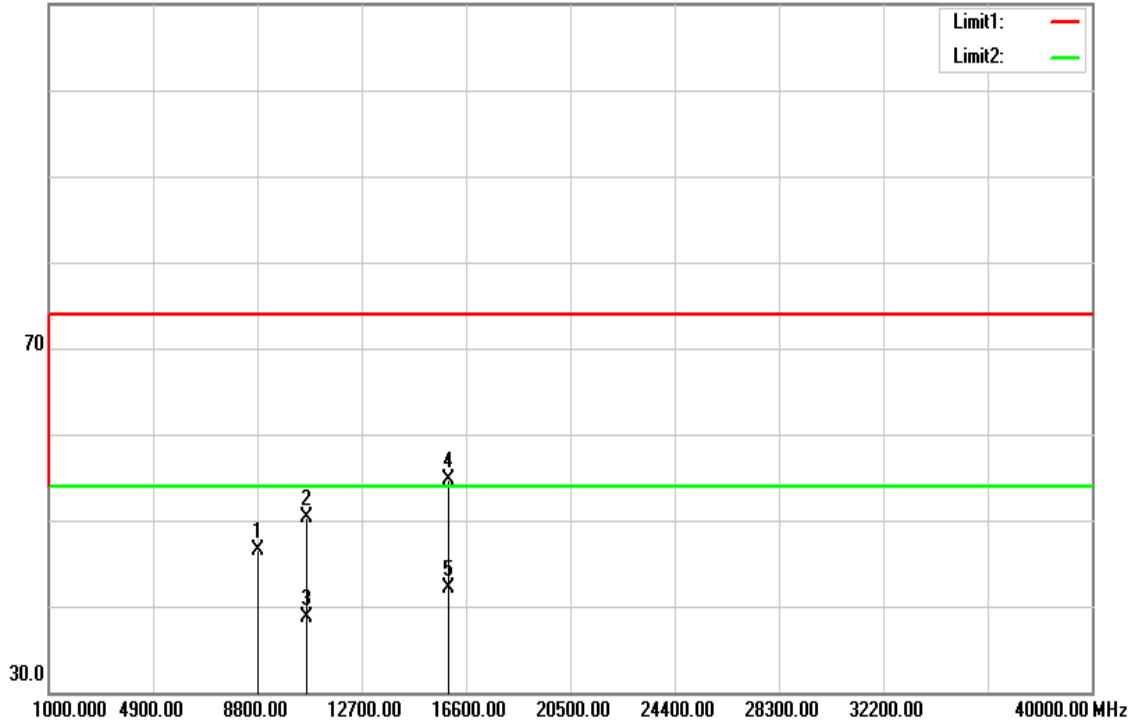

Polarity: Horizontal

110.0 dBuV/m

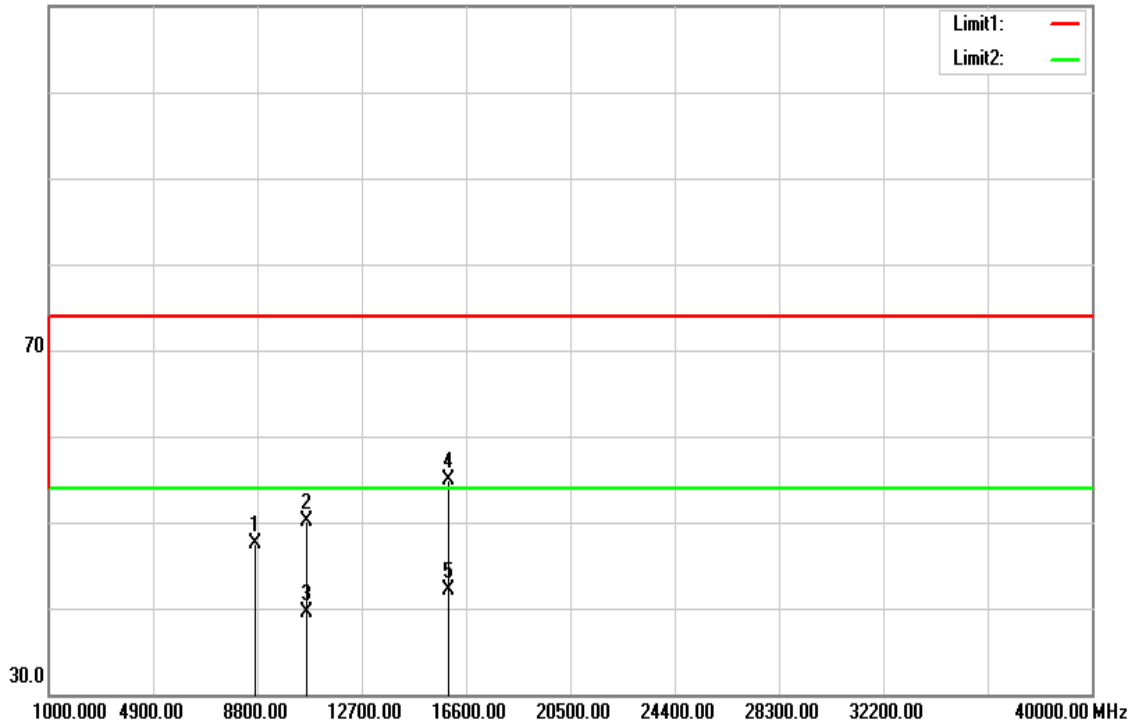

Operation Mode: Tx / IEEE 802.11a mode / CH High

Test Date: September 12, 2016

Temperature: 27°C

Tested by: Dennis Li

Humidity: 53% RH

Polarity: Ver. / Hor.

Frequency (MHz)	Reading (dBuV)	Correction (dB/m)	Result (dBuV/m)	Limit (dBuV/m)	Margin (dB)	Remark	Ant.Pol. (H/V)
8840.000	32.68	13.80	46.48	74.00	-27.52	peak	V
10640.000	33.22	17.04	50.26	74.00	-23.74	peak	V
10640.000	21.70	17.04	38.74	54.00	-15.26	AVG	V
15960.000	35.21	19.40	54.61	74.00	-19.39	peak	V
15960.000	22.75	19.40	42.15	54.00	-11.85	AVG	V
N/A							
8730.000	33.73	13.75	47.48	74.00	-26.52	peak	H
10640.000	32.99	17.04	50.03	74.00	-23.97	peak	H
10640.000	22.44	17.04	39.48	54.00	-14.52	AVG	H
15960.000	35.46	19.40	54.86	74.00	-19.14	peak	H
15960.000	22.78	19.40	42.18	54.00	-11.82	AVG	H
N/A							

Remark:

1. Measuring frequencies from 1 GHz to the 10th harmonic of highest fundamental frequency.
2. Radiated emissions measured in frequency above 1000MHz were made with an instrument using peak/average detector mode.
3. Average test would be performed if the peak result were greater than the average limit.
4. Data of measurement within this frequency range shown " --- " in the table above means the reading of emissions are attenuated more than 20dB below the permissible limits or the field strength is too small to be measured.
5. Measurements above show only up to 6 maximum emissions noted, or would be lesser, with " N/A " remark, if no specific emissions from the EUT are recorded (ie: margin>20dB from the applicable limit) and considered that's already beyond the background noise floor.
6. Margin (dB) = Remark result (dBuV/m) – Average limit (dBuV/m).

Tx / IEEE 802.11n HT 20 MHz mode / CH Low

Polarity: Vertical

110.0 dBuV/m

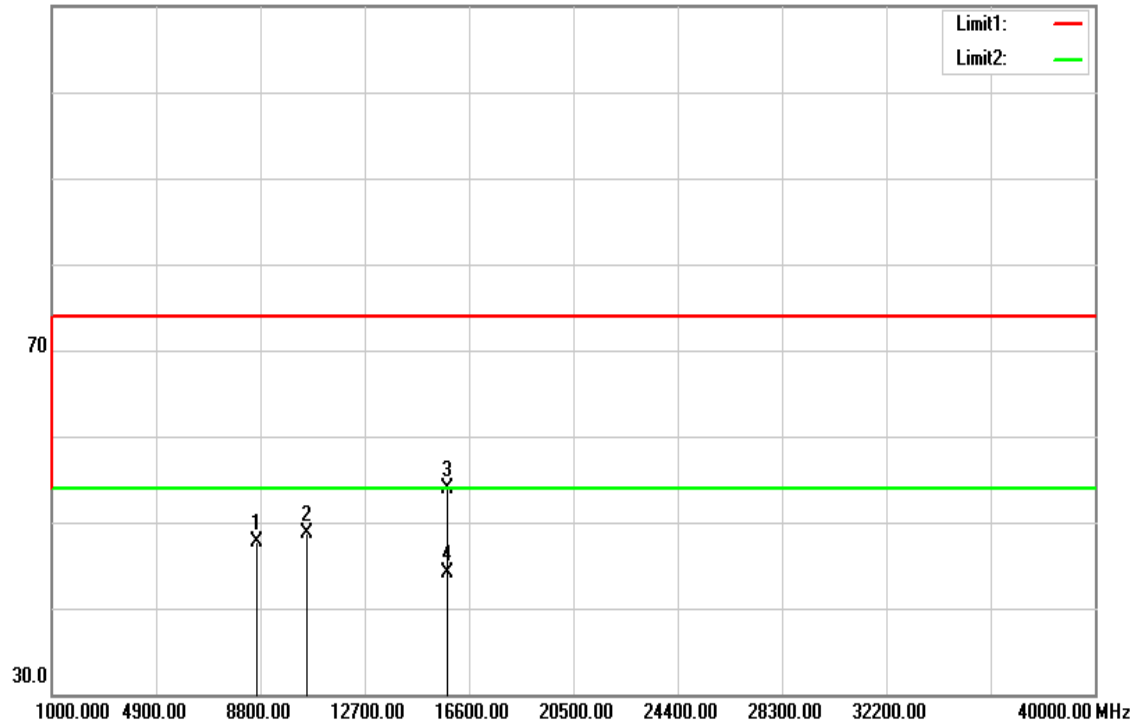

Polarity: Horizontal

110.0 dBuV/m

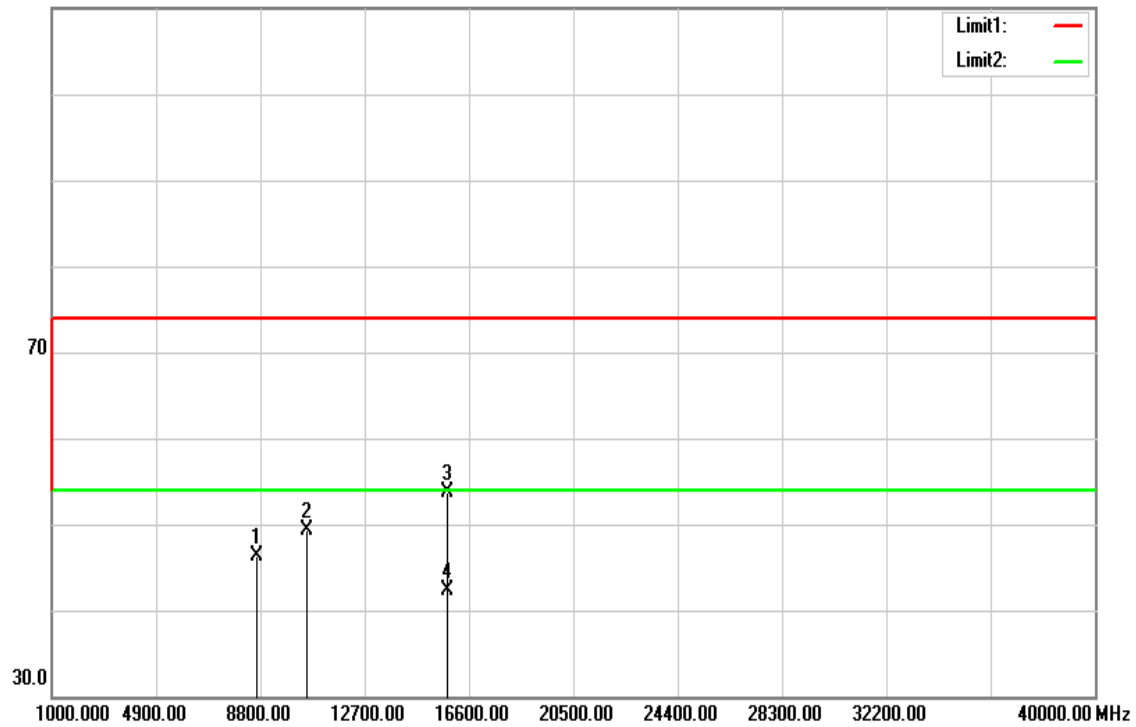

Operation Mode: Tx / IEEE 802.11n HT 20 MHz mode / CH Low **Test Date:** September 14, 2016

Temperature: 27°C

Tested by: Dennis Li

Humidity: 53% RH

Polarity: Ver. / Hor.

Frequency (MHz)	Reading (dBuV)	Correction (dB/m)	Result (dBuV/m)	Limit (dBuV/m)	Margin (dB)	Remark	Ant.Pol. (H/V)
8650.000	33.93	13.71	47.64	74.00	-26.36	peak	V
10520.000	31.63	17.14	48.77	74.00	-25.23	peak	V
15780.000	34.70	19.25	53.95	74.00	-20.05	peak	V
15780.000	24.81	19.25	44.06	54.00	-9.94	AVG	V
N/A							
8650.000	32.64	13.71	46.35	74.00	-27.65	peak	H
10520.000	32.09	17.14	49.23	74.00	-24.77	peak	H
15780.000	34.37	19.25	53.62	74.00	-20.38	peak	H
15780.000	23.11	19.25	42.36	54.00	-11.64	AVG	H
N/A							

Remark:

1. Measuring frequencies from 1 GHz to the 10th harmonic of highest fundamental frequency.
2. Radiated emissions measured in frequency above 1000MHz were made with an instrument using peak/average detector mode.
3. Average test would be performed if the peak result were greater than the average limit.
4. Data of measurement within this frequency range shown " --- " in the table above means the reading of emissions are attenuated more than 20dB below the permissible limits or the field strength is too small to be measured.
5. Measurements above show only up to 6 maximum emissions noted, or would be lesser, with " N/A " remark, if no specific emissions from the EUT are recorded (ie: margin>20dB from the applicable limit) and considered that's already beyond the background noise floor.
6. Margin (dB) = Remark result (dBuV/m) – Average limit (dBuV/m).

Tx / IEEE 802.11n HT 20 MHz mode / CH Mid

Polarity: Vertical

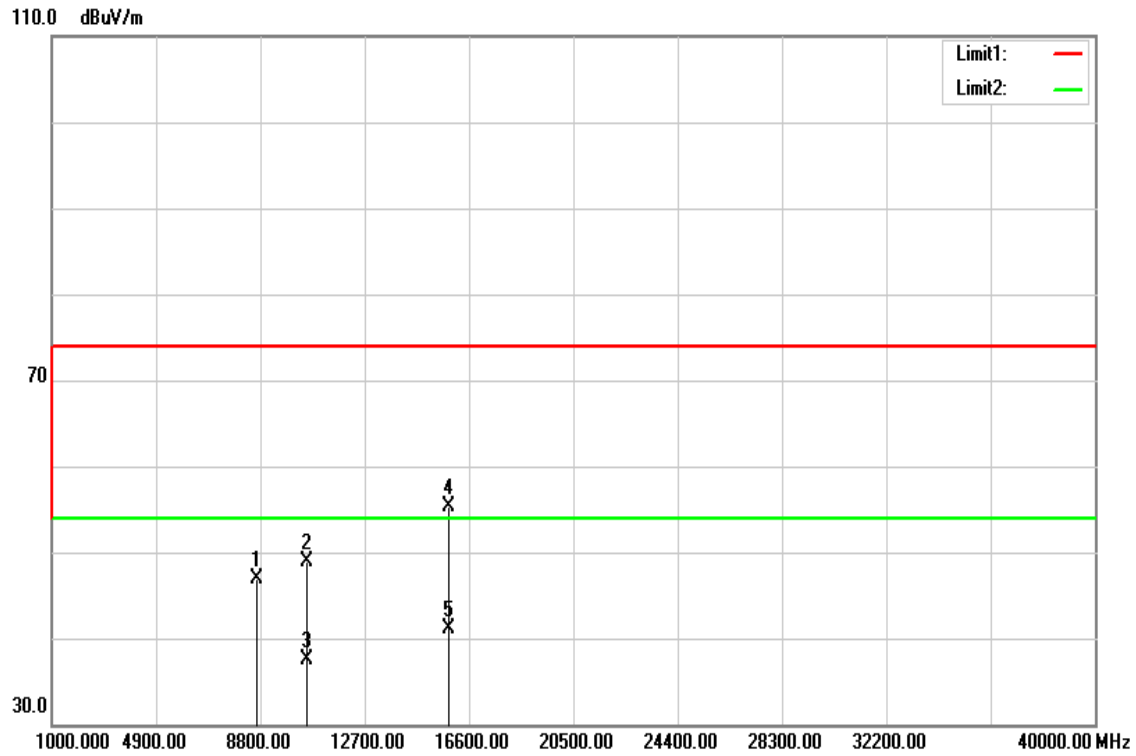

Polarity: Horizontal

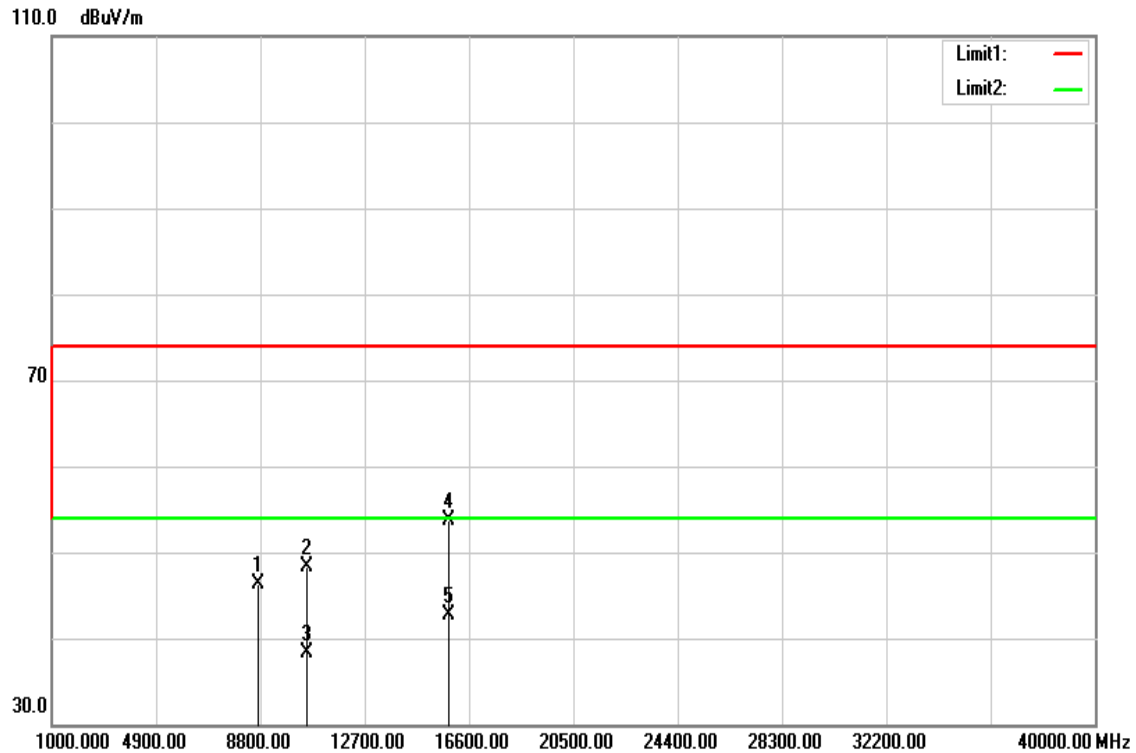

Operation Mode: Tx / IEEE 802.11n HT 20 MHz mode / CH Mid **Test Date:** September 14, 2016

Temperature: 27°C

Tested by: Dennis Li

Humidity: 53% RH

Polarity: Ver. / Hor.

Frequency (MHz)	Reading (dBuV)	Correction (dB/m)	Result (dBuV/m)	Limit (dBuV/m)	Margin (dB)	Remark	Ant.Pol. (H/V)
8650.000	33.28	13.71	46.99	74.00	-27.01	peak	V
10560.000	31.80	17.11	48.91	74.00	-25.09	peak	V
10560.000	20.36	17.11	37.47	54.00	-16.53	AVG	V
15840.000	36.01	19.30	55.31	74.00	-18.69	peak	V
15840.000	21.71	19.30	41.01	54.00	-12.99	AVG	V
N/A							
8700.000	32.50	13.73	46.23	74.00	-27.77	peak	H
10560.000	31.16	17.11	48.27	74.00	-25.73	peak	H
10560.000	21.25	17.11	38.36	54.00	-15.64	AVG	H
15840.000	34.33	19.30	53.63	74.00	-20.37	peak	H
15840.000	23.32	19.30	42.62	54.00	-11.38	AVG	H
N/A							

Remark:

1. Measuring frequencies from 1 GHz to the 10th harmonic of highest fundamental frequency.
2. Radiated emissions measured in frequency above 1000MHz were made with an instrument using peak/average detector mode.
3. Average test would be performed if the peak result were greater than the average limit.
4. Data of measurement within this frequency range shown " --- " in the table above means the reading of emissions are attenuated more than 20dB below the permissible limits or the field strength is too small to be measured.
5. Measurements above show only up to 6 maximum emissions noted, or would be lesser, with " N/A " remark, if no specific emissions from the EUT are recorded (ie: margin>20dB from the applicable limit) and considered that's already beyond the background noise floor.
6. Margin (dB) = Remark result (dBuV/m) – Average limit (dBuV/m).

Tx / IEEE 802.11n HT 20 MHz mode / CH High

Polarity: Vertical

110.0 dBuV/m

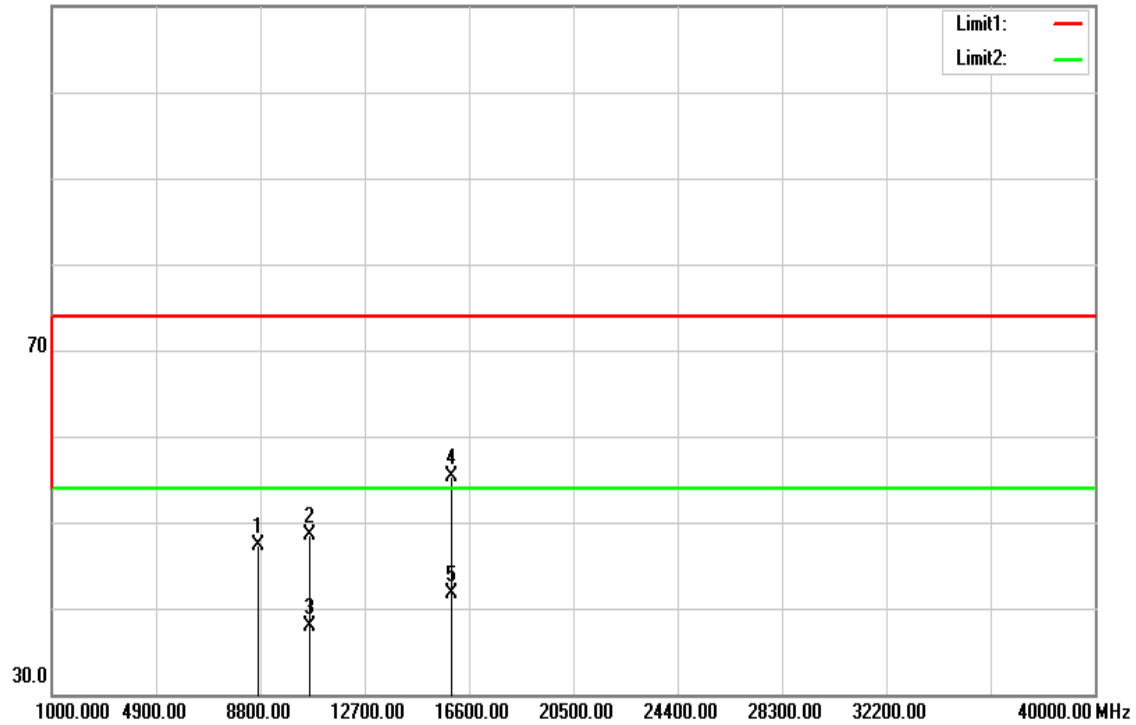

Polarity: Horizontal

110.0 dBuV/m

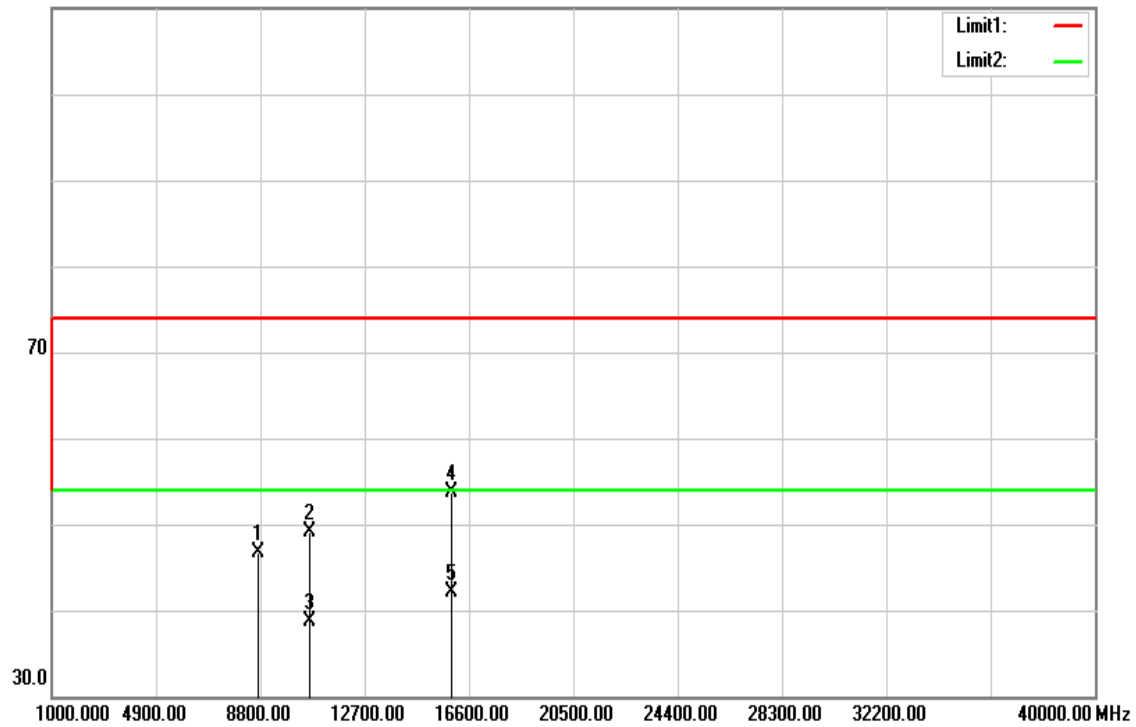

Operation Mode: Tx / IEEE 802.11n HT 20 MHz mode / CH High **Test Date:** September 14, 2016

Temperature: 27°C

Tested by: Dennis Li

Humidity: 53% RH

Polarity: Ver. / Hor.

Frequency (MHz)	Reading (dBuV)	Correction (dB/m)	Result (dBuV/m)	Limit (dBuV/m)	Margin (dB)	Remark	Ant.Pol. (H/V)
8700.000	33.53	13.73	47.26	74.00	-26.74	peak	V
10640.000	31.48	17.04	48.52	74.00	-25.48	peak	V
10640.000	20.84	17.04	37.88	54.00	-16.12	AVG	V
15960.000	36.00	19.40	55.40	74.00	-18.60	peak	V
15960.000	22.27	19.40	41.67	54.00	-12.33	AVG	V
N/A							
8700.000	32.92	13.73	46.65	74.00	-27.35	peak	H
10640.000	32.06	17.04	49.10	74.00	-24.90	peak	H
10640.000	21.75	17.04	38.79	54.00	-15.21	AVG	H
15960.000	34.30	19.40	53.70	74.00	-20.30	peak	H
15960.000	22.66	19.40	42.06	54.00	-11.94	AVG	H
N/A							

Remark:

1. Measuring frequencies from 1 GHz to the 10th harmonic of highest fundamental frequency.
2. Radiated emissions measured in frequency above 1000MHz were made with an instrument using peak/average detector mode.
3. Average test would be performed if the peak result were greater than the average limit.
4. Data of measurement within this frequency range shown " --- " in the table above means the reading of emissions are attenuated more than 20dB below the permissible limits or the field strength is too small to be measured.
5. Measurements above show only up to 6 maximum emissions noted, or would be lesser, with " N/A " remark, if no specific emissions from the EUT are recorded (ie: margin>20dB from the applicable limit) and considered that's already beyond the background noise floor.
6. Margin (dB) = Remark result (dBuV/m) – Average limit (dBuV/m).

Tx / IEEE 802.11n HT 40 MHz mode / CH Low

Polarity: Vertical

110.0 dBuV/m

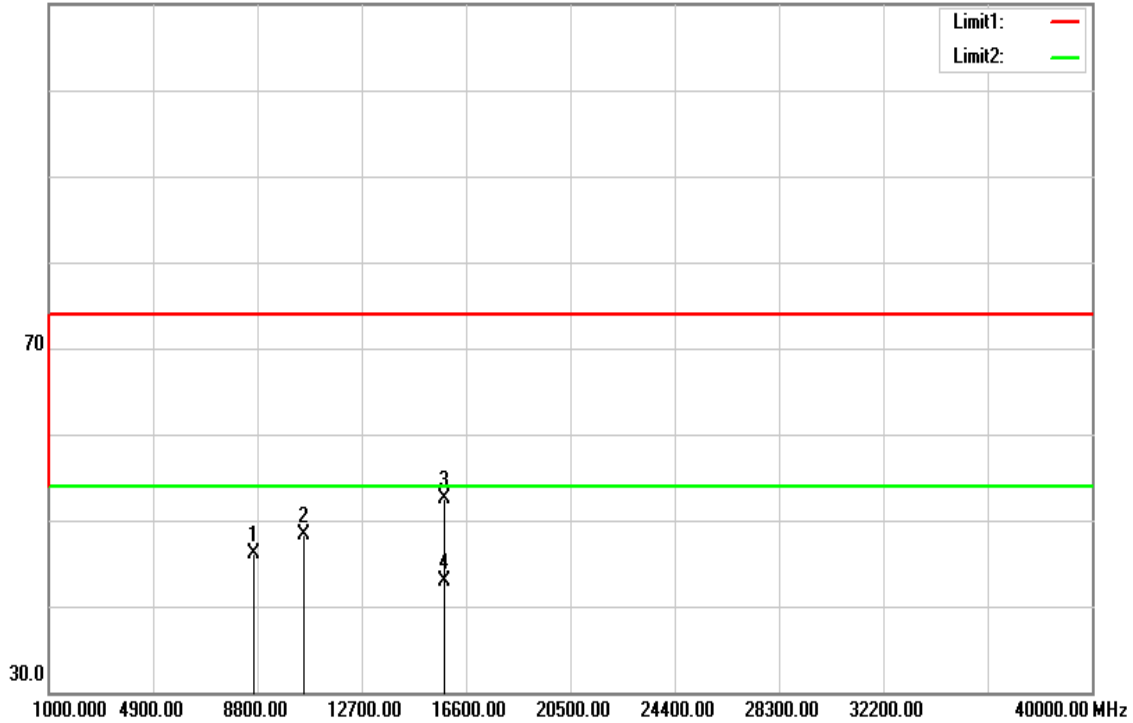

Polarity: Horizontal

110.0 dBuV/m

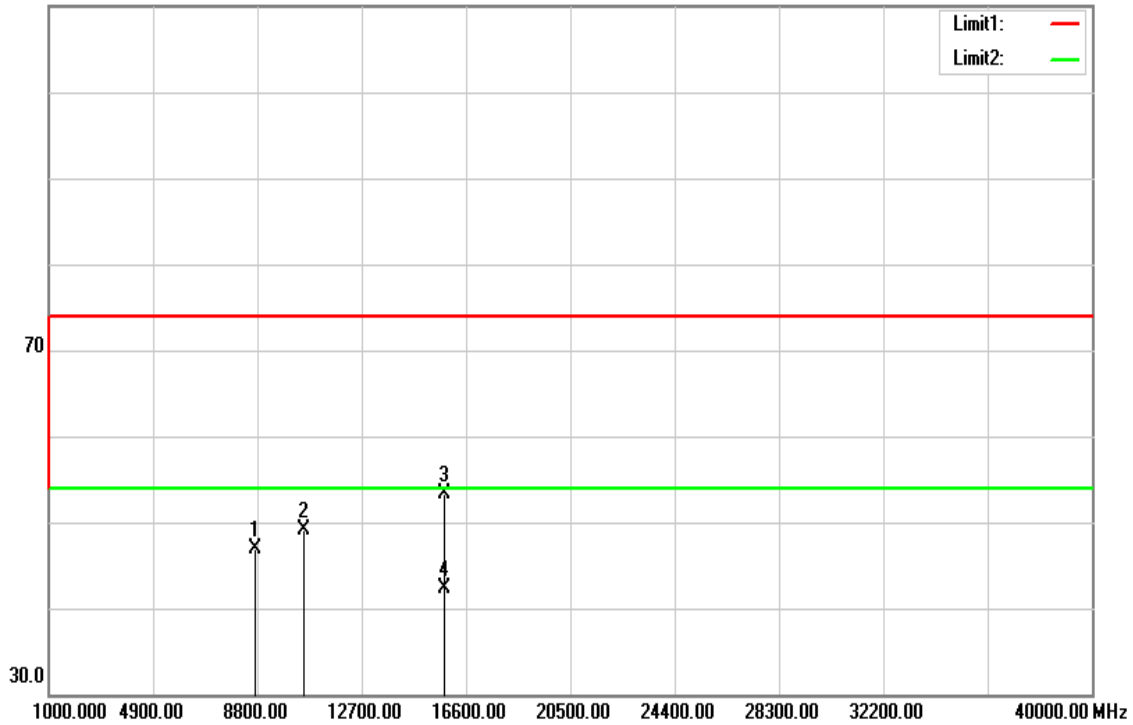

Operation Mode: Tx / IEEE 802.11n HT 40 MHz mode / CH Low **Test Date:** September 14, 2016

Temperature: 27°C

Tested by: Dennis Li

Humidity: 53% RH

Polarity: Ver. / Hor.

Frequency (MHz)	Reading (dBuV)	Correction (dB/m)	Result (dBuV/m)	Limit (dBuV/m)	Margin (dB)	Remark	Ant.Pol. (H/V)
8660.000	32.45	13.71	46.16	74.00	-27.84	peak	V
10540.000	31.07	17.13	48.20	74.00	-25.80	peak	V
15810.000	33.26	19.27	52.53	74.00	-21.47	peak	V
15810.000	23.64	19.27	42.91	54.00	-11.09	AVG	V
N/A							
8740.000	33.07	13.75	46.82	74.00	-27.18	peak	H
10540.000	32.02	17.13	49.15	74.00	-24.85	peak	H
15810.000	33.97	19.27	53.24	74.00	-20.76	peak	H
15810.000	23.00	19.27	42.27	54.00	-11.73	AVG	H
N/A							

Remark:

1. Measuring frequencies from 1 GHz to the 10th harmonic of highest fundamental frequency.
2. Radiated emissions measured in frequency above 1000MHz were made with an instrument using peak/average detector mode.
3. Average test would be performed if the peak result were greater than the average limit.
4. Data of measurement within this frequency range shown " --- " in the table above means the reading of emissions are attenuated more than 20dB below the permissible limits or the field strength is too small to be measured.
5. Measurements above show only up to 6 maximum emissions noted, or would be lesser, with " N/A " remark, if no specific emissions from the EUT are recorded (ie: margin>20dB from the applicable limit) and considered that's already beyond the background noise floor.
6. Margin (dB) = Remark result (dBuV/m) – Average limit (dBuV/m).

Tx / IEEE 802.11n HT 40 MHz mode / CH High

Polarity: Vertical

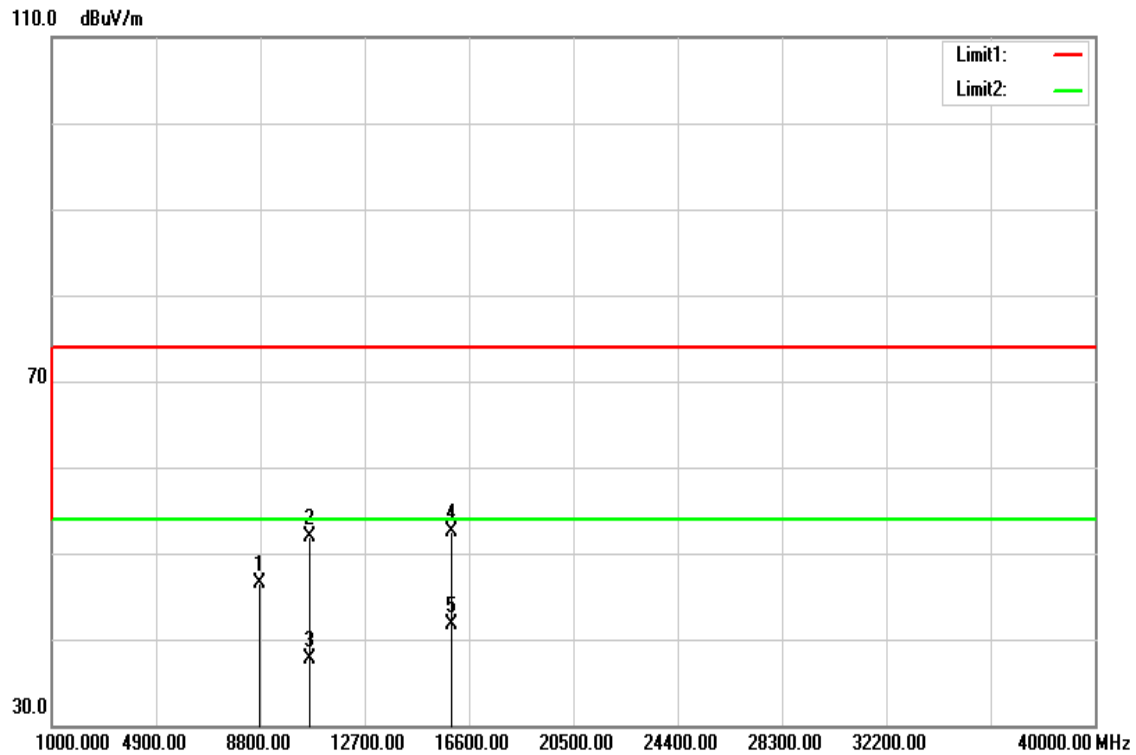

Polarity: Horizontal

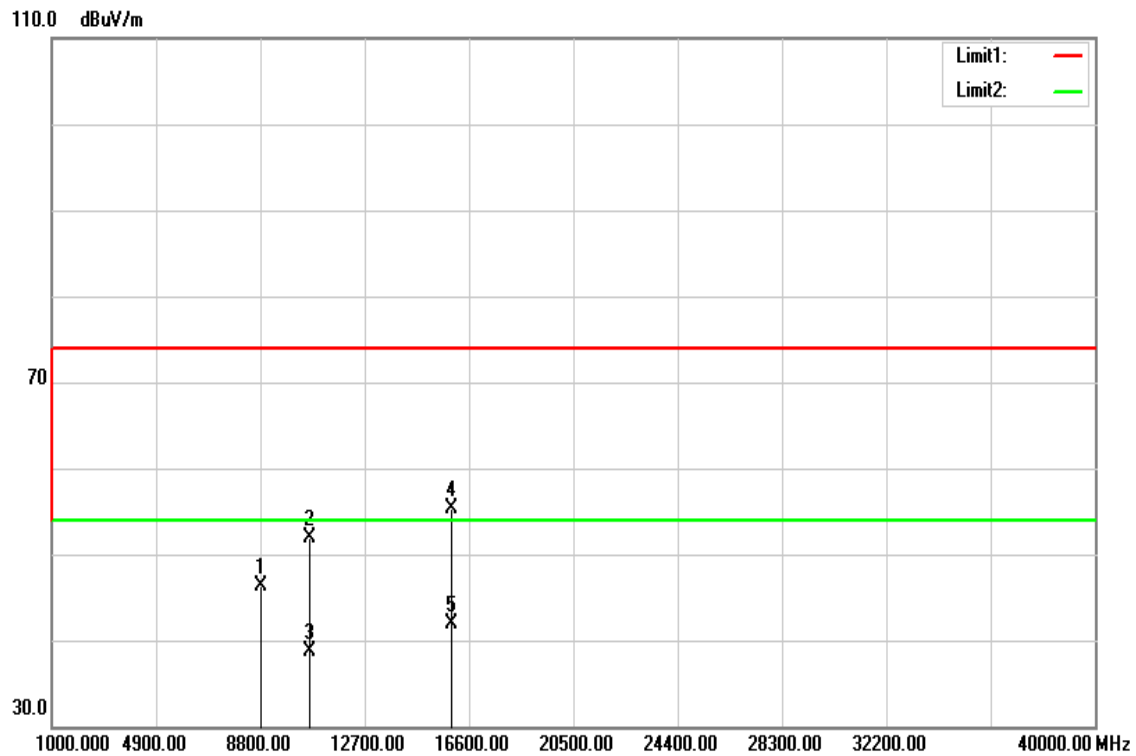

Operation Mode: Tx / IEEE 802.11n HT 40 MHz mode / CH High **Test Date:** September 14, 2016

Temperature: 27°C

Tested by: Dennis Li

Humidity: 53% RH

Polarity: Ver. / Hor.

Frequency (MHz)	Reading (dBuV)	Correction (dB/m)	Result (dBuV/m)	Limit (dBuV/m)	Margin (dB)	Remark	Ant.Pol. (H/V)
8750.000	32.81	13.75	46.56	74.00	-27.44	peak	V
10620.000	34.76	17.06	51.82	74.00	-22.18	peak	V
10620.000	20.56	17.06	37.62	54.00	-16.38	AVG	V
15930.000	33.22	19.37	52.59	74.00	-21.41	peak	V
15930.000	22.25	19.37	41.62	54.00	-12.38	AVG	V
N/A							
8850.000	32.54	13.80	46.34	74.00	-27.66	peak	H
10620.000	34.93	17.06	51.99	74.00	-22.01	peak	H
10620.000	21.63	17.06	38.69	54.00	-15.31	AVG	H
15930.000	35.90	19.37	55.27	74.00	-18.73	peak	H
15930.000	22.54	19.37	41.91	54.00	-12.09	AVG	H
N/A							

Remark:

1. Measuring frequencies from 1 GHz to the 10th harmonic of highest fundamental frequency.
2. Radiated emissions measured in frequency above 1000MHz were made with an instrument using peak/average detector mode.
3. Average test would be performed if the peak result were greater than the average limit.
4. Data of measurement within this frequency range shown " --- " in the table above means the reading of emissions are attenuated more than 20dB below the permissible limits or the field strength is too small to be measured.
5. Measurements above show only up to 6 maximum emissions noted, or would be lesser, with " N/A " remark, if no specific emissions from the EUT are recorded (ie: margin>20dB from the applicable limit) and considered that's already beyond the background noise floor.
6. Margin (dB) = Remark result (dBuV/m) – Average limit (dBuV/m).

U-NII-2C

Tx / IEEE 802.11a mode / CH Low

Polarity: Vertical

110.0 dBuV/m

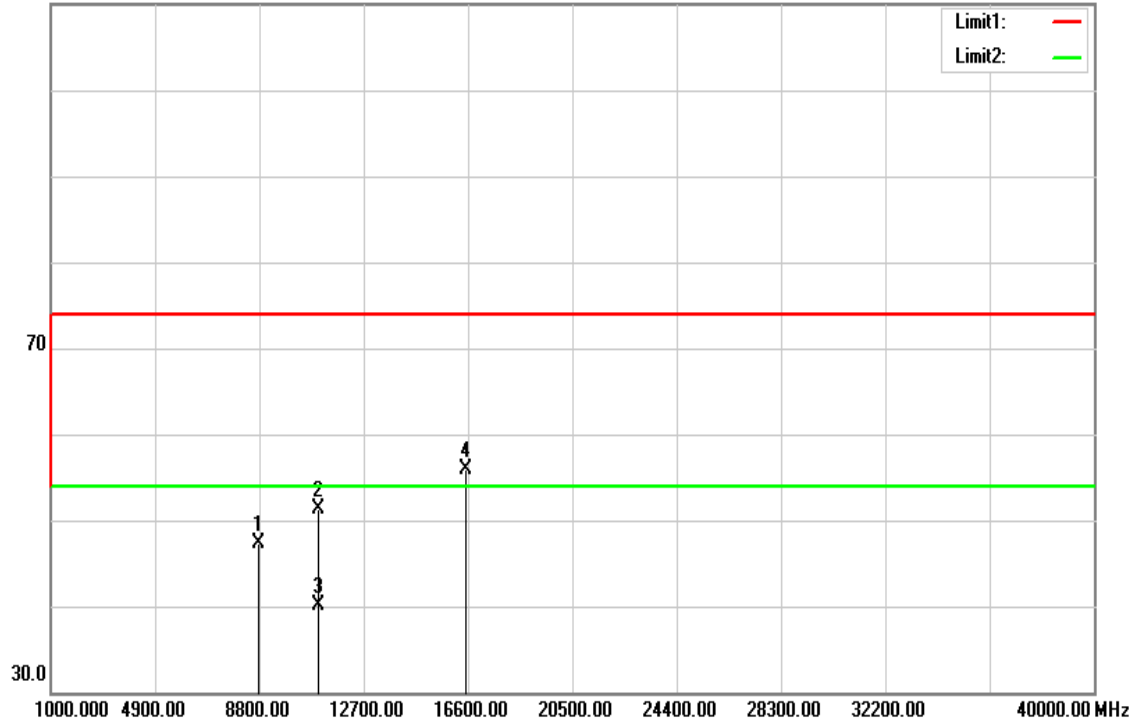

Polarity: Horizontal

110.0 dBuV/m

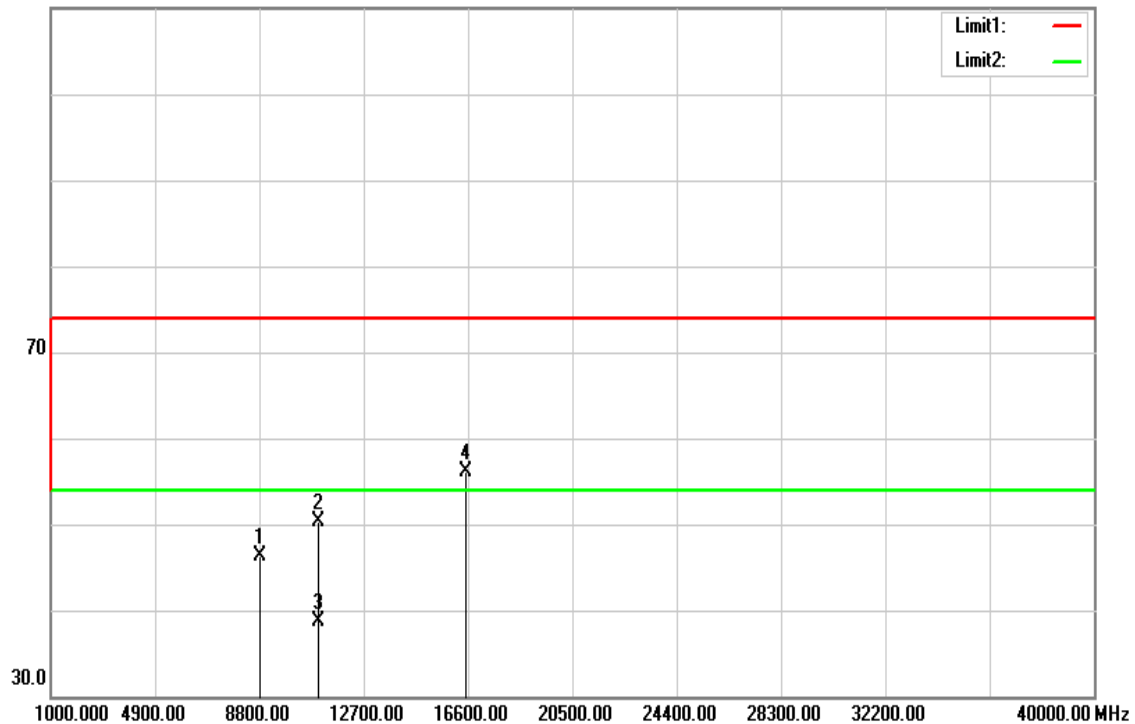

Operation Mode: Tx / IEEE 802.11a mode / CH Low

Test Date: September 12, 2016

Temperature: 27°C

Tested by: Dennis Li

Humidity: 53% RH

Polarity: Ver. / Hor.

Frequency (MHz)	Reading (dBuV)	Correction (dB/m)	Result (dBuV/m)	Limit (dBuV/m)	Margin (dB)	Remark	Ant.Pol. (H/V)
8750.000	33.57	13.75	47.32	74.00	-26.68	peak	V
11000.000	34.63	16.73	51.36	74.00	-22.64	peak	V
11000.000	23.42	16.73	40.15	54.00	-13.85	AVG	V
16500.000	34.52	21.39	55.91	74.00	-18.09	peak	V
N/A							
8830.000	32.44	13.79	46.23	74.00	-27.77	peak	H
11000.000	33.54	16.73	50.27	74.00	-23.73	peak	H
11000.000	22.01	16.73	38.74	54.00	-15.26	AVG	H
16500.000	34.65	21.39	56.04	74.00	-17.96	peak	H
N/A							

Remark:

1. Measuring frequencies from 1 GHz to the 10th harmonic of highest fundamental frequency.
2. Radiated emissions measured in frequency above 1000MHz were made with an instrument using peak/average detector mode.
3. Average test would be performed if the peak result were greater than the average limit or as required by the applicant.
4. Data of measurement within this frequency range shown “ --- ” in the table above means the reading of emissions are attenuated more than 20dB below the permissible limits or the field strength is too small to be measured.
5. Measurements above show only up to 6 maximum emissions noted, or would be lesser, with “ N/A ” remark, if no specific emissions from the EUT are recorded (ie: margin>20dB from the applicable limit) and considered that's already beyond the background noise floor.
6. Margin (dB) = Remark result (dBuV/m) – Average limit (dBuV/m).

Tx / IEEE 802.11a mode / CH Mid

Polarity: Vertical

110.0 dBuV/m

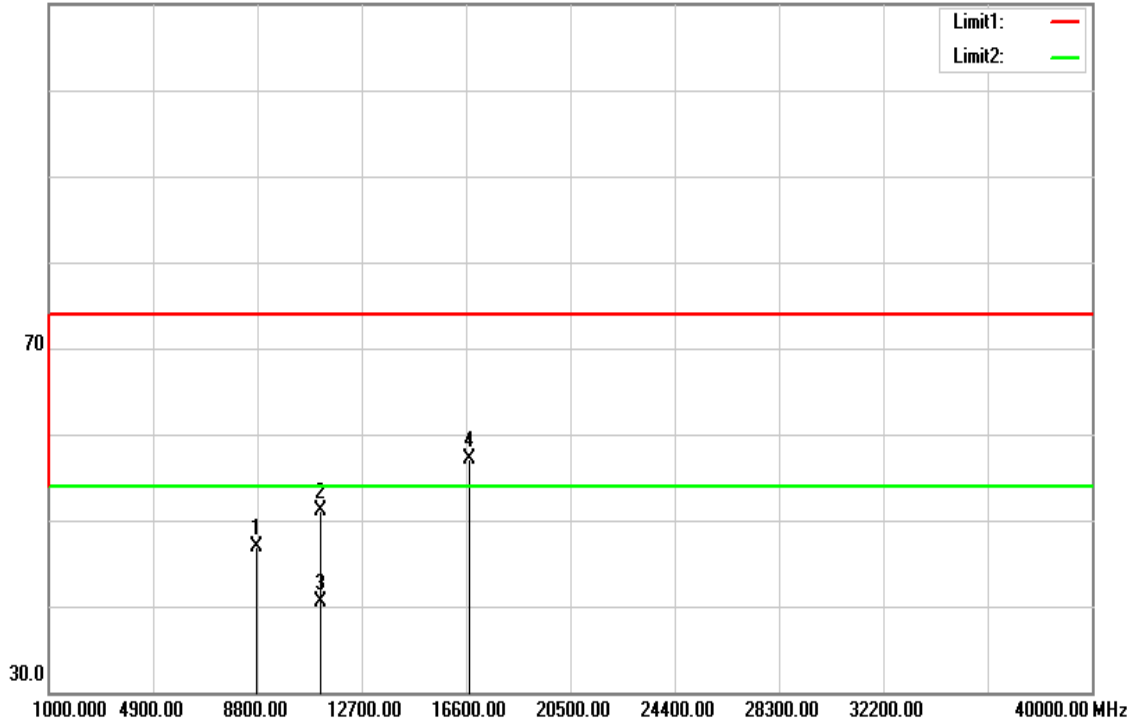

Polarity: Horizontal

110.0 dBuV/m

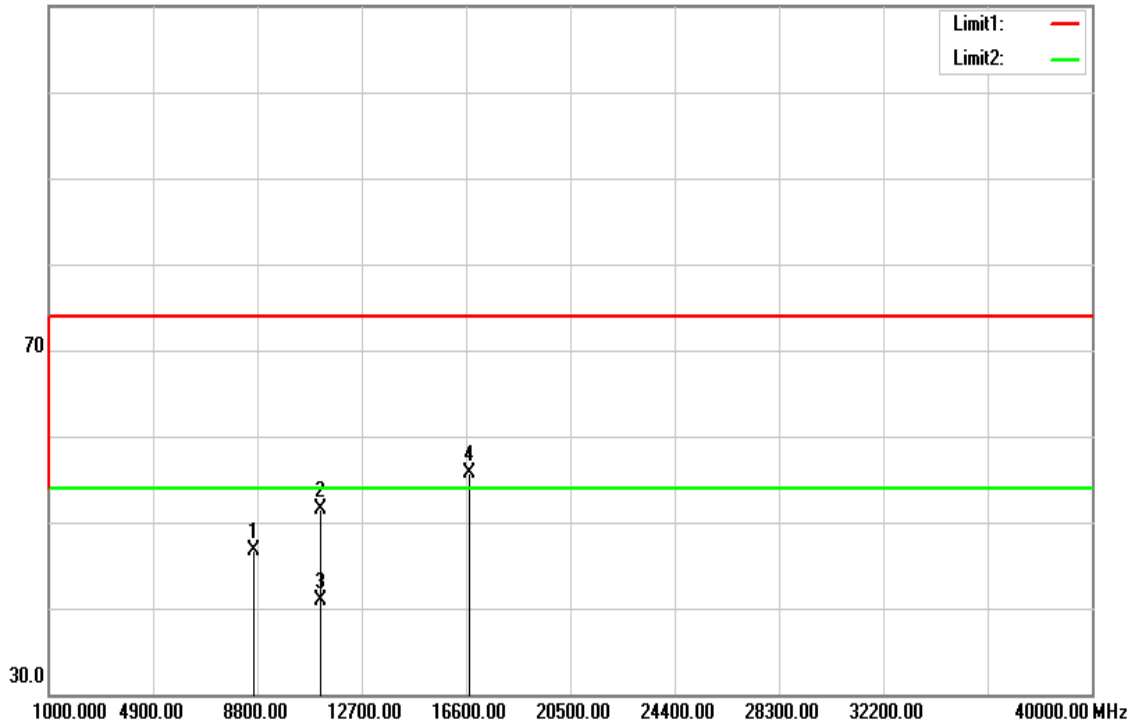

Operation Mode: Tx / IEEE 802.11a mode / CH Mid

Test Date: September 12, 2016

Temperature: 27°C

Tested by: Dennis Li

Humidity: 53% RH

Polarity: Ver. / Hor.

Frequency (MHz)	Reading (dBuV)	Correction (dB/m)	Result (dBuV/m)	Limit (dBuV/m)	Margin (dB)	Remark	Ant.Pol. (H/V)
8750.000	33.12	13.75	46.87	74.00	-27.13	peak	V
11160.000	34.34	16.75	51.09	74.00	-22.91	peak	V
11160.000	23.74	16.75	40.49	54.00	-13.51	AVG	V
16740.000	34.22	22.82	57.04	74.00	-16.96	peak	V
N/A							
8690.000	32.88	13.73	46.61	74.00	-27.39	peak	H
11160.000	34.73	16.75	51.48	74.00	-22.52	peak	H
11160.000	24.09	16.75	40.84	54.00	-13.16	AVG	H
16740.000	32.97	22.82	55.79	74.00	-18.21	peak	H
N/A							

Remark:

1. *Measuring frequencies from 1 GHz to the 10th harmonic of highest fundamental frequency.*
2. *Radiated emissions measured in frequency above 1000MHz were made with an instrument using peak/average detector mode.*
3. *Average test would be performed if the peak result were greater than the average limit or as required by the applicant.*
4. *Data of measurement within this frequency range shown " --- " in the table above means the reading of emissions are attenuated more than 20dB below the permissible limits or the field strength is too small to be measured.*
5. *Measurements above show only up to 6 maximum emissions noted, or would be lesser, with " N/A " remark, if no specific emissions from the EUT are recorded (ie: margin>20dB from the applicable limit) and considered that's already beyond the background noise floor.*
6. *Margin (dB) = Remark result (dBuV/m) – Average limit (dBuV/m).*

Tx / IEEE 802.11a mode / CH High

Polarity: Vertical

110.0 dBuV/m

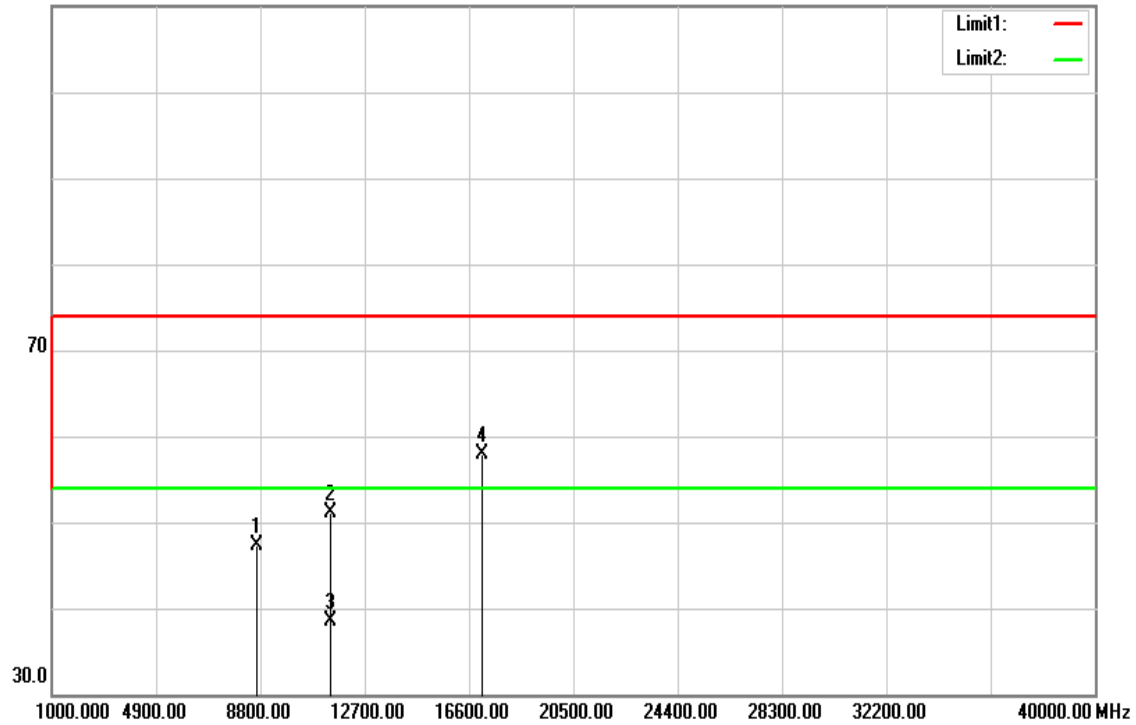

Polarity: Horizontal

110.0 dBuV/m

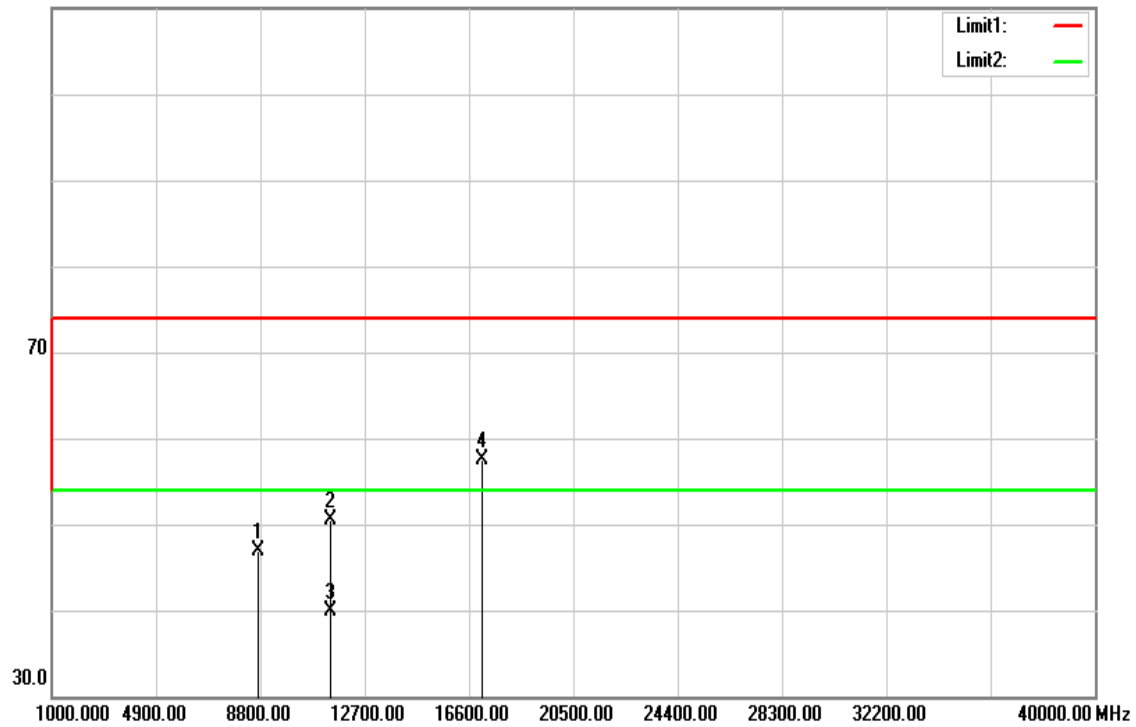

Operation Mode: Tx / IEEE 802.11a mode / CH High

Test Date: September 12, 2016

Temperature: 27°C

Tested by: Dennis Li

Humidity: 53% RH

Polarity: Ver. / Hor.

Frequency (MHz)	Reading (dBuV)	Correction (dB/m)	Result (dBuV/m)	Limit (dBuV/m)	Margin (dB)	Remark	Ant.Pol. (H/V)
8680.000	33.50	13.72	47.22	74.00	-26.78	peak	V
11400.000	34.32	16.77	51.09	74.00	-22.91	peak	V
11400.000	21.70	16.77	38.47	54.00	-15.53	AVG	V
17100.000	33.08	24.75	57.83	74.00	-16.17	peak	V
N/A							
8700.000	33.11	13.73	46.84	74.00	-27.16	peak	H
11400.000	33.71	16.77	50.48	74.00	-23.52	peak	H
11400.000	23.07	16.77	39.84	54.00	-14.16	AVG	H
17100.000	32.85	24.75	57.60	74.00	-16.40	peak	H
N/A							

Remark:

1. Measuring frequencies from 1 GHz to the 10th harmonic of highest fundamental frequency.
2. Radiated emissions measured in frequency above 1000MHz were made with an instrument using peak/average detector mode.
3. Average test would be performed if the peak result were greater than the average limit or as required by the applicant.
4. Data of measurement within this frequency range shown " --- " in the table above means the reading of emissions are attenuated more than 20dB below the permissible limits or the field strength is too small to be measured.
5. Measurements above show only up to 6 maximum emissions noted, or would be lesser, with " N/A " remark, if no specific emissions from the EUT are recorded (ie: margin>20dB from the applicable limit) and considered that's already beyond the background noise floor.
6. Margin (dB) = Remark result (dBuV/m) – Average limit (dBuV/m).

Tx / IEEE 802.11n HT 20 MHz mode / CH Low

Polarity: Vertical

110.0 dBuV/m

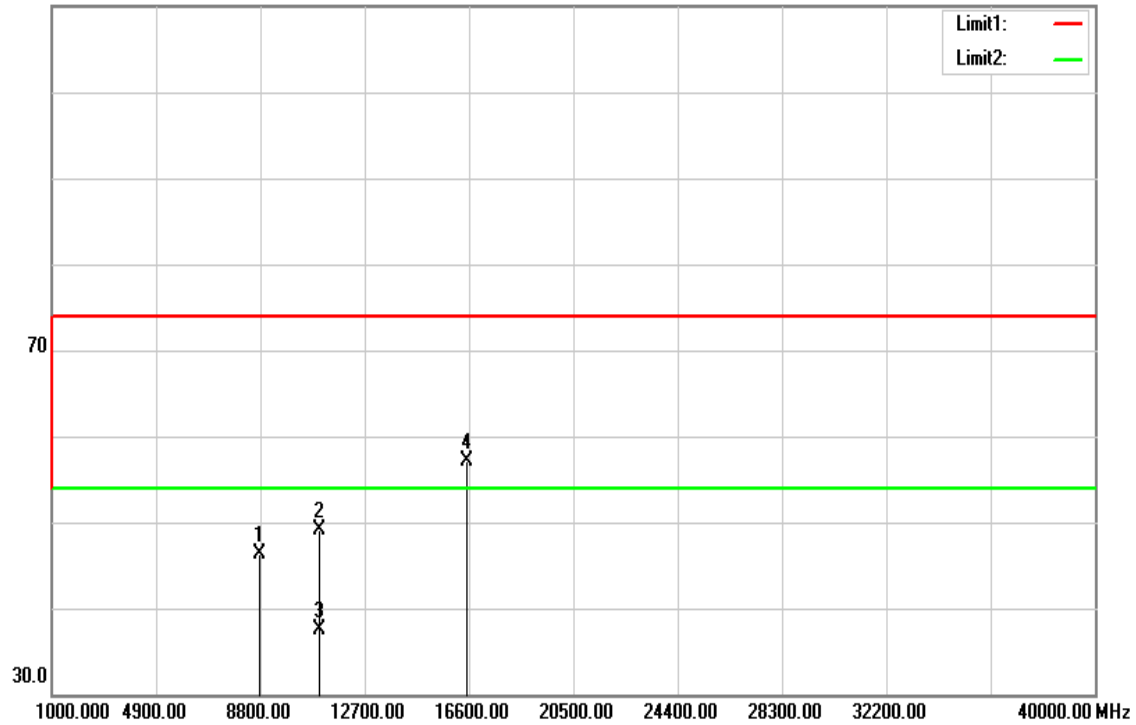

Polarity: Horizontal

110.0 dBuV/m

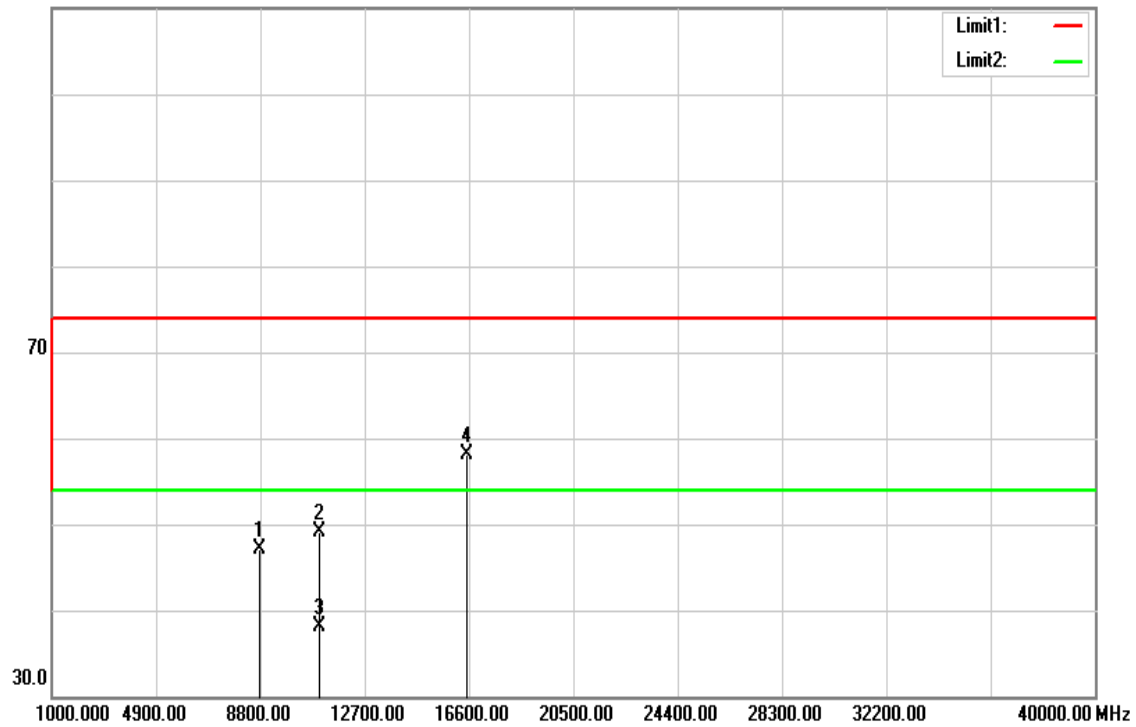

Operation Mode:Tx / IEEE 802.11n HT 20 MHz mode / CH Low **Test Date:** September 14, 2016

Temperature: 27°C

Tested by:Dennis Li

Humidity: 53% RH

Polarity: Ver. / Hor.

Frequency (MHz)	Reading (dBuV)	Correction (dB/m)	Result (dBuV/m)	Limit (dBuV/m)	Margin (dB)	Remark	Ant.Pol. (H/V)
8750.000	32.56	13.75	46.31	74.00	-27.69	peak	V
11000.000	32.39	16.73	49.12	74.00	-24.88	peak	V
11000.000	20.85	16.73	37.58	54.00	-16.42	AVG	V
16500.000	35.65	21.39	57.04	74.00	-16.96	peak	V
N/A							
8750.000	33.26	13.75	47.01	74.00	-26.99	peak	H
11000.000	32.35	16.73	49.08	74.00	-24.92	peak	H
11000.000	21.35	16.73	38.08	54.00	-15.92	AVG	H
16500.000	36.79	21.39	58.18	74.00	-15.82	peak	H
N/A							

Remark:

1. Measuring frequencies from 1 GHz to the 10th harmonic of highest fundamental frequency.
2. Radiated emissions measured in frequency above 1000MHz were made with an instrument using peak/average detector mode.
3. Average test would be performed if the peak result were greater than the average limit or as required by the applicant.
4. Data of measurement within this frequency range shown “ --- ” in the table above means the reading of emissions are attenuated more than 20dB below the permissible limits or the field strength is too small to be measured.
5. Measurements above show only up to 6 maximum emissions noted, or would be lesser, with “ N/A ” remark, if no specific emissions from the EUT are recorded (ie: margin>20dB from the applicable limit) and considered that's already beyond the background noise floor.
6. Margin (dB) = Remark result (dBuV/m) – Average limit (dBuV/m).

Tx / IEEE 802.11n HT 20 MHz mode / CH Mid

Polarity: Vertical

110.0 dBuV/m

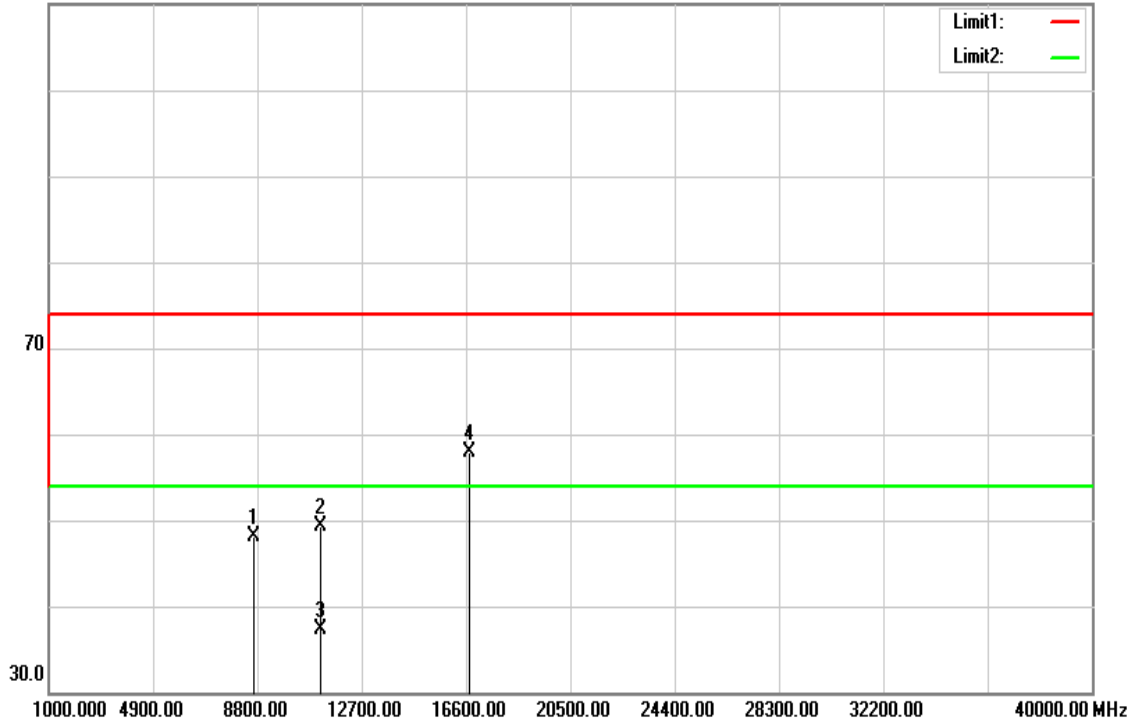

Polarity: Horizontal

110.0 dBuV/m

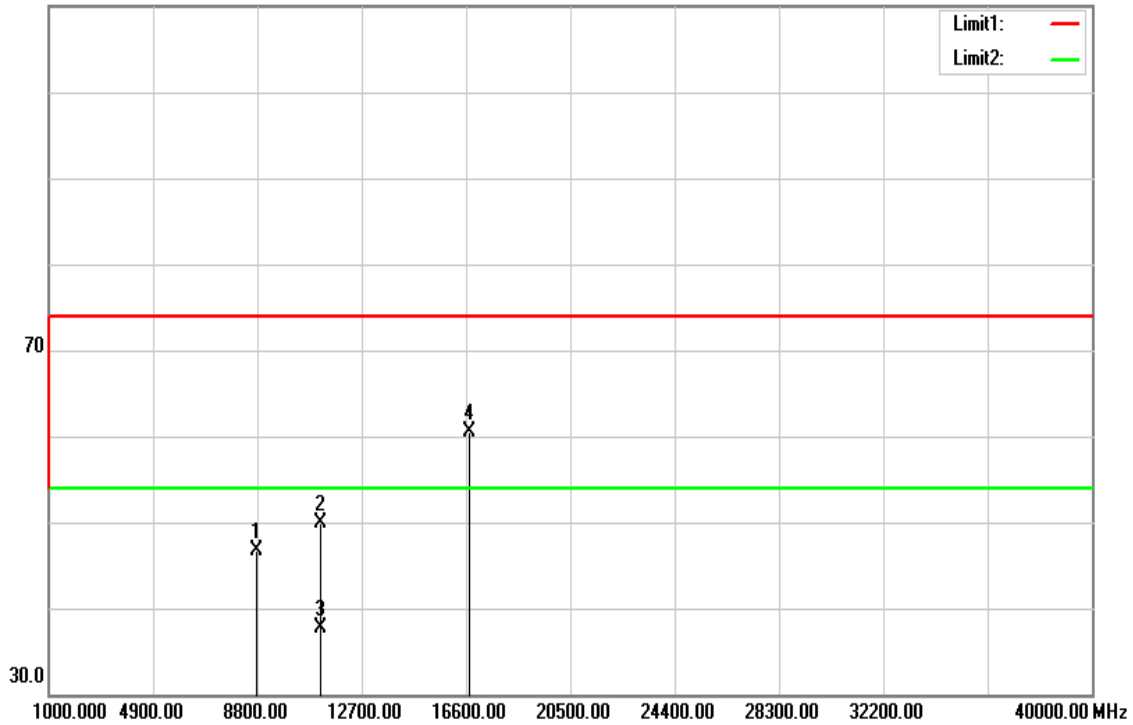

Operation Mode:Tx / IEEE 802.11n HT 20 MHz mode / CH Mid**Test Date:** September 14, 2016

Temperature: 27°C

Tested by:Dennis Li

Humidity: 53% RH

Polarity: Ver. / Hor.

Frequency (MHz)	Reading (dBuV)	Correction (dB/m)	Result (dBuV/m)	Limit (dBuV/m)	Margin (dB)	Remark	Ant.Pol. (H/V)
8680.000	34.39	13.72	48.11	74.00	-25.89	peak	V
11160.000	32.53	16.75	49.28	74.00	-24.72	peak	V
11160.000	20.60	16.75	37.35	54.00	-16.65	AVG	V
16740.000	35.05	22.82	57.87	74.00	-16.13	peak	V
N/A							
8750.000	33.04	13.75	46.79	74.00	-27.21	peak	H
11160.000	33.24	16.75	49.99	74.00	-24.01	peak	H
11160.000	20.97	16.75	37.72	54.00	-16.28	AVG	H
16740.000	37.60	22.82	60.42	74.00	-13.58	peak	H
N/A							

Remark:

1. Measuring frequencies from 1 GHz to the 10th harmonic of highest fundamental frequency.
2. Radiated emissions measured in frequency above 1000MHz were made with an instrument using peak/average detector mode.
3. Average test would be performed if the peak result were greater than the average limit or as required by the applicant.
4. Data of measurement within this frequency range shown " --- " in the table above means the reading of emissions are attenuated more than 20dB below the permissible limits or the field strength is too small to be measured.
5. Measurements above show only up to 6 maximum emissions noted, or would be lesser, with " N/A " remark, if no specific emissions from the EUT are recorded (ie: margin>20dB from the applicable limit) and considered that's already beyond the background noise floor.
6. Margin (dB) = Remark result (dBuV/m) – Average limit (dBuV/m).

Tx / IEEE 802.11n HT 20 MHz mode / CH High

Polarity: Vertical

110.0 dBuV/m

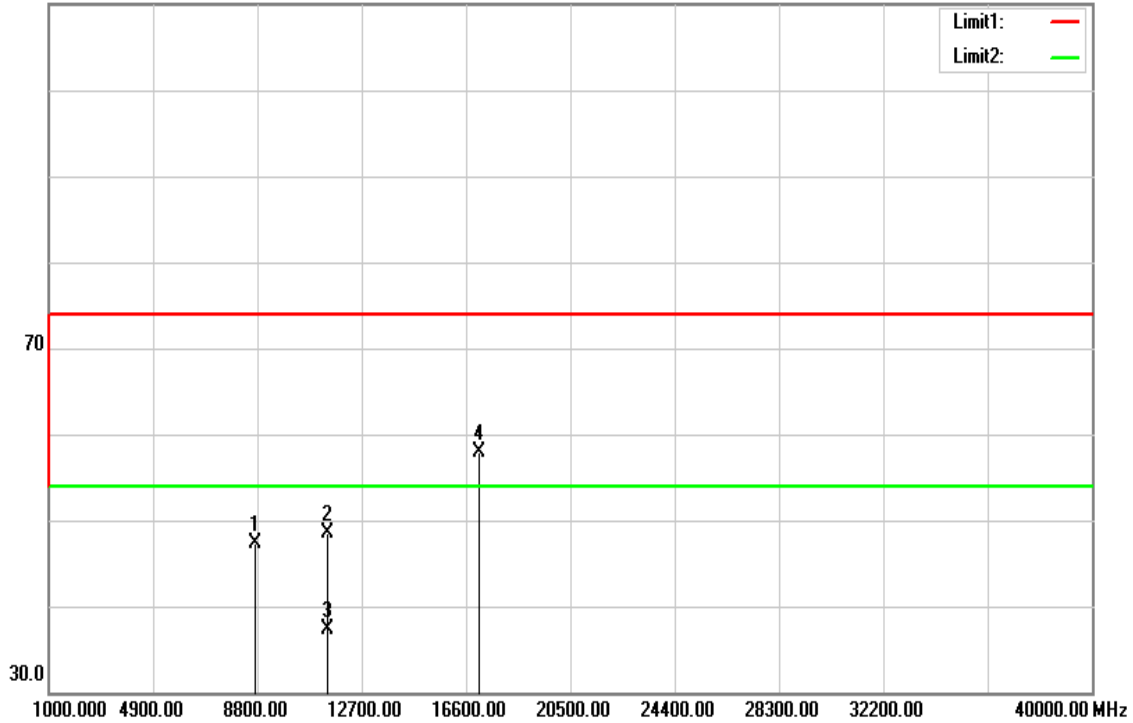

Polarity: Horizontal

110.0 dBuV/m

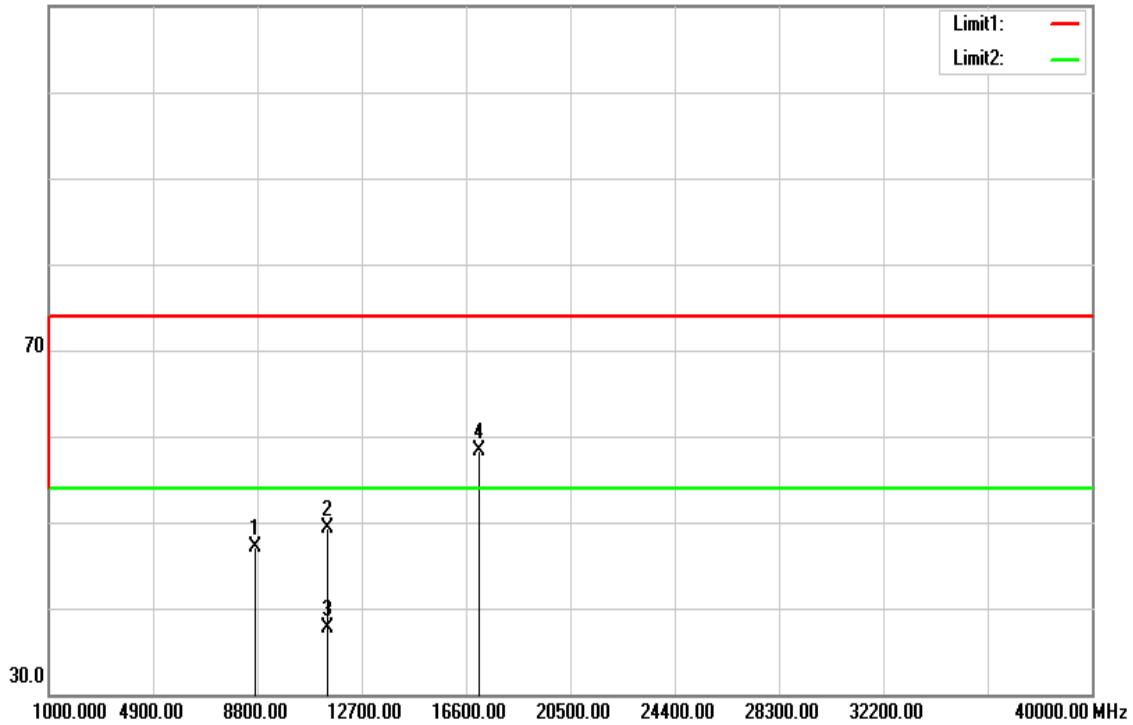

Operation Mode: Tx / IEEE 802.11n HT 20 MHz mode / CH High **Test Date:** September 14, 2016

Temperature: 27°C

Tested by: Dennis Li

Humidity: 53% RH

Polarity: Ver. / Hor.

Frequency (MHz)	Reading (dBuV)	Correction (dB/m)	Result (dBuV/m)	Limit (dBuV/m)	Margin (dB)	Remark	Ant.Pol. (H/V)
8700.000	33.61	13.73	47.34	74.00	-26.66	peak	V
11400.000	31.82	16.77	48.59	74.00	-25.41	peak	V
11400.000	20.59	16.77	37.36	54.00	-16.64	AVG	V
17100.000	33.12	24.75	57.87	74.00	-16.13	peak	V
N/A							
8700.000	33.35	13.73	47.08	74.00	-26.92	peak	H
11400.000	32.63	16.77	49.40	74.00	-24.60	peak	H
11400.000	20.99	16.77	37.76	54.00	-16.24	AVG	H
17100.000	33.61	24.75	58.36	74.00	-15.64	peak	H
N/A							

Remark:

1. *Measuring frequencies from 1 GHz to the 10th harmonic of highest fundamental frequency.*
2. *Radiated emissions measured in frequency above 1000MHz were made with an instrument using peak/average detector mode.*
3. *Average test would be performed if the peak result were greater than the average limit or as required by the applicant.*
4. *Data of measurement within this frequency range shown “ --- ” in the table above means the reading of emissions are attenuated more than 20dB below the permissible limits or the field strength is too small to be measured.*
5. *Measurements above show only up to 6 maximum emissions noted, or would be lesser, with “ N/A ” remark, if no specific emissions from the EUT are recorded (ie: margin>20dB from the applicable limit) and considered that's already beyond the background noise floor.*
6. *Margin (dB) = Remark result (dBuV/m) – Average limit (dBuV/m).*

Tx / IEEE 802.11n HT 40 MHz mode / CH Low

Polarity: Vertical

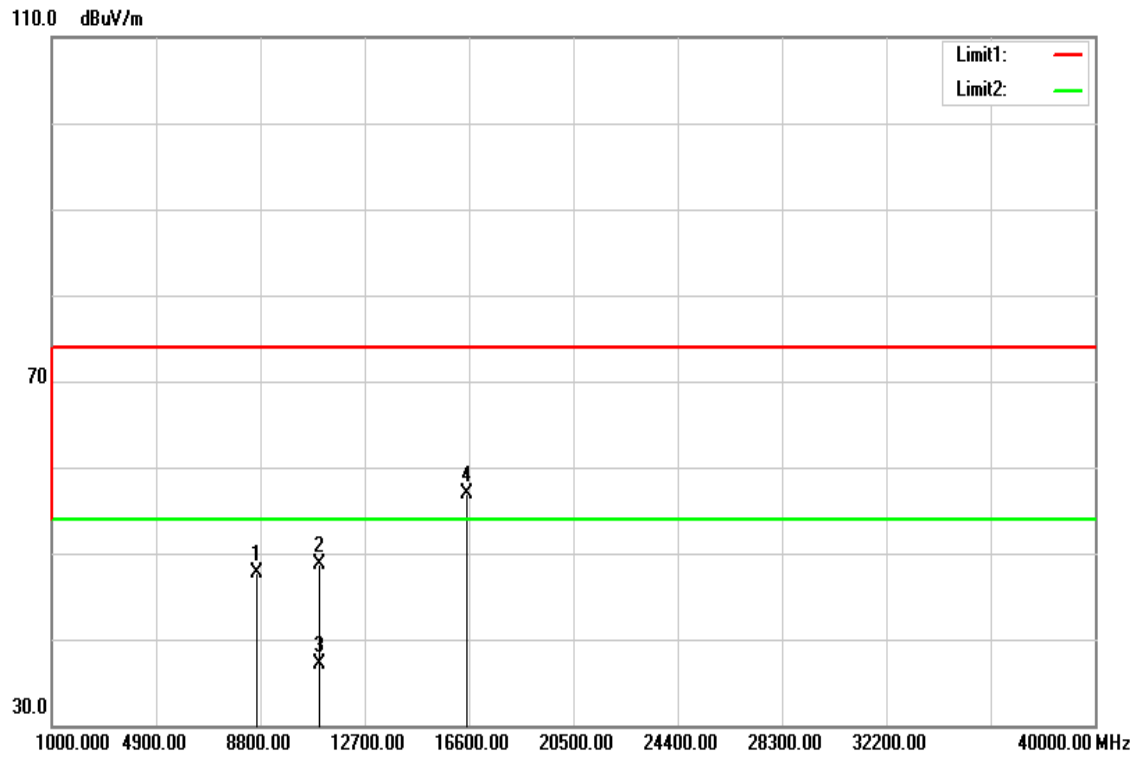

Polarity: Horizontal

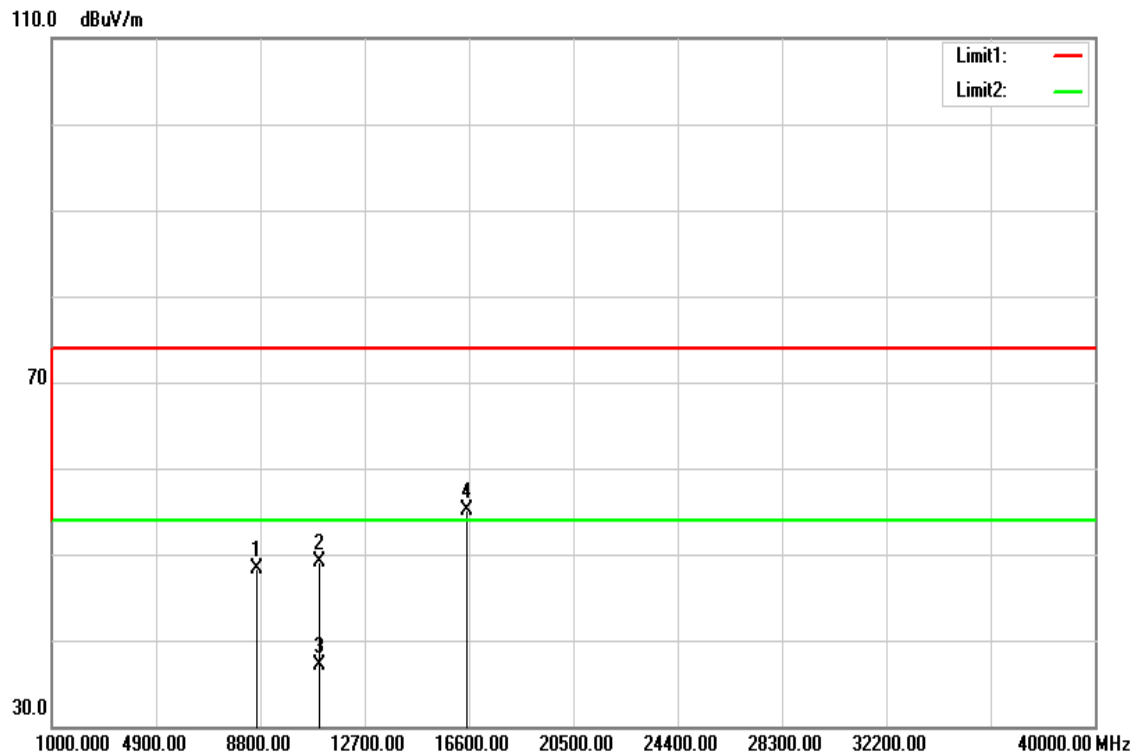

Operation Mode:Tx / IEEE 802.11n HT 40 MHz mode / CH Low **Test Date:** September 14, 2016

Temperature: 27°C

Tested by:Dennis Li

Humidity: 53% RH

Polarity: Ver. / Hor.

Frequency (MHz)	Reading (dBuV)	Correction (dB/m)	Result (dBuV/m)	Limit (dBuV/m)	Margin (dB)	Remark	Ant.Pol. (H/V)
8650.000	34.03	13.71	47.74	74.00	-26.26	peak	V
11020.000	31.97	16.73	48.70	74.00	-25.30	peak	V
11020.000	20.28	16.73	37.01	54.00	-16.99	AVG	V
16530.000	35.37	21.57	56.94	74.00	-17.06	peak	V
N/A							
8680.000	34.51	13.72	48.23	74.00	-25.77	peak	H
11020.000	32.40	16.73	49.13	74.00	-24.87	peak	H
11020.000	20.42	16.73	37.15	54.00	-16.85	AVG	H
16530.000	33.58	21.57	55.15	74.00	-18.85	peak	H
N/A							

Remark:

1. *Measuring frequencies from 1 GHz to the 10th harmonic of highest fundamental frequency.*
2. *Radiated emissions measured in frequency above 1000MHz were made with an instrument using peak/average detector mode.*
3. *Average test would be performed if the peak result were greater than the average limit or as required by the applicant.*
4. *Data of measurement within this frequency range shown “ --- ” in the table above means the reading of emissions are attenuated more than 20dB below the permissible limits or the field strength is too small to be measured.*
5. *Measurements above show only up to 6 maximum emissions noted, or would be lesser, with “ N/A ” remark, if no specific emissions from the EUT are recorded (ie: margin>20dB from the applicable limit) and considered that's already beyond the background noise floor.*
6. *Margin (dB) = Remark result (dBuV/m) – Average limit (dBuV/m).*

Tx / IEEE 802.11n HT 40 MHz mode / CH Mid

Polarity: Vertical

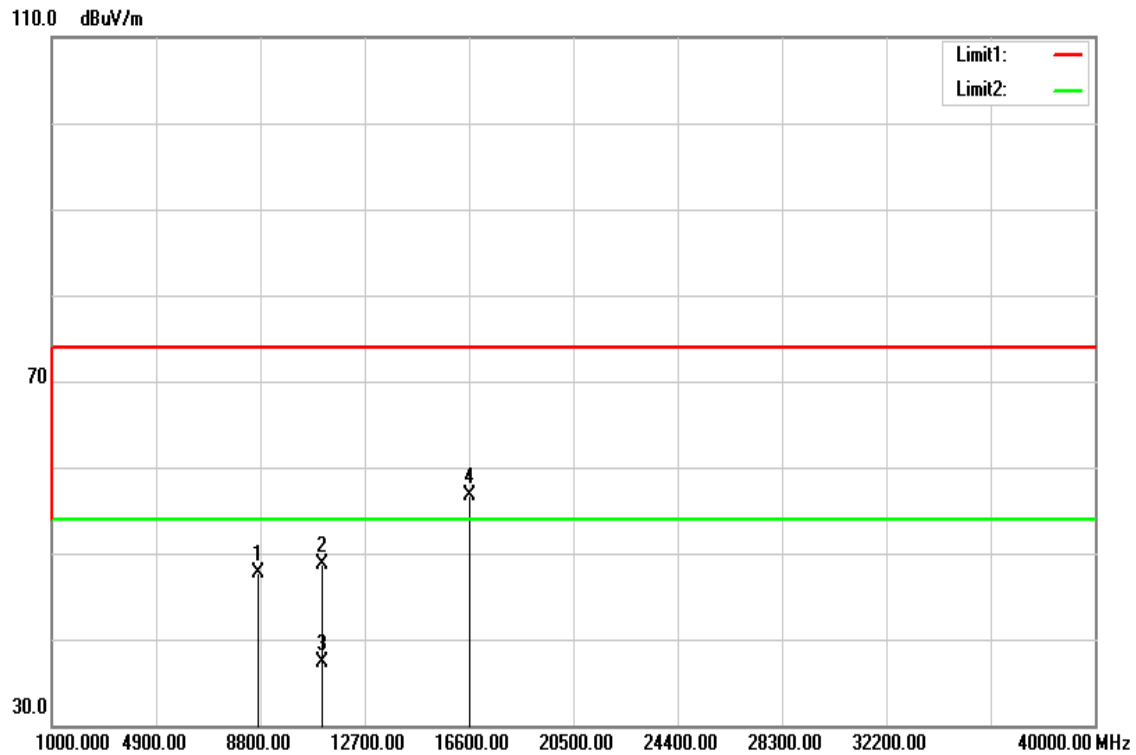

Polarity: Horizontal

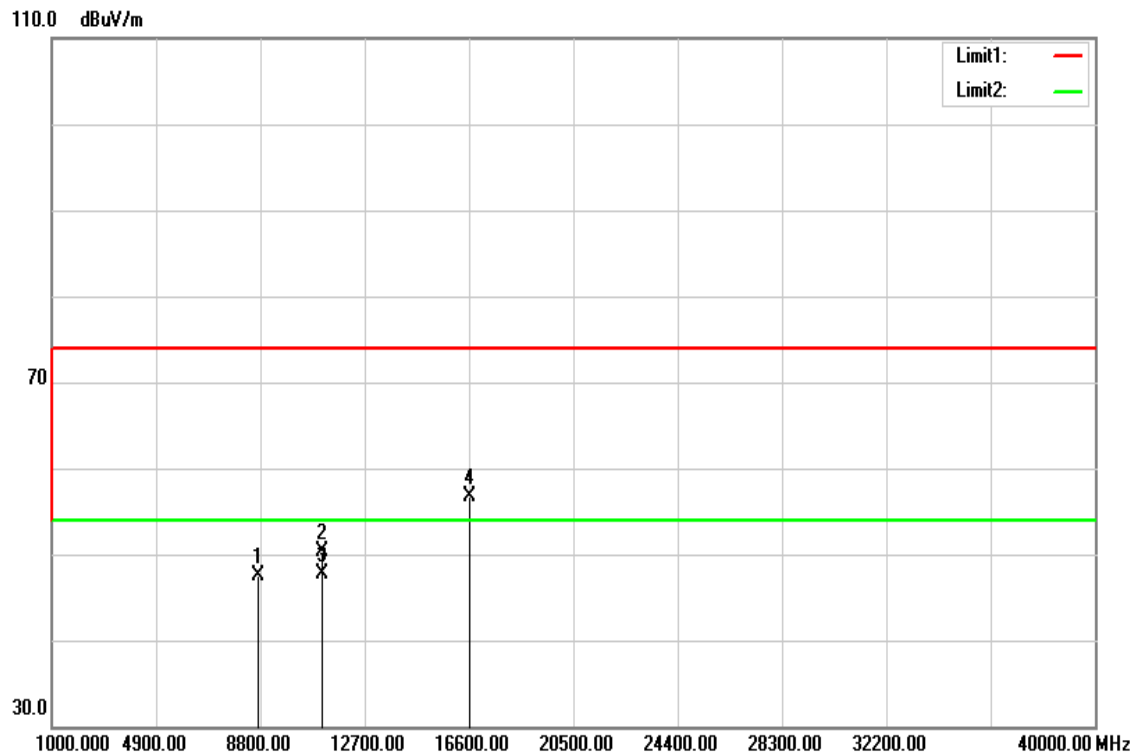

Operation Mode: Tx / IEEE 802.11n HT 40 MHz mode / CH Mid **Test Date:** September 14, 2016

Temperature: 27°C

Tested by: Dennis Li

Humidity: 53% RH

Polarity: Ver. / Hor.

Frequency (MHz)	Reading (dBuV)	Correction (dB/m)	Result (dBuV/m)	Limit (dBuV/m)	Margin (dB)	Remark	Ant.Pol. (H/V)
8700.000	34.04	13.73	47.77	74.00	-26.23	peak	V
11100.000	31.95	16.74	48.69	74.00	-25.31	peak	V
11100.000	20.48	16.74	37.22	54.00	-16.78	AVG	V
16650.000	34.38	22.28	56.66	74.00	-17.34	peak	V
N/A							
8700.000	33.84	13.73	47.57	74.00	-26.43	peak	H
11100.000	33.55	16.74	50.29	74.00	-23.71	peak	H
11100.000	31.02	16.74	47.76	54.00	-6.24	AVG	H
16650.000	34.50	22.28	56.78	74.00	-17.22	peak	H
N/A							

Remark:

1. Measuring frequencies from 1 GHz to the 10th harmonic of highest fundamental frequency.
2. Radiated emissions measured in frequency above 1000MHz were made with an instrument using peak/average detector mode.
3. Average test would be performed if the peak result were greater than the average limit or as required by the applicant.
4. Data of measurement within this frequency range shown " --- " in the table above means the reading of emissions are attenuated more than 20dB below the permissible limits or the field strength is too small to be measured.
5. Measurements above show only up to 6 maximum emissions noted, or would be lesser, with " N/A " remark, if no specific emissions from the EUT are recorded (ie: margin>20dB from the applicable limit) and considered that's already beyond the background noise floor.
6. Margin (dB) = Remark result (dBuV/m) – Average limit (dBuV/m).

Tx / IEEE 802.11n HT 40 MHz mode / CH High

Polarity: Vertical

110.0 dBuV/m

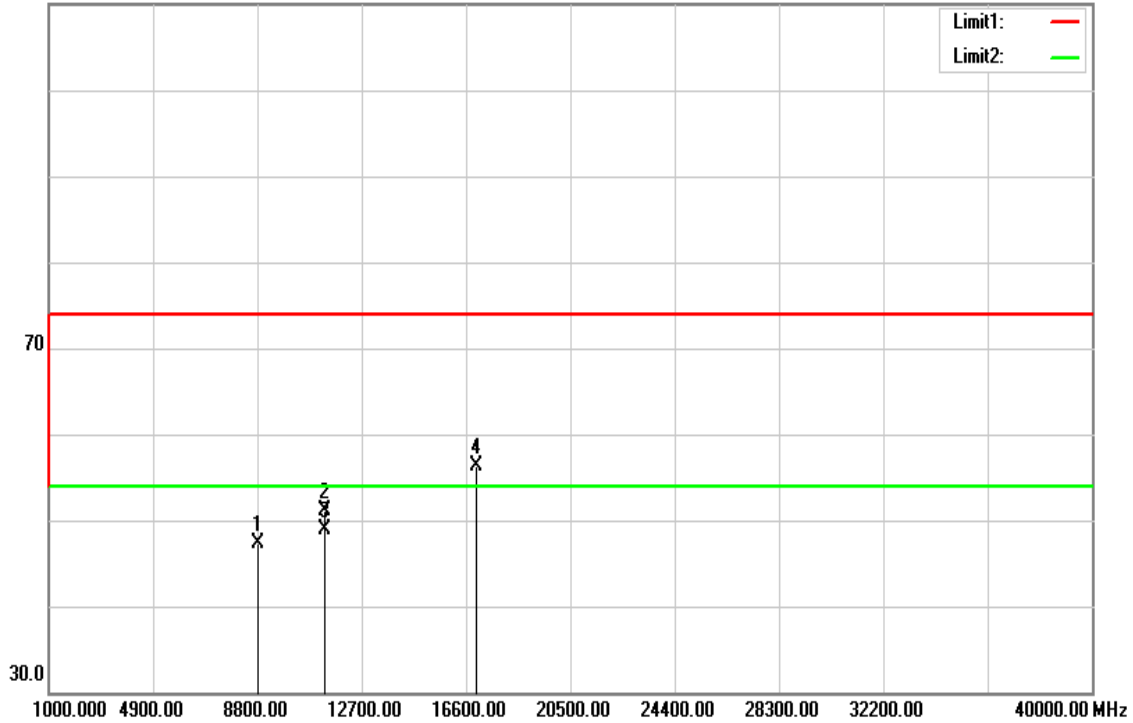

Polarity: Horizontal

110.0 dBuV/m

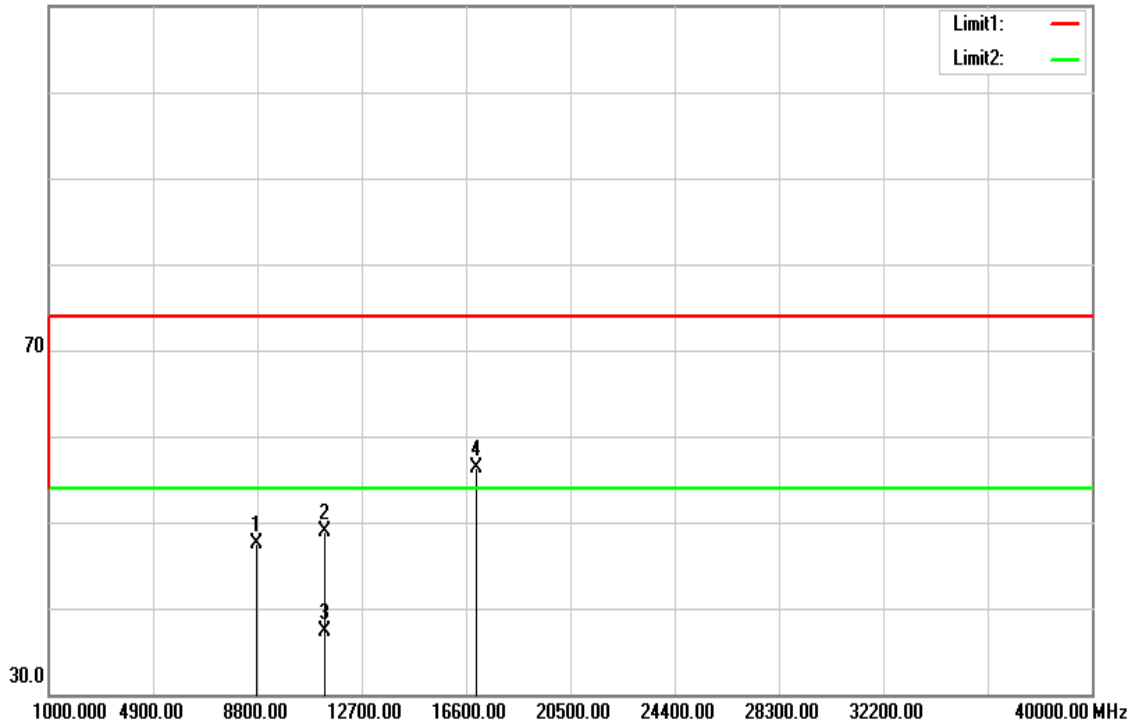

Operation Mode: Tx / IEEE 802.11n HT 40 MHz mode / CH High **Test Date:** September 14, 2016

Temperature: 27°C

Tested by: Dennis Li

Humidity: 53% RH

Polarity: Ver. / Hor.

Frequency (MHz)	Reading (dBuV)	Correction (dB/m)	Result (dBuV/m)	Limit (dBuV/m)	Margin (dB)	Remark	Ant.Pol. (H/V)
8800.000	33.55	13.78	47.33	74.00	-26.67	peak	V
11340.000	34.28	16.76	51.04	74.00	-22.96	peak	V
11340.000	32.08	16.76	48.84	54.00	-5.16	AVG	V
17010.000	31.91	24.40	56.31	74.00	-17.69	peak	V
N/A							
8750.000	33.70	13.75	47.45	74.00	-26.55	peak	H
11340.000	32.17	16.76	48.93	74.00	-25.07	peak	H
11340.000	20.56	16.76	37.32	54.00	-16.68	AVG	H
17010.000	31.99	24.40	56.39	74.00	-17.61	peak	H
N/A							

Remark:

1. *Measuring frequencies from 1 GHz to the 10th harmonic of highest fundamental frequency.*
2. *Radiated emissions measured in frequency above 1000MHz were made with an instrument using peak/average detector mode.*
3. *Average test would be performed if the peak result were greater than the average limit or as required by the applicant.*
4. *Data of measurement within this frequency range shown “ --- ” in the table above means the reading of emissions are attenuated more than 20dB below the permissible limits or the field strength is too small to be measured.*
5. *Measurements above show only up to 6 maximum emissions noted, or would be lesser, with “ N/A ” remark, if no specific emissions from the EUT are recorded (ie: margin>20dB from the applicable limit) and considered that's already beyond the background noise floor.*
6. *Margin (dB) = Remark result (dBuV/m) – Average limit (dBuV/m).*

7.7 POWERLINE CONDUCTED EMISSIONS

LIMIT

According to §15.207(a) & RSS-Gen §8.8, for an intentional radiator that is designed to be connected to the public utility (AC) power line, the radio frequency voltage that is conducted back onto the AC power line on any frequency or frequencies within the band 150 kHz to 30 MHz shall not exceed the limits in the following table, as measured using a 50 μ H/50 ohms line impedance stabilization network (LISN). Compliance with the provisions of this paragraph shall be based on the measurement of the radio frequency voltage between each power line and ground at the power terminal. The lower limit applies at the boundary between the frequency ranges.

Frequency Range (MHz)	Limits (dB μ V)	
	Quasi-peak	Average
0.15 to 0.50	66 to 56*	56 to 46*
0.50 to 5	56	46
5 to 30	60	50

* Decreases with the logarithm of the frequency.

Test Configuration

See test photographs attached in Appendix II for the actual connections between EUT and support equipment.

TEST PROCEDURE

1. The EUT was placed on a table, which is 0.8m above ground plane.
2. Maximum procedure was performed on the six highest emissions to ensure EUT compliance.
3. Repeat above procedures until all frequency measured were complete.

Test Plots

Conducted emissions (Line 1)

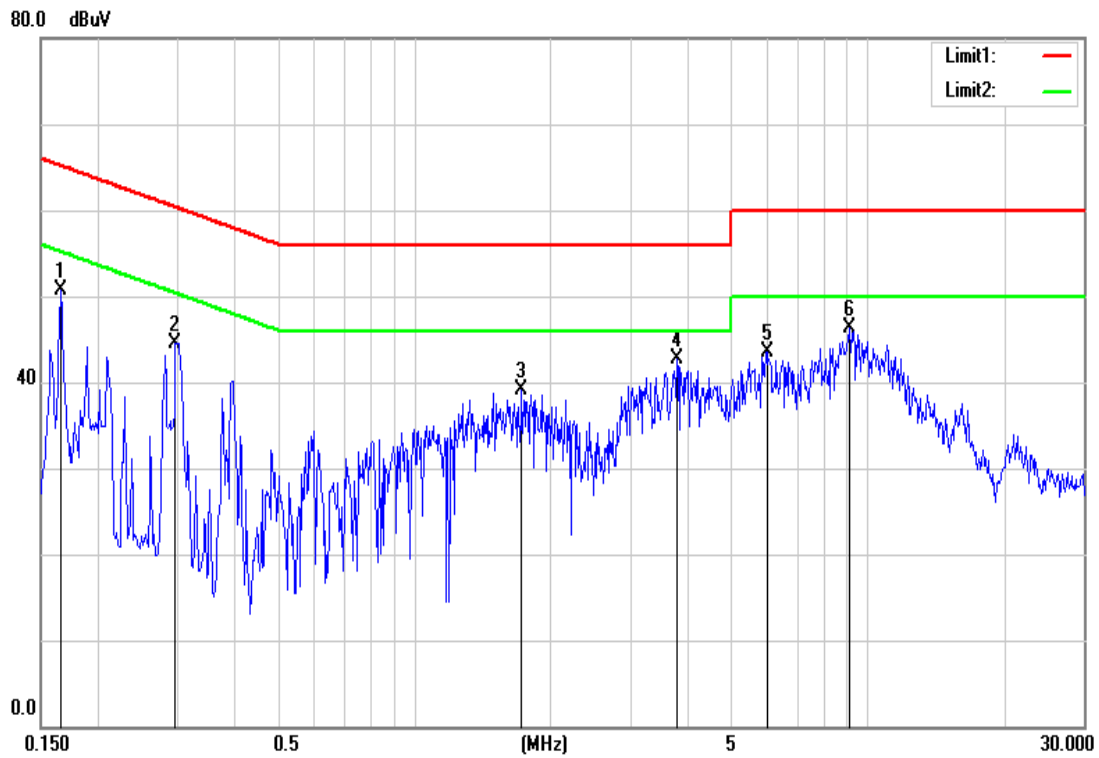

Conducted emissions (Line 2)

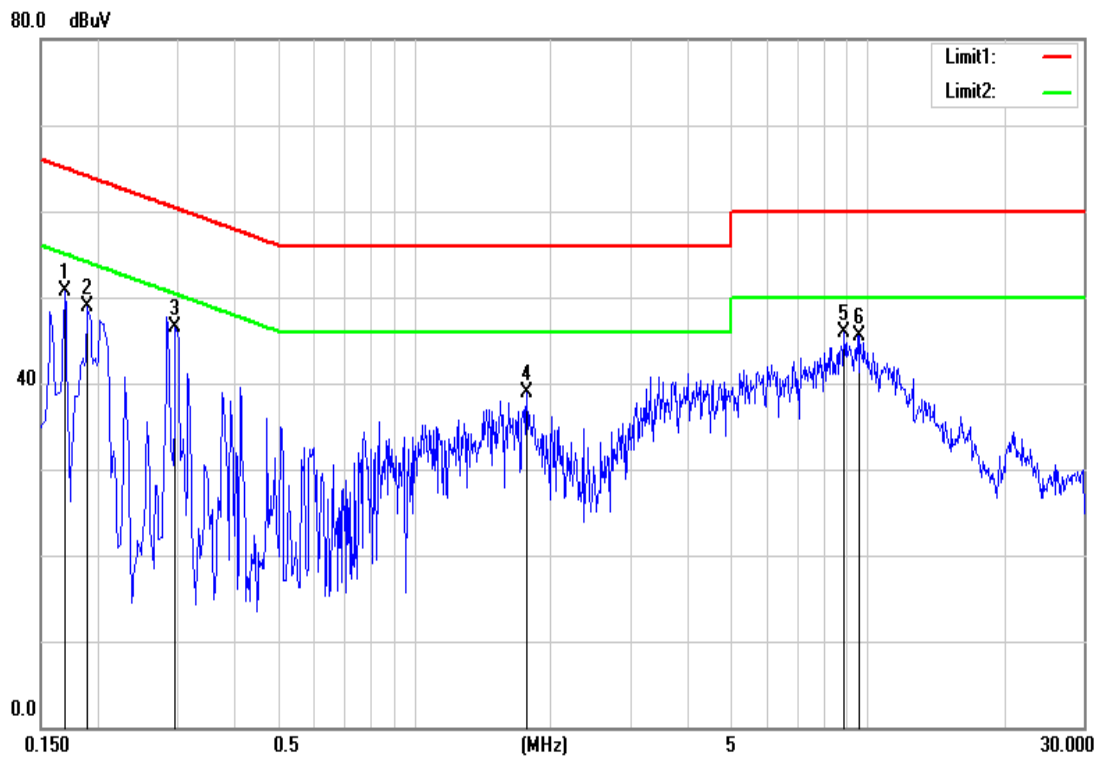

7.8 FREQUENCY STABILITY

LIMIT

According to §15.407(g) & RSS-247, manufacturers of U-NII devices are responsible for ensuring frequency stability such that an emission is maintained within the band of operation under all conditions of normal operation as specified in the operational description.

Test Configuration

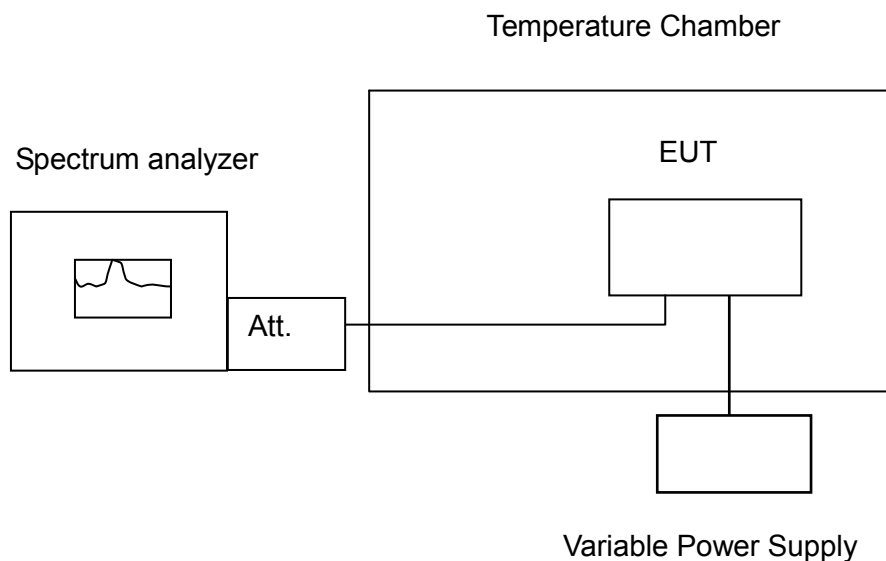

Remark: Measurement setup for testing on Antenna connector

TEST PROCEDURE

The equipment under test was connected to an external AC or DC power supply and input rated voltage. RF output was connected to a frequency counter or spectrum analyzer via feed through attenuators. The EUT was placed inside the temperature chamber. Set the spectrum analyzer RBW low enough to obtain the desired frequency resolution and measure EUT 20°C operating frequency as reference frequency. Turn EUT off and set the chamber temperature to -20°C. After the temperature stabilized for approximately 30 minutes recorded the frequency. Repeat step measure with 10°C increased per stage until the highest temperature of +50°C reached.

TEST RESULTS

No non-compliance noted.

Operating Frequency: 5220 MHz				
Environment Temperature (°C)	Voltage (V)	Measured Frequency (MHz)	Limit (20ppm)	Test Result
50	5	5179.9284	-13.8301	Pass
40	5	5179.9252	-14.4382	Pass
30	5	5179.9238	-14.7201	Pass
20	5	5179.9188	-15.6737	Pass
10	5	5179.9204	-15.3629	Pass
0	5	5179.9499	-9.6718	Pass
-10	5	5179.9702	-5.7568	Pass
-20	5	5179.9848	-2.9344	Pass

Operating Frequency: 5220 MHz				
Environment Temperature (°C)	Voltage (V)	Measured Frequency (MHz)	Limit (20ppm)	Test Result
20	4.5	5179.9165	-16.1245	Pass
	5	5179.9188	-15.6737	Pass
	5.5	5179.9196	-15.5160	Pass

7.9 DYNAMIC FREQUENCY SELECTION

TEST PROCEDURE

According to “KDB 905462 D02 v01r 02” and “KDB 905462 D03 v01r02”

LIMIT

According to §15.407 (h) and FCC 06-96 appendix “compliance measurement procedures for unlicensed-national information infrastructure devices operating in the 5250-5350 MHz and 5470-5725 MHz bands incorporating dynamic frequency selection”.

Remark: IC RSS-247 is closely harmonized with FCC Part 15 DFS rules.

Table 1: Applicability of DFS requirements prior to use of a channel

Requirement	Operational Mode		
	Master	Client (without radar detection)	Client(with radar detection)
Non-Occupancy Period	Yes	Not required	Yes
DFS Detection Threshold	Yes	Not required	Yes
Channel Availability Check Time	Yes	Not required	Not required
U-NII Detection Bandwidth	Yes	Not required	Yes

Table 2: Applicability of DFS requirements during normal operation

Requirement	Operational Mode	
	Master Device or Client with Radar Detection	Client Without Radar Detection
DFS Detection Threshold	Yes	Not required
Channel Closing Transmission Time	Yes	Yes
Channel Move Time	Yes	Yes
U-NII Detection Bandwidth	Yes	Not required

Table 3: Interference Threshold values, Master or Client incorporating In-Service

Maximum Transmit Power	Value (See Notes 1, 2, and 3)
EIRP ≥ 200 milliwatt	-64 dBm
EIRP < 200 milliwatt and power spectral density < 10 dBm/MHz	-62 dBm
EIRP < 200 milliwatt that do not meet the power spectral density requirement	-64 dBm

Note 1: This is the level at the input of the receiver assuming a 0 dBi receive antenna.

Note 2: Throughout these test procedures an additional 1 dB has been added to the amplitude of the test transmission waveforms to account for variations in measurement equipment. This will ensure that the test signal is at or above the detection threshold level to trigger a DFS response.

Note3: EIRP is based on the highest antenna gain. For MIMO devices refer to KDB Publication 662911 D01.

Table 4: DFS Response requirement values

Parameter	Value
Non-occupancy period	Minimum 30 minutes
Channel Availability Check Time	60 seconds
Channel Move Time	10 seconds See Note 1.
Channel Closing Transmission Time	200 milliseconds + an aggregate of 60 milliseconds over remaining 10 second period. See Notes 1 and 2.
U-NII Detection Bandwidth	Minimum 100% of the U-NII 99% transmission power bandwidth. See Note 3.

Note 1: Channel Move Time and the Channel Closing Transmission Time should be performed with Radar Type 0. The measurement timing begins at the end of the Radar Type 0 burst.

Note 2: The Channel Closing Transmission Time is comprised of 200 milliseconds starting at the beginning of the Channel Move Time plus any additional intermittent control signals required to facilitate a Channel move (an aggregate of 60 milliseconds) during the remainder of the 10 second period. The aggregate duration of control signals will not count quiet periods in between transmissions.

Note 3: During the U-NII Detection Bandwidth detection test, radar type 0 should be used. For each frequency step the minimum percentage of detection is 90 percent. Measurements are performed with no data traffic.

Table 5 – Short Pulse Radar Test Waveforms

Radar Type	Pulse Width (µsec)	PRI (µsec)	Number of Pulses	Minimum Percentage of Successful Detection	Minimum Number of Trials
0	1	1428	18	See Note 1	
1	1	Test A: 15 unique PRI values randomly selected from the list of 23 PRI values in Table 5a	$\text{Roundup} \left\{ \begin{matrix} \left(\frac{1}{360} \right) \cdot \\ \left(\frac{19 \cdot 10^6}{\text{PRI}_{\mu\text{sec}}} \right) \end{matrix} \right\}$	60%	30
		Test B: 15 unique PRI values randomly selected within the range of 518-3066 µsec, with a minimum increment of 1 µsec, excluding PRI values selected in Test A			
2	1-5	150-230	23-29	60%	30
3	6-10	200-500	16-18	60%	30
4	11-20	200-500	12-16	60%	30
Aggregate (Radar Types 1-4)				80%	120

Note 1: Short Pulse Radar Type 0 should be used for the detection bandwidth test, channel move time, and channel closing time tests.

Table 6 – Long Pulse Radar Test Signal

Radar Type	Pulse Width (µsec)	Chirp Width (MHz)	PRI (µsec)	Number of Pulses per Burst	Number of Bursts	Minimum Percentage of Successful Detection	Minimum Number of Trials
5	50-100	5-20	1000-2000	1-3	8-20	80%	30

Table 7 – Frequency Hopping Radar Test Signal

Radar Type	Pulse Width (µsec)	PRI (µsec)	Pulses per Hop	Hopping Rate (kHz)	Hopping Sequence Length (msec)	Minimum Percentage of Successful Detection	Minimum Number of Trials
6	1	333	9	0.333	300	70%	30

DESCRIPTION OF EUT

Overview Of EUT With Respect To §15.407 (H) Requirements

The firmware installed in the EUT during testing was:

Firmware Rev: JEDI.MP2.mt76x2u.wifi.v3.2.1

The EUT operates over the 5250-5350 MHz range as a Client Device that does not have radar detection capability.

The EUT uses one transmitter connected to two 50-ohm coaxial antenna ports via a diversity switch. Only one antenna port is connected to the test system since the EUT has one antenna only.

The Slave device associated with the EUT during these tests does not have radar detection capability.

WLAN traffic is generated by streaming the video file TestFile.mp2 “6 ½ Magic Hours” from the Master to the Slave in full motion video mode using the media player with the V2.61 Codec package.

The EUT utilizes the 802.11a architecture, with a nominal channel bandwidth of 20 MHz.

The rated output power of the Master unit is < 23dBm (EIRP). Therefore the required interference threshold level is -62 dBm. After correction for antenna gain and procedural adjustments, the required conducted threshold at the antenna port is $-62 + 5 = -57$ dBm.

The calibrated conducted DFS Detection Threshold level is set to -57 dBm. The tested level is lower than the required level hence it provides margin to the limit.

Manufacturer’s Statement Regarding Uniform Channel Spreading

The end product implements an automatic channel selection feature at startup such that operation commences on channels distributed across the entire set of allowed 5GHz channels. This feature will ensure uniform spreading is achieved while avoiding non-allowed channels due to prior radar events.

TEST AND MEASUREMENT SYSTEM

System Overview

The measurement system is based on a conducted test method.

The short pulse and long pulse signal generating system utilizes the NTIA software. The Vector Signal Generator has been validated by the NTIA. The hopping signal generating system utilizes the CCS simulated hopping method and system, which has been validated by the DoD, FCC and NTIA. The software selects waveform parameters from within the bounds of the signal type on a random basis using uniform distribution.

The short pulse types 2, 3 and 4, and the long pulse type 5 parameters are randomized at run-time.

The hopping type 6 pulse parameters are fixed while the hopping sequence is based on the August 2005 NTIA Hopping Frequency List. The initial starting point randomized at run-time and each subsequent starting point is incremented by 475. Each frequency in the 100-length segment is compared to the boundaries of the EUT Detection Bandwidth and the software creates a hopping burst pattern in accordance with Section 7.4.1.3 Method #2 Simulated Frequency Hopping Radar Waveform Generating Subsystem of FCC 06-96 APPENDIX. The frequency of the signal generator is incremented in 1 MHz steps from FL to FH for each successive trial. This incremental sequence is repeated as required to generate a minimum of 30 total trials and to maintain a uniform frequency distribution over the entire Detection Bandwidth.

The signal monitoring equipment consists of a spectrum analyzer set to display 8001 bins on the horizontal axis. The time-domain resolution is 2 msec / bin with a 16 second sweep time, meeting the 10 second short pulse reporting criteria. The aggregate ON time is calculated by multiplying the number of bins above a threshold during a particular observation period by the dwell time per bin, with the analyzer set to peak detection and max hold. The time-domain resolution is 3 msec / bin with a 24 second sweep time, meeting the 22 second long pulse reporting criteria and allowing a minimum of 10 seconds after the end of the long pulse waveform.

Should multiple RF ports be utilized for the Master and/or Slave devices (for example, for diversity or MIMO implementations), 50 ohm termination would be removed from the splitter so that connection can be established between splitter and the Master and/or Slave devices.

Conducted Method System Block Diagram

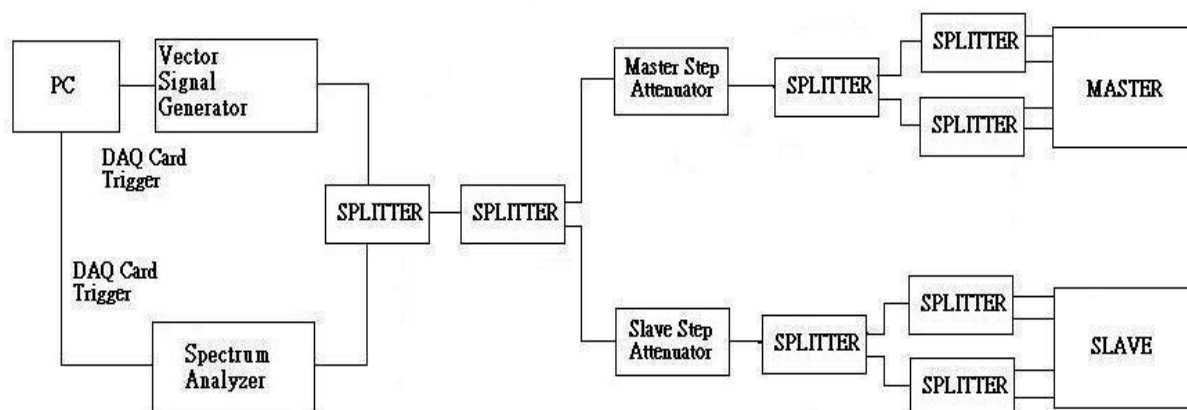

System Calibration

Connect the spectrum analyzer to the test system in place of the master device. Set the signal generator to CW mode. Adjust the amplitude of the signal generator to yield a measured level of –62 dBm on the spectrum analyzer.

Without changing any of the instrument settings, reconnect the spectrum analyzer to the Common port of the Spectrum Analyzer Combiner/Divider and connect a 50 ohm load to the Master Device port of the test system.

Measure the amplitude and calculate the difference from –62 dBm. Adjust the Reference Level Offset of the spectrum analyzer to this difference. Confirm that the signal is displayed at –62 dBm. Readjust the RBW and VBW to 3 MHz, set the span to 10 MHz, and confirm that the signal is still displayed at –62 dBm.

The spectrum analyzer displays the level of the signal generator as received at the antenna ports of the Master Device. The interference detection threshold may be varied from the calibrated value of –62 dBm and the spectrum analyzer will still indicate the level as received by the Master Device.

Set the signal generator to produce a radar waveform, trigger a burst manually and measure the level on the spectrum analyzer. Readjust the amplitude of the signal generator as required so that the peak level of the waveform is at a displayed level equal to the required or desired interference detection threshold. Separate signal generator amplitude settings are determined as required for each radar type.

Adjustment Of Displayed Traffic Level

Establish a link between the Master and Slave, adjusting the Link Step Attenuator as needed to provide a suitable received level at the Master and Slave devices. Stream the video test file to generate WLAN traffic. Confirm that the WLAN traffic level, as displayed on the spectrum analyzer, is at lower amplitude than the radar detection threshold. Confirm that the displayed traffic is from the Master Device. For Master Device testing confirm that the displayed traffic does not include Slave Device traffic. For Slave Device testing confirm that the displayed traffic does not include Master Device traffic.

If a different setting of the Master Step Attenuator is required to meet the above conditions, perform a new System Calibration for the new Master Step Attenuator setting.

Test Setup

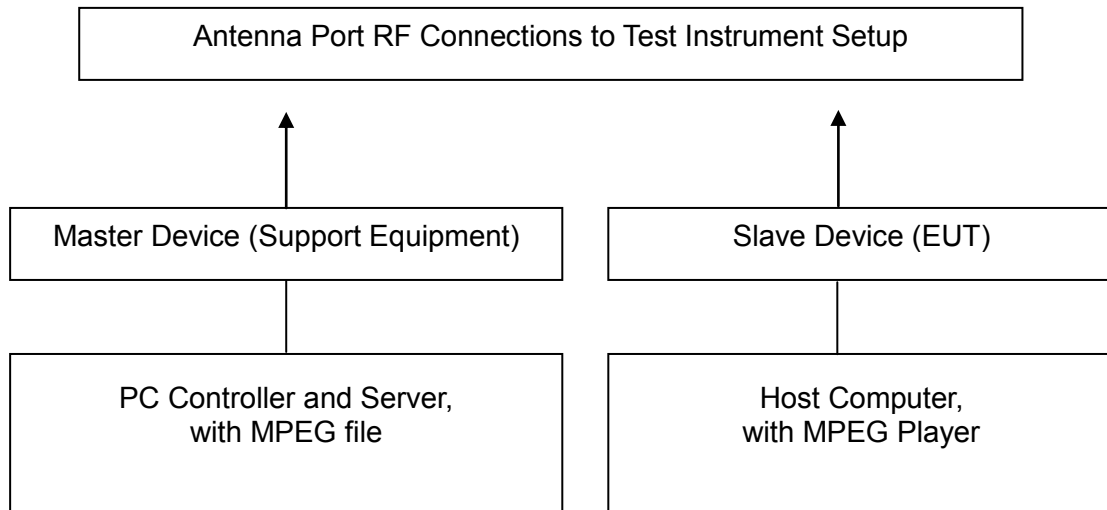

TEST RESULTS

No non-compliance noted

PLOT OF WLAN TRAFFIC FROM SLAVE

IEEE 802.11n HT 40 MHz mode / 5510MHz

Noise Floor

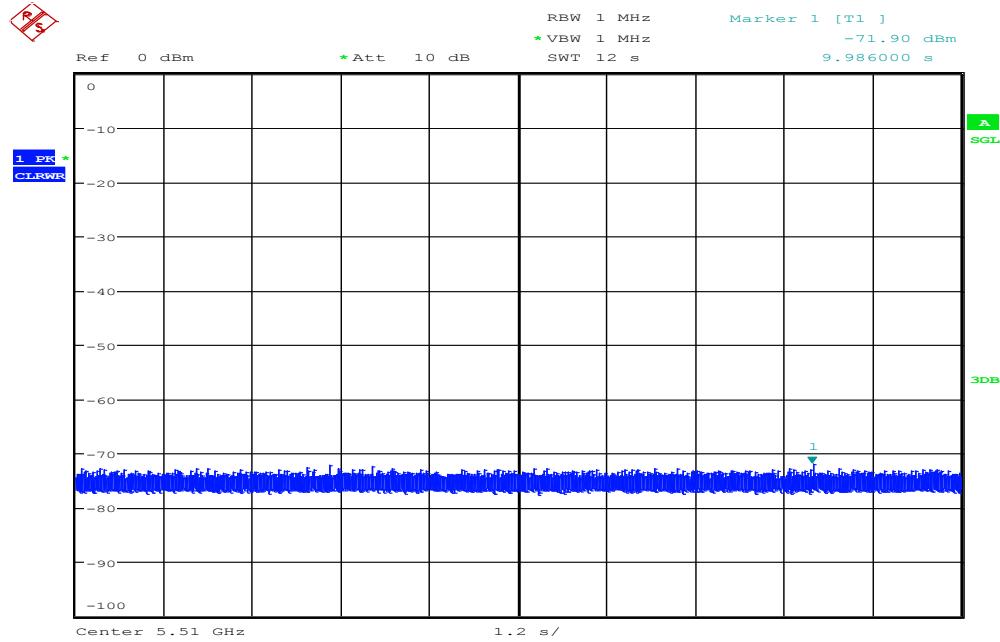

Date: 7.SEP.2016 10:45:40

Master Level

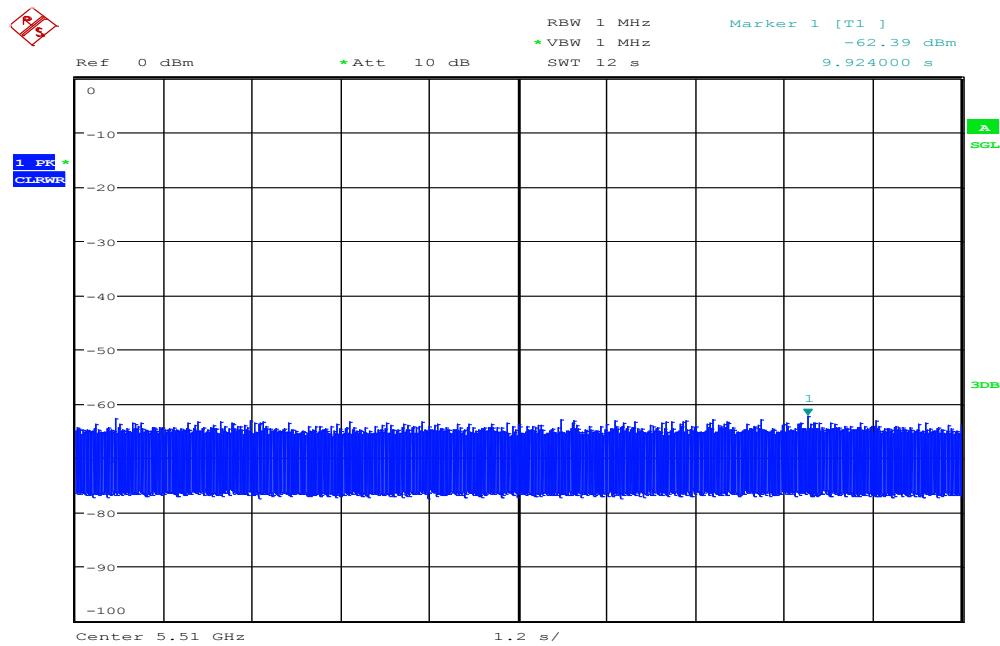

Date: 7.SEP.2016 10:40:07

Slave Level

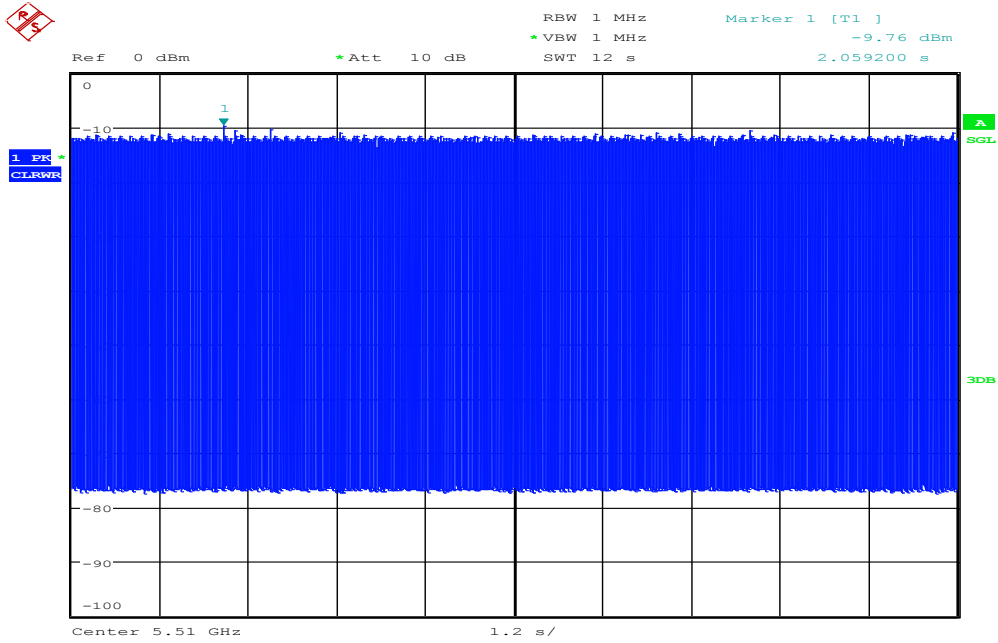

Date: 7.SEP.2016 10:45:04

TEST CHANNEL AND METHOD

All tests were performed at a channel center frequency of 5530 MHz utilizing a conducted test method.

CHANNEL MOVE TIME AND CHANNEL CLOSING TRANSMISSION TIME**GENERAL REPORTING NOTES**

The reference marker is set at the end of last radar pulse.

The delta marker is set at the end of the last WLAN transmission following the radar pulse. This delta is the channel move time.

The aggregate channel closing transmission time is calculated as follows:

Aggregate Transmission Time = (Number of analyzer bins showing transmission) * (dwell time per bin)

The observation period over which the aggregate time is calculated

Begins at (Reference Marker + 200 msec) and Ends no earlier than (Reference Marker + 10 sec).

IEEE 802.11n HT 40 MHz mode / 5510MHz

Type 1 Channel Move Time Results

No non-compliance noted.

Channel Move Time (s)	Limit (s)
-0.2	10

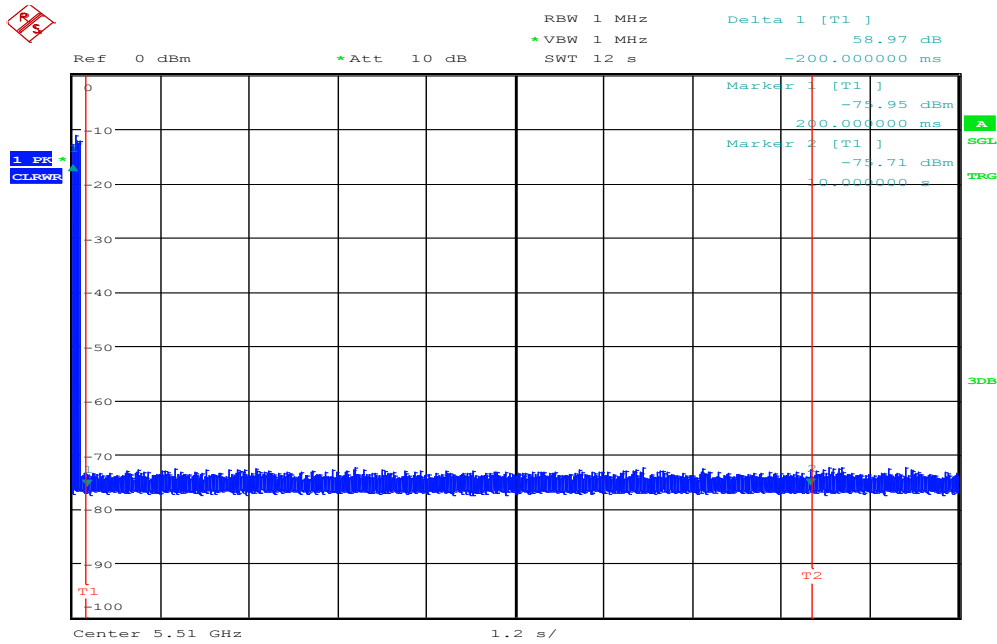

Date: 7.SEP.2016 11:58:58

Type 1 Channel Closing Transmission Time Results

No non-compliance noted.

Aggregate Transmission Time (ms)	Limit (ms)	Margin (ms)
0	60	-60

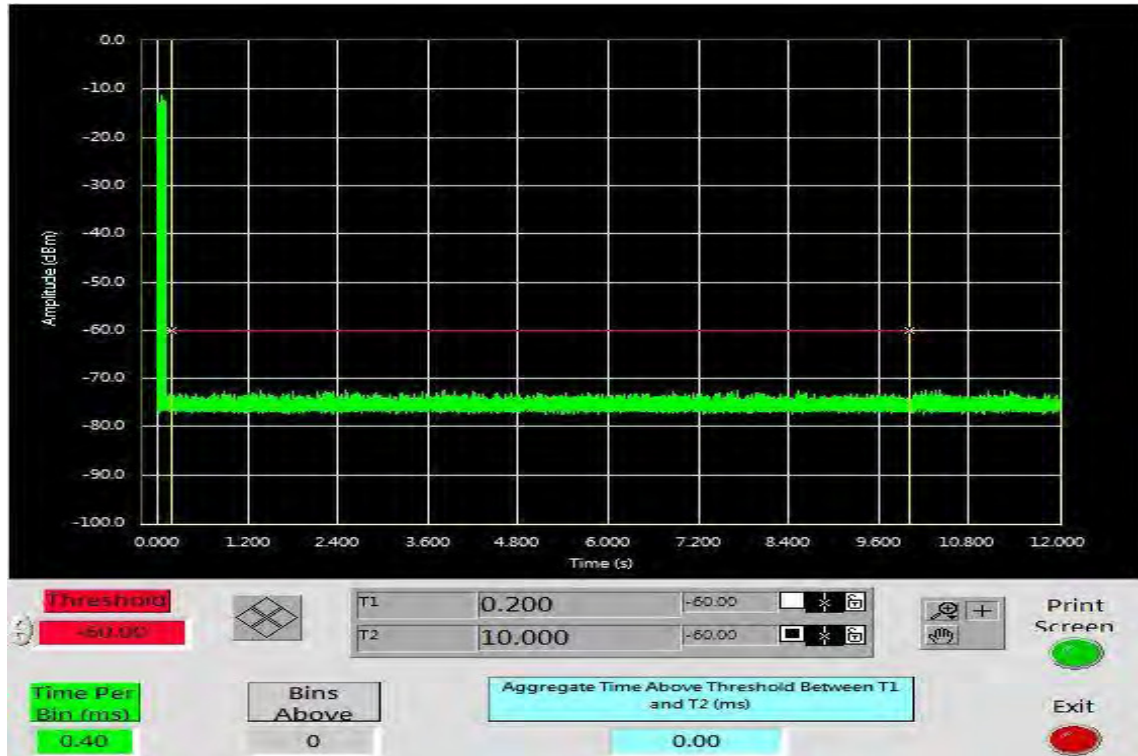

NON-OCCUPANCY PERIOD

IEEE 802.11n HT 40 MHz mode / 5510MHz

Type 1 Non-Occupancy Period Test Results

No non-compliance noted.

No EUT transmissions were observed on the test channel during the 30 minute observation time.

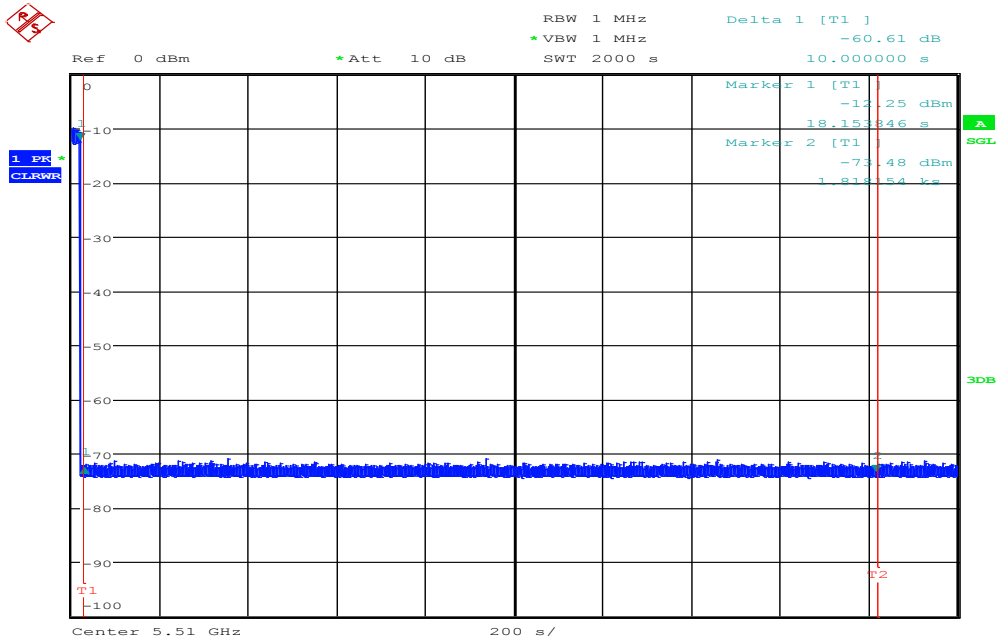

Date: 7.SEP.2016 11:39:35