

**FCC 47 CFR PART 15 SUBPART C &
INDUSTRY CANADA RSS-247**

TEST REPORT

For

Wi-Fi (11a/b/g/n 2Tx2R)+BT (V4.1LE) USB Combo Module

Model:

WCBN4515R, WCBN4515R(Ext), WCBN4515R(Emb)

Trade Name: LITE-ON

Issued to

Lite-On Technology Corp.

**Bldg. C, 90, Chien 1 Road, Chung Ho, New Taipei City 23585, Taiwan,
R.O.C**

Issued by

Compliance Certification Services Inc.

**No.11, Wugong 6th Rd., Wugu Dist.,
New Taipei City 24891, Taiwan. (R.O.C.)**

<http://www.ccsrf.com>

service@ccsrf.com

Issued Date: November 17, 2016



Testing Laboratory
1309

Note: This report shall not be reproduced except in full, without the written approval of Compliance Certification Services Inc. This document may be altered or revised by Compliance Certification Services Inc. personnel only, and shall be noted in the revision section of the document.

Revision History

Rev.	Issue Date	Revisions	Effect Page	Revised By
00	November 17, 2016	Initial Issue	ALL	Doris Chu
01	December 10, 2016	1. Add remark for Part 15.203 2. Revised BT4.0 to BT 4.1: Modulation Technique	P.5, P.7, P.8, P.20-P.21, P.42	Doris Chu

TABLE OF CONTENTS

1. TEST RESULT CERTIFICATION.....	4
2. EUT DESCRIPTION.....	5
3. TEST METHODOLOGY.....	6
3.1 EUT CONFIGURATION	6
3.2 FCC PART 15.205 RESTRICTED BANDS OF OPERATIONS.....	6
3.3 DESCRIPTION OF TEST MODES	7
3.4 THE WORST CASE POWER SETTING PARAMETER	8
4 INSTRUMENT CALIBRATION.....	9
4.1 MEASURING INSTRUMENT CALIBRATION	9
4.2 MEASUREMENT EQUIPMENT USED	9
4.3 MEASUREMENT UNCERTAINTY	10
5 FACILITIES AND ACCREDITATIONS.....	11
5.1 FACILITIES.....	11
5.2 EQUIPMENT.....	11
5.3 TABLE OF ACCREDITATIONS AND LISTINGS.....	12
6 SETUP OF EQUIPMENT UNDER TEST.....	13
6.1 SETUP CONFIGURATION OF EUT	13
6.2 SUPPORT EQUIPMENT	13
7 FCC PART 15.247 REQUIREMENTS & RSS-247 REQUIREMENTS.....	14
7.1 OCCUPIED BANDWIDTH(99%) AND 6 DB BANDWIDTH.....	14
7.2 PEAK POWER	17
7.3 AVERAGE POWER.....	18
7.4 BAND EDGES MEASUREMENT.....	19
7.5 CONDUCTED BAND EDGE AND CONDUCTED SPURIOUS EMISSION	30
7.6 PEAK POWER SPECTRAL DENSITY.....	36
7.7 RADIATED EMISSIONS.....	39
7.8 POWERLINE CONDUCTED EMISSIONS.....	59
APPENDIX I PHOTOGRAPHS OF TEST SETUP	62

1. TEST RESULT CERTIFICATION

Applicant: Lite-On Technology Corp.
Bldg. C, 90, Chien 1 Road, Chung Ho, New Taipei City 23585,
Taiwan, R.O.C

Manufacturer: LITE-ON TECHNOLOGY (Changzhou) CO., LTD
A9 Building, No.88 Yanghu Road, Wujin Hi-Tech Industrial
Development Zone, Changzhou City,
Jiangsu Province 213100 China

Equipment Under Test: Wi-Fi (11a/b/g/n 2Tx2R)+BT (V4.1LE) USB Combo Module

Model Number: WCBN4515R, WCBN4515R(Ext), WCBN4515R(Emb)

Trade Name: LITE-ON

Date of Test: September 7 ~ November 16, 2016

APPLICABLE STANDARDS	
STANDARD	TEST RESULT
FCC 47 CFR Part 15 Subpart C Industry Canada RSS-247 Issue 1	No non-compliance noted
Deviation from Applicable Standard	
N/A	

We hereby certify that:

The above equipment was tested by Compliance Certification Services Inc. The test data, data evaluation, test procedures, and equipment configurations shown in this report were made in accordance with the procedures given in ANSI C63.10: 2013 and the energy emitted by the sample EUT tested as described in this report is in compliance with the requirements set forth in the above standards.

The test results of this report relate only to the tested sample EUT identified in this report.

Approved by:



Sam Chuang
Manager
Compliance Certification Services Inc.

Tested by:

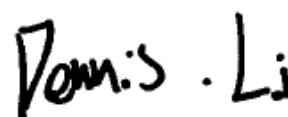

Dennis Li
Engineer
Compliance Certification Services Inc.

2. EUT DESCRIPTION

Product	Wi-Fi (11a/b/g/n 2Tx2R)+BT (V4.1LE) USB Combo Module
Model Number	WCBN4515R, WCBN4515R(Ext), WCBN4515R(Emb)
Trade Name	LITE-ON
Model Discrepancy	WCBN4515R : PCB Antenna WCBN4515R(Ext) : WiFi PCB Antenna, BT PIFA Antenna WCBN4515R(Emb) : PCB Antenna
Received Date	September 5, 2016
Power supply	Power form host device.
Frequency Range	2402MHz ~ 2480MHz
Transmit Power	6.60 dBm
Modulation Technique	BT 4.1 LE mode, GFSK (1Mbps)
Number of Channels	40 Channels
Antenna Specification	1. PCB Antenna Ant3: Gain: -0.80dBi 2. PIFA Antenna Gain:2.28 dBi
Product SW/HW version	3.3.0 / V00
Radio SW version	3.3.0
Radio HW version	V00

Remark:

1. The sample selected for test was engineering sample that approximated to production product and was provided by manufacturer.
2. This submittal(s) (test report) is intended for FCC ID: **PPQ-WCBN4515R** & ISED No. : **4491A-WCBN4515R** filing to comply with FCC Part 15C, Section 15.207, 15.209 and IC RSS-247 & RSS-GEN.
3. Antenna was meets the rule of Part 15.203 Antenna requirement.

Antenna Category	<input checked="" type="checkbox"/> Integral: antenna permanently attached <input type="checkbox"/> External dedicated antennas <input type="checkbox"/> External Unique antenna connector
-------------------------	--

3. TEST METHODOLOGY

The tests documented in this report were performed in accordance with ANSI C63.10: 2013 and FCC CFR 47 Part 15.207, 15.209, 15.247, KDB 558074 D01 DTS Meas Guidance v03r05, RSS-247, RSS-Gen.

3.1 EUT CONFIGURATION

The EUT configuration for testing is installed on RF field strength measurement to meet the Commissions requirement and operating in a manner that intends to maximize its emission characteristics in a continuous normal application.

3.2 FCC PART 15.205 RESTRICTED BANDS OF OPERATIONS

(a) Except as shown in paragraph (d) of this section, only spurious emissions are permitted in any of the frequency bands listed below:

MHz	MHz	MHz	GHz
0.090 - 0.110	16.42 - 16.423	399.9 - 410	4.5 - 5.15
¹ 0.495 - 0.505	16.69475 - 16.69525	608 - 614	5.35 - 5.46
2.1735 - 2.1905	16.80425 - 16.80475	960 - 1240	7.25 - 7.75
4.125 - 4.128	25.5 - 25.67	1300 - 1427	8.025 - 8.5
4.17725 - 4.17775	37.5 - 38.25	1435 - 1626.5	9.0 - 9.2
4.20725 - 4.20775	73 - 74.6	1645.5 - 1646.5	9.3 - 9.5
6.215 - 6.218	74.8 - 75.2	1660 - 1710	10.6 - 12.7
6.26775 - 6.26825	108 - 121.94	1718.8 - 1722.2	13.25 - 13.4
6.31175 - 6.31225	123 - 138	2200 - 2300	14.47 - 14.5
8.291 - 8.294	149.9 - 150.05	2310 - 2390	15.35 - 16.2
8.362 - 8.366	156.52475 -	2483.5 - 2500	17.7 - 21.4
8.37625 - 8.38675	156.52525	2655 - 2900	22.01 - 23.12
8.41425 - 8.41475	156.7 - 156.9	3260 - 3267	23.6 - 24.0
12.29 - 12.293	162.0125 - 167.17	3332 - 3339	31.2 - 31.8
12.51975 - 12.52025	167.72 - 173.2	3345.8 - 3358	36.43 - 36.5
12.57675 - 12.57725	240 - 285	3600 - 4400	(²)
13.36 - 13.41	322 - 335.4		

¹ Until February 1, 1999, this restricted band shall be 0.490-0.510 MHz.

² Above 38.6

(b) Except as provided in paragraphs (d) and (e), the field strength of emissions appearing within these frequency bands shall not exceed the limits shown in Section 15.209. At frequencies equal to or less than 1000 MHz, compliance with the limits in Section 15.209 shall be demonstrated using measurement instrumentation employing a CISPR quasi-peak detector. Above 1000 MHz, compliance with the emission limits in Section 15.209 shall be demonstrated based on the average value of the measured emissions. The provisions in Section 15.35 apply to these measurements.

3.3 DESCRIPTION OF TEST MODES

The EUT (model: WCBN4515R) had been tested under operating condition.

Software used to control the EUT for staying in continuous transmitting mode was programmed.

After verification, all tests were carried out with the worst case test modes as shown below except radiated spurious emission below 1GHz and power line conducted emissions below 30MHz, which worst case was in normal link mode only.

BT 4.1

Tested Channel	Frequency (MHz)
Low	2402
Mid	2440
High	2480

3.3.1 The worst mode of measurement

AC Conducted Emission	
Test Condition	AC Power line conducted emission for line and neutral
Voltage/Hz	120V/60Hz
Test Mode	Mode 1: Printed Antenna (EUT via USB link NB) Mode 2: PIFA Antenna (EUT via USB link NB)
Worst Mode	<input type="checkbox"/> Mode 1 <input checked="" type="checkbox"/> Mode 2 <input type="checkbox"/> Mode 3 <input type="checkbox"/> Mode 4

Remark: The worst mode was record in this test report.

Radiated Emission Measurement	
Test Condition	Band edge, Emission for Unwanted and Fundamental
Voltage/Hz	120V/60Hz
Test Mode	Mode 1: Printed Antenna (EUT via USB link NB) Mode 2: PIFA Antenna (EUT via USB link NB)
Worst Mode	<input checked="" type="checkbox"/> Mode 1 <input checked="" type="checkbox"/> Mode 2 <input type="checkbox"/> Mode 3 <input type="checkbox"/> Mode 4
Position	<input type="checkbox"/> Placed in fixed position. <input checked="" type="checkbox"/> Placed in fixed position at X-Plane (E2-Plane) <input type="checkbox"/> Placed in fixed position at Y-Plane (E1-Plane) <input type="checkbox"/> Placed in fixed position at Z-Plane (H-Plane)

Remark:

1. The worst mode was record in this test report.
2. The EUT pre-scanned in three axis ,X,Y, Z and two polarity, Horizontal and Vertical for radiated measurement. The worst case (X-Plane and Horizontal) were recorded in this report.

3.4 THE WORST CASE POWER SETTING PARAMETER

BT4.1

Channel	Frequency (MHz)	RF power setting in TEST SW
Low	2402	Defalut
Mid	2440	Defalut
High	2480	Defalut

4 INSTRUMENT CALIBRATION

4.1 MEASURING INSTRUMENT CALIBRATION

The measuring equipment, which was utilized in performing the tests documented herein, has been calibrated in accordance with the manufacturer's recommendations for utilizing calibration equipment, which is traceable to recognized national standards.

4.2 MEASUREMENT EQUIPMENT USED

Equipment Used for Emissions Measurement

RF Conducted Test Site					
Name of Equipment	Manufacturer	Model	Serial Number	Calibration Date	Calibration Due
Power Meter	Anritsu	ML2495A	1012009	07/04/16	07/03/17
Power Meter	Anritsu	MA2411B	917072	07/04/16	07/03/17
Spectrum Analyzer	R&S	FSV 40	101073	08/01/16	07/31/17

Wugu 966 Chamber A					
Name of Equipment	Manufacturer	Model	Serial Number	Calibration Date	Calibration Due
Spectrum Analyzer	Agilent	E4446A	US42510252	12/08/15	12/07/16
Loop Ant	COM-POWER	AL-130	121051	02/25/16	02/24/17
Bilog Antenna	Sunol Sciences	JB3	A030105	07/03/16	07/02/17
Pre-Amplifier	EMEC	EM330	60609	06/08/16	06/07/17
Horn Antenna	ETC	MCTD 1209	DRH13M02003	09/02/16	09/01/17
Antenna Tower	CCS	CC-A-1F	N/A	N.C.R	N.C.R
Controller	CCS	CC-C-1F	N/A	N.C.R	N.C.R
Turn Table	CCS	CC-T-1F	N/A	N.C.R	N.C.R
Software	EZ-EMC (CCS-3A1RE)				

Conducted Emission Room # B					
Name of Equipment	Manufacturer	Model	Serial Number	Calibration Date	Calibration Due
LISN	SCHWARZBECK	NSLK 8127	8127-541	11/23/15	11/22/16
Receiver	R&S	ESCI	101073	08/20/16	08/19/17
Software	CCS-3A1-CE				

Remark:

1. Each piece of equipment is scheduled for calibration once a year and Precision Dipole is scheduled for calibration once three years.
2. N.C.R. = No Calibration Request.

4.3 MEASUREMENT UNCERTAINTY

PARAMETER	UNCERTAINTY
Powerline Conducted Emission	+/- 1.2575
3M Semi Anechoic Chamber / 30M~200M	+/- 4.0138
3M Semi Anechoic Chamber / 200M~1000M	+/- 3.9483
3M Semi Anechoic Chamber / 1G~8G	+/- 2.5975
3M Semi Anechoic Chamber / 8G~18G	+/- 2.6112
3M Semi Anechoic Chamber / 18G~26G	+/- 2.7389
3M Semi Anechoic Chamber / 26G~40G	+/- 2.9683

Remark: This uncertainty represents an expanded uncertainty expressed at approximately the 95% confidence level using a coverage factor of $k=2$.

5 FACILITIES AND ACCREDITATIONS

5.1 FACILITIES

All measurement facilities used to collect the measurement data are located at

- No.199, Chunghsen Road, Hsintien City, Taipei Hsien, Taiwan, R.O.C.
Tel: 886-2-2217-0894 / Fax: 886-2-2217-1029
- No.11, Wugong 6th Rd., Wugu Dist., New Taipei City 24891, Taiwan. (R.O.C.)
Tel: 886-2-2299-9720 / Fax: 886-2-2298-4045
- No.81-1, Lane 210, Bade 2nd Rd., Lujhu Township, Taoyuan County 33841, TAIWAN, R.O.C.
Tel: 886-3-324-0332 / Fax: 886-3-324-5235

The sites are constructed in conformance with the requirements of ANSI C63.7, ANSI C63.10: 2013 and CISPR Publication 22.

5.2 EQUIPMENT



Radiated emissions are measured with one or more of the following types of linearly polarized antennas: tuned dipole, biconical, log periodic, bi-log, ridged waveguide, horn and/or Loop. Spectrum analyzers with pre-selectors and quasi-peak detectors are used to perform radiated measurements.

Conducted emissions are measured with Line Impedance Stabilization Networks and EMI Test Receivers.

Calibrated wideband preamplifiers, coaxial cables, and coaxial attenuators are also used for making measurements.

All receiving equipment conforms to CISPR Publication 16-1, "Radio Interference Measuring Apparatus and Measurement Methods."

5.3 TABLE OF ACCREDITATIONS AND LISTINGS

Country	Agency	Scope of Accreditation	Logo
USA	FCC	3M Semi Anechoic Chamber (FCC MRA: TW1039) to perform FCC Part 15 measurements	
Taiwan	TAF	LP0002, RTTE01, FCC Method-47 CFR Part 15 Subpart C, D, E, RSS-247, RSS-310 IDA TS SRD, AS/NZS 4268, AS/NZS 4771, TS 12.1 & 12.2, ETSI EN 300 440-1, ETSI EN 300 440-2, ETSI EN 300 328, ETSI EN 300 220-1, ETSI EN 300 220-2, ETSI EN 301 893, ETSI EN 301 489-1/3/7/17 FCC OET Bulletin 65 + Supplement C, EN 50360, EN 50361, EN 50371, RSS 102, EN 50383, EN 50385, EN 50392, IEC 62209, CNS 14958-1, CNS 14959 FCC Method -47 CFR Part 15 Subpart B IEC / EN 61000-3-2, IEC / EN 61000-3-3, IEC / EN 61000-4-2/3/4/5/6/8/11	
Canada	Industry Canada	3M Semi Anechoic Chamber (IC 2324G-1 / IC 2324G-2) to perform	

** No part of this report may be used to claim or imply product endorsement by A2LA or any agency of the US Government.*

6 SETUP OF EQUIPMENT UNDER TEST

6.1 SETUP CONFIGURATION OF EUT

See test photographs attached in Appendix I for the actual connections between EUT and support equipment.

6.2 SUPPORT EQUIPMENT

No	Equipment	Brand	Model	Series No.	FCC ID	Data Cable	Power Cord
1	Notebook PC	ASUS	M5200AE	5BN0AG019631	PD9WM3B2100	N/A	AC I/P: Unshielded, 1.8m with a core DC O/P: Unshielded, 1.8m
2	Notebook PC	IBM	7663 (T61)	L3E9812	N/A	N/A	AC I/P: Unshielded, 1.8m DC O/P: Unshielded, 1.8m with a core

Remark:

1. *All the equipment/cables were placed in the worst-case configuration to maximize the emission during the test.*
2. *Grounding was established in accordance with the manufacturer's requirements and conditions for the intended use.*

7 FCC PART 15.247 REQUIREMENTS & RSS-247 REQUIREMENTS

7.1 OCCUPIED BANDWIDTH(99%) AND 6 DB BANDWIDTH

Test Configuration

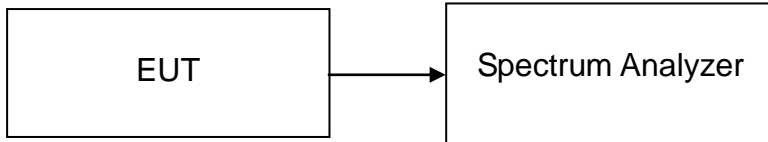

OCCUPIED BANDWIDTH(99%)

The resolution bandwidth shall be set to as close to 1% of the selected span as is possible without being below 1%. The video bandwidth shall be set to 3 times the resolution bandwidth. Video averaging is not permitted. Where practical, a sampling detector shall be used since a peak or, peak hold.

6 DB BANDWIDTH

According to §15.247(a)(2) & RSS-247, systems using digital modulation techniques may operate in the 902 - 928 MHz, 2400 - 2483.5 MHz, and 5725 - 5850 MHz bands. The minimum 6dB bandwidth shall be at least 500 kHz.

TEST PROCEDURE

1. Place the EUT on the table and set it in the transmitting mode.
2. Remove the antenna from the EUT and then connect a low loss RF cable from the antenna port to the spectrum analyzer.
3. Set the spectrum analyzer as RBW = 100 kHz, VBW= 300 kHz, Span = 3 MHz, Detector = Peak, Sweep = auto.
4. Set spectrum analyzer as OBW(99%) function.
5. Mark the peak frequency and -6dB (upper and lower) frequency.
6. Repeat until all the rest channels are investigated.

TEST RESULTS

No non-compliance noted.

Test Data

For GFSK

Channel	Frequency (MHz)	99% Bandwidth (MHz)	6dB Bandwidth (kHz)	6dB Bandwidth Limit (kHz)
Low	2402	1.0463	0.7164	>500
Mid	2440	1.0376	0.7164	
High	2480	1.0463	0.7337	

Test Plot

CH Low

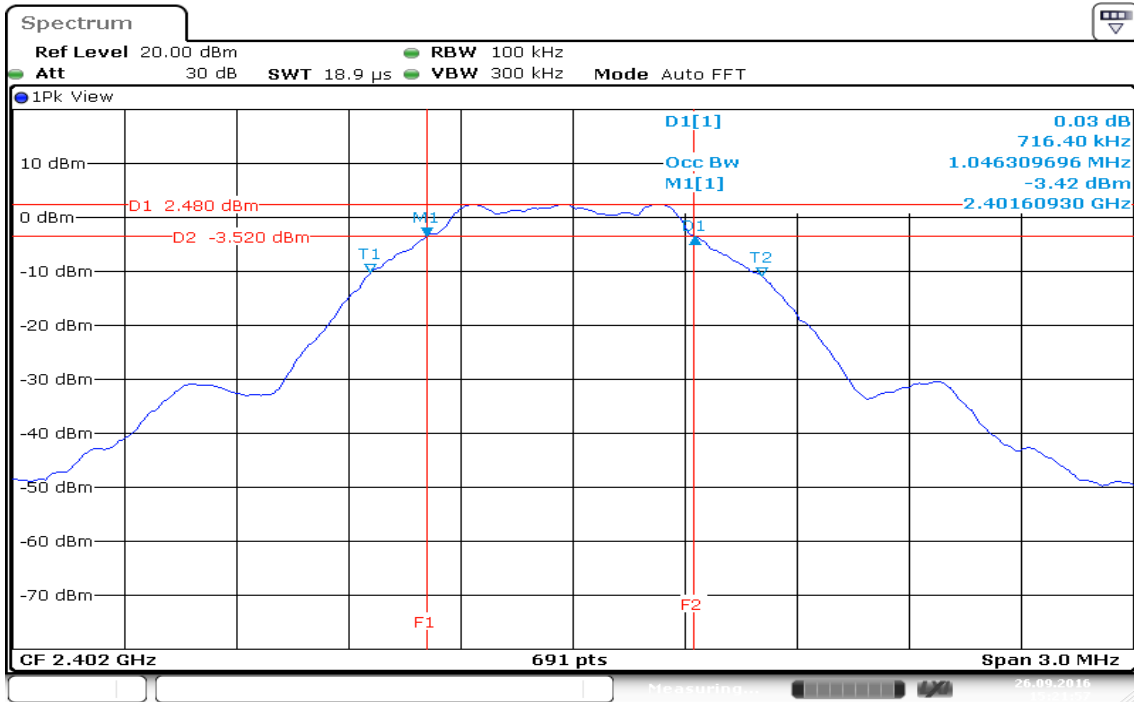

CH Mid

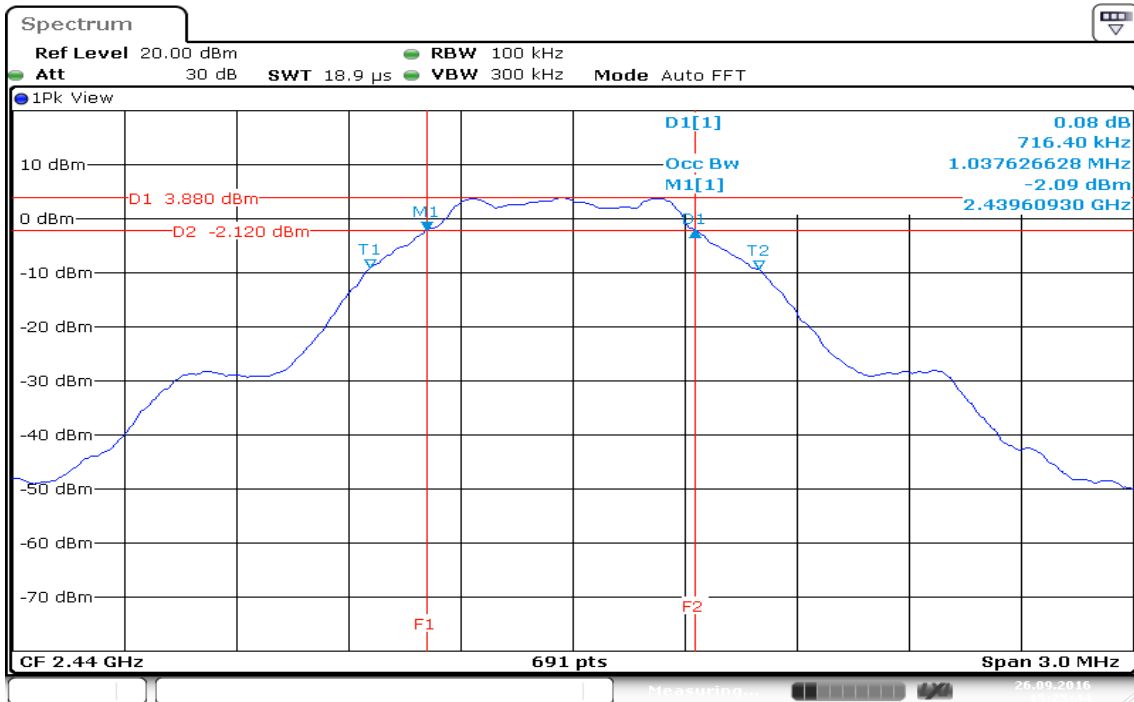

CH High

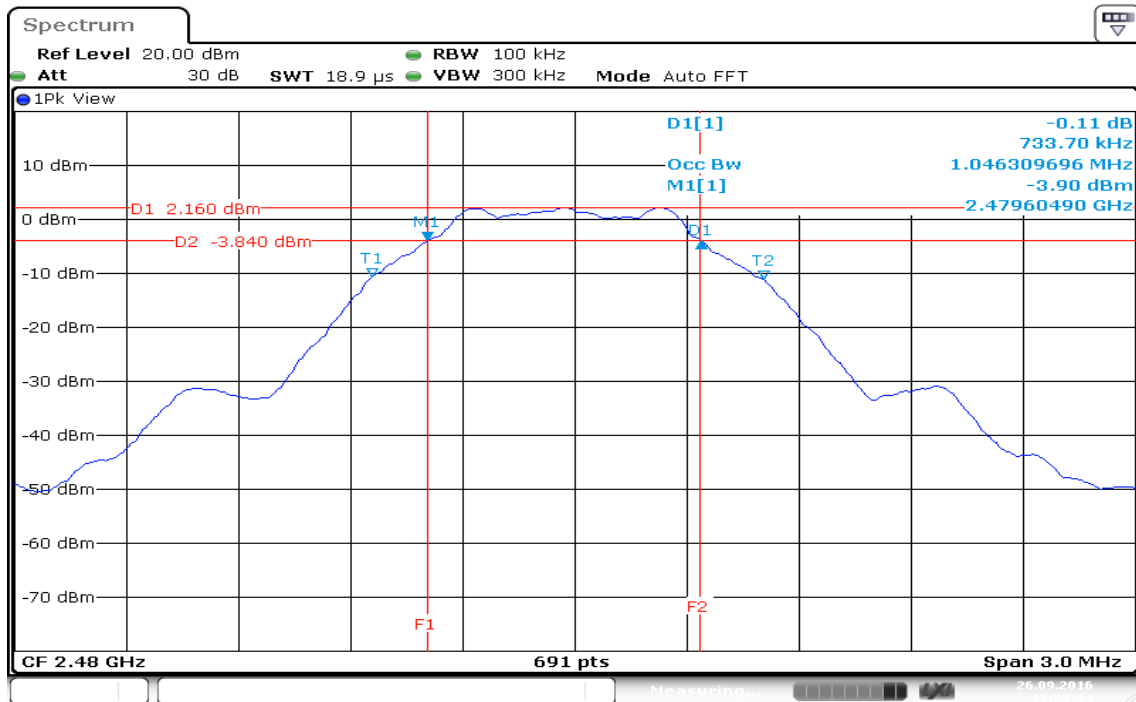

Date: 26.SEP.2016 15:29:34

7.2 PEAK POWER

LIMIT

The maximum peak output power of the intentional radiator shall not exceed the following:

1. According to §15.247(b)(3), for systems using digital modulation in the bands of 902-928 MHz, 2400-2483.5 MHz, and 5725-5850 MHz: 1 Watt.
2. According to §15.247(b)(4), the conducted output power limit specified in paragraph (b) of this section is based on the use of antennas with directional gains that do not exceed 6 dBi. Except as shown in paragraph (c) of this section, if transmitting antennas of directional gain greater than 6 dBi are used, the conducted output power from the intentional radiator shall be reduced below the stated values in paragraphs (b)(1), (b)(2), and (b)(3) of this section, as appropriate, by the amount in dB that the directional gain of the antenna exceeds 6 dBi.
3. According to RSS-247, for systems employing digital modulation techniques operating in the bands 902-928 MHz, 2400-2483.5 MHz and 5725-5850 MHz, the maximum peak conducted output power shall not exceed 1 W.

Test Configuration

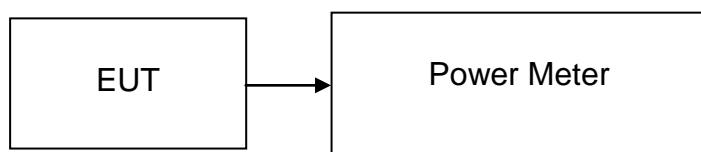

TEST PROCEDURE

The transmitter output is connected to the spectrum analyzer. Set the RBW = 1MHz , VBW = 3MHz, Detector = Peak, Trace mode = max hold, Sweep = auto couple. Record the max reading.

Repeat the above procedure until the measurements for all frequencies are completed.

TEST RESULTS

No non-compliance noted

Test Data

Channel	Frequency (MHz)	Output Power (dBm)	Output Power (W)	Limit (W)	Test Result
Low	2402	5.20	0.0033	1	PASS
Mid	2440	*6.60	0.0046		PASS
High	2480	5.06	0.0032		PASS

7.3 AVERAGE POWER

LIMIT

None; for reporting purposes only.

Test Configuration

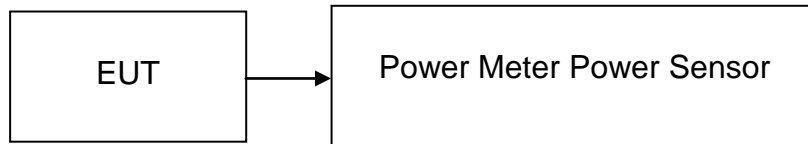

TEST PROCEDURE

The transmitter output is connected to the Power Meter. The Power Meter is set to the average power detection.

TEST RESULTS

No non-compliance noted.

Test Data

Channel	Frequency (MHz)	Output Power (dBm)	Output Power (W)
Low	2402	4.70	0.0030
Mid	2440	6.11	0.0041
High	2480	4.56	0.0029

7.4 BAND EDGES MEASUREMENT

LIMIT

According to §15.247(d) & RSS-247, in any 100 kHz bandwidth outside the frequency bands in which the spread spectrum intentional radiator is operating, the radio frequency power that is produced by the intentional radiator shall be at least 20 dB below that in the 100 kHz bandwidth within the band that contains the highest level of the desired power, based on either an RF conducted or a radiated measurement, provided the transmitter demonstrates compliance with the peak conducted power limits. In addition, radiated emissions which fall in the restricted bands, as defined in §15.205(a), must also comply with the radiated emission limits specified in 15.209(a) (see Section 15.205(c)).

Test Configuration

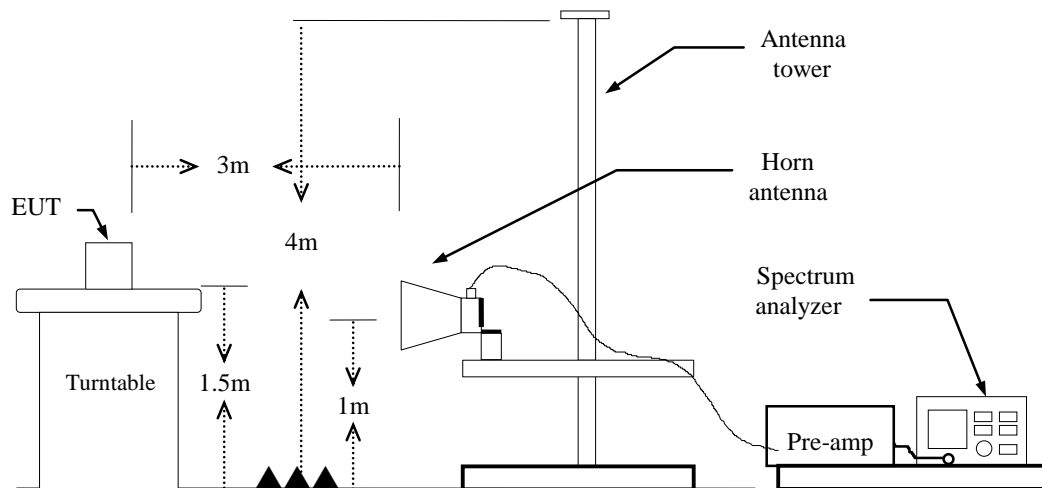

TEST PROCEDURE

For Radiated

1. The EUT is placed on a turntable, which is 1.5m above the ground plane.
2. The turntable shall be rotated for 360 degrees to determine the position of maximum emission level.
3. EUT is set 3m away from the receiving antenna, which is varied from 1m to 4m to find out the highest emission.
4. Set the spectrum analyzer in the following setting in order to capture the lower and upper band-edges of the emission:
 - (a) PEAK: RBW=1MHz / VBW=3MHz / Sweep=AUTO
 - (b) AVERAGE: RBW=1MHz,
if duty cycle \geq 98%, VBW=10Hz.
if duty cycle < 98% VBW=1/T.

For PIFA Antenna

BT4.1: = 65%, VBW= 2.7kHz

For PCB Antenna

BT4.1: = 65%, VBW= 2.7kHz

5. Repeat the procedures until all the PEAK and AVERAGE versus POLARIZATION are measured.
6. Result = Spectrum Reading + cable loss(spectrum to Amp) - Amp Gain + Cable loss(Amp to receive Ant)+ Receive Ant

DUTY CYCLE
For PIFA Antenna
BT4.1

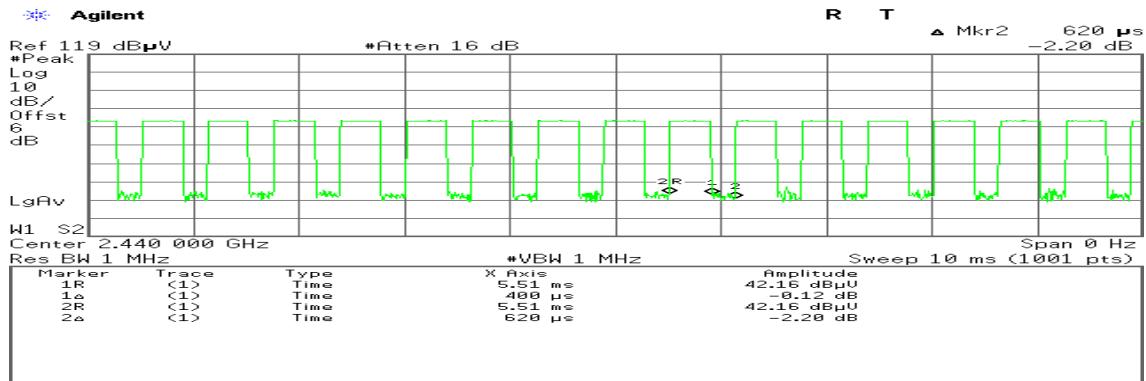

For PCB Antenna
BT4.1

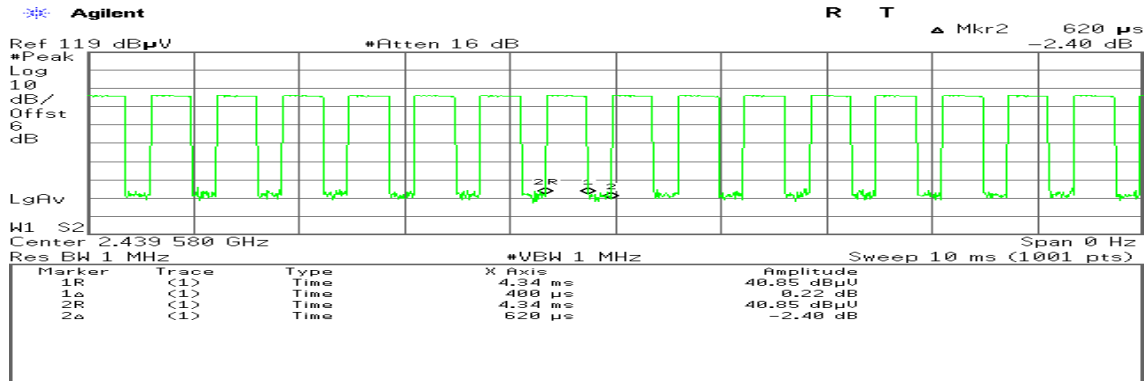

TEST RESULTS

Refer to attach spectrum analyzer data chart.

For PIFA Antenna

Band Edges (CH Low)

Detector mode: Peak

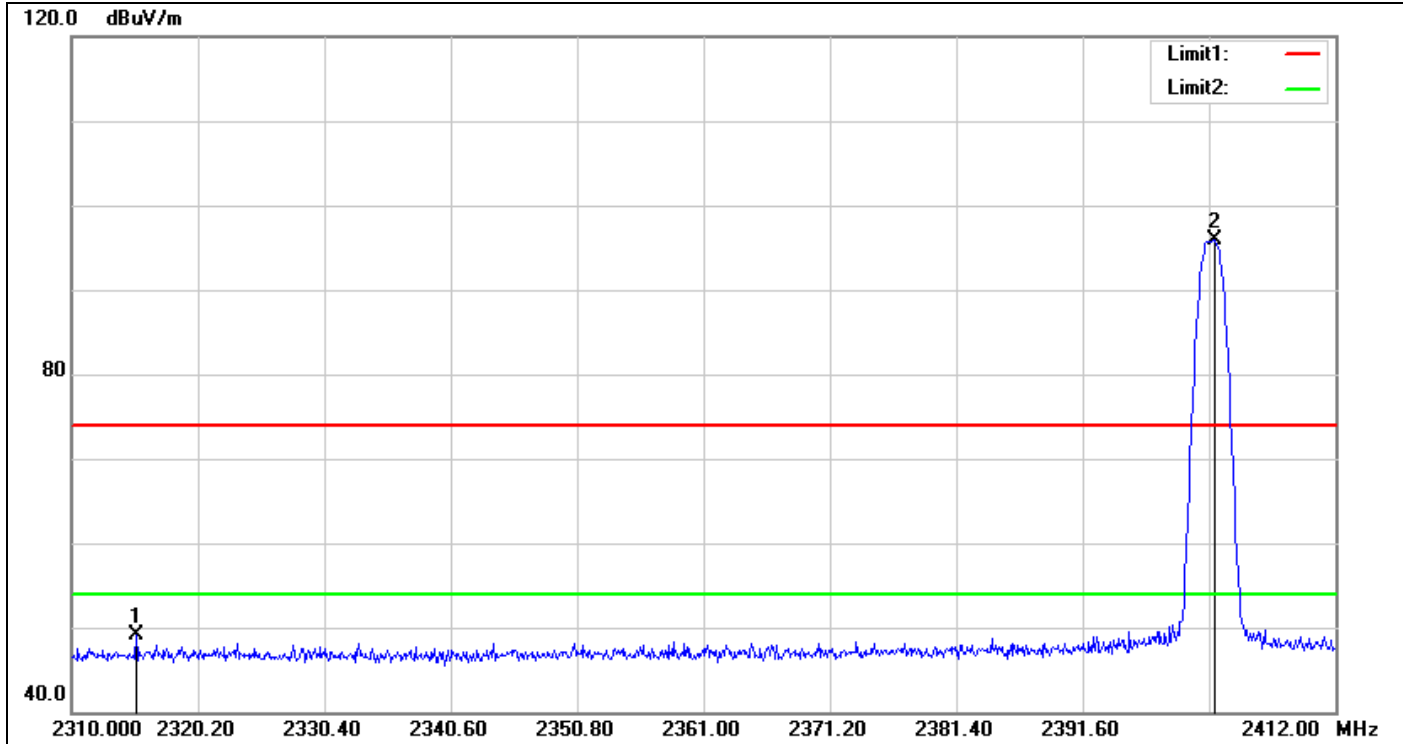

No.	Frequency (MHz)	Reading (dBuV)	Correct Factor(dB/m)	Result (dBuV/m)	Limit (dBuV/m)	Margin (dB)	Remark
1	2315.202	52.07	-2.98	49.09	74.00	-24.91	peak
2	2402.208	98.25	-2.41	95.84	-	-	peak

Detector mode: Average

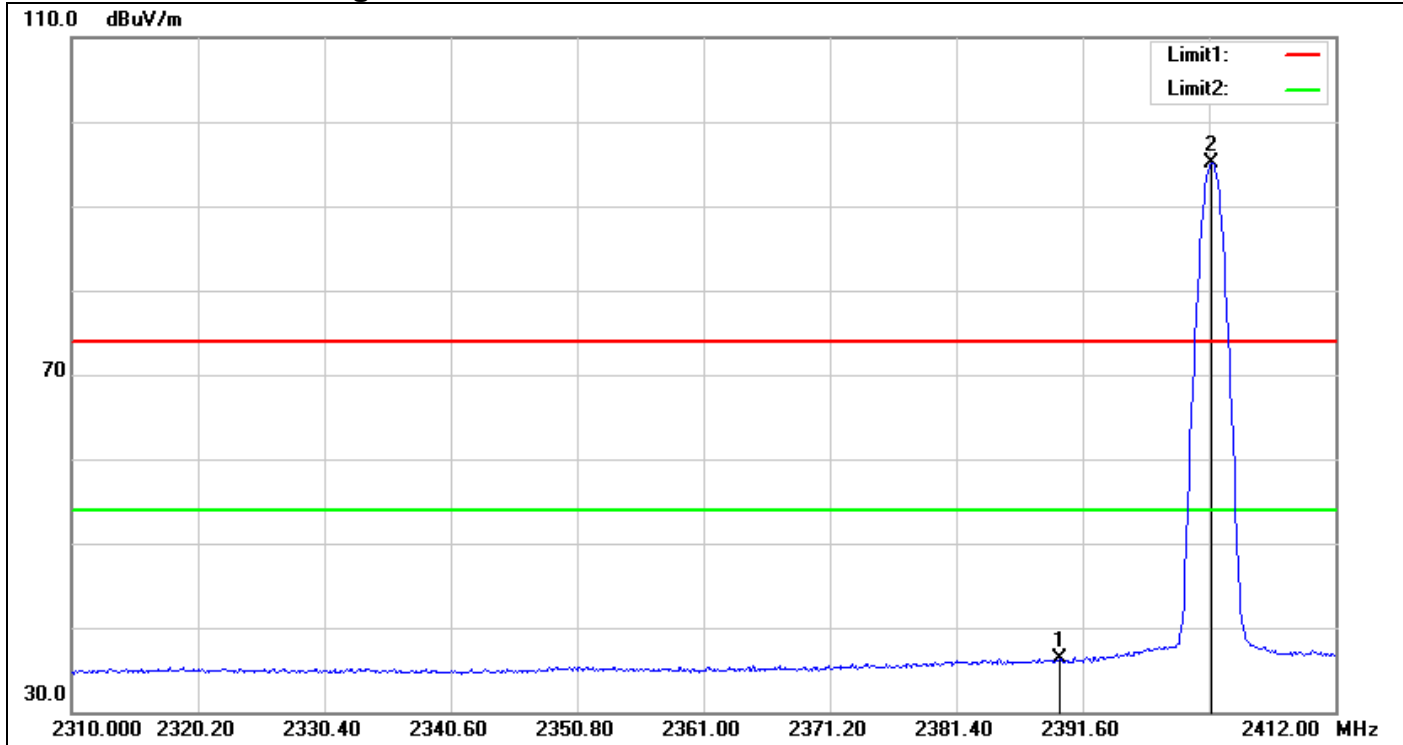

No.	Frequency (MHz)	Reading (dBuV)	Correct Factor(dB/m)	Result (dBuV/m)	Limit (dBuV/m)	Margin (dB)	Remark
1	2389.764	38.73	-2.49	36.24	54.00	-17.76	AVG
2	2402.004	97.42	-2.41	95.01	-	-	AVG

Band Edges (CH High)

Detector mode: Peak

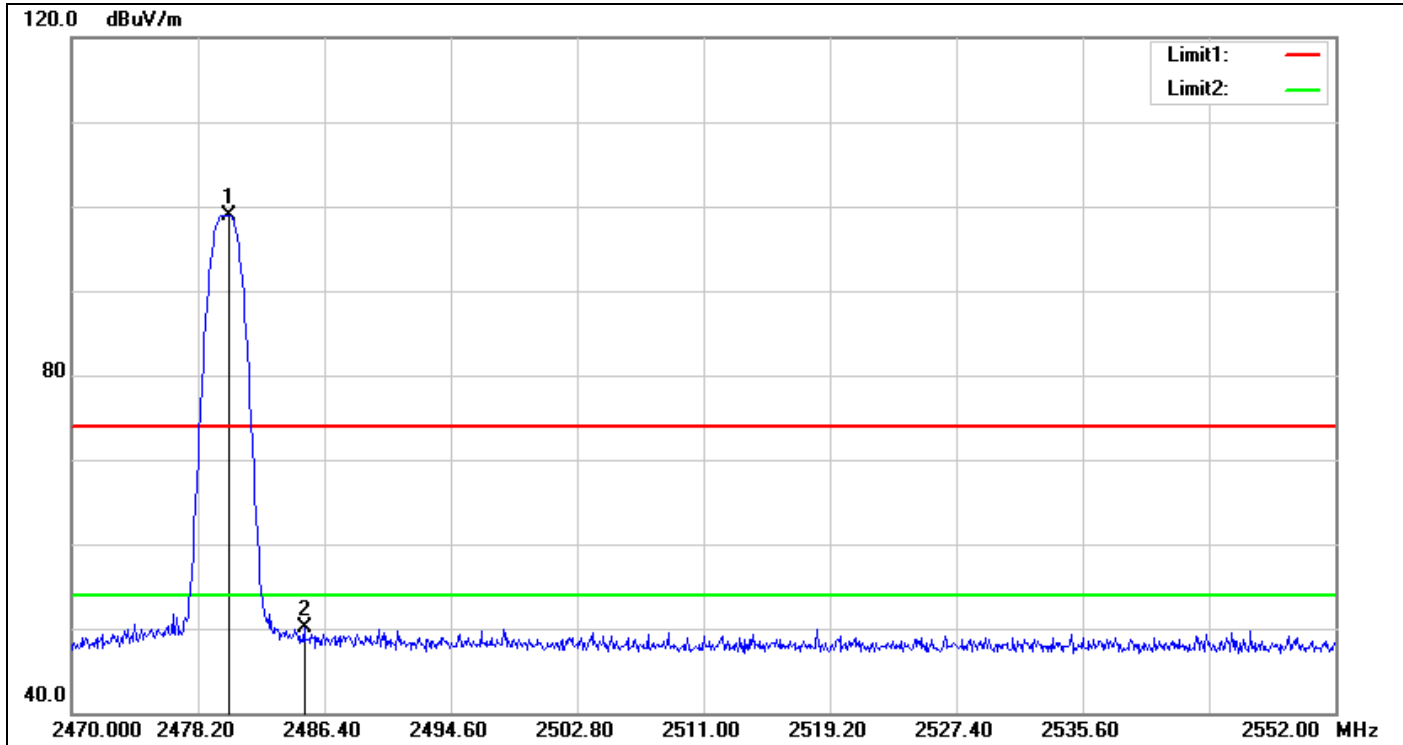

No.	Frequency (MHz)	Reading (dBuV)	Correct Factor(dB/m)	Result (dBuV/m)	Limit (dBuV/m)	Margin (dB)	Remark
1	2480.168	100.96	-2.03	98.93	-	-	peak
2	2485.088	52.07	-1.98	50.09	74.00	-23.91	peak

Detector mode: Average

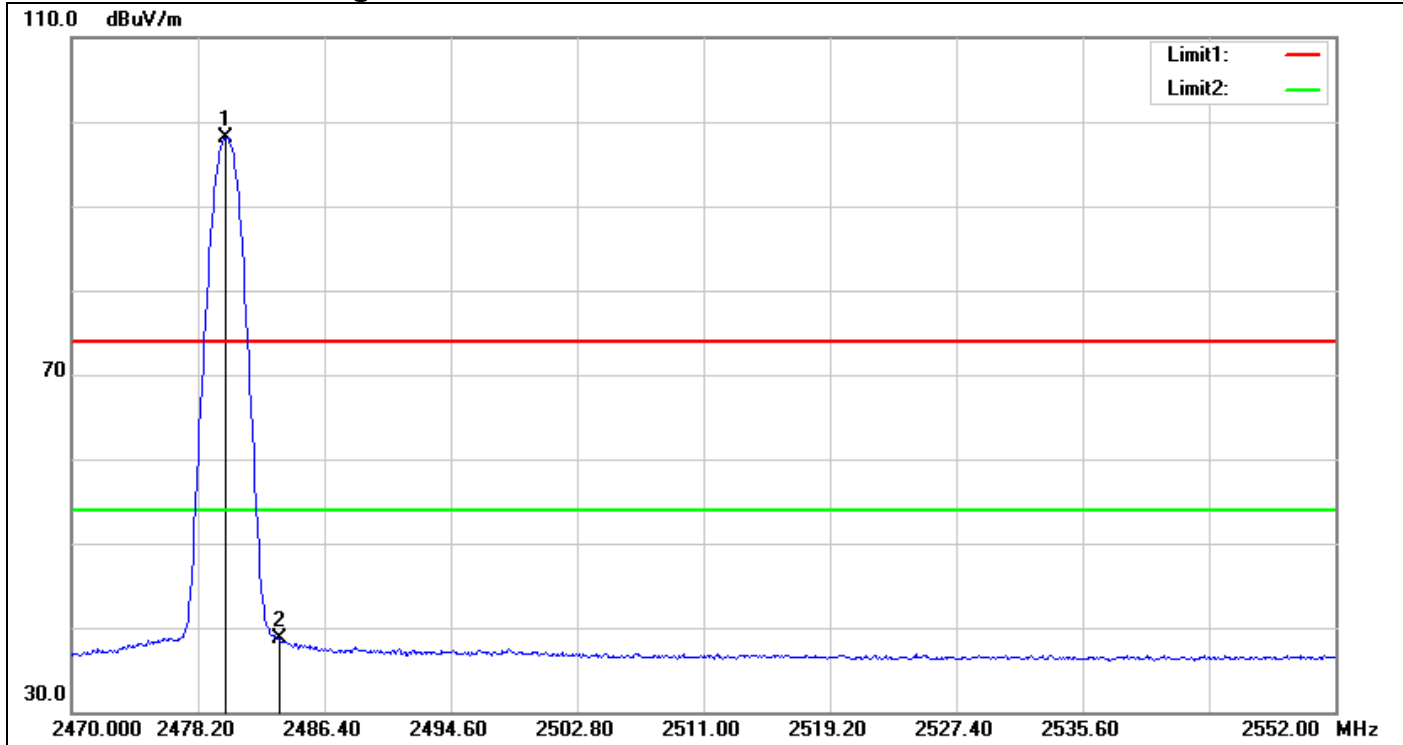

No.	Frequency (MHz)	Reading (dBuV)	Correct Factor(dB/m)	Result (dBuV/m)	Limit (dBuV/m)	Margin (dB)	Remark
1	2480.004	100.22	-2.03	98.19	-	-	AVG
2	2483.530	40.61	-1.99	38.62	54.00	-15.38	AVG

For PCB Antenna

Band Edges (CH Low)

Detector mode: Peak

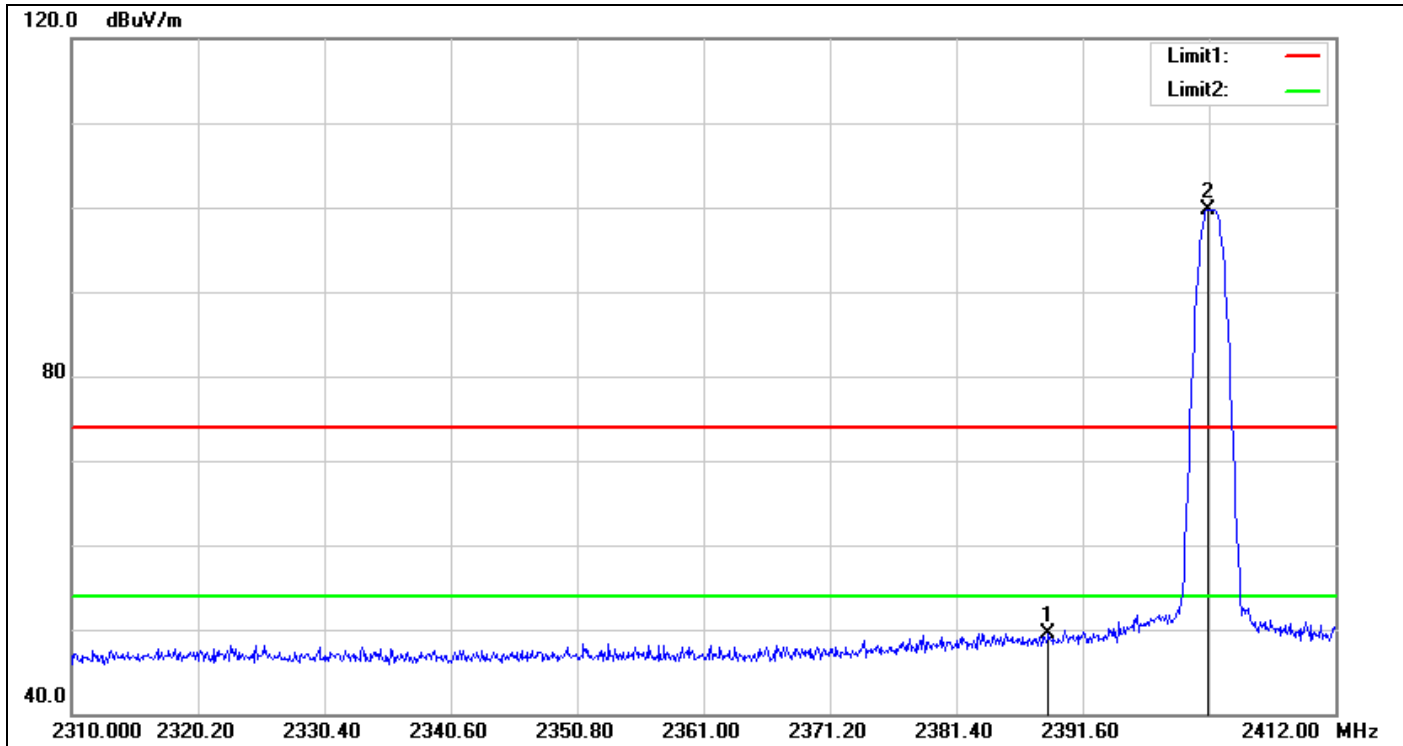

No.	Frequency (MHz)	Reading (dBuV)	Correct Factor(dB/m)	Result (dBuV/m)	Limit (dBuV/m)	Margin (dB)	Remark
1	2388.846	52.81	-3.29	49.52	74.00	-24.48	peak
2	2401.698	103.01	-3.25	99.76	-	-	peak

Detector mode: Average

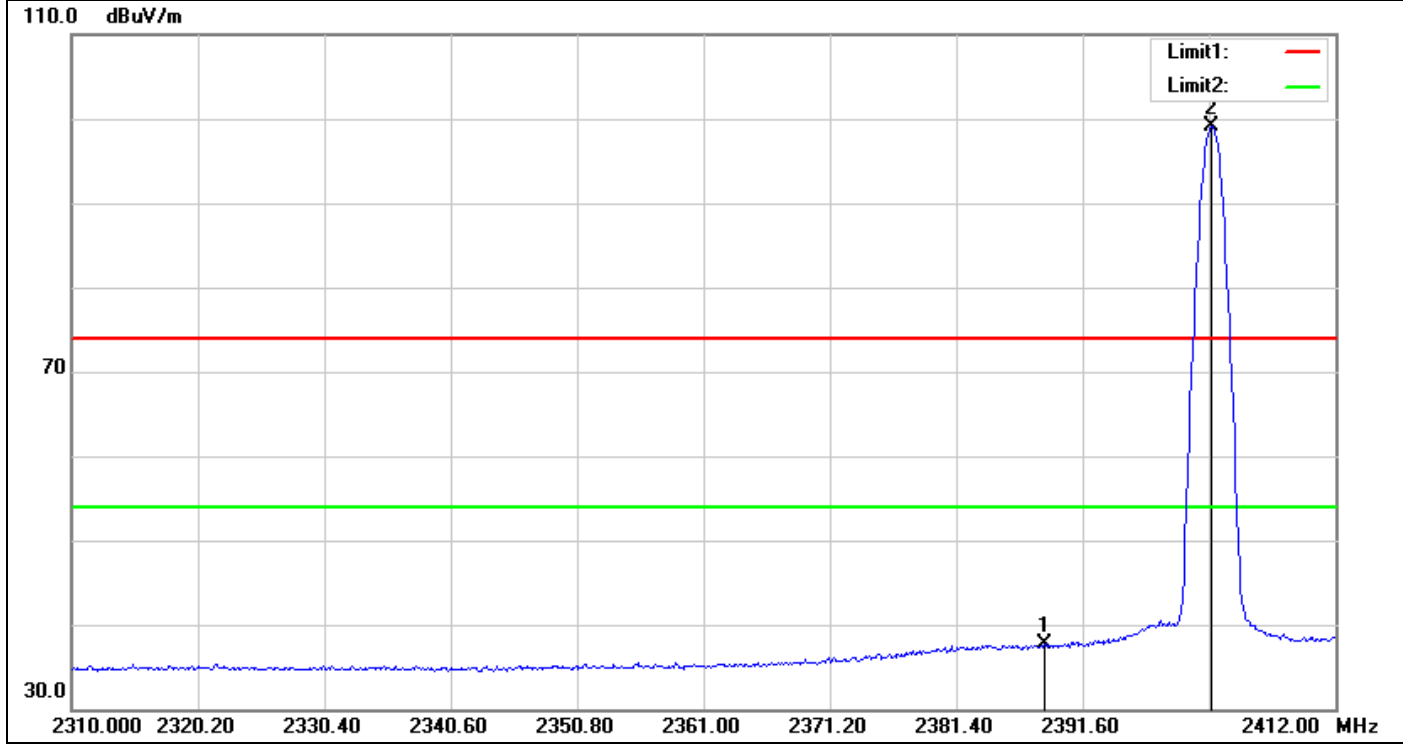

No.	Frequency (MHz)	Reading (dBuV)	Correct Factor(dB/m)	Result (dBuV/m)	Limit (dBuV/m)	Margin (dB)	Remark
1	2388.540	41.04	-3.29	37.75	54.00	-16.25	AVG
2	2402.004	102.27	-3.25	99.02	-	-	AVG

Band Edges (CH High)

Detector mode: Peak

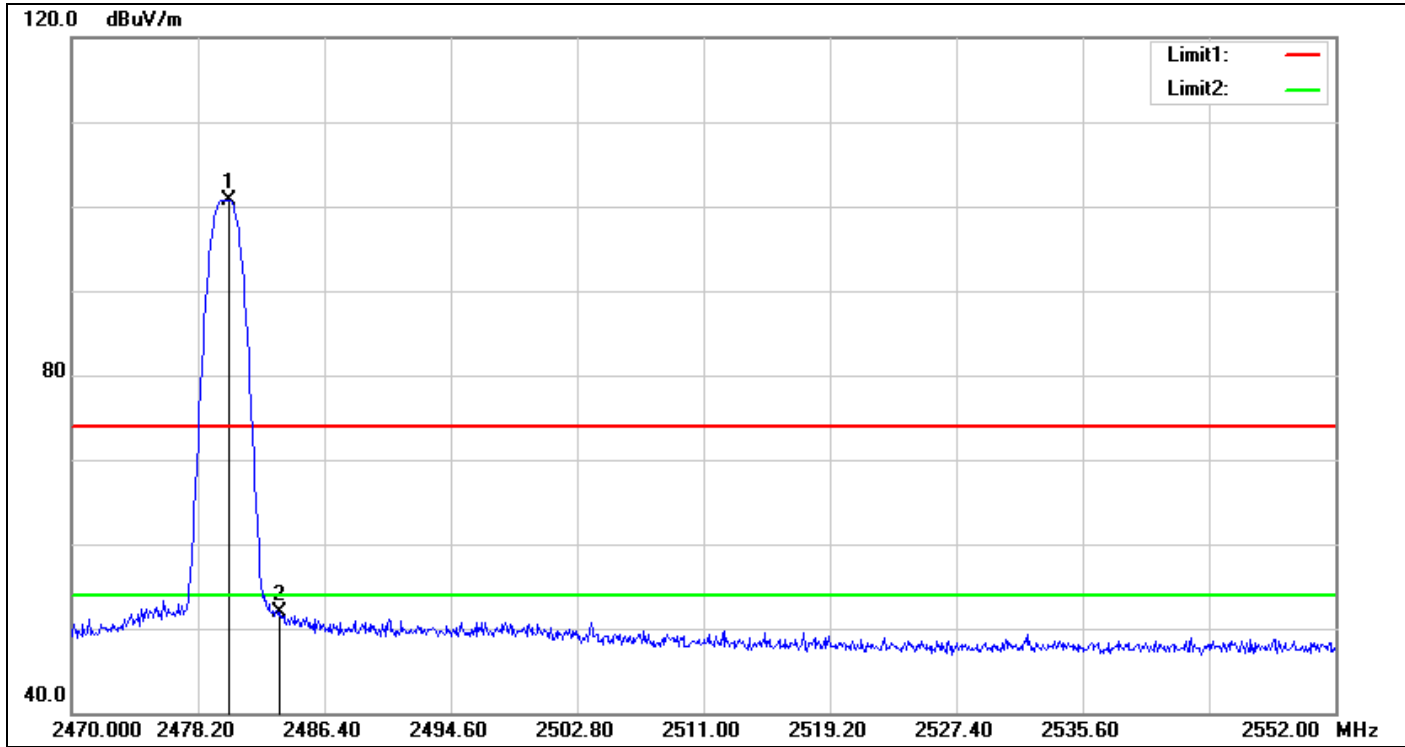

No.	Frequency (MHz)	Reading (dBuV)	Correct Factor(dB/m)	Result (dBuV/m)	Limit (dBuV/m)	Margin (dB)	Remark
1	2480.250	103.78	-3.03	100.75	-	-	peak
2	2483.500	54.93	-3.02	51.91	74.00	-22.09	peak

Detector mode: Average

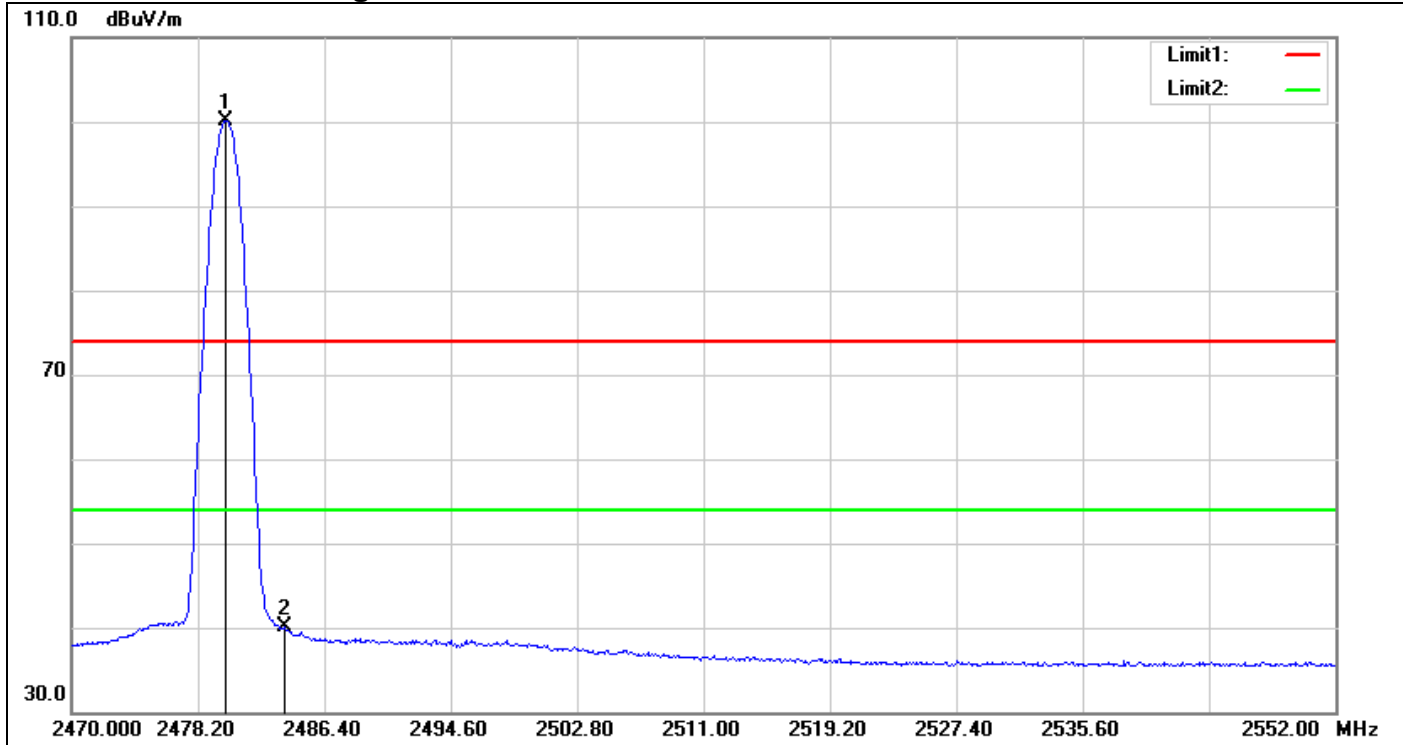

No.	Frequency (MHz)	Reading (dBuV)	Correct Factor(dB/m)	Result (dBuV/m)	Limit (dBuV/m)	Margin (dB)	Remark
1	2480.004	103.16	-3.03	100.13	-	-	AVG
2	2483.776	43.09	-3.01	40.08	54.00	-13.92	AVG

7.5 CONDUCTED BAND EDGE AND CONDUCTED SPURIOUS EMISSION

In any 100 kHz bandwidth outside the authorized frequency band,

Non-restricted bands shall be attenuated at least 20 dB/30 dB relative to the maximum PSD level in 100 kHz by RF conducted or a radiated measurement which fall in the restricted bands, as defined in §15.205(a), must also comply with the radiated emission limits specified in §15.209(a)

TEST PROCEDURE

According to KDB 558074 D01 v03r04, and 15.247(d)

1. EUT RF output port connected to the SA by RF cable, and the path loss was compensated to result.
2. SA setting, RBW=100kHz, VBW=300kHz, Detector=Peak, Trace mode = max hold, SWT = Auto.
3. In any 100 kHz bandwidth outside the authorized frequency band, shall be attenuated at least 20 dB relative to the maximum in-band peak PSD level in 100 kHz when conducted power procedure is used. If the transmitter complies with the conducted power limits based on the use of RMS averaging over a time interval, the attenuation required under this paragraph shall be 30 dB instead of 20 dB.

TEST CONFIGURATION

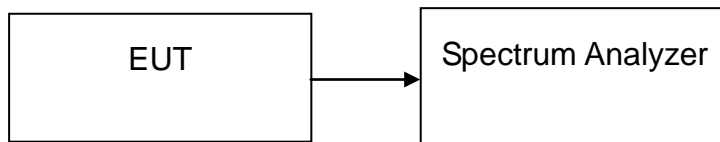

TEST RESULTS

Refer to attach spectrum analyzer data chart.

Test Data

Mode: BLE

Low CH_100kHz PSD Reference Level

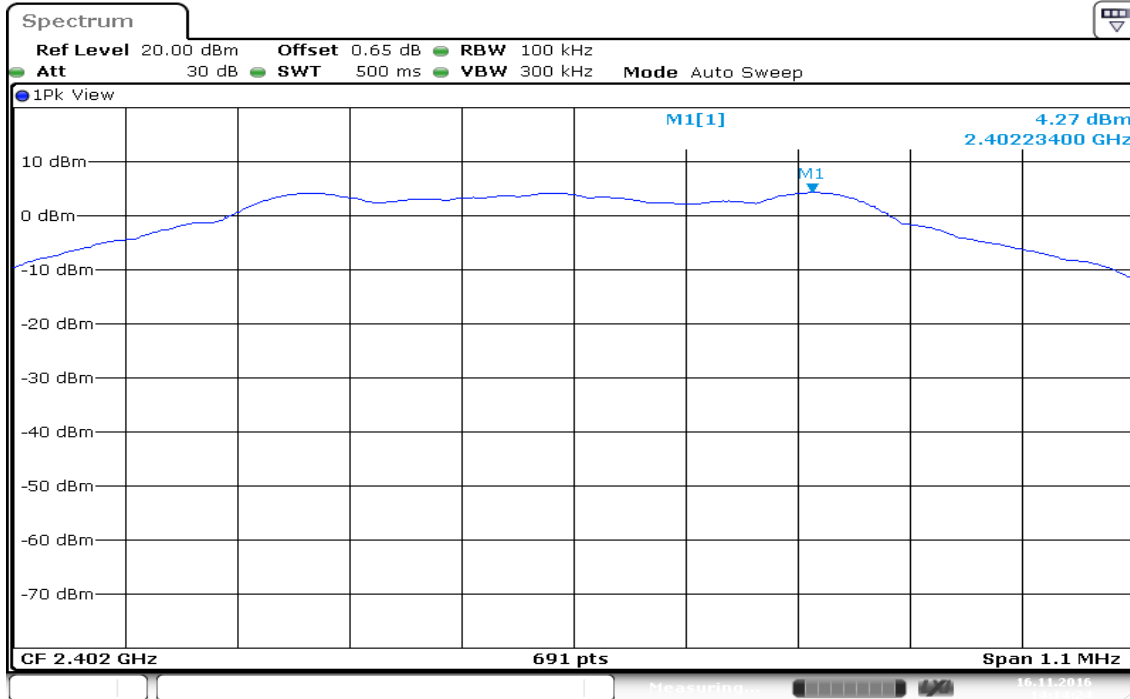

Date: 16 NOV 2016 14:14:24

Low CH_Conducted Band Edge

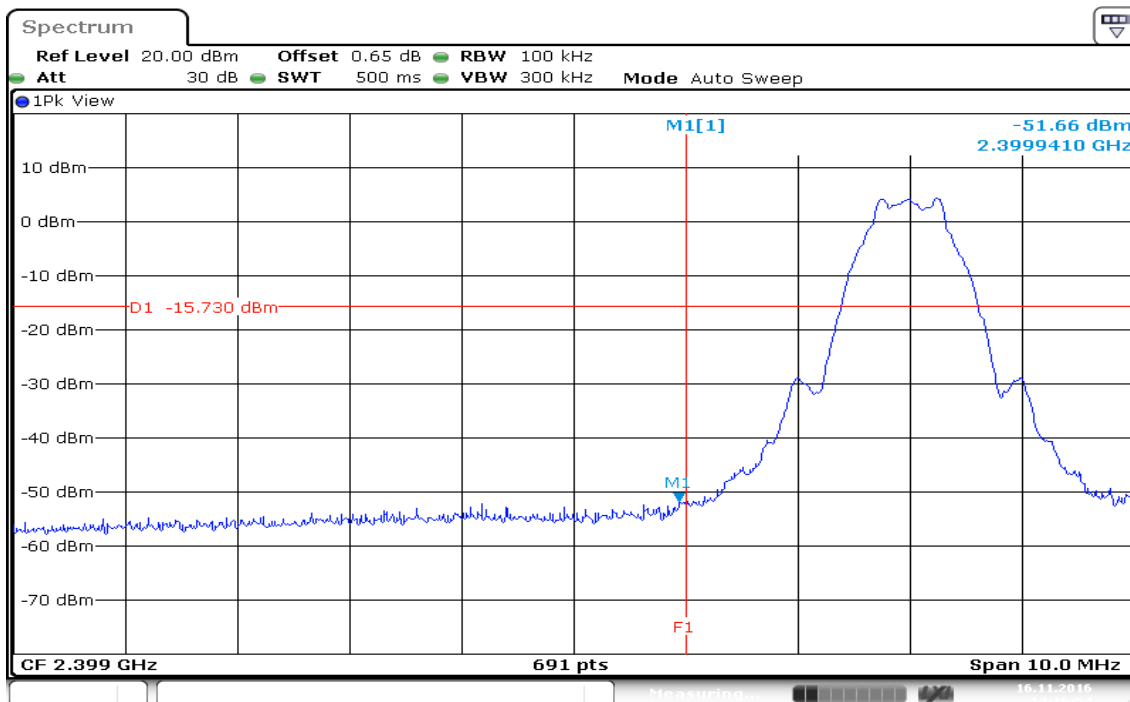

Date: 16 NOV 2016 14:16:54

Low CH_Conducted Spurious Emission

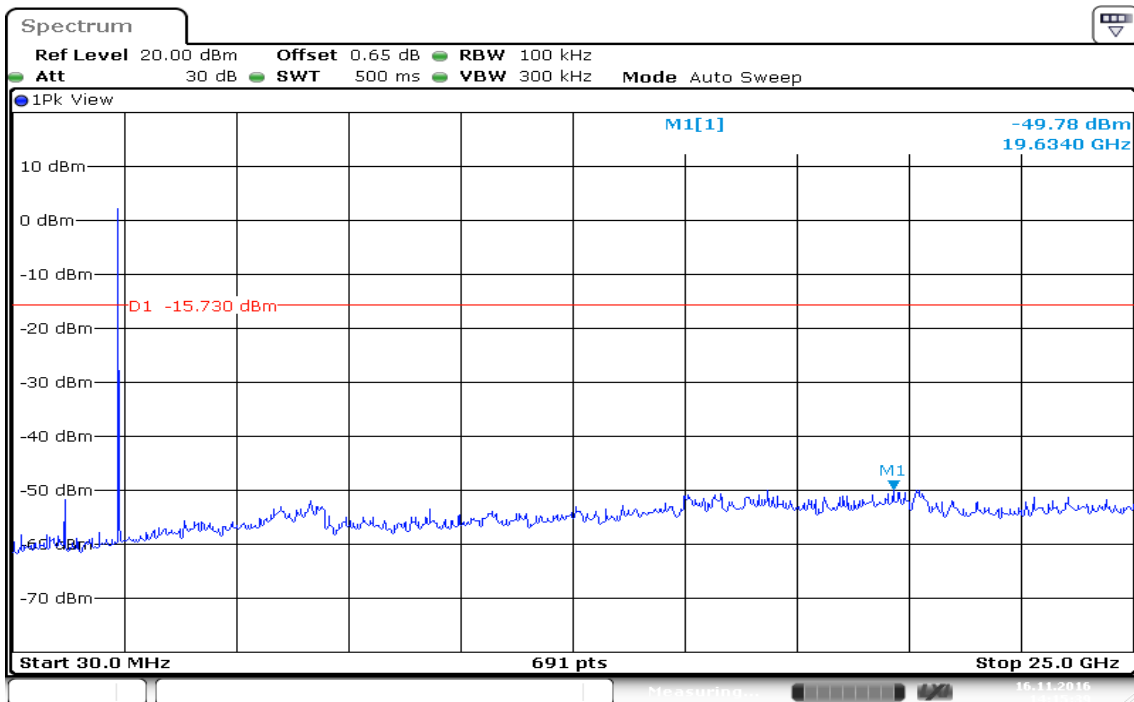

Date: 16 NOV 2016 14:15:39

Mid CH_100kHz PSD Reference Level

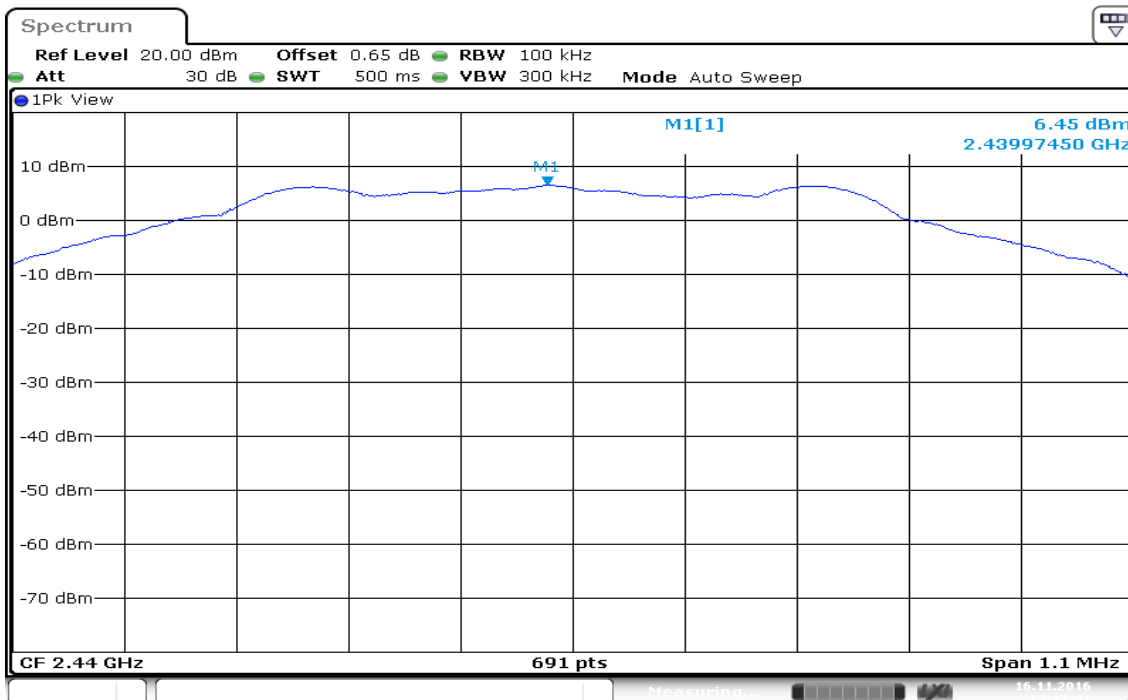

Mid CH_ Conducted Spurious Emission

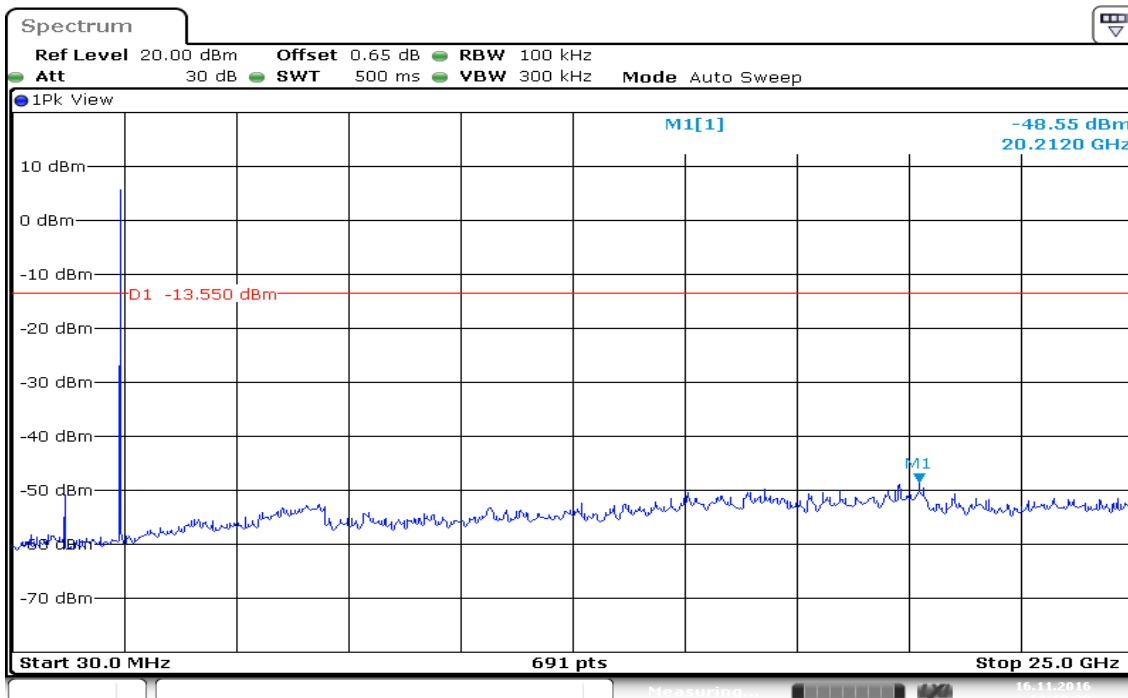

High CH_100kHz PSD Reference Level

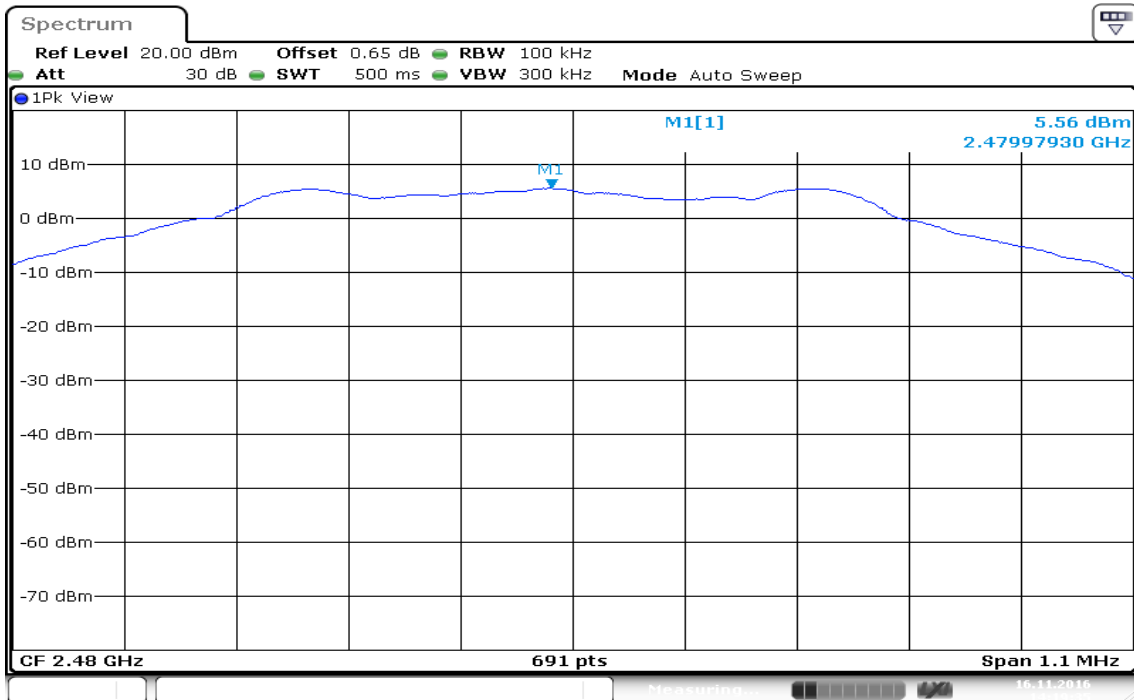

Date: 16 NOV 2016 14:19:35

High CH_Conducted Band Edge

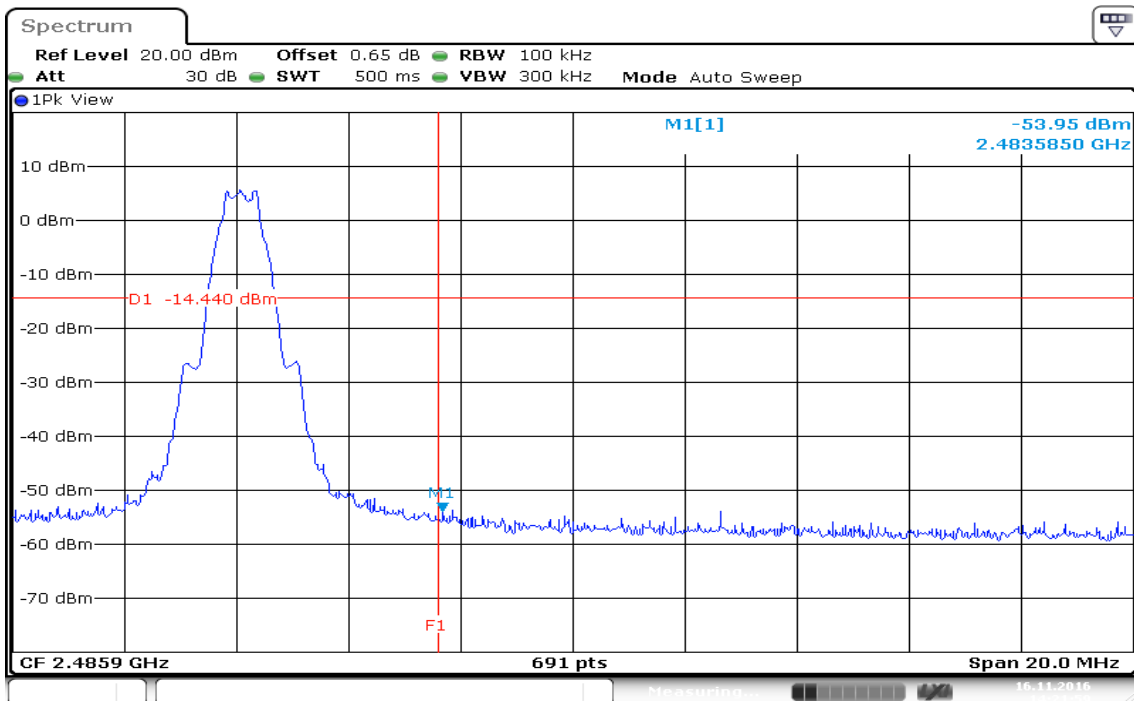

Date: 16 NOV 2016 14:22:00

High CH_Conducted Spurious Emission

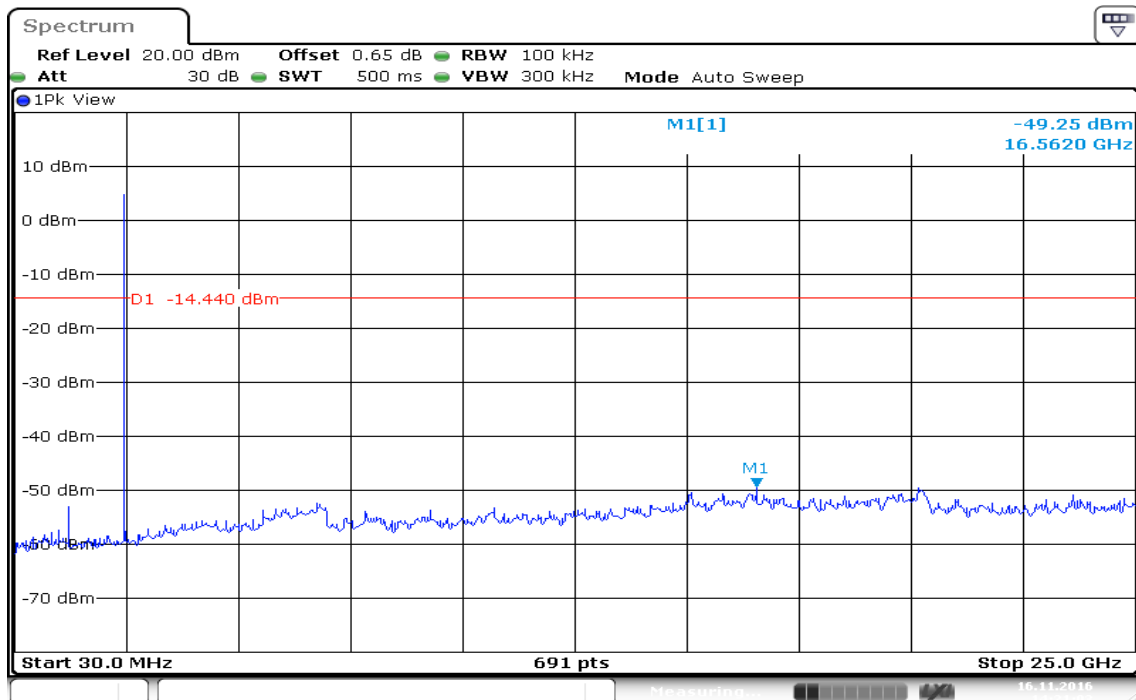

Date: 16 NOV 2016 14:21:04

7.6 PEAK POWER SPECTRAL DENSITY

LIMIT

1. According to §15.247(e) & RSS-247, for digitally modulated systems, the power spectral density conducted from the intentional radiator to the antenna shall not be greater than 8 dBm in any 3 kHz band during any time interval of continuous transmission.
2. According to §15.247(f) & RSS-247, the digital modulation operation of the hybrid system, with the frequency hopping turned off, shall comply with the power density requirements of paragraph (d) of this section.

Test Configuration

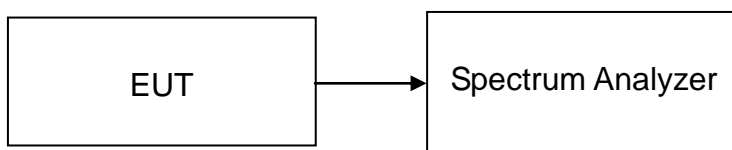

TEST PROCEDURE

1. Place the EUT on the table and set it in transmitting mode.
Remove the antenna from the EUT and then connect a low loss RF cable from the antenna port to the spectrum analyzer.
2. Set the spectrum analyzer as RBW = 3kHz, VBW = 30 kHz, Sweep time = auto couple.
3. Trace mode = max hold
4. Repeat the above procedure until the measurements for all frequencies are completed.

TEST RESULTS

No non-compliance noted

Test Data

Channel	Frequency (MHz)	PPSD (dBm)	Limit (dBm)	Result
Low	2402	-9.53	8.00	PASS
Mid	2440	-8.08		PASS
High	2480	-9.80		PASS

Test Plot

PPSD (CH Low)

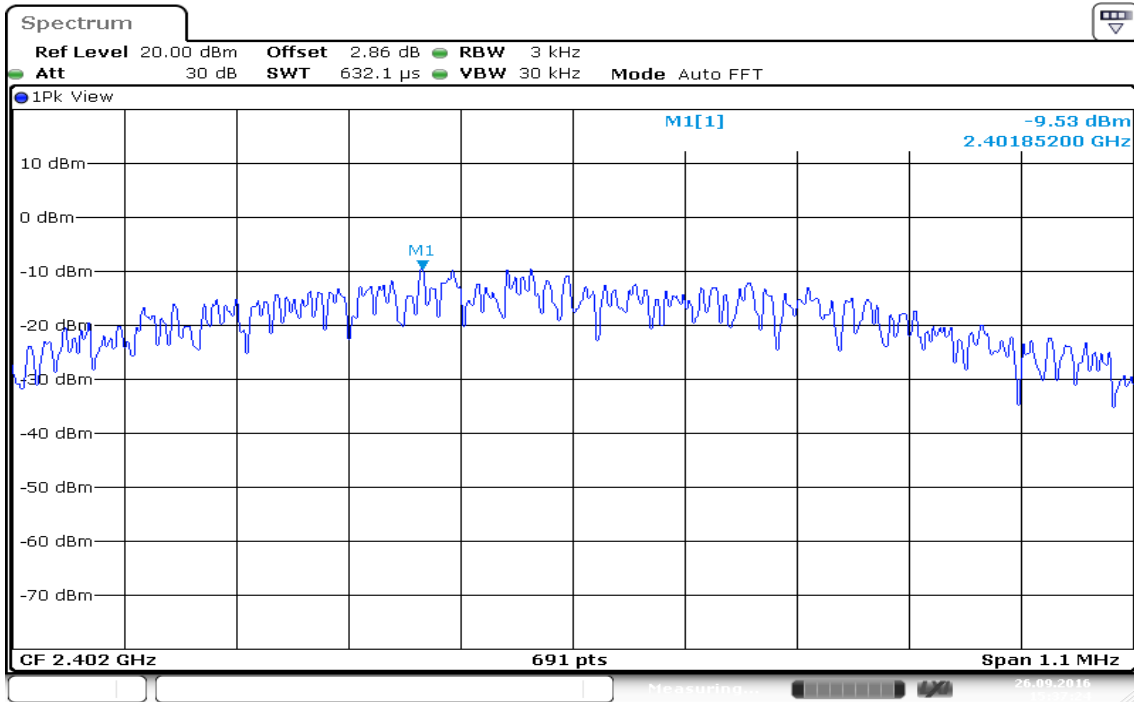

Date: 26.SEP.2016 15:37:24

PPSD (CH Mid)

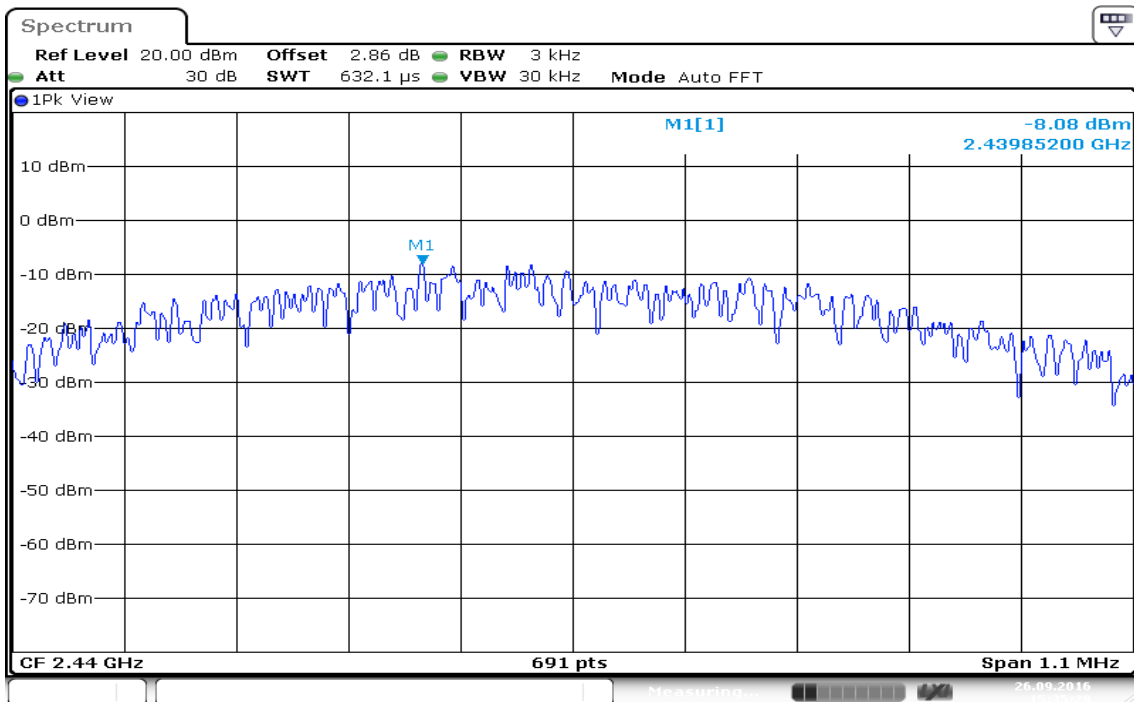

Date: 26.SEP.2016 15:35:29

PPSD (CH High)

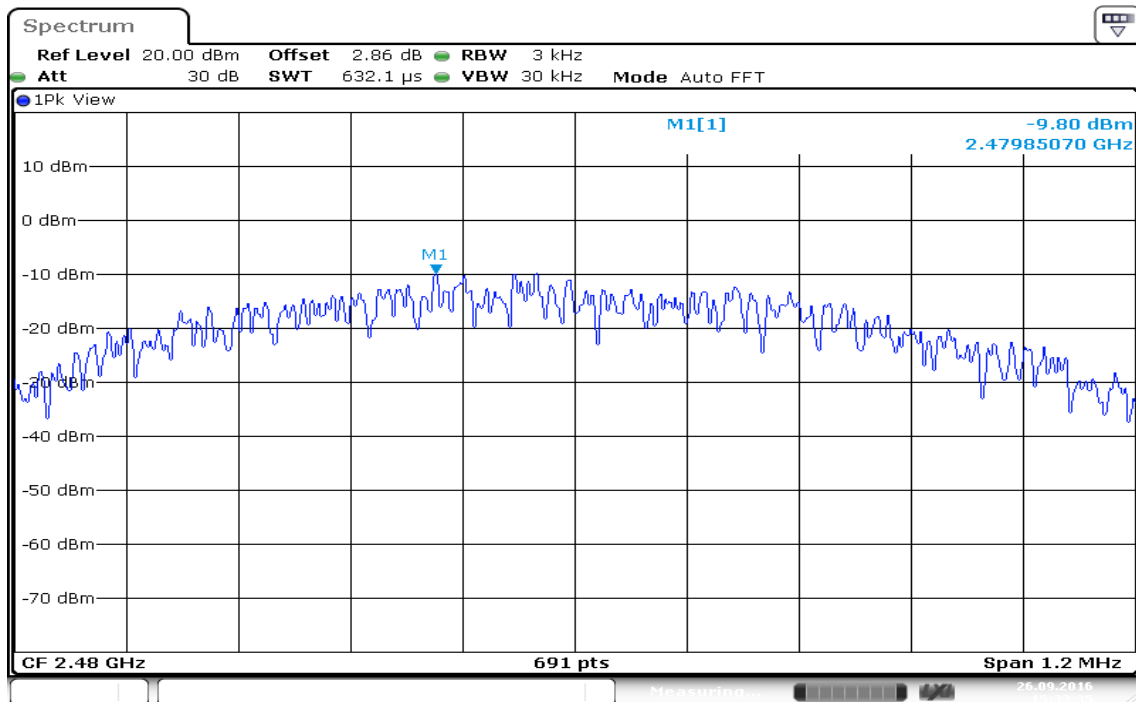

Date: 26.SEP.2016 15:33:35

7.7 RADIATED EMISSIONS

LIMIT

All spurious emissions shall comply with the limits of §15.209(a) and RSS-Gen Table 2 & Table 4.

RSS-Gen Table 2 & Table 4: General Field Strength Limits for Transmitters and Receivers at Frequencies Above 30 MHz ^(Note)

Frequency (MHz)	Field Strength microvolts/m at 3 metres (watts, e.i.r.p.)	
	Transmitters	Receivers
30-88	100 (3 nW)	100 (3 nW)
88-216	150 (6.8 nW)	150 (6.8 nW)
216-960	200 (12 nW)	200 (12 nW)
Above 960	500 (75 nW)	500 (75 nW)

Note: *Measurements for compliance with limits in the above table may be performed at distances other than 3 metres, in accordance with Section 6.5.

Transmitting devices are not permitted in Table 1 bands or, unless stated otherwise, in TV bands (54-72 MHz, 76-88 MHz, 174-216 MHz, 470-608 MHz and 614-806 MHz).

RSS-Gen Table 5: General Field Strength Limits for Transmitters at Frequencies Below 30 MHz (Transmit)

Frequency	Field Strength (microvolts/m)	Magnetic H-Field (microamperes/m)	Measurement Distance (metres)
9-490 kHz	2,400/F (F in kHz)	2,400/377F (F in kHz)	3000
490-1,705 kHz	24,000/F (F in kHz)	24,000/377F (F in kHz)	30
1.705-30 MHz	30	N/A	30

Note: The emission limits for the bands 9-90 kHz and 110-490 kHz are based on measurements employing an average detector.

Test Configuration

9kHz ~ 30MHz

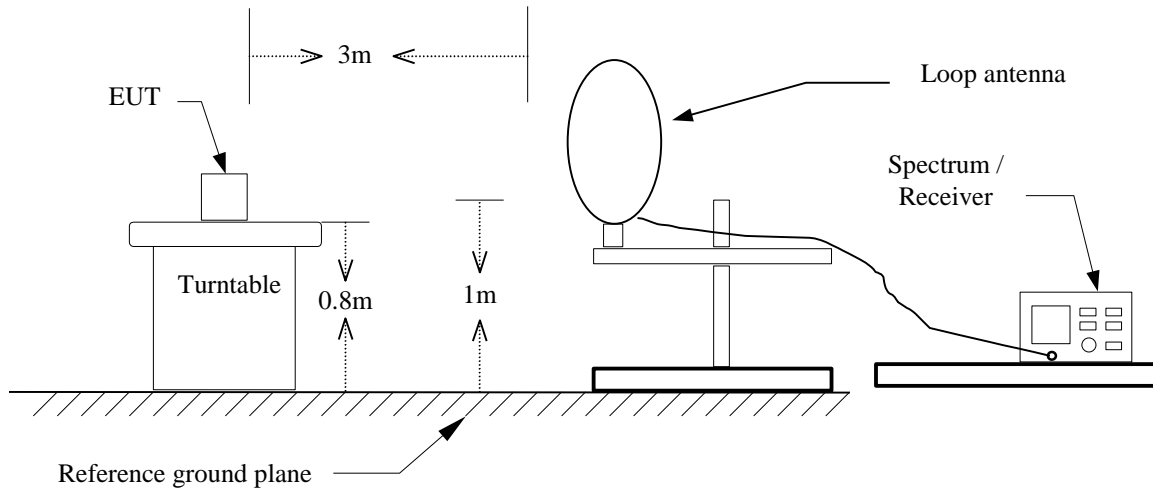

30MHz ~ 1GHz

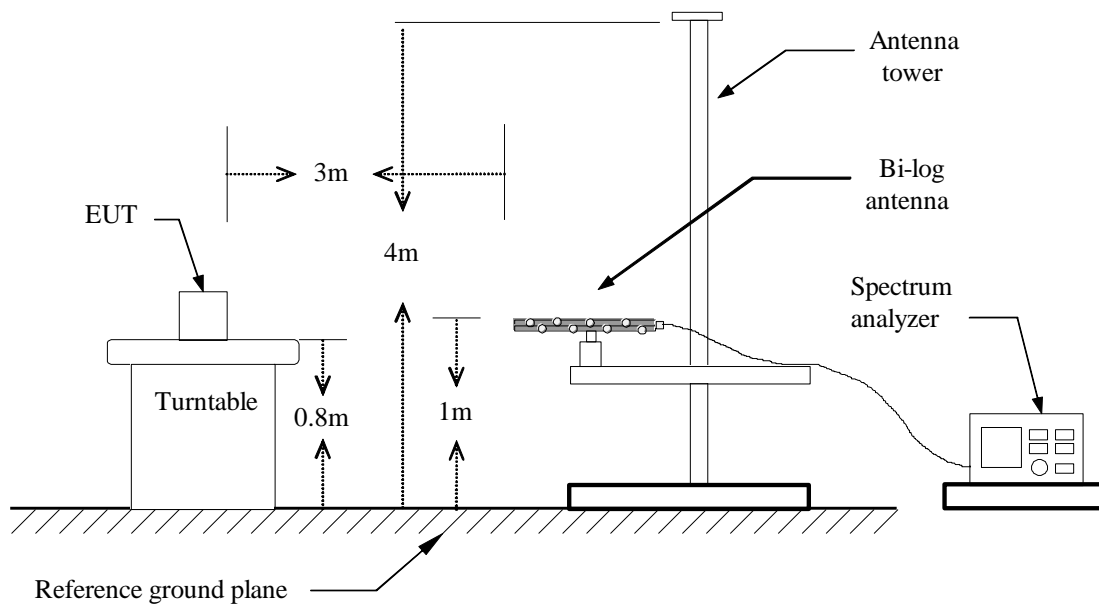

Above 1 GHz

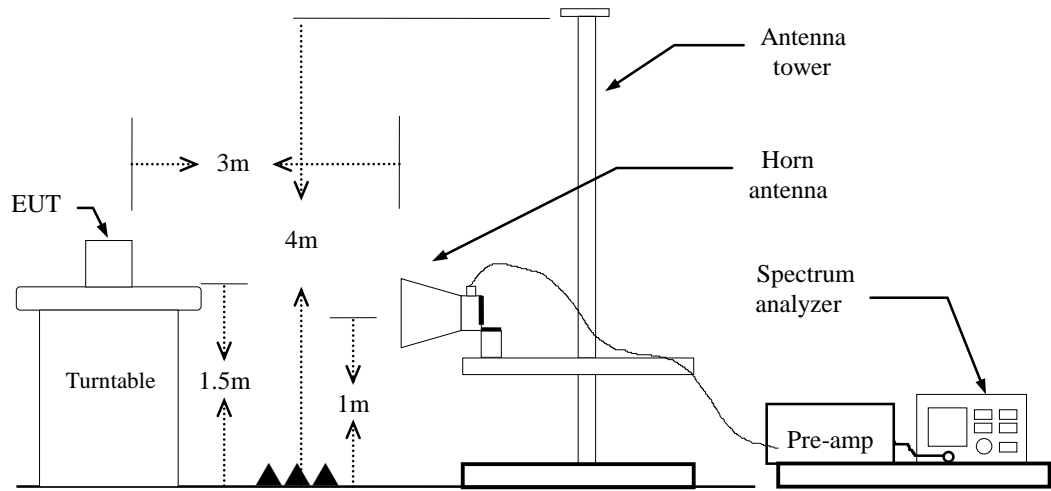

TEST PROCEDURE

1. The EUT is placed on a turntable, Above 1 GHz is 1.5m high and below 1 GHz is 0.8m high above ground plane.
2. The turntable shall be rotated for 360 degrees to determine the position of maximum emission level.
3. EUT is set 3m away from the receiving antenna, which is varied from 1m to 4m to find out the highest emissions.
4. Maximum procedure was performed on the six highest emissions to ensure EUT compliance.
5. And also, each emission was to be maximized by changing the polarization of receiving antenna both horizontal and vertical.
6. Set the spectrum analyzer in the following setting as:

Below 1GHz:

RBW=100kHz / VBW=300kHz / Sweep=AUTO

Above 1GHz:

(a) PEAK: RBW=1MHz / VBW=3MHz / Sweep=AUTO

(b) AVERAGE: RBW=1MHz,
if duty cycle \geq 98%, VBW=10Hz.
if duty cycle < 98% VBW=1/T.

For PIFA Antenna

BT4.1: = 65%, VBW= 2.7kHz

For PCB Antenna

BT4.1: = 65%, VBW= 2.7kHz

7. Repeat above procedures until the measurements for all frequencies are complete.
8. Result = Spectrum Reading + cable loss(spectrum to Amp) - Amp Gain + Cable loss(Amp to receive Ant)+ Receive Ant

Note: We checked every harmonics frequencies from Fundamental frequencies with reduced VBW, and we mark a point to prove pass or not if we find any emission. For this case, there are no emissions hidden in the noise floor.

For PIFA Antenna

Below 1 GHz

Operation Mode: Normal Link

Test Date: October 13, 2016

Temperature: 27°C

Tested by: Dennis Li

Humidity: 53% RH

Polarity: Ver.

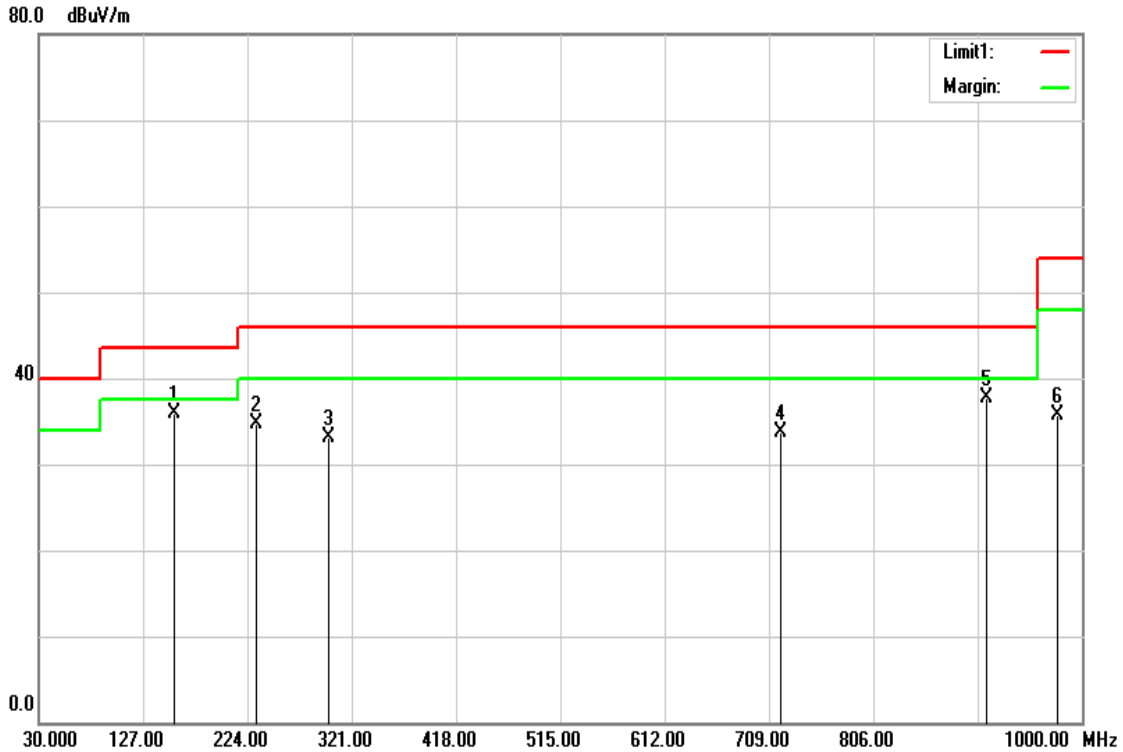

Frequency (MHz)	Reading (dBuV)	Correction Factor (dB/m)	Result (dBuV/m)	Limit (dBuV/m)	Margin (dB)	Remark	Ant. Pol. (H/V)
156.1000	52.20	-16.25	35.95	43.50	-7.55	peak	V
232.7300	51.43	-16.67	34.76	46.00	-11.24	peak	V
299.6600	47.27	-14.25	33.02	46.00	-12.98	peak	V
719.6700	39.32	-5.62	33.70	46.00	-12.30	peak	V
911.7300	40.72	-3.00	37.72	46.00	-8.28	peak	V
977.6900	37.74	-1.95	35.79	54.00	-18.21	peak	V

Remark:

1. No emission found between lowest internal used/generated frequency to 30MHz (9kHz~30MHz)
2. Radiated emissions measured in frequency range from 30 MHz to 1000MHz were made with an instrument using peak/quasi-peak detector mode.
3. Quasi-peak test would be performed if the peak result were greater than the quasi-peak limit or as required by the applicant.
4. Measurements above show only up to 6 maximum emissions noted, or would be lesser, with " N/A " remark, if no specific emissions from the EUT are recorded (ie: margin>20dB from the applicable limit) and considered that's already beyond the background noise floor.
5. Margin (dB) = Remark result (dBuV/m) – Quasi-peak limit (dBuV/m).

Operation Mode: Normal Link

Test Date: October 13, 2016

Temperature: 27°C

Tested by: Dennis Li

Humidity: 53% RH

Polarity: Hor.

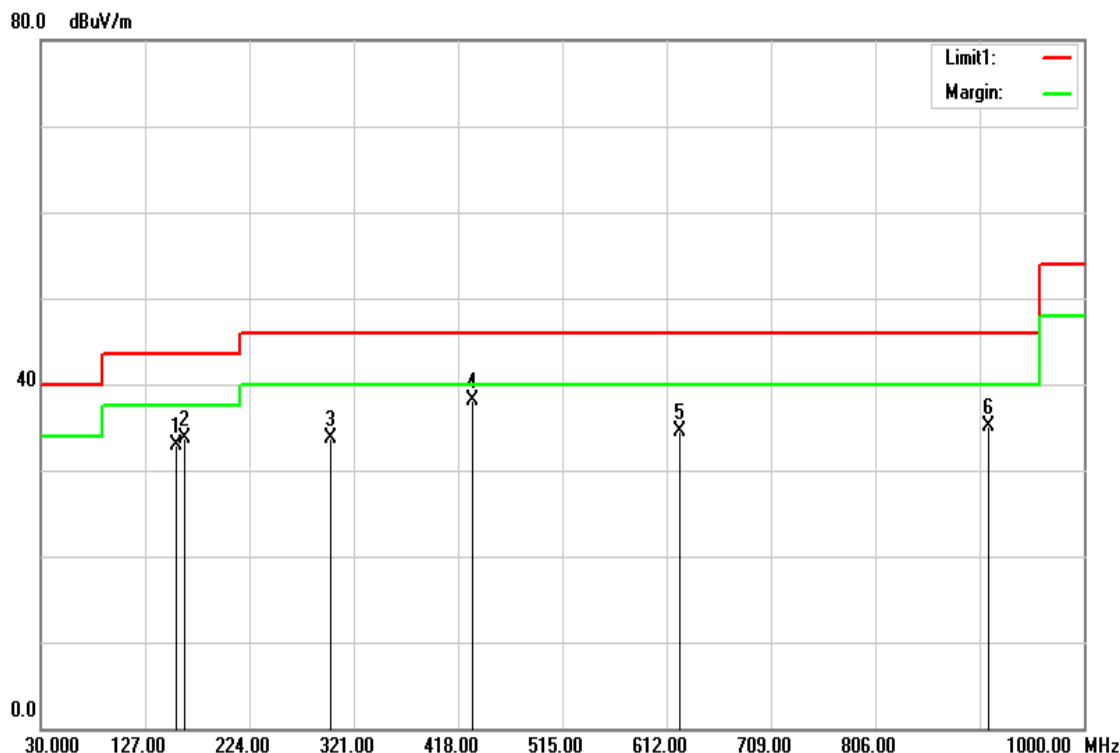

Frequency (MHz)	Reading (dBuV)	Correction Factor (dB/m)	Result (dBuV/m)	Limit (dBuV/m)	Margin (dB)	Remark	Ant. Pol. (H/V)
156.1000	49.17	-16.25	32.92	43.50	-10.58	QP	H
163.8600	50.26	-16.55	33.71	43.50	-9.79	QP	H
299.6600	47.86	-14.25	33.61	46.00	-12.39	QP	H
431.5800	48.81	-10.75	38.06	46.00	-7.94	peak	H
624.6100	41.60	-7.17	34.43	46.00	-11.57	peak	H
911.7300	38.15	-3.00	35.15	46.00	-10.85	peak	H

Remark:

1. No emission found between lowest internal used/generated frequency to 30MHz (9kHz~30MHz)
2. Radiated emissions measured in frequency range from 30 MHz to 1000MHz were made with an instrument using peak/quasi-peak detector mode.
3. Quasi-peak test would be performed if the peak result were greater than the quasi-peak limit or as required by the applicant.
4. Measurements above show only up to 6 maximum emissions noted, or would be lesser, with " N/A " remark, if no specific emissions from the EUT are recorded (ie: margin>20dB from the applicable limit) and considered that's already beyond the background noise floor.
5. Margin (dB) = Remark result (dBuV/m) – Quasi-peak limit (dBuV/m).

Above 1 GHz

GFSK / TX / CH Low

Polarity: Vertical

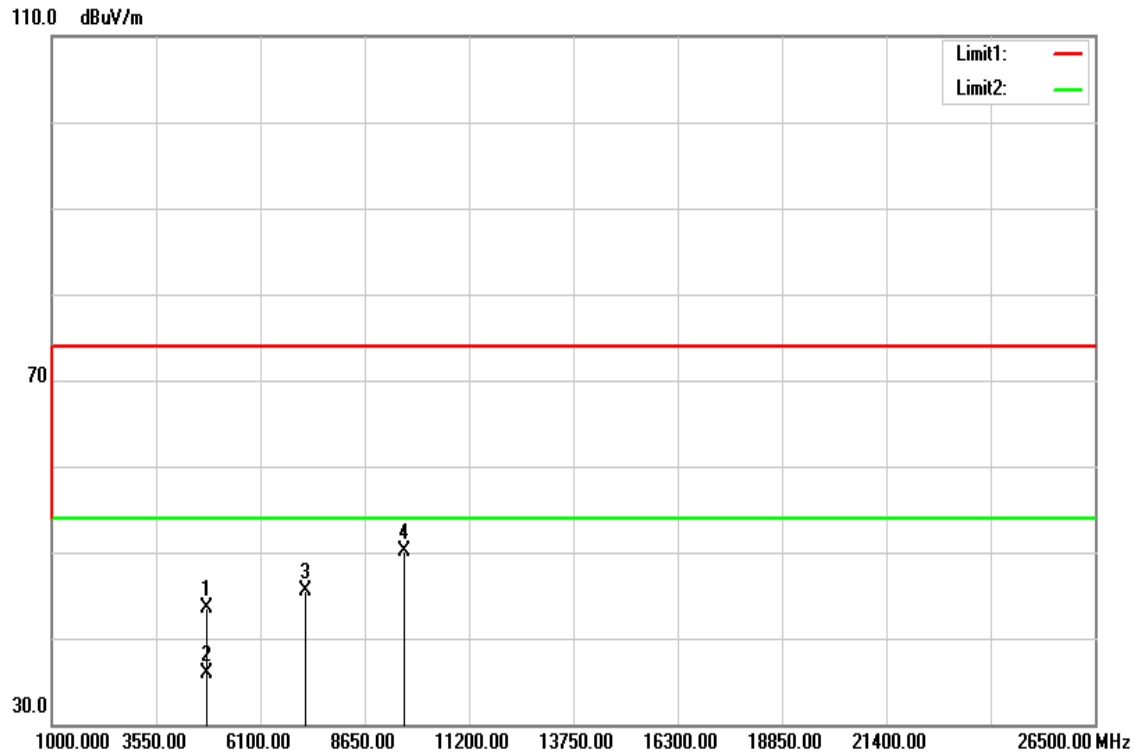

Polarity: Horizontal

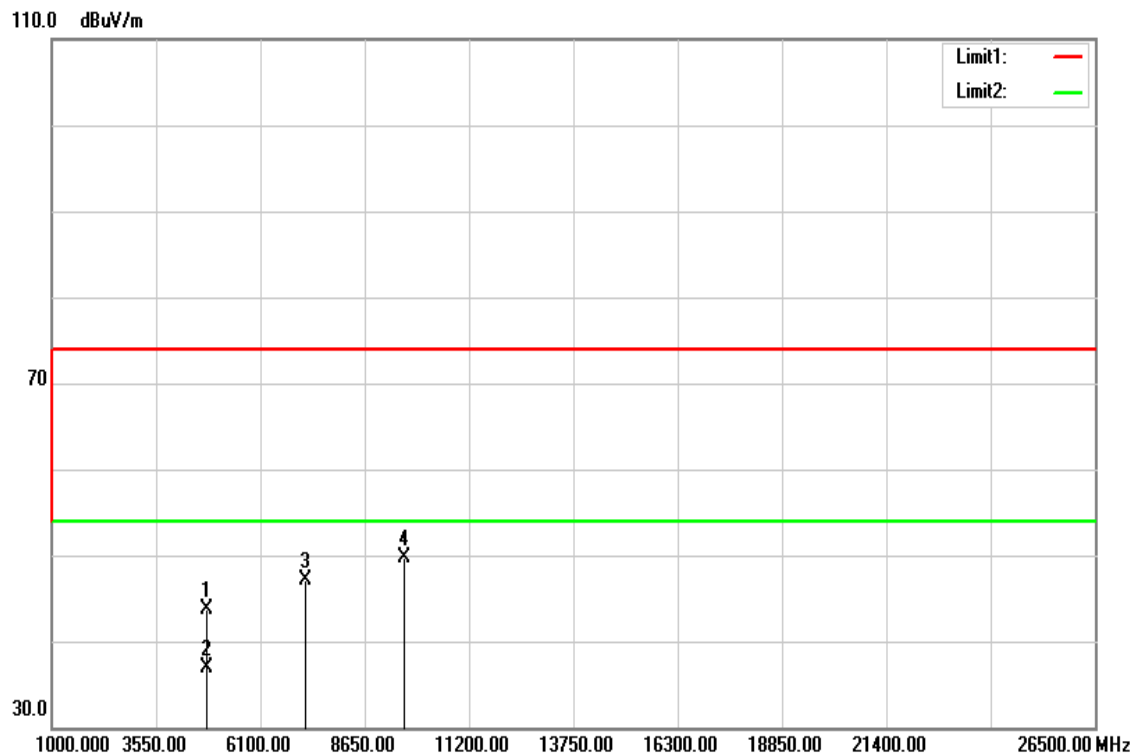

Operation Mode: GFSK / TX / CH Low

Test Date: October 13, 2016

Temperature: 27°C

Tested by: Dennis Li

Humidity: 53 % RH

Polarity: Ver. / Hor.

Frequency (MHz)	Reading (dBuV)	Correction (dB/m)	Result (dBuV/m)	Limit (dBuV/m)	Margin (dB)	Remark	Ant.Pol. (H/V)
4804.000	38.41	5.04	43.45	74.00	-30.55	peak	V
4804.000	30.86	5.04	35.90	54.00	-18.10	AVG	V
7206.000	32.98	12.62	45.60	74.00	-28.40	peak	V
9608.000	32.56	17.60	50.16	74.00	-23.84	peak	V
N/A							
4804.000	38.71	5.04	43.75	74.00	-30.25	peak	H
4804.000	31.91	5.04	36.95	54.00	-17.05	AVG	H
7206.000	34.49	12.62	47.11	74.00	-26.89	peak	H
9608.000	32.12	17.60	49.72	74.00	-24.28	peak	H
N/A							

Remark:

1. Measuring frequencies from 1 GHz to the 10th harmonic of highest fundamental frequency.
2. Radiated emissions measured in frequency above 1000MHz were made with an instrument using peak/average detector mode.
3. Average test would be performed if the peak result were greater than the average limit or as required by the applicant.
4. Data of measurement within this frequency range shown “ --- ” in the table above means the reading of emissions are attenuated more than 20dB below the permissible limits or the field strength is too small to be measured.
5. Measurements above show only up to 6 maximum emissions noted, or would be lesser, with “ N/A ” remark, if no specific emissions from the EUT are recorded (ie: margin>20dB from the applicable limit) and considered that's already beyond the background noise floor.
6. Margin (dB) = Remark result (dBuV/m) – Average limit (dBuV/m).

GFSK / TX / CH Mid

Polarity: Vertical

110.0 dBuV/m

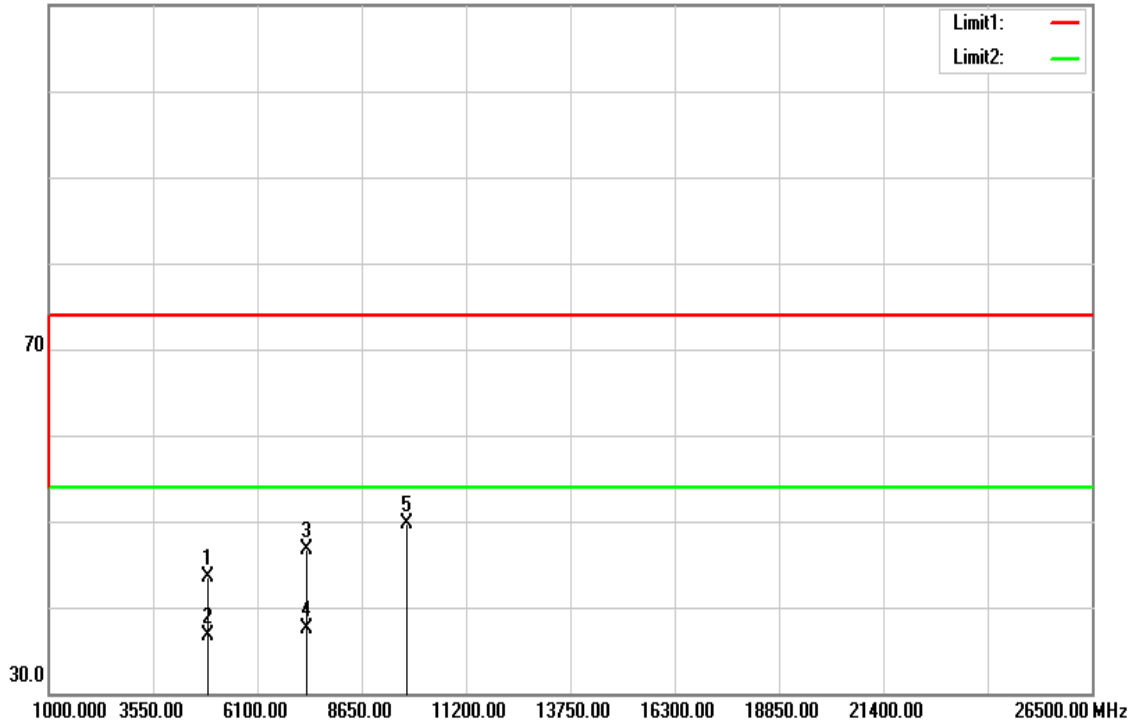

Polarity: Horizontal

110.0 dBuV/m

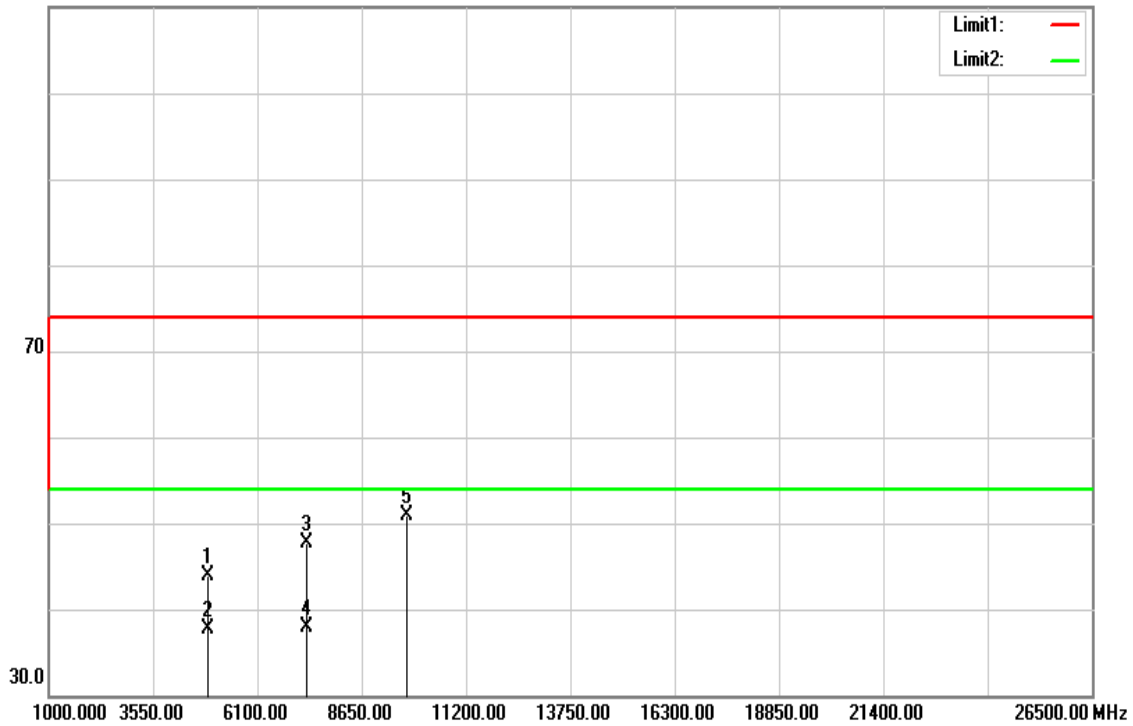

Operation Mode: GFSK / TX / CH Mid

Test Date: October 13, 2016

Temperature: 27°C

Tested by: Dennis Li

Humidity: 53 % RH

Polarity: Ver. / Hor.

Frequency (MHz)	Reading (dBuV)	Correction (dB/m)	Result (dBuV/m)	Limit (dBuV/m)	Margin (dB)	Remark	Ant.Pol. (H/V)
4880.000	38.25	5.25	43.50	74.00	-30.50	peak	V
4880.000	31.40	5.25	36.65	54.00	-17.35	AVG	V
7320.000	33.70	12.97	46.67	74.00	-27.33	peak	V
7320.000	24.48	12.97	37.45	54.00	-16.55	AVG	V
9760.000	32.03	17.60	49.63	74.00	-24.37	peak	V
N/A							
4880.000	38.63	5.25	43.88	74.00	-30.12	peak	H
4880.000	32.45	5.25	37.70	54.00	-16.30	AVG	H
7320.000	34.66	12.97	47.63	74.00	-26.37	peak	H
7320.000	24.89	12.97	37.86	54.00	-16.14	AVG	H
9760.000	33.27	17.60	50.87	74.00	-23.13	peak	H
N/A							

Remark:

1. Measuring frequencies from 1 GHz to the 10th harmonic of highest fundamental frequency.
2. Radiated emissions measured in frequency above 1000MHz were made with an instrument using peak/average detector mode.
3. Average test would be performed if the peak result were greater than the average limit or as required by the applicant.
4. Data of measurement within this frequency range shown " --- " in the table above means the reading of emissions are attenuated more than 20dB below the permissible limits or the field strength is too small to be measured.
5. Measurements above show only up to 6 maximum emissions noted, or would be lesser, with " N/A " remark, if no specific emissions from the EUT are recorded (ie: margin>20dB from the applicable limit) and considered that's already beyond the background noise floor.
6. Margin (dB) = Remark result (dBuV/m) – Average limit (dBuV/m).

GFSK / TX / CH High

Polarity: Vertical

110.0 dBuV/m

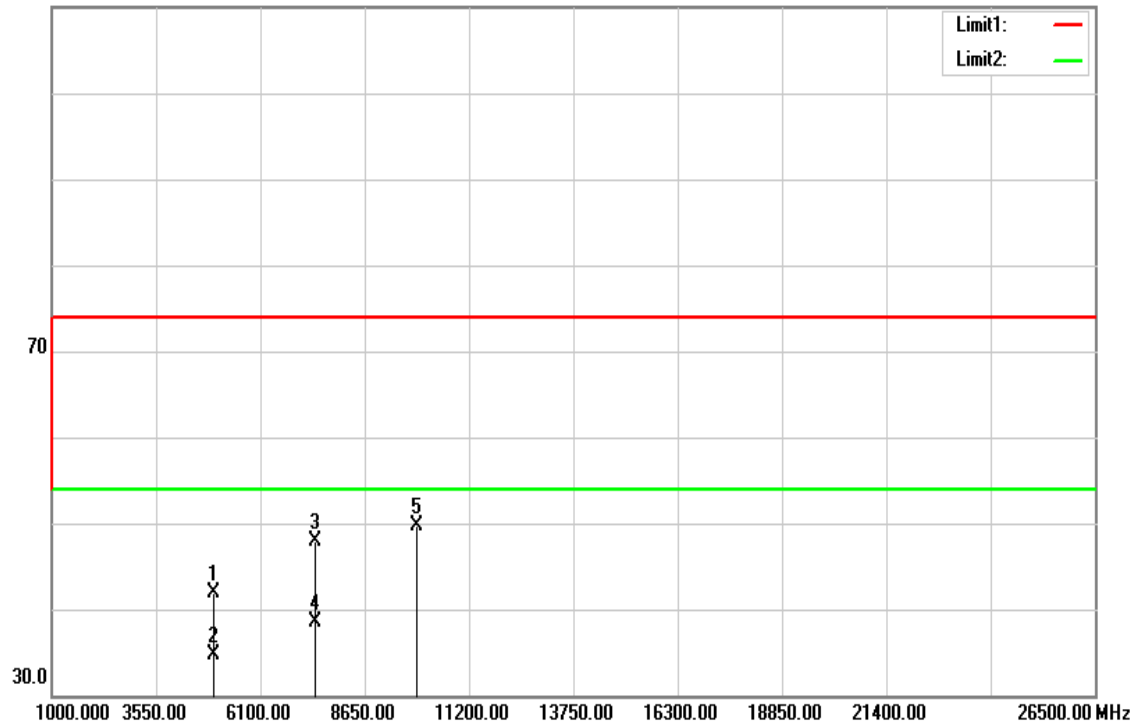

Polarity: Horizontal

110.0 dBuV/m

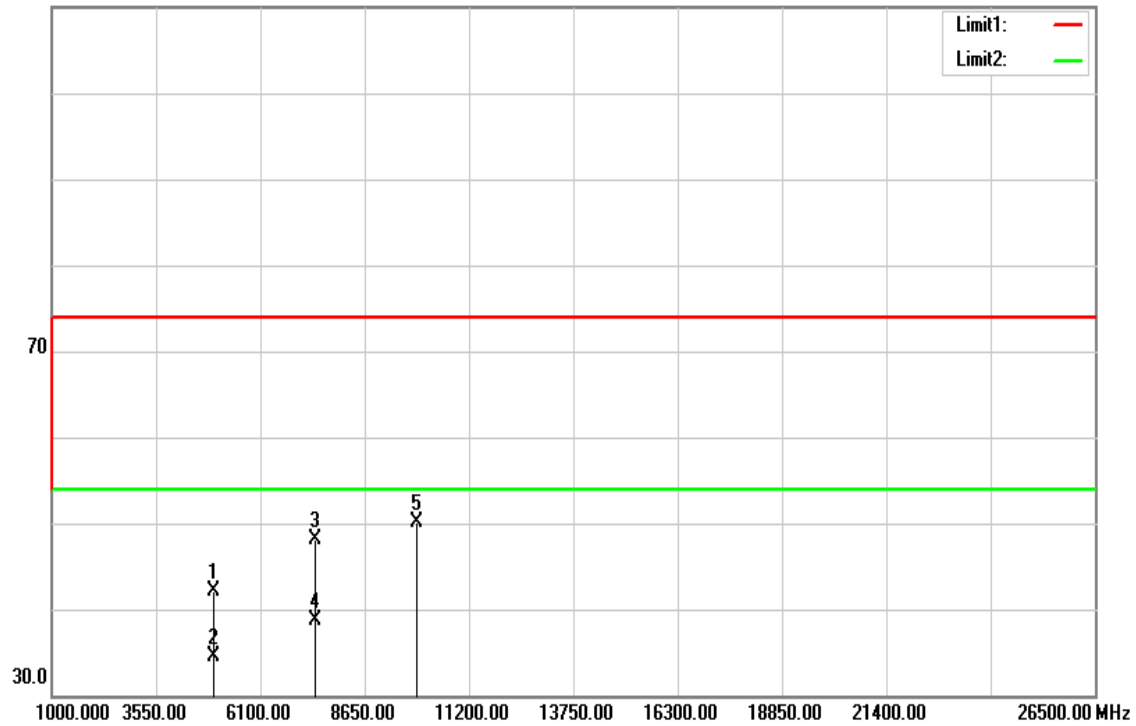

Operation Mode: GFSK / TX / CH High

Test Date: October 13, 2016

Temperature: 27°C

Tested by: Dennis Li

Humidity: 53 % RH

Polarity: Ver. / Hor.

Frequency (MHz)	Reading (dBuV)	Correction (dB/m)	Result (dBuV/m)	Limit (dBuV/m)	Margin (dB)	Remark	Ant.Pol. (H/V)
4960.000	36.40	5.46	41.86	74.00	-32.14	peak	V
4960.000	29.30	5.46	34.76	54.00	-19.24	AVG	V
7440.000	34.54	13.33	47.87	74.00	-26.13	peak	V
7440.000	25.25	13.33	38.58	54.00	-15.42	AVG	V
9920.000	32.20	17.60	49.80	74.00	-24.20	peak	V
N/A							
4960.000	36.62	5.46	42.08	74.00	-31.92	peak	H
4960.000	29.09	5.46	34.55	54.00	-19.45	AVG	H
7440.000	34.78	13.33	48.11	74.00	-25.89	peak	H
7440.000	25.28	13.33	38.61	54.00	-15.39	AVG	H
9920.000	32.52	17.60	50.12	74.00	-23.88	peak	H
N/A							

Remark:

1. *Measuring frequencies from 1 GHz to the 10th harmonic of highest fundamental frequency.*
2. *Radiated emissions measured in frequency above 1000MHz were made with an instrument using peak/average detector mode.*
3. *Average test would be performed if the peak result were greater than the average limit or as required by the applicant.*
4. *Data of measurement within this frequency range shown " --- " in the table above means the reading of emissions are attenuated more than 20dB below the permissible limits or the field strength is too small to be measured.*
5. *Measurements above show only up to 6 maximum emissions noted, or would be lesser, with " N/A " remark, if no specific emissions from the EUT are recorded (ie: margin>20dB from the applicable limit) and considered that's already beyond the background noise floor.*
6. *Margin (dB) = Remark result (dBuV/m) – Average limit (dBuV/m).*

For PIFA Antenna

Below 1 GHz

Operation Mode: Normal Link

Test Date: September 13, 2016

Temperature: 27°C

Tested by: Dennis Li

Humidity: 53% RH

Polarity: Ver.

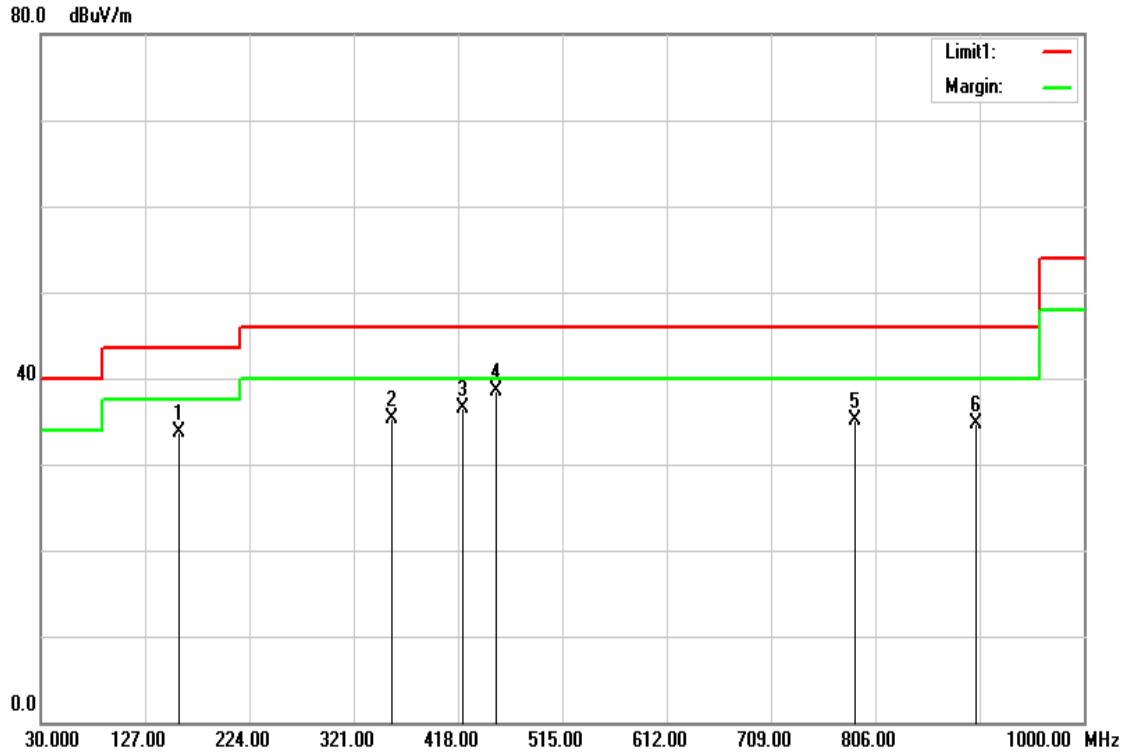

Frequency (MHz)	Reading (dBuV)	Correction Factor (dB/m)	Result (dBuV/m)	Limit (dBuV/m)	Margin (dB)	Remark	Ant. Pol. (H/V)
158.0400	50.10	-16.30	33.80	43.50	-9.70	peak	V
355.9200	48.09	-12.75	35.34	46.00	-10.66	peak	V
421.8800	47.60	-11.04	36.56	46.00	-9.44	peak	V
452.9200	48.62	-10.13	38.49	46.00	-7.51	QP	V
786.6000	39.62	-4.61	35.01	46.00	-10.99	peak	V
900.0900	37.99	-3.19	34.80	46.00	-11.20	peak	V

Remark:

1. No emission found between lowest internal used/generated frequency to 30MHz (9kHz~30MHz)
2. Radiated emissions measured in frequency range from 30 MHz to 1000MHz were made with an instrument using peak/quasi-peak detector mode.
3. Quasi-peak test would be performed if the peak result were greater than the quasi-peak limit or as required by the applicant.
4. Measurements above show only up to 6 maximum emissions noted, or would be lesser, with " N/A " remark, if no specific emissions from the EUT are recorded (ie: margin>20dB from the applicable limit) and considered that's already beyond the background noise floor.
5. Margin (dB) = Remark result (dBuV/m) – Quasi-peak limit (dBuV/m).

Operation Mode: Normal Link

Test Date: September 13, 2016

Temperature: 27°C

Tested by: Dennis Li

Humidity: 53% RH

Polarity: Hor.

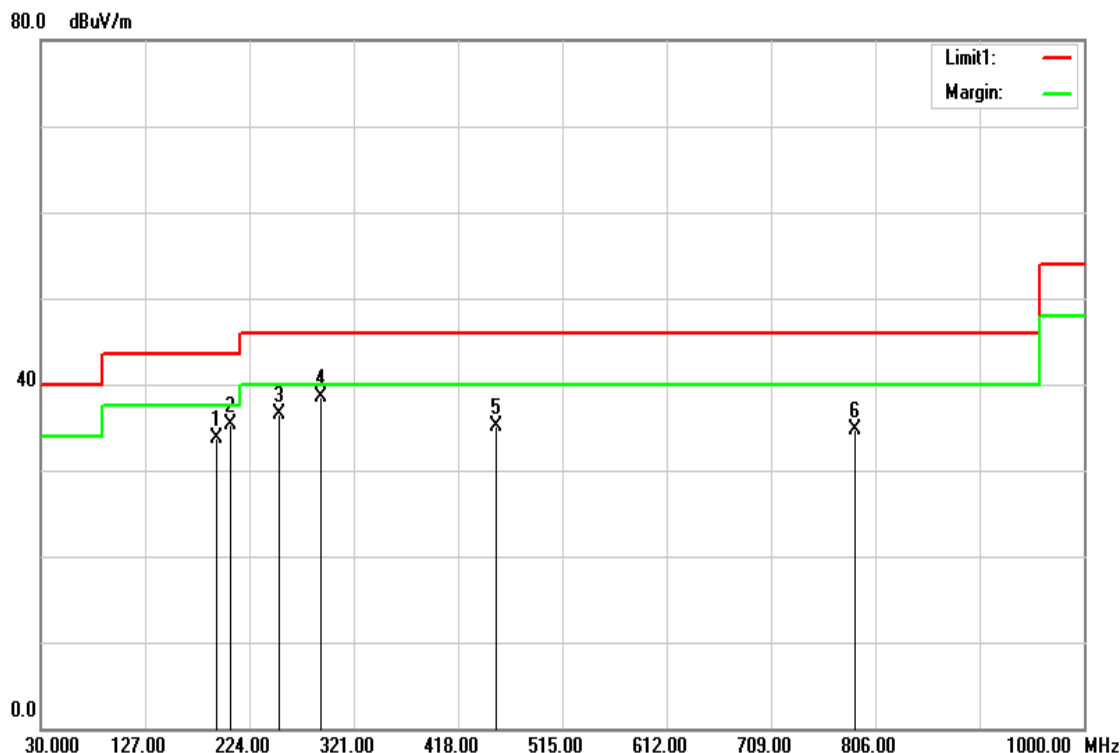

Frequency (MHz)	Reading (dBuV)	Correction Factor (dB/m)	Result (dBuV/m)	Limit (dBuV/m)	Margin (dB)	Remark	Ant. Pol. (H/V)
193.9300	49.89	-16.09	33.80	43.50	-9.70	QP	H
206.5400	51.35	-16.01	35.34	43.50	-8.16	QP	H
251.1600	52.75	-16.19	36.56	46.00	-9.44	peak	H
290.9300	52.90	-14.41	38.49	46.00	-7.51	peak	H
452.9200	45.14	-10.13	35.01	46.00	-10.99	peak	H
786.6000	39.41	-4.61	34.80	46.00	-11.20	peak	H

Remark:

1. No emission found between lowest internal used/generated frequency to 30MHz (9kHz~30MHz)
2. Radiated emissions measured in frequency range from 30 MHz to 1000MHz were made with an instrument using peak/quasi-peak detector mode.
3. Quasi-peak test would be performed if the peak result were greater than the quasi-peak limit or as required by the applicant.
4. Measurements above show only up to 6 maximum emissions noted, or would be lesser, with " N/A " remark, if no specific emissions from the EUT are recorded (ie: margin>20dB from the applicable limit) and considered that's already beyond the background noise floor.
5. Margin (dB) = Remark result (dBuV/m) – Quasi-peak limit (dBuV/m).

Above 1 GHz

GFSK / TX / CH Low

Polarity: Vertical

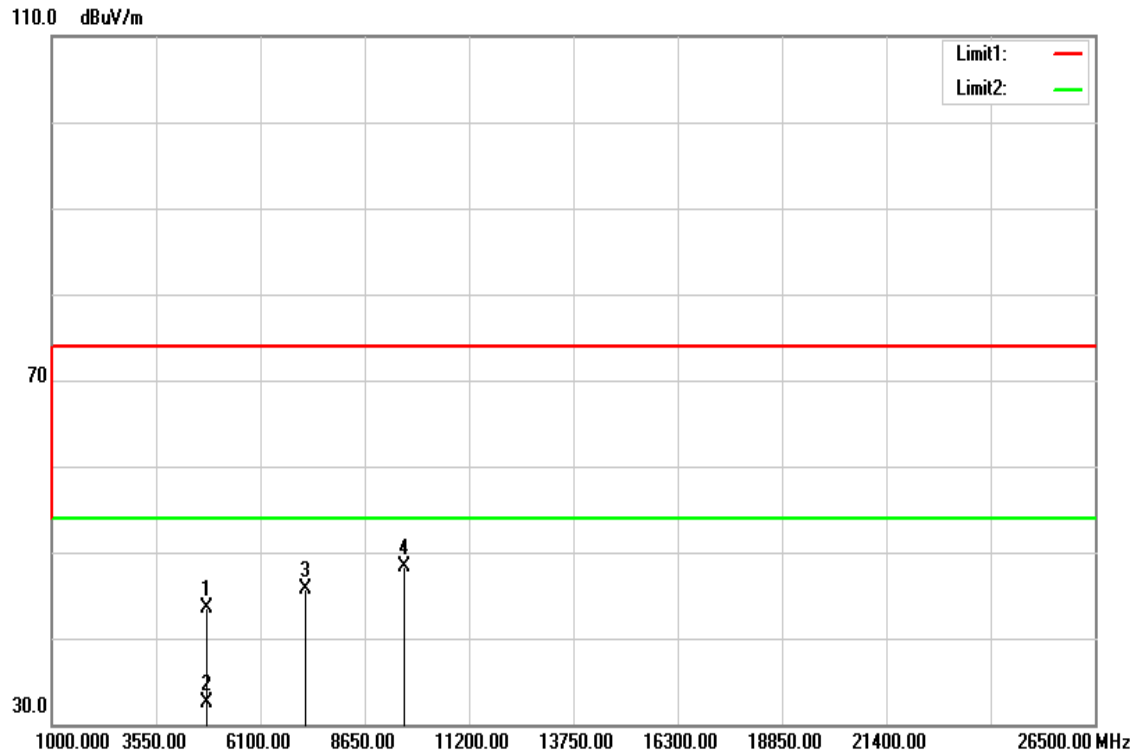

Polarity: Horizontal

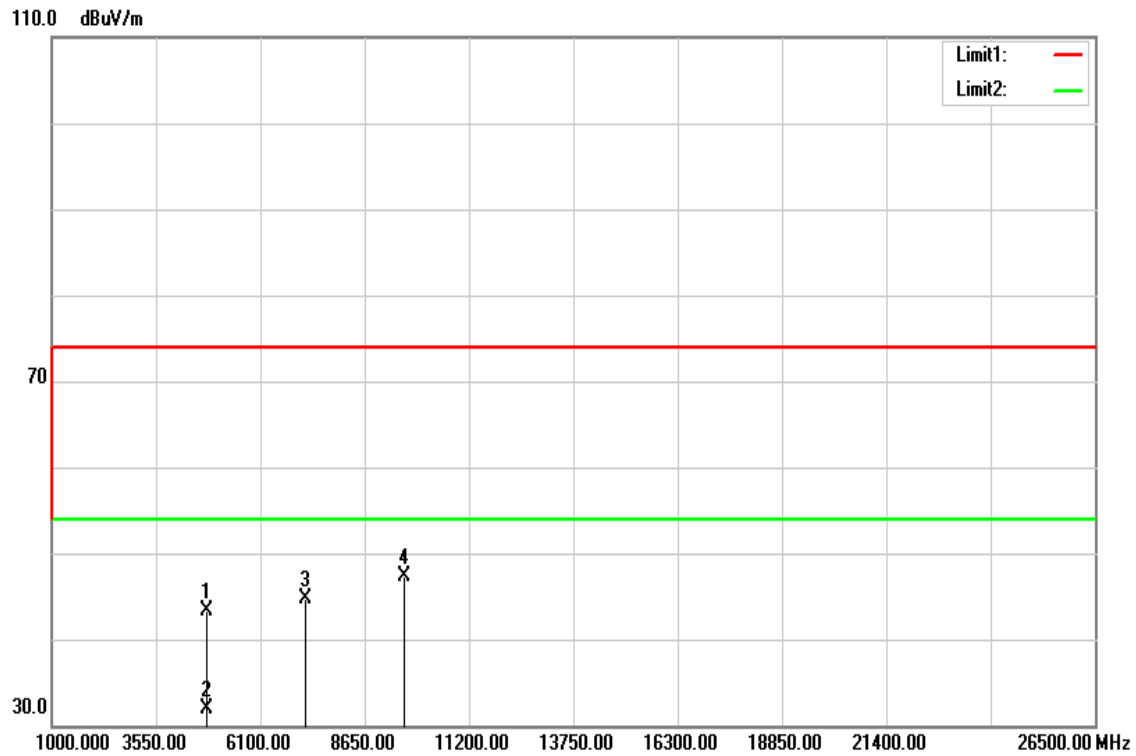

Operation Mode: GFSK / TX / CH Low

Test Date: September 7, 2016

Temperature: 27°C

Tested by: Dennis Li

Humidity: 53 % RH

Polarity: Ver. / Hor.

Frequency (MHz)	Reading (dBuV)	Correction (dB/m)	Result (dBuV/m)	Limit (dBuV/m)	Margin (dB)	Remark	Ant.Pol. (H/V)
4804.000	39.44	4.14	43.58	74.00	-30.42	peak	V
4804.000	28.27	4.14	32.41	54.00	-21.59	AVG	V
7206.000	34.31	11.34	45.65	74.00	-28.35	peak	V
9608.000	32.92	15.29	48.21	74.00	-25.79	peak	V
N/A							
4804.000	39.07	4.14	43.21	74.00	-30.79	peak	H
4804.000	27.71	4.14	31.85	54.00	-22.15	AVG	H
7206.000	33.39	11.34	44.73	74.00	-29.27	peak	H
9608.000	32.10	15.29	47.39	74.00	-26.61	peak	H
N/A							

Remark:

1. Measuring frequencies from 1 GHz to the 10th harmonic of highest fundamental frequency.
2. Radiated emissions measured in frequency above 1000MHz were made with an instrument using peak/average detector mode.
3. Average test would be performed if the peak result were greater than the average limit or as required by the applicant.
4. Data of measurement within this frequency range shown " --- " in the table above means the reading of emissions are attenuated more than 20dB below the permissible limits or the field strength is too small to be measured.
5. Measurements above show only up to 6 maximum emissions noted, or would be lesser, with " N/A " remark, if no specific emissions from the EUT are recorded (ie: margin>20dB from the applicable limit) and considered that's already beyond the background noise floor.
6. Margin (dB) = Remark result (dBuV/m) – Average limit (dBuV/m).

GFSK / TX / CH Mid

Polarity: Vertical

110.0 dBuV/m

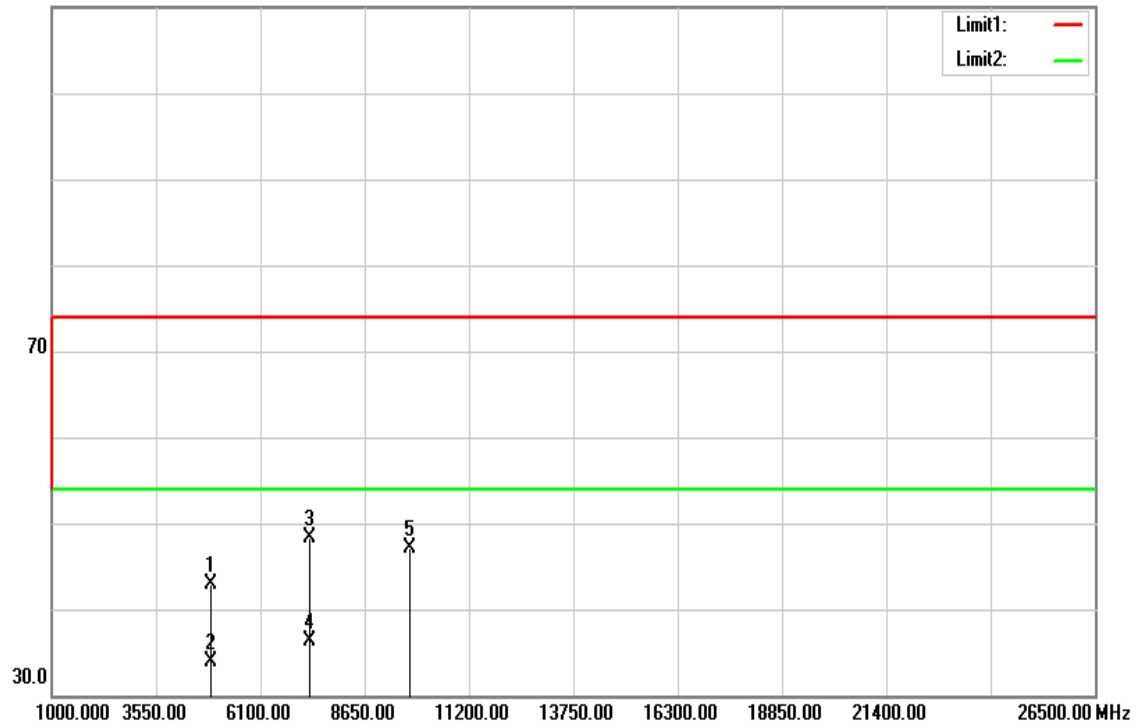

Polarity: Horizontal

110.0 dBuV/m

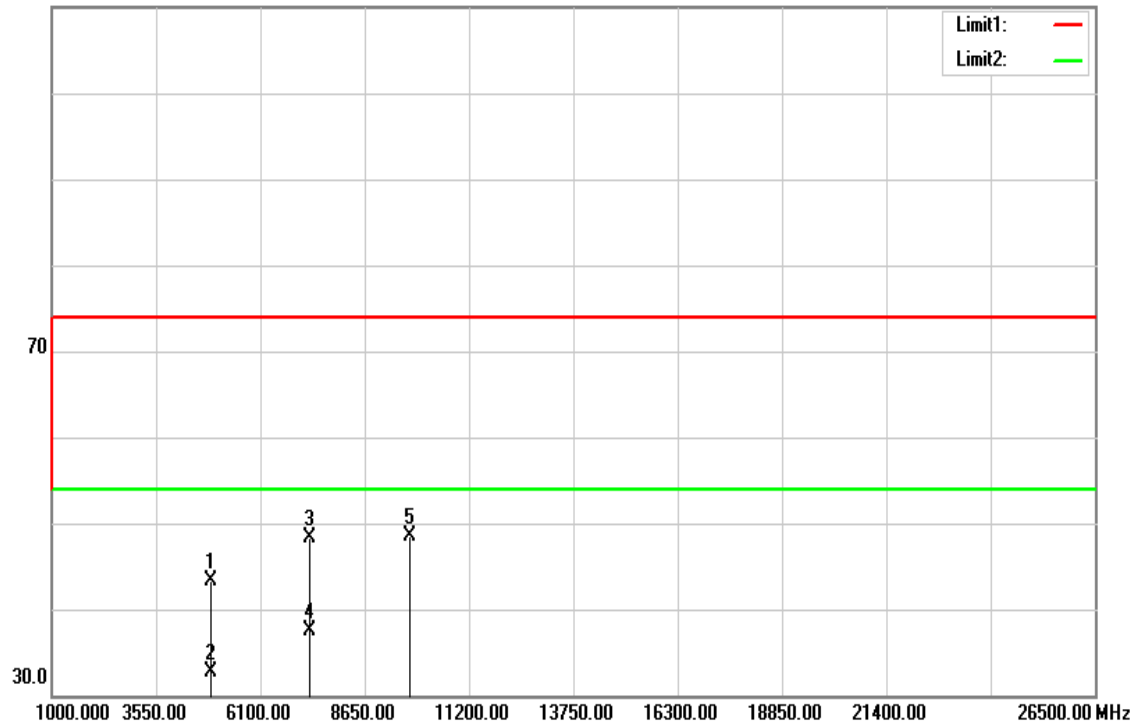

Operation Mode: GFSK / TX / CH Mid

Test Date: September 7, 2016

Temperature: 27°C

Tested by: Dennis Li

Humidity: 53 % RH

Polarity: Ver. / Hor.

Frequency (MHz)	Reading (dBuV)	Correction (dB/m)	Result (dBuV/m)	Limit (dBuV/m)	Margin (dB)	Remark	Ant.Pol. (H/V)
4880.000	38.66	4.33	42.99	74.00	-31.01	peak	V
4880.000	29.51	4.33	33.84	54.00	-20.16	AVG	V
7320.000	36.83	11.57	48.40	74.00	-25.60	peak	V
7320.000	24.83	11.57	36.40	54.00	-17.60	AVG	V
9760.000	31.56	15.50	47.06	74.00	-26.94	peak	V
N/A							
4880.000	39.04	4.33	43.37	74.00	-30.63	peak	H
4880.000	28.31	4.33	32.64	54.00	-21.36	AVG	H
7320.000	36.83	11.57	48.40	74.00	-25.60	peak	H
7320.000	25.98	11.57	37.55	54.00	-16.45	AVG	H
9760.000	33.01	15.50	48.51	74.00	-25.49	peak	H
N/A							

Remark:

1. Measuring frequencies from 1 GHz to the 10th harmonic of highest fundamental frequency.
2. Radiated emissions measured in frequency above 1000MHz were made with an instrument using peak/average detector mode.
3. Average test would be performed if the peak result were greater than the average limit or as required by the applicant.
4. Data of measurement within this frequency range shown " --- " in the table above means the reading of emissions are attenuated more than 20dB below the permissible limits or the field strength is too small to be measured.
5. Measurements above show only up to 6 maximum emissions noted, or would be lesser, with " N/A " remark, if no specific emissions from the EUT are recorded (ie: margin>20dB from the applicable limit) and considered that's already beyond the background noise floor.
6. Margin (dB) = Remark result (dBuV/m) – Average limit (dBuV/m).

GFSK / TX / CH High

Polarity: Vertical

110.0 dBuV/m

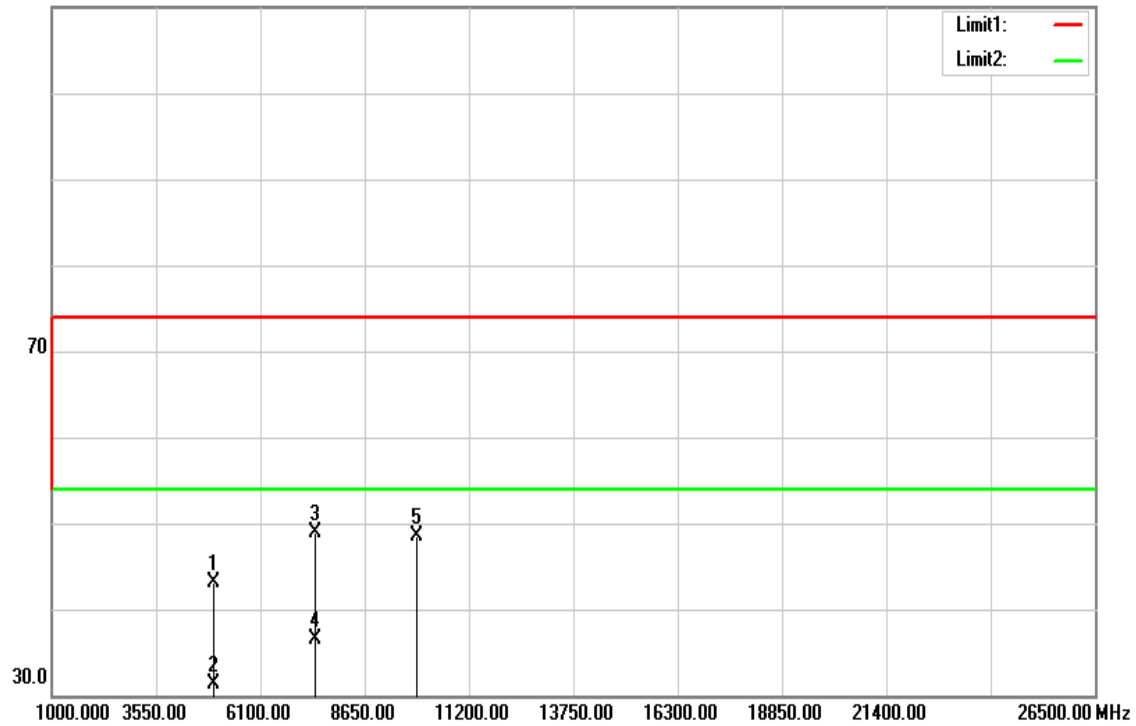

Polarity: Horizontal

110.0 dBuV/m

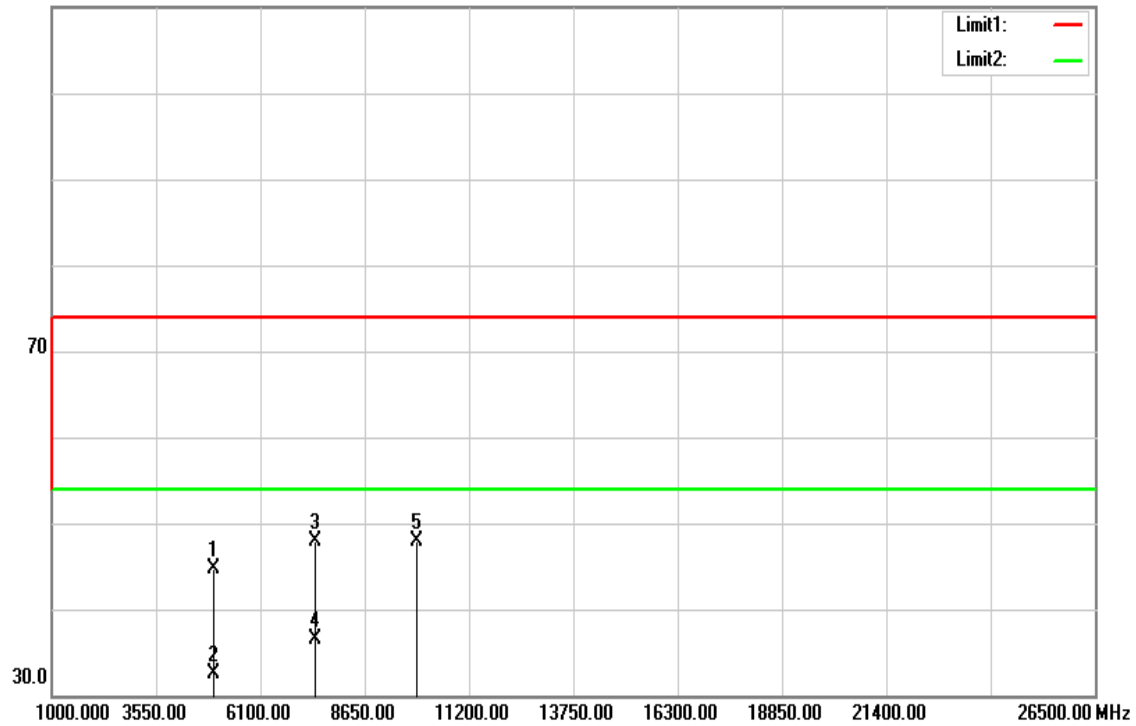

Operation Mode: GFSK / TX / CH High

Test Date: September 7, 2016

Temperature: 27°C

Tested by: Dennis Li

Humidity: 53 % RH

Polarity: Ver. / Hor.

Frequency (MHz)	Reading (dBuV)	Correction (dB/m)	Result (dBuV/m)	Limit (dBuV/m)	Margin (dB)	Remark	Ant.Pol. (H/V)
4960.000	38.51	4.55	43.06	74.00	-30.94	peak	V
4960.000	26.73	4.55	31.28	54.00	-22.72	AVG	V
7440.000	37.02	11.81	48.83	74.00	-25.17	peak	V
7440.000	24.70	11.81	36.51	54.00	-17.49	AVG	V
9920.000	32.77	15.73	48.50	74.00	-25.50	peak	V
N/A							
4960.000	40.10	4.55	44.65	74.00	-29.35	peak	H
4960.000	27.93	4.55	32.48	54.00	-21.52	AVG	H
7440.000	36.04	11.81	47.85	74.00	-26.15	peak	H
7440.000	24.64	11.81	36.45	54.00	-17.55	AVG	H
9920.000	32.21	15.73	47.94	74.00	-26.06	peak	H
N/A							

Remark:

1. Measuring frequencies from 1 GHz to the 10th harmonic of highest fundamental frequency.
2. Radiated emissions measured in frequency above 1000MHz were made with an instrument using peak/average detector mode.
3. Average test would be performed if the peak result were greater than the average limit or as required by the applicant.
4. Data of measurement within this frequency range shown " --- " in the table above means the reading of emissions are attenuated more than 20dB below the permissible limits or the field strength is too small to be measured.
5. Measurements above show only up to 6 maximum emissions noted, or would be lesser, with " N/A " remark, if no specific emissions from the EUT are recorded (ie: margin>20dB from the applicable limit) and considered that's already beyond the background noise floor.
6. Margin (dB) = Remark result (dBuV/m) – Average limit (dBuV/m).

7.8 POWERLINE CONDUCTED EMISSIONS

LIMIT

According to §15.207(a) & RSS-Gen §8.8, for an intentional radiator that is designed to be connected to the public utility (AC) power line, the radio frequency voltage that is conducted back onto the AC power line on any frequency or frequencies within the band 150 kHz to 30 MHz shall not exceed the limits in the following table, as measured using a 50 μ H/50 ohms line impedance stabilization network (LISN). Compliance with the provisions of this paragraph shall be based on the measurement of the radio frequency voltage between each power line and ground at the power terminal. The lower limit applies at the boundary between the frequency ranges.

Frequency Range (MHz)	Limits (dB μ V)	
	Quasi-peak	Average
0.15 to 0.50	66 to 56*	56 to 46*
0.50 to 5	56	46
5 to 30	60	50

Test Configuration

See test photographs attached in Appendix II for the actual connections between EUT and support equipment.

TEST PROCEDURE

1. The EUT was placed on a table, which is 0.8m above ground plane.
2. Maximum procedure was performed on the six highest emissions to ensure EUT compliance.
3. Repeat above procedures until all frequency measured were complete.

TEST RESULTS

Test Data

Operation Mode: Normal Link **Test Date:** September 26, 2016
Temperature: 24°C **Tested by:** Dennis Li
Humidity: 50% RH

Freq. (MHz)	QP Reading (dBuV)	AV Reading (dBuV)	Corr. factor (dB/m)	QP Result (dBuV/m)	AV Result (dBuV/m)	QP Limit (dBuV)	AV Limit (dBuV)	QP Margin (dB)	AV Margin (dB)	Note
0.1660	41.08	39.51	9.69	50.77	49.20	65.15	55.16	-14.38	-5.96	L1
0.2980	34.85	32.58	9.68	44.53	42.26	60.30	50.30	-15.77	-8.04	L1
1.7340	29.09	27.55	9.96	39.05	37.51	56.00	46.00	-16.95	-8.49	L1
3.8140	32.88	30.28	9.82	42.70	40.10	56.00	46.00	-13.30	-5.90	L1
6.0140	33.71	30.78	9.86	43.57	40.64	60.00	50.00	-16.43	-9.36	L1
9.1340	36.41	34.53	9.92	46.33	44.45	60.00	50.00	-13.67	-5.55	L1
0.1700	40.98	38.48	9.64	50.62	48.12	64.96	54.96	-14.34	-6.84	L2
0.1900	39.24	37.88	9.64	48.88	47.52	64.03	54.04	-15.15	-6.48	L2
0.2980	36.91	34.87	9.64	46.55	44.51	60.30	50.30	-13.75	-5.79	L2
1.7780	29.02	27.44	9.89	38.91	37.33	56.00	46.00	-17.09	-8.67	L2
8.9020	35.95	33.74	9.89	45.84	43.63	60.00	50.00	-14.16	-6.37	L2
9.6500	35.69	33.94	9.91	45.60	43.85	60.00	50.00	-14.40	-6.15	L2

Remark:

1. *Measuring frequencies from 0.15 MHz to 30MHz.*
2. *The emissions measured in frequency range from 0.15 MHz to 30MHz were made with an instrument using Quasi-peak detector and average detector.*
3. *The IF bandwidth of SPA between 0.15MHz to 30MHz was 10kHz; the IF bandwidth of Test Receiver between 0.15MHz to 30MHz was 9kHz;*
4. *L1 = Line One (Live Line) / L2 = Line Two (Neutral Line)*

Test Plots

Conducted emissions (Line 1)

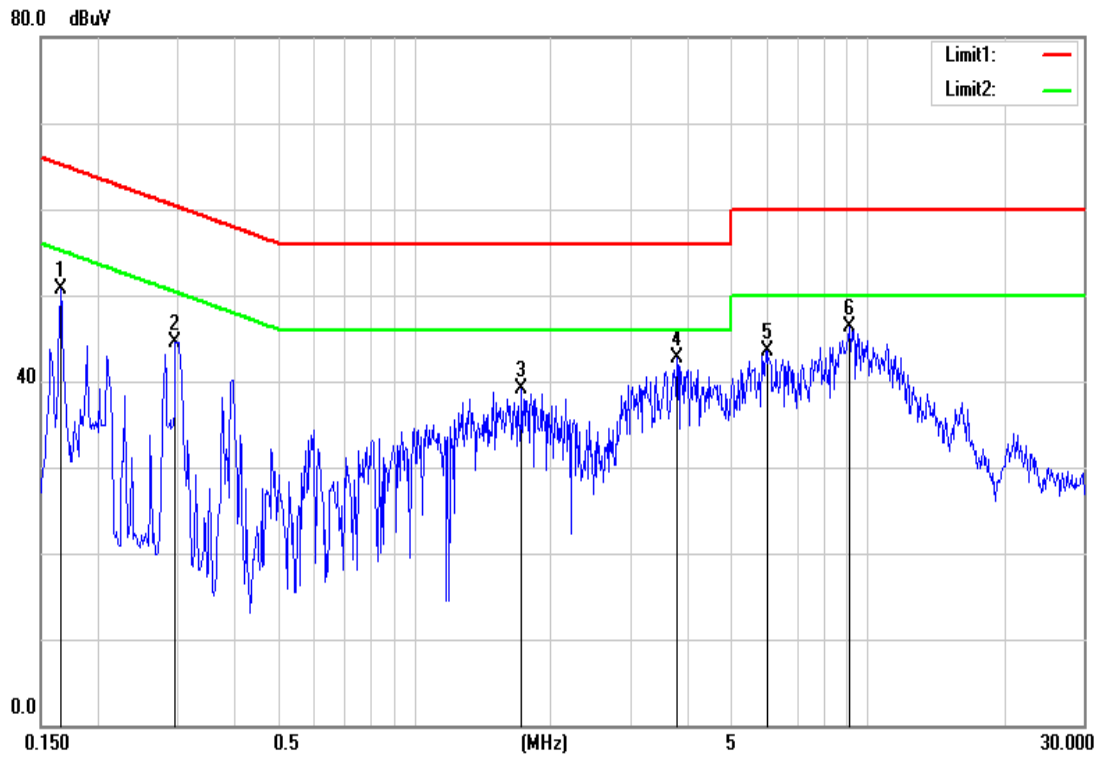

Conducted emissions (Line 2)

