

**FCC 47 CFR PART 15 SUBPART E &
INDUSTRY CANADA RSS-247**

TEST REPORT

For

Wi-Fi (11a/b/g/n 2Tx2R)+BT (V4.2LE) USB Combo Module

Model: WCBN4513R

Trade Name: LITE-ON

Issued to

**Lite-On Technology Corp.
Bldg. C, 90, Chien 1 Road, Chung Ho, New Taipei City 23585, Taiwan,
R.O.C**

Issued by

Compliance Certification Services Inc.

**No.11, Wugong 6th Rd., Wugu Dist.,
New Taipei City 24891, Taiwan. (R.O.C.)**

<http://www.ccsrf.com>

service@ccsrf.com

Issued Date: August 15, 2016



Note: This report shall not be reproduced except in full, without the written approval of Compliance Certification Services Inc. This document may be altered or revised by Compliance Certification Services Inc. personnel only, and shall be noted in the revision section of the document.

Revision History

Rev.	Issue Date	Revisions	Effect Page	Revised By
00	August 15, 2016	Initial Issue	ALL	Doris Chu

TABLE OF CONTENTS

1. TEST RESULT CERTIFICATION	4
2. EUT DESCRIPTION.....	5
3. TEST METHODOLOGY.....	6
3.1 EUT CONFIGURATION	6
3.2 EUT EXERCISE	6
3.3 GENERAL TEST PROCEDURES	6
3.4 FCC PART 15.205 RESTRICTED BANDS OF OPERATIONS.....	7
3.5 DESCRIPTION OF TEST MODES	8
3.6 THE WORST CASE POWER SETTING PARAMETER.....	9
4. INSTRUMENT CALIBRATION	10
4.1 MEASURING INSTRUMENT CALIBRATION.....	10
4.2 MEASUREMENT EQUIPMENT USED.....	10
4.3 MEASUREMENT UNCERTAINTY	11
5 FACILITIES AND ACCREDITATIONS	12
5.1 FACILITIES	12
5.2 LABORATORY ACCREDITATIONS AND LISTING	12
5.3 TABLE OF ACCREDITATIONS AND LISTINGS	13
6 SETUP OF EQUIPMENT UNDER TEST	14
6.1 SETUP CONFIGURATION OF EUT	14
6.2 SUPPORT EQUIPMENT	14
7 RSS-247 REQUIREMENTS	15
7.1 99%BANDWIDTH.....	15
7.2 6DB BANDWIDTH	25
7.3 MAXIMUM CONDUCTED OUTPUT POWER	35
7.4 BAND EDGES MEASUREMENT	37
7.5 PEAK POWER SPECTRAL DENSITY	55
7.6 RADIATED EMISSIONS.....	65
7.7 POWERLINE CONDUCTED EMISSIONS	87
APPENDIX I PHOTOGRAPHS OF TEST SETUP.....	90

1. TEST RESULT CERTIFICATION

Applicant: Lite-On Technology Corp.
 Bldg. C, 90, Chien 1 Road, Chung Ho, New Taipei City 23585,
 Taiwan, R.O.C

Manufacturer: LITE-ON TECHNOLOGY (Changzhou) CO., LTD
 A9 Building, No.88 Yanghu Road, Wujin Hi-Tech Industrial
 Development Zone, Changzhou City,
 Jiangsu Province 213100 China

Equipment Under Test: Wi-Fi (11a/b/g/n 2Tx2R)+BT (V4.2LE) USB Combo Module

Model Number: WCBN4513R

Trade Name: LITE-ON

Date of Test: July 29 ~ August 5, 2016

APPLICABLE STANDARDS	
STANDARD	TEST RESULT
FCC 47 CFR Part 15 Subpart E & Industry Canada RSS-247 Issue 1	No non-compliance noted

We hereby certify that:

Compliance Certification Services Inc. tested the above equipment in accordance with the requirements set forth in the above standards. The test results show that the equipment tested is capable of demonstrating compliance with the requirements as documented in this report.

The test results of this report relate only to the tested sample identified in this report.

Approved by:

Tested by:

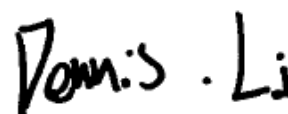
Miller Lee
 Manager
 Compliance Certification Services Inc.

Dennis Li
 Engineer
 Compliance Certification Services Inc.

2. EUT DESCRIPTION

Product	Wi-Fi (11a/b/g/n 2Tx2R)+BT (V4.2LE) USB Combo Module
Model Number	WCBN4513R
Trade Name	LITE-ON
Model Discrepancy	N/A
Received Date	June 25, 2016
Power supply	Power form host device.
Frequency Range	IEEE 802.11a / IEEE 802.11n HT 20 MHz: 5745 ~ 5825 MHz IEEE 802.11n HT 40 MHz: 5755 ~ 5795 MHz
Transmit Power	IEEE 802.11a mode: 13.23dBm IEEE 802.11n HT 20 MHz mode: 18.48 dBm IEEE 802.11n HT 40 MHz mode: 16.57 dBm
Number of Channels	IEEE 802.11a mode: 5 Channels IEEE 802.11n HT 20 MHz mode: 5 Channels IEEE 802.11n HT 40 MHz mode: 2 Channels
Antenna Specification	Walsin / RFMTA200700NNLB002 PIFA Antenna Ant0: Gain: 2.62dBi Ant1: Gain: 3.22dBi
Product SW/HW version	SW: V1.0.3.19 HW: V01
Radio SW version	SW: V1.0.3.19
Radio HW version	HW: V01

Remark: 1. The sample selected for test was engineering sample that approximated to production product and was provided by manufacturer.

2. The device is restricted to transmit in the band 5600 ~ 5650 MHz

3. TEST METHODOLOGY

The tests documented in this report were performed in accordance with ANSI C63.10: 2013 and FCC CFR 47 Part 15.207, 15.209, 15.407 and KDB 789033 D02 General UNII Test Procedures New Rules v01r02.

The tests documented in this report were performed in accordance with IC RSS-247, IC RSS-Gen and ANSI C63.10:2013.

This submittal(s) (test report) is intended for IC Certification with Industry Canada RSS-247.

3.1 EUT CONFIGURATION

The EUT configuration for testing is installed for RF field strength measurement to meet the Commissions requirement, and is operated in a manner intended to generate the maximum emission in a continuous normal application.

3.2 EUT EXERCISE

The EUT is operated in the engineering mode to fix the Tx frequency for the purposes of measurement.

According to its specifications, the EUT must comply with the requirements of Section 15.407 under the FCC Rules Part 15 Subpart E.

3.3 GENERAL TEST PROCEDURES

Conducted Emissions

According to the requirements in ANSI C63.10: 2013, the conducted emission from the EUT is measured in the frequency range between 0.15 MHz and 30MHz, using the CISPR Quasi-Peak detector mode.

Radiated Emissions

The EUT is placed on the turntable, which is 1.5 m above the ground plane. The turntable is then rotated for 360 degrees to determine the proper orientation for the maximum emission level. The EUT is set 3m away from the receiving antenna, which is varied from 1m to 4m to find out the highest emission level. And, each emission is to be maximized by changing the horizontal and vertical polarization of the receiving antenna. In order to find out the maximum emissions, exploratory radiated emission measurements were made according to the requirements in ANSI C63.10: 2013.

3.4 FCC PART 15.205 RESTRICTED BANDS OF OPERATIONS

(a) Except as shown in paragraph (d) of this section, only spurious emissions are permitted in any of the frequency bands listed below:

MHz	MHz	MHz	GHz
0.090 - 0.110	16.42 - 16.423	399.9 - 410	4.5 - 5.15
¹ 0.495 - 0.505	16.69475 - 16.69525	608 - 614	5.35 - 5.46
2.1735 - 2.1905	16.80425 - 16.80475	960 - 1240	7.25 - 7.75
4.125 - 4.128	25.5 - 25.67	1300 - 1427	8.025 - 8.5
4.17725 - 4.17775	37.5 - 38.25	1435 - 1626.5	9.0 - 9.2
4.20725 - 4.20775	73 - 74.6	1645.5 - 1646.5	9.3 - 9.5
6.215 - 6.218	74.8 - 75.2	1660 - 1710	10.6 - 12.7
6.26775 - 6.26825	108 - 121.94	1718.8 - 1722.2	13.25 - 13.4
6.31175 - 6.31225	123 - 138	2200 - 2300	14.47 - 14.5
8.291 - 8.294	149.9 - 150.05	2310 - 2390	15.35 - 16.2
8.362 - 8.366	156.52475 -	2483.5 - 2500	17.7 - 21.4
8.37625 - 8.38675	156.52525	2655 - 2900	22.01 - 23.12
8.41425 - 8.41475	156.7 - 156.9	3260 - 3267	23.6 - 24.0
12.29 - 12.293	162.0125 - 167.17	3332 - 3339	31.2 - 31.8
12.51975 - 12.52025	167.72 - 173.2	3345.8 - 3358	36.43 - 36.5
12.57675 - 12.57725	240 - 285	3600 - 4400	(²)
13.36 - 13.41	322 - 335.4		

¹ Until February 1, 1999, this restricted band shall be 0.490-0.510 MHz.

² Above 38.6

(b) Except as provided in paragraphs (d) and (e), the field strength of emissions appearing within these frequency bands shall not exceed the limits shown in Section 15.209. At frequencies equal to or less than 1000 MHz, compliance with the limits in Section 15.209 shall be demonstrated using measurement instrumentation employing a CISPR quasi-peak detector. Above 1000 MHz, compliance with the emission limits in Section 15.209 shall be demonstrated based on the average value of the measured emissions. The provisions in Section 15.35 apply to these measurements.

3.5 DESCRIPTION OF TEST MODES

The EUT (model: WCBN4513R) had been tested under operating condition.

The EUT is a 2x2 configuration spatial MIMO (2Tx & 2Rx) without beam forming function that operate in double TX chains and double RX chains. The 2x2 configuration is implemented with two outside TX & RX chains (Chain 0 and 1).

Software used to control the EUT for staying in continuous transmitting and receiving mode was programmed.

After verification, all tests were carried out with the worst case test modes as shown below except radiated spurious emission below 1GHz, which worst case was in normal link mode only.

IEEE 802.11a mode / 5745 ~ 5825MHz

Channel Low (5745MHz), Channel Mid (5785MHz) and Channel High (5825MHz) with 6Mbps data rate were chosen for full testing.

IEEE 802.11n HT 20 MHz mode / 5745 ~ 5825MHz

Channel Low(5745MHz), Channel Mid(5785MHz) and Channel High(5825MHz) with 6.5Mbps data rate were chosen for full testing.

IEEE 802.11n HT 40 MHz mode / 5755 ~ 5795MHz

Channel Low(5755MHz) and Channel High(5795MHz) with 13.5Mbps data rate were chosen for full testing.

The field strength of spurious emission was measured in the following position: EUT stand-up position (Z axis), lie-down position (X, Y axis). The worst emission was found in lie-down position (X axis) and the worst case was recorded.

3.6 THE WORST CASE POWER SETTING PARAMETER

IEEE 802.11a mode / 5745 ~ 5825MHz

Channel	Frequency (MHz)	RF power setting in TEST SW
Low	5745	1D
Mid	5785	1C
High	5825	1C

IEEE 802.11n HT 20 MHz mode / 5745 ~ 5825MHz

Channel	Frequency (MHz)	RF power setting in TEST SW (Chin 0)	RF power setting in TEST SW (Chin 1)
Low	5745	1F	1F
Mid	5785	21	20
High	5825	20	21

IEEE 802.11n HT 40 MHz mode / 5755 ~ 5795MHz

Channel	Frequency (MHz)	RF power setting in TEST SW (Chin 0)	RF power setting in TEST SW (Chin 1)
Low	5755	22	21
High	5795	22	21

4. INSTRUMENT CALIBRATION

4.1 MEASURING INSTRUMENT CALIBRATION

The measuring equipment, which was utilized in performing the tests documented herein, has been calibrated in accordance with the manufacturer's recommendations for utilizing calibration equipment, which is traceable to recognized national standards.

4.2 MEASUREMENT EQUIPMENT USED

Equipment Used for Emissions Measurement

Conducted Emissions Test Site					
Name of Equipment	Manufacturer	Model	Serial Number	Calibration Date	Calibration Due
Power Meter	Anritsu	ML2495A	1012009	2016/7/4	2017/7/3
Power Meter	Anritsu	MA2411B	917072	2016/7/4	2017/7/3
Spectrum Analyzer	R&S	FSV 40	101073	2016/8/1	2017/7/31

Wugu 966 Chamber A					
Name of Equipment	Manufacturer	Model	Serial Number	Calibration Date	Calibration Due
Spectrum Analyzer	Agilent	E4446A	US42510252	2015/12/8	2016/12/7
Bilog Antenna	Sunol Sciences	JB3	A030105	2016/8/5	2017/8/4
Pre-Amplifier	EMEC	EM330	60609	2016/6/8	2017/6/7
Horn Antenna	ETC	MCTD 1209	DRH13M02003	2015/9/2	2016/9/1
Antenna Tower	CCS	CC-A-1F	N/A	N.C.R	N.C.R
Controller	CCS	CC-C-1F	N/A	N.C.R	N.C.R
Turn Table	CCS	CC-T-1F	N/A	N.C.R	N.C.R
Software	EZ-EMC (CCS-3A1RE)				

Conducted Emission Room # B					
Name of Equipment	Manufacturer	Model	Serial Number	Calibration Date	Calibration Due
LISN	R&S	ENV216	101054	2016/5/11	2017/5/10
Receiver	R&S	ESCI	101073	2015/9/9	2016/9/8
Software	CCS-3A1-CE				

Remark:

1. Each piece of equipment is scheduled for calibration once a year and Precision Dipole is scheduled for calibration once three years.
2. N.C.R. = No Calibration Request.

4.3 MEASUREMENT UNCERTAINTY

PARAMETER	UNCERTAINTY
Powerline Conducted Emission	+/- 1.2575
3M Semi Anechoic Chamber / 30M~200M	+/- 4.0138
3M Semi Anechoic Chamber / 200M~1000M	+/- 3.9483
3M Semi Anechoic Chamber / 1G~8G	+/- 2.5975
3M Semi Anechoic Chamber / 8G~18G	+/- 2.6112
3M Semi Anechoic Chamber / 18G~26G	+/- 2.7389
3M Semi Anechoic Chamber / 26G~40G	+/- 2.9683

Remark: This uncertainty represents an expanded uncertainty expressed at approximately the 95% confidence level using a coverage factor of $k=2$.

5 FACILITIES AND ACCREDITATIONS

5.1 FACILITIES

All measurement facilities used to collect the measurement data are located at

- No.199, Chungshen Road, Hsintien City, Taipei Hsien, Taiwan, R.O.C.
Tel: 886-2-2217-0894 / Fax: 886-2-2217-1029
- No.11, Wugong 6th Rd., Wugu Dist., New Taipei City 248, Taiwan (R.O.C.)
Tel: 886-2-2299-9720 / Fax: 886-2-2298-4045
- No.81-1, Lane 210, Bade 2nd Rd., Lujhu Township, Taoyuan County 33841, TAIWAN, R.O.C.
Tel: 886-3-324-0332 / Fax: 886-3-324-5235



The sites are constructed in conformance with the requirements of ANSI C63.7, ANSI C63.10: 2013 and CISPR Publication 22.

All receiving equipment conforms to CISPR Publication 16-1, "Radio Interference Measuring Apparatus and Measurement Methods."

5.2 LABORATORY ACCREDITATIONS AND LISTING

The test facilities used to perform radiated and conducted emissions tests are accredited by American Association for Laboratory Accreditation Program for the specific scope accreditation under Lab Code: 0824-01 to perform Electromagnetic Interference tests according to FCC Part 15 and CISPR 22 requirements. In addition, the test facilities are listed with Industry Canada, Certification and Engineering Bureau, IC 2324G-1 for 3M Semi Anechoic Chamber A, IC 2324G-2 for 3M Semi Anechoic Chamber B.

5.3 TABLE OF ACCREDITATIONS AND LISTINGS

Country	Agency	Scope of Accreditation	Logo
USA	FCC	3M Semi Anechoic Chamber (FCC MRA: TW1039) to perform FCC Part 15 measurements	 FCC MRA: TW1039
Taiwan	TAF	LP0002, RTTE01, FCC Method-47 CFR Part 15 Subpart C, D, E, RSS-247, RSS-310 IDA TS SRD, AS/NZS 4268, AS/NZS 4771, TS 12.1 & 12.2, ETSI EN 300 440-1, ETSI EN 300 440-2, ETSI EN 300 328, ETSI EN 300 220-1, ETSI EN 300 220-2, ETSI EN 301 893, ETSI EN 301 489-1/3/7/17 FCC OET Bulletin 65 + Supplement C, EN 50360, EN 50361, EN 50371, RSS 102, EN 50383, EN 50385, EN 50392, IEC 62209, CNS 14958-1, CNS 14959 FCC Method -47 CFR Part 15 Subpart B IEC / EN 61000-3-2, IEC / EN 61000-3-3, IEC / EN 61000-4-2/3/4/5/6/8/11	
Canada	Industry Canada	3M Semi Anechoic Chamber (IC 2324G-1 / IC 2324G-2) to perform	

* No part of this report may be used to claim or imply product endorsement by A2LA or any agency of the US Government.

6 SETUP OF EQUIPMENT UNDER TEST

6.1 SETUP CONFIGURATION OF EUT

See test photographs attached in Appendix I for the actual connections between EUT and support equipment.

6.2 SUPPORT EQUIPMENT

No	Equipment	Brand	Model	Series No.	FCC ID	Data Cable	Power Cord
1	Notebook PC	ASUS	M5200AE	5BN0AG019631	PD9WM3B2100	N/A	AC I/P: Unshielded, 1.8m with a core DC O/P: Unshielded, 1.8m
2	Fixture	LITEON	LITEON	N/A	N/A	N/A	N/A

Remark:

1. *All the equipment/cables were placed in the worst-case configuration to maximize the emission during the test.*
2. *Grounding was established in accordance with the manufacturer's requirements and conditions for the intended use.*

7 RSS-247 REQUIREMENTS

7.1 99%BANDWIDTH

Test Configuration

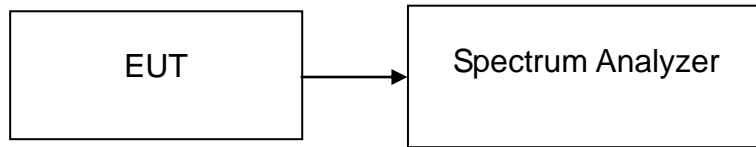

TEST PROCEDURE

The resolution bandwidth shall be set to as close to 1% of the selected span as is possible without being below 1%. The video bandwidth shall be set to 3 times the resolution bandwidth. Video averaging is not permitted. Where practical, a sampling detector shall be used since a peak or, peak hold.

TEST RESULTS

No non-compliance noted.

Test Data**Test mode: IEEE 802.11a mode / 5745 ~ 5825MHz**

Channel	Frequency (MHz)	99%Bandwidth (MHz)
Low	5745	16.4544
Mid	5785	16.4544
High	5825	16.4978

Test mode: IEEE 802.11n HT 20 MHz mode / Chain 0

Channel	Frequency (MHz)	99% Bandwidth (MHz)
Low	5745	17.5832
Mid	5785	17.5832
High	5825	17.5832

Test mode: IEEE 802.11n HT 20 MHz mode / Chain 1

Channel	Frequency (MHz)	99% Bandwidth (MHz)
Low	5745	17.5832
Mid	5785	17.5832
High	5825	17.5832

Test mode: IEEE 802.11n HT 40 MHz mode / Chain 0

Channel	Frequency (MHz)	99% Bandwidth (MHz)
Low	5755	35.7742
High	5795	35.8900

Test mode: IEEE 802.11n HT 40 MHz mode / Chain 1

Channel	Frequency (MHz)	99% Bandwidth (MHz)
Low	5755	35.7742
High	5795	35.7742

Test Plot

IEEE 802.11a mode / 5745 ~ 5825MHz

99% Bandwidth (CH Low)

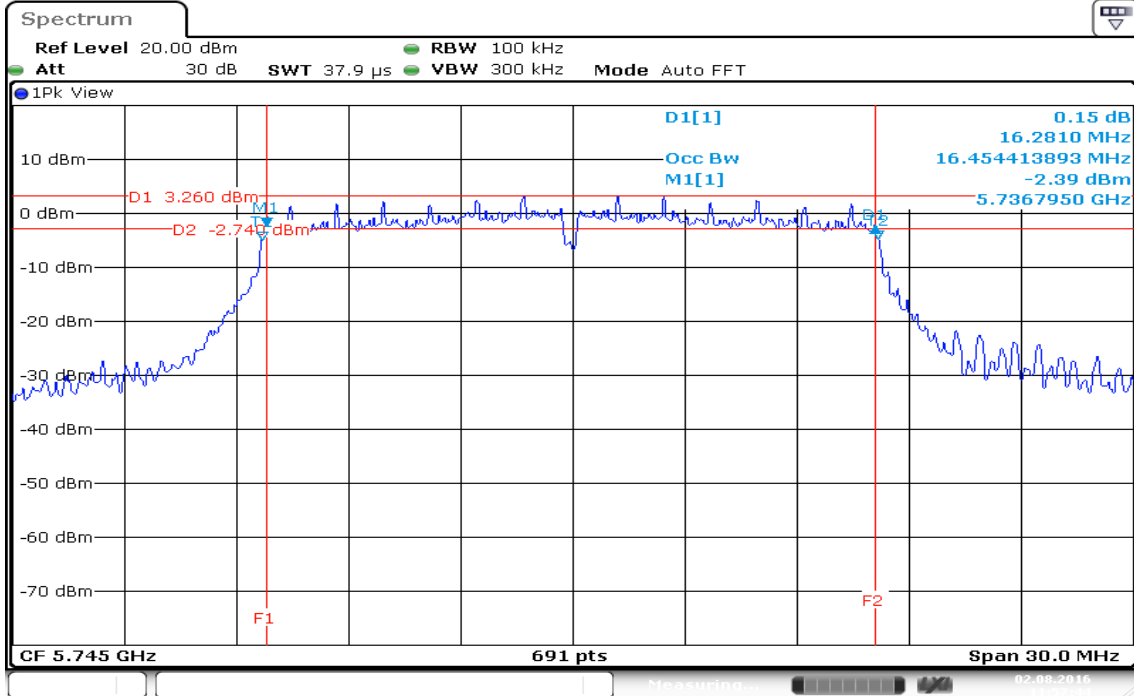

99% Bandwidth (CH Mid)

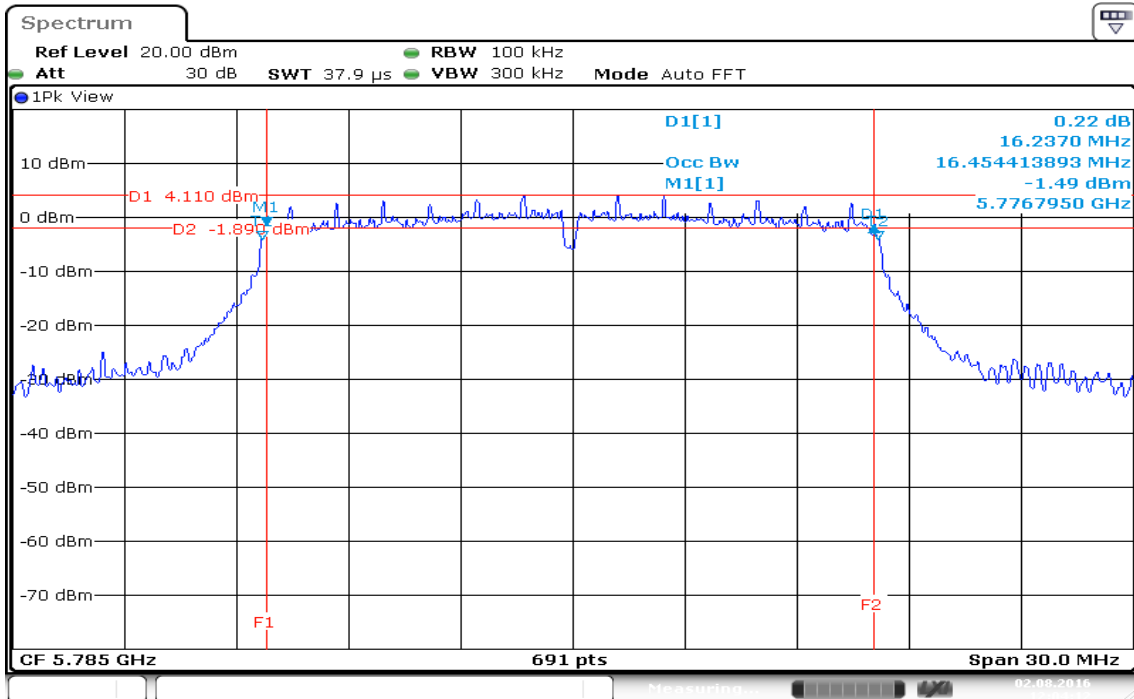

99% Bandwidth (CH High)

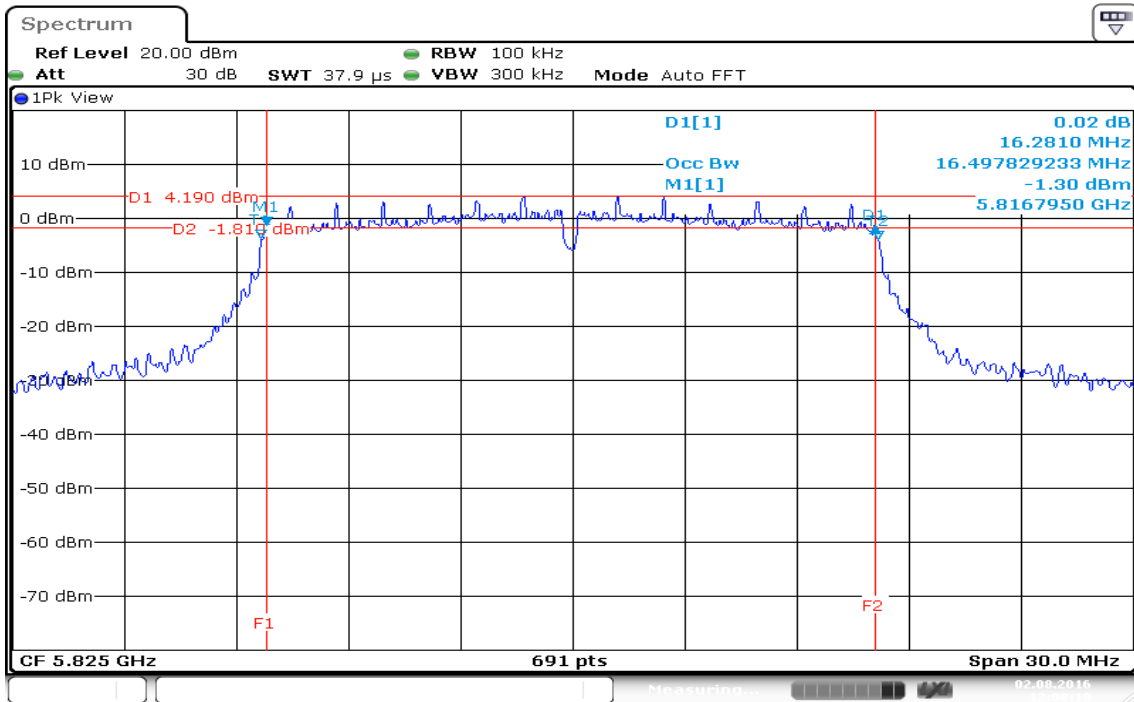

Date: 2.AUG.2016 12:08:18

IEEE 802.11n HT 20 MHz mode / 5745 ~ 5825MHz / Chain 0

99% Bandwidth (CH Low)

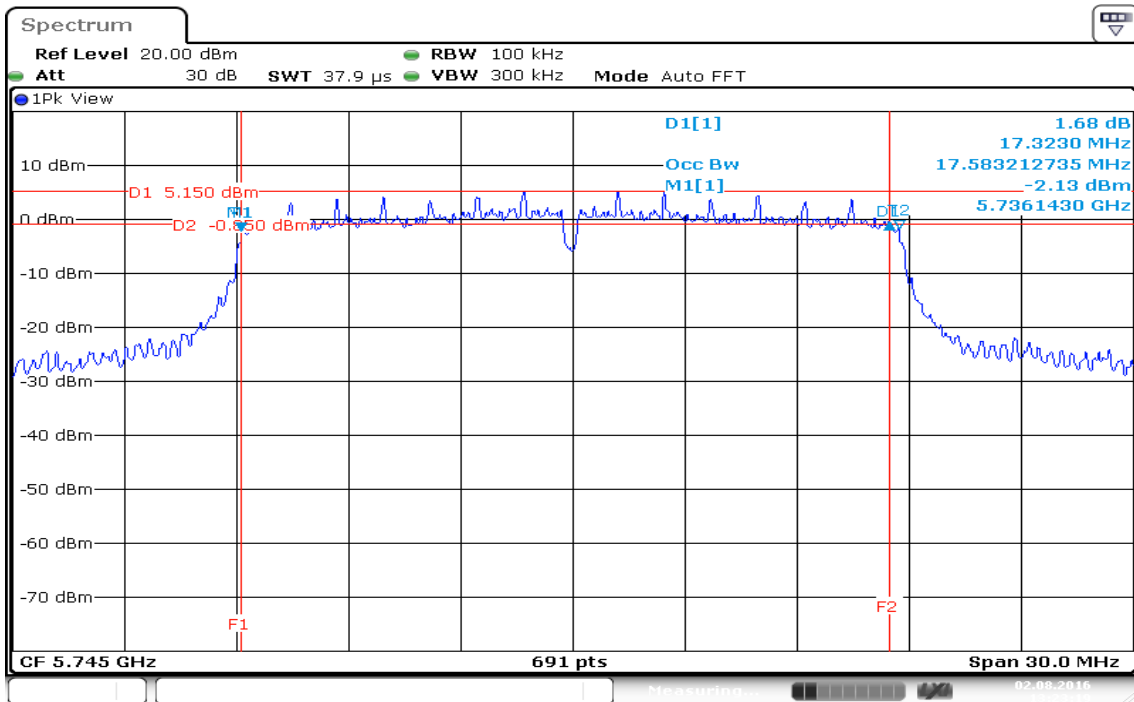

99% Bandwidth (CH Mid)

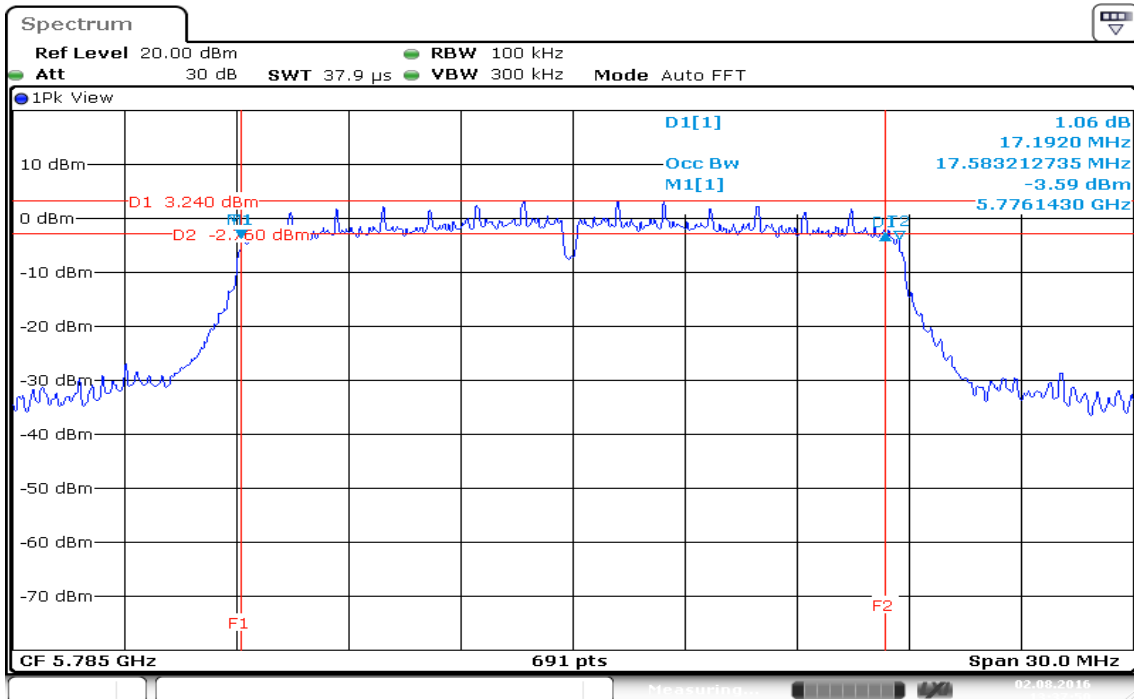

99% Bandwidth (CH High)

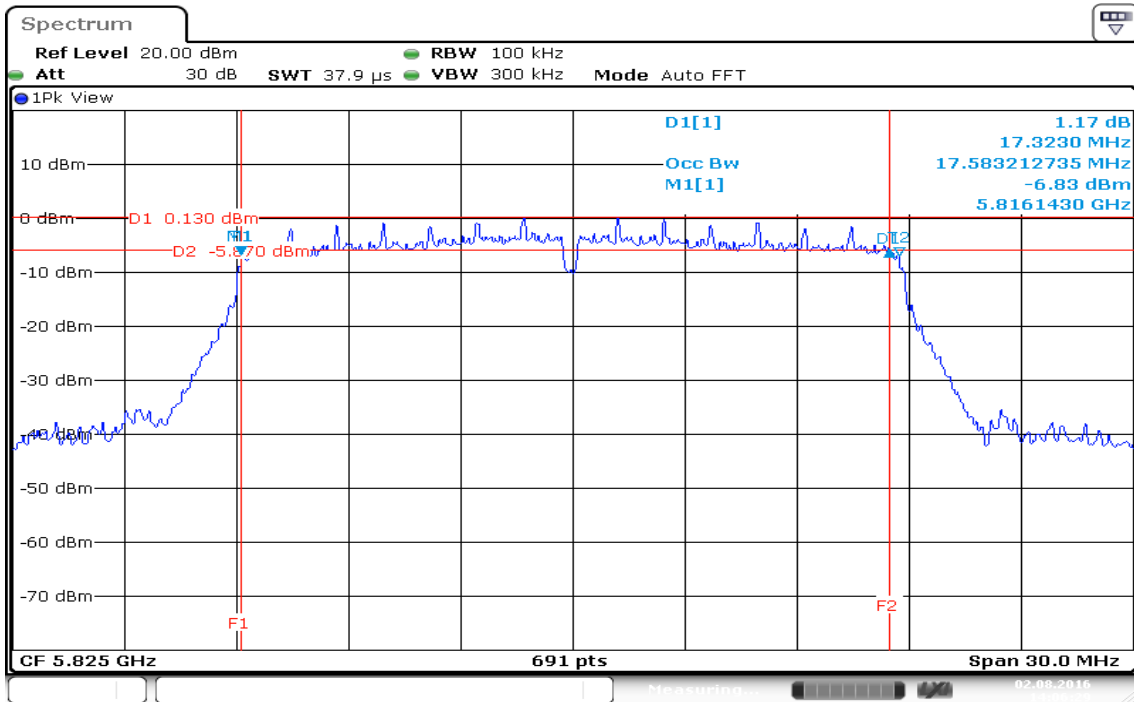

Date: 2.AUG.2016 14:06:30

IEEE 802.11n HT 20 MHz mode / 5745 ~ 5825MHz / Chain 1

99% Bandwidth (CH Low)

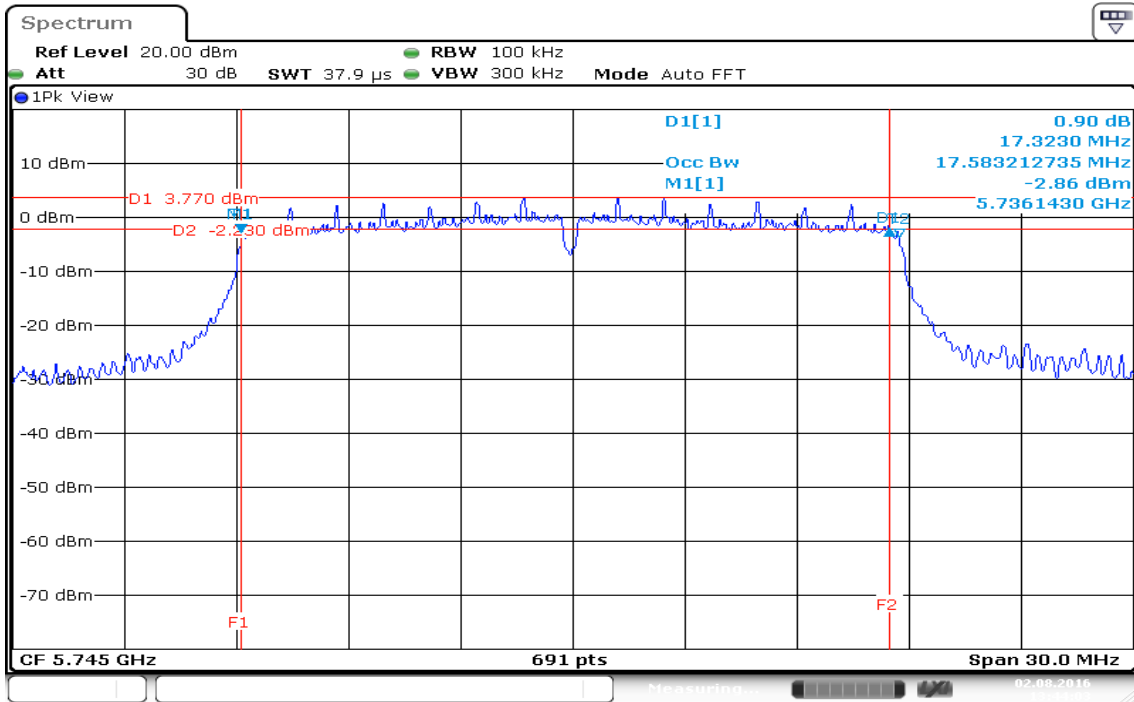

99% Bandwidth (CH Mid)

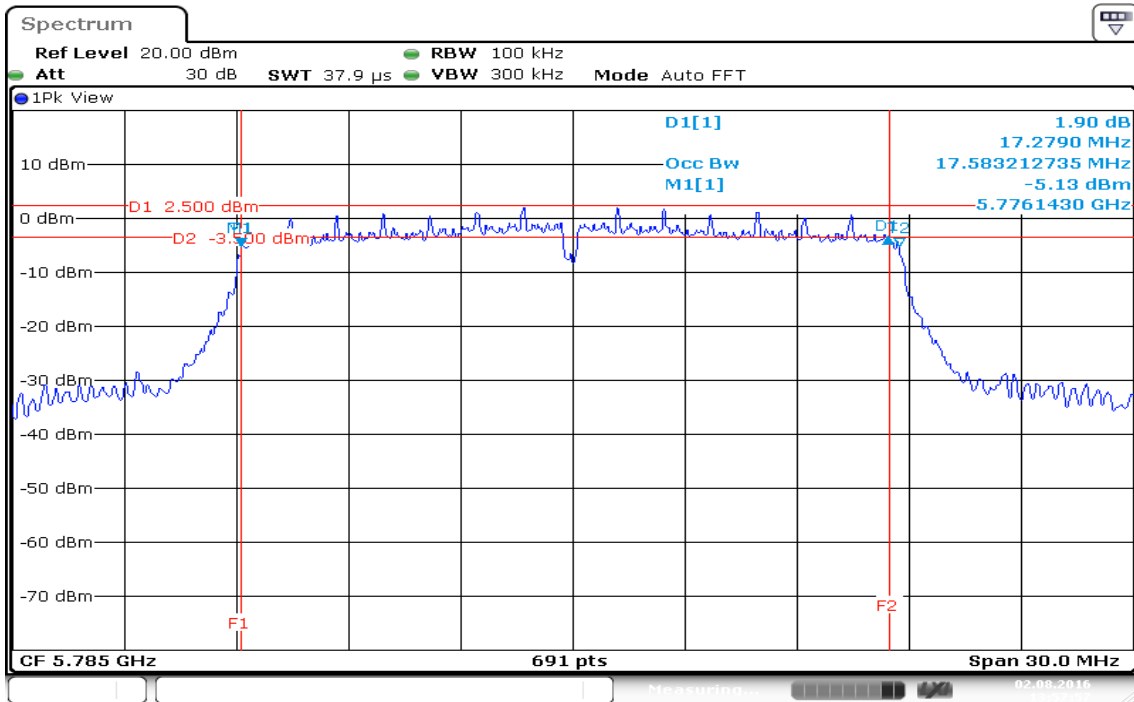

99% Bandwidth (CH High)

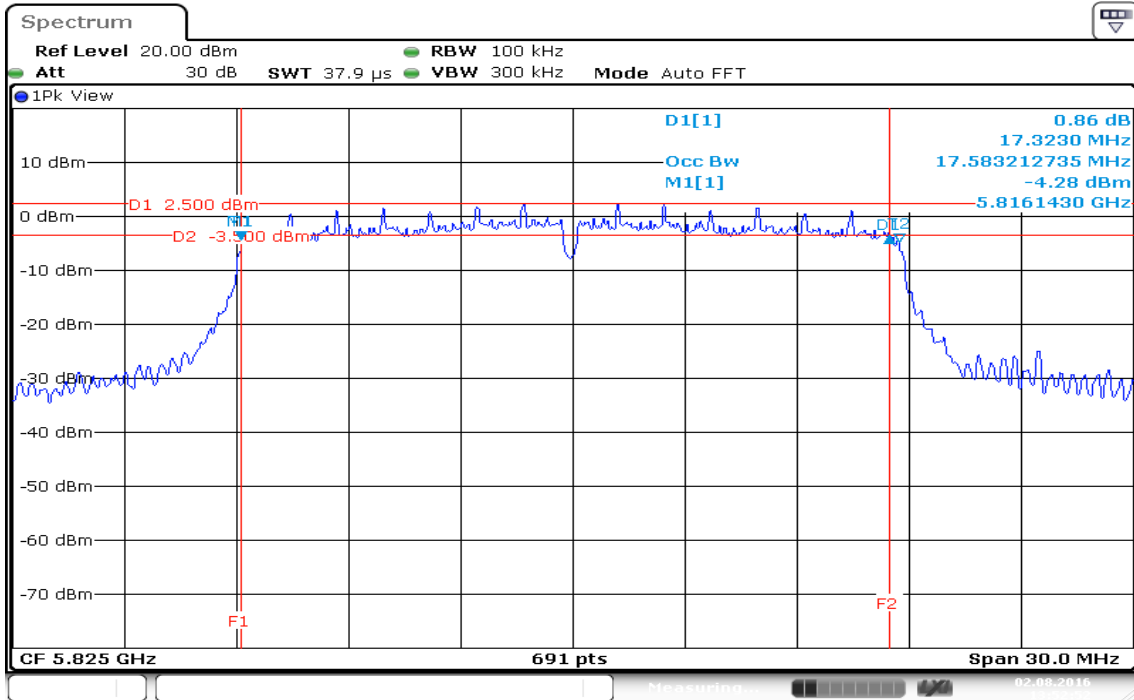

IEEE 802.11n HT 40 MHz mode / 5755 ~ 5795MHz / Chain 0

99% Bandwidth (CH Low)

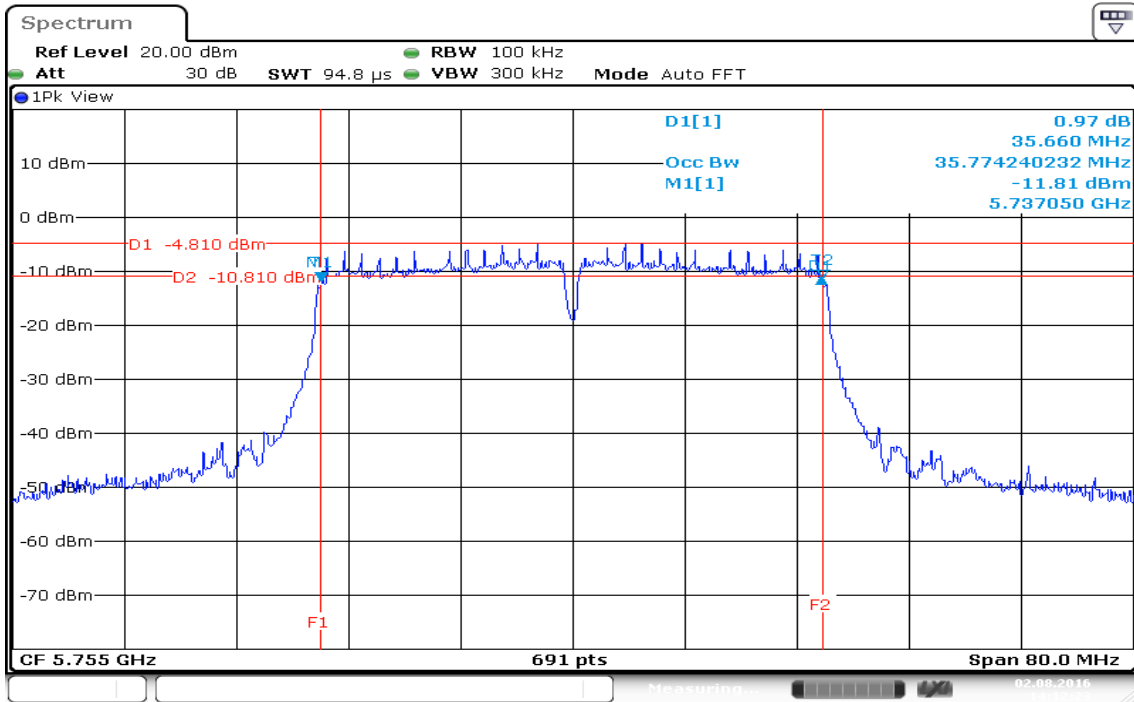

99% Bandwidth (CH High)

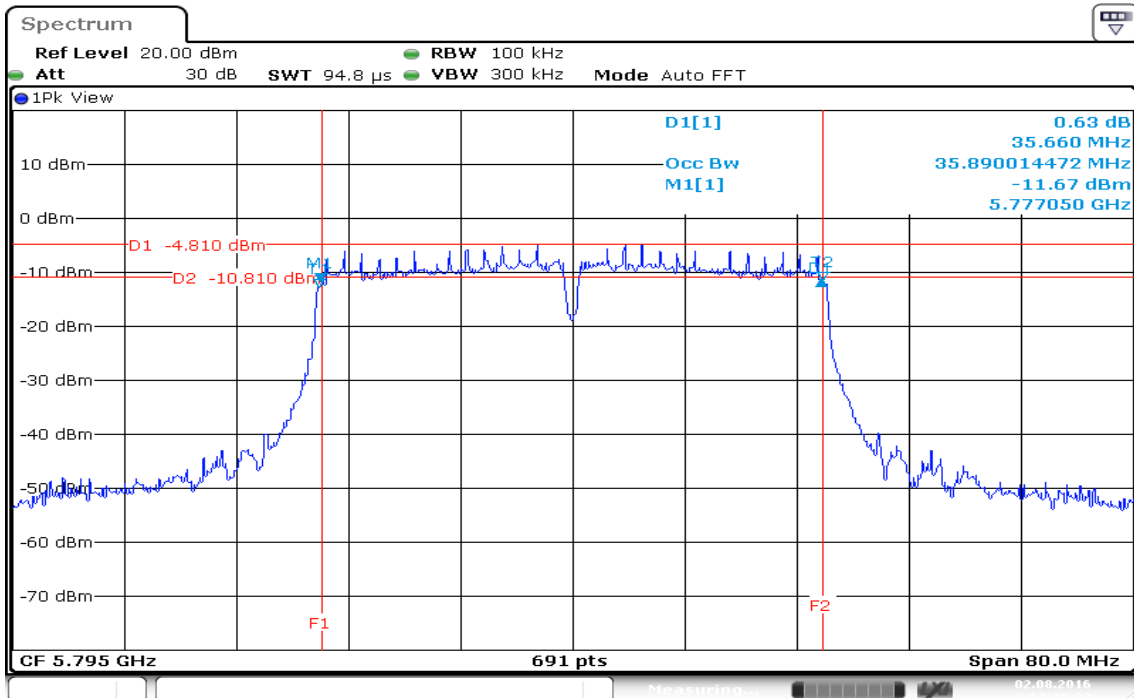

IEEE 802.11n HT 40 MHz mode / 5755 ~ 5795MHz / Chain 1

99% Bandwidth (CH Low)

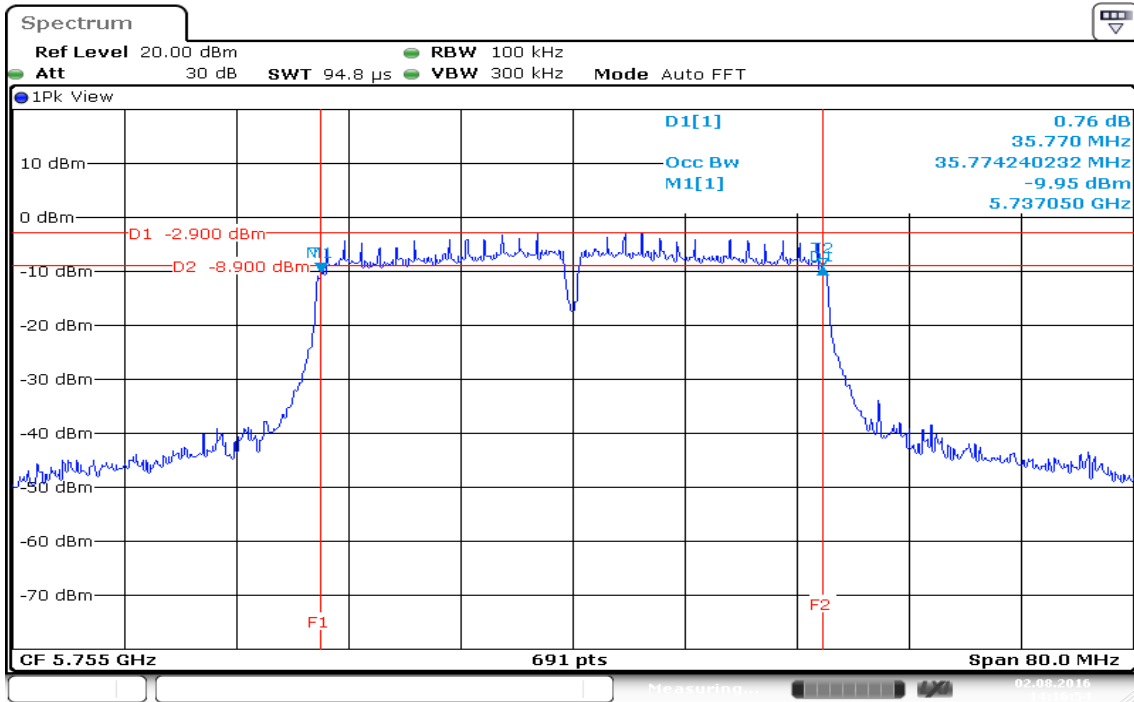

99% Bandwidth (CH High)

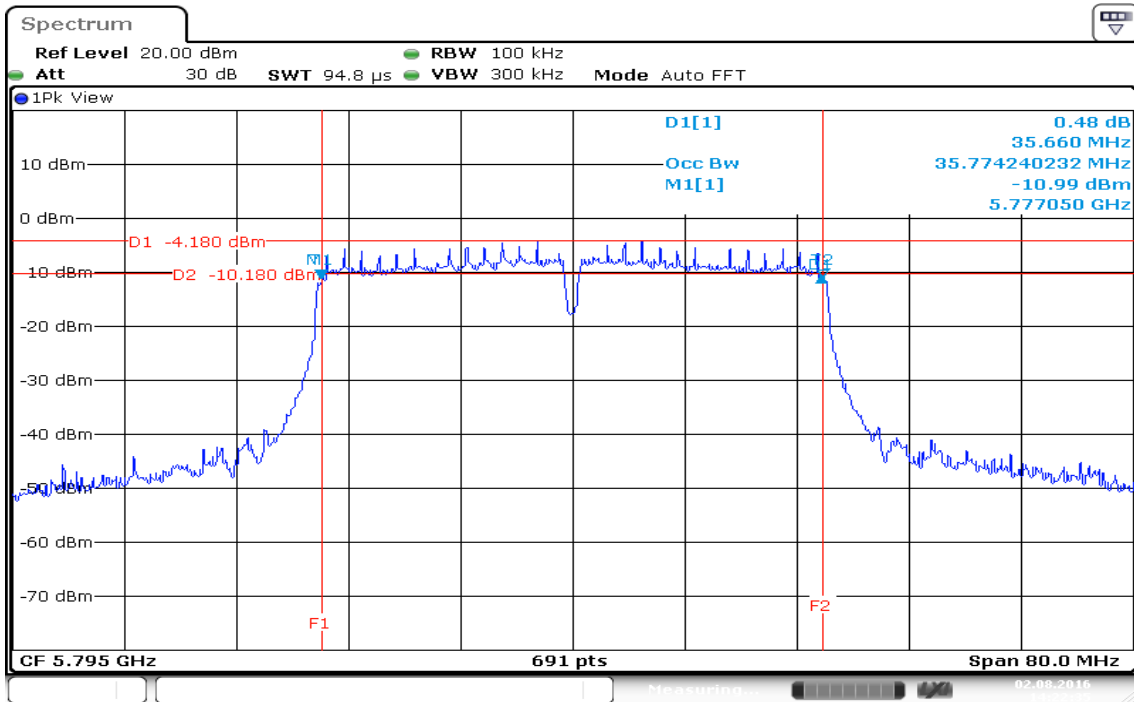

7.2 6DB BANDWIDTH

LIMIT

According to §15.407 & RSS-247§, systems using digital modulation techniques may operate in the 902 - 928 MHz, 2400 - 2483.5 MHz, and 5725 - 5850 MHz bands. The minimum 6dB bandwidth shall be at least 500 kHz.

Test Configuration

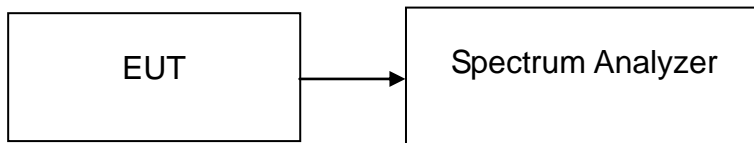

TEST PROCEDURE

1. Place the EUT on the table and set it in the transmitting mode.
2. Remove the antenna from the EUT and then connect a low loss RF cable from the antenna port to the spectrum analyzer.
3. Set the spectrum analyzer as RBW = VBW = 100kHz, Span = 50MHz, Sweep = auto.
4. Mark the peak frequency and -6dB (upper and lower) frequency.
5. Repeat until all the rest channels are investigated.

TEST RESULTS

No non-compliance noted

Test Data

Test mode: IEEE 802.11a mode

Channel	Frequency (MHz)	6dB Bandwidth (MHz)	Limit (kHz)	Result
Low	5745	16.2810	>500	PASS
Mid	5785	16.2370		PASS
High	5825	16.2810		PASS

Test mode: IEEE 802.11n HT 20 MHz mode / Chain 0

Channel	Frequency (MHz)	6dB Bandwidth (MHz)	Limit (kHz)	Result
Low	5745	17.3230	>500	PASS
Mid	5785	17.1920		PASS
High	5825	17.3230		PASS

Test mode: IEEE 802.11n HT 20 MHz mode / Chain 1

Channel	Frequency (MHz)	6dB Bandwidth (MHz)	Limit (kHz)	Result
Low	5745	17.3230	>500	PASS
Mid	5785	17.2790		PASS
High	5825	17.3230		PASS

Test mode: IEEE 802.11n HT 40 MHz mode / Chain 0

Channel	Frequency (MHz)	6dB Bandwidth (MHz)	Limit (kHz)	Result
Low	5755	35.6600	>500	PASS
High	5795	35.6600		PASS

Test mode: IEEE 802.11n HT 40 MHz mode / Chain 1

Channel	Frequency (MHz)	6dB Bandwidth (MHz)	Limit (kHz)	Result
Low	5755	35.7700	>500	PASS
High	5795	35.6600		PASS

Test Plot

IEEE 802.11a mode / 5745 ~ 5825MHz

6dB Bandwidth (CH Low)

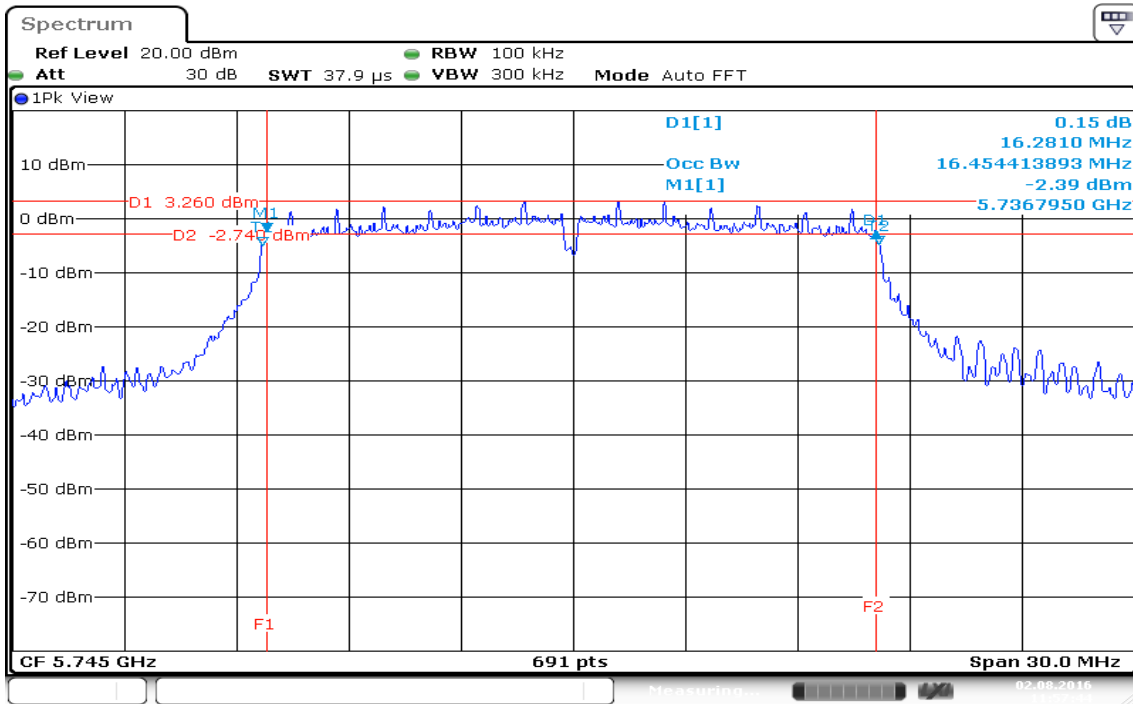

6dB Bandwidth (CH Mid)

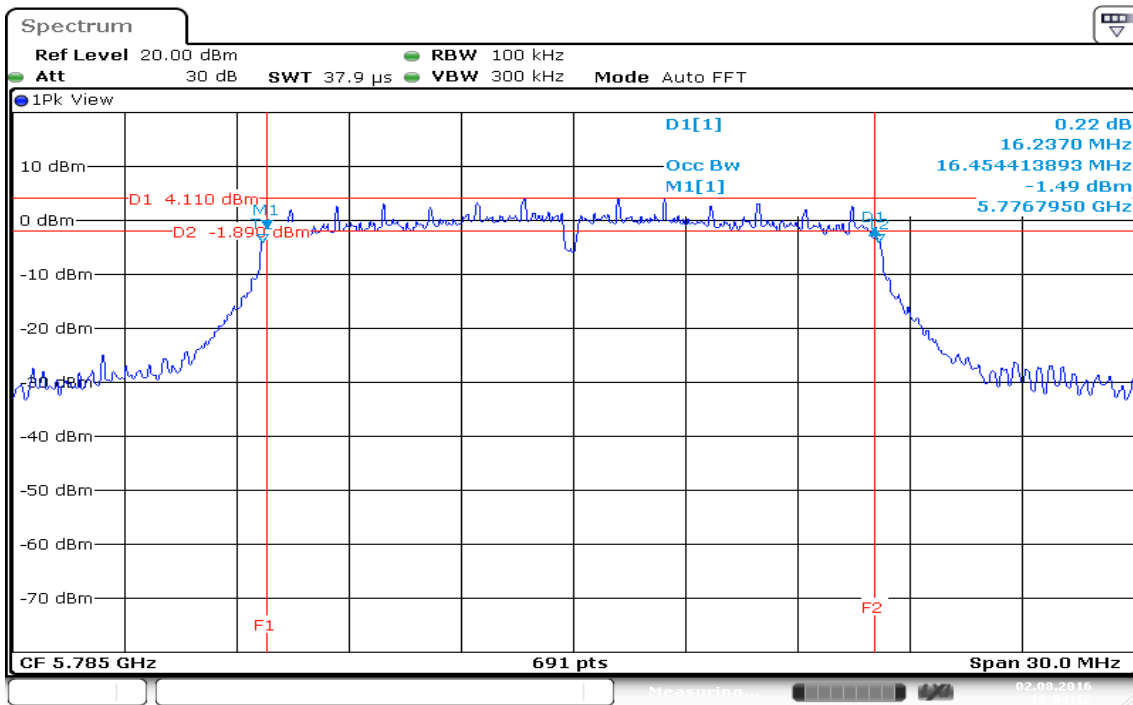

6dB Bandwidth (CH High)

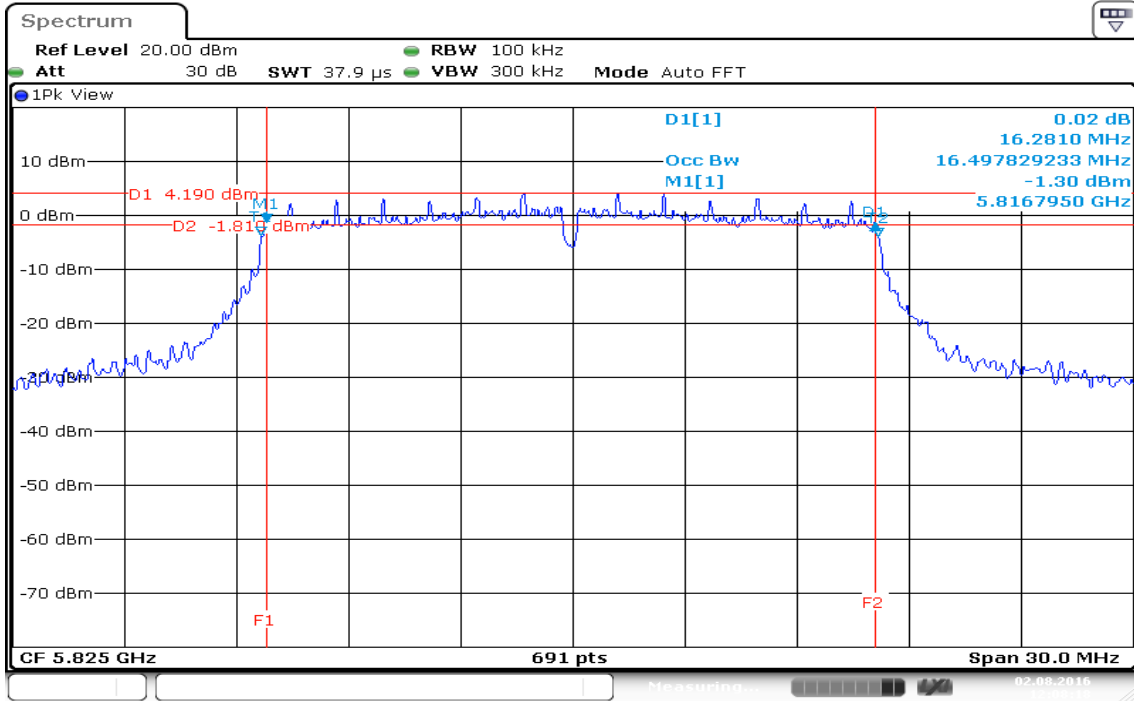

IEEE 802.11n HT 20 MHz mode / 5745 ~ 5825MHz / Chain 0

6dB Bandwidth (CH Low)

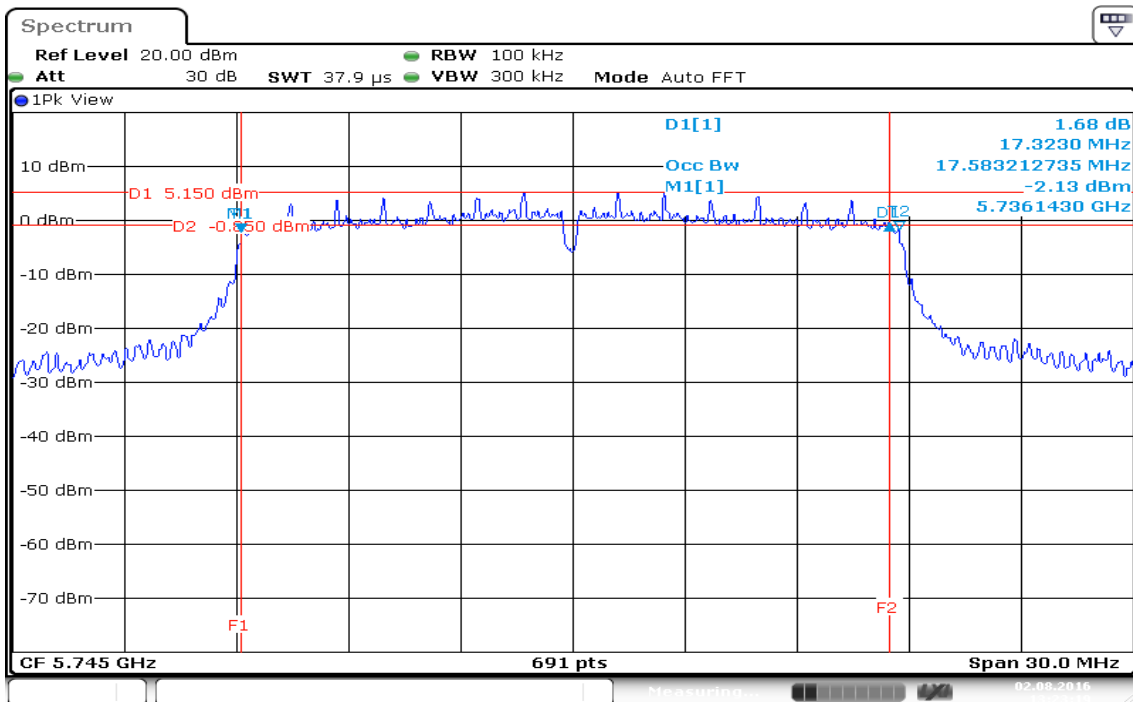

6dB Bandwidth (CH Mid)

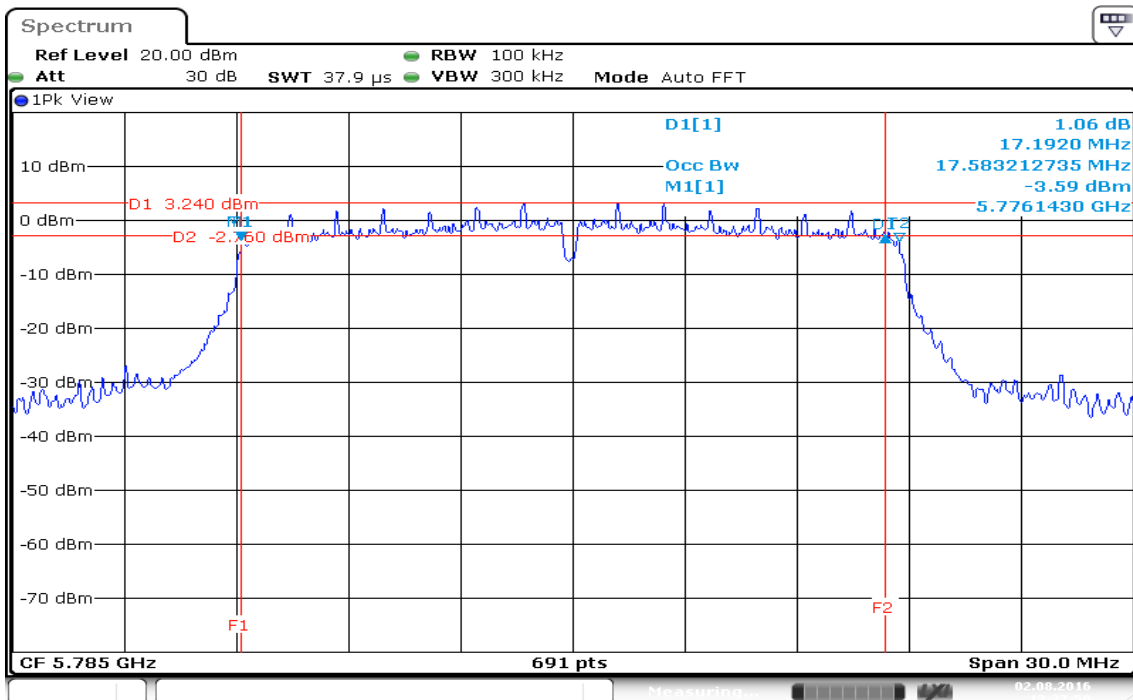

6dB Bandwidth (CH High)

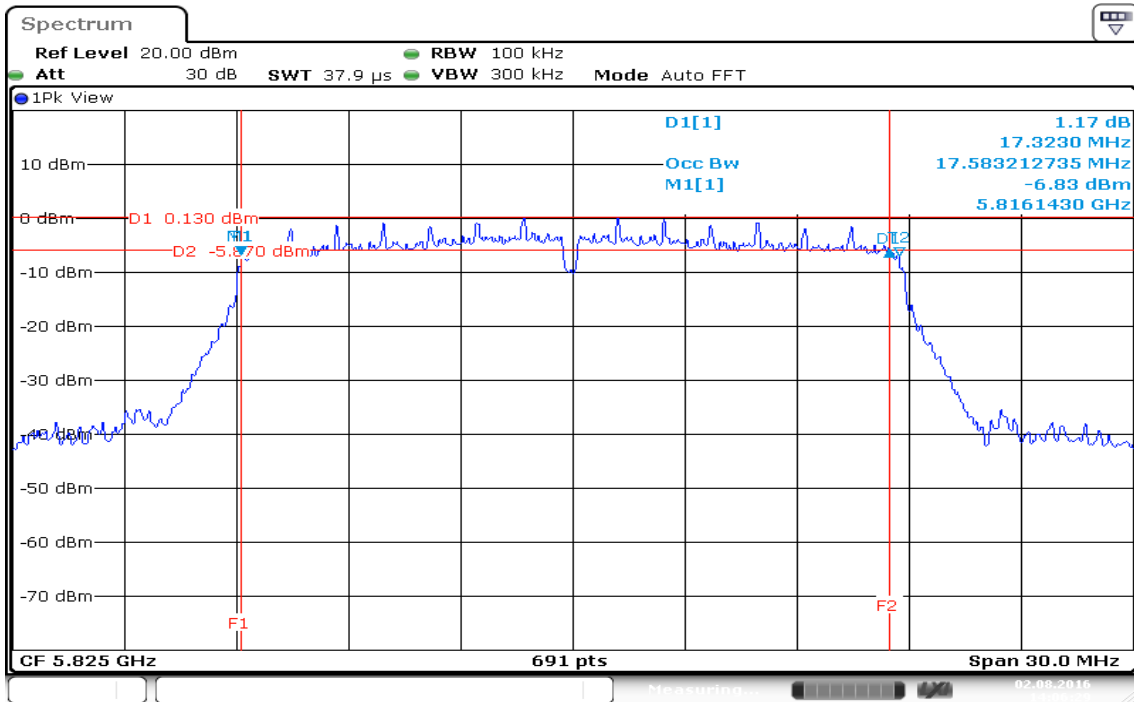

Date: 2.AUG.2016 14:06:30

IEEE 802.11n HT 20 MHz mode / 5745 ~ 5825MHz / Chain 1

6dB Bandwidth (CH Low)

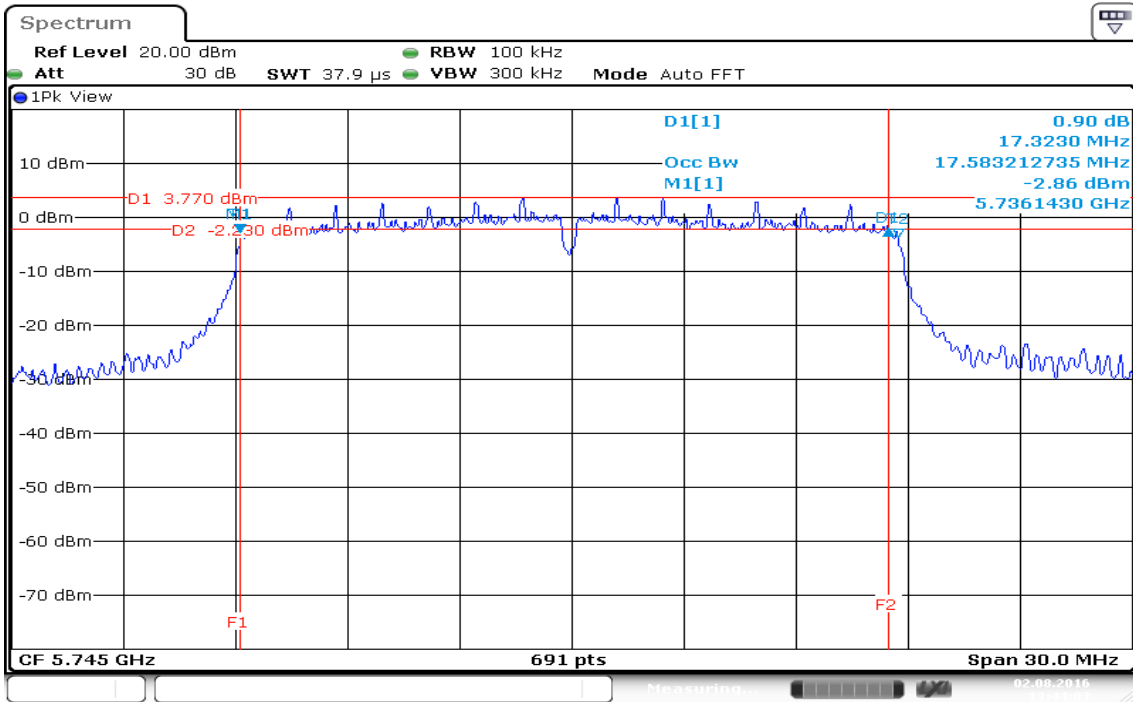

6dB Bandwidth (CH Mid)

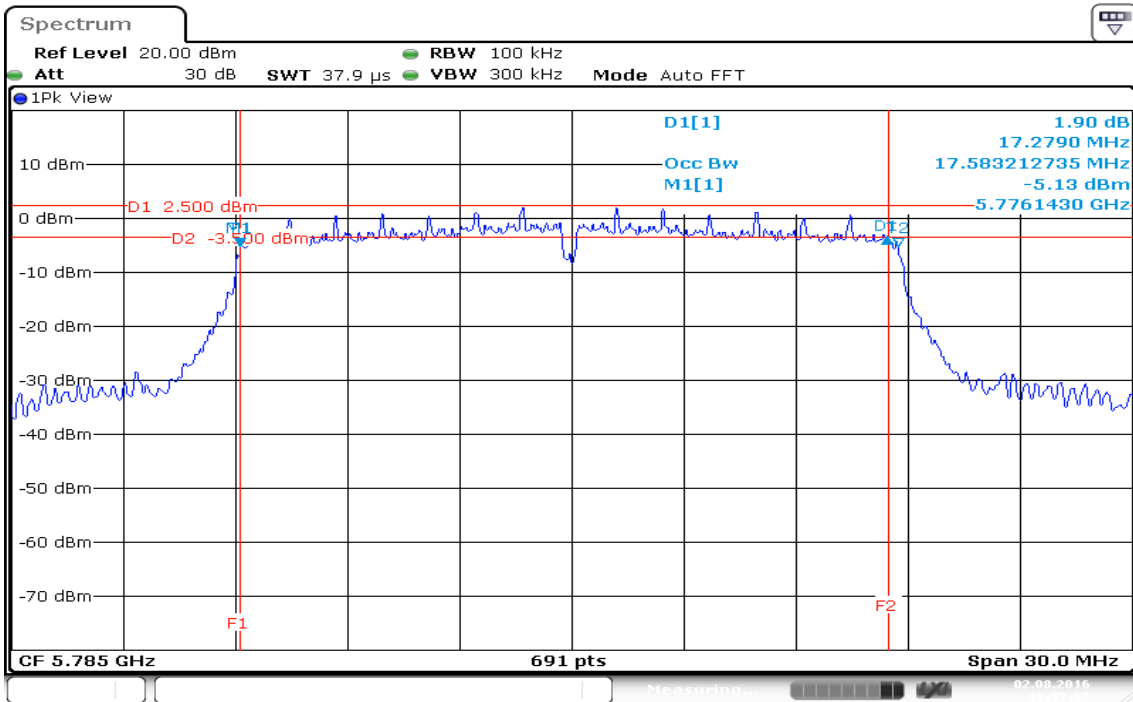

6dB Bandwidth (CH High)

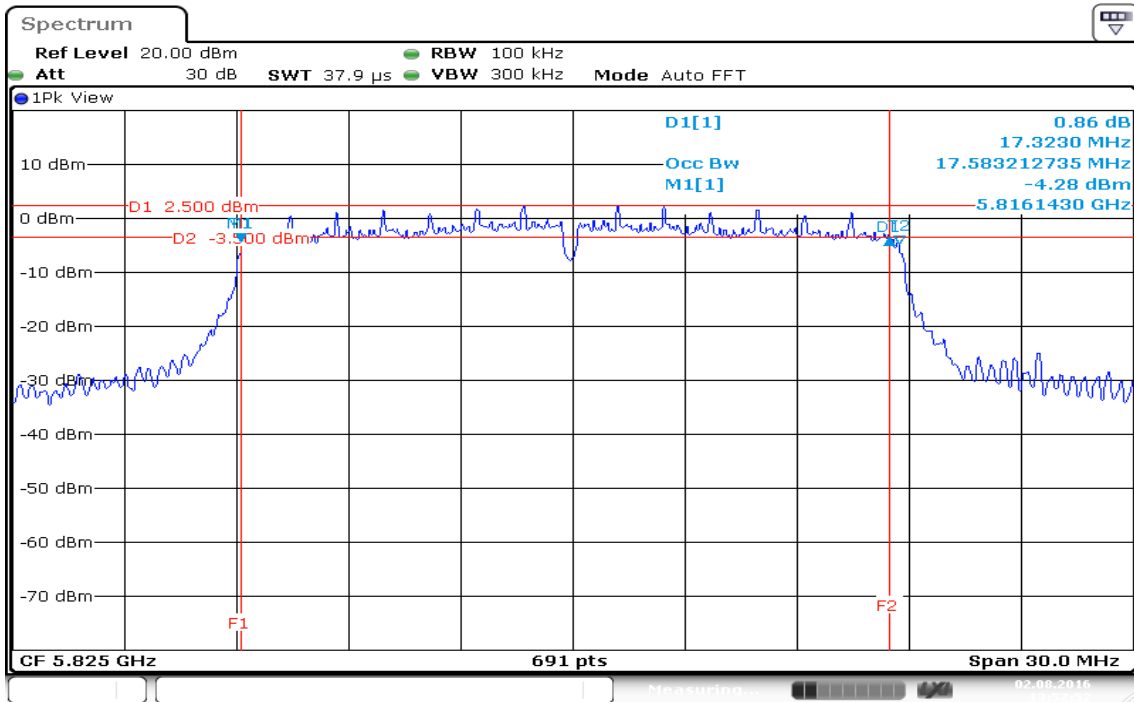

Date: 2.AUG.2016 13:52:52

IEEE 802.11n HT 40 MHz mode / 5755 ~ 5795MHz / Chain 0

6dB Bandwidth (CH Low)

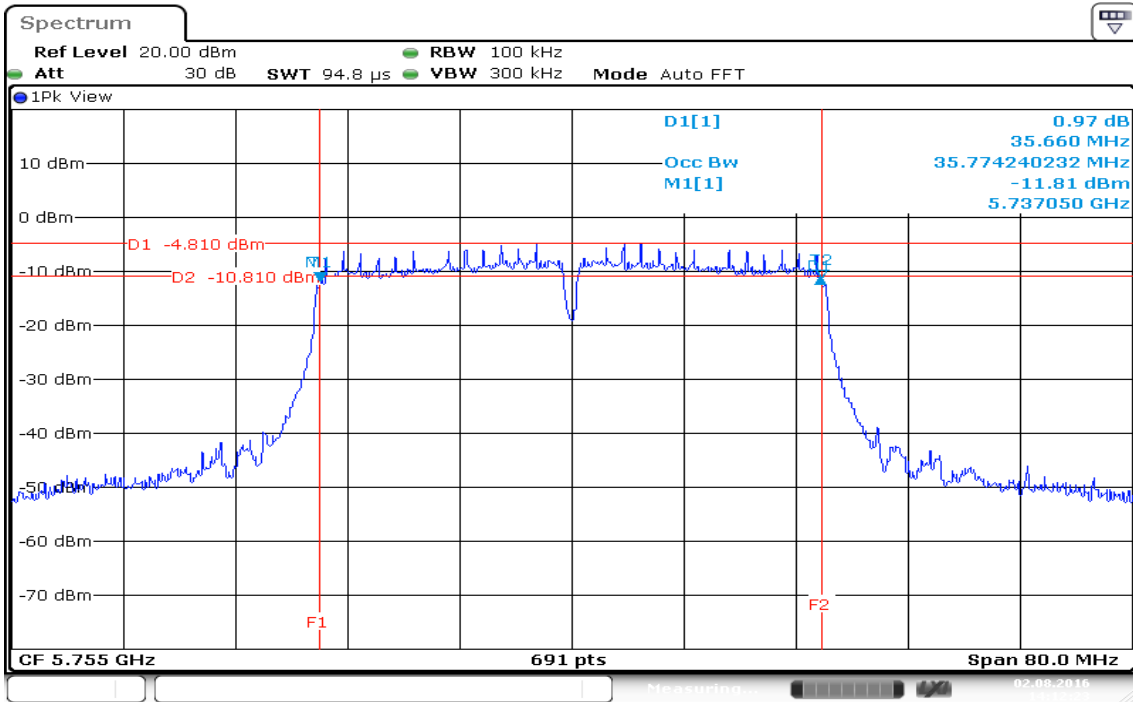

6dB Bandwidth (CH High)

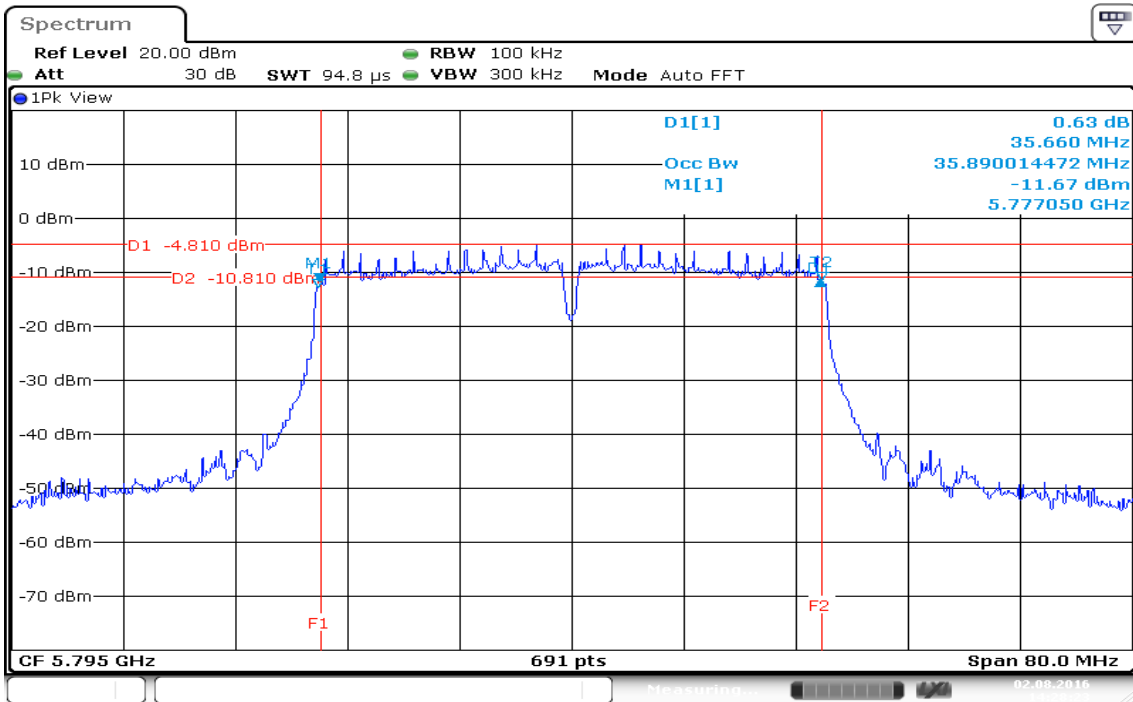

IEEE 802.11n HT 40 MHz mode / 5755 ~ 5795MHz / Chain 1

6dB Bandwidth (CH Low)

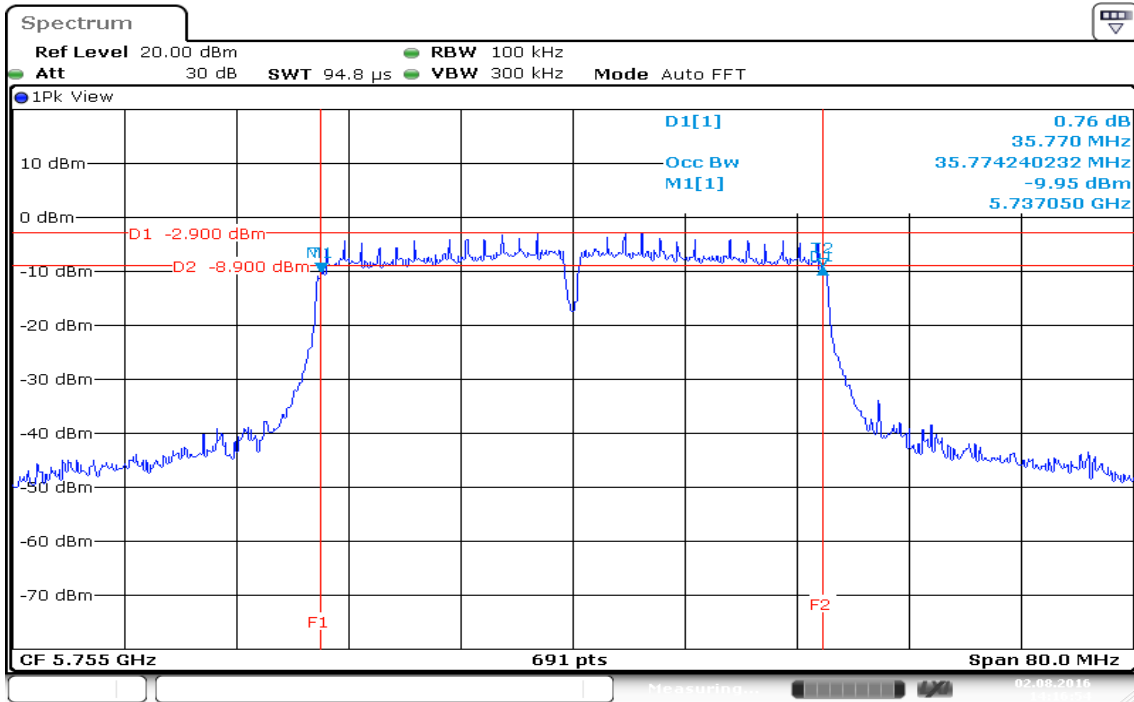

6dB Bandwidth (CH High)

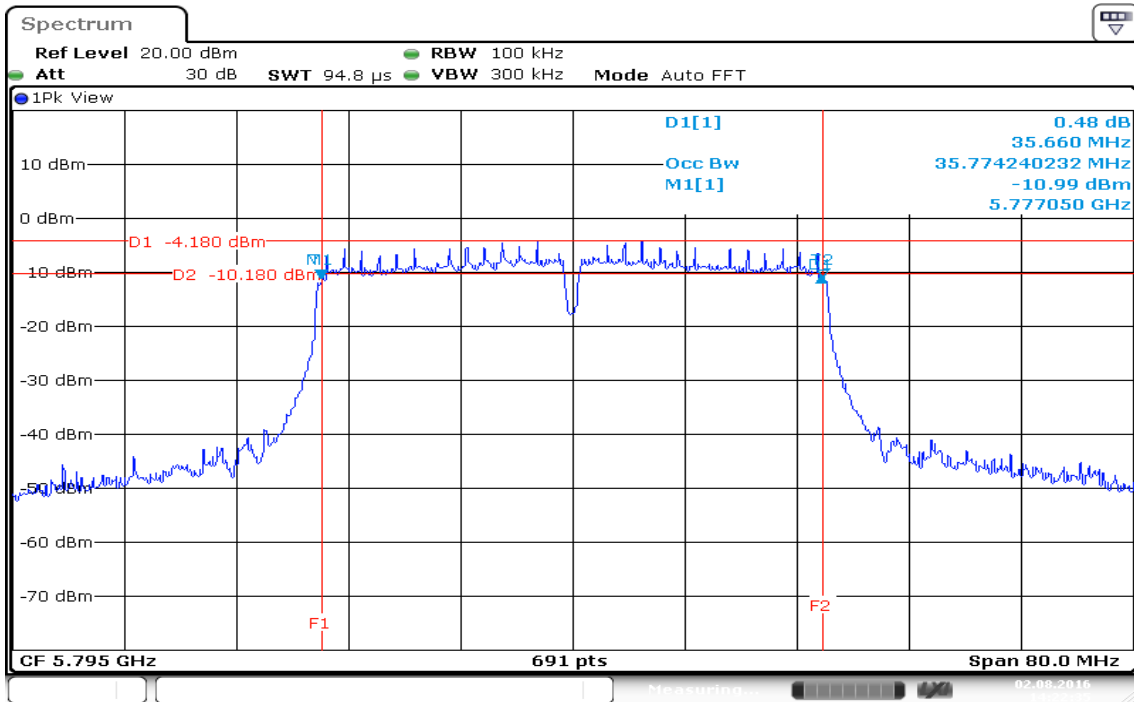

7.3 MAXIMUM CONDUCTED OUTPUT POWER

LIMIT

The maximum peak output power of the intentional radiator shall not exceed the following:

1. According to §15.407, for systems using digital modulation in the bands of 902-928 MHz, 2400-2483.5 MHz, and 5725-5850 MHz: 1 Watt.
2. According to RSS-247 §, for systems employing digital modulation techniques operating in the bands 902-928 MHz, 2400-2483.5 MHz and 5725-5850 MHz, the maximum peak conducted output power shall not exceed 1 W.

Test Configuration

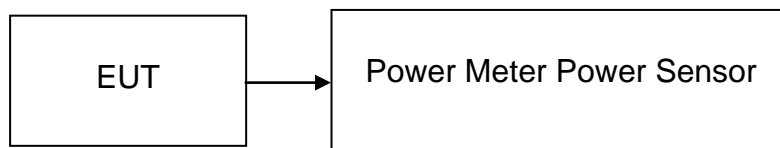

TEST PROCEDURE

The transmitter output is connected to the Power Meter. The Power Meter is set to the peak power detection.

TEST RESULTS

No non-compliance noted

Test Data

Test mode: IEEE 802.11a mode / 5745 ~ 5825MHz

Channel	Frequency (MHz)	Output Power (dBm)	Output Power (W)	Limit (dBm)
Low	5745	*13.23	0.0210	30.00
Mid	5785	13.12	0.0205	30.00
High	5825	13.11	0.0205	30.00

Test mode: IEEE 802.11n HT 20 MHz mode / 5745 ~ 5825MHz

Channel	Frequency (MHz)	Chain 0 Output Power (dBm)	Chain 1 Output Power (dBm)	Output Power (dBm)	Output Power (W)	Limit (dBm)
Low	5745	14.94	15.54	18.26	0.0670	30
Mid	5785	15.49	15.45	*18.48	0.0705	30
High	5825	15.25	15.41	18.34	0.0682	30

Test mode: IEEE 802.11n HT 40 MHz mode / 5755 ~ 5795MHz

Channel	Frequency (MHz)	Chain 0 Output Power (dBm)	Chain 1 Output Power (dBm)	Output Power (dBm)	Output Power (W)	Limit (dBm)
Low	5755	13.36	13.75	*16.57	0.0454	30
High	5795	13.53	13.45	16.50	0.0447	30

Remark:

1. Total Output Power (w) = Chain 0 (10^(Output Power /10)/1000)+ Chain 1 (10^(Output Power /10)/1000)

7.4 BAND EDGES MEASUREMENT

LIMIT

According to §15.407 & RSS-247 §, in any 100 kHz bandwidth outside the frequency bands in which the spread spectrum intentional radiator is operating, the radio frequency power that is produced by the intentional radiator shall be at least 20 dB below that in the 100 kHz bandwidth within the band that contains the highest level of the desired power, based on either an RF conducted or a radiated measurement, provided the transmitter demonstrates compliance with the peak conducted power limits. In addition, radiated emissions which fall in the restricted bands, as defined in §15.205(a), must also comply with the radiated emission limits specified in 15.209(a) (see Section 15.205(c)).

Test Configuration

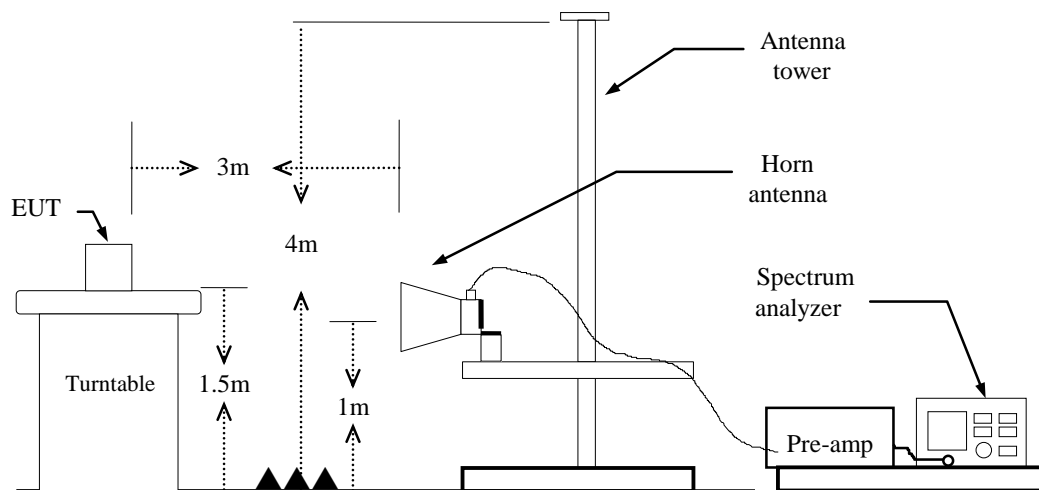

TEST PROCEDURE

1. The EUT is placed on a turntable, which is 1.5m above the ground plane.
2. The turntable shall be rotated for 360 degrees to determine the position of maximum emission level.
3. EUT is set 3m away from the receiving antenna, which is varied from 1m to 4m to find out the highest emission.
4. Set the spectrum analyzer in the following setting in order to capture the lower and upper band-edges of the emission:
 - (a) PEAK: RBW=VBW=1MHz / Sweep=AUTO
 - (b) AVERAGE: RBW=1MHz,
if duty cycle $\geq 98\%$, VBW=10Hz.
if duty cycle $< 98\%$ VBW=1/T.
IEEE 802.11a mode: =89%, VBW=750Hz
IEEE 802.11n HT 20 MHz mode: =88%, VBW=750Hz
IEEE 802.11n HT 40 MHz mode: =80%, VBW=1.5KHz
5. Repeat the procedures until all the PEAK and AVERAGE versus POLARIZATION are measured.
6. Result = Spectrum Reading + cable loss(spectrum to Amp) - Amp Gain + Cable loss(Amp to receive Ant)+ Receive Ant

For Un-restricted Band Emissions

The peak output power procedure is used to measure the fundamental emission power to demonstrate compliance to requirements, then the peak conducted output power measured within any 100 kHz outside the authorized frequency band shall be attenuated by at least 20 dB relative to the maximum measured in-band peak PSD level.

TEST RESULTS

Refer to attach spectrum analyzer data chart.

IEEE 802.11a Mode / CH Low

Detector mode: Peak

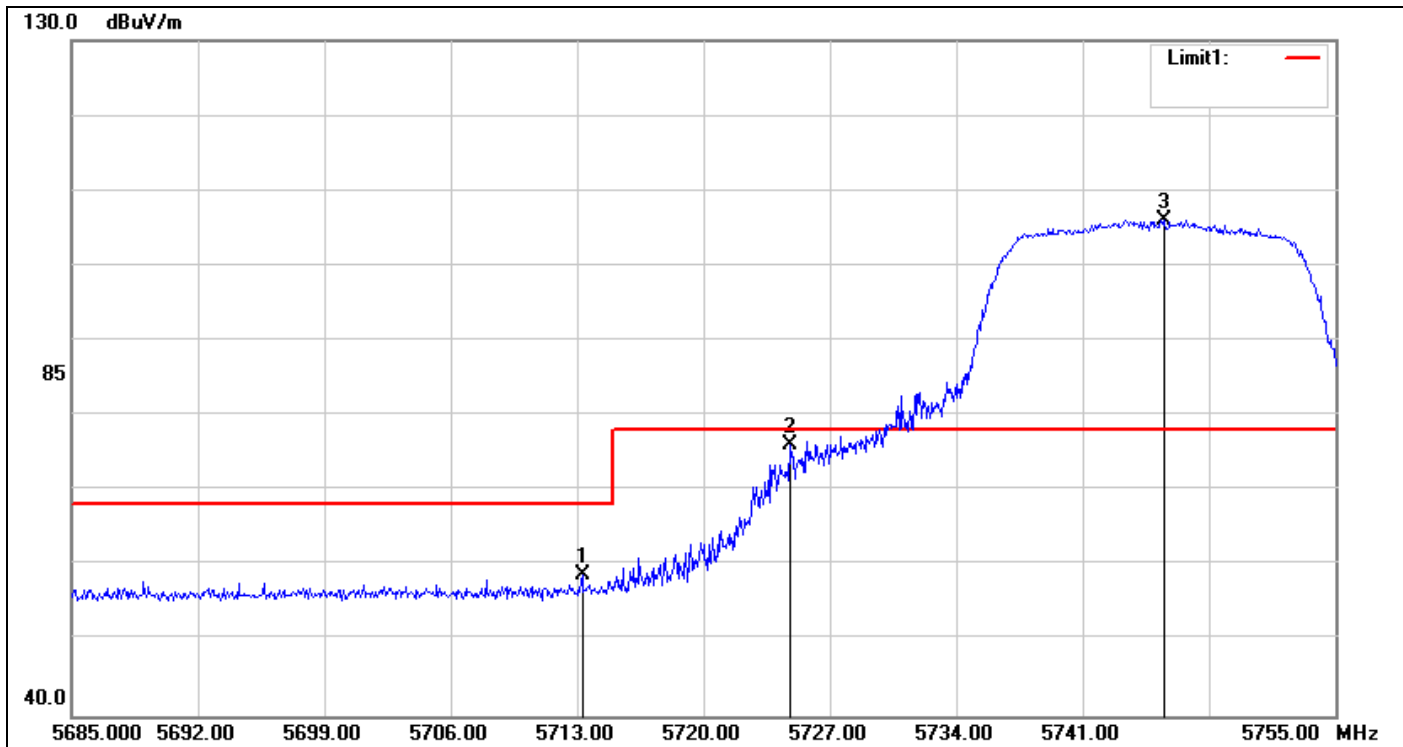

No.	Frequency (MHz)	Reading (dBuV)	Correct Factor(dB/m)	Result (dBuV/m)	Limit (dBuV/m)	Margin (dB)	Remark
1	5713.280	52.71	6.16	58.87	68.20	-9.33	peak
2	5724.760	69.89	6.21	76.10	78.20	-2.10	peak
3	5745.480	99.80	6.30	106.10	-	-	peak

Detector mode: Average

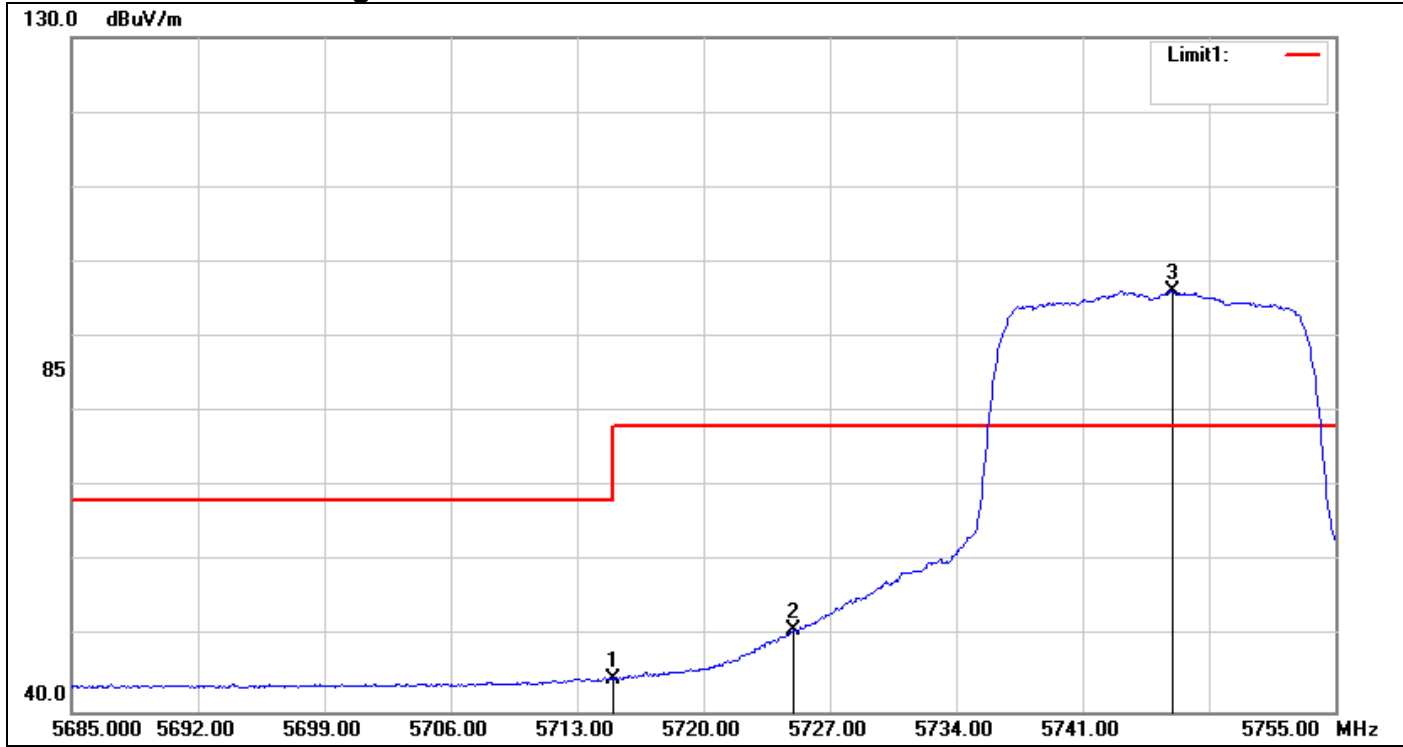

No.	Frequency (MHz)	Reading (dBuV)	Correct Factor(dB/m)	Result (dBuV/m)	Limit (dBuV/m)	Margin (dB)	Remark
1	5715.000	38.27	6.17	44.44	68.20	-23.76	AVG
2	5725.000	44.63	6.21	50.84	78.20	-27.36	AVG
3	5745.970	89.86	6.30	96.16	-	-	AVG

IEEE 802.11a Mode / CH Mid

Detector mode: Peak

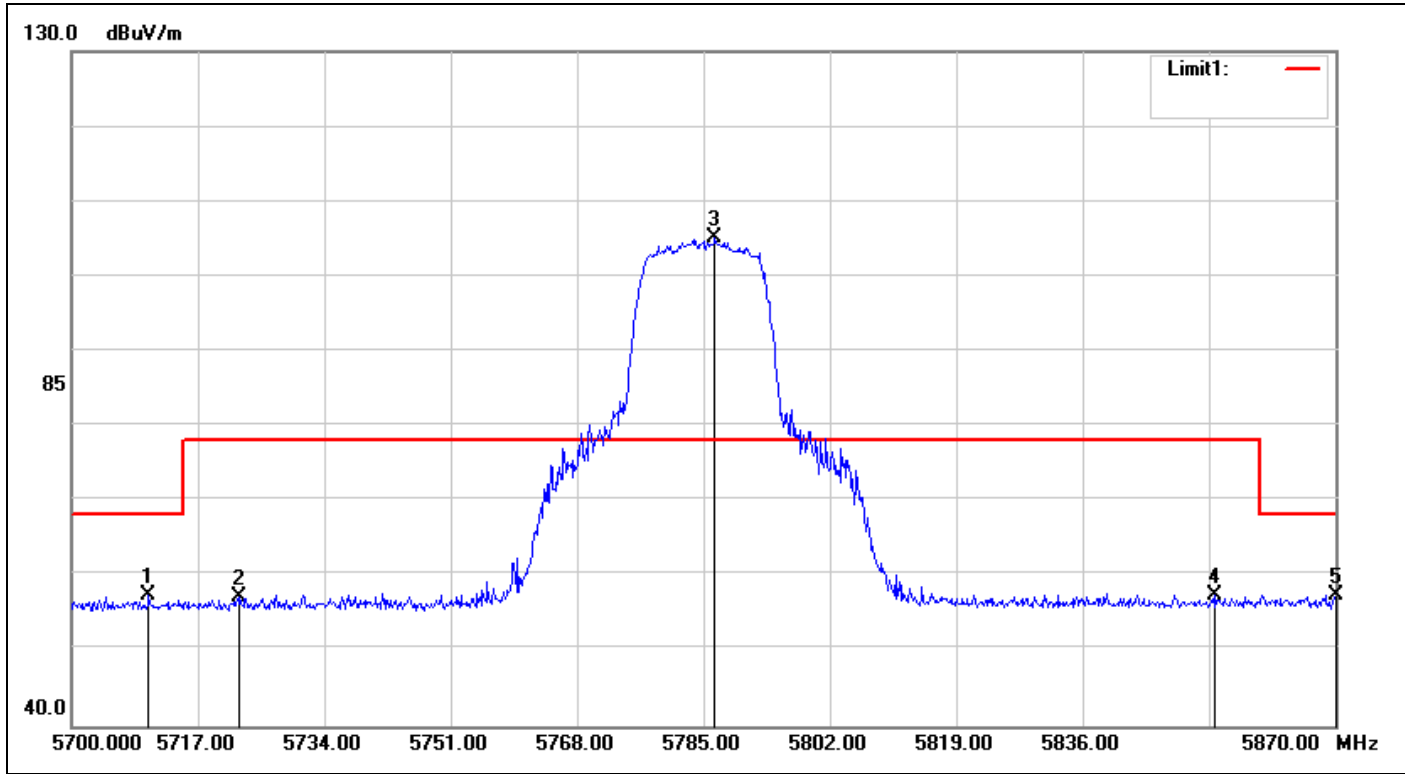

No.	Frequency (MHz)	Reading (dBuV)	Correct Factor(dB/m)	Result (dBuV/m)	Limit (dBuV/m)	Margin (dB)	Remark
1	5710.370	51.26	6.15	57.41	68.20	-10.79	peak
2	5722.610	51.01	6.20	57.21	78.20	-20.99	peak
3	5786.530	98.70	6.47	105.17	-	-	peak
4	5853.850	50.69	6.76	57.45	78.20	-20.75	peak
5	5870.000	50.57	6.83	57.40	68.20	-10.80	peak

Detector mode: Average

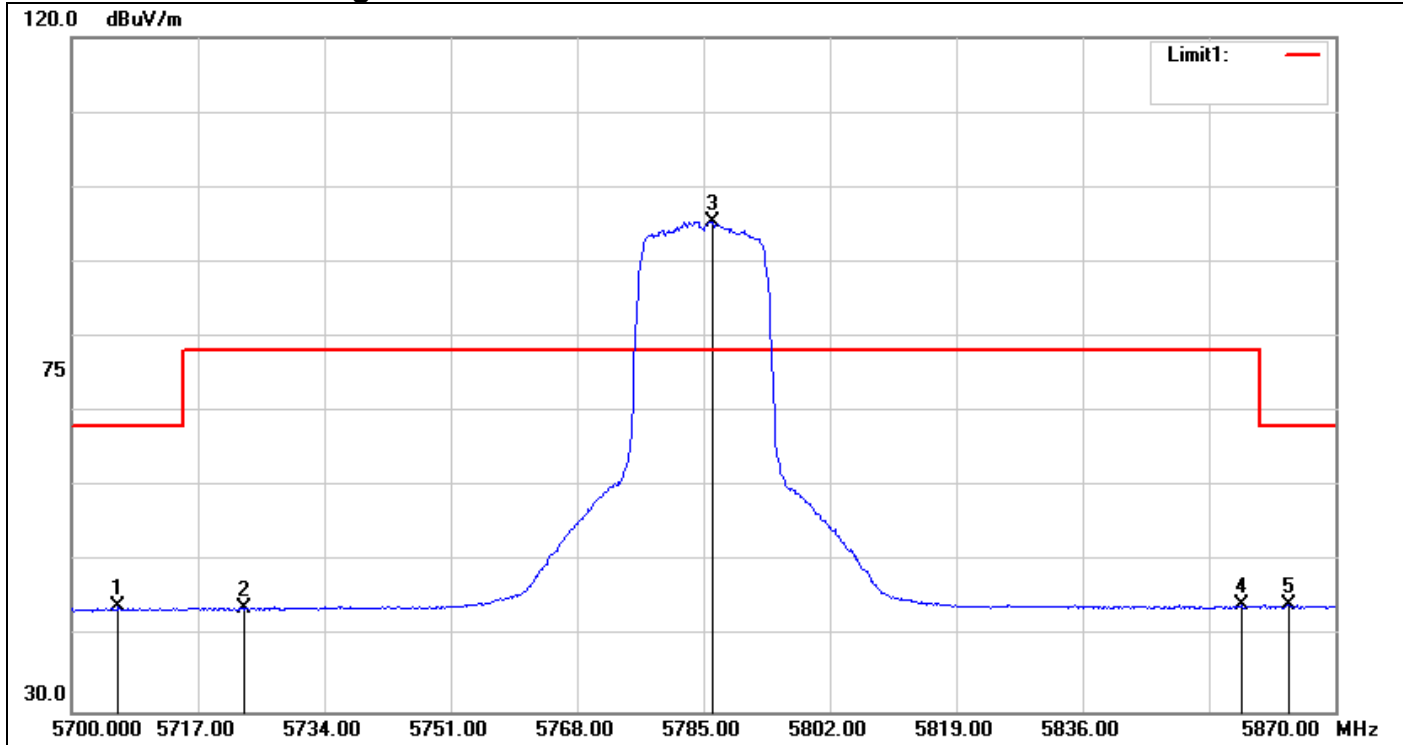

No.	Frequency (MHz)	Reading (dBuV)	Correct Factor(dB/m)	Result (dBuV/m)	Limit (dBuV/m)	Margin (dB)	Remark
1	5706.290	37.84	6.13	43.97	68.20	-24.23	AVG
2	5723.120	37.68	6.20	43.88	78.20	-34.32	AVG
3	5786.190	88.89	6.47	95.36	-	-	AVG
4	5857.420	37.41	6.77	44.18	78.20	-34.02	AVG
5	5863.710	37.50	6.80	44.30	68.20	-23.90	AVG

IEEE 802.11a Mode / CH High

Detector mode: Peak

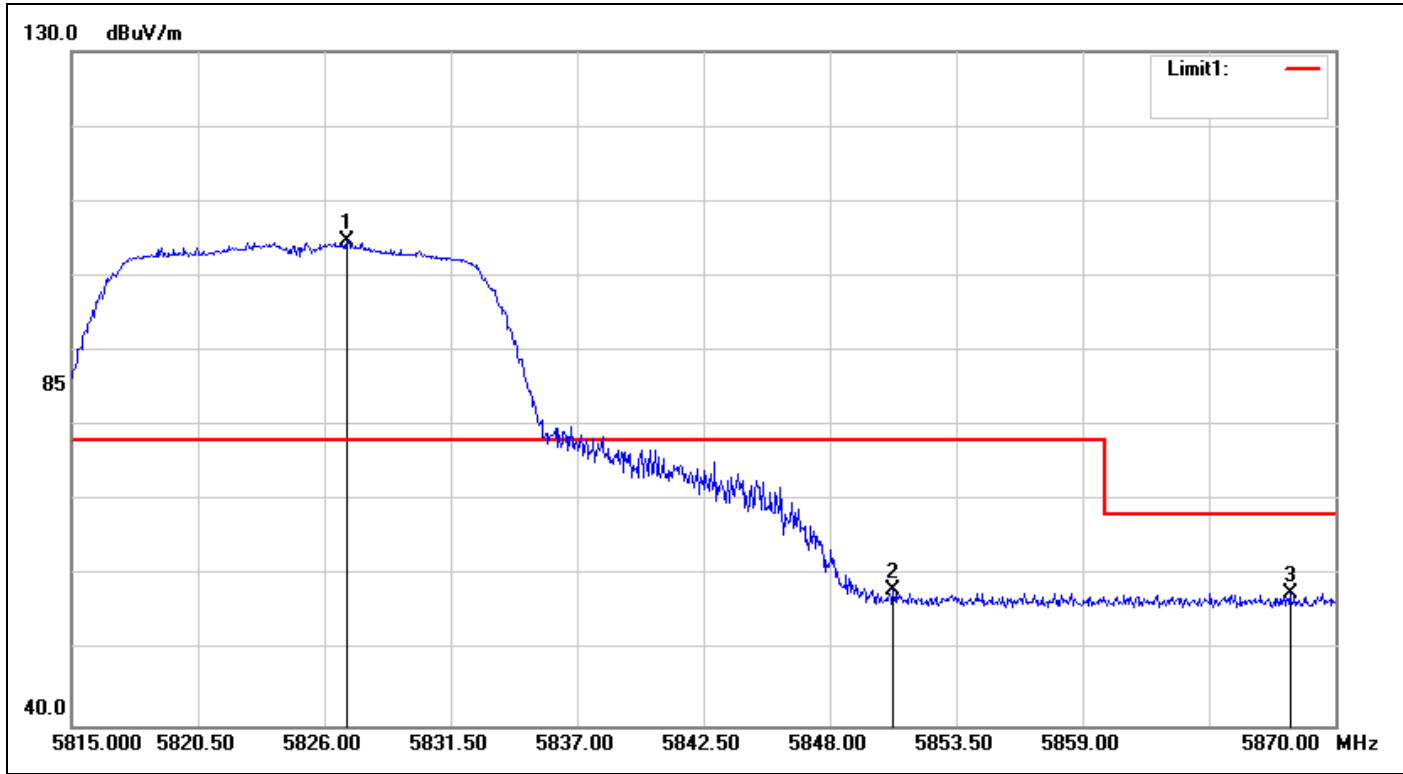

No.	Frequency (MHz)	Reading (dBuV)	Correct Factor(dB/m)	Result (dBuV/m)	Limit (dBuV/m)	Margin (dB)	Remark
1	5826.990	98.15	6.64	104.79	-	-	peak
2	5850.750	51.38	6.74	58.12	78.20	-20.08	peak
3	5868.020	50.93	6.82	57.75	68.20	-10.45	peak

Detector mode: Average

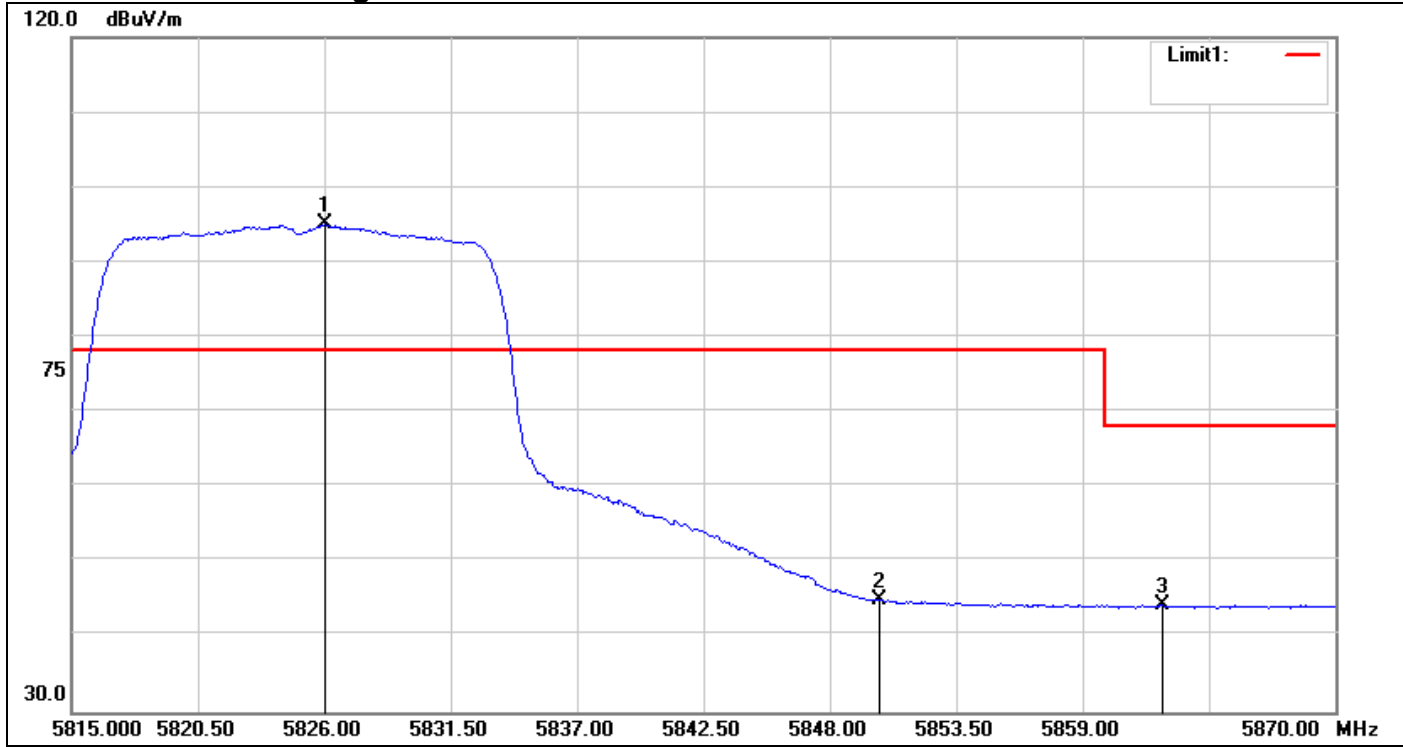

No.	Frequency (MHz)	Reading (dBuV)	Correct Factor(dB/m)	Result (dBuV/m)	Limit (dBuV/m)	Margin (dB)	Remark
1	5826.055	88.43	6.64	95.07	-	-	AVG
2	5850.145	38.24	6.74	44.98	78.20	-33.22	AVG
3	5862.465	37.46	6.79	44.25	68.20	-23.95	AVG

IEEE 802.11n HT 20 MHz Mode / CH Low

Detector mode: Peak

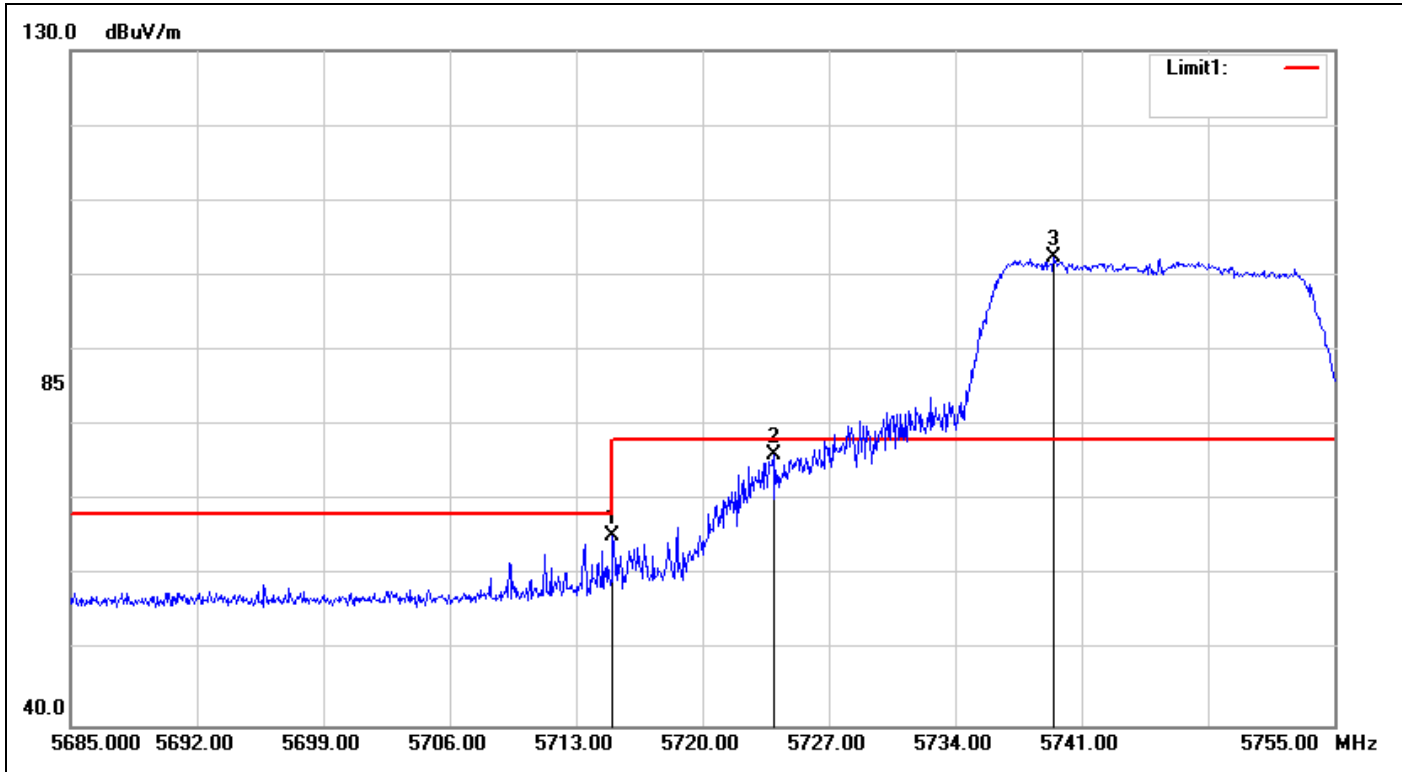

No.	Frequency (MHz)	Reading (dBuV)	Correct Factor(dB/m)	Result (dBuV/m)	Limit (dBuV/m)	Margin (dB)	Remark
1	5715.000	59.11	6.17	65.28	68.20	-2.92	peak
2	5723.920	69.83	6.20	76.03	78.20	-2.17	peak
3	5739.460	96.07	6.27	102.34	-	-	peak

Detector mode: Average

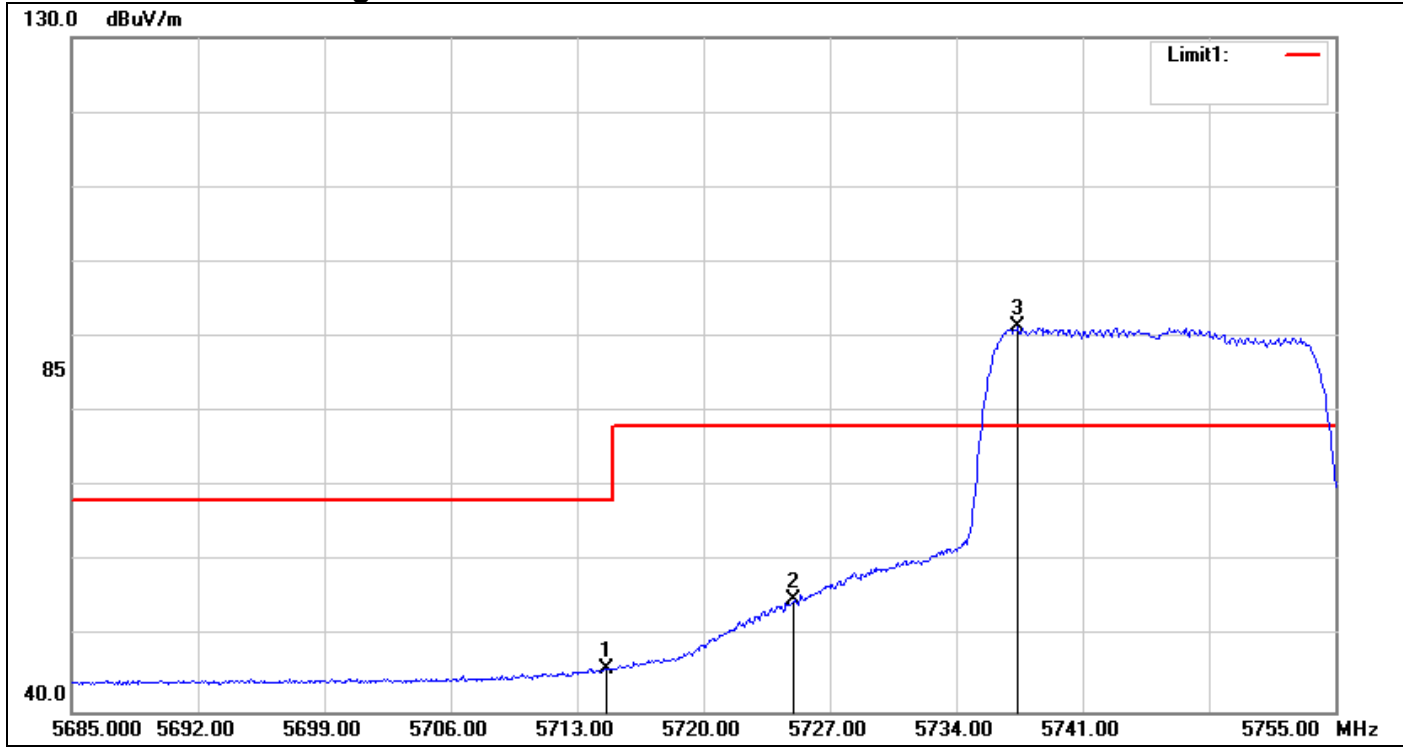

No.	Frequency (MHz)	Reading (dBuV)	Correct Factor(dB/m)	Result (dBuV/m)	Limit (dBuV/m)	Margin (dB)	Remark
1	5714.610	39.68	6.16	45.84	68.20	-22.36	AVG
2	5725.000	48.64	6.21	54.85	78.20	-23.35	AVG
3	5737.430	85.11	6.26	91.37	-	-	AVG

IEEE 802.11n HT 20 MHz Mode / CH Mid

Detector mode: Peak

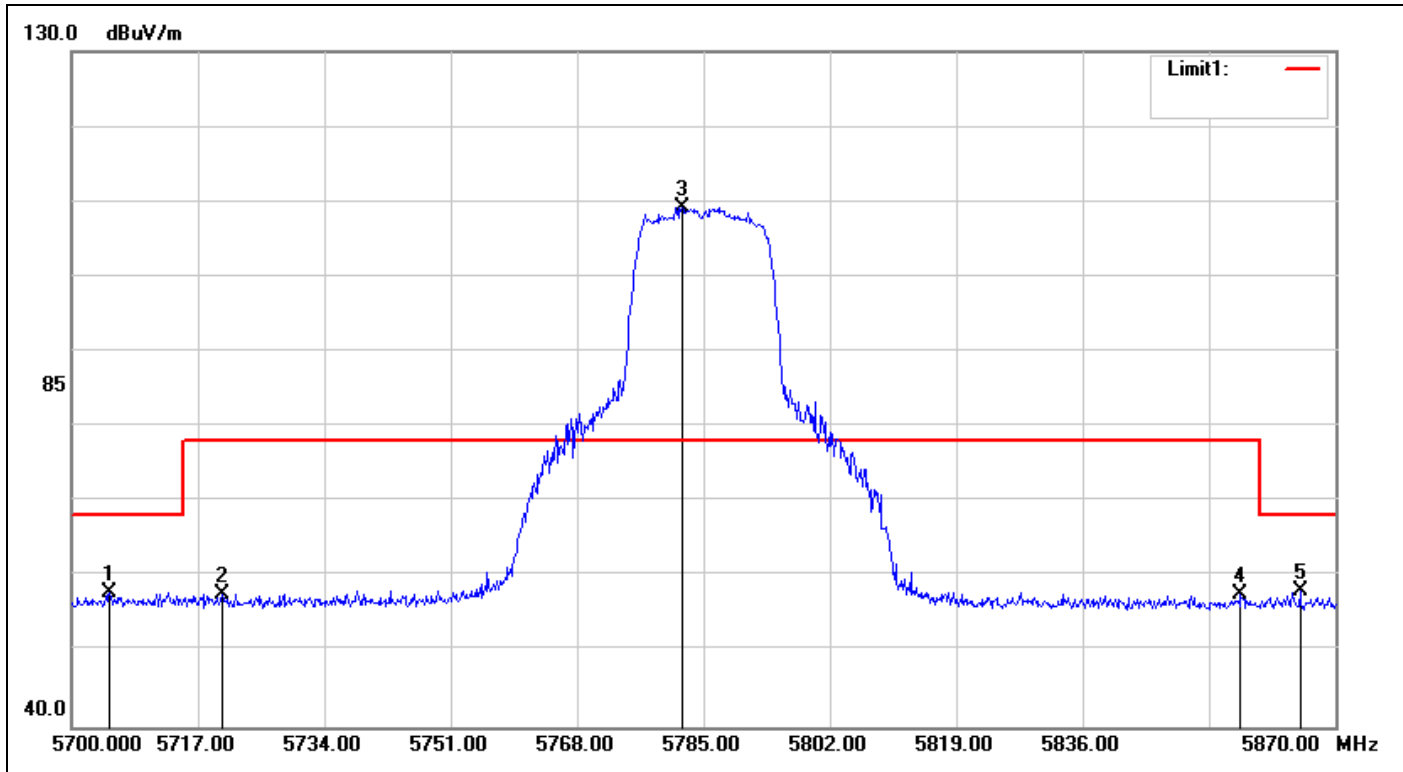

No.	Frequency (MHz)	Reading (dBuV)	Correct Factor(dB/m)	Result (dBuV/m)	Limit (dBuV/m)	Margin (dB)	Remark
1	5705.000	51.83	6.12	57.95	68.20	-10.25	peak
2	5720.230	51.53	6.19	57.72	78.20	-20.48	peak
3	5782.110	102.72	6.45	109.17	-	-	peak
4	5857.250	50.86	6.77	57.63	78.20	-20.57	peak
5	5865.240	51.29	6.81	58.10	68.20	-10.10	peak

Detector mode: Average

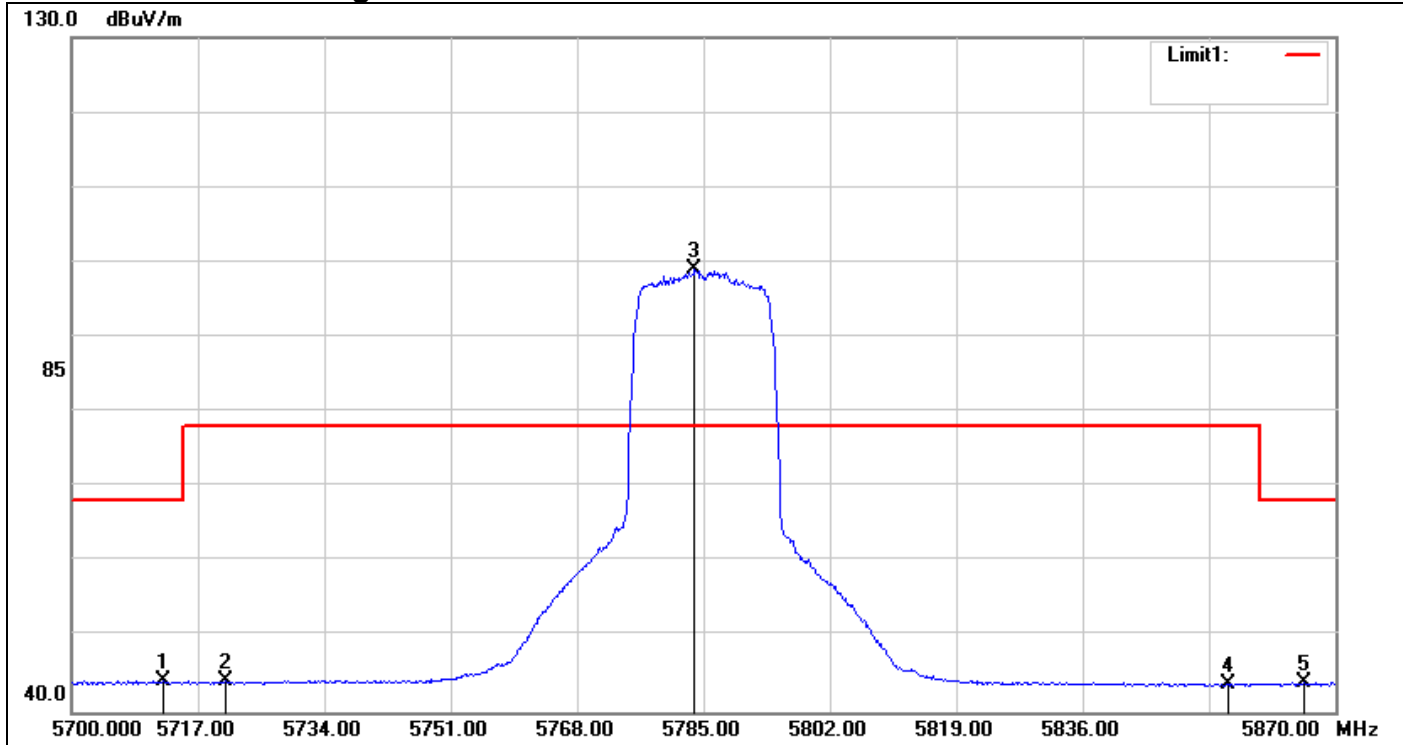

No.	Frequency (MHz)	Reading (dBuV)	Correct Factor(dB/m)	Result (dBuV/m)	Limit (dBuV/m)	Margin (dB)	Remark
1	5712.410	38.06	6.15	44.21	68.20	-23.99	AVG
2	5720.740	37.88	6.19	44.07	78.20	-34.13	AVG
3	5783.810	92.51	6.46	98.97	-	-	AVG
4	5855.550	37.04	6.76	43.80	78.20	-34.40	AVG
5	5865.750	37.10	6.81	43.91	68.20	-24.29	AVG

IEEE 802.11n HT 20 MHz Mode / CH High

Detector mode: Peak

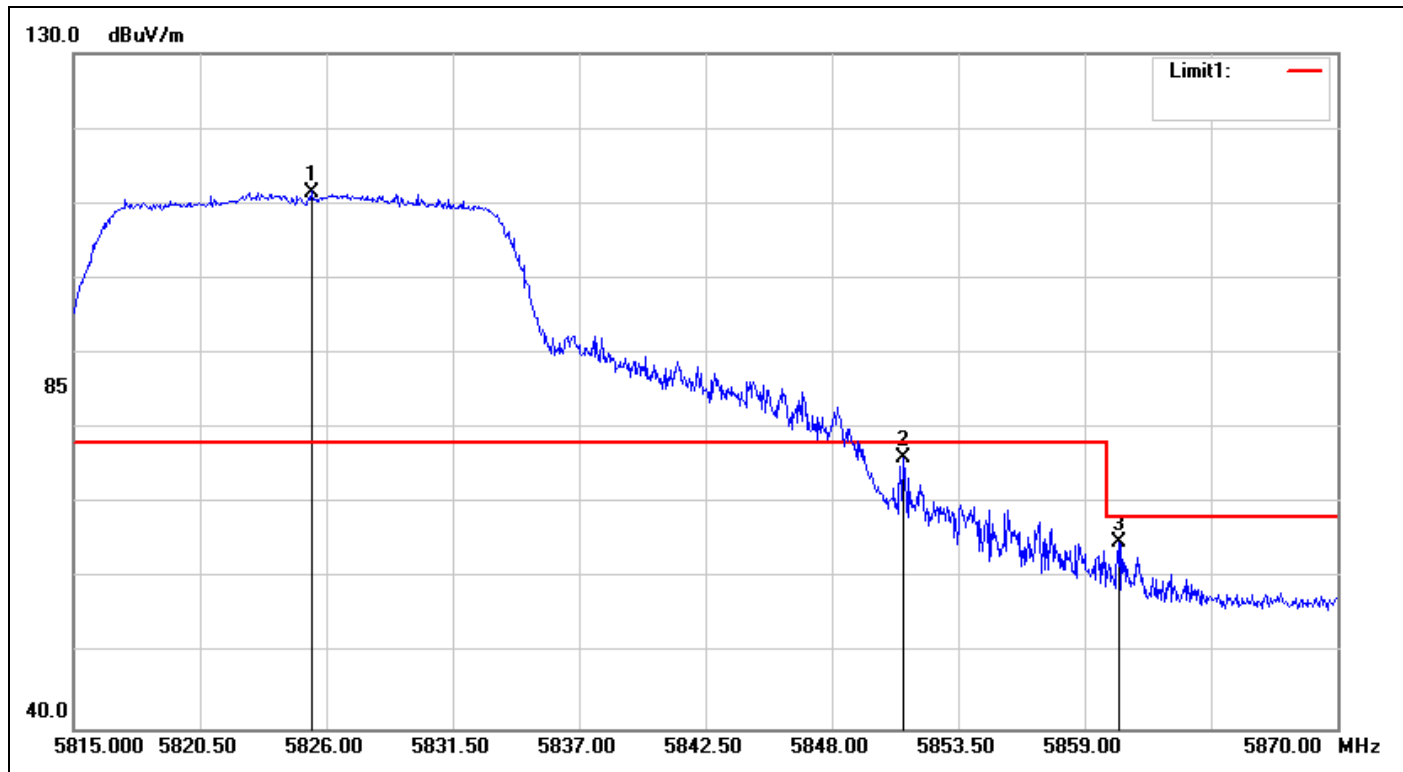

No.	Frequency (MHz)	Reading (dBuV)	Correct Factor(dB/m)	Result (dBuV/m)	Limit (dBuV/m)	Margin (dB)	Remark
1	5825.340	104.91	6.64	111.55	-	-	peak
2	5851.080	69.37	6.75	76.12	78.20	-2.08	peak
3	5860.485	57.98	6.79	64.77	68.20	-3.43	peak

Detector mode: Average

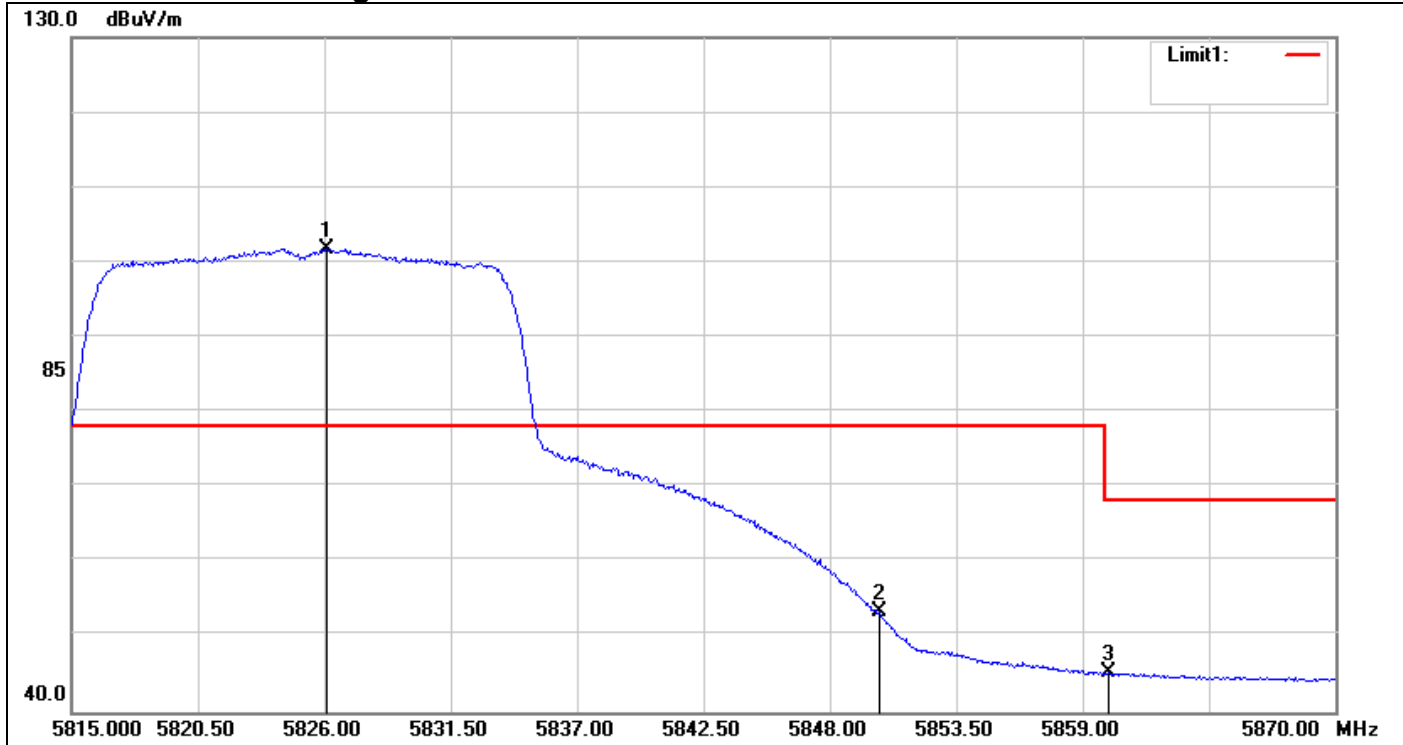

No.	Frequency (MHz)	Reading (dBuV)	Correct Factor(dB/m)	Result (dBuV/m)	Limit (dBuV/m)	Margin (dB)	Remark
1	5826.110	95.17	6.64	101.81	-	-	AVG
2	5850.145	46.62	6.74	53.36	78.20	-24.84	AVG
3	5860.100	38.53	6.78	45.31	68.20	-22.89	AVG

IEEE 802.11n HT 40 MHz Mode / CH Low

Detector mode: Peak

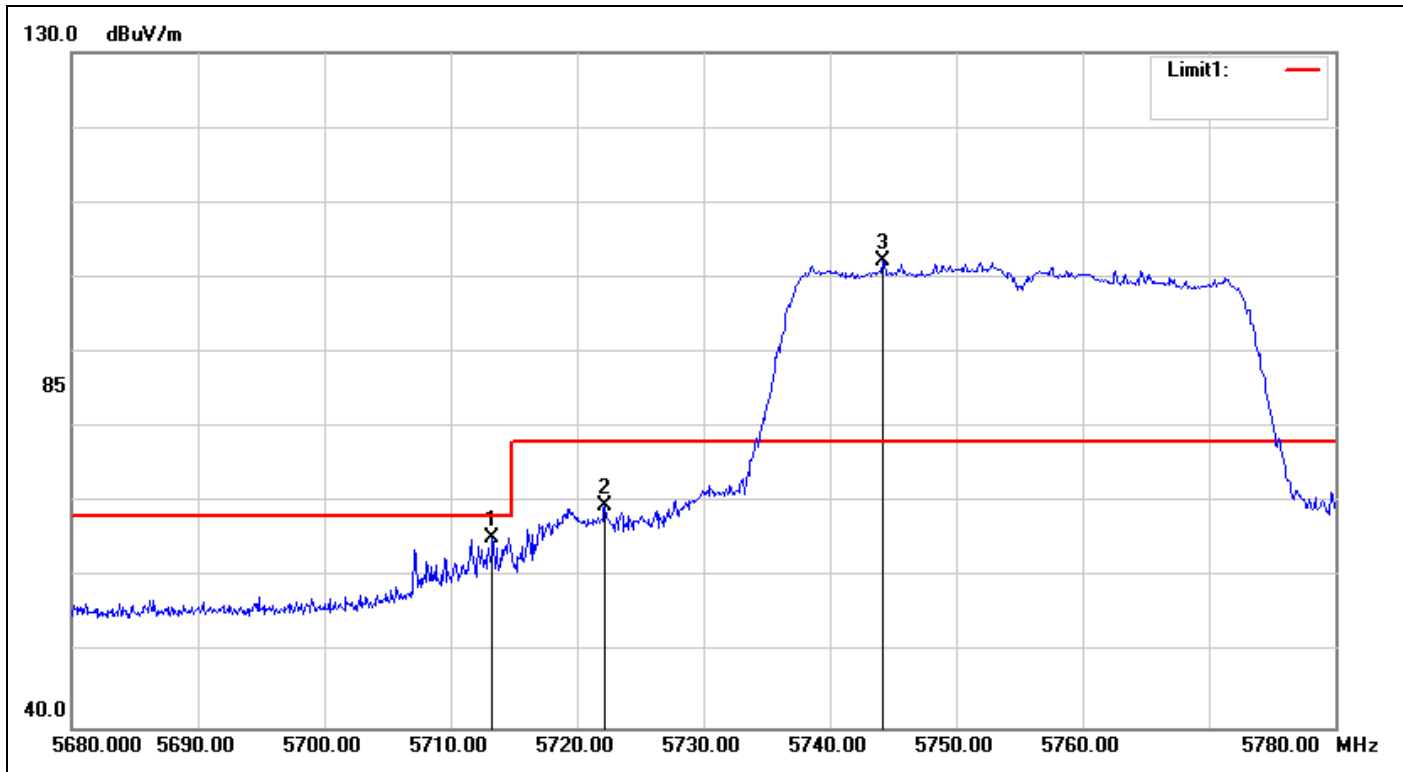

No.	Frequency (MHz)	Reading (dBuV)	Correct Factor(dB/m)	Result (dBuV/m)	Limit (dBuV/m)	Margin (dB)	Remark
1	5713.300	59.26	6.16	65.42	68.20	-2.78	peak
2	5722.200	63.28	6.20	69.48	78.20	-8.72	peak
3	5744.200	95.92	6.29	102.21	-	-	peak

Detector mode: Average

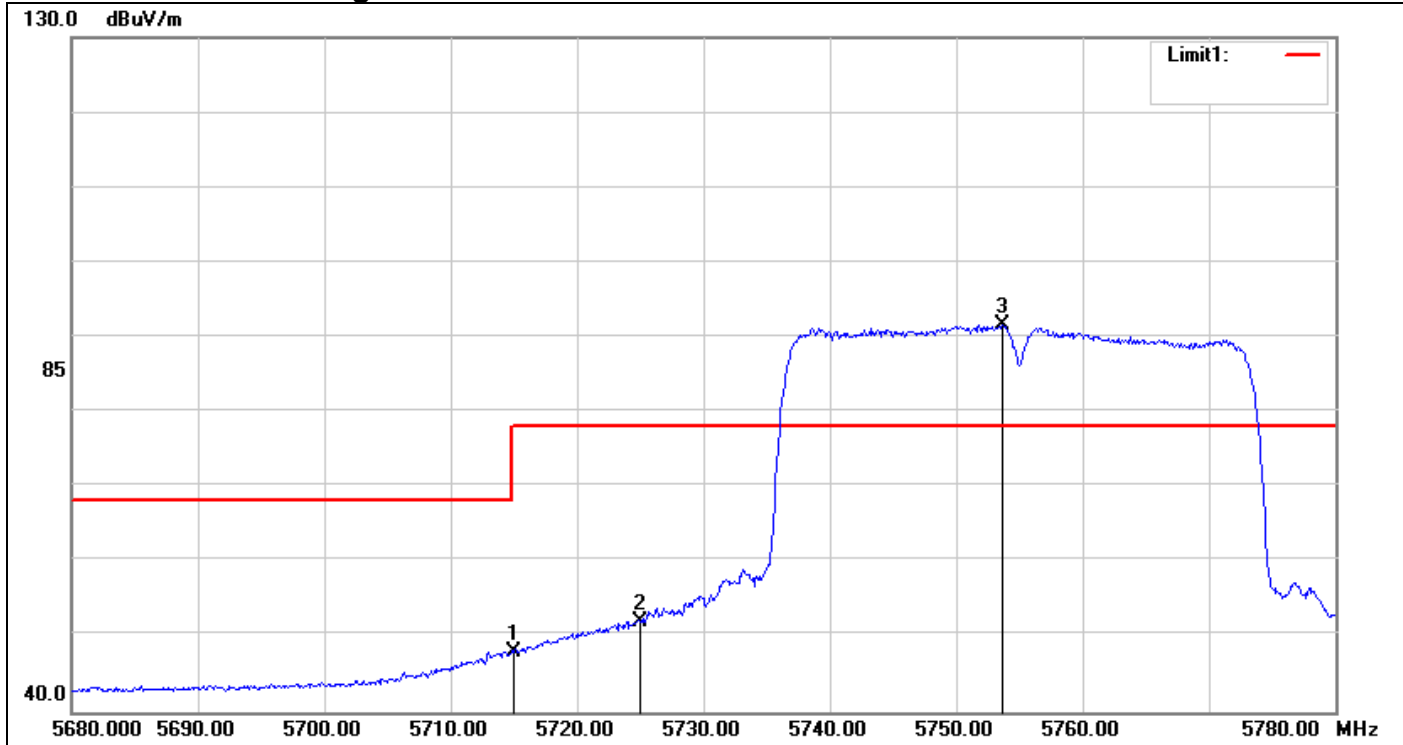

No.	Frequency (MHz)	Reading (dBuV)	Correct Factor(dB/m)	Result (dBuV/m)	Limit (dBuV/m)	Margin (dB)	Remark
1	5715.000	41.82	6.17	47.99	68.20	-20.21	AVG
2	5725.000	45.73	6.21	51.94	78.20	-26.26	AVG
3	5753.700	85.29	6.33	91.62	-	-	AVG

IEEE 802.11n HT 40 MHz Mode / CH High

Detector mode: Peak

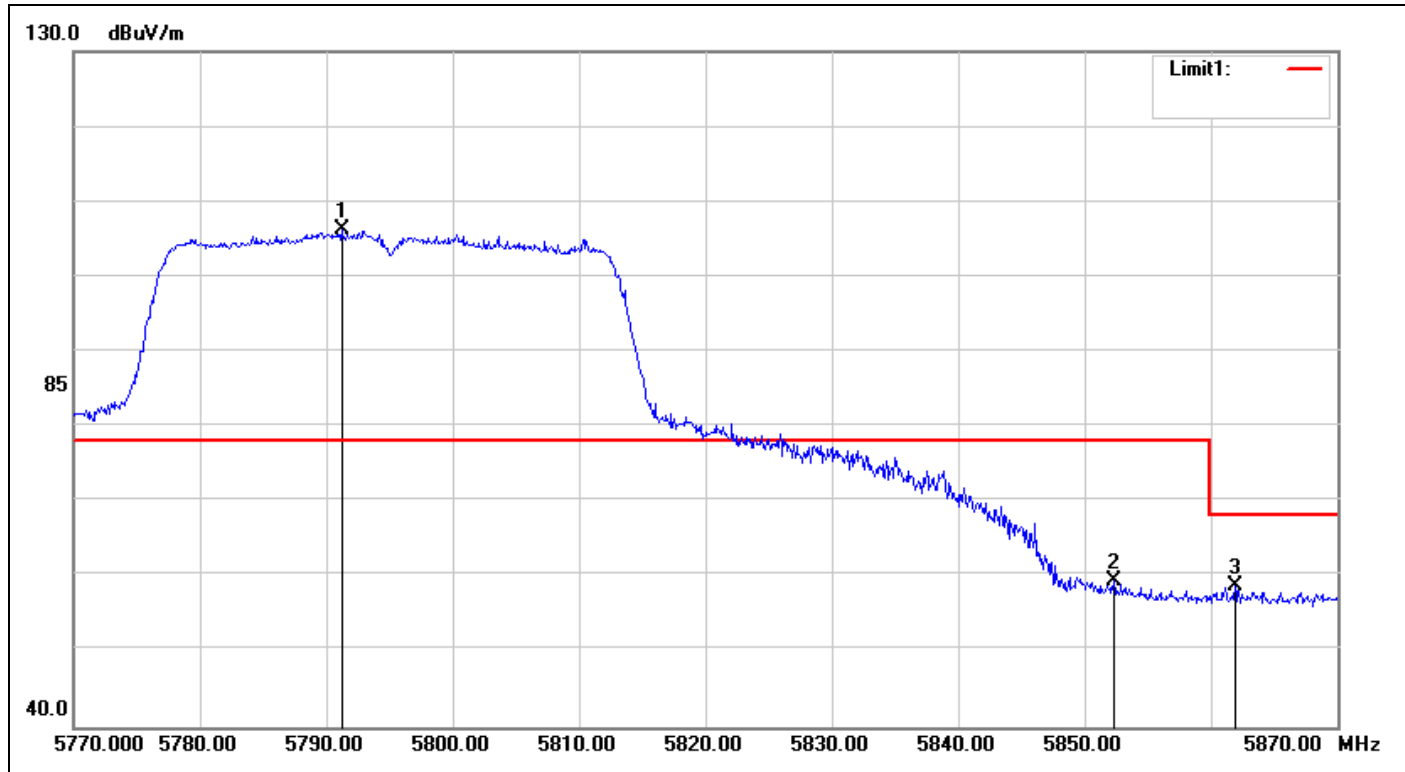

No.	Frequency (MHz)	Reading (dBuV)	Correct Factor(dB/m)	Result (dBuV/m)	Limit (dBuV/m)	Margin (dB)	Remark
1	5791.200	99.76	6.49	106.25	-	-	peak
2	5852.300	52.79	6.75	59.54	78.20	-18.66	peak
3	5861.900	52.05	6.79	58.84	68.20	-9.36	peak

Detector mode: Average

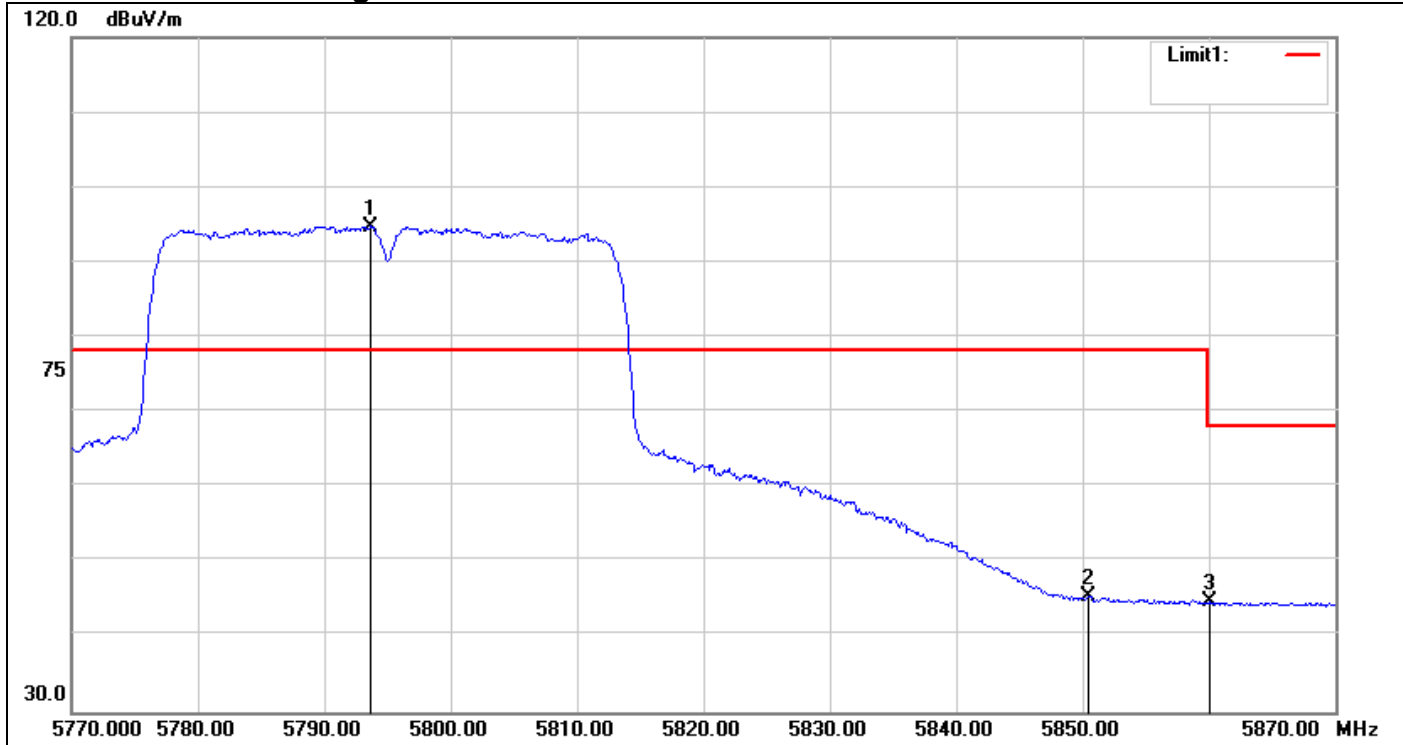

No.	Frequency (MHz)	Reading (dBuV)	Correct Factor(dB/m)	Result (dBuV/m)	Limit (dBuV/m)	Margin (dB)	Remark
1	5793.700	88.30	6.50	94.80	-	-	AVG
2	5850.500	38.71	6.74	45.45	78.20	-32.75	AVG
3	5860.100	37.89	6.78	44.67	68.20	-23.53	AVG

7.5 PEAK POWER SPECTRAL DENSITY

LIMIT

1. According to §15.407 & RSS-247 §, for digitally modulated systems, the power spectral density conducted from the intentional radiator to the antenna shall not be greater than 30 dBm in any 500 kHz band during any time interval of continuous transmission.

Test Configuration

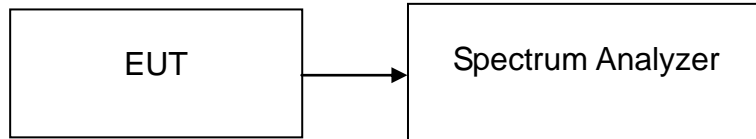

TEST PROCEDURE

1. Place the EUT on the table and set it in transmitting mode. Remove the antenna from the EUT and then connect a low loss RF cable from the antenna port to the spectrum analyzer.
2. Set the spectrum analyzer as RBW = 3kHz, VBW = 10kHz, Span = 300kHz, Sweep=100s
3. Record the max. reading.
4. Repeat the above procedure until the measurements for all frequencies are completed.

TEST RESULTS

No non-compliance noted

Test Data

Test mode: IEEE 802.11a mode/ 5745 ~ 5825MHz

Duty Cycle : 89.32% Duty Fac: 0.49

Channel	Frequency (MHz)	PPSD (dBm)	Limit (dBm)	Result
Low	5745	8.47	30.00	PASS
Mid	5785	7.88		PASS
High	5825	8.09		PASS

Test mode: IEEE 802.11n HT 20 MHz mode / 5745 ~ 5825MHz

Duty Cycle : 88.66% Duty Fac: 0.52

Channel	Frequency (MHz)	Chain 0 PPSD (dBm)	Chain 1 PPSD (dBm)	PPSD (dBm)	Limit (dBm)	Result
Low	5745	9.12	9.35	12.25	30.00	PASS
Mid	5785	6.66	7.37	10.04		PASS
High	5825	6.71	6.83	9.78		PASS

Test mode: IEEE 802.11n HT 40 MHz mode / 5755 ~ 5795MHz

Duty Cycle : 81.49% Duty Fac: 0.89

Channel	Frequency (MHz)	Chain 0 PPSD (dBm)	Chain 1 PPSD (dBm)	PPSD (dBm)	Limit (dBm)	Result
Low	5755	3.26	3.12	6.20	30.00	PASS
High	5795	5.51	5.55	8.54		PASS

Remark:

1. Total PPSD (dBm) = 10*LOG(10^(Chain 0 PPSD / 10)+10^(Chain 1 PPSD / 10))

Test Plot

IEEE 802.11a MHz mode / 5745 ~ 5825MHz

PPSD (CH Low)

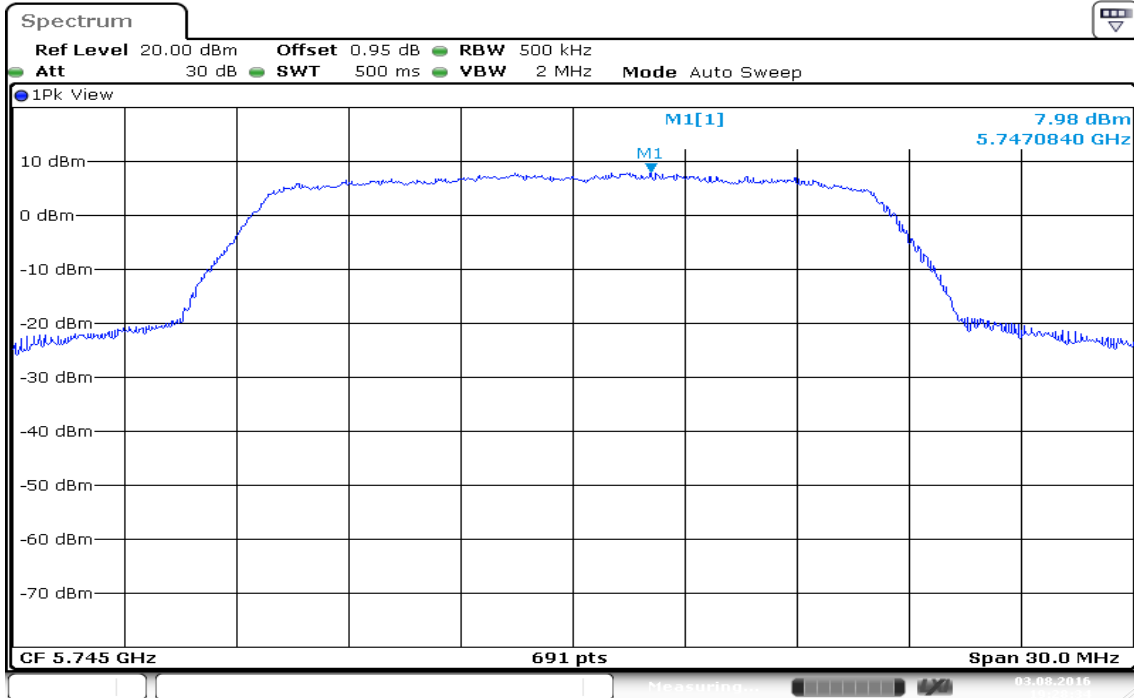

Date: 3.AUG.2016 19:28:35

PPSD (CH Mid)

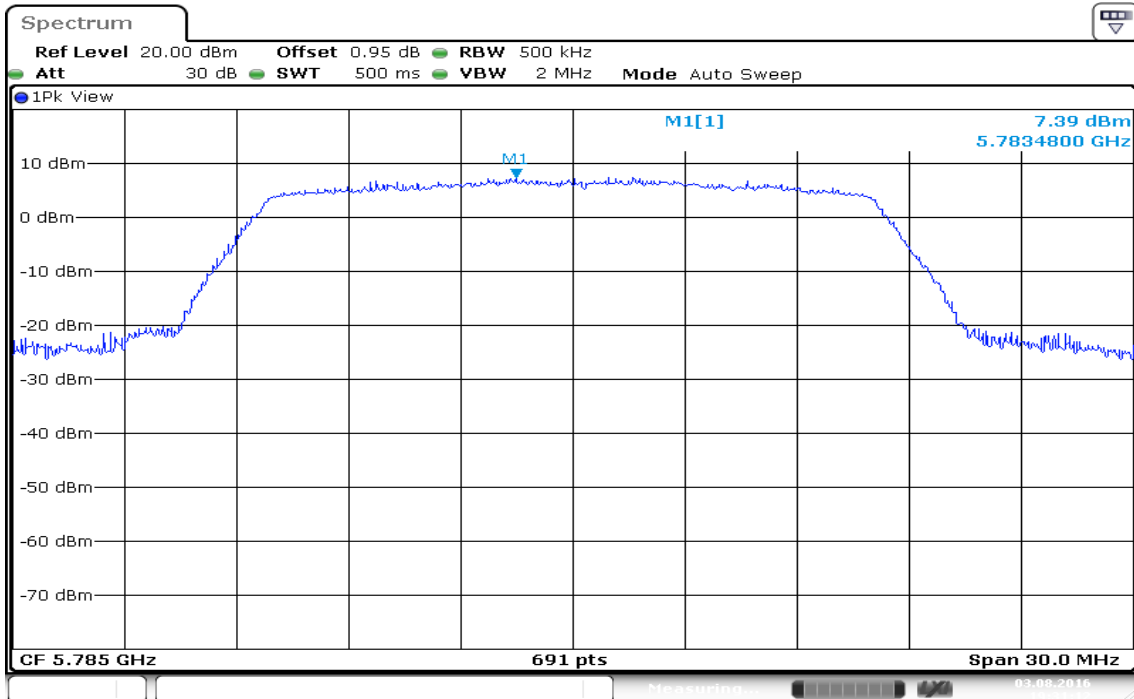

Date: 3.AUG.2016 19:31:13

PPSD (CH High)

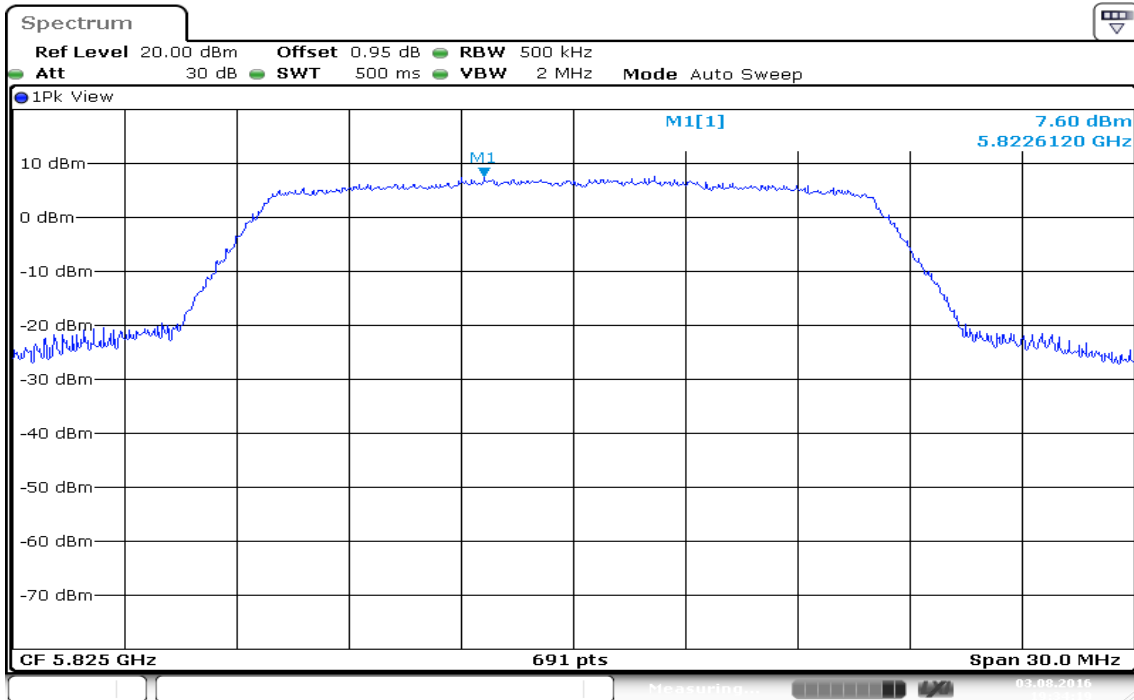

Date: 3.AUG.2016 19:34:20

IEEE 802.11n HT 20 MHz mode / 5745 ~ 5825MHz / Chain 0

PPSD (CH Low)

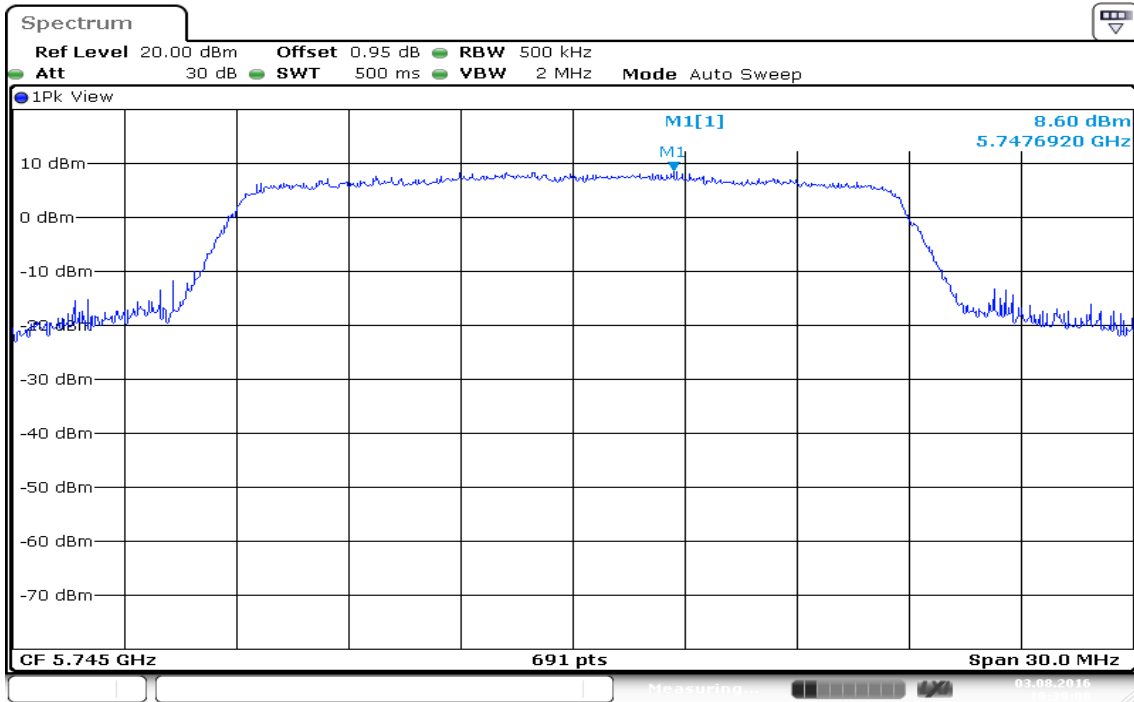

Date: 3.AUG.2016 19:39:09

PPSD (CH Mid)

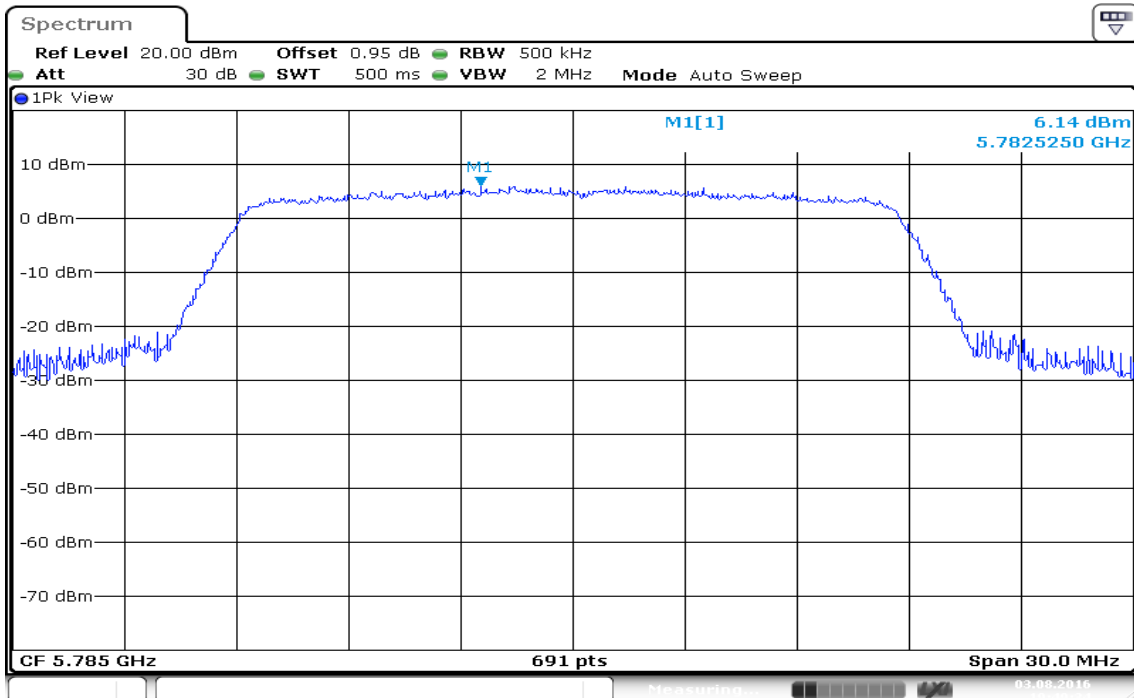

Date: 3.AUG.2016 19:49:35

PPSD (CH High)

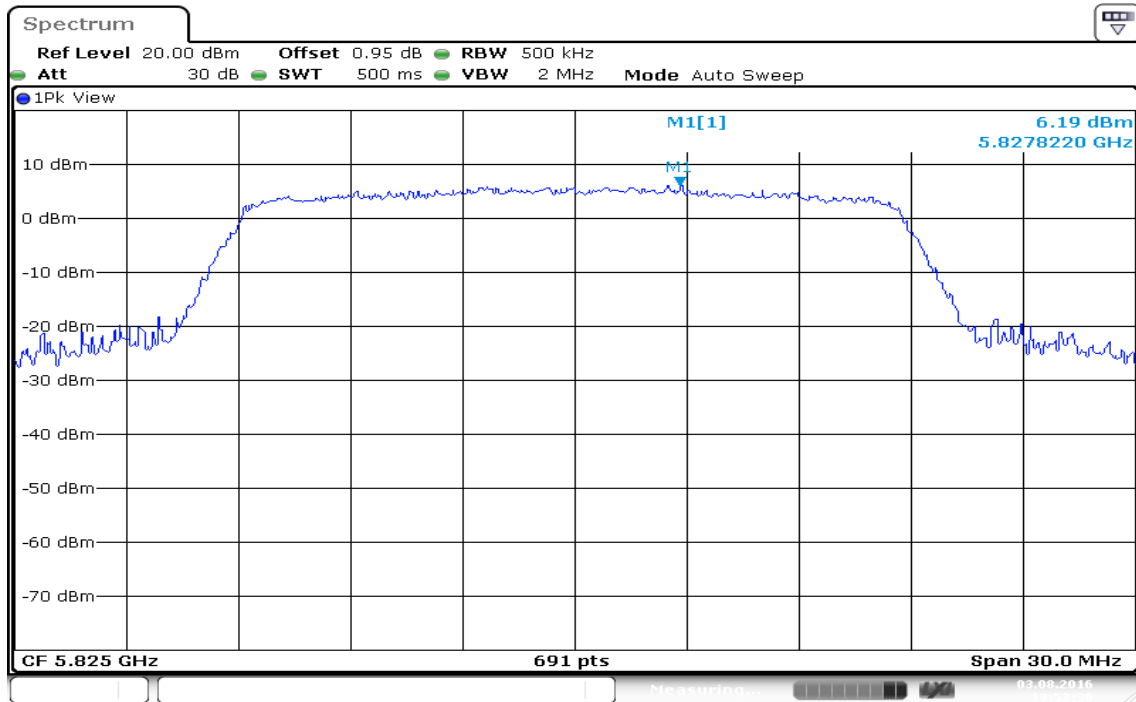

Date: 3.AUG.2016 19:52:36

IEEE 802.11n HT 20 MHz mode / 5745 ~ 5825MHz / Chain 1

PPSD (CH Low)

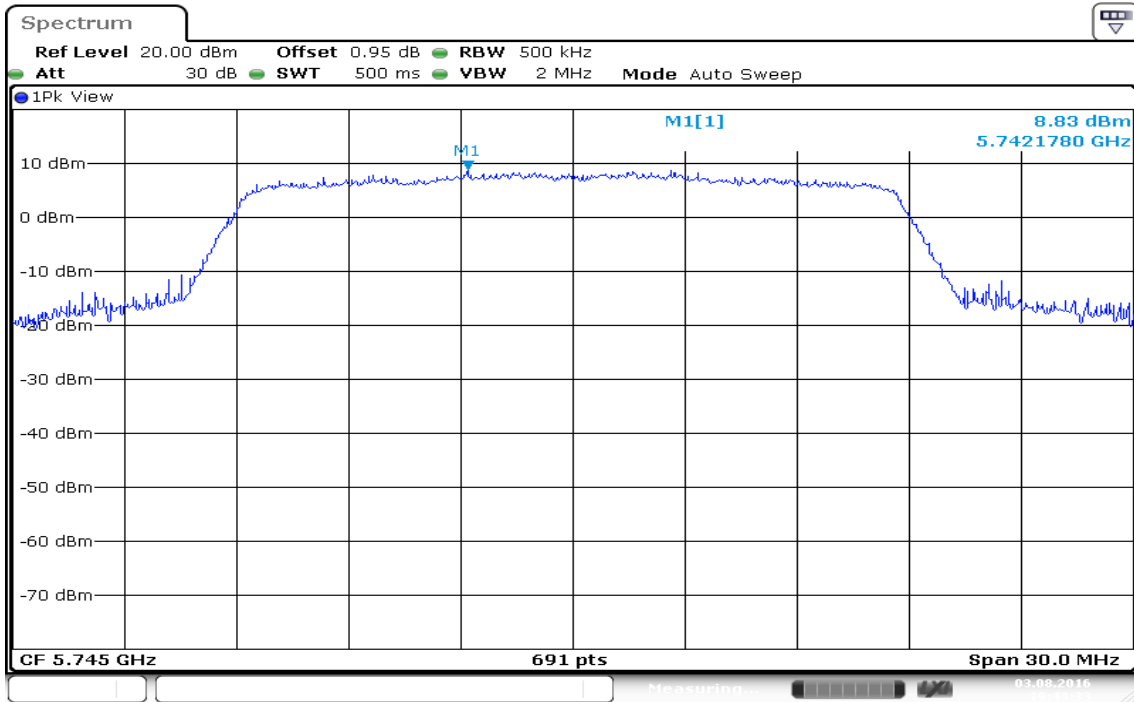

PPSD (CH Mid)

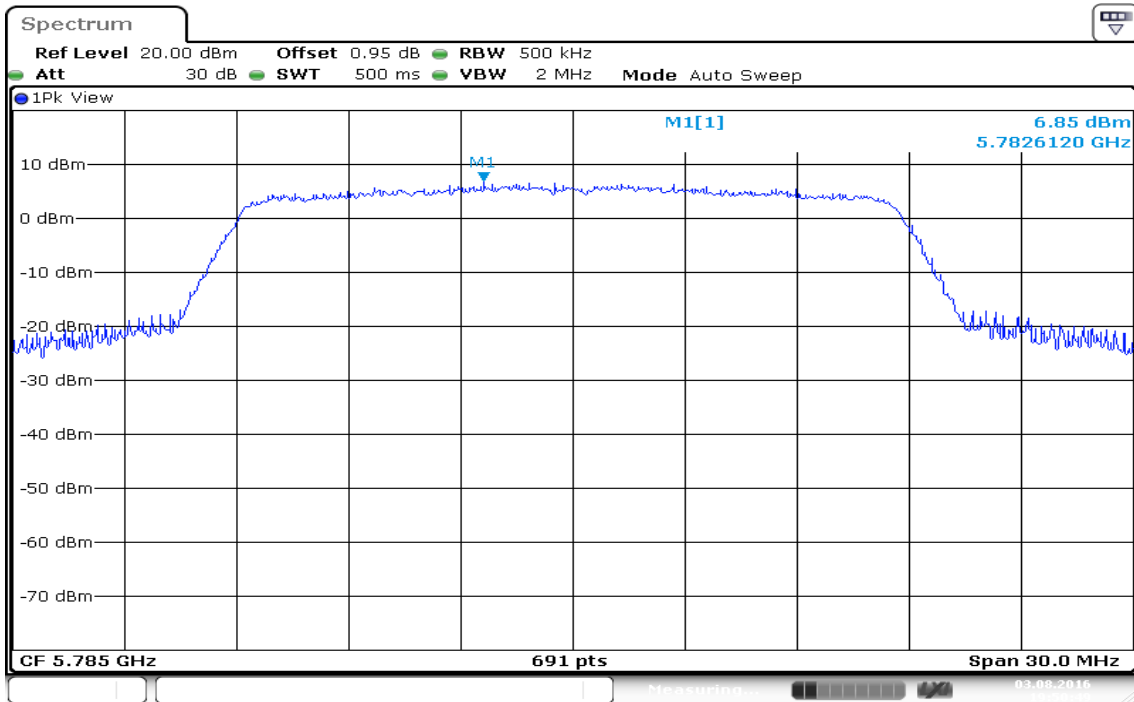

PPSD (CH High)

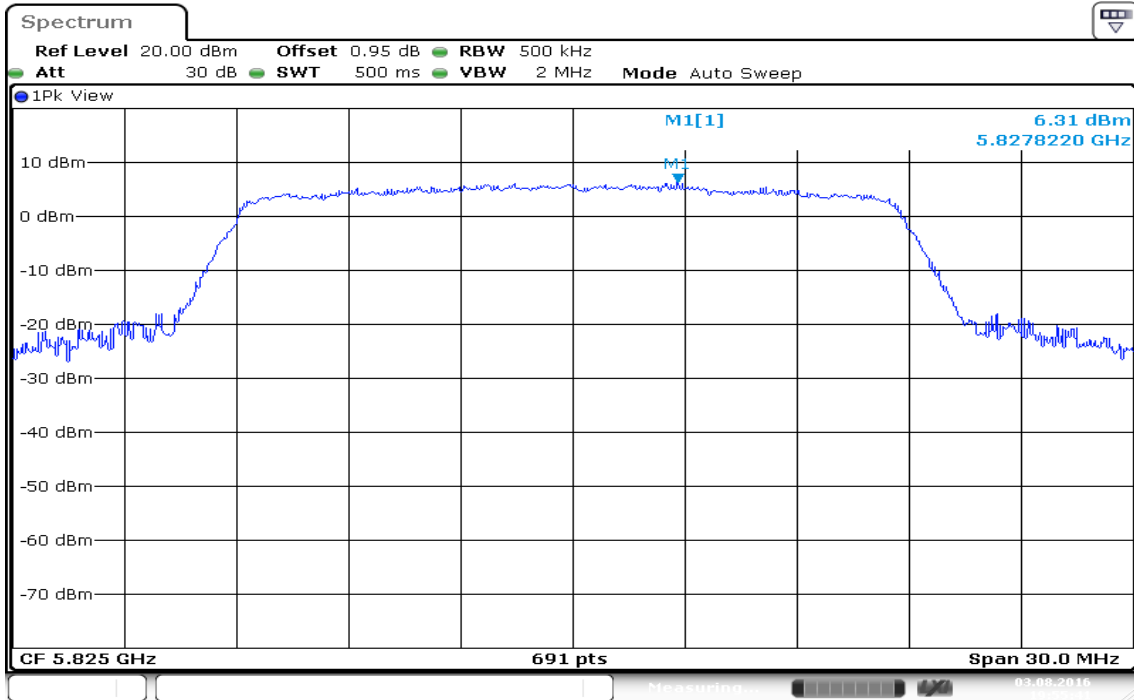

Date: 3.AUG.2016 19:55:42

IEEE 802.11n HT 40 MHz mode / 5755 ~ 5795MHz / Chain 0

PPSD (CH Low)

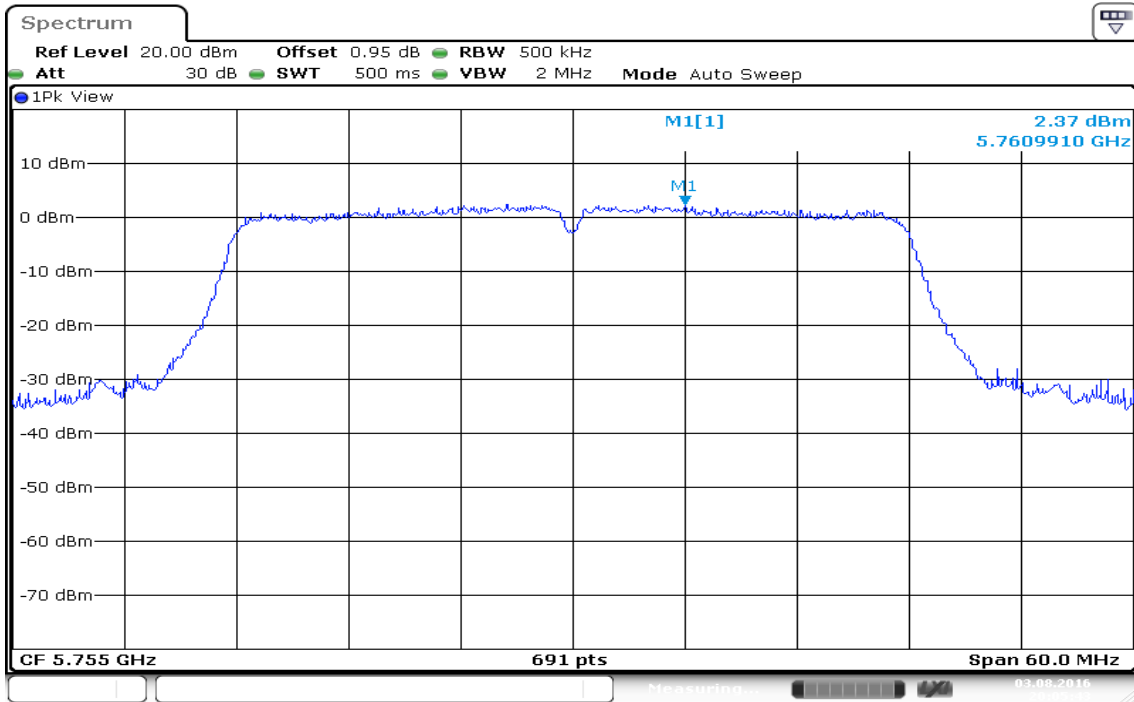

Date: 3.AUG.2016 20:05:44

PPSD (CH High)

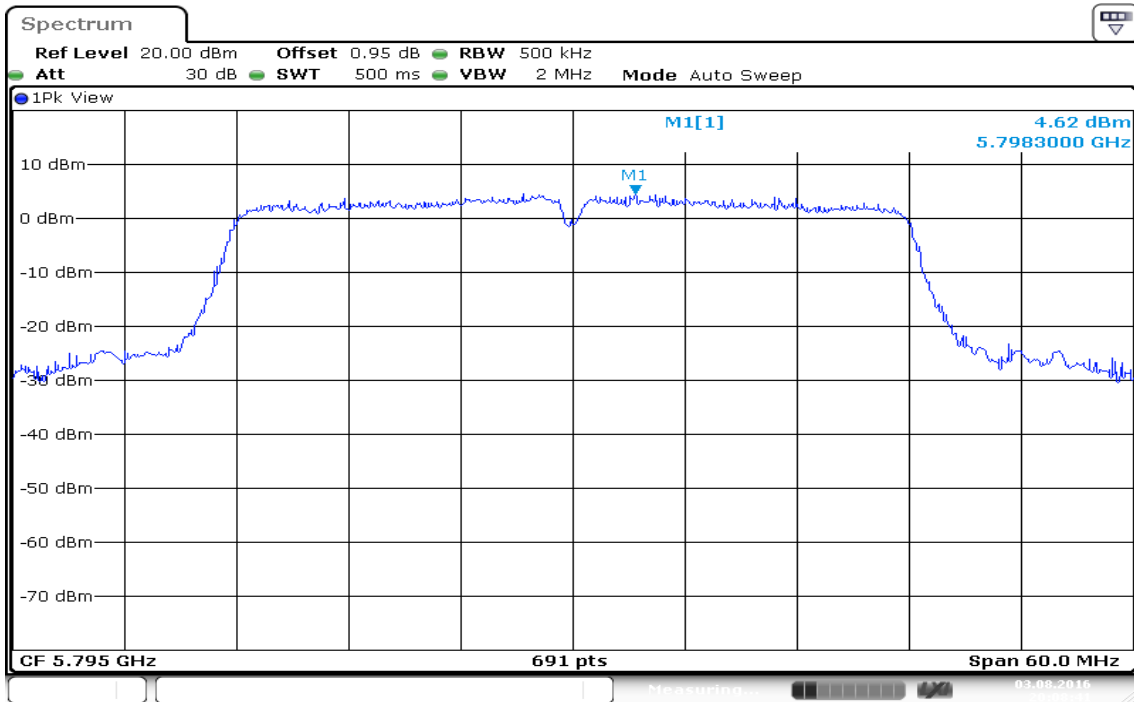

Date: 3.AUG.2016 20:08:42

IEEE 802.11n HT 40 MHz mode / 5755 ~ 5795MHz / Chain 1

PPSD (CH Low)

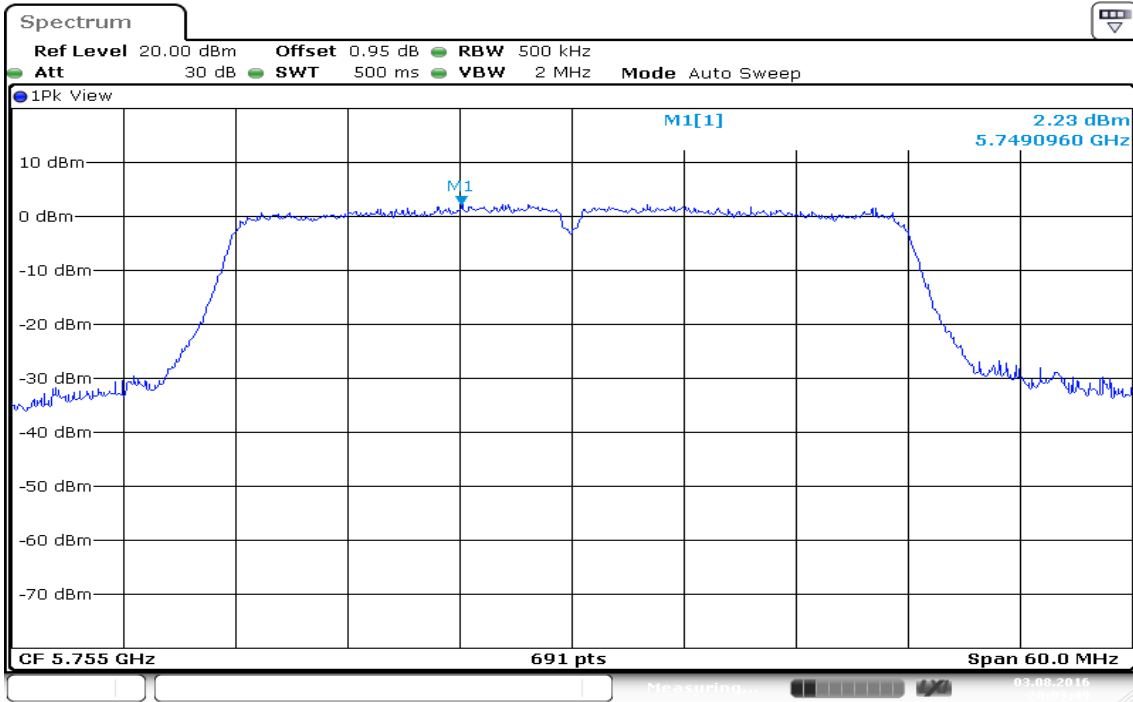

Date: 3.AUG.2016 20:03:49

PPSD (CH High)

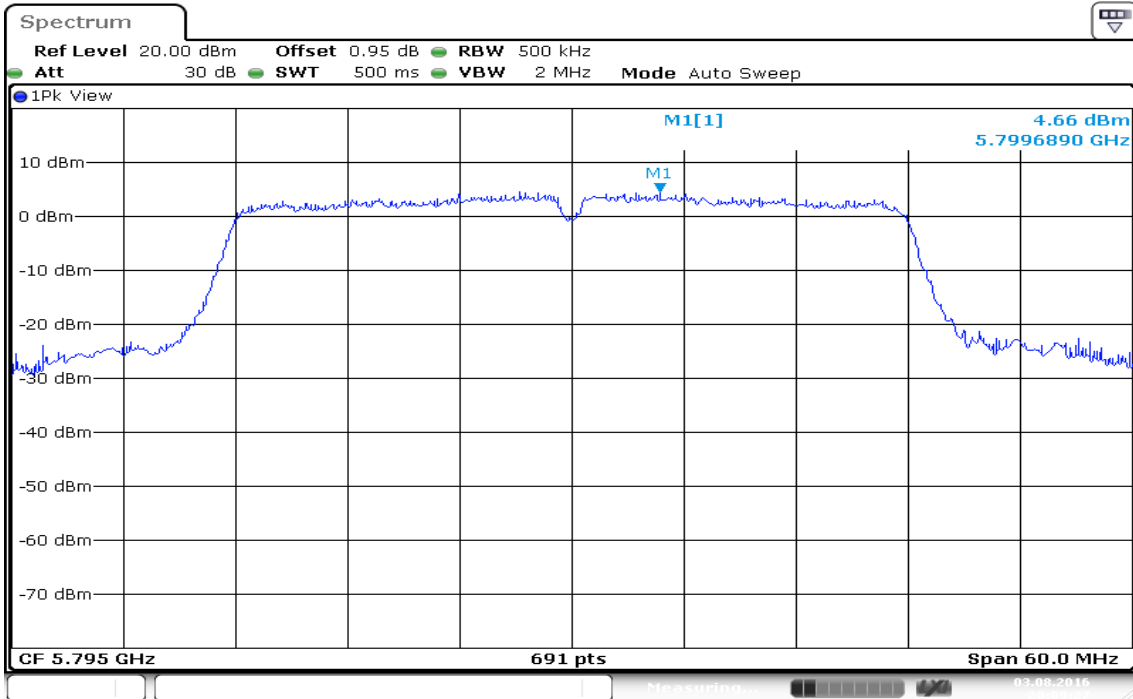

Date: 3.AUG.2016 20:09:28

7.6 RADIATED EMISSIONS

LIMIT

All spurious emissions shall comply with the limits of §15.209(a) and RSS-Gen Table 2 & Table 5.

RSS-Gen Table 2 & Table 5: General Field Strength Limits for Transmitters and Receivers at Frequencies Above 30 MHz ^(Note)

Frequency (MHz)	Field Strength microvolts/m at 3 metres (watts, e.i.r.p.)	
	Transmitters	Receivers
30-88	100 (3 nW)	100 (3 nW)
88-216	150 (6.8 nW)	150 (6.8 nW)
216-960	200 (12 nW)	200 (12 nW)
Above 960	500 (75 nW)	500 (75 nW)

Note: *Measurements for compliance with limits in the above table may be performed at distances other than 3 metres, in accordance with Section 7.2.7.

Transmitting devices are not permitted in Table 1 bands or, unless stated otherwise, in TV bands (54-72 MHz, 76-88 MHz, 174-216 MHz, 470-608 MHz and 614-806 MHz).

RSS-Gen Table 6: General Field Strength Limits for Transmitters at Frequencies Below 30 MHz (Transmit)

Frequency	Field Strength (microvolts/m)	Magnetic H-Field (microamperes/m)	Measurement Distance (metres)
9-490 kHz	2,400/F (F in kHz)	2,400/377F (F in kHz)	3000
490-1,705 kHz	24,000/F (F in kHz)	24,000/377F (F in kHz)	30
1.705-30 MHz	30	N/A	30

Note: The emission limits for the bands 9-90 kHz and 110-490 kHz are based on measurements employing an average detector.

Test Configuration

9kHz ~ 30MHz

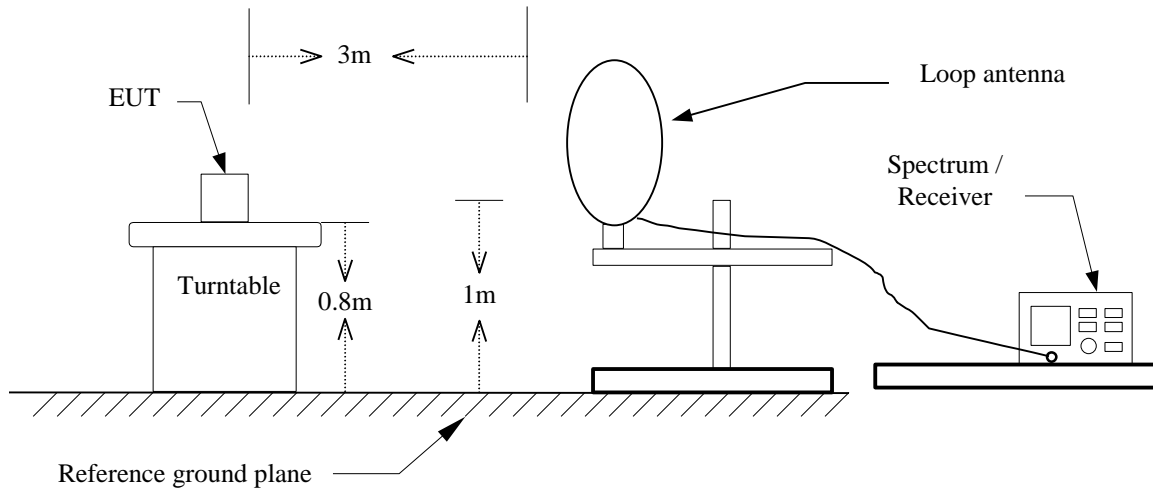

30MHz ~ 1GHz

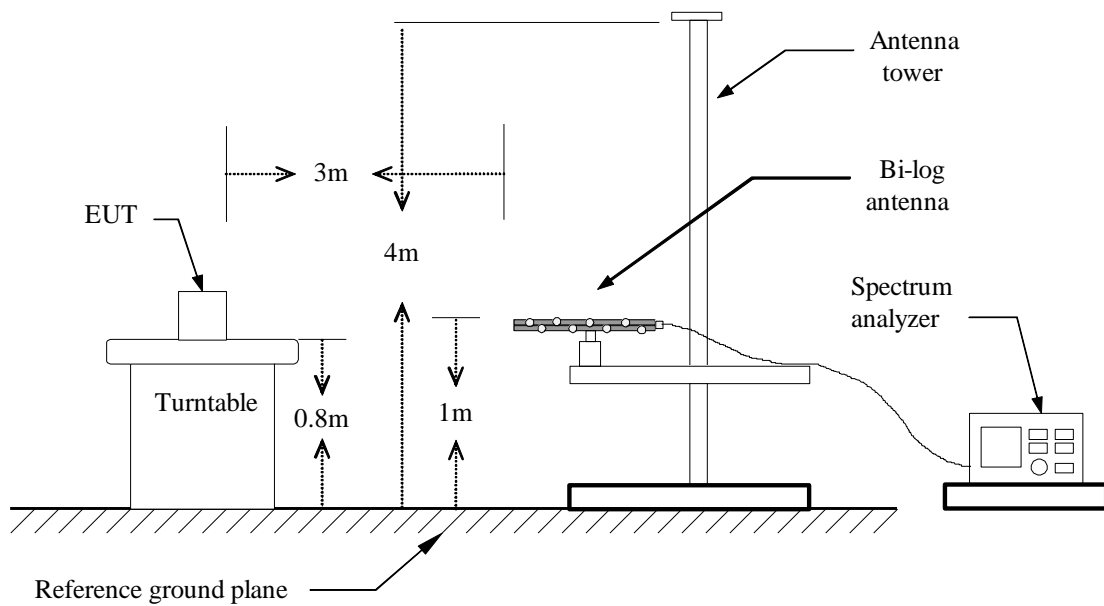

Above 1 GHz

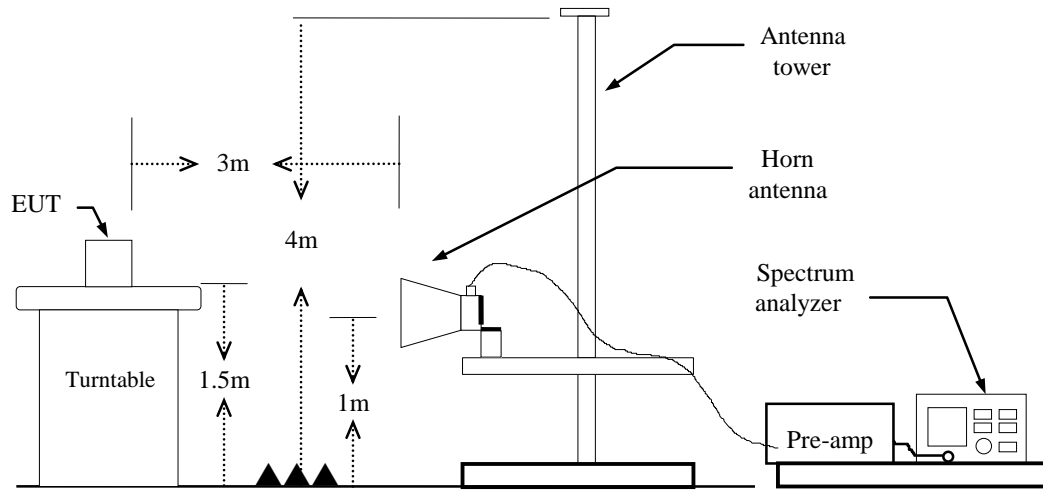

TEST PROCEDURE

1. The EUT is placed on a turntable, Above 1 GHz is 1.5m high and below 1 GHz is 0.8m high above ground plane.
2. The turntable shall be rotated for 360 degrees to determine the position of maximum emission level.
3. EUT is set 3m away from the receiving antenna, which is varied from 1m to 4m to find out the highest emissions.
4. Maximum procedure was performed on the six highest emissions to ensure EUT compliance.
5. And also, each emission was to be maximized by changing the polarization of receiving antenna both horizontal and vertical.
6. Set the spectrum analyzer in the following setting as:

Below 1GHz:

RBW=100kHz / VBW=300kHz / Sweep=AUTO

Above 1GHz:

(a) PEAK: RBW=VBW=1MHz / Sweep=AUTO

(b) AVERAGE: RBW=1MHz,
if duty cycle \geq 98%, VBW=10Hz.
if duty cycle < 98% VBW=1/T.

IEEE 802.11a mode: =89%, VBW=750Hz

IEEE 802.11n HT 20 MHz mode: =88%, VBW=750Hz

IEEE 802.11n HT 40 MHz mode: =80%, VBW=1.5KHz

7. Repeat above procedures until the measurements for all frequencies are complete.
8. Result = Spectrum Reading + cable loss(spectrum to Amp) - Amp Gain + Cable loss(Amp to receive Ant)+ Receive Ant

Note: We checked every harmonics frequencies from Fundamental frequencies with reduced VBW, and we mark a point to prove pass or not if we find any emission. For this case, there are no emissions hidden in the noise floor.

Below 1 GHz

Operation Mode: Normal Link

Test Date: August 5, 2016

Temperature: 27°C

Tested by: Dennis Li

Humidity: 53% RH

Polarity: Ver.

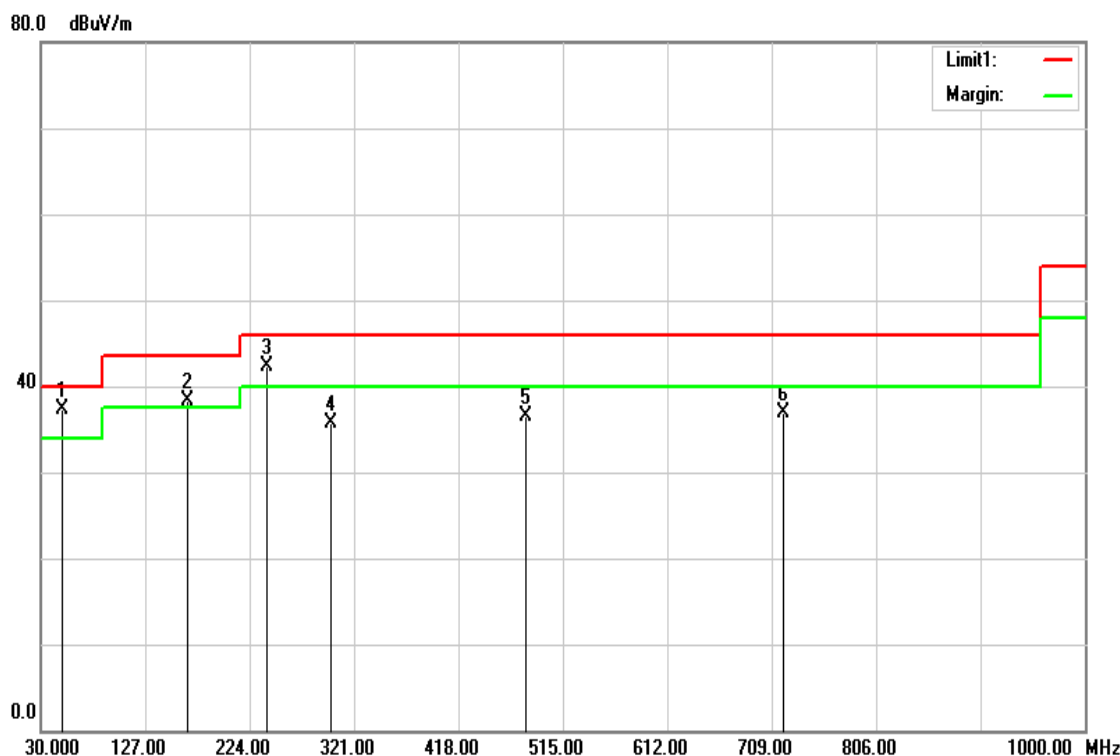

Frequency (MHz)	Reading (dBuV)	Correction Factor (dB/m)	Result (dBuV/m)	Limit (dBuV/m)	Margin (dB)	Remark	Ant.Pol. (H/V)
50.3700	58.46	-21.11	37.35	40.00	-2.65	QP	V
166.7700	55.02	-16.69	38.33	43.50	-5.17	peak	V
240.4900	58.85	-16.50	42.35	46.00	-3.65	QP	V
299.6600	49.92	-14.25	35.67	46.00	-10.33	peak	V
480.0800	46.10	-9.62	36.48	46.00	-9.52	peak	V
719.6700	42.56	-5.62	36.94	46.00	-9.06	peak	V

Remark:

1. No emission found between lowest internal used/generated frequency to 30MHz (9kHz~30MHz).
2. Radiated emissions measured in frequency range from 30 MHz to 1000MHz were made with an instrument using peak/quasi-peak detector mode.
3. Quasi-peak test would be performed if the peak result were greater than the quasi-peak limit or as required by the applicant.
4. Measurements above show only up to 6 maximum emissions noted, or would be lesser, with " N/A " remark, if no specific emissions from the EUT are recorded (ie: margin>20dB from the applicable limit) and considered that's already beyond the background noise floor.
5. Margin (dB) = Remark result (dBuV/m) – Quasi-peak limit (dBuV/m).

Operation Mode: Normal Link

Test Date: August 5, 2016

Temperature: 27°C

Tested by: Dennis Li

Humidity: 53% RH

Polarity: Hor.

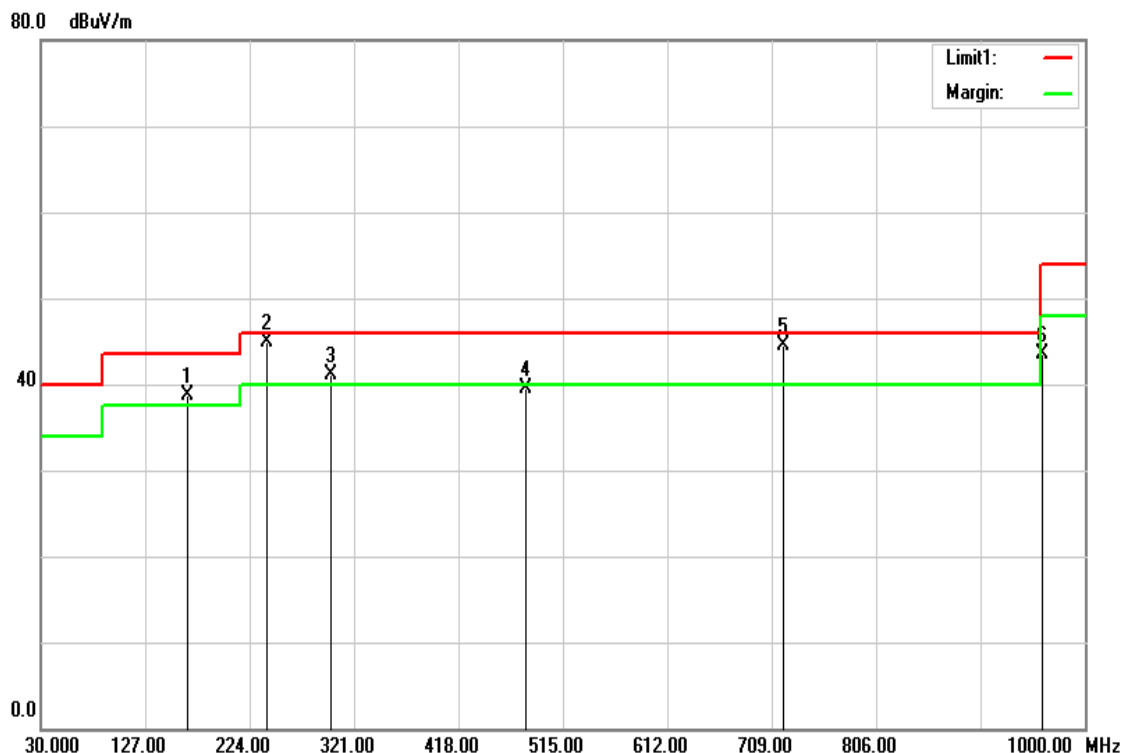

Frequency (MHz)	Reading (dBuV)	Correction Factor (dB/m)	Result (dBuV/m)	Limit (dBuV/m)	Margin (dB)	Remark	Ant.Pol. (H/V)
166.7700	55.31	-16.69	38.62	43.50	-4.88	QP	H
240.4900	61.31	-16.50	44.81	46.00	-1.19	QP	H
299.6600	55.42	-14.25	41.17	46.00	-4.83	peak	H
480.0800	49.04	-9.62	39.42	46.00	-6.58	peak	H
719.6700	50.19	-5.62	44.57	46.00	-1.43	QP	H
960.2300	45.65	-2.23	43.42	54.00	-10.58	peak	H

Remark:

1. No emission found between lowest internal used/generated frequency to 30MHz (9kHz~30MHz).
2. Radiated emissions measured in frequency range from 30 MHz to 1000MHz were made with an instrument using peak/quasi-peak detector mode.
3. Quasi-peak test would be performed if the peak result were greater than the quasi-peak limit or as required by the applicant.
4. Measurements above show only up to 6 maximum emissions noted, or would be lesser, with " N/A " remark, if no specific emissions from the EUT are recorded (ie: margin>20dB from the applicable limit) and considered that's already beyond the background noise floor.
5. Margin (dB) = Remark result (dBuV/m) – Quasi-peak limit (dBuV/m).

Above 1 GHz

TX / IEEE 802.11a mode / CH Low

Polarity: Vertical

110.0 dBuV/m

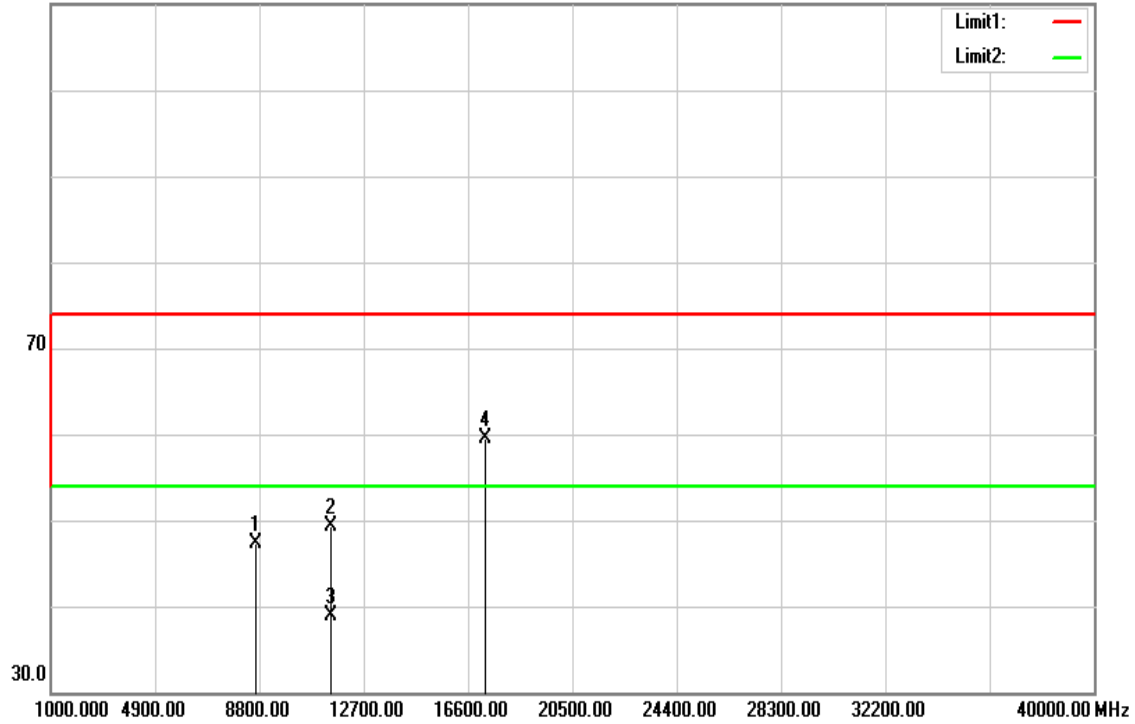

Polarity: Horizontal

110.0 dBuV/m

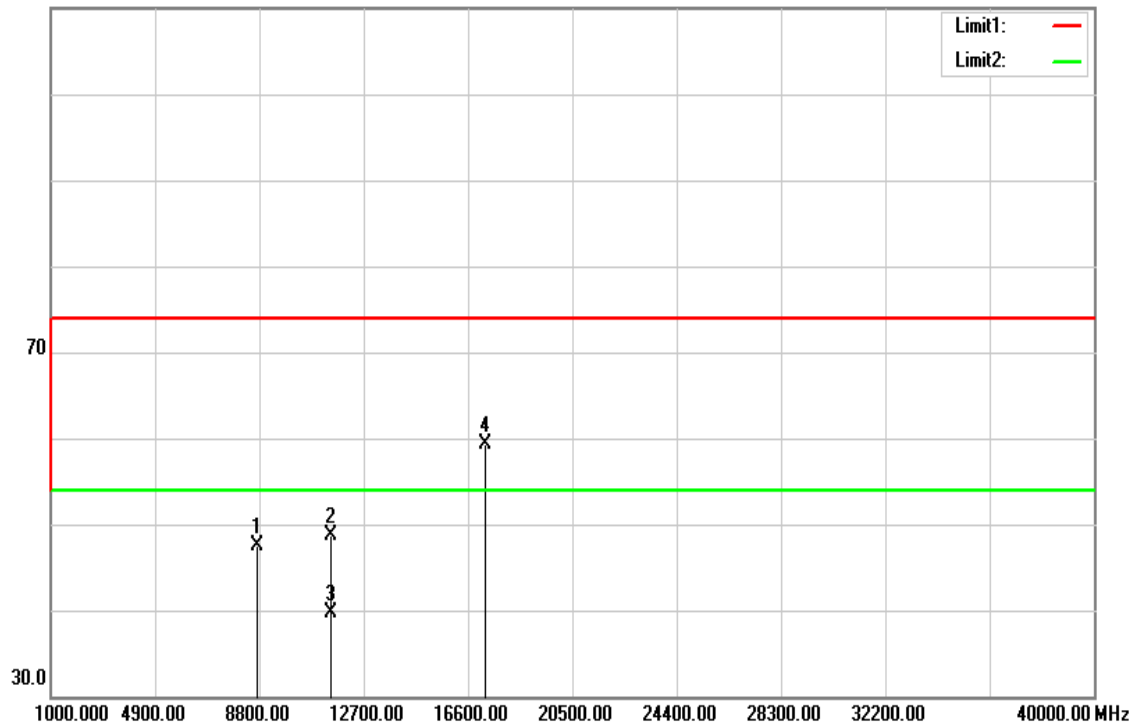

Operation Mode: TX / IEEE 802.11a mode / CH Low

Test Date: July 29, 2016

Temperature: 27°C

Tested by: Dennis Li

Humidity: 53% RH

Polarity: Ver. / Hor.

Frequency (MHz)	Reading (dBuV)	Correction (dB/m)	Result (dBuV/m)	Limit (dBuV/m)	Margin (dB)	Remark	Ant.Pol. (H/V)
8695.000	31.83	15.45	47.28	74.00	-26.72	peak	V
11490.000	31.05	18.16	49.21	74.00	-24.79	peak	V
11490.000	20.70	18.16	38.86	54.00	-15.14	AVG	V
17235.000	32.72	26.83	59.55	74.00	-14.45	peak	V
N/A							
8735.000	32.05	15.52	47.57	74.00	-26.43	peak	H
11490.000	30.62	18.16	48.78	74.00	-25.22	peak	H
11490.000	21.52	18.16	39.68	54.00	-14.32	AVG	H
17235.000	32.39	26.83	59.22	74.00	-14.78	peak	H
N/A							

Remark:

1. *Measuring frequencies from 1 GHz to the 10th harmonic of highest fundamental frequency.*
2. *Radiated emissions measured in frequency above 1000MHz were made with an instrument using peak/average detector mode.*
3. *Average test would be performed if the peak result were greater than the average limit.*
4. *Data of measurement within this frequency range shown " --- " in the table above means the reading of emissions are attenuated more than 20dB below the permissible limits or the field strength is too small to be measured.*
5. *Measurements above show only up to 6 maximum emissions noted, or would be lesser, with " N/A " remark, if no specific emissions from the EUT are recorded (ie: margin>20dB from the applicable limit) and considered that's already beyond the background noise floor.*
6. *Margin (dB) = Remark result (dBuV/m) – Average limit (dBuV/m).*

TX / IEEE 802.11a mode / CH Mid

Polarity: Vertical

110.0 dBuV/m

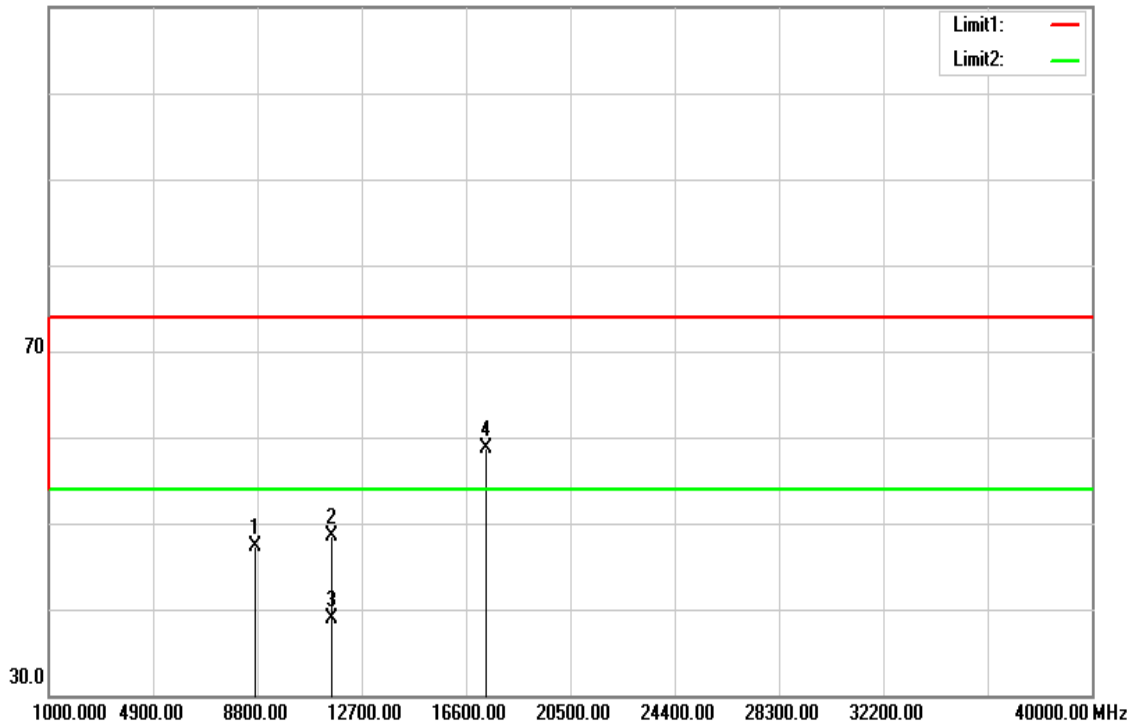

Polarity: Horizontal

110.0 dBuV/m

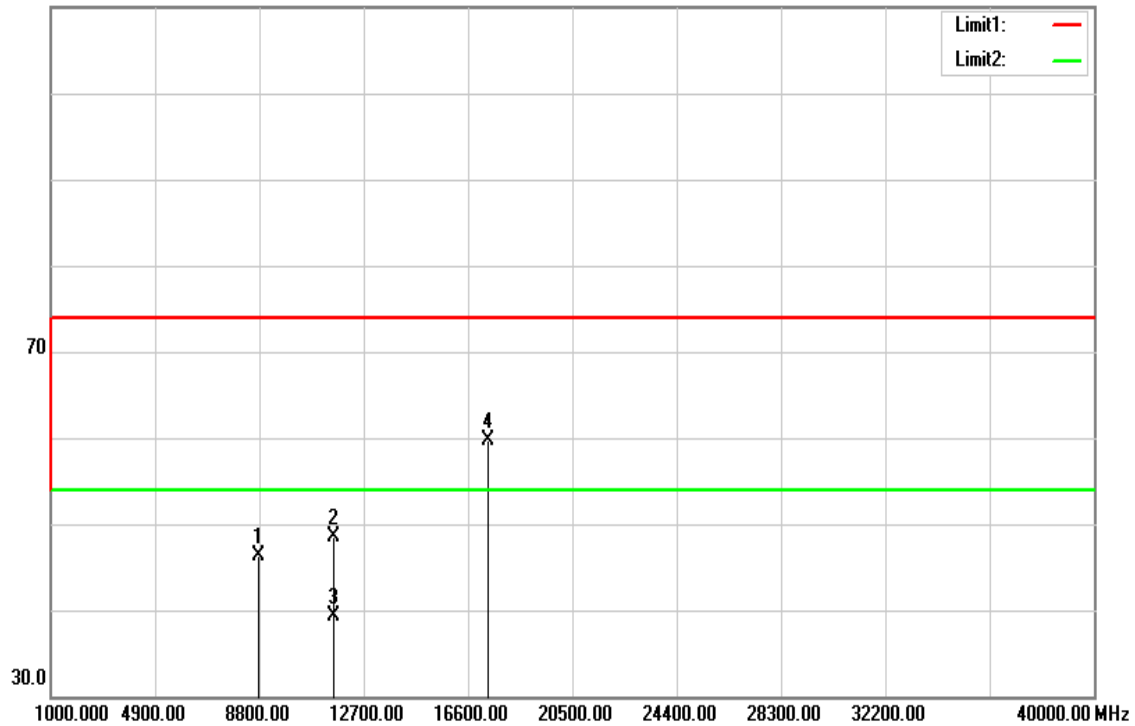

Operation Mode: TX / IEEE 802.11a mode / CH Mid

Test Date: July 29, 2016

Temperature: 27°C

Tested by: Dennis Li

Humidity: 53% RH

Polarity: Ver. / Hor.

Frequency (MHz)	Reading (dBuV)	Correction (dB/m)	Result (dBuV/m)	Limit (dBuV/m)	Margin (dB)	Remark	Ant.Pol. (H/V)
8715.000	33.52	13.74	47.26	74.00	-26.74	peak	V
11570.000	31.70	16.84	48.54	74.00	-25.46	peak	V
11570.000	22.02	16.84	38.86	54.00	-15.14	AVG	V
17355.000	33.00	25.75	58.75	74.00	-15.25	peak	V
N/A							
8795.000	32.52	13.78	46.30	74.00	-27.70	peak	H
11570.000	31.68	16.84	48.52	74.00	-25.48	peak	H
11570.000	22.41	16.84	39.25	54.00	-14.75	AVG	H
17355.000	33.97	25.75	59.72	74.00	-14.28	peak	H
N/A							

Remark:

1. *Measuring frequencies from 1 GHz to the 10th harmonic of highest fundamental frequency.*
2. *Radiated emissions measured in frequency above 1000MHz were made with an instrument using peak/average detector mode.*
3. *Average test would be performed if the peak result were greater than the average limit.*
4. *Data of measurement within this frequency range shown " --- " in the table above means the reading of emissions are attenuated more than 20dB below the permissible limits or the field strength is too small to be measured.*
5. *Measurements above show only up to 6 maximum emissions noted, or would be lesser, with " N/A " remark, if no specific emissions from the EUT are recorded (ie: margin>20dB from the applicable limit) and considered that's already beyond the background noise floor.*
6. *Margin (dB) = Remark result (dBuV/m) – Average limit (dBuV/m).*

TX / IEEE 802.11a mode / CH High

Polarity: Vertical

110.0 dBuV/m

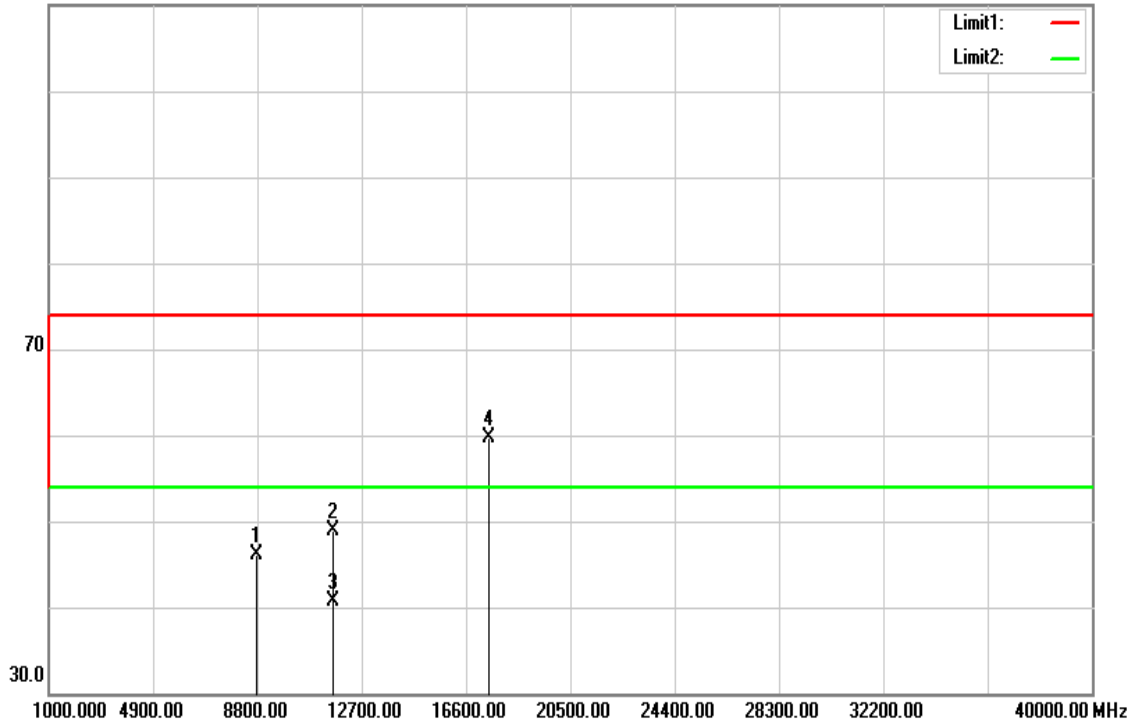

Polarity: Horizontal

110.0 dBuV/m

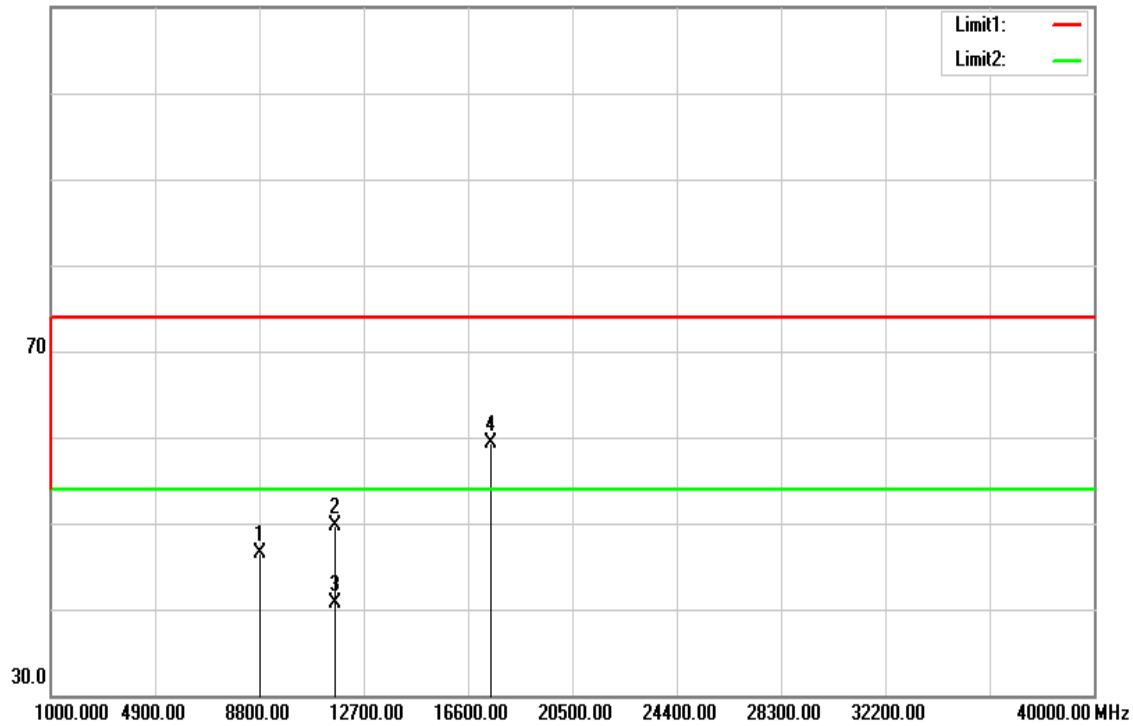

Operation Mode: TX / IEEE 802.11a mode / CH High

Test Date: July 29, 2016

Temperature: 27°C

Tested by: Dennis Li

Humidity: 53% RH

Polarity: Ver. / Hor.

Frequency (MHz)	Reading (dBuV)	Correction (dB/m)	Result (dBuV/m)	Limit (dBuV/m)	Margin (dB)	Remark	Ant.Pol. (H/V)
8777.000	32.25	13.77	46.02	74.00	-27.98	peak	V
11650.000	31.96	16.91	48.87	74.00	-25.13	peak	V
11650.000	23.77	16.91	40.68	54.00	-13.32	AVG	V
17475.000	33.45	26.22	59.67	74.00	-14.33	peak	V
N/A							
8815.000	32.81	13.78	46.59	74.00	-27.41	peak	H
11650.000	32.72	16.91	49.63	74.00	-24.37	peak	H
11650.000	23.77	16.91	40.68	54.00	-13.32	AVG	H
17475.000	33.12	26.22	59.34	74.00	-14.66	peak	H
N/A							

Remark:

1. Measuring frequencies from 1 GHz to the 10th harmonic of highest fundamental frequency.
2. Radiated emissions measured in frequency above 1000MHz were made with an instrument using peak/average detector mode.
3. Average test would be performed if the peak result were greater than the average limit.
4. Data of measurement within this frequency range shown " --- " in the table above means the reading of emissions are attenuated more than 20dB below the permissible limits or the field strength is too small to be measured.
5. Measurements above show only up to 6 maximum emissions noted, or would be lesser, with " N/A " remark, if no specific emissions from the EUT are recorded (ie: margin>20dB from the applicable limit) and considered that's already beyond the background noise floor.
6. Margin (dB) = Remark result (dBuV/m) – Average limit (dBuV/m).

TX / IEEE 802.11n HT 20 MHz mode / CH Low

Polarity: Vertical

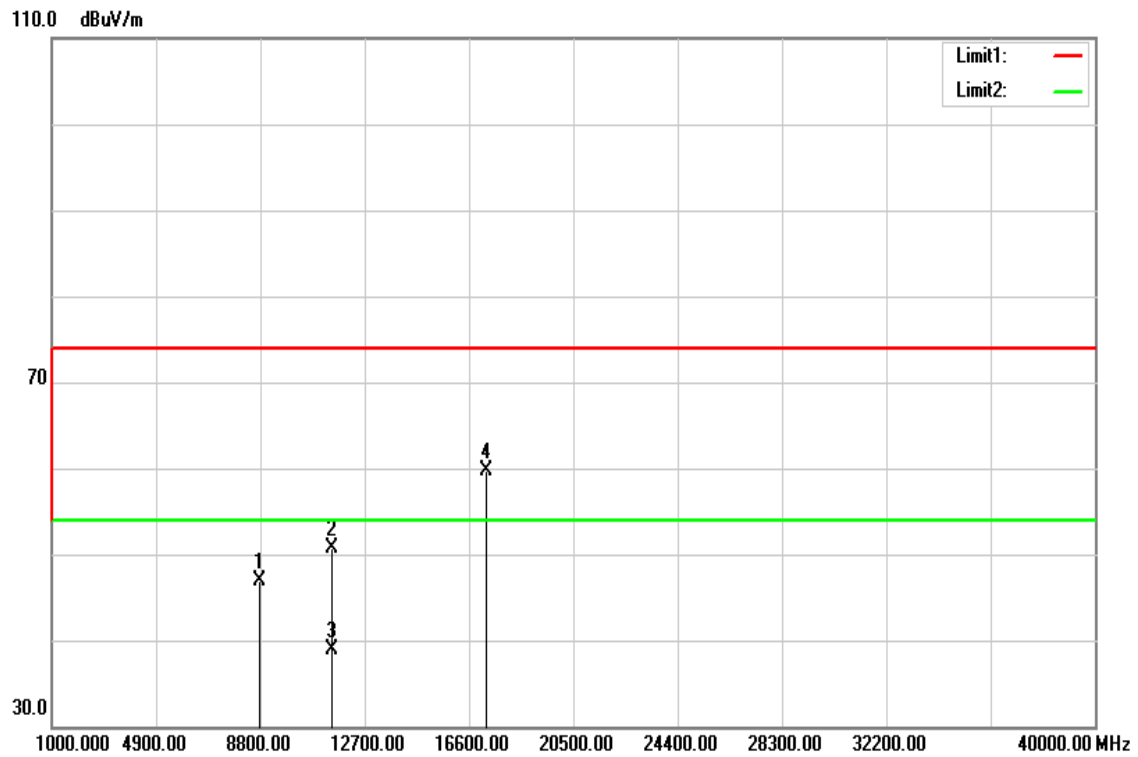

Polarity: Horizontal

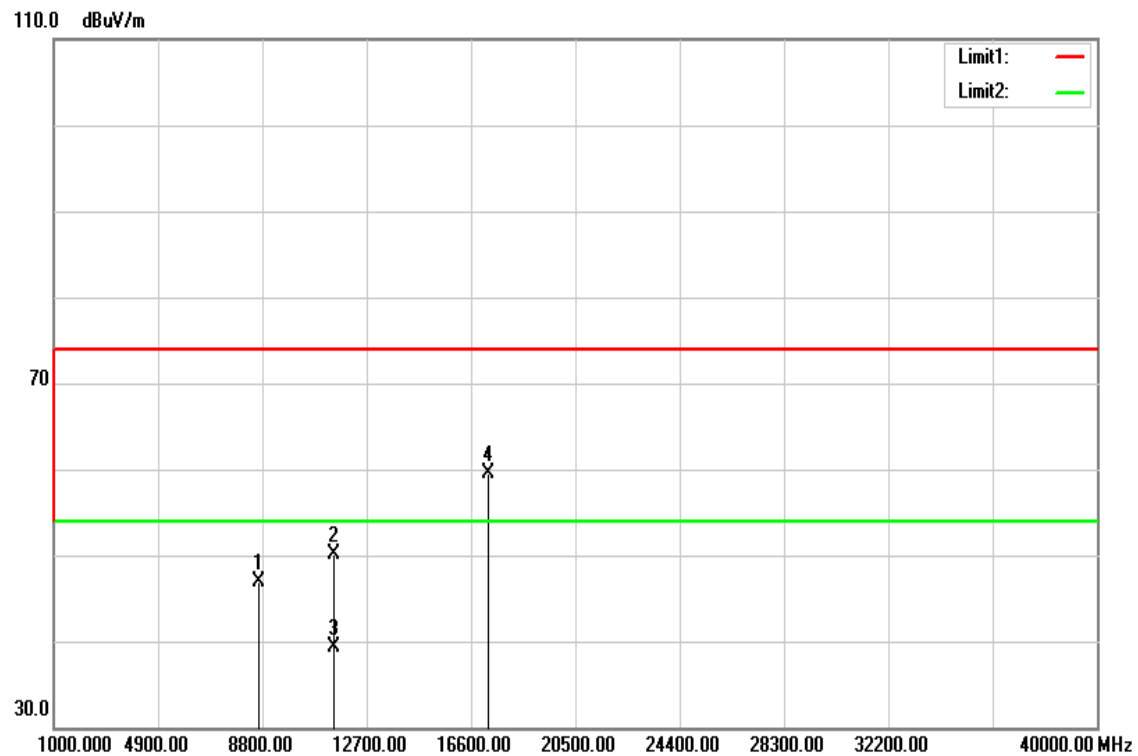

Operation Mode: TX / IEEE 802.11n HT 20 MHz mode / CH Low **Test Date:** July 29, 2016

Temperature: 27°C

Tested by: Dennis Li

Humidity: 53% RH

Polarity: Ver. / Hor.

Frequency (MHz)	Reading (dBuV)	Correction (dB/m)	Result (dBuV/m)	Limit (dBuV/m)	Margin (dB)	Remark	Ant.Pol. (H/V)
8756.000	33.20	13.76	46.96	74.00	-27.04	peak	V
11490.000	33.83	16.78	50.61	74.00	-23.39	peak	V
11490.000	22.14	16.78	38.92	54.00	-15.08	AVG	V
17235.000	34.52	25.28	59.80	74.00	-14.20	peak	V
N/A							
8692.000	33.20	13.73	46.93	74.00	-27.07	peak	H
11490.000	33.24	16.78	50.02	74.00	-23.98	peak	H
11490.000	22.57	16.78	39.35	54.00	-14.65	AVG	H
17235.000	34.23	25.28	59.51	74.00	-14.49	peak	H
N/A							

Remark:

1. Measuring frequencies from 1 GHz to the 10th harmonic of highest fundamental frequency.
2. Radiated emissions measured in frequency above 1000MHz were made with an instrument using peak/average detector mode.
3. Average test would be performed if the peak result were greater than the average limit or as required by the applicant.
4. Data of measurement within this frequency range shown " --- " in the table above means the reading of emissions are attenuated more than 20dB below the permissible limits or the field strength is too small to be measured.
5. Measurements above show only up to 6 maximum emissions noted, or would be lesser, with " N/A " remark, if no specific emissions from the EUT are recorded (ie: margin>20dB from the applicable limit) and considered that's already beyond the background noise floor.
6. Margin (dB) = Remark result (dBuV/m) – Average limit (dBuV/m).

TX / IEEE 802.11n HT 20 MHz mode / CH Mid

Polarity: Vertical

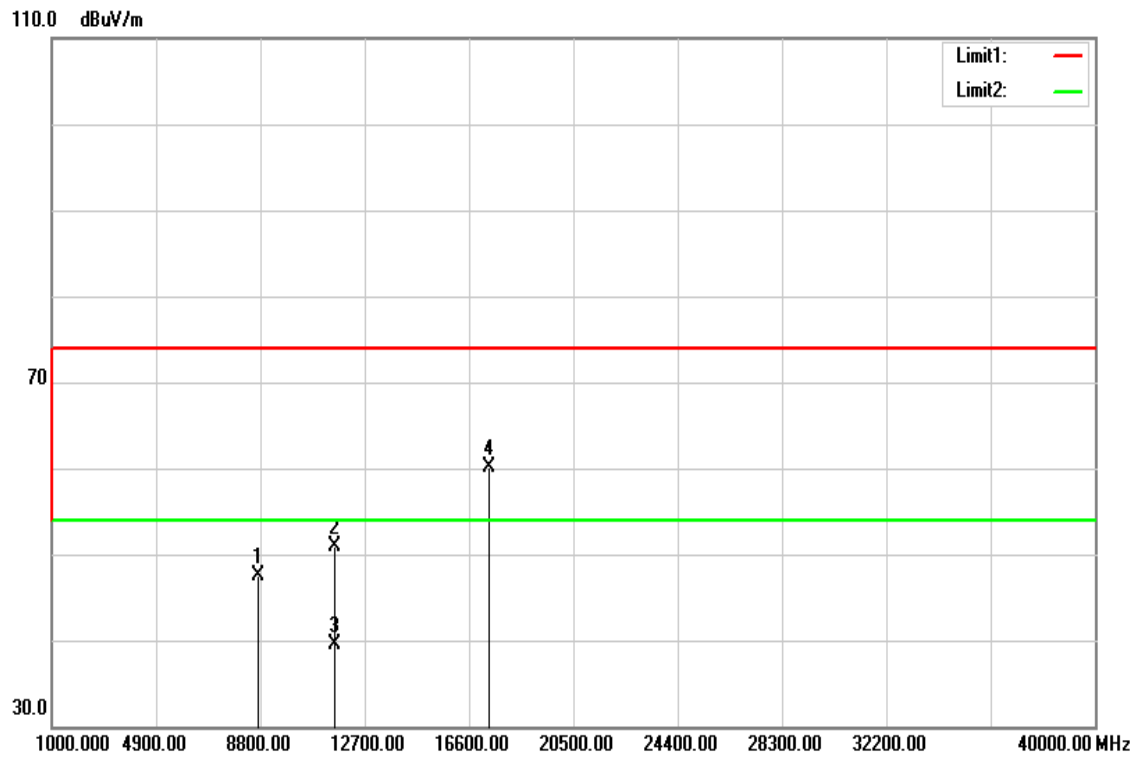

Polarity: Horizontal

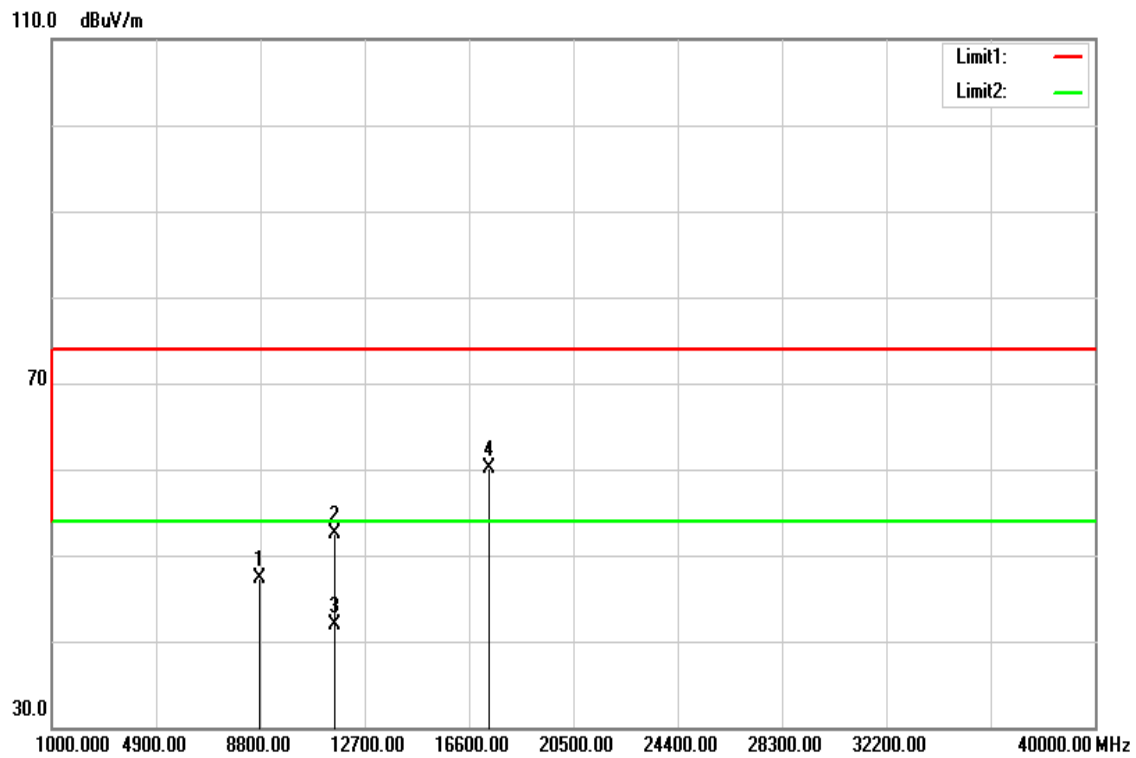

Operation Mode: TX / IEEE 802.11n HT 20 MHz mode / CH Mid **Test Date:** July 29, 2016

Temperature: 27°C

Tested by: Dennis Li

Humidity: 53% RH

Polarity: Ver. / Hor.

Frequency (MHz)	Reading (dBuV)	Correction (dB/m)	Result (dBuV/m)	Limit (dBuV/m)	Margin (dB)	Remark	Ant.Pol. (H/V)
8698.000	33.68	13.73	47.41	74.00	-26.59	peak	V
11570.000	34.12	16.84	50.96	74.00	-23.04	peak	V
11570.000	22.73	16.84	39.57	54.00	-14.43	AVG	V
17355.000	34.29	25.75	60.04	74.00	-13.96	peak	V
N/A							
8781.000	33.44	13.77	47.21	74.00	-26.79	peak	H
11570.000	35.59	16.84	52.43	74.00	-21.57	peak	H
11570.000	25.01	16.84	41.85	54.00	-12.15	AVG	H
17355.000	34.26	25.75	60.01	74.00	-13.99	peak	H
N/A							

Remark:

1. Measuring frequencies from 1 GHz to the 10th harmonic of highest fundamental frequency.
2. Radiated emissions measured in frequency above 1000MHz were made with an instrument using peak/average detector mode.
3. Average test would be performed if the peak result were greater than the average limit or as required by the applicant.
4. Data of measurement within this frequency range shown " --- " in the table above means the reading of emissions are attenuated more than 20dB below the permissible limits or the field strength is too small to be measured.
5. Measurements above show only up to 6 maximum emissions noted, or would be lesser, with " N/A " remark, if no specific emissions from the EUT are recorded (ie: margin>20dB from the applicable limit) and considered that's already beyond the background noise floor.
6. Margin (dB) = Remark result (dBuV/m) – Average limit (dBuV/m).

TX / IEEE 802.11n HT 20 MHz mode / CH High

Polarity: Vertical

110.0 dBuV/m

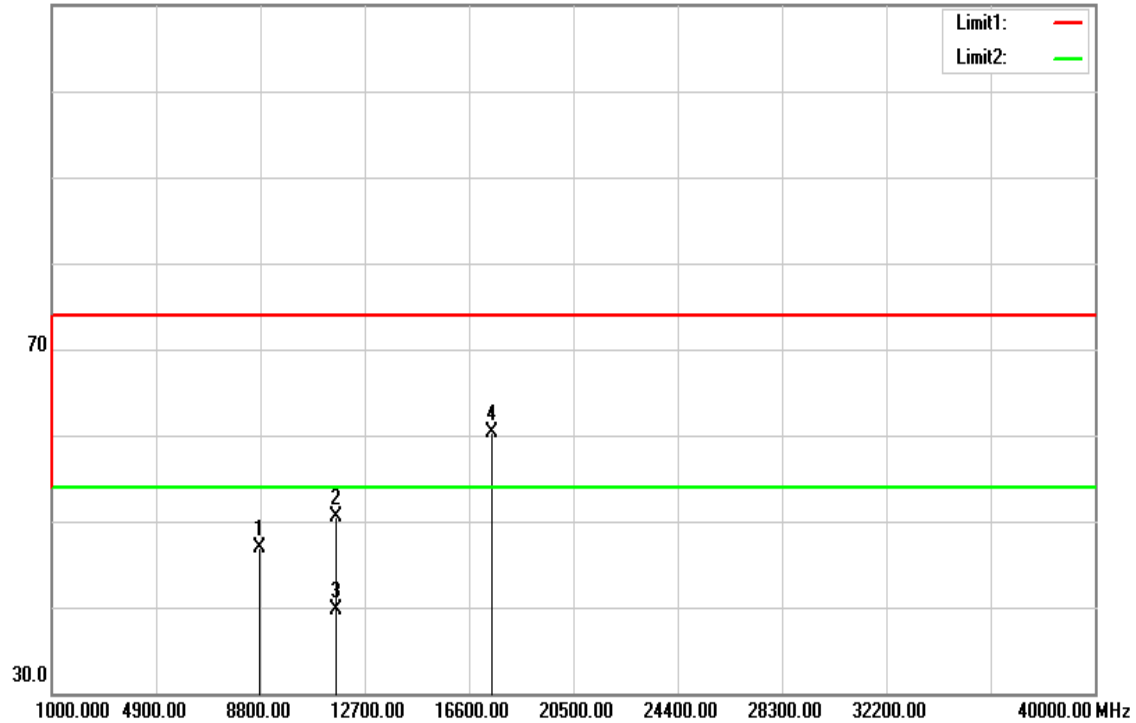

Polarity: Horizontal

110.0 dBuV/m

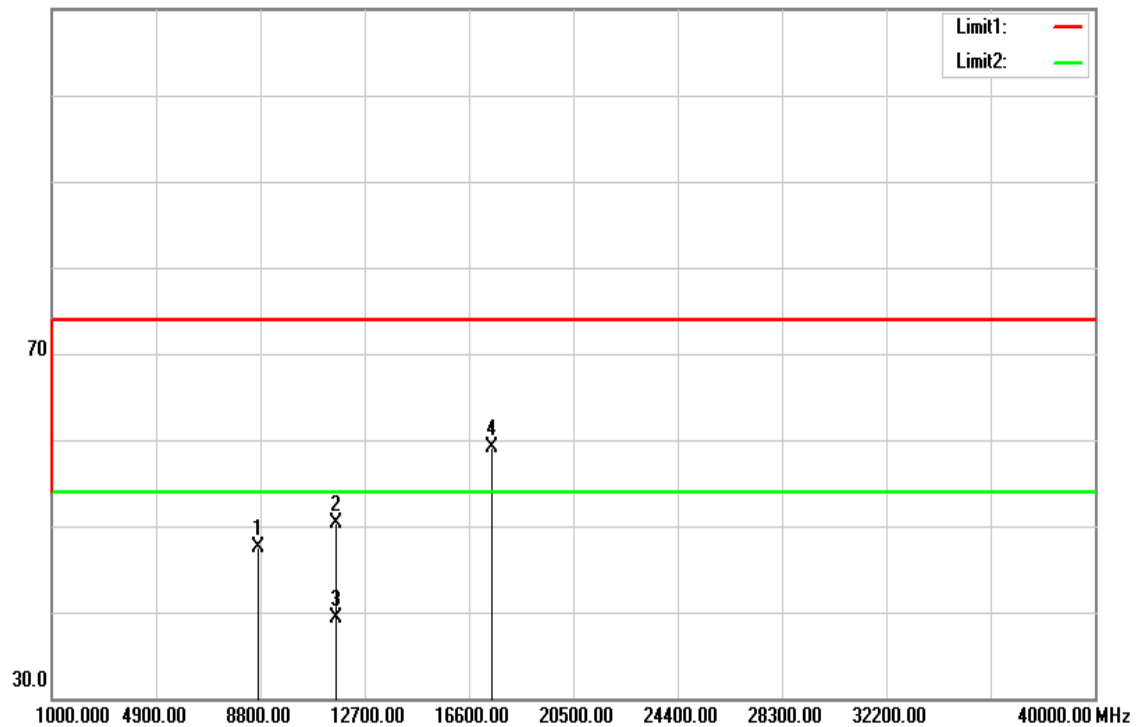

Operation Mode: TX / IEEE 802.11n HT 20 MHz mode / CH High **Test Date:** July 29, 2016

Temperature: 27°C

Tested by: Dennis Li

Humidity: 53% RH

Polarity: Ver. / Hor.

Frequency (MHz)	Reading (dBuV)	Correction (dB/m)	Result (dBuV/m)	Limit (dBuV/m)	Margin (dB)	Remark	Ant.Pol. (H/V)
8751.000	33.21	13.76	46.97	74.00	-27.03	peak	V
11650.000	33.53	16.91	50.44	74.00	-23.56	peak	V
11650.000	22.75	16.91	39.66	54.00	-14.34	AVG	V
17475.000	34.07	26.22	60.29	74.00	-13.71	peak	V
N/A							
8715.000	33.72	13.74	47.46	74.00	-26.54	peak	H
11650.000	33.41	16.91	50.32	74.00	-23.68	peak	H
11650.000	22.40	16.91	39.31	54.00	-14.69	AVG	H
17475.000	32.88	26.22	59.10	74.00	-14.90	peak	H
N/A							

Remark:

1. Measuring frequencies from 1 GHz to the 10th harmonic of highest fundamental frequency.
2. Radiated emissions measured in frequency above 1000MHz were made with an instrument using peak/average detector mode.
3. Average test would be performed if the peak result were greater than the average limit or as required by the applicant.
4. Data of measurement within this frequency range shown " --- " in the table above means the reading of emissions are attenuated more than 20dB below the permissible limits or the field strength is too small to be measured.
5. Measurements above show only up to 6 maximum emissions noted, or would be lesser, with " N/A " remark, if no specific emissions from the EUT are recorded (ie: margin>20dB from the applicable limit) and considered that's already beyond the background noise floor.
6. Margin (dB) = Remark result (dBuV/m) – Average limit (dBuV/m).

TX / IEEE 802.11n HT 40 MHz mode / CH Low

Polarity: Vertical

110.0 dBuV/m

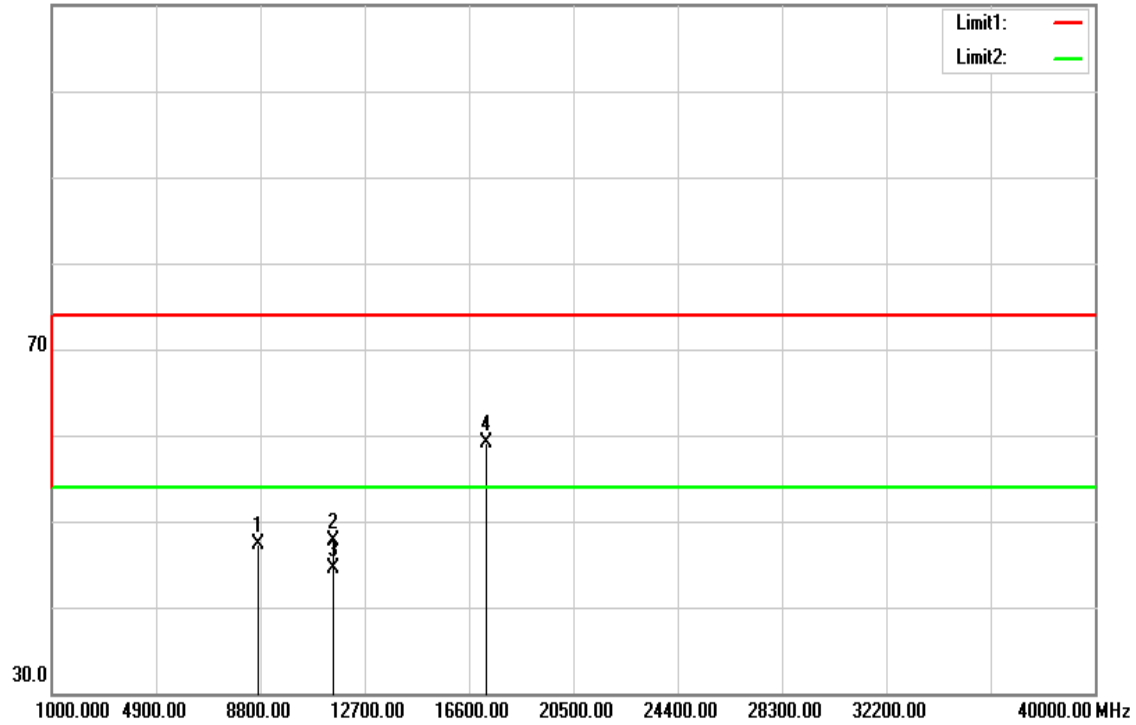

Polarity: Horizontal

110.0 dBuV/m

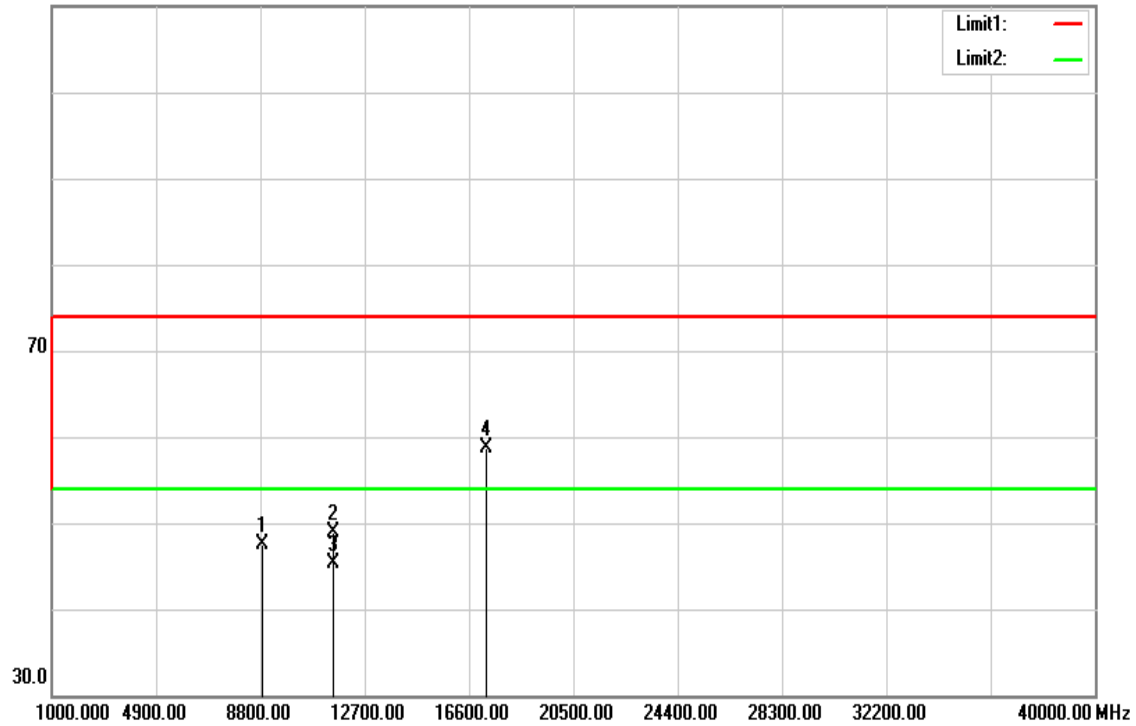

Operation Mode: TX / IEEE 802.11n HT 40 MHz mode / CH Low **Test Date:** July 29, 2016

Temperature: 27°C

Tested by: Dennis Li

Humidity: 53% RH

Polarity: Ver. / Hor.

Frequency (MHz)	Reading (dBuV)	Correction (dB/m)	Result (dBuV/m)	Limit (dBuV/m)	Margin (dB)	Remark	Ant.Pol. (H/V)
8698.000	33.60	13.73	47.33	74.00	-26.67	peak	V
11510.000	30.90	16.79	47.69	74.00	-26.31	peak	V
11510.000	27.72	16.79	44.51	54.00	-9.49	AVG	V
17265.000	33.69	25.40	59.09	74.00	-14.91	peak	V
N/A							
8857.000	33.69	13.80	47.49	74.00	-26.51	peak	H
11510.000	32.03	16.79	48.82	74.00	-25.18	peak	H
11510.000	28.49	16.79	45.28	54.00	-8.72	AVG	H
17265.000	33.38	25.40	58.78	74.00	-15.22	peak	H
N/A							

Remark:

1. Measuring frequencies from 1 GHz to the 10th harmonic of highest fundamental frequency.
2. Radiated emissions measured in frequency above 1000MHz were made with an instrument using peak/average detector mode.
3. Average test would be performed if the peak result were greater than the average limit or as required by the applicant.
4. Data of measurement within this frequency range shown " --- " in the table above means the reading of emissions are attenuated more than 20dB below the permissible limits or the field strength is too small to be measured.
5. Measurements above show only up to 6 maximum emissions noted, or would be lesser, with " N/A " remark, if no specific emissions from the EUT are recorded (ie: margin>20dB from the applicable limit) and considered that's already beyond the background noise floor.
6. Margin (dB) = Remark result (dBuV/m) – Average limit (dBuV/m).

TX / IEEE 802.11n HT 40 MHz mode / CH High

Polarity: Vertical

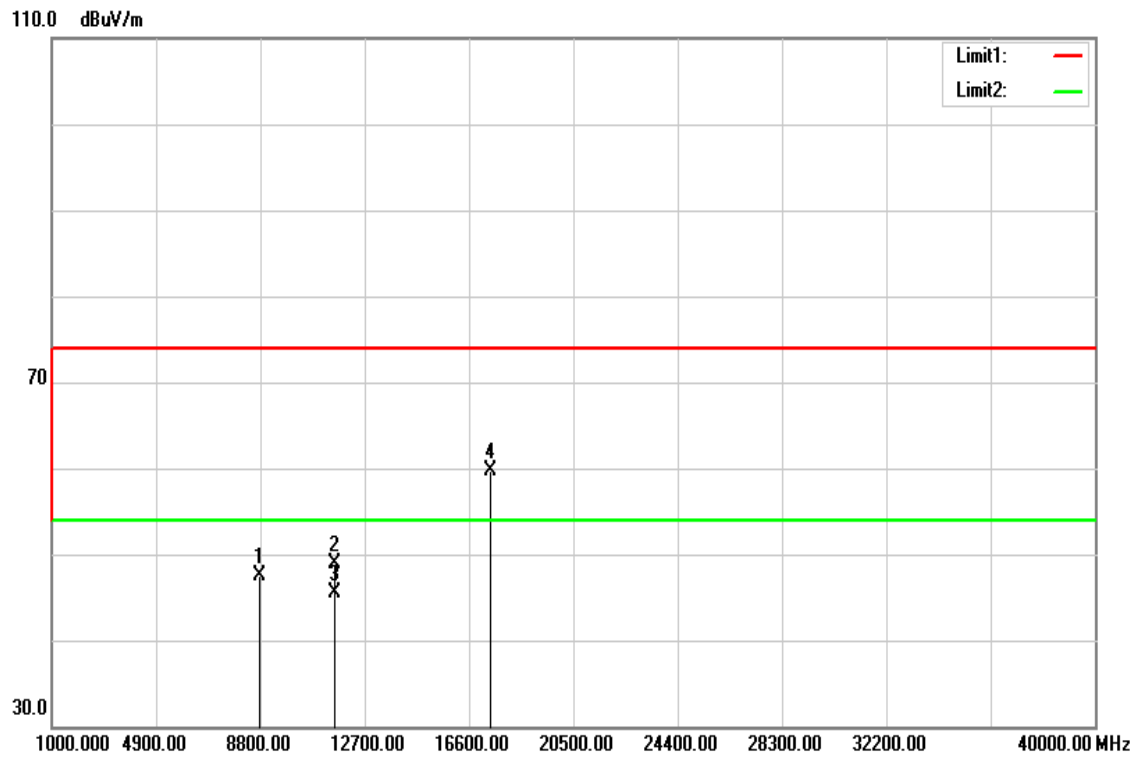

Polarity: Horizontal

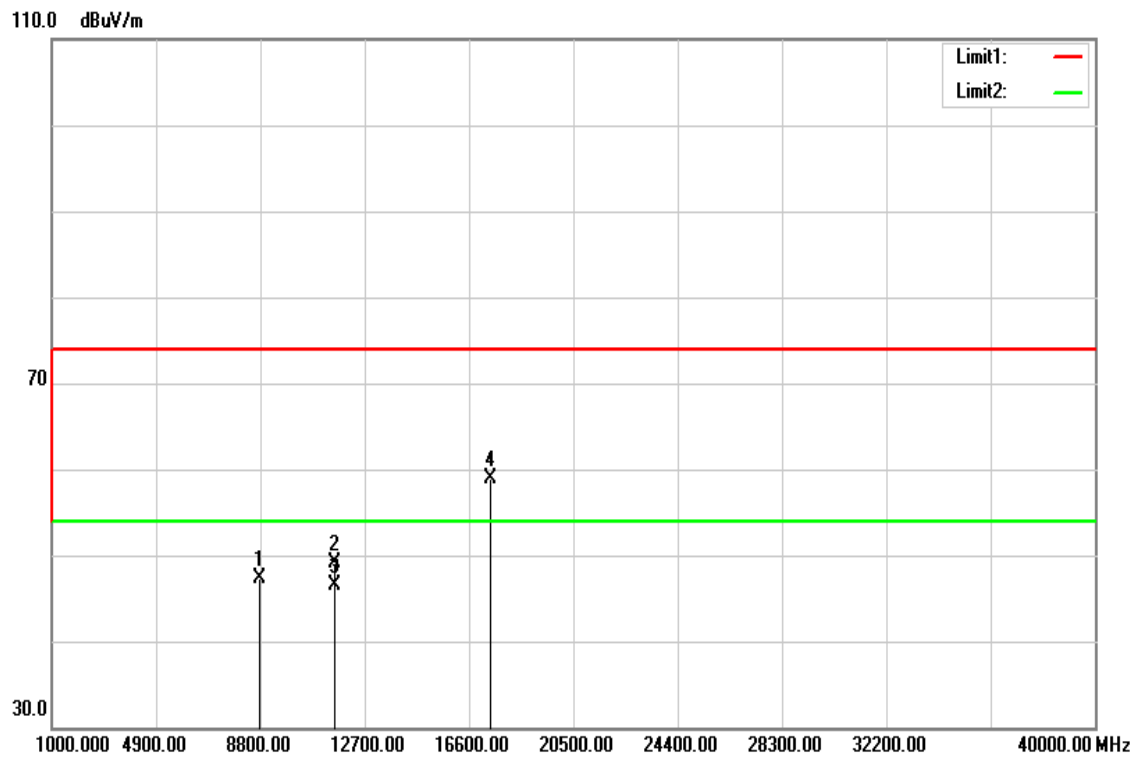

Operation Mode: TX / IEEE 802.11n HT 40 MHz mode / CH High **Test Date:** July 29, 2016

Temperature: 27°C

Tested by: Dennis Li

Humidity: 53% RH

Polarity: Ver. / Hor.

Frequency (MHz)	Reading (dBuV)	Correction (dB/m)	Result (dBuV/m)	Limit (dBuV/m)	Margin (dB)	Remark	Ant.Pol. (H/V)
8751.000	33.79	13.76	47.55	74.00	-26.45	peak	V
11590.000	32.12	16.86	48.98	74.00	-25.02	peak	V
11590.000	28.71	16.86	45.57	54.00	-8.43	AVG	V
17385.000	33.90	25.87	59.77	74.00	-14.23	peak	V
N/A							
8789.000	33.47	13.77	47.24	74.00	-26.76	peak	H
11590.000	32.27	16.86	49.13	74.00	-24.87	peak	H
11590.000	29.72	16.86	46.58	54.00	-7.42	AVG	H
17385.000	33.04	25.87	58.91	74.00	-15.09	peak	H
N/A							

Remark:

1. Measuring frequencies from 1 GHz to the 10th harmonic of highest fundamental frequency.
2. Radiated emissions measured in frequency above 1000MHz were made with an instrument using peak/average detector mode.
3. Average test would be performed if the peak result were greater than the average limit or as required by the applicant.
4. Data of measurement within this frequency range shown " --- " in the table above means the reading of emissions are attenuated more than 20dB below the permissible limits or the field strength is too small to be measured.
5. Measurements above show only up to 6 maximum emissions noted, or would be lesser, with " N/A " remark, if no specific emissions from the EUT are recorded (ie: margin>20dB from the applicable limit) and considered that's already beyond the background noise floor.
6. $Margin (dB) = Remark\ result (dBuV/m) - Average\ limit (dBuV/m)$.

7.7 POWERLINE CONDUCTED EMISSIONS

LIMIT

According to §15.207(a) & RSS-Gen §7.2.4, except when the requirements applicable to a given device state otherwise, for any licence-exempt radiocommunication device equipped to operate from the public utility AC power supply, either directly or indirectly, the radio frequency voltage that is conducted back onto the AC power lines in the frequency range of 0.15 MHz to 30 MHz shall not exceed the limits shown in Table 2.

The tighter limit applies at the frequency range boundaries.

The conducted emissions shall be measured with a 50 ohm/50 microhenry line impedance stabilization network.

RSS-Gen Table 2 – AC Power Lines Conducted Emission Limits

Frequency Range (MHz)	Conducted limit (dBµV)	
	Quasi-peak	Average
0.15 to 0.5	66 to 56*	56 to 46*
0.5 to 5	56	46
5 to 30	60	50

**Decreases with the logarithm of the frequency*

Test Configuration

See test photographs attached in Appendix 1 for the actual connections between EUT and support equipment.

TEST PROCEDURE

1. The EUT was placed on a table, which is 0.8m above ground plane.
2. Maximum procedure was performed on the six highest emissions to ensure EUT compliance.
3. Repeat above procedures until all frequency measured were complete.

TEST RESULTS

The initial step in collecting conducted data is a spectrum analyzer peak scan of the measurement range. Significant peaks are then marked as shown on the following data page, and these signals are then quasi-peaked.

Test Data

Operation Mode: Normal Link **Test Date:** July 29, 2016
Temperature: 24°C **Tested by:** Dennis Li
Humidity: 50% RH

Freq. (MHz)	QP Reading (dBuV)	AV Reading (dBuV)	Corr. factor (dB/m)	QP Result (dBuV/m)	AV Result (dBuV/m)	QP Limit (dBuV)	AV Limit (dBuV)	QP Margin (dB)	AV Margin (dB)	Note
0.2980	34.68	32.56	9.70	44.38	42.26	60.30	50.30	-15.92	-8.04	L1
0.5220	29.73	27.95	9.70	39.43	37.65	56.00	46.00	-16.57	-8.35	L1
0.5940	32.30	28.61	9.70	42.00	38.31	56.00	46.00	-14.00	-7.69	L1
0.6300	26.53	20.96	9.70	36.23	30.66	56.00	46.00	-19.77	-15.34	L1
0.9300	23.86	15.28	9.71	33.57	24.99	56.00	46.00	-22.43	-21.01	L1
1.4620	27.01	24.58	9.72	36.73	34.30	56.00	46.00	-19.27	-11.70	L1
0.1539	31.19	19.05	9.78	40.97	28.83	65.78	55.79	-24.81	-26.96	L2
0.2980	35.15	34.15	9.77	44.92	43.92	60.30	50.30	-15.38	-6.38	L2
0.3379	26.59	18.89	9.76	36.35	28.65	59.25	49.25	-22.90	-20.60	L2
0.5980	30.64	26.55	9.76	40.40	36.31	56.00	46.00	-15.60	-9.69	L2
0.9300	26.63	18.84	9.76	36.39	28.60	56.00	46.00	-19.61	-17.40	L2
1.4340	22.30	14.17	9.77	32.07	23.94	56.00	46.00	-23.93	-22.06	L2

Remark:

1. Measuring frequencies from 0.15 MHz to 30MHz.
2. The emissions measured in frequency range from 0.15 MHz to 30MHz were made with an instrument using Quasi-peak detector and average detector.
3. The IF bandwidth of SPA between 0.15MHz to 30MHz was 10kHz; the IF bandwidth of Test Receiver between 0.15MHz to 30MHz was 9kHz;
4. L1 = Line One (Live Line) / L2 = Line Two (Neutral Line)

Test Plots

Conducted emissions (Line 1)

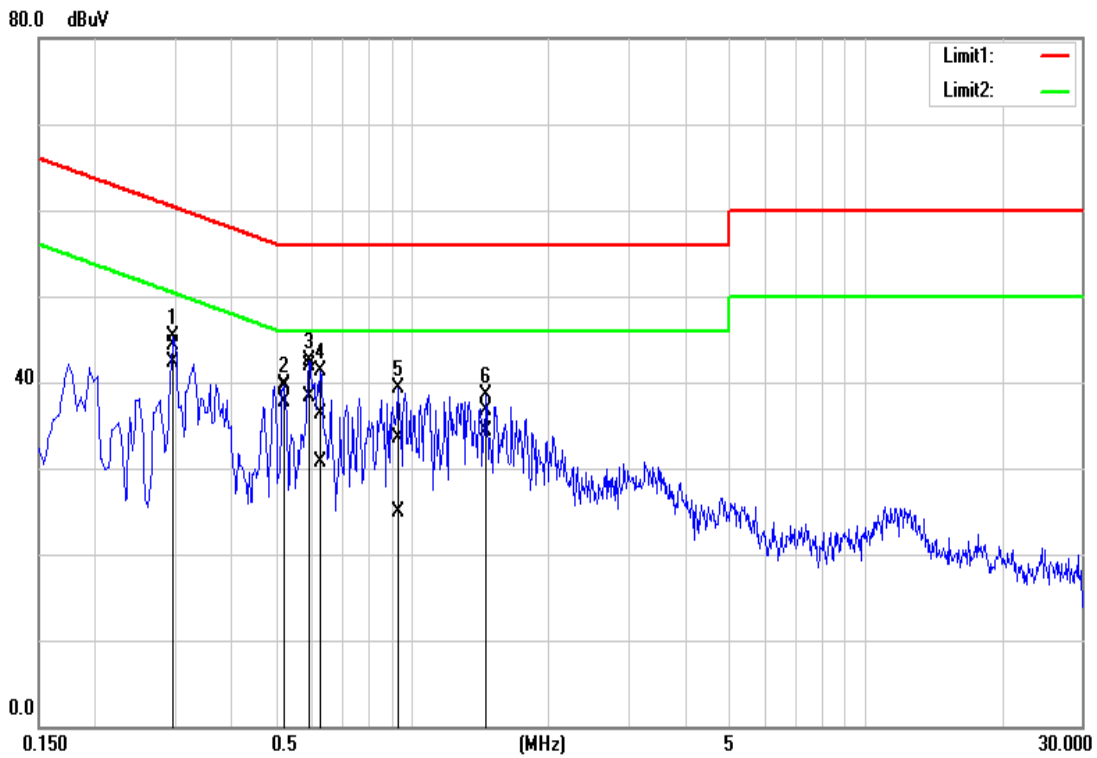

Conducted emissions (Line 2)

