

**FCC 47 CFR PART 15 SUBPART C &
INDUSTRY CANADA RSS-247**

TEST REPORT

For

Wi-Fi (11a/b/g/n 2Tx2R)+BT (V4.2LE) USB Combo Module

Model: WCBN4513R

Trade Name: LITE-ON

Issued to

**Lite-On Technology Corp.
Bldg. C, 90, Chien 1 Road, Chung Ho, New Taipei City 23585, Taiwan,
R.O.C**

Issued by

**Compliance Certification Services Inc.
No.11, Wugong 6th Rd., Wugu Dist.,
New Taipei City 24891, Taiwan. (R.O.C.)
<http://www.ccsrf.com>
service@ccsrf.com
Issued Date: August 11, 2016**



Note: This report shall not be reproduced except in full, without the written approval of Compliance Certification Services Inc. This document may be altered or revised by Compliance Certification Services Inc. personnel only, and shall be noted in the revision section of the document.

Revision History

Rev.	Issue Date	Revisions	Effect Page	Revised By
00	August 11, 2016	Initial Issue	ALL	Doris Chu

TABLE OF CONTENTS

1. TEST RESULT CERTIFICATION	4
2. EUT DESCRIPTION.....	5
3. TEST METHODOLOGY.....	6
3.1 EUT CONFIGURATION	6
3.2 EUT EXERCISE	6
3.3 GENERAL TEST PROCEDURES.....	6
3.4 FCC PART 15.205 RESTRICTED BANDS OF OPERATIONS	7
3.5 DESCRIPTION OF TEST MODES.....	8
3.6 THE WORST CASE POWER SETTING PARAMETER	9
4. INSTRUMENT CALIBRATION	10
4.1 MEASURING INSTRUMENT CALIBRATION	10
4.2 MEASUREMENT EQUIPMENT USED	10
4.3 MEASUREMENT UNCERTAINTY.....	11
5. FACILITIES AND ACCREDITATIONS	12
5.1 FACILITIES	12
5.2 EQUIPMENT	12
5.3 LABORATORY ACCREDITATIONS AND LISTING.....	12
5.4 TABLE OF ACCREDITATIONS AND LISTINGS.....	13
6. SETUP OF EQUIPMENT UNDER TEST	14
6.1 SETUP CONFIGURATION OF EUT	14
6.2 SUPPORT EQUIPMENT.....	14
7. FCC PART 15.247 REQUIREMENTS & RSS-247 REQUIREMENTS.....	15
7.1 99% BANDWIDTH	15
7.2 6DB BANDWIDTH.....	29
7.3 PEAK POWER	43
7.4 AVERAGE POWER	45
7.5 BAND EDGES MEASUREMENT	47
7.6 PEAK POWER SPECTRAL DENSITY	81
7.7 RADIATED EMISSIONS	95
7.8 POWERLINE CONDUCTED EMISSIONS.....	125
APPENDIX II PHOTOGRAPHS OF TEST SETUP	128

1. TEST RESULT CERTIFICATION

Applicant: Lite-On Technology Corp.
Bldg. C, 90, Chien 1 Road, Chung Ho, New Taipei City 23585,
Taiwan, R.O.C

Manufacturer: LITE-ON TECHNOLOGY (Changzhou) CO., LTD
A9 Building, No.88 Yanghu Road, Wujin Hi-Tech Industrial
Development Zone, Changzhou City,
Jiangsu Province 213100 China

Equipment Under Test: Wi-Fi (11a/b/g/n 2Tx2R)+BT (V4.2LE) USB Combo Module

Model Number: WCBN4513R

Trade Name: LITE-ON

Date of Test: July 29 ~ August 5, 2016

APPLICABLE STANDARDS	
STANDARD	TEST RESULT
FCC 47 CFR Part 15 Subpart C Industry Canada RSS-247 Issue 1	No non-compliance noted

We hereby certify that:

The above equipment was tested by Compliance Certification Services Inc. The test data, data evaluation, test procedures, and equipment configurations shown in this report were made in accordance with the procedures given in ANSI C63.10: 2013 and the energy emitted by the sample EUT tested as described in this report is in compliance with the requirements of FCC Rules Part 15.207, 15.209, 15.247 and Industry Canada RSS-247.

The test results of this report relate only to the tested sample EUT identified in this report.

Approved by:

Tested by:



Miller Lee
Manager
Compliance Certification Services Inc.

Dennis Li
Engineer
Compliance Certification Services Inc.

2. EUT DESCRIPTION

Product	Wi-Fi (11a/b/g/n 2Tx2R)+BT (V4.2LE) USB Combo Module			
Model Number	WCBN4513R			
Trade Name	LITE-ON			
Model Discrepancy	N/A			
Received Date	June 25, 2016			
Power supply	Power form host device.			
Frequency Range	2412 ~ 2462 MHz			
Transmit Power	Mode	Frequency Range	Output Power (dBm)	Output Power (W)
	IEEE 802.11b	2412 - 2462	21.64	0.1459
	IEEE 802.11g	2412 - 2462	24.86	0.3062
	IEEE 802.11n HT 20 MHz	2412 - 2462	28.48	0.7047
	IEEE 802.11n HT 40 MHz	2422 - 2452	23.49	0.2234
Number of Channels	IEEE 802.11b/g mode: 11 Channels IEEE 802.11n HT 20 MHz mode: 11 Channels IEEE 802.11n HT 40 MHz mode: 7 Channels			
Antenna Specification	Walsin / RFMTA200700NNLB002 PIFA Antenna Ant0: Gain: 1.63dBi Ant1: Gain: 2.49dBi			
Product SW/HW version	SW: V1.0.3.19 HW: V01			
Radio SW version	SW: V1.0.3.19			
Radio HW version	HW: V01			

Remark:

1. The sample selected for test was engineering sample that approximated to production product and was provided by manufacturer.
2. This submittal(s) (test report) is intended for FCC ID: **PPQ-WCBN4513R** & ISED No. : **4491A-WCBN4513R** filing to comply with FCC Part 15C, Section 15.207, 15.209 and IC RSS-247 & RSS-GEN.

3. TEST METHODOLOGY

The tests documented in this report were performed in accordance with ANSI C63.10: 2013 and FCC CFR 47 Part 15.207, 15.209, 15.247, KDB 558074 D01 DTS Meas Guidance v03r05

The tests documented in this report were performed in accordance with IC RSS-247, IC RSS-Gen and ANSI C63.10:2013.

This submittal(s) (test report) is intended for IC Certification with Industry Canada RSS-247.

3.1 EUT CONFIGURATION

The EUT configuration for testing is installed on RF field strength measurement to meet the Commissions requirement and operating in a manner that intends to maximize its emission characteristics in a continuous normal application.

3.2 EUT EXERCISE

The EUT was operated in the engineering mode to fix the TX frequency that was for the purpose of the measurements.

According to its specifications, the EUT must comply with the requirements of the Section 15.207, 15.209 and 15.247 under the FCC Rules Part 15 Subpart C.

The tests documented in this report were performed in accordance with IC RSS-247, IC RSS-Gen, and ANSI C63.10: 2013.

3.3 GENERAL TEST PROCEDURES

Conducted Emissions

According to the requirements in ANSI C63.10: 2013 Conducted emissions from the EUT measured in the frequency range between 0.15 MHz and 30MHz using CISPR Quasi-peak and average detector modes.

Radiated Emissions

The EUT is placed on a turn table, which is 1.5 m above ground plane. The turntable shall rotate 360 degrees to determine the position of maximum emission level. EUT is set 3m away from the receiving antenna, which varied from 1m to 4m to find out the highest emission. And also, each emission was to be maximized by changing the polarization of receiving antenna both horizontal and vertical. In order to find out the maximum emissions, exploratory radiated emission measurements were made according to the requirements in ANSI C63.10: 2013.

3.4 FCC PART 15.205 RESTRICTED BANDS OF OPERATIONS

(a) Except as shown in paragraph (d) of this section, only spurious emissions are permitted in any of the frequency bands listed below:

MHz	MHz	MHz	GHz
0.090 - 0.110	16.42 - 16.423	399.9 - 410	4.5 - 5.15
¹ 0.495 - 0.505	16.69475 - 16.69525	608 - 614	5.35 - 5.46
2.1735 - 2.1905	16.80425 - 16.80475	960 - 1240	7.25 - 7.75
4.125 - 4.128	25.5 - 25.67	1300 - 1427	8.025 - 8.5
4.17725 - 4.17775	37.5 - 38.25	1435 - 1626.5	9.0 - 9.2
4.20725 - 4.20775	73 - 74.6	1645.5 - 1646.5	9.3 - 9.5
6.215 - 6.218	74.8 - 75.2	1660 - 1710	10.6 - 12.7
6.26775 - 6.26825	108 - 121.94	1718.8 - 1722.2	13.25 - 13.4
6.31175 - 6.31225	123 - 138	2200 - 2300	14.47 - 14.5
8.291 - 8.294	149.9 - 150.05	2310 - 2390	15.35 - 16.2
8.362 - 8.366	156.52475 -	2483.5 - 2500	17.7 - 21.4
8.37625 - 8.38675	156.52525	2655 - 2900	22.01 - 23.12
8.41425 - 8.41475	156.7 - 156.9	3260 - 3267	23.6 - 24.0
12.29 - 12.293	162.0125 - 167.17	3332 - 3339	31.2 - 31.8
12.51975 - 12.52025	167.72 - 173.2	3345.8 - 3358	36.43 - 36.5
12.57675 - 12.57725	240 - 285	3600 - 4400	(²)
13.36 - 13.41	322 - 335.4		

¹ Until February 1, 1999, this restricted band shall be 0.490-0.510 MHz.

² Above 38.6

(b) Except as provided in paragraphs (d) and (e), the field strength of emissions appearing within these frequency bands shall not exceed the limits shown in Section 15.209. At frequencies equal to or less than 1000 MHz, compliance with the limits in Section 15.209 shall be demonstrated using measurement instrumentation employing a CISPR quasi-peak detector. Above 1000 MHz, compliance with the emission limits in Section 15.209 shall be demonstrated based on the average value of the measured emissions. The provisions in Section 15.35 apply to these measurements.

3.5 DESCRIPTION OF TEST MODES

The EUT (model: WCBN4513R) had been tested under operating condition.

The EUT is a 2x2 configuration spatial MIMO (2Tx & 2Rx) without beam forming function that operate in double TX chains and double RX chains. The 2x2 configuration is implemented with two outside TX & RX chains (Chain 0 and 1).

Software used to control the EUT for staying in continuous transmitting and receiving mode was programmed.

After verification, all tests carried out are with the worst-case test modes as shown below except radiated spurious emission below 1GHz and power line conducted emissions below 30MHz, which worst case was in normal link mode and receiving radiated spurious emission above 1GHz, which worst case was in CH Mid mode only.

IEEE 802.11b mode:

Channel Low (2412MHz), Channel Mid (2437MHz) and Channel High (2462MHz) with 1Mbps data rate were chosen for full testing.

IEEE 802.11g mode:

Channel Low (2412MHz), Channel Mid (2437MHz) and Channel High (2462MHz) with 6Mbps data rate were chosen for full testing.

IEEE 802.11n HT 20 MHz mode:

Channel Low (2412MHz), Channel Mid (2437MHz) and Channel High (2462MHz) with 6.5Mbps data rate were chosen for full testing.

IEEE 802.11n HT 40 MHz mode:

Channel Low (2422MHz), Channel Mid (2437MHz) and Channel High (2452MHz) with 13.5Mbps data rate were chosen for full testing.

The field strength of spurious emission was measured in the following position: EUT stand-up position (Z axis), lie-down position (X, Y axis). The worst emission was found in lie-down position (X axis) and the worst case was recorded.

3.6 THE WORST CASE POWER SETTING PARAMETER

IEEE 802.11b mode

Channel	Frequency (MHz)	RF power setting in TEST SW
Low	2412	21
Mid	2437	23
High	2462	21

IEEE 802.11g mode

Channel	Frequency (MHz)	RF power setting in TEST SW
Low	2412	1F
Mid	2437	3F
High	2462	1E

IEEE 802.11n HT 20 MHz mode

Channel	Frequency (MHz)	RF power setting in TEST SW (Chin 0)	RF power setting in TEST SW (Chin 1)
Low	2412	15	15
Mid	2437	29	29
High	2462	19	19

IEEE 802.11n HT 40 MHz mode

Channel	Frequency (MHz)	RF power setting in TEST SW (Chin 0)	RF power setting in TEST SW (Chin 1)
Low	2422	15	15
Mid	2437	1A	1A
High	2452	17	17

4. INSTRUMENT CALIBRATION

4.1 MEASURING INSTRUMENT CALIBRATION

The measuring equipment, which was utilized in performing the tests documented herein, has been calibrated in accordance with the manufacturer's recommendations for utilizing calibration equipment, which is traceable to recognized national standards.

4.2 MEASUREMENT EQUIPMENT USED

Equipment Used for Emissions Measurement

Conducted Emissions Test Site					
Name of Equipment	Manufacturer	Model	Serial Number	Calibration Date	Calibration Due
Power Meter	Anritsu	ML2495A	1012009	2016/7/4	2017/7/3
Power Meter	Anritsu	MA2411B	917072	2016/7/4	2017/7/3
Spectrum Analyzer	R&S	FSV 40	101073	2016/8/1	2017/7/31

Wugu 966 Chamber A					
Name of Equipment	Manufacturer	Model	Serial Number	Calibration Date	Calibration Due
Spectrum Analyzer	Agilent	E4446A	US42510252	2015/12/8	2016/12/7
Bilog Antenna	Sunol Sciences	JB3	A030105	2016/8/5	2017/8/4
Pre-Amplifier	EMEC	EM330	60609	2016/6/8	2017/6/7
Horn Antenna	ETC	MCTD 1209	DRH13M02003	2015/9/2	2016/9/1
Antenna Tower	CCS	CC-A-1F	N/A	N.C.R	N.C.R
Controller	CCS	CC-C-1F	N/A	N.C.R	N.C.R
Turn Table	CCS	CC-T-1F	N/A	N.C.R	N.C.R
Software	EZ-EMC (CCS-3A1RE)				

Conducted Emission Room # B					
Name of Equipment	Manufacturer	Model	Serial Number	Calibration Date	Calibration Due
LISN	R&S	ENV216	101054	2016/5/11	2017/5/10
Receiver	R&S	ESCI	101073	2015/9/9	2016/9/8
Software	CCS-3A1-CE				

Remark:

1. Each piece of equipment is scheduled for calibration once a year and Precision Dipole is scheduled for calibration once three years.
2. N.C.R. = No Calibration Request.

4.3 MEASUREMENT UNCERTAINTY

PARAMETER	UNCERTAINTY
Powerline Conducted Emission	+/- 1.2575
3M Semi Anechoic Chamber / 30M~200M	+/- 4.0138
3M Semi Anechoic Chamber / 200M~1000M	+/- 3.9483
3M Semi Anechoic Chamber / 1G~8G	+/- 2.5975
3M Semi Anechoic Chamber / 8G~18G	+/- 2.6112
3M Semi Anechoic Chamber / 18G~26G	+/- 2.7389
3M Semi Anechoic Chamber / 26G~40G	+/- 2.9683

Remark: This uncertainty represents an expanded uncertainty expressed at approximately the 95% confidence level using a coverage factor of $k=2$.

5. FACILITIES AND ACCREDITATIONS

5.1 FACILITIES

All measurement facilities used to collect the measurement data are located at

- No.199, Chunghsen Road, Hsintien City, Taipei Hsien, Taiwan, R.O.C.
Tel: 886-2-2217-0894 / Fax: 886-2-2217-1029
- No.11, Wugong 6th Rd., Wugu Dist., New Taipei City 24891, Taiwan. (R.O.C.)
Tel: 886-2-2299-9720 / Fax: 886-2-2298-4045
- No.81-1, Lane 210, Bade 2nd Rd., Lujhu Township, Taoyuan County 33841, TAIWAN, R.O.C.
Tel: 886-3-324-0332 / Fax: 886-3-324-5235

The sites are constructed in conformance with the requirements of ANSI C63.7, ANSI C63.10: 2013 and CISPR Publication 22.

5.2 EQUIPMENT

Radiated emissions are measured with one or more of the following types of linearly polarized antennas: tuned dipole, biconical, log periodic, bi-log, ridged waveguide, horn and/or Loop. Spectrum analyzers with pre-selectors and quasi-peak detectors are used to perform radiated measurements.

Conducted emissions are measured with Line Impedance Stabilization Networks and EMI Test Receivers.



Calibrated wideband preamplifiers, coaxial cables, and coaxial attenuators are also used for making measurements.

All receiving equipment conforms to CISPR Publication 16-1, "Radio Interference Measuring Apparatus and Measurement Methods."

5.3 LABORATORY ACCREDITATIONS AND LISTING

The test facilities used to perform radiated and conducted emissions tests are accredited by American Association for Laboratory Accreditation Program for the specific scope accreditation under Lab Code: 0824-01 to perform Electromagnetic Interference tests according to FCC Part 15 and CISPR 22 requirements. In addition, the test facilities are listed with Industry Canada, Certification and Engineering Bureau, IC 2324G-1 for 3M Semi Anechoic Chamber A, 2324G-2 for 3M Semi Anechoic Chamber B.

5.4 TABLE OF ACCREDITATIONS AND LISTINGS

Country	Agency	Scope of Accreditation	Logo
USA	FCC	3M Semi Anechoic Chamber (FCC MRA: TW1039) to perform FCC Part 15 measurements	 FCC MRA: TW1039
Taiwan	TAF	LP0002, RTTE01, FCC Method-47 CFR Part 15 Subpart C, D, E, RSS-210, RSS-310 IDA TS SRD, AS/NZS 4268, AS/NZS 4771, TS 12.1 & 12.2, ETSI EN 300 440-1, ETSI EN 300 440-2, ETSI EN 300 328, ETSI EN 300 220-1, ETSI EN 300 220-2, ETSI EN 301 893, ETSI EN 301 489-1/3/7/17 FCC OET Bulletin 65 + Supplement C, EN 50360, EN 50361, EN 50371, RSS 102, EN 50383, EN 50385, EN 50392, IEC 62209, CNS 14958-1, CNS 14959 FCC Method -47 CFR Part 15 Subpart B IEC / EN 61000-3-2, IEC / EN 61000-3-3, IEC / EN 61000-4-2/3/4/5/6/8/11	
Canada	Industry Canada	3M Semi Anechoic Chamber (IC 2324G-1 / IC 2324G-2) to perform	 IC 2324G-1 IC 2324G-2

** No part of this report may be used to claim or imply product endorsement by A2LA or any agency of the US Government.*

6. SETUP OF EQUIPMENT UNDER TEST

6.1 SETUP CONFIGURATION OF EUT

See test photographs attached in Appendix II for the actual connections between EUT and support equipment.

6.2 SUPPORT EQUIPMENT

No	Equipment	Brand	Model	Series No.	FCC ID	Data Cable	Power Cord
1	Notebook PC	ASUS	M5200AE	5BN0AG019631	PD9WM3B2100	N/A	AC I/P: Unshielded, 1.8m with a core DC O/P: Unshielded, 1.8m
2	Fixture	LITEON	LITEON	N/A	N/A	N/A	N/A

Remark:

1. All the equipment/cables were placed in the worst-case configuration to maximize the emission during the test.
2. Grounding was established in accordance with the manufacturer's requirements and conditions for the intended use.

7. FCC PART 15.247 REQUIREMENTS & RSS-247 REQUIREMENTS

7.1 99% BANDWIDTH

Test Configuration

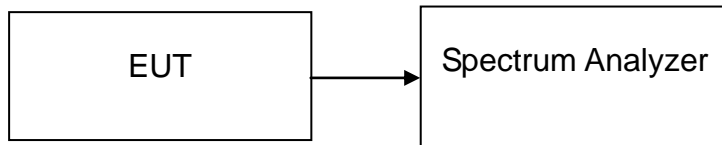

TEST PROCEDURE

The resolution bandwidth shall be set to as close to 1% of the selected span as is possible without being below 1%. The video bandwidth shall be set to 3 times the resolution bandwidth. Video averaging is not permitted. Where practical, a sampling detector shall be used since a peak or, peak hold.

Test Data

IEEE 802.11b mode

Channel	Frequency (MHz)	99% Bandwidth (MHz)
Low	2412	12.1562
Mid	2437	12.1997
High	2462	12.1562

IEEE 802.11g mode

Channel	Frequency (MHz)	99% Bandwidth (MHz)
Low	2412	16.4109
Mid	2437	16.4978
High	2462	16.4109

IEEE 802.11n HT 20 MHz mode / Chain 0

Channel	Frequency (MHz)	99% Bandwidth (MHz)
Low	2412	17.6266
Mid	2437	17.5397
High	2462	17.5397

IEEE 802.11n HT 20 MHz mode / Chain 1

Channel	Frequency (MHz)	99% Bandwidth (MHz)
Low	2412	17.5397
Mid	2437	17.5397
High	2462	17.5397

IEEE 802.11n HT 40 MHz mode / Chain 0

Channel	Frequency (MHz)	99% Bandwidth (MHz)
Low	2422	36.0057
Mid	2437	36.0057
High	2452	36.0057

IEEE 802.11n HT 40 MHz mode / Chain 1

Channel	Frequency (MHz)	99% Bandwidth (MHz)
Low	2422	35.8900
Mid	2437	35.8900
High	2452	35.8900

Test Plot

IEEE 802.11b mode

99% Bandwidth (CH Low)

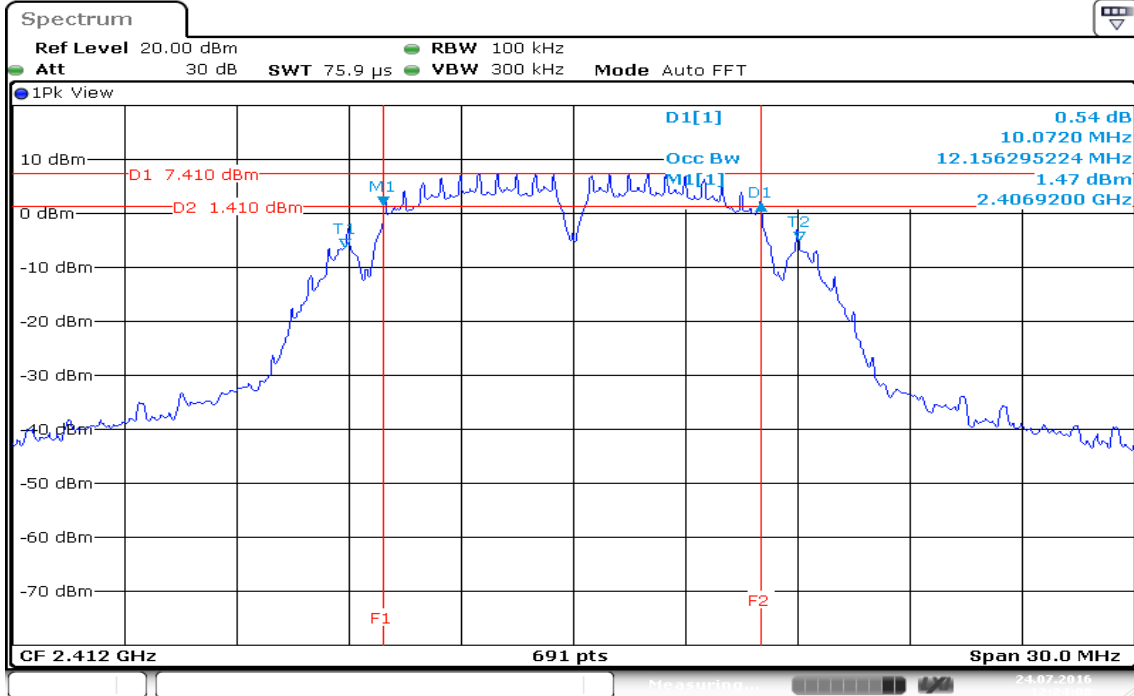

99% Bandwidth (CH Mid)

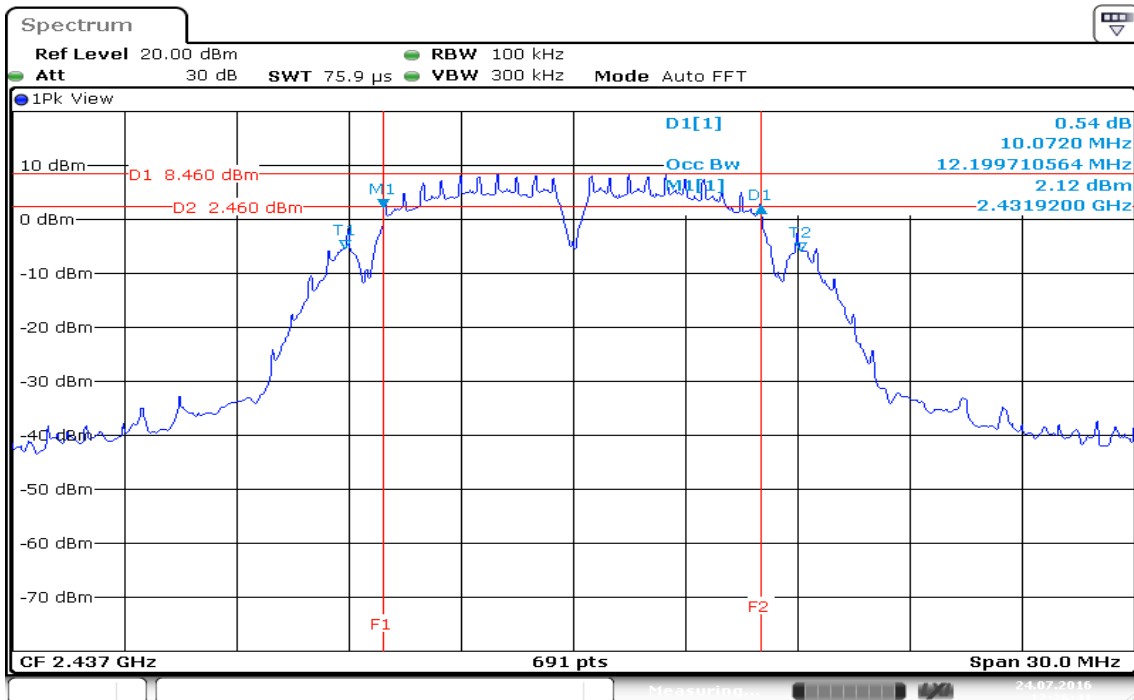

99% Bandwidth (CH High)

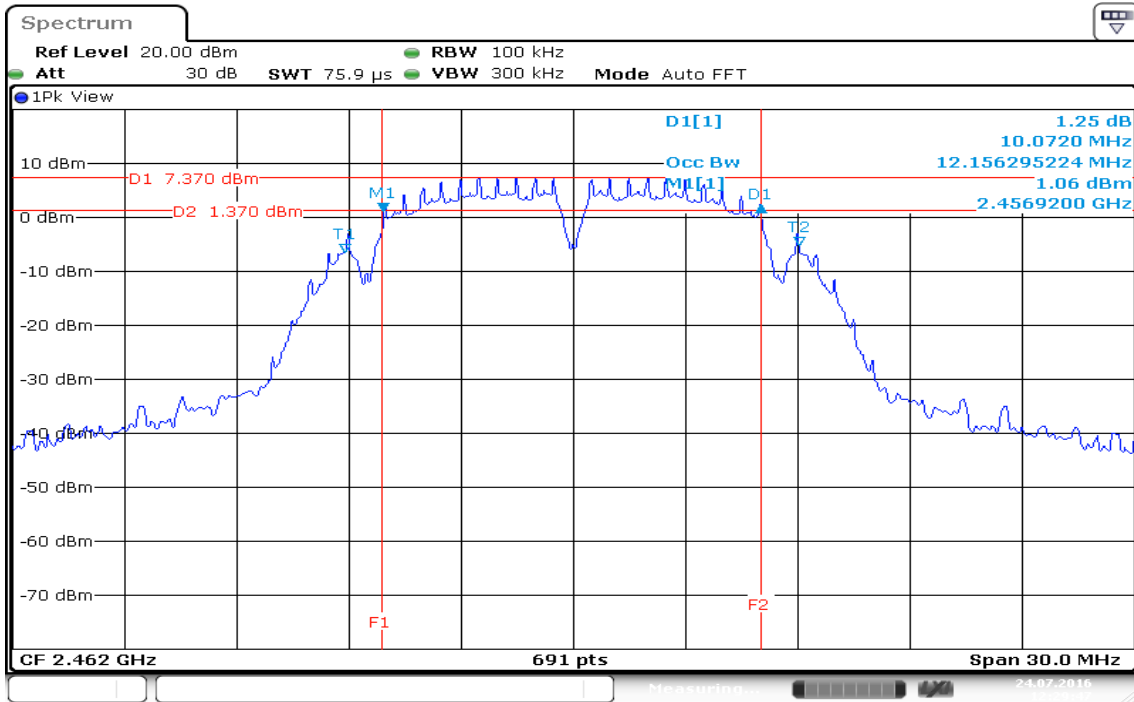

IEEE 802.11g mode

99% Bandwidth (CH Low)

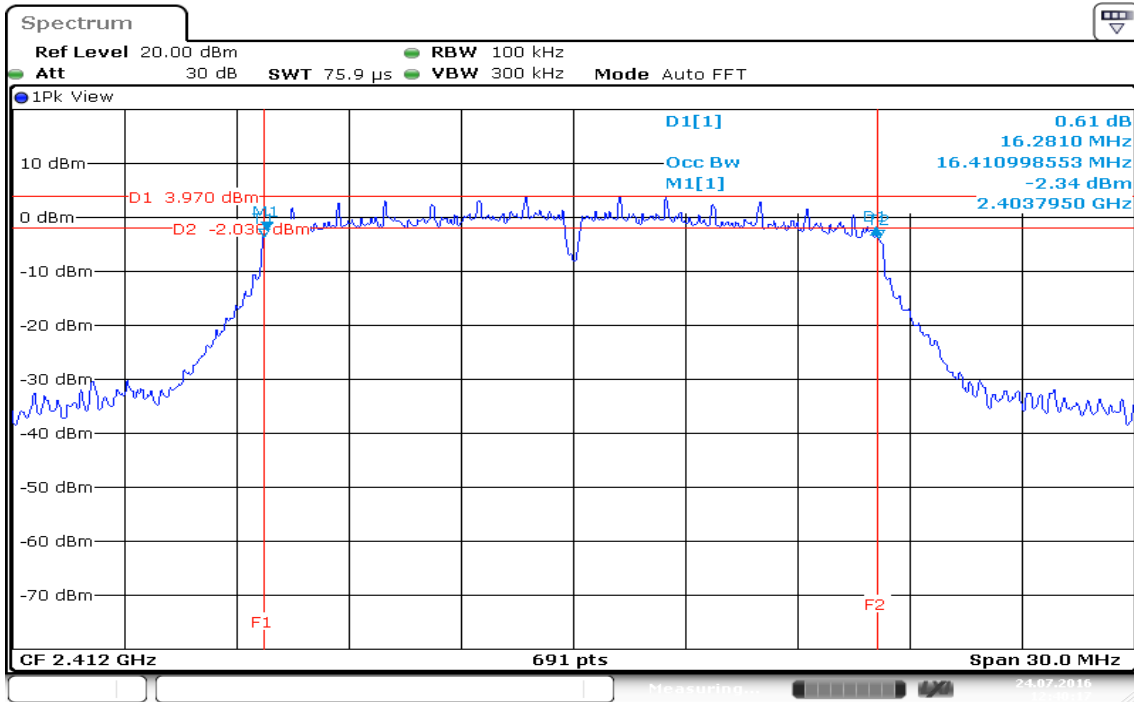

99% Bandwidth (CH Mid)

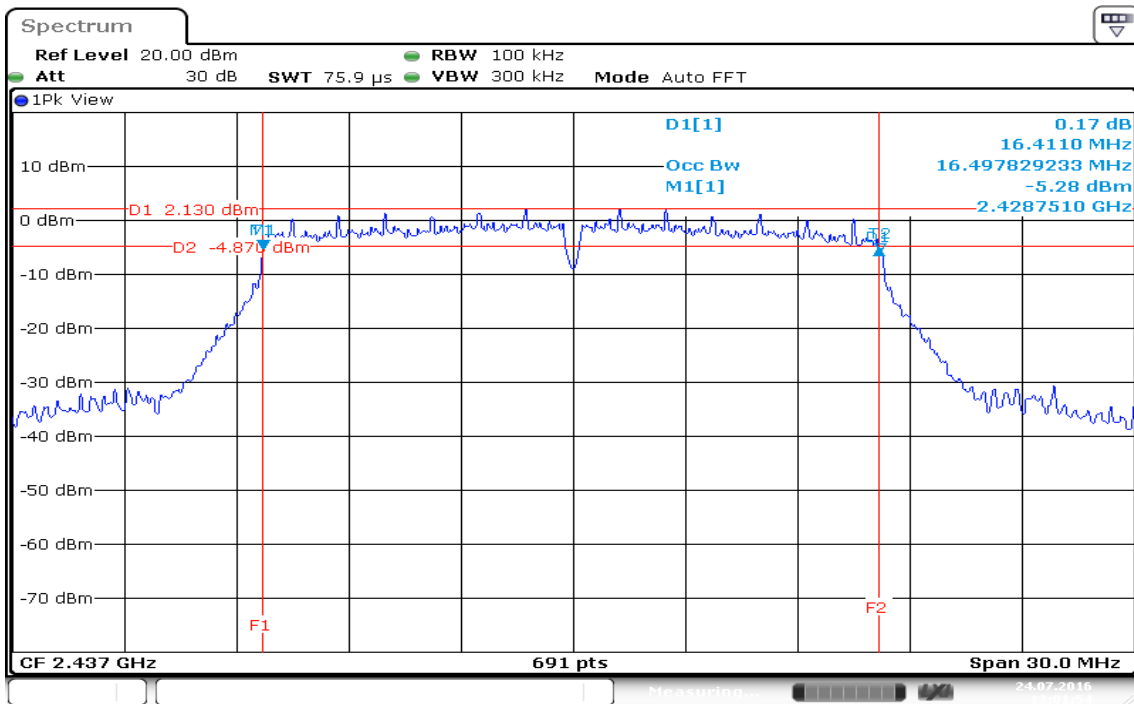

99% Bandwidth (CH High)

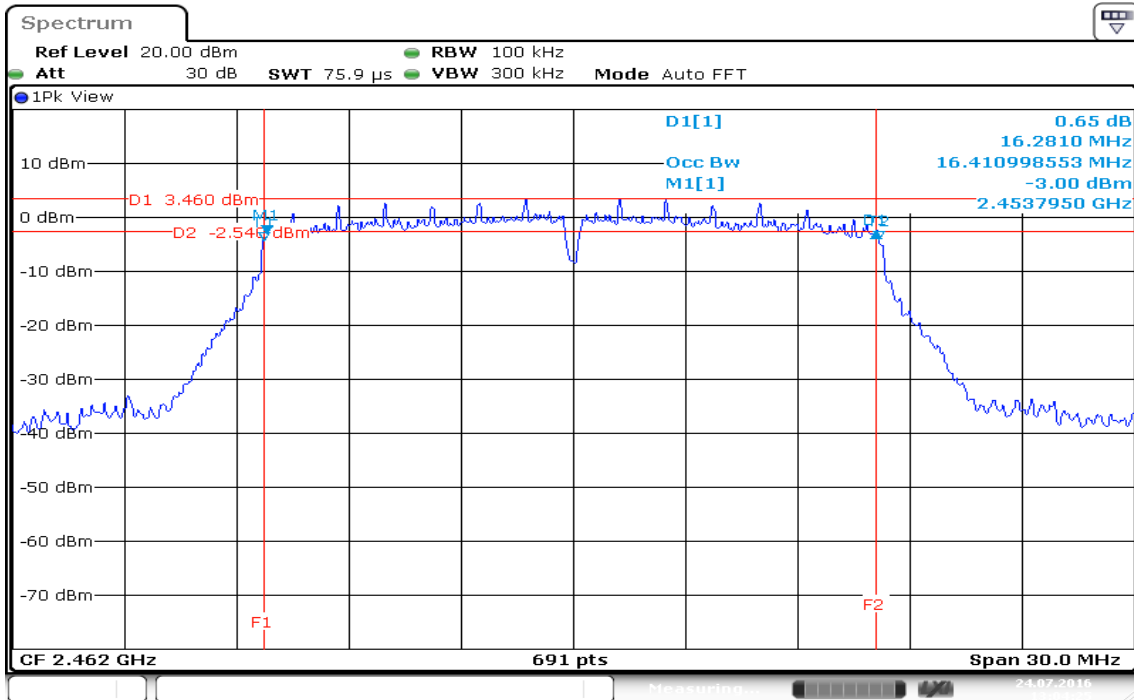

Date: 24 JUL 2016 13:04:26

IEEE 802.11n HT 20 MHz mode/ Chain 0

99% Bandwidth (CH Low)

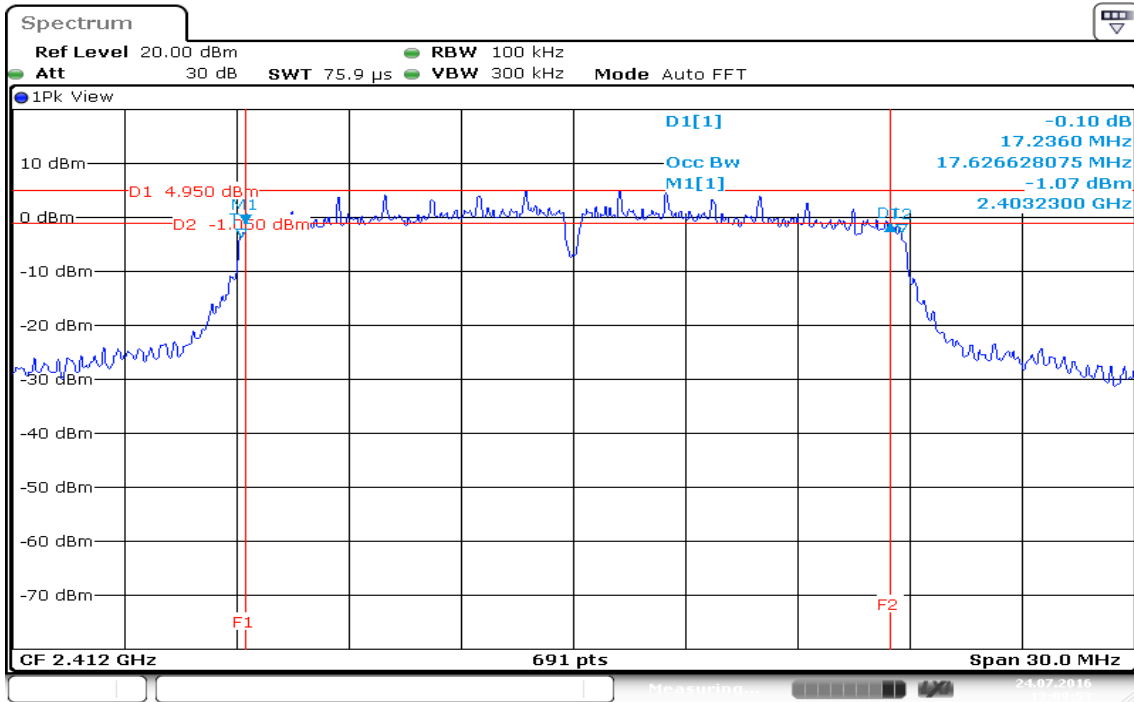

99% Bandwidth (CH Mid)

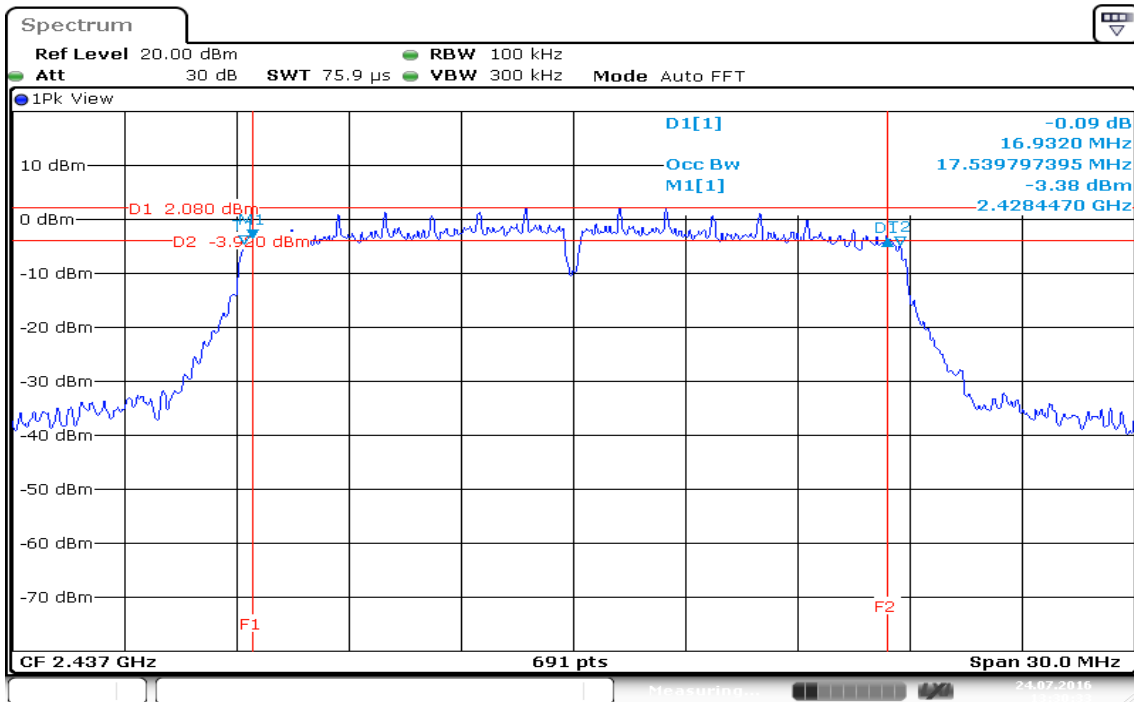

99% Bandwidth (CH High)

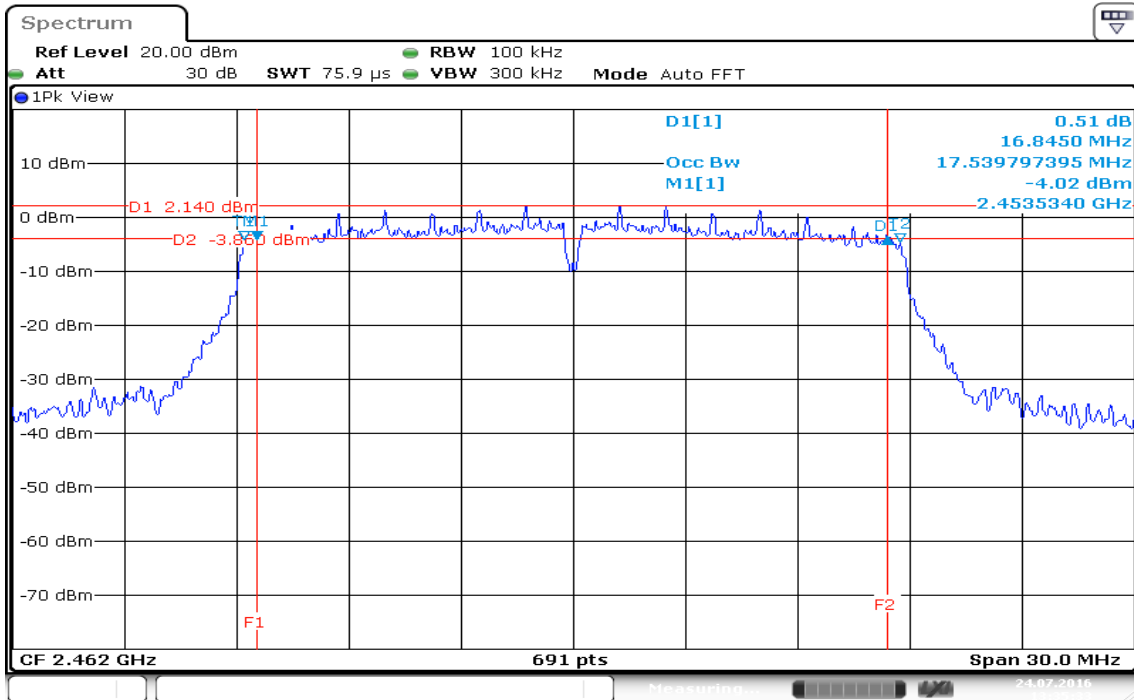

Date: 24 JUL 2016 13:35:33

IEEE 802.11n HT 20 MHz mode / Chain 1
99% Bandwidth (CH Low)

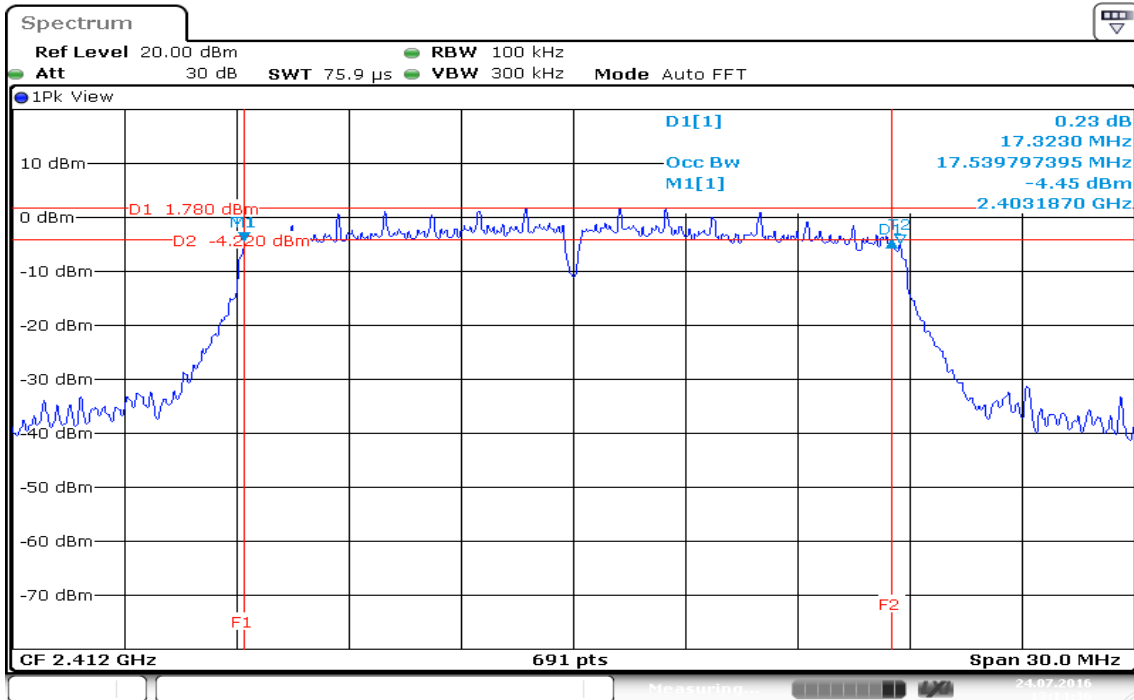

99% Bandwidth (CH Mid)

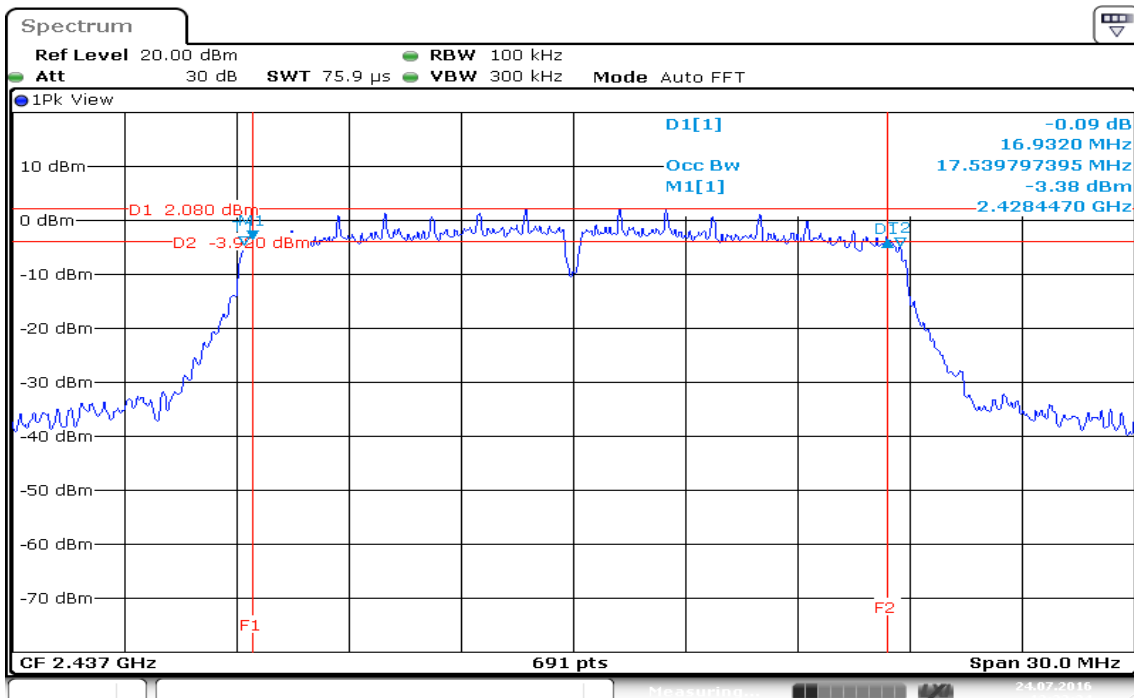

99% Bandwidth (CH High)

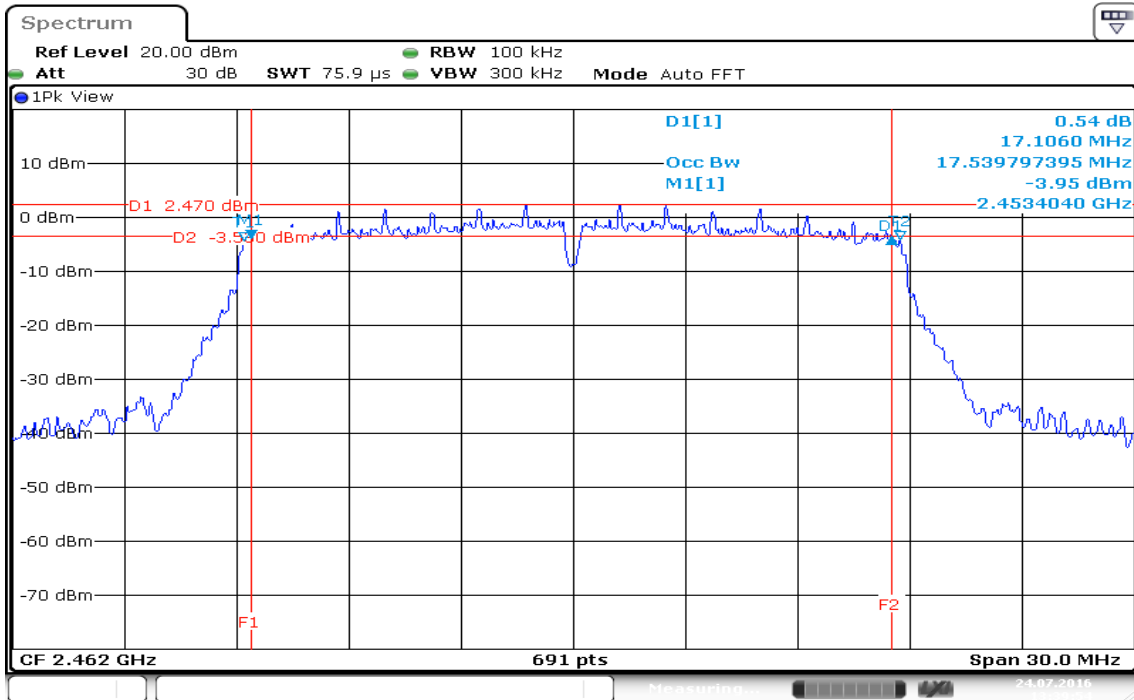

Date: 24 JUL 2016 13:39:54

IEEE 802.11n HT 40 MHz mode/ Chain 0

99% Bandwidth (CH Low)

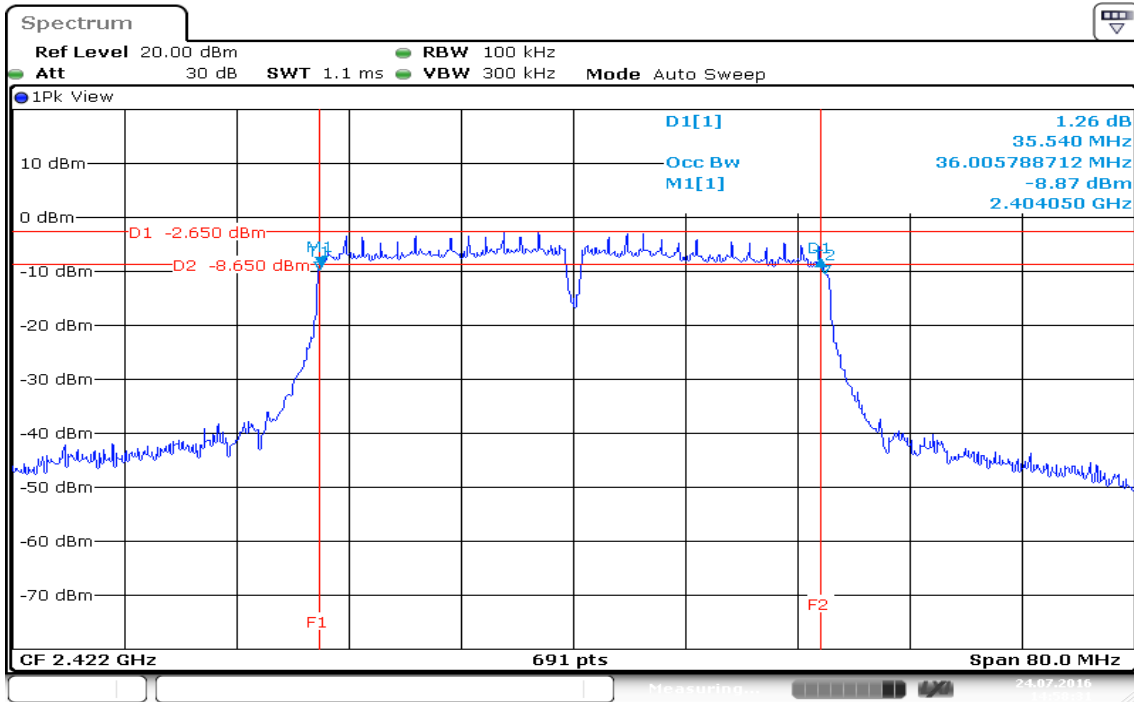

99% Bandwidth (CH Mid)

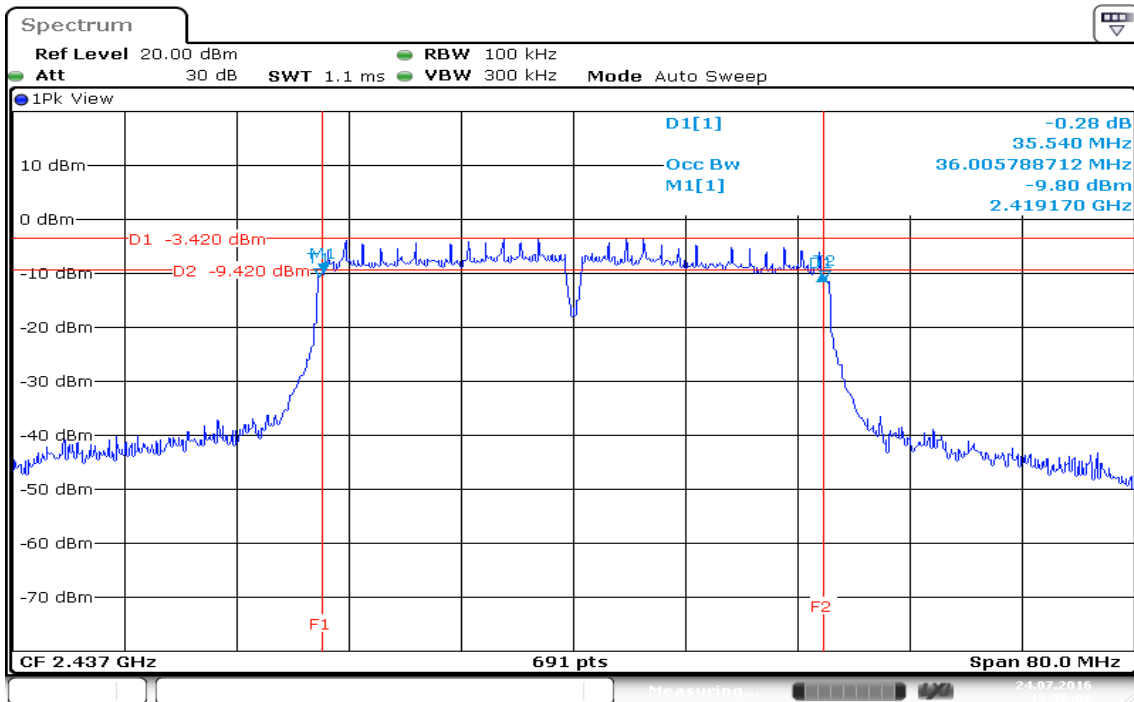

99% Bandwidth (CH High)

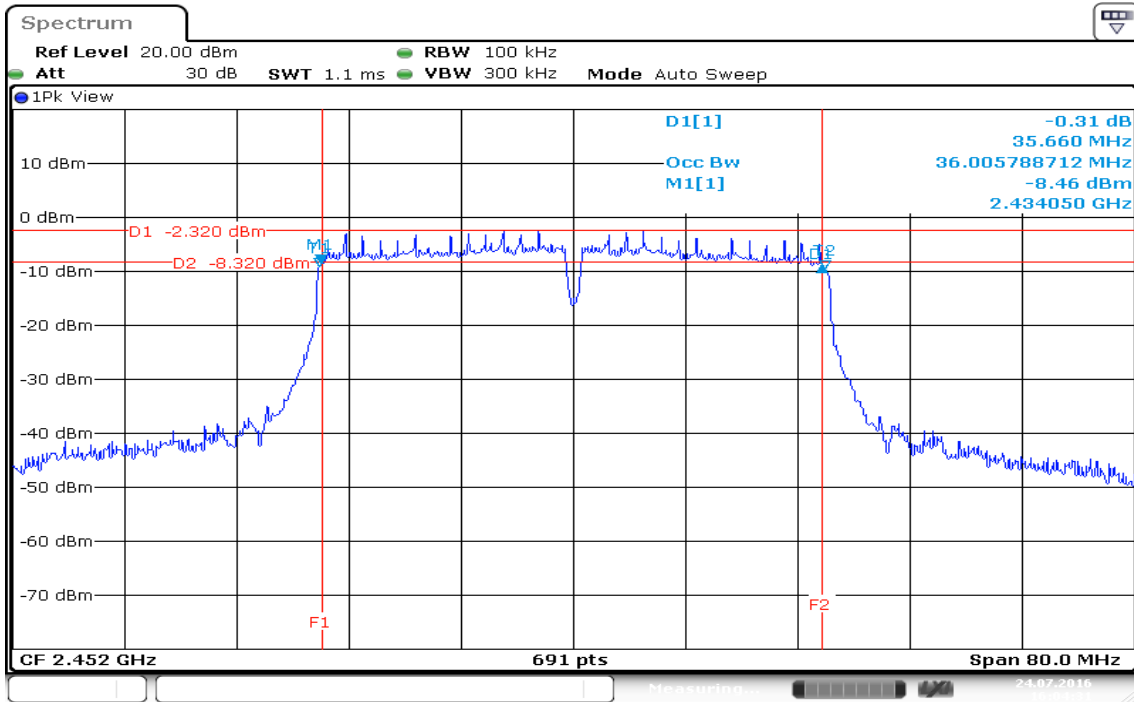

Date: 24 JUL 2016 16:04:30

IEEE 802.11n HT 40 MHz mode / Chain 1
99% Bandwidth (CH Low)

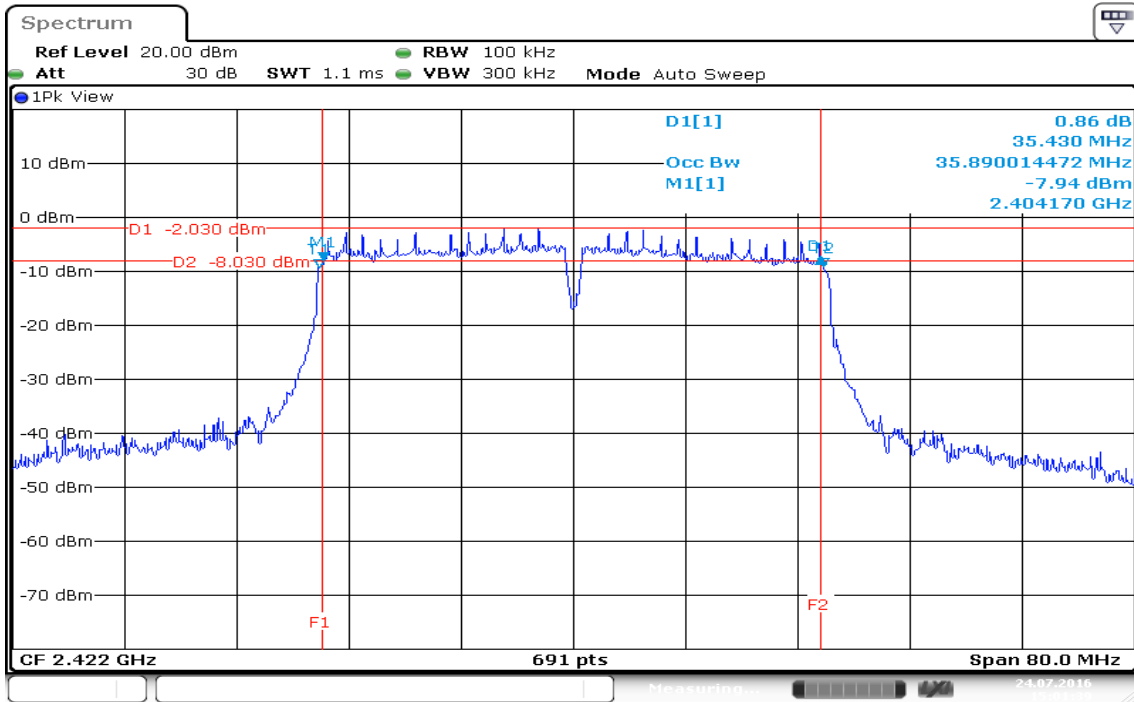

99% Bandwidth (CH Mid)

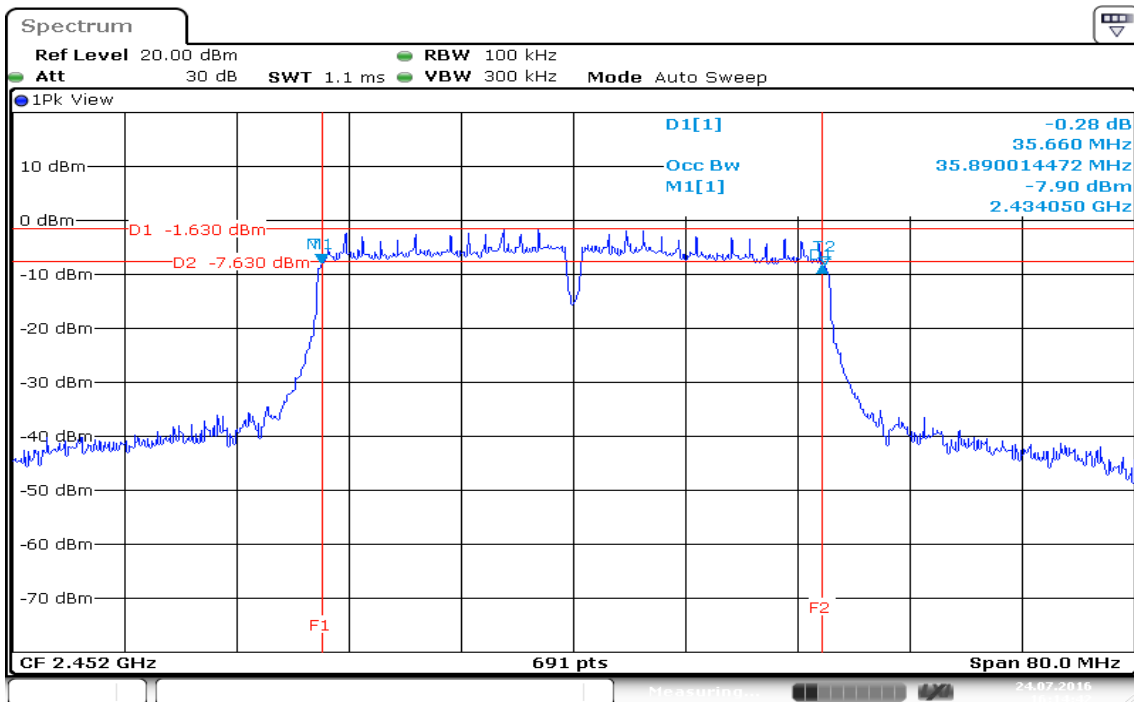

99% Bandwidth (CH High)

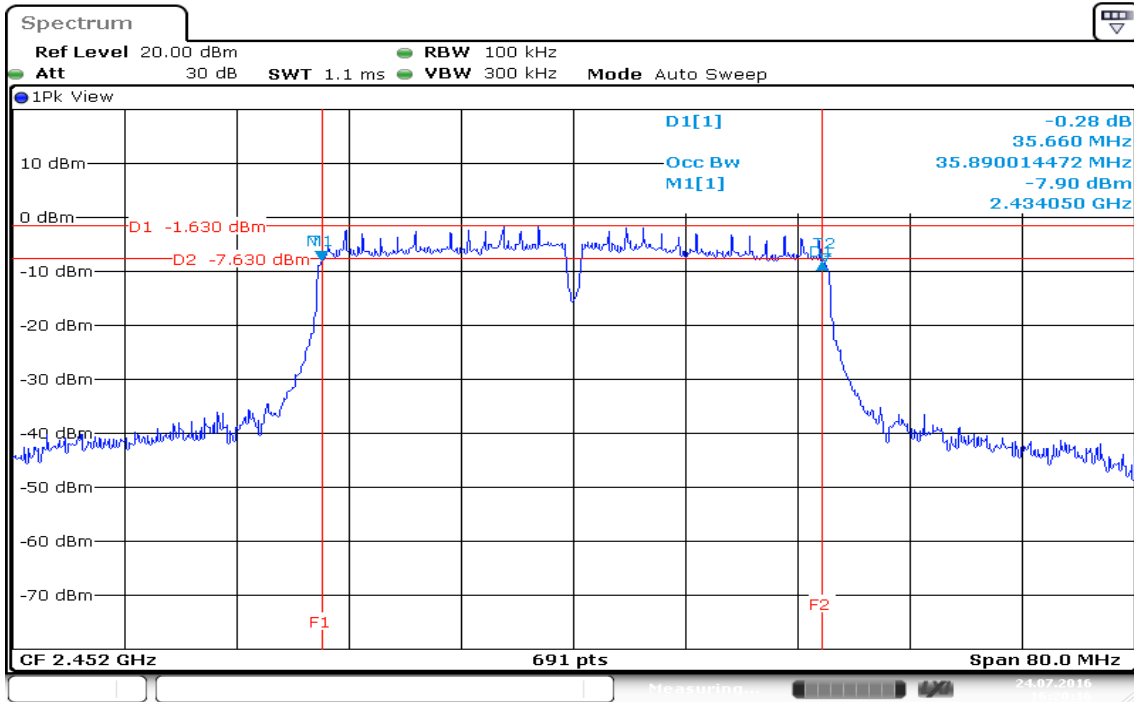

7.2 6DB BANDWIDTH

LIMIT

According to §15.247(a)(2) & RSS-247, systems using digital modulation techniques may operate in the 902 - 928 MHz, 2400 - 2483.5 MHz, and 5725 - 5850 MHz bands. The minimum 6dB bandwidth shall be at least 500 kHz.

Test Configuration

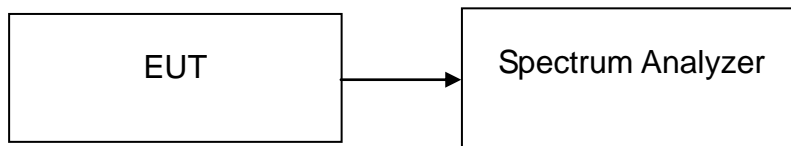

TEST PROCEDURE

1. Place the EUT on the table and set it in the transmitting mode.
2. Remove the antenna from the EUT and then connect a low loss RF cable from the antenna port to the spectrum analyzer.
3. Set the spectrum analyzer as RBW = 100 kHz, VBW= 300kHz, Span = 50 MHz, Sweep = auto.
4. Mark the peak frequency and -6dB (upper and lower) frequency.
5. Repeat until all the rest channels are investigated.

TEST RESULTS

No non-compliance noted

Test Data

IEEE 802.11b mode

Channel	Frequency (MHz)	6dB Bandwidth (MHz)	Limit (kHz)	Result
Low	2412	10.0720	>500	PASS
Mid	2437	10.0720		PASS
High	2462	10.0720		PASS

IEEE 802.11g mode

Channel	Frequency (MHz)	6dB Bandwidth (MHz)	Limit (kHz)	Result
Low	2412	16.2810	>500	PASS
Mid	2437	16.4110		PASS
High	2462	16.2810		PASS

IEEE 802.11n HT 20 MHz mode / Chain 0

Channel	Frequency (MHz)	6dB Bandwidth (MHz)	Limit (kHz)	Result
Low	2412	17.2360	>500	PASS
Mid	2437	16.9320		PASS
High	2462	16.8450		PASS

IEEE 802.11n HT 20 MHz mode / Chain 1

Channel	Frequency (MHz)	6dB Bandwidth (MHz)	Limit (kHz)	Result
Low	2412	17.3230	>500	PASS
Mid	2437	16.9320		PASS
High	2462	17.1060		PASS

IEEE 802.11n HT 40 MHz mode / Chain 0

Channel	Frequency (MHz)	6dB Bandwidth (MHz)	Limit (kHz)	Result
Low	2422	35.5400	>500	PASS
Mid	2437	35.5400		PASS
High	2452	35.6600		PASS

IEEE 802.11n HT 40 MHz mode / Chain 1

Channel	Frequency (MHz)	6dB Bandwidth (MHz)	Limit (kHz)	Result
Low	2422	35.4300	>500	PASS
Mid	2437	35.6600		PASS
High	2452	35.6600		PASS

Test Plot

IEEE 802.11b mode

6dB Bandwidth (CH Low)

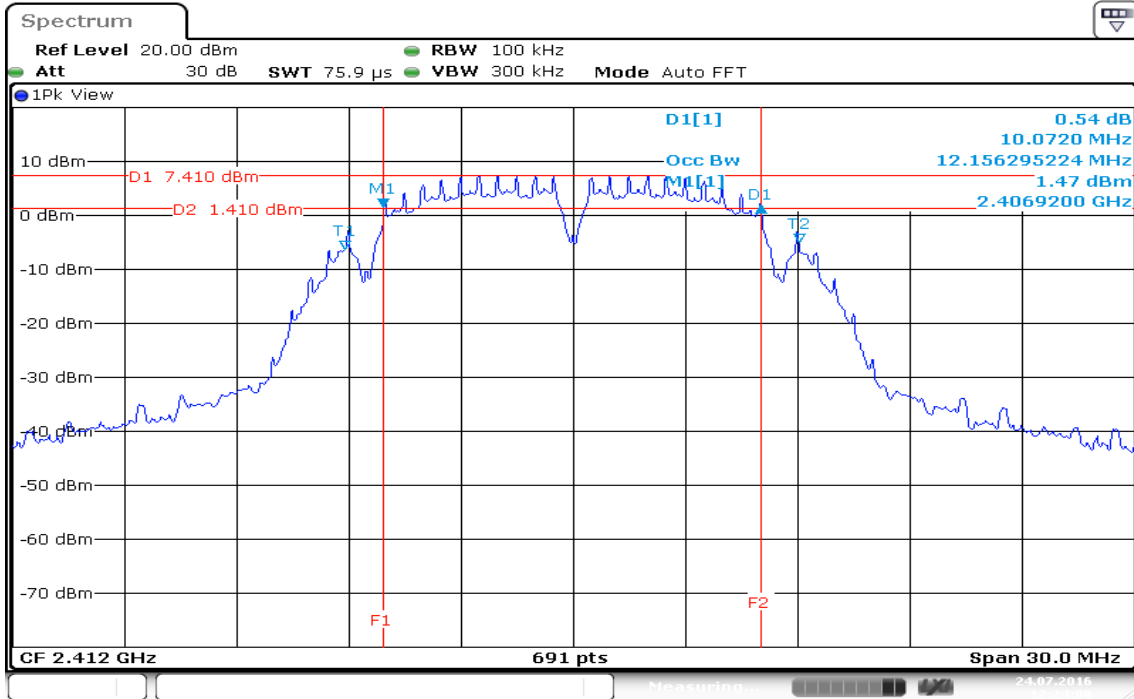

6dB Bandwidth (CH Mid)

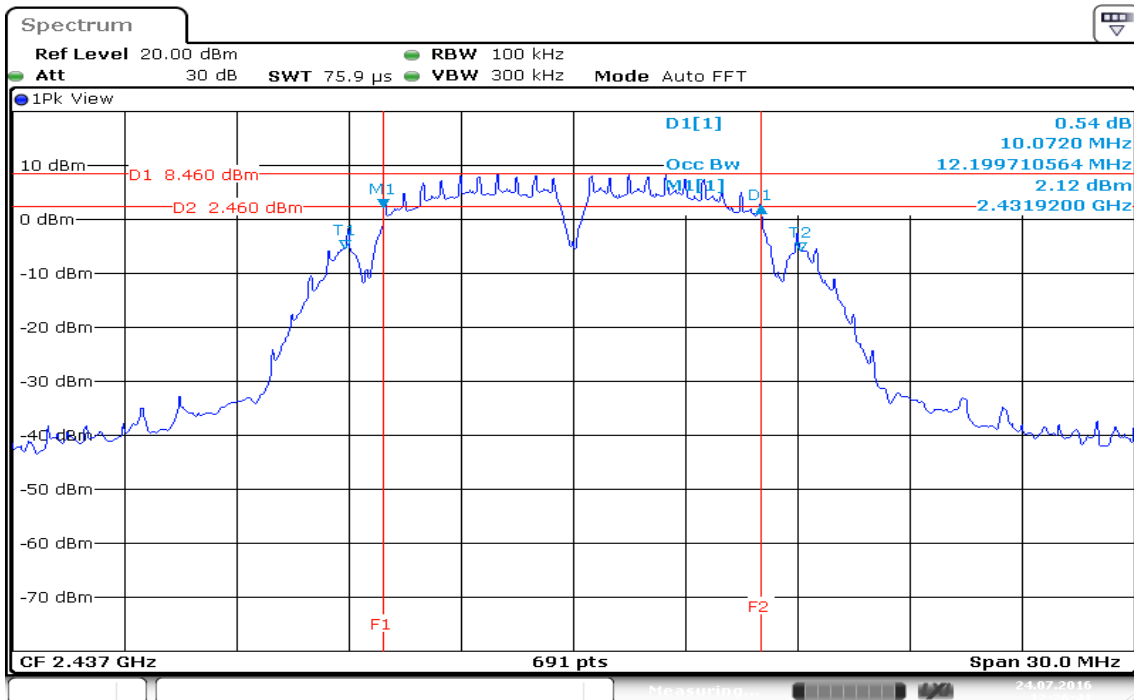

6dB Bandwidth (CH High)

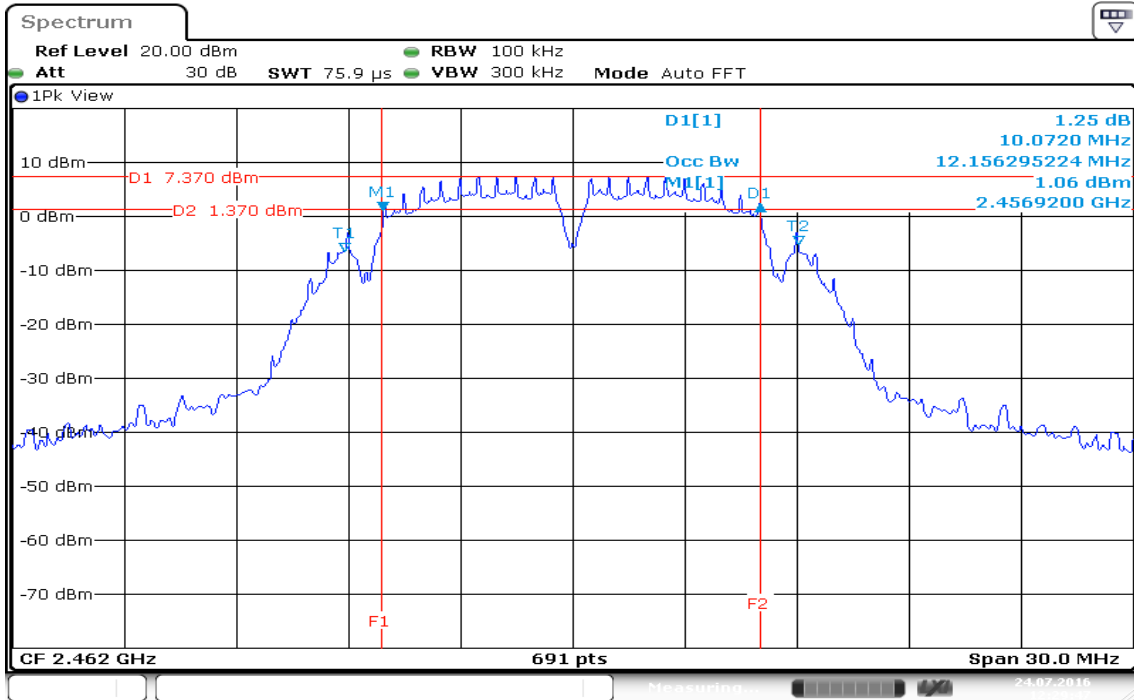

Date: 24 JUL 2016 12:29:47

IEEE 802.11g mode

6dB Bandwidth (CH Low)

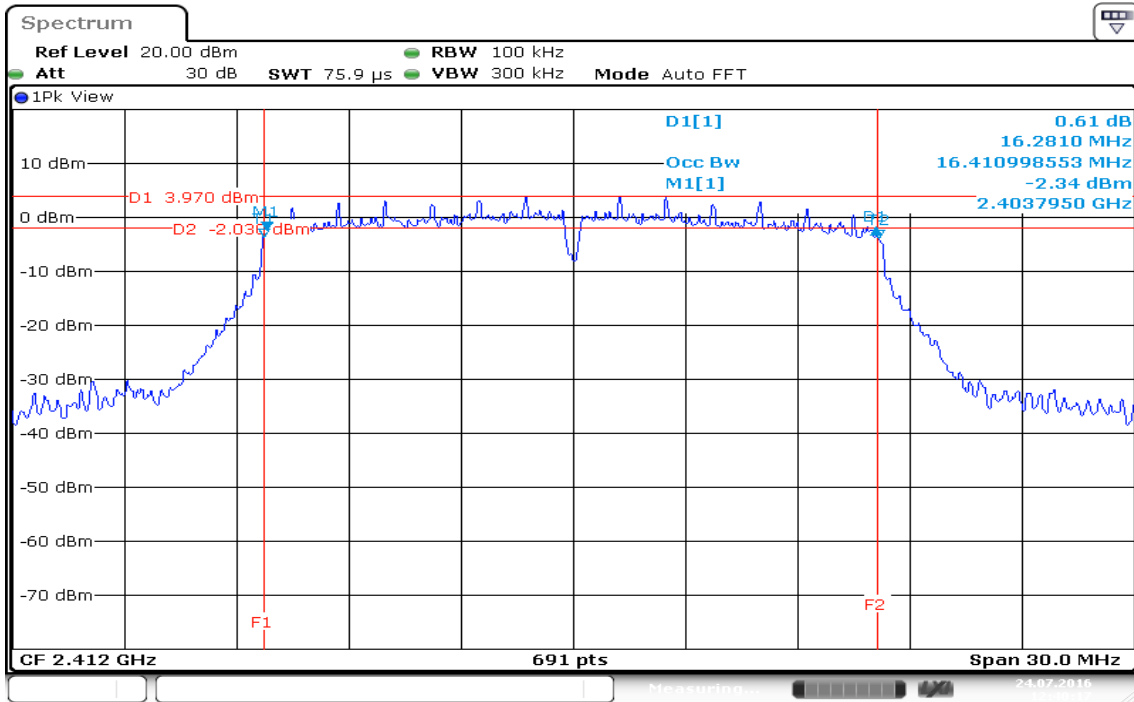

6dB Bandwidth (CH Mid)

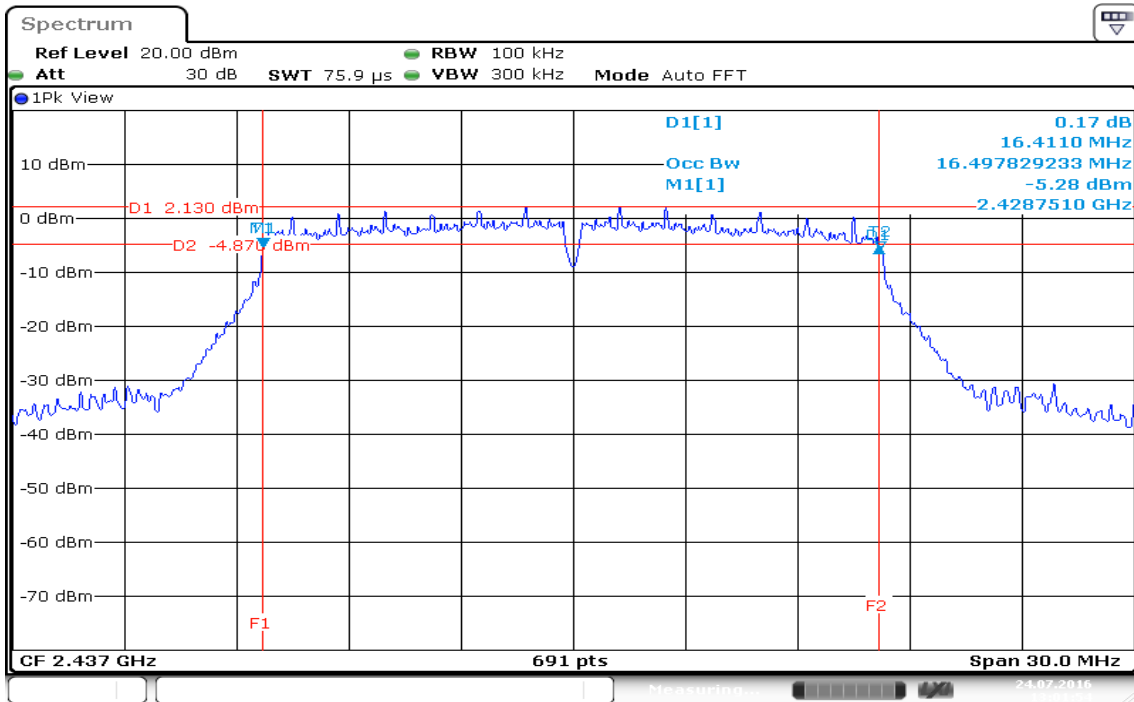

6dB Bandwidth (CH High)

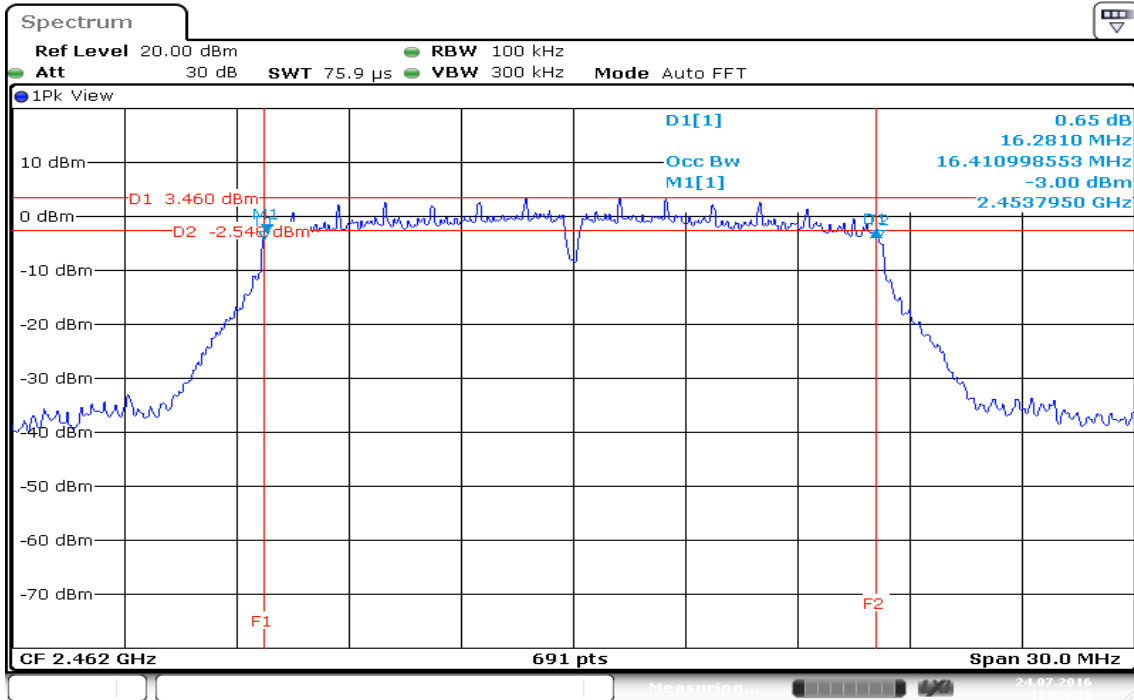

Date: 24 JUL 2016 13:04:26

IEEE 802.11n HT 20 MHz mode / Chain 0

6dB Bandwidth (CH Low)

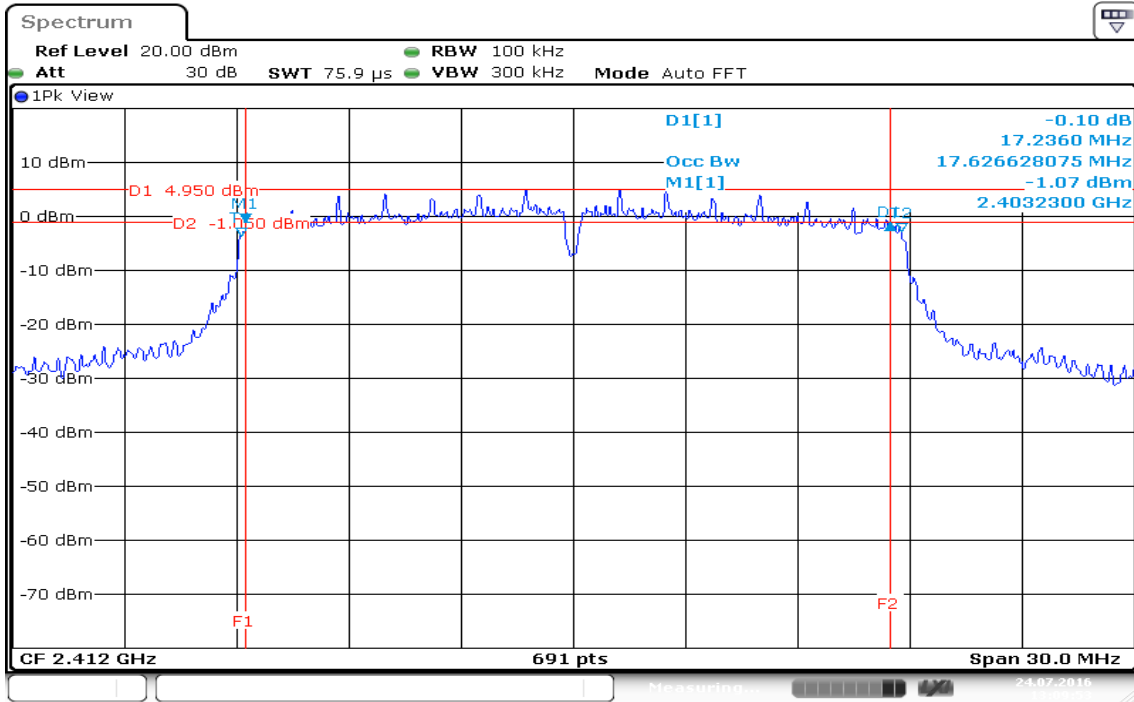

6dB Bandwidth (CH Mid)

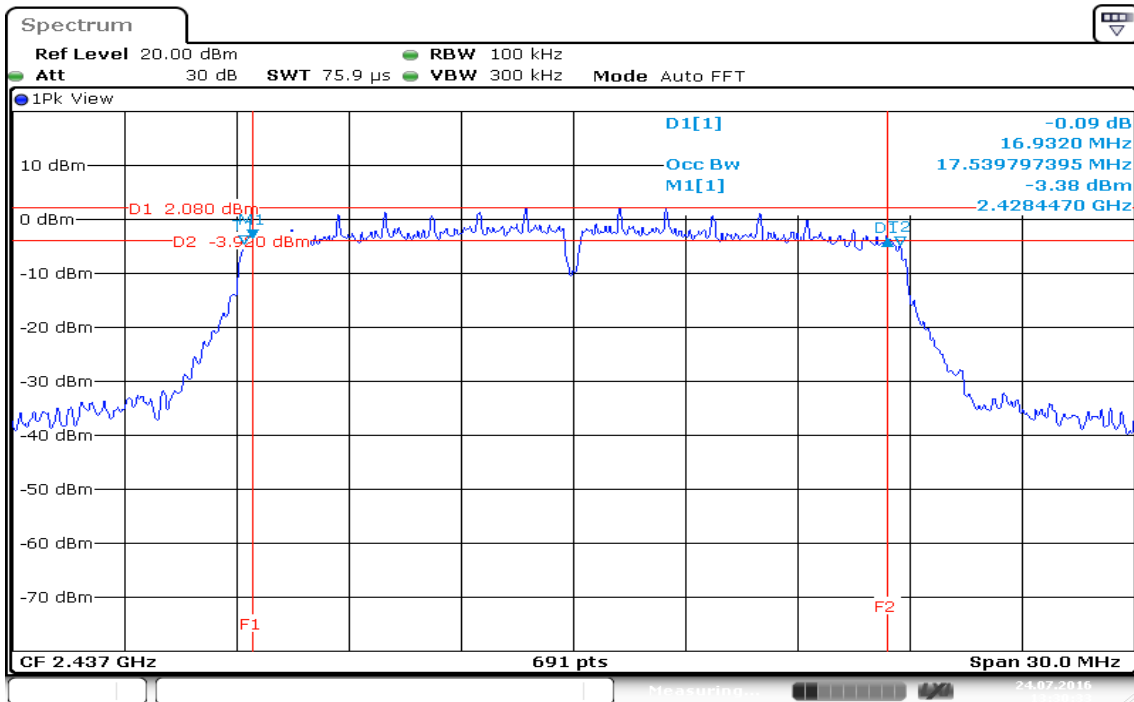

6dB Bandwidth (CH High)

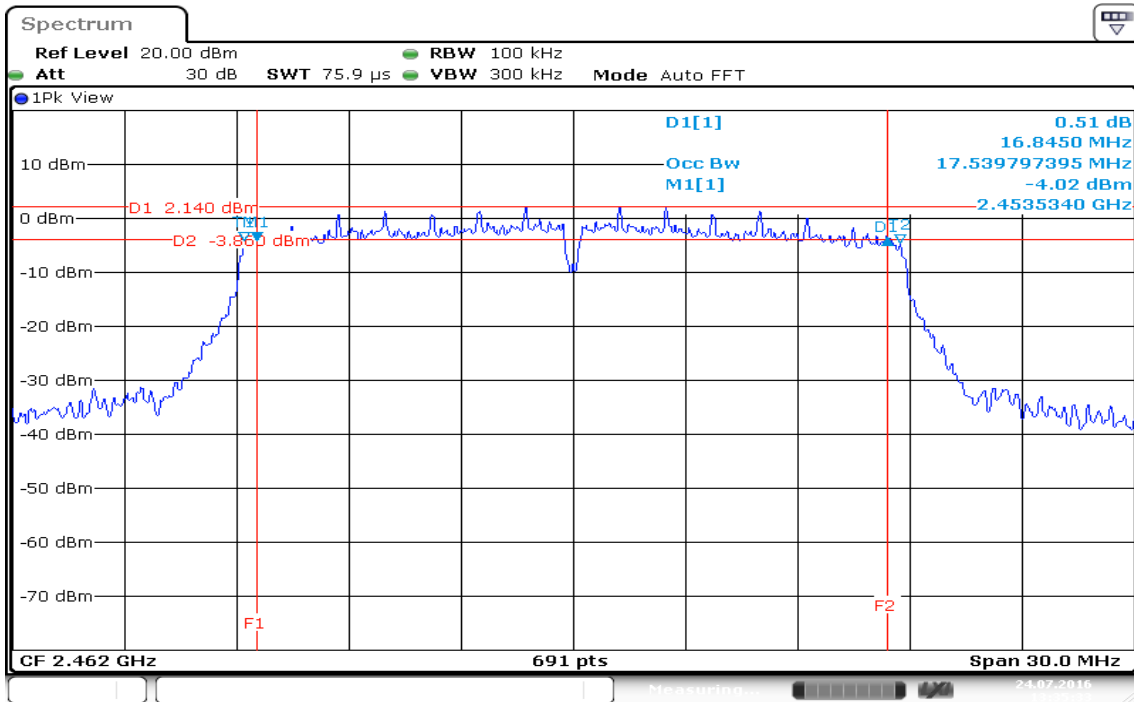

Date: 24 JUL 2016 13:35:33

IEEE 802.11n HT 20 MHz mode / Chain 1

6dB Bandwidth (CH Low)

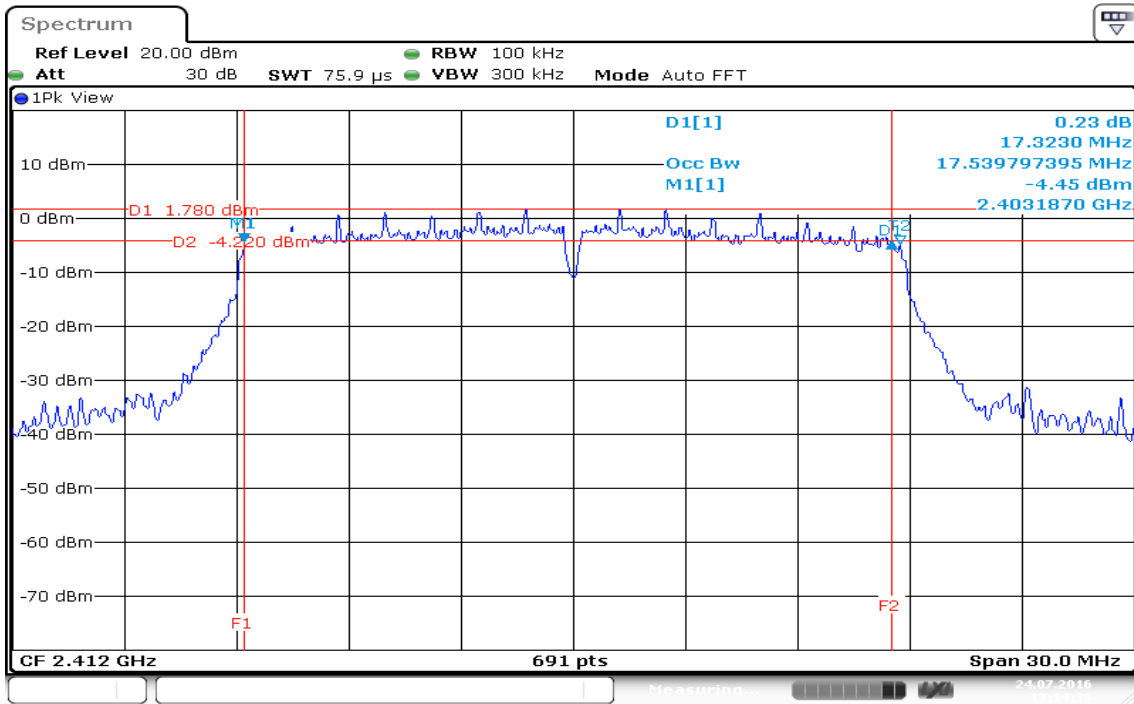

Date: 24 JUL 2016 13:14:36

6dB Bandwidth (CH Mid)

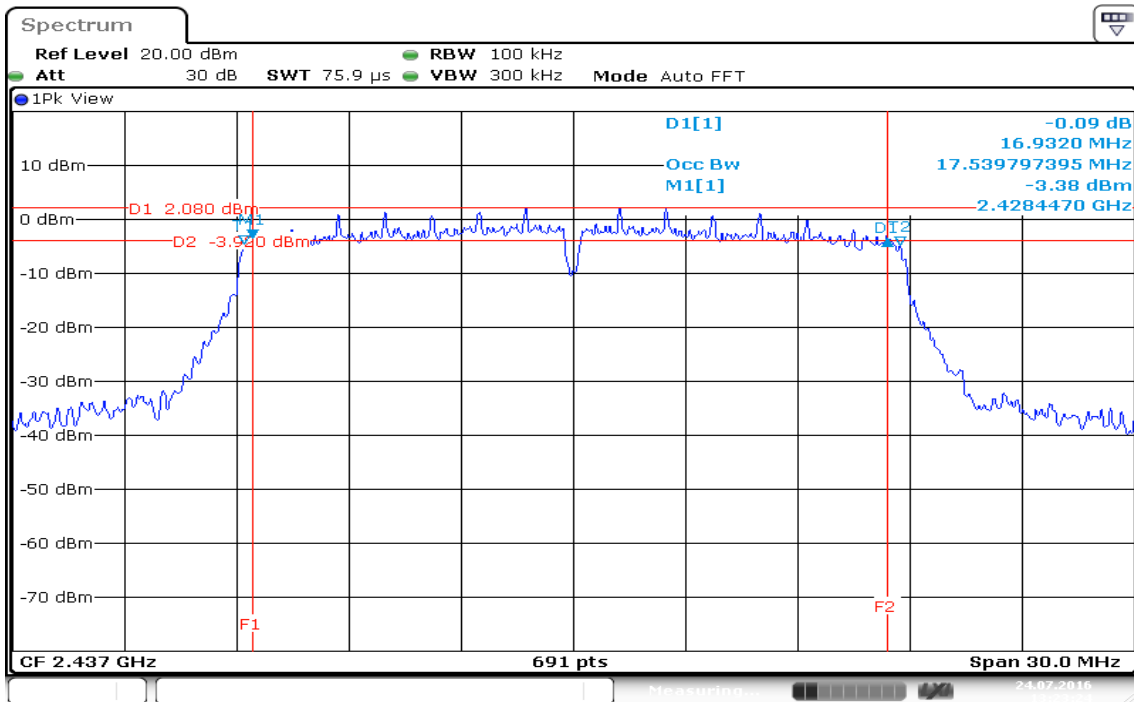

Date: 24 JUL 2016 13:23:25

6dB Bandwidth (CH High)

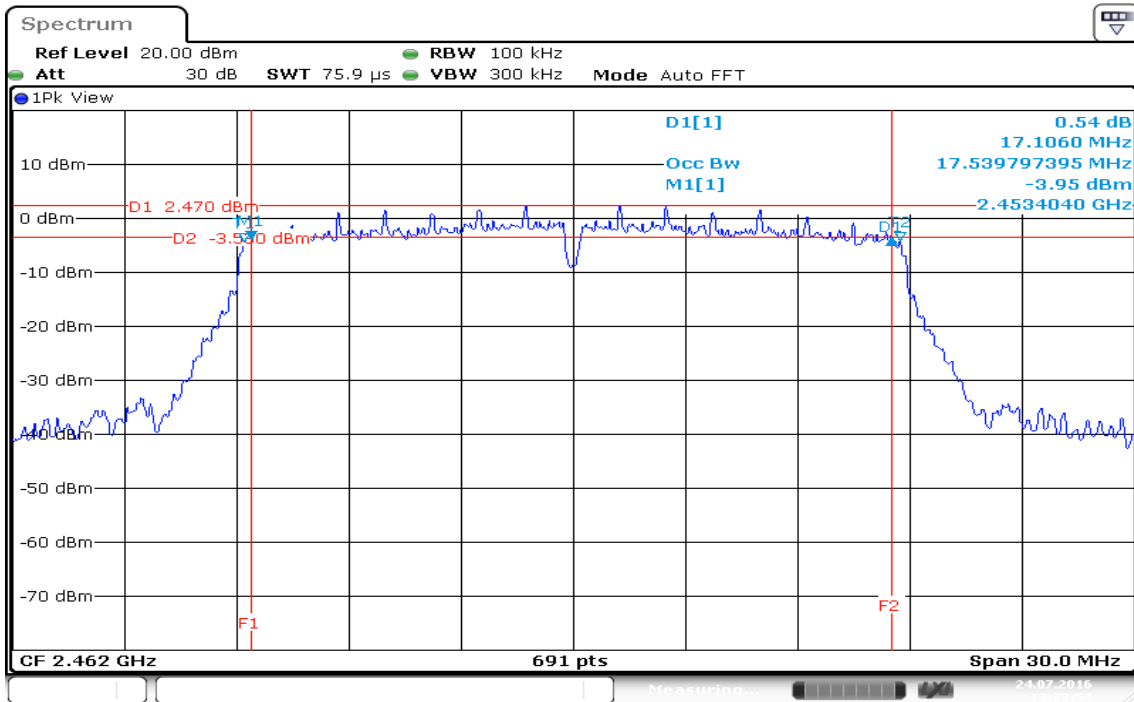

Date: 24 JUL 2016 13:39:54

IEEE 802.11n HT 40 MHz mode / Chain 0

6dB Bandwidth (CH Low)

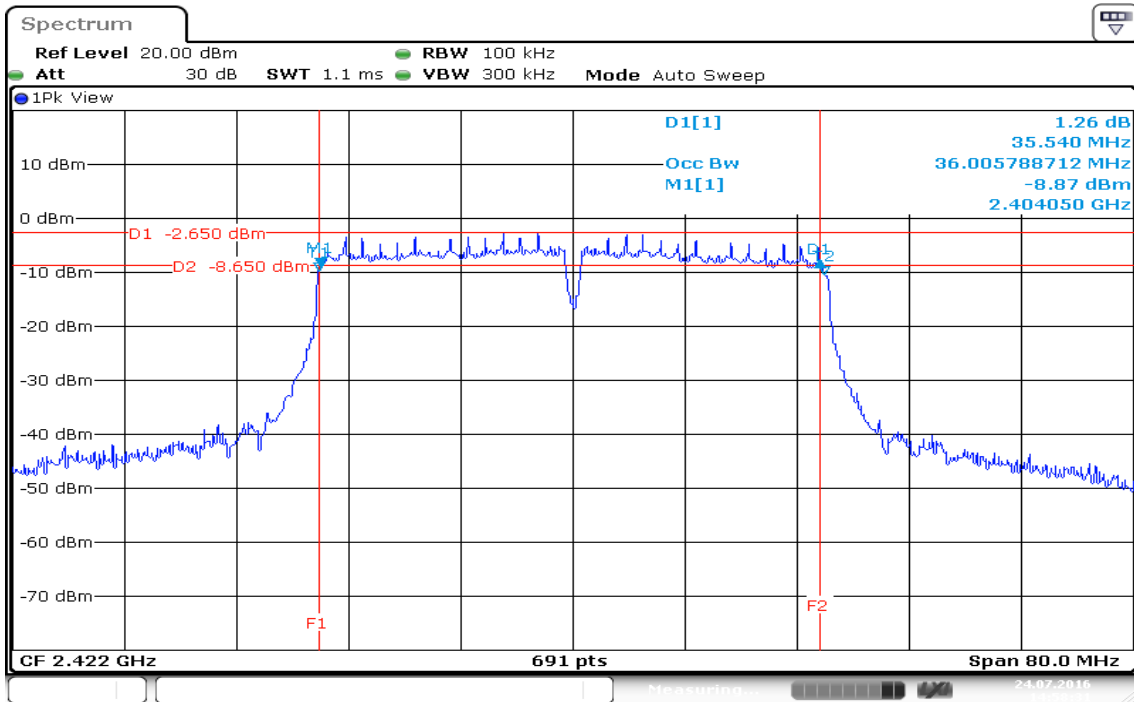

6dB Bandwidth (CH Mid)

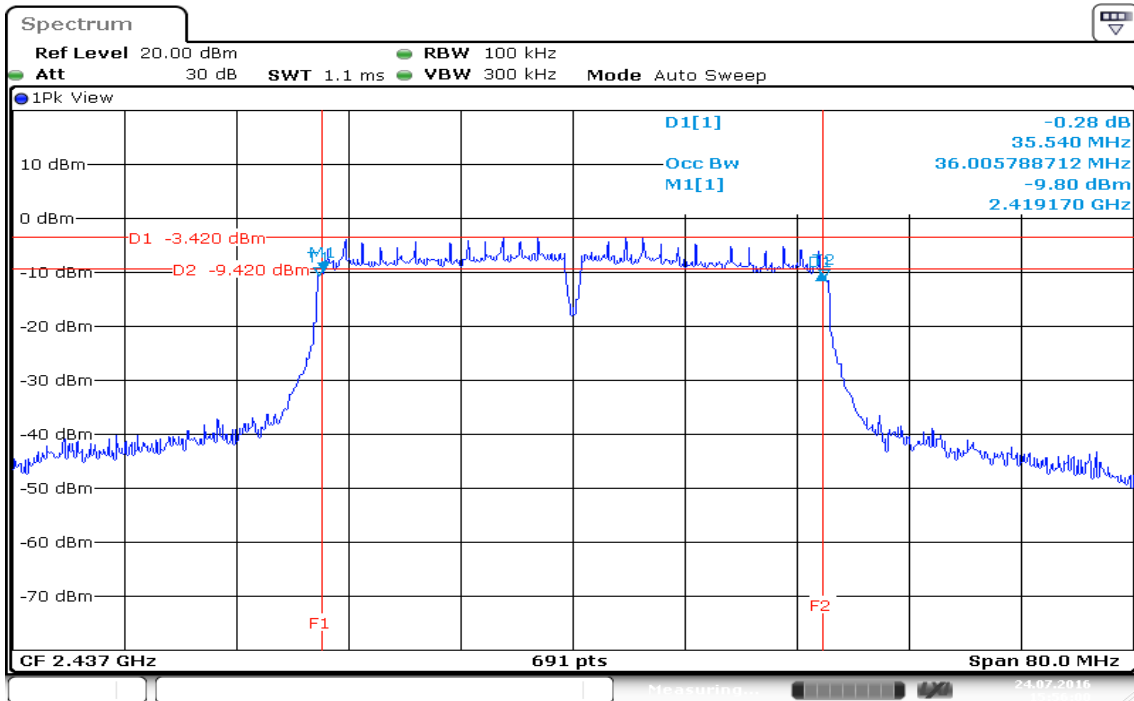

6dB Bandwidth (CH High)

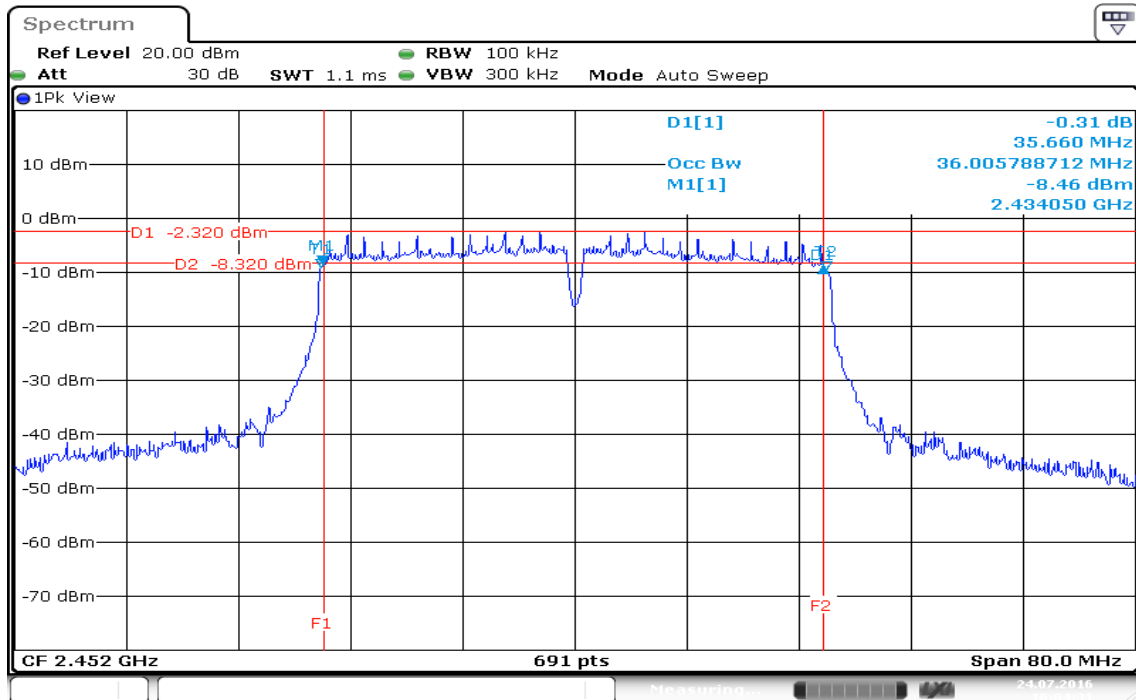

Date: 24 JUL 2016 16:04:30

IEEE 802.11n HT 40 MHz mode / Chain 1

6dB Bandwidth (CH Low)

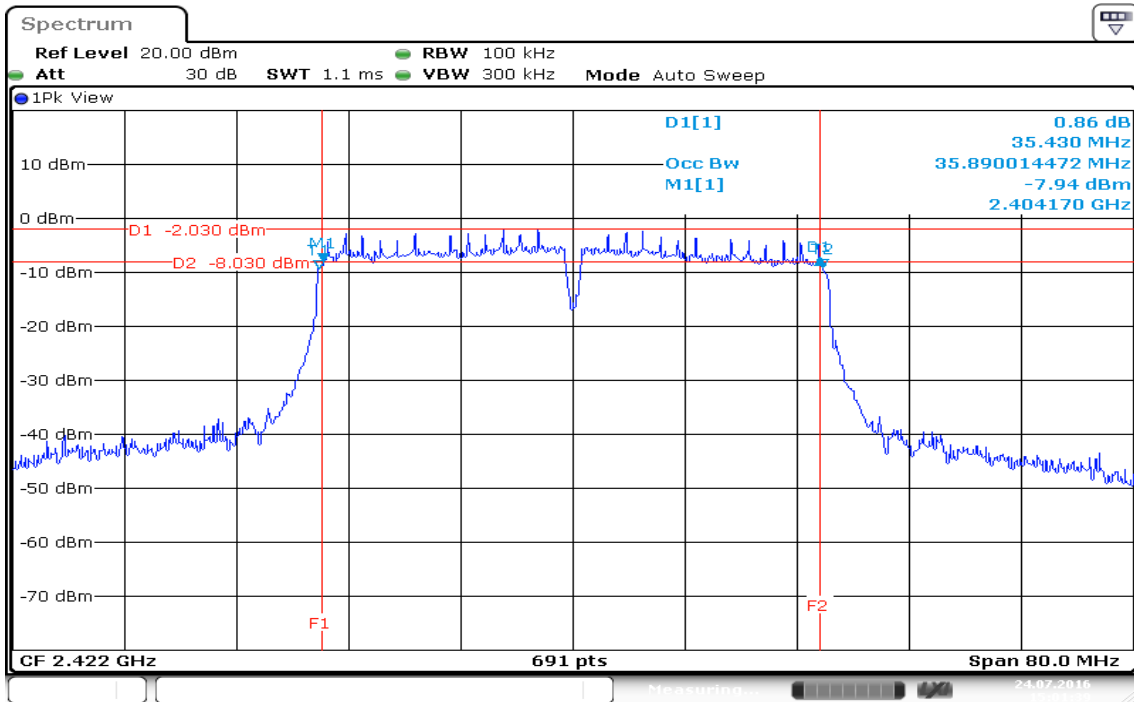

6dB Bandwidth (CH Mid)

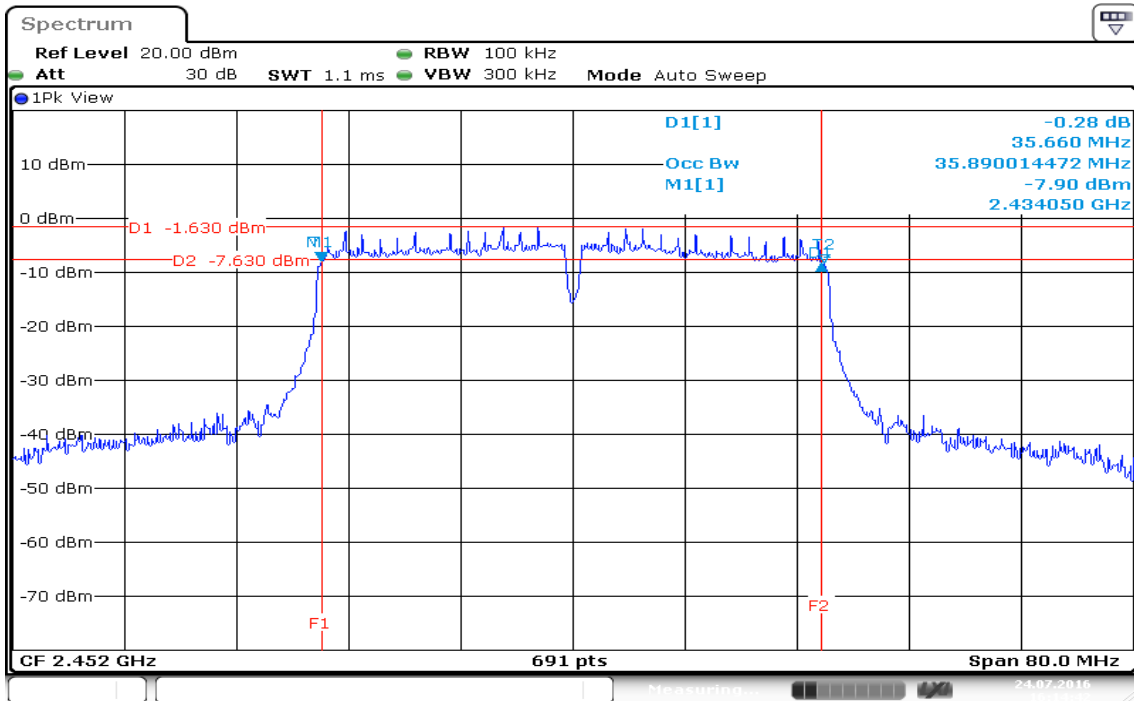

6dB Bandwidth (CH High)

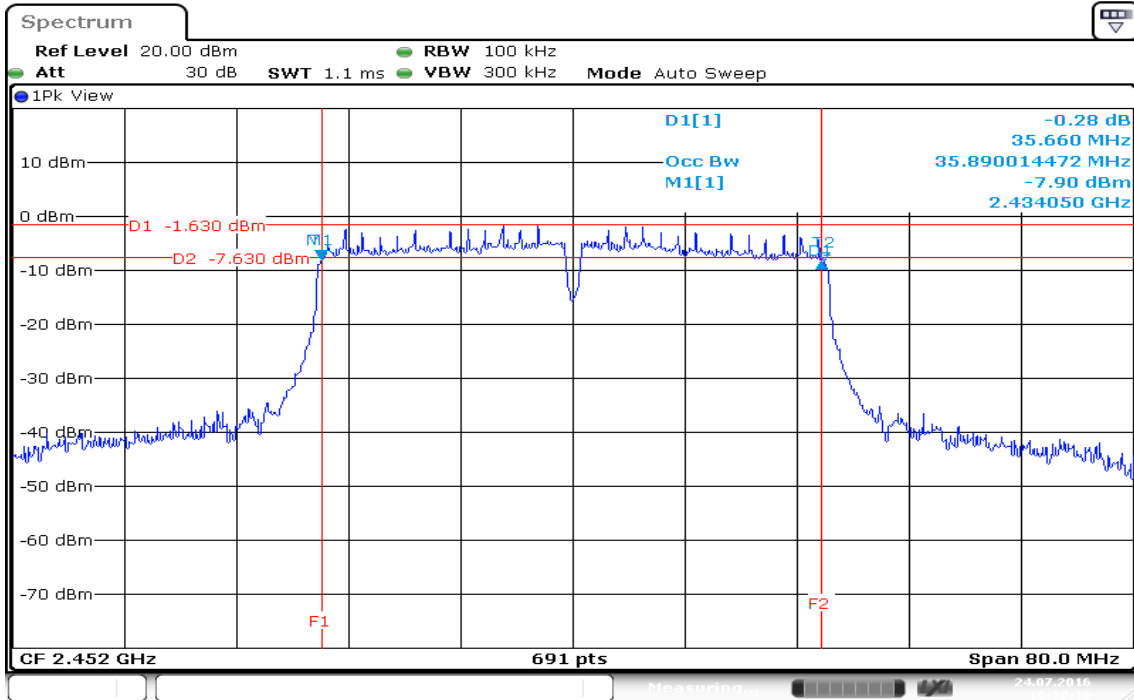

Date: 24 JUL 2016 16:20:16

7.3 PEAK POWER

LIMIT

The maximum peak output power of the intentional radiator shall not exceed the following:

1. According to §15.247(b)(3), for systems using digital modulation in the bands of 902-928 MHz, 2400-2483.5 MHz, and 5725-5850 MHz: 1 Watt.
2. According to §15.247(b)(4), the conducted output power limit specified in paragraph (b) of this section is based on the use of antennas with directional gains that do not exceed 6 dBi. Except as shown in paragraph (c) of this section, if transmitting antennas of directional gain greater than 6 dBi are used, the conducted output power from the intentional radiator shall be reduced below the stated values in paragraphs (b)(1), (b)(2), and (b)(3) of this section, as appropriate, by the amount in dB that the directional gain of the antenna exceeds 6 dBi.
3. According to RSS-247, for systems employing digital modulation techniques operating in the bands 902-928 MHz, 2400-2483.5 MHz and 5725-5850 MHz, the maximum peak conducted output power shall not exceed 1 W.

Test Configuration

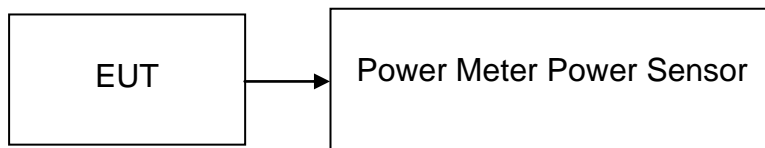

TEST PROCEDURE

The transmitter output is connected to the Power Meter. The Power Meter is set to the peak power detection.

TEST RESULTS

No non-compliance noted

Test Data

IEEE 802.11b mode

Channel	Frequency (MHz)	Output Power (dBm)	Output Power (W)	Limit (dBm)	Result
Low	2412	20.74	0.1186	30	PASS
Mid	2437	*21.64	0.1459		PASS
High	2462	21.57	0.1435		PASS

IEEE 802.11g mode

Channel	Frequency (MHz)	Output Power (dBm)	Output Power (W)	Limit (dBm)	Result
Low	2412	19.52	0.0895	30	PASS
Mid	2437	*24.86	0.3062		PASS
High	2462	19.22	0.0836		PASS

IEEE 802.11n HT 20 MHz mode

Channel	Frequency (MHz)	Chain 0 Output Power (dBm)	Chain 1 Output Power (dBm)	Total Output Power (dBm)	Output Power (W)	Limit (dBm)	Result
Low	2412	19.09	20.65	22.95	0.1972	30	PASS
Mid	2437	25.48	25.46	*28.48	0.7047		PASS
High	2462	22.08	22.11	25.11	0.3243		PASS

IEEE 802.11n HT 40 MHz mode

Channel	Frequency (MHz)	Chain 0 Output Power (dBm)	Chain 1 Output Power (dBm)	Total Output Power (dBm)	Output Power (W)	Limit (dBm)	Result
Low	2422	17.22	17.87	20.57	0.1140	30	PASS
Mid	2437	20.13	20.8	*23.49	0.2234		PASS
High	2452	17.94	19.38	21.73	0.1489		PASS

Remark:

1. Total Output Power (w) = Chain 0 (10^(Output Power /10)/1000)+ Chain 1 (10^(Output Power /10)/1000)

7.4 AVERAGE POWER

LIMIT

None; for reporting purposes only.

Test Configuration

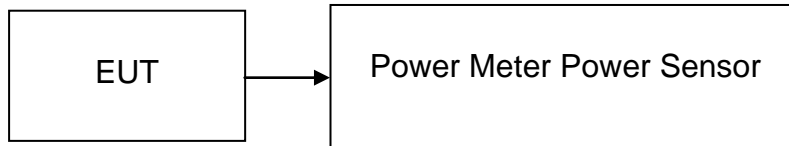

TEST PROCEDURE

The transmitter output is connected to the Power Meter. The Power Meter is set to the peak power detection.

TEST RESULTS

No non-compliance noted

Test Data

Test mode: IEEE 802.11b mode

Channel	Frequency (MHz)	Output Power (dBm)	Output Power (W)
Low	2412	17.04	0.0506
Mid	2437	18.00	0.0631
High	2462	16.89	0.0489

Test mode: IEEE 802.11g mode

Channel	Frequency (MHz)	Output Power (dBm)	Output Power (W)
Low	2412	16.28	0.0425
Mid	2437	22.52	0.1786
High	2462	15.79	0.0379

Test mode: IEEE 802.11n HT 20 MHz mode

Channel	Frequency (MHz)	Chain 0 Output Power (dBm)	Chain 1 Output Power (dBm)	Total Output Power (dBm)	Output Power (W)
Low	2412	9.94	10.28	13.12	0.0205
Mid	2437	19.68	19.20	22.46	0.1762
High	2462	12.05	12.19	15.13	0.0326

Test mode: IEEE 802.11n HT 40 MHz mode

Channel	Frequency (MHz)	Chain 0 Output Power (dBm)	Chain 1 Output Power (dBm)	Total Output Power (dBm)	Output Power (W)
Low	2422	8.31	9.08	11.72	0.0149
Mid	2437	10.05	10.71	13.40	0.0219
High	2452	9.45	9.42	12.45	0.0176

Remark: Total Output Power (w) = Chain 0 (10^{^(Output Power /10)}/1000) + Chain 1 (10^{^(Output Power /10)}/1000)

7.5 BAND EDGES MEASUREMENT

LIMIT

According to §15.247(d) & RSS-247, in any 100 kHz bandwidth outside the frequency bands in which the spread spectrum intentional radiator is operating, the radio frequency power that is produced by the intentional radiator shall be at least 20 dB below that in the 100 kHz bandwidth within the band that contains the highest level of the desired power, based on either an RF conducted or a radiated measurement, provided the transmitter demonstrates compliance with the peak conducted power limits. In addition, radiated emissions which fall in the restricted bands, as defined in §15.205(a), must also comply with the radiated emission limits specified in 15.209(a) (see Section 15.205(c)).

Test Configuration

For Radiated

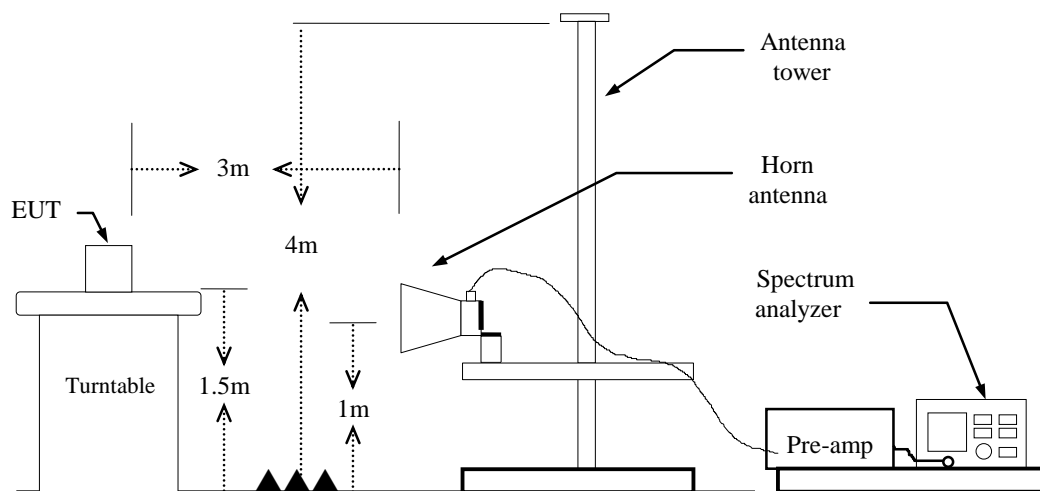

TEST PROCEDURE

For Radiated

1. The EUT is placed on a turntable, which is 1.5m above the ground plane.
2. The turntable shall be rotated for 360 degrees to determine the position of maximum emission level.
3. EUT is set 3m away from the receiving antenna, which is varied from 1m to 4m to find out the highest emission.
4. Set the spectrum analyzer in the following setting in order to capture the lower and upper band-edges of the emission:
 - (a) PEAK: RBW=1MHz / VBW=3MHz / Sweep=AUTO
 - (b) AVERAGE: RBW=1MHz,
if duty cycle $\geq 98\%$, VBW=10Hz.
if duty cycle $< 98\%$ VBW=1/T.
IEEE 802.11b mode: $\geq 98\%$, VBW=10Hz
IEEE 802.11g mode: $\approx 89\%$, VBW=680Hz
IEEE 802.11n HT 20 MHz mode: $\geq 89\%$, VBW=750Hz
IEEE 802.11n HT 40 MHz mode: $\geq 68\%$, VBW=2.7kHz
5. Repeat the procedures until all the PEAK and AVERAGE versus POLARIZATION are measured.
6. Result = Spectrum Reading + cable loss(spectrum to Amp) - Amp Gain + Cable loss(Amp to receive Ant)+ Receive Ant

For Un-restricted Band Emissions

The peak output power procedure is used to measure the fundamental emission power to demonstrate compliance to requirements, then the peak conducted output power measured within any 100 kHz outside the authorized frequency band shall be attenuated by at least 20 dB relative to the maximum measured in-band peak PSD level.

TEST RESULTS

Refer to attach spectrum analyzer data chart.

Band Edges

IEEE 802.11b Mode / CH Low

Detector mode: Peak

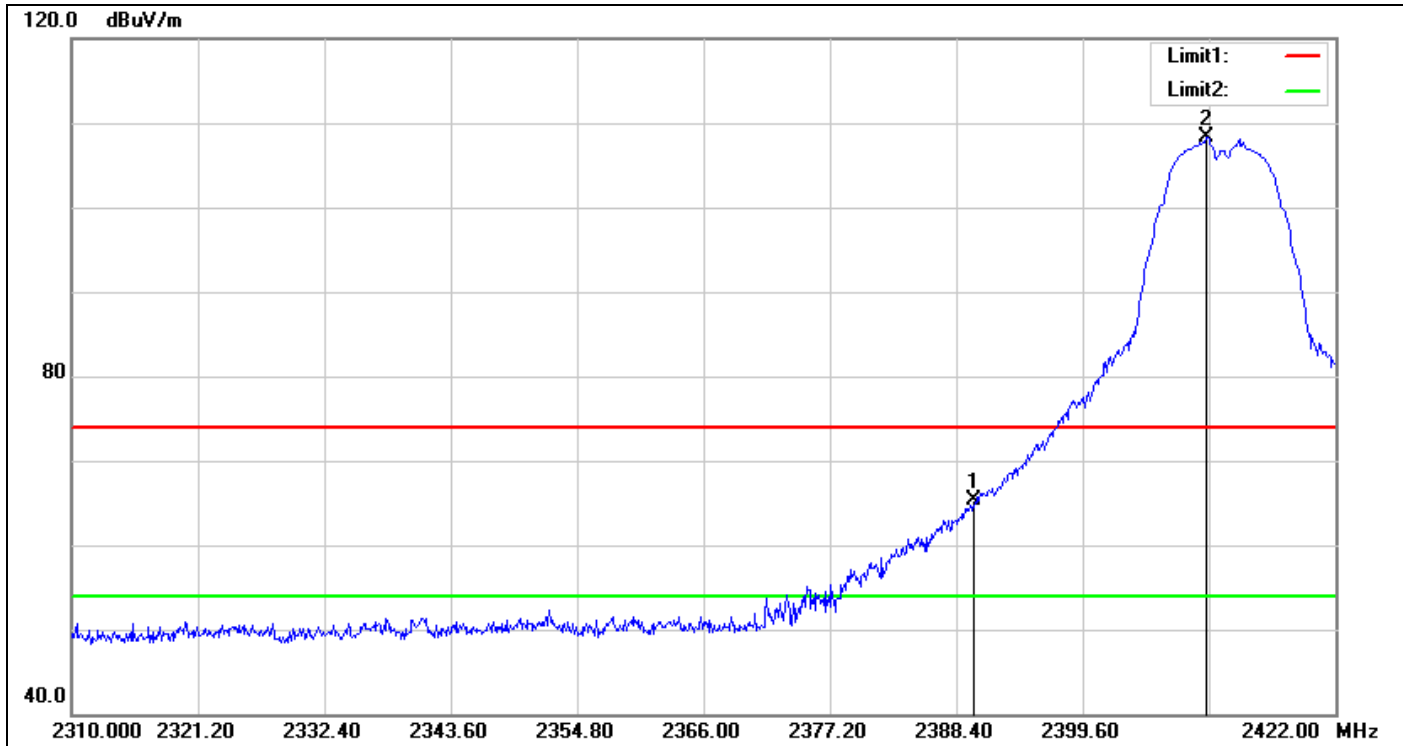

No.	Frequency (MHz)	Reading (dBuV)	Correct Factor(dB/m)	Result (dBuV/m)	Limit (dBuV/m)	Margin (dB)	Remark
1	2390.000	67.69	-2.49	65.20	74.00	-8.80	peak
2	2410.576	110.70	-2.43	108.27	-	-	peak

Detector mode: Average

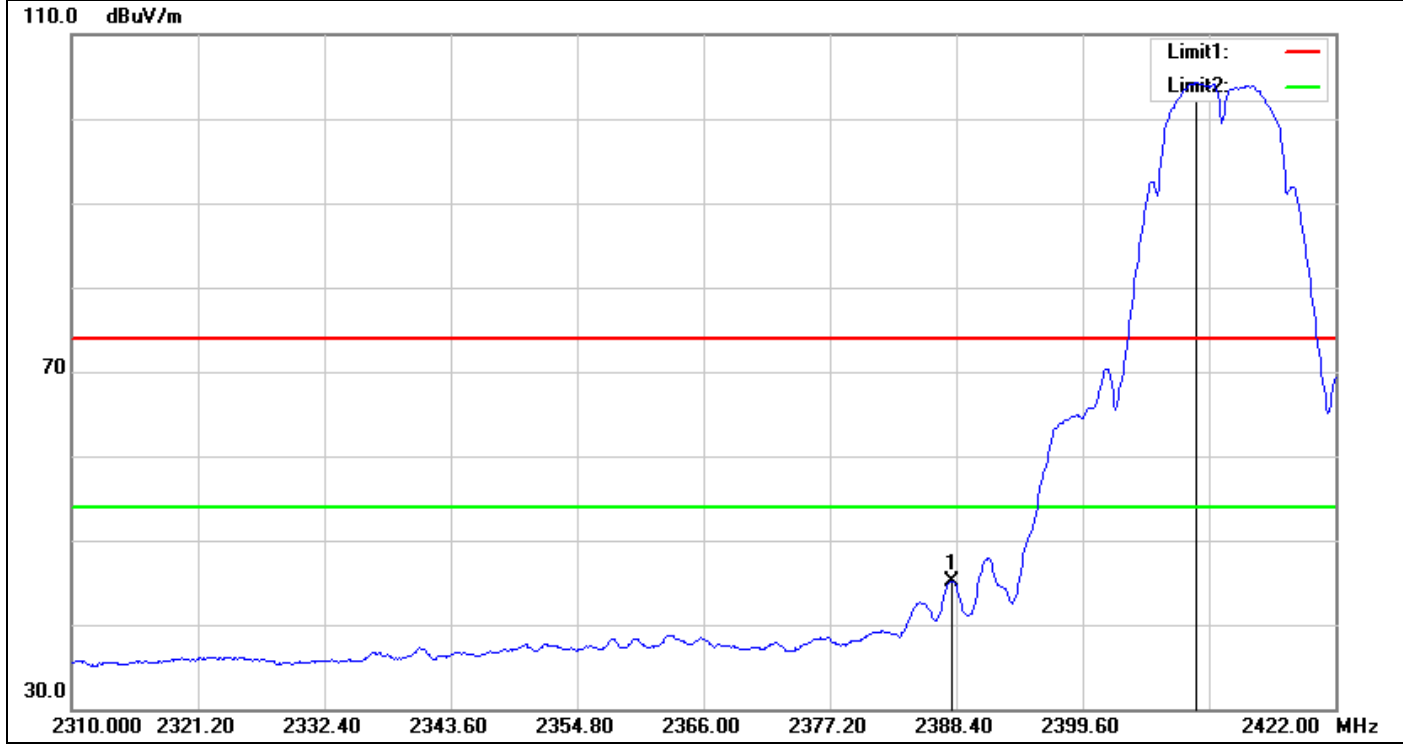

No.	Frequency (MHz)	Reading (dBuV)	Correct Factor(dB/m)	Result (dBuV/m)	Limit (dBuV/m)	Margin (dB)	Remark
1	2388.064	47.60	-2.51	45.09	54.00	-8.91	AVG
2	2409.680	106.71	-2.43	104.28	-	-	AVG

Band Edges

IEEE 802.11b Mode / CH Mid

Detector mode: Peak

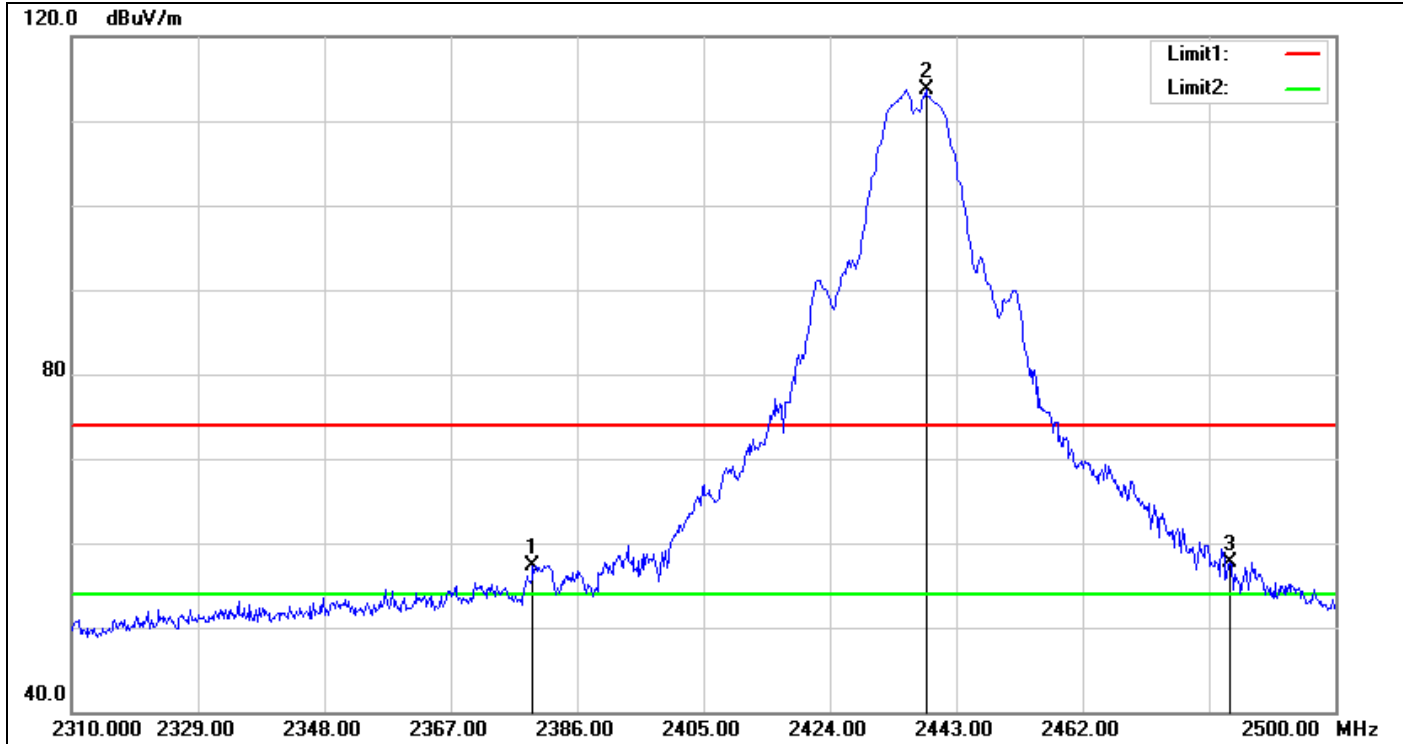

No.	Frequency (MHz)	Reading (dBuV)	Correct Factor(dB/m)	Result (dBuV/m)	Limit (dBuV/m)	Margin (dB)	Remark
1	2379.350	59.94	-2.58	57.36	74.00	-16.64	peak
2	2438.440	115.96	-2.22	113.74	-	-	peak
3	2484.230	59.71	-1.99	57.72	74.00	-16.28	peak

Detector mode: Average

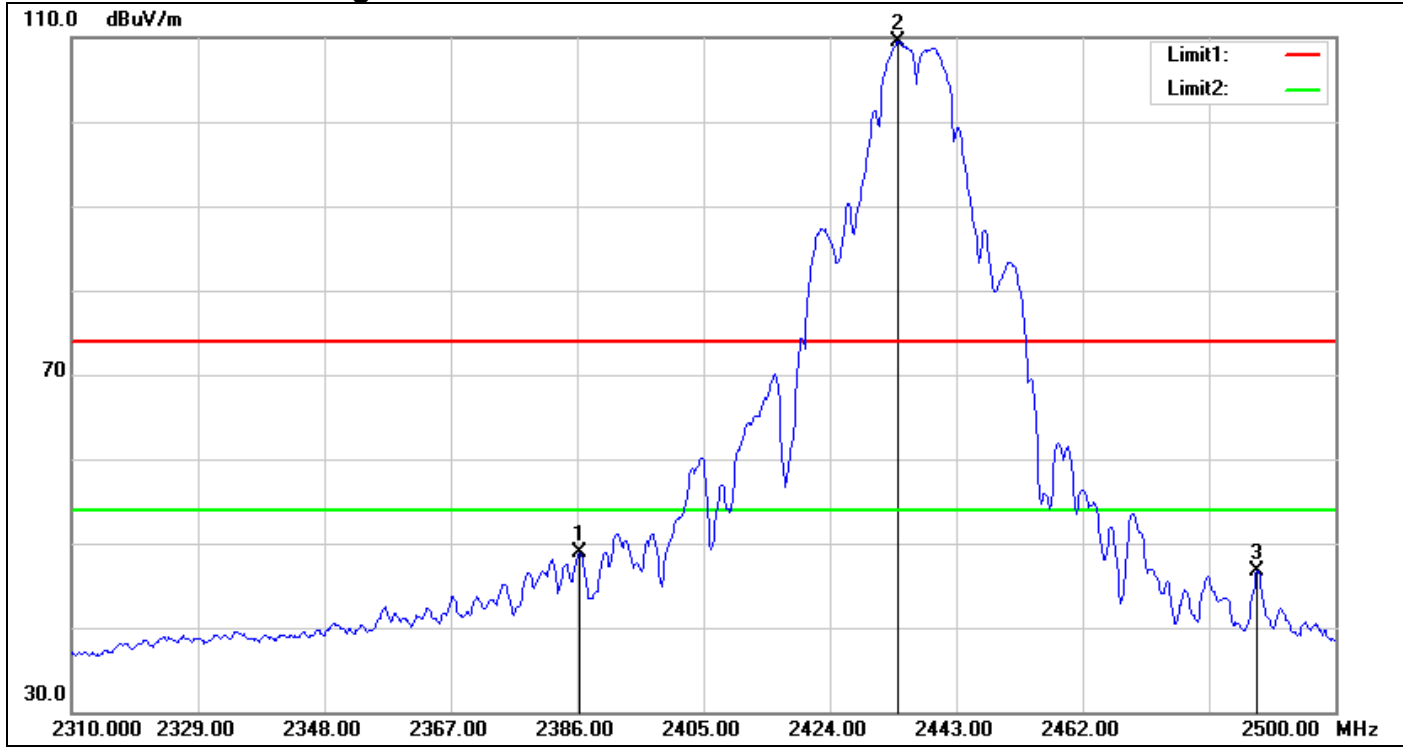

No.	Frequency (MHz)	Reading (dBuV)	Correct Factor(dB/m)	Result (dBuV/m)	Limit (dBuV/m)	Margin (dB)	Remark
1	2386.380	51.33	-2.52	48.81	54.00	-5.19	AVG
2	2434.260	111.69	-2.25	109.44	-	-	AVG
3	2488.220	48.69	-1.95	46.74	54.00	-7.26	AVG

Band Edges

IEEE 802.11b Mode / CH High

Detector mode: Peak

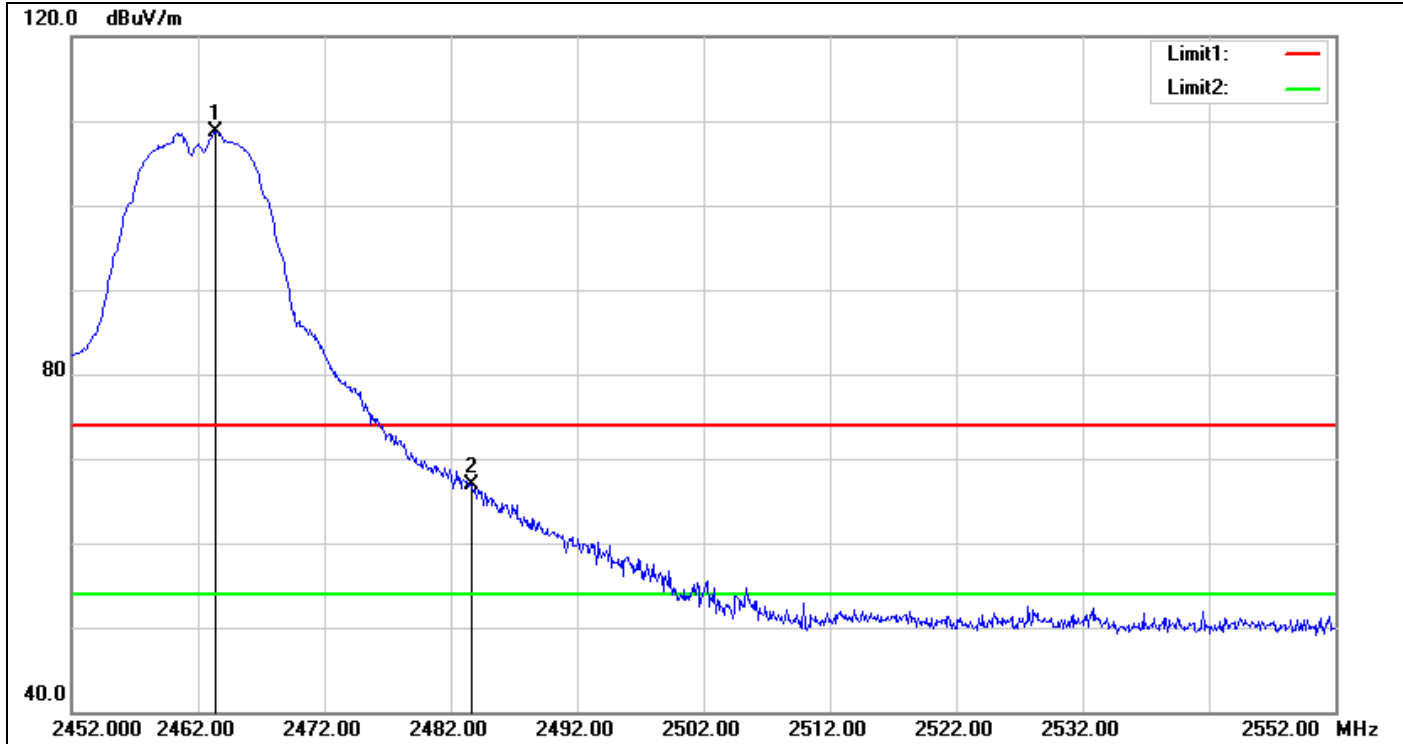

No.	Frequency (MHz)	Reading (dBuV)	Correct Factor(dB/m)	Result (dBuV/m)	Limit (dBuV/m)	Margin (dB)	Remark
1	2463.400	110.79	-2.09	108.70	-	-	peak
2	2483.700	68.97	-1.99	66.98	74.00	-7.02	peak

Detector mode: Average

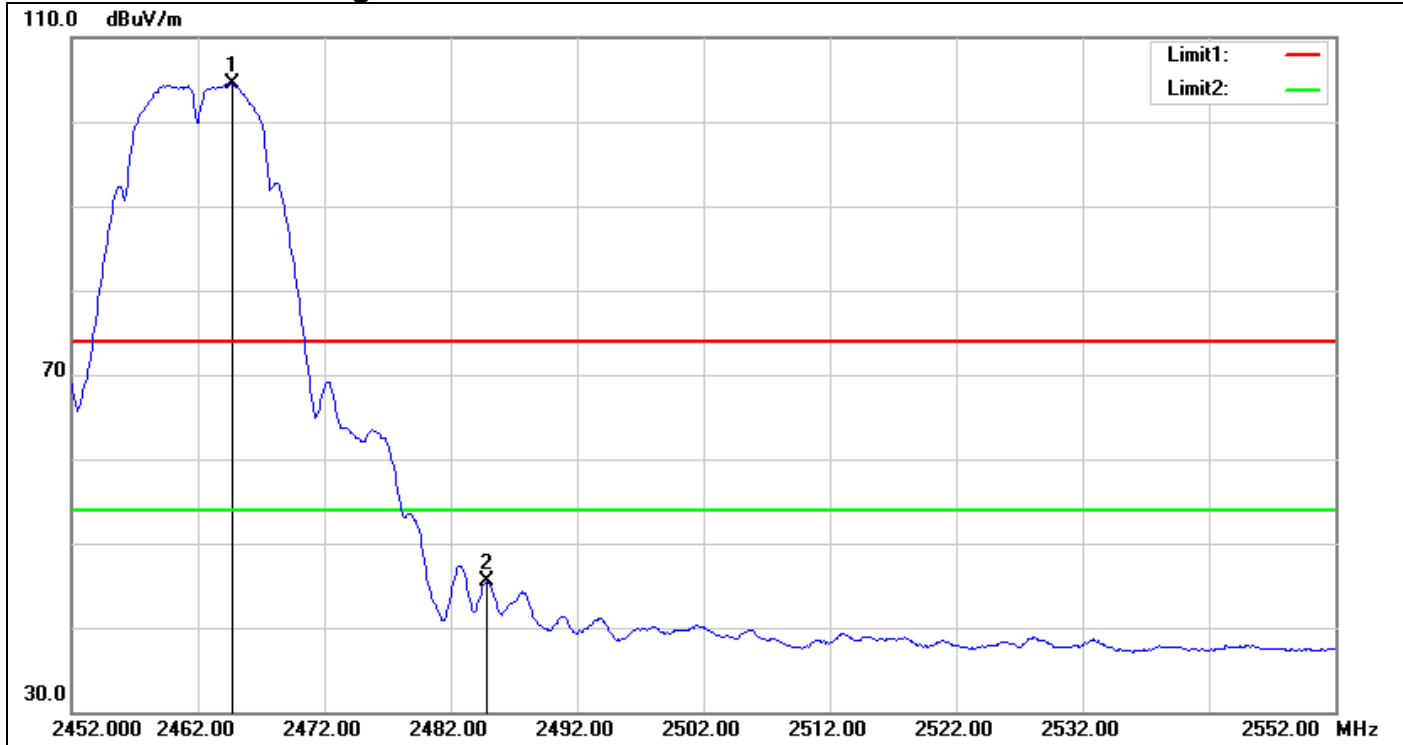

No.	Frequency (MHz)	Reading (dBuV)	Correct Factor(dB/m)	Result (dBuV/m)	Limit (dBuV/m)	Margin (dB)	Remark
1	2464.700	106.55	-2.09	104.46	-	-	peak
2	2484.900	47.43	-1.98	45.45	74.00	-28.55	peak

Band Edges

IEEE 802.11g Mode / CH Low

Detector mode: Peak

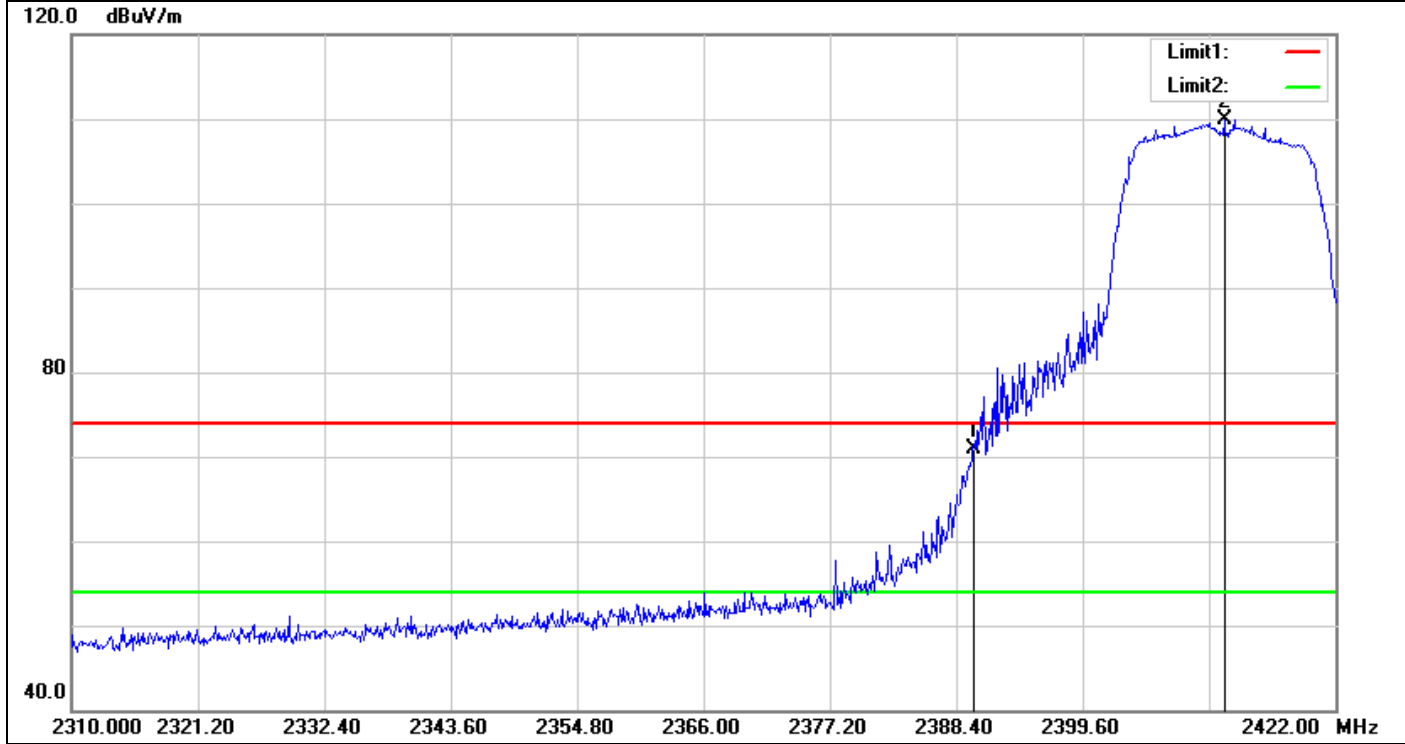

No.	Frequency (MHz)	Reading (dBuV)	Correct Factor(dB/m)	Result (dBuV/m)	Limit (dBuV/m)	Margin (dB)	Remark
1	2390.000	73.34	-2.49	70.85	74.00	-3.15	peak
2	2412.144	112.36	-2.41	109.95	-	-	peak

Detector mode: Average

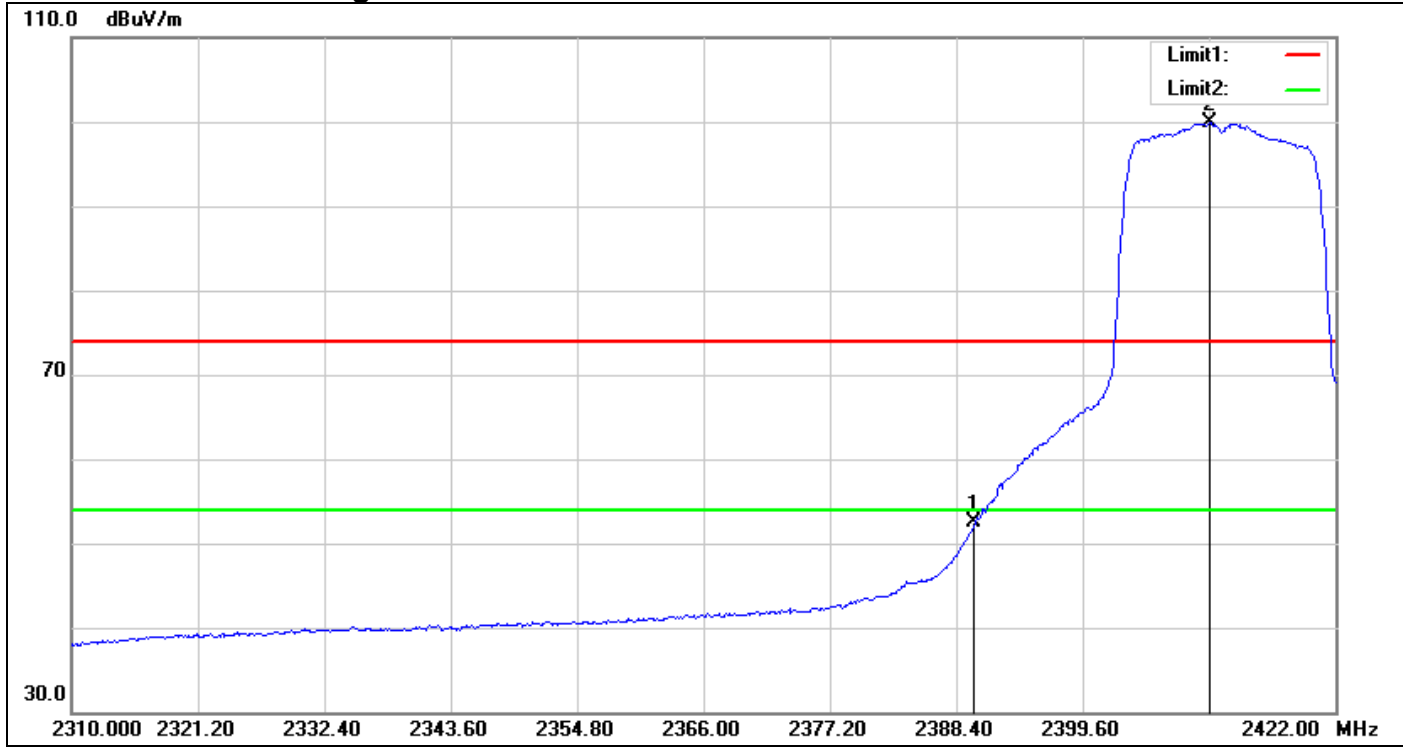

No.	Frequency (MHz)	Reading (dBuV)	Correct Factor(dB/m)	Result (dBuV/m)	Limit (dBuV/m)	Margin (dB)	Remark
1	2390.000	55.00	-2.49	52.51	54.00	-1.49	AVG
2	2410.912	102.36	-2.42	99.94	-	-	AVG

Band Edges

IEEE 802.11g Mode / CH Mid

Detector mode: Peak

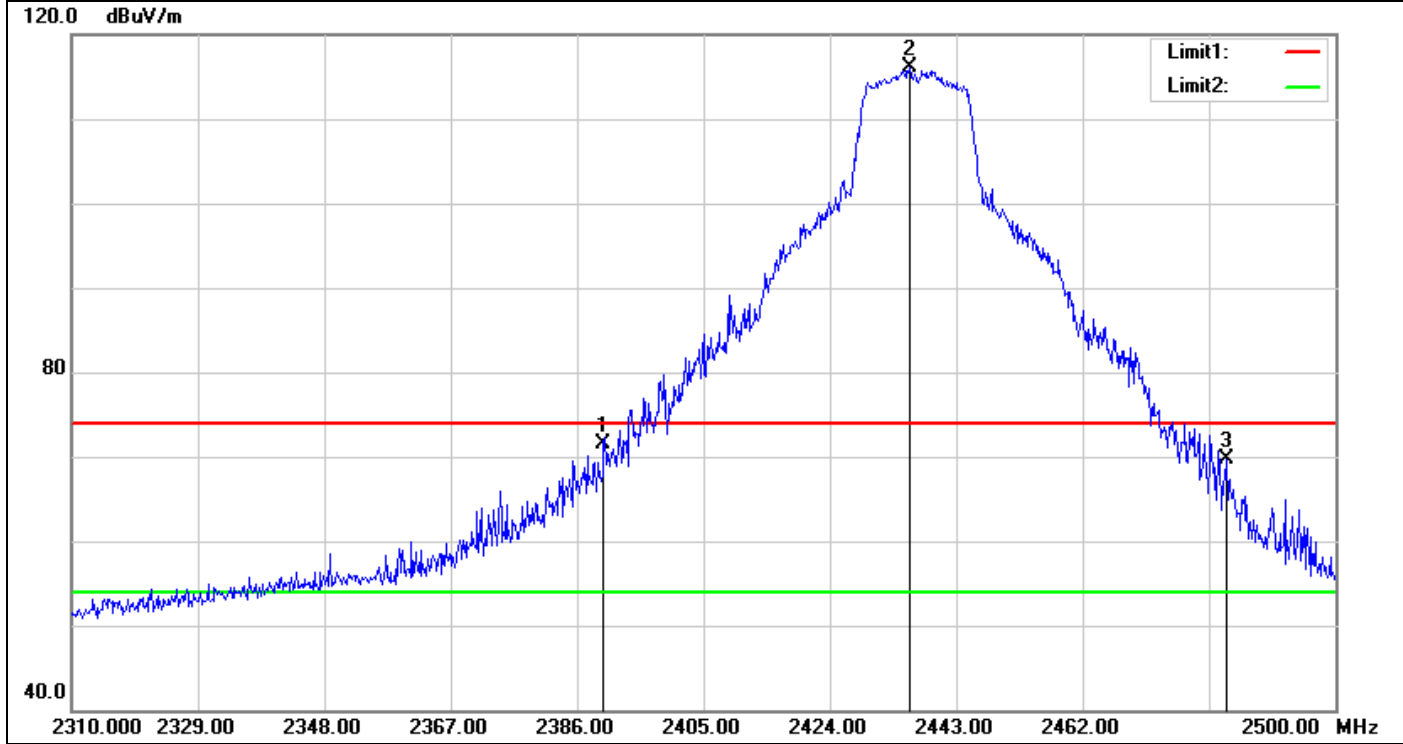

No.	Frequency (MHz)	Reading (dBuV)	Correct Factor(dB/m)	Result (dBuV/m)	Limit (dBuV/m)	Margin (dB)	Remark
1	2389.990	73.99	-2.49	71.50	74.00	-2.50	peak
2	2435.970	118.27	-2.24	116.03	-	-	peak
3	2483.660	71.75	-1.99	69.76	74.00	-4.24	peak

Detector mode: Average

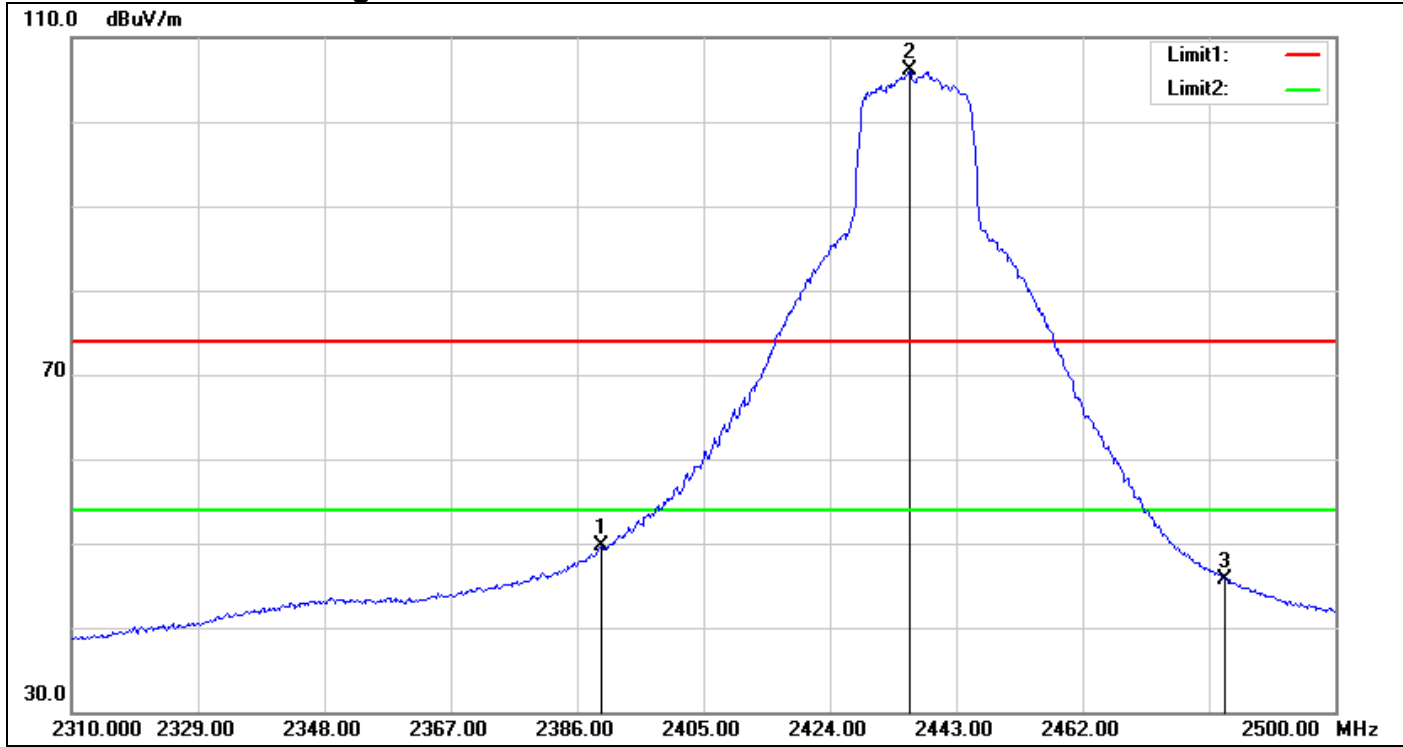

No.	Frequency (MHz)	Reading (dBuV)	Correct Factor(dB/m)	Result (dBuV/m)	Limit (dBuV/m)	Margin (dB)	Remark
1	2389.610	52.12	-2.49	49.63	54.00	-4.37	AVG
2	2435.970	108.27	-2.24	106.03	-	-	AVG
3	2483.470	47.72	-2.00	45.72	54.00	-8.28	AVG

Band Edges

IEEE 802.11g Mode / CH High

Detector mode: Peak

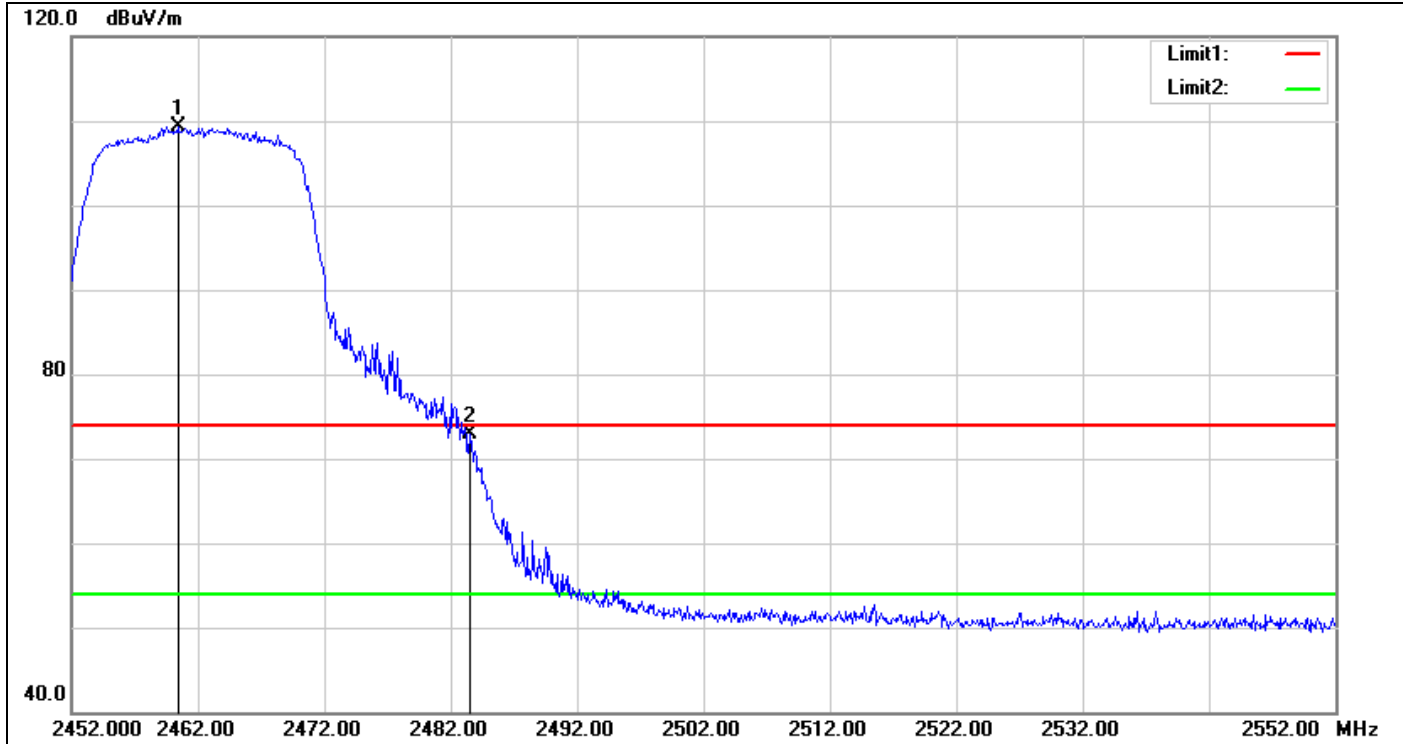

No.	Frequency (MHz)	Reading (dBuV)	Correct Factor(dB/m)	Result (dBuV/m)	Limit (dBuV/m)	Margin (dB)	Remark
1	2460.400	111.49	-2.10	109.39	-	-	peak
2	2483.500	74.96	-1.99	72.97	74.00	-1.03	peak

Detector mode: Average

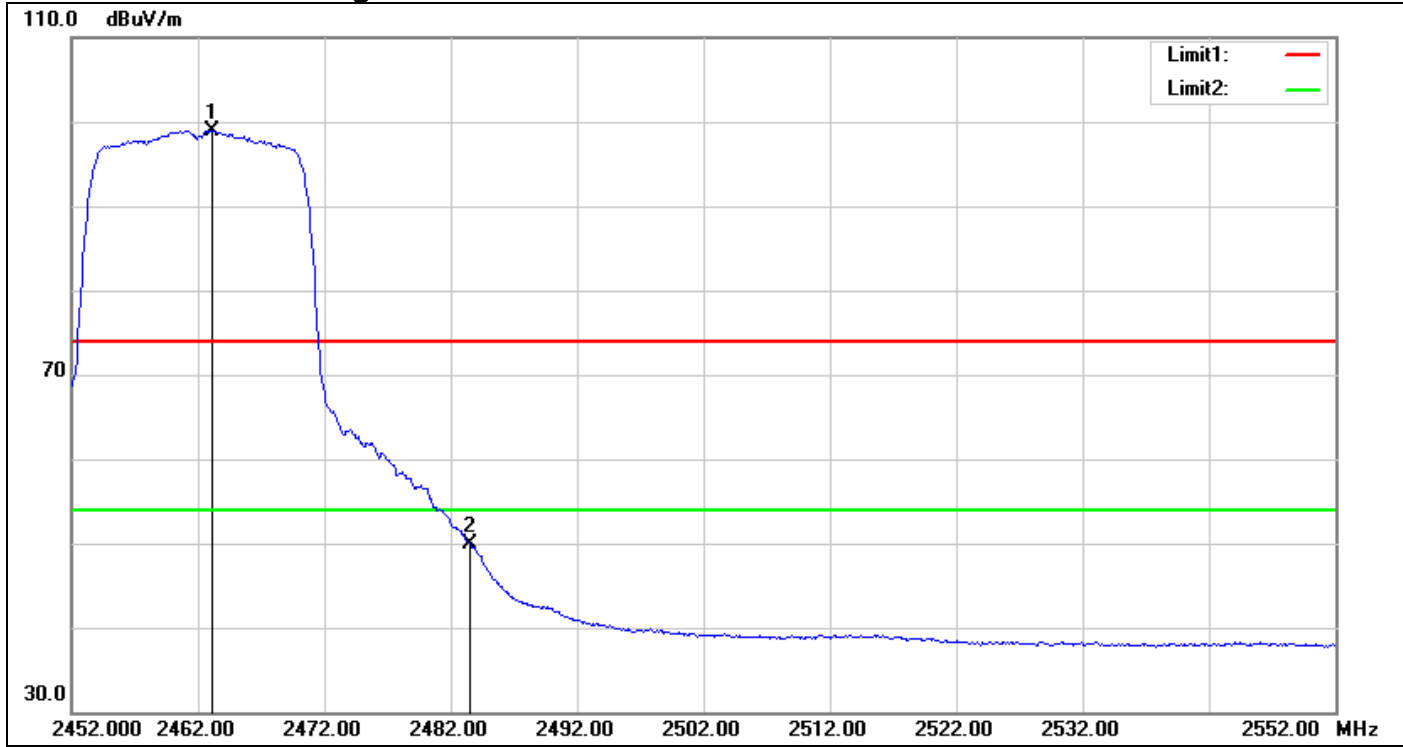

No.	Frequency (MHz)	Reading (dBuV)	Correct Factor(dB/m)	Result (dBuV/m)	Limit (dBuV/m)	Margin (dB)	Remark
1	2463.100	101.05	-2.09	98.96	-	-	AVG
2	2483.500	51.86	-1.99	49.87	54.00	-4.13	AVG

Band Edges

IEEE 802.11n HT 20 MHz Mode / CH Low

Detector mode: Peak

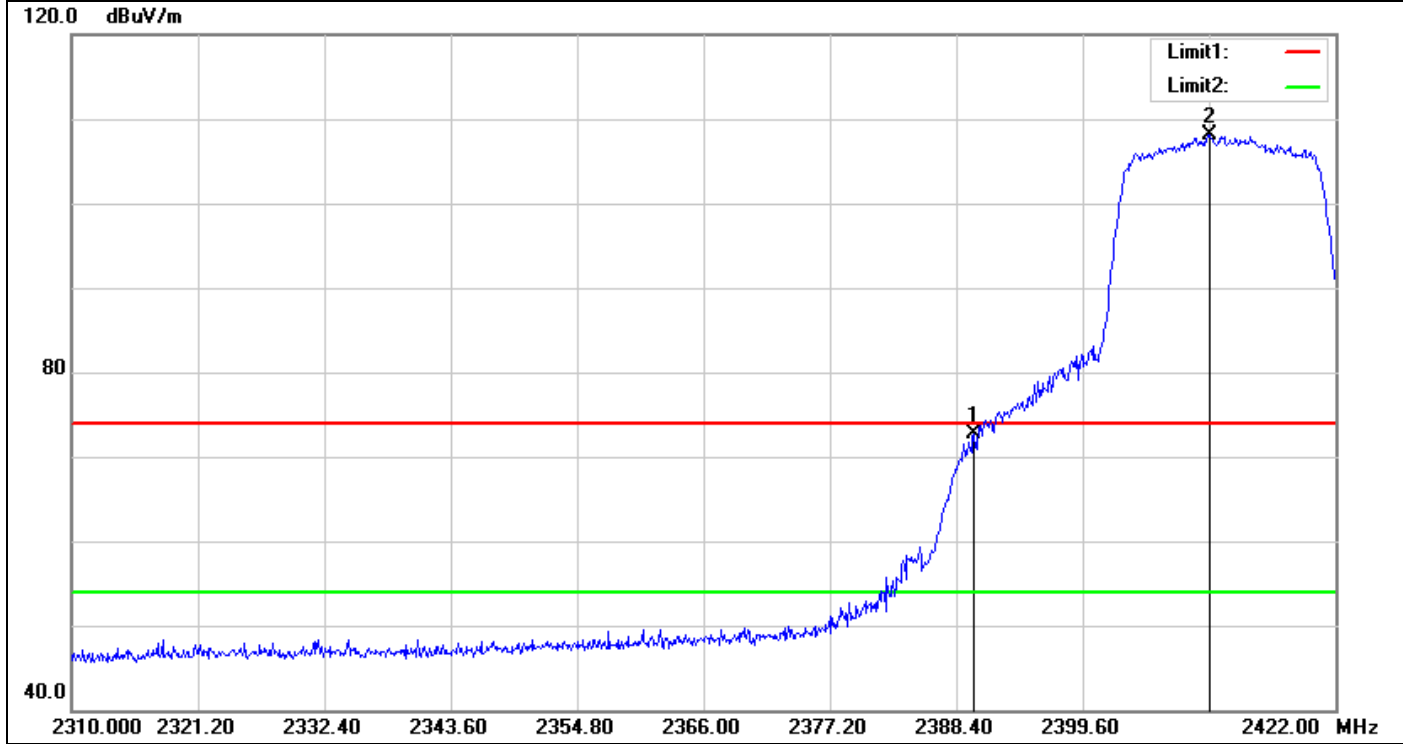

No.	Frequency (MHz)	Reading (dBuV)	Correct Factor(dB/m)	Result (dBuV/m)	Limit (dBuV/m)	Margin (dB)	Remark
1	2389.968	75.19	-2.49	72.70	74.00	-1.30	peak
2	2410.800	110.52	-2.42	108.10	-	-	peak

Detector mode: Average

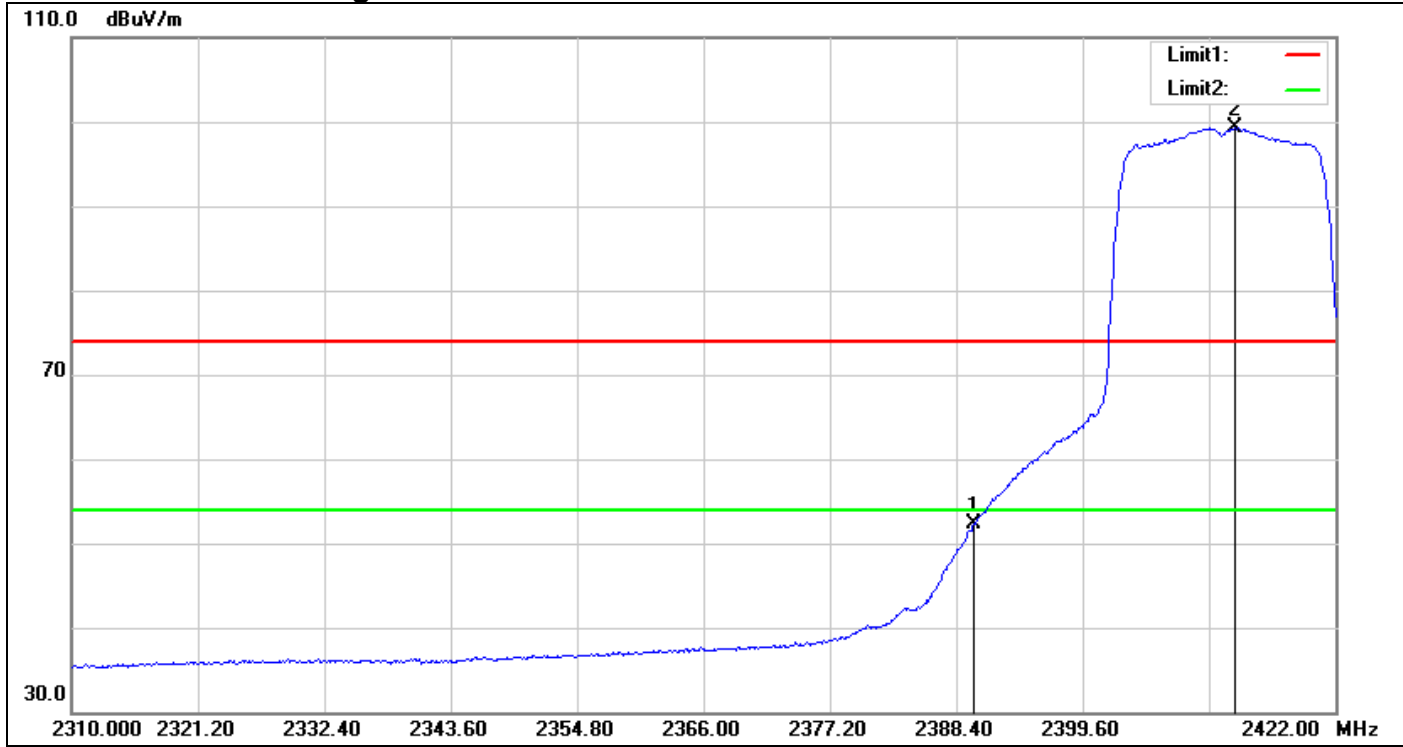

No.	Frequency (MHz)	Reading (dBuV)	Correct Factor(dB/m)	Result (dBuV/m)	Limit (dBuV/m)	Margin (dB)	Remark
1	2389.968	54.78	-2.49	52.29	54.00	-1.71	AVG
2	2413.152	101.75	-2.41	99.34	-	-	AVG

Band Edges

IEEE 802.11n HT 20 MHz Mode / CH Mid

Detector mode: Peak

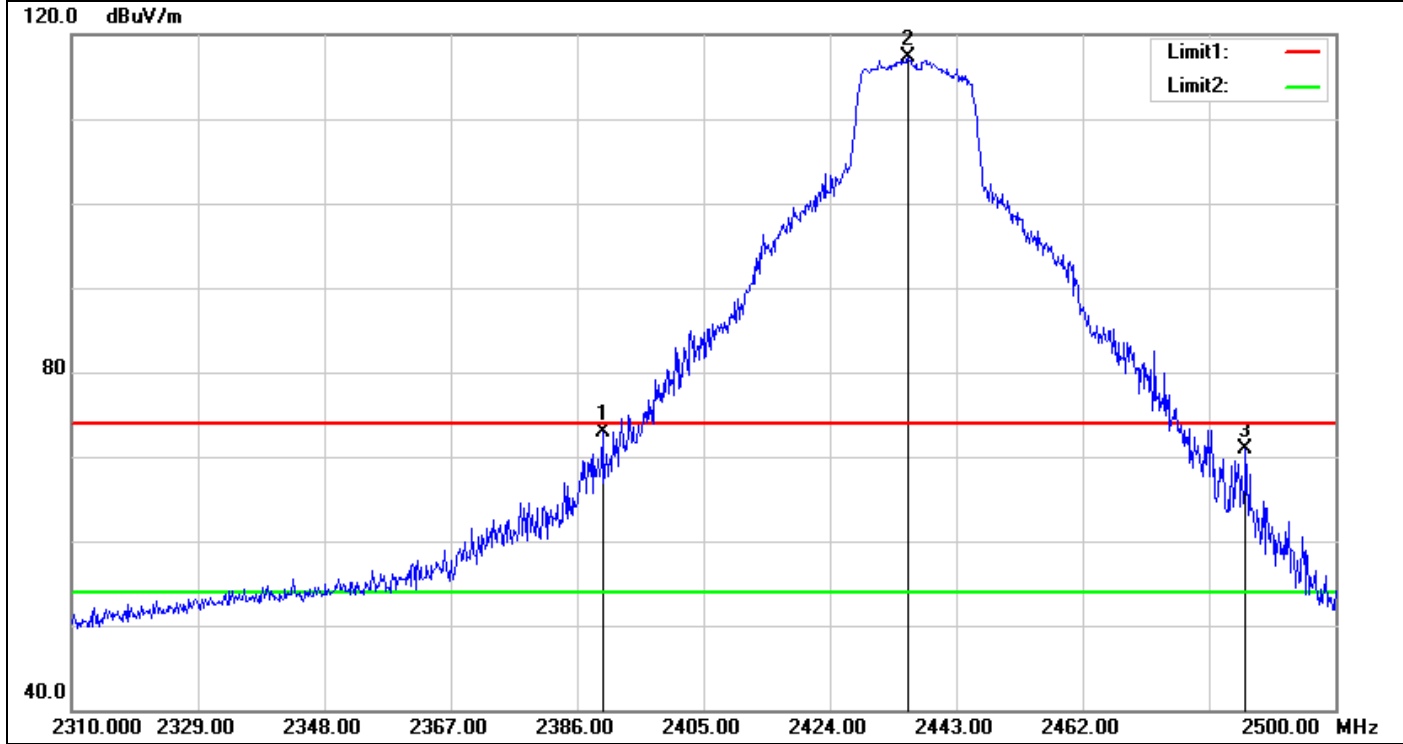

No.	Frequency (MHz)	Reading (dBuV)	Correct Factor(dB/m)	Result (dBuV/m)	Limit (dBuV/m)	Margin (dB)	Remark
1	2389.800	75.36	-2.49	72.87	74.00	-1.13	peak
2	2435.780	119.55	-2.24	117.31	-	-	peak
3	2486.510	72.83	-1.96	70.87	74.00	-3.13	peak

Detector mode: Average

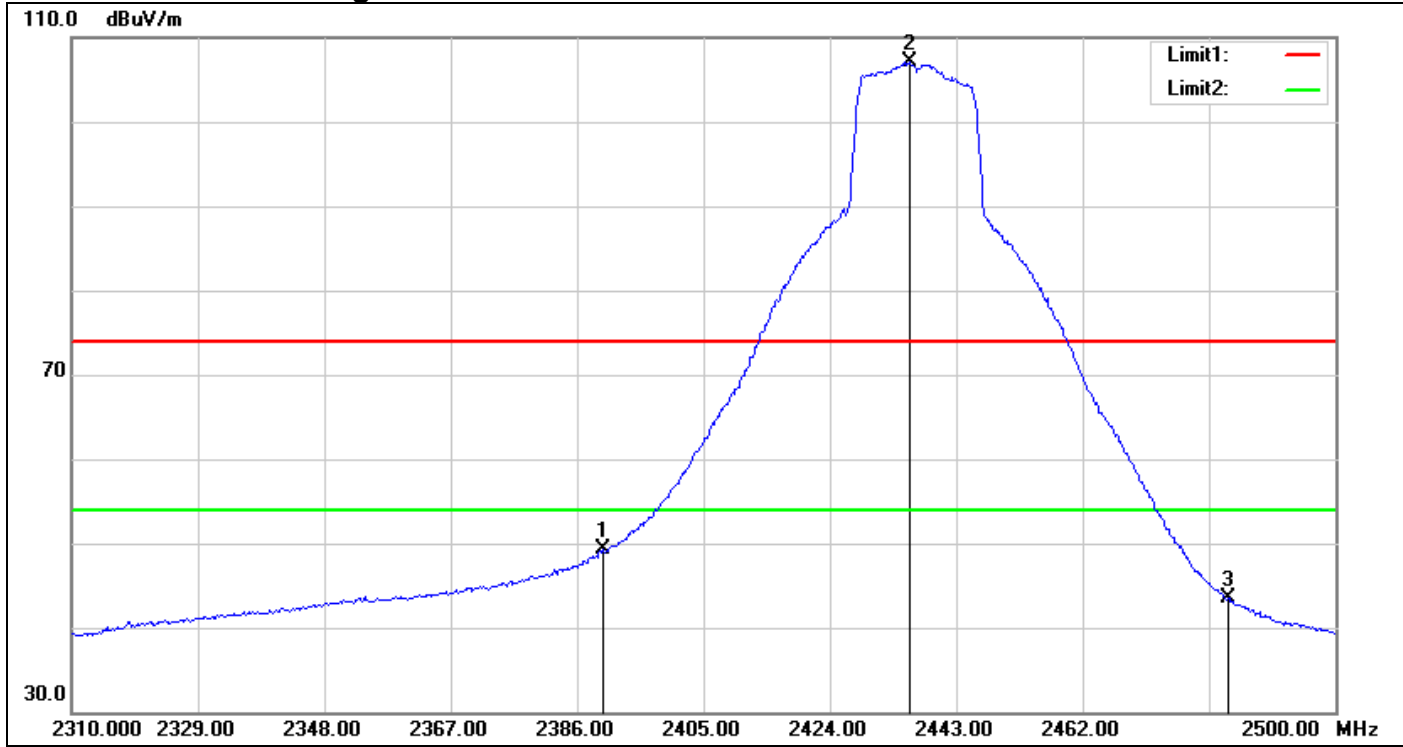

No.	Frequency (MHz)	Reading (dBuV)	Correct Factor(dB/m)	Result (dBuV/m)	Limit (dBuV/m)	Margin (dB)	Remark
1	2389.800	51.80	-2.49	49.31	54.00	-4.69	AVG
2	2435.970	109.41	-2.24	107.17	-	-	AVG
3	2483.850	45.55	-1.99	43.56	54.00	-10.44	AVG

Band Edges

IEEE 802.11n HT 20 MHz Mode / CH High

Detector mode: Peak

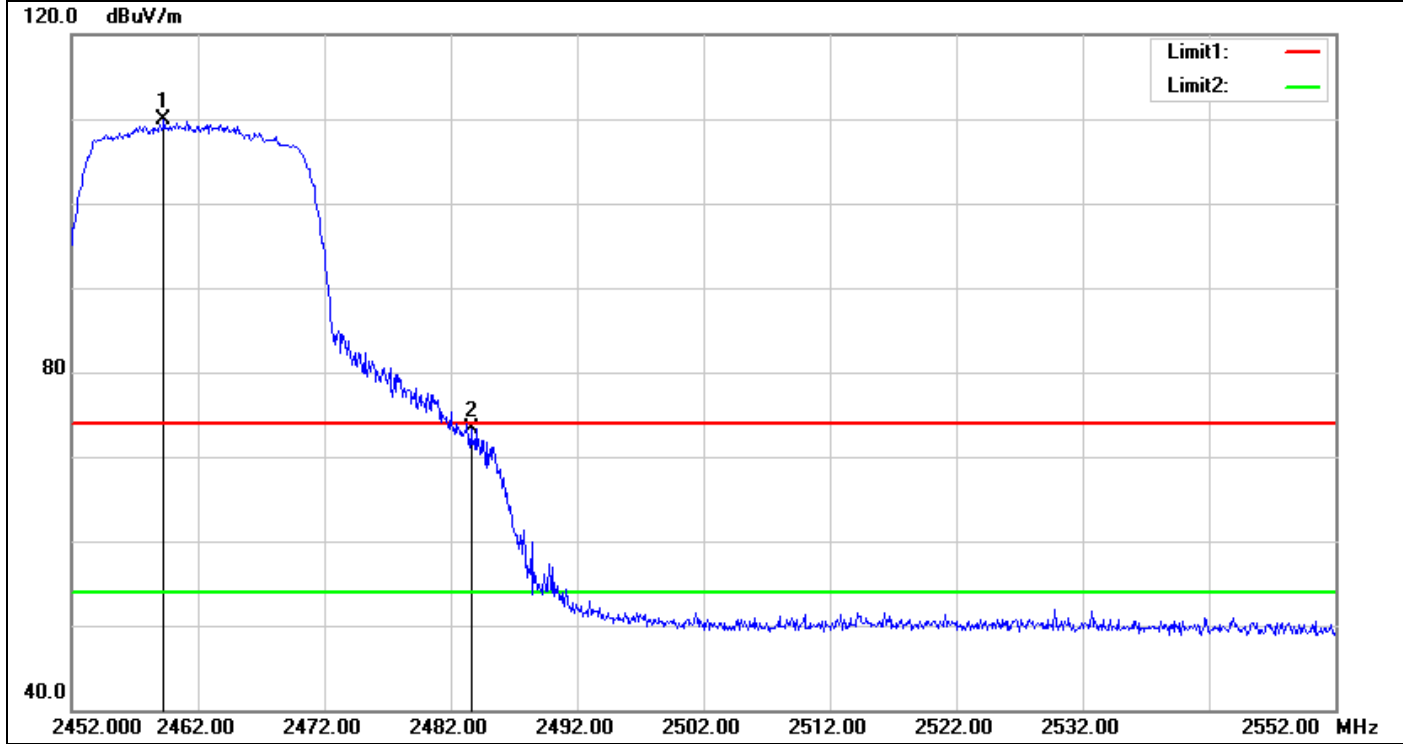

No.	Frequency (MHz)	Reading (dBuV)	Correct Factor(dB/m)	Result (dBuV/m)	Limit (dBuV/m)	Margin (dB)	Remark
1	2459.300	111.98	-2.11	109.87	-	-	peak
2	2483.600	75.26	-1.99	73.27	74.00	-0.73	peak

Detector mode: Average

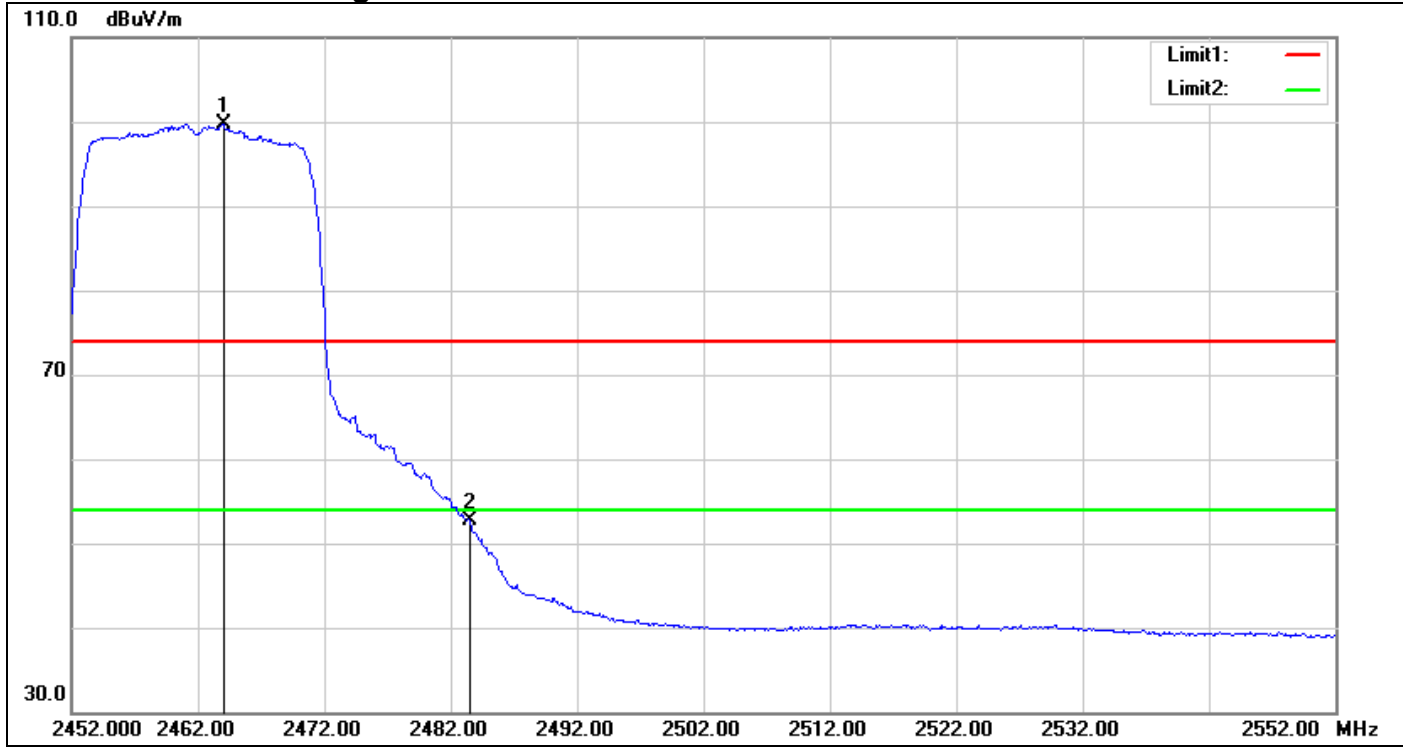

No.	Frequency (MHz)	Reading (dBuV)	Correct Factor(dB/m)	Result (dBuV/m)	Limit (dBuV/m)	Margin (dB)	Remark
1	2464.000	101.86	-2.09	99.77	-	-	AVG
2	2483.500	54.61	-1.99	52.62	54.00	-1.38	AVG

Band Edges

IEEE 802.11n HT 40 MHz Mode / CH Low

Detector mode: Peak

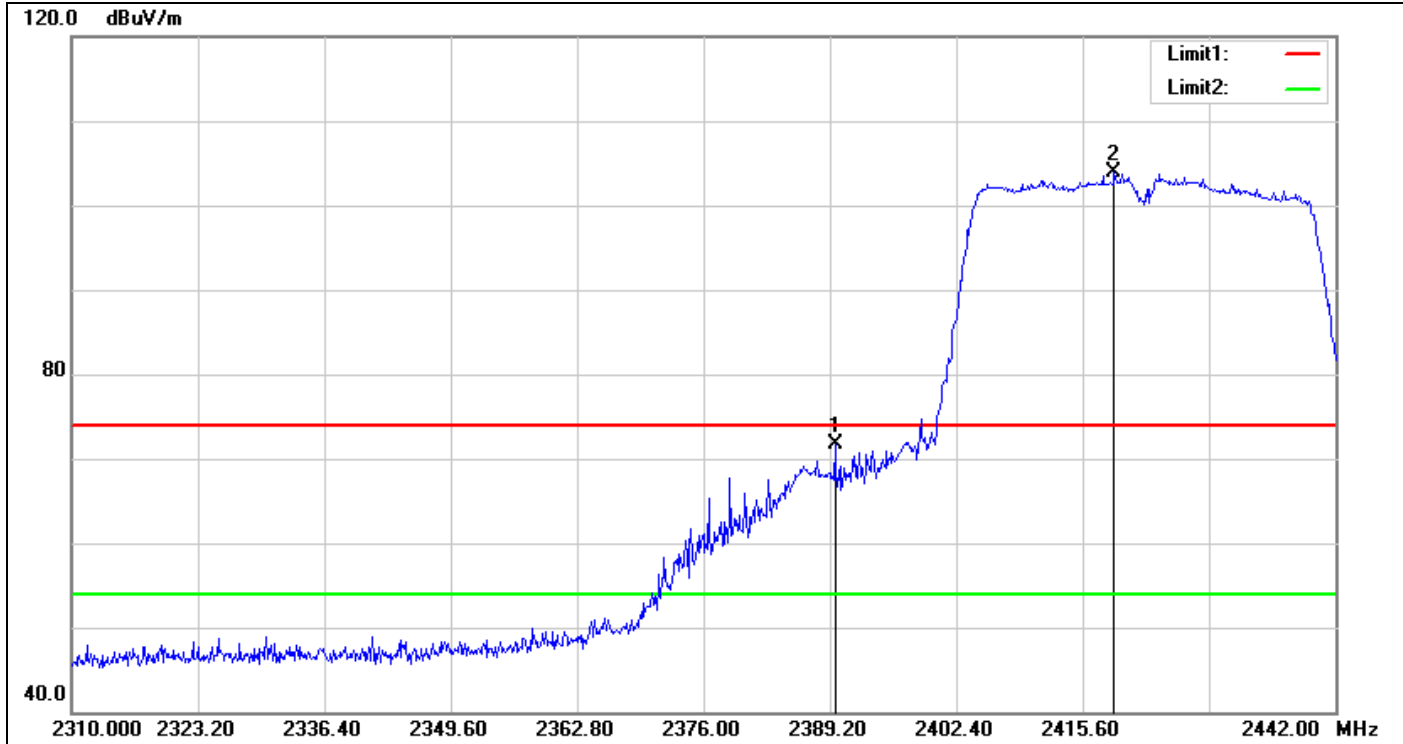

No.	Frequency (MHz)	Reading (dBuV)	Correct Factor(dB/m)	Result (dBuV/m)	Limit (dBuV/m)	Margin (dB)	Remark
1	2389.728	74.28	-2.49	71.79	74.00	-2.21	peak
2	2418.900	106.21	-2.37	103.84	-	-	peak

Detector mode: Average

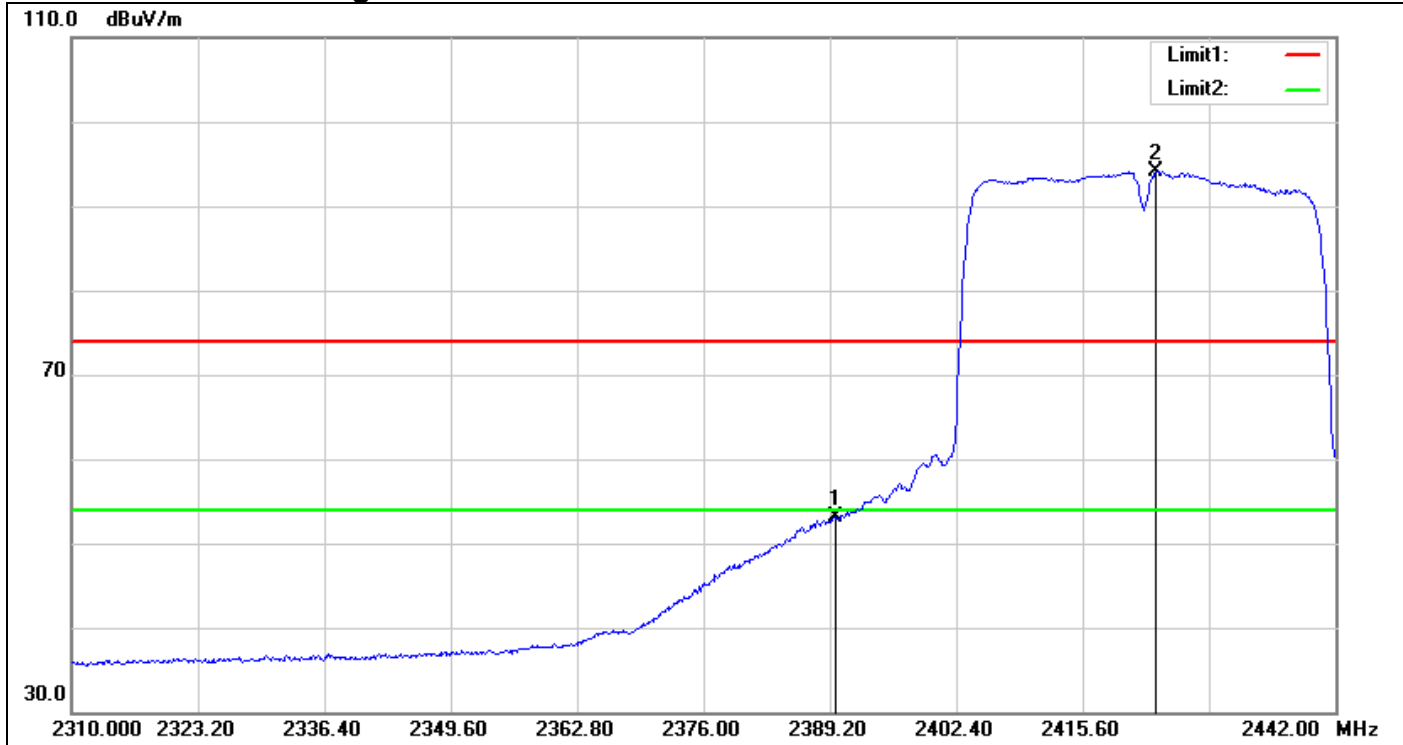

No.	Frequency (MHz)	Reading (dBuV)	Correct Factor(dB/m)	Result (dBuV/m)	Limit (dBuV/m)	Margin (dB)	Remark
1	2389.860	55.62	-2.49	53.13	54.00	-0.87	AVG
2	2423.256	96.37	-2.33	94.04	-	-	AVG

Band Edges

IEEE 802.11n HT 40 MHz Mode / CH Mid

Detector mode: Peak

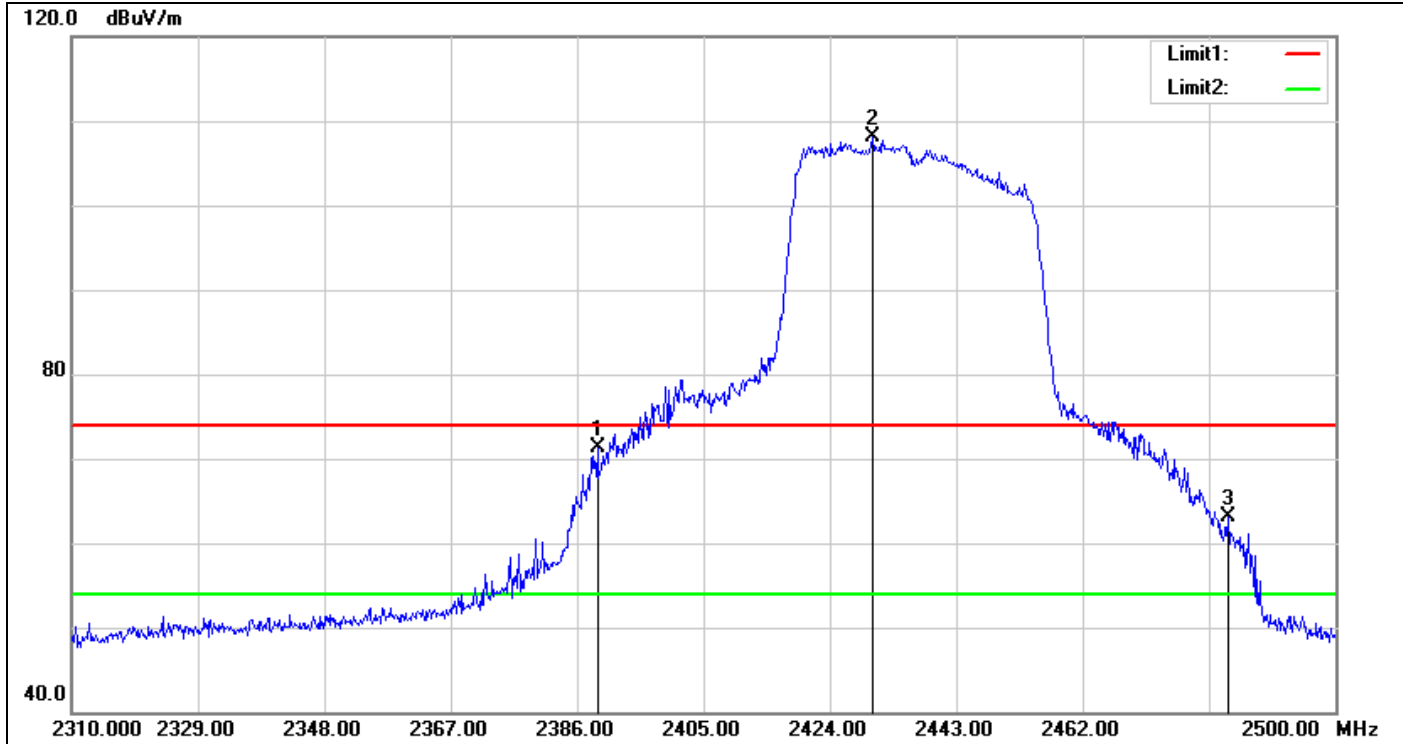

No.	Frequency (MHz)	Reading (dBuV)	Correct Factor(dB/m)	Result (dBuV/m)	Limit (dBuV/m)	Margin (dB)	Remark
1	2389.040	73.89	-2.50	71.39	74.00	-2.61	peak
2	2430.460	110.32	-2.28	108.04	-	-	peak
3	2483.850	65.00	-1.99	63.01	74.00	-10.99	peak

Detector mode: Average

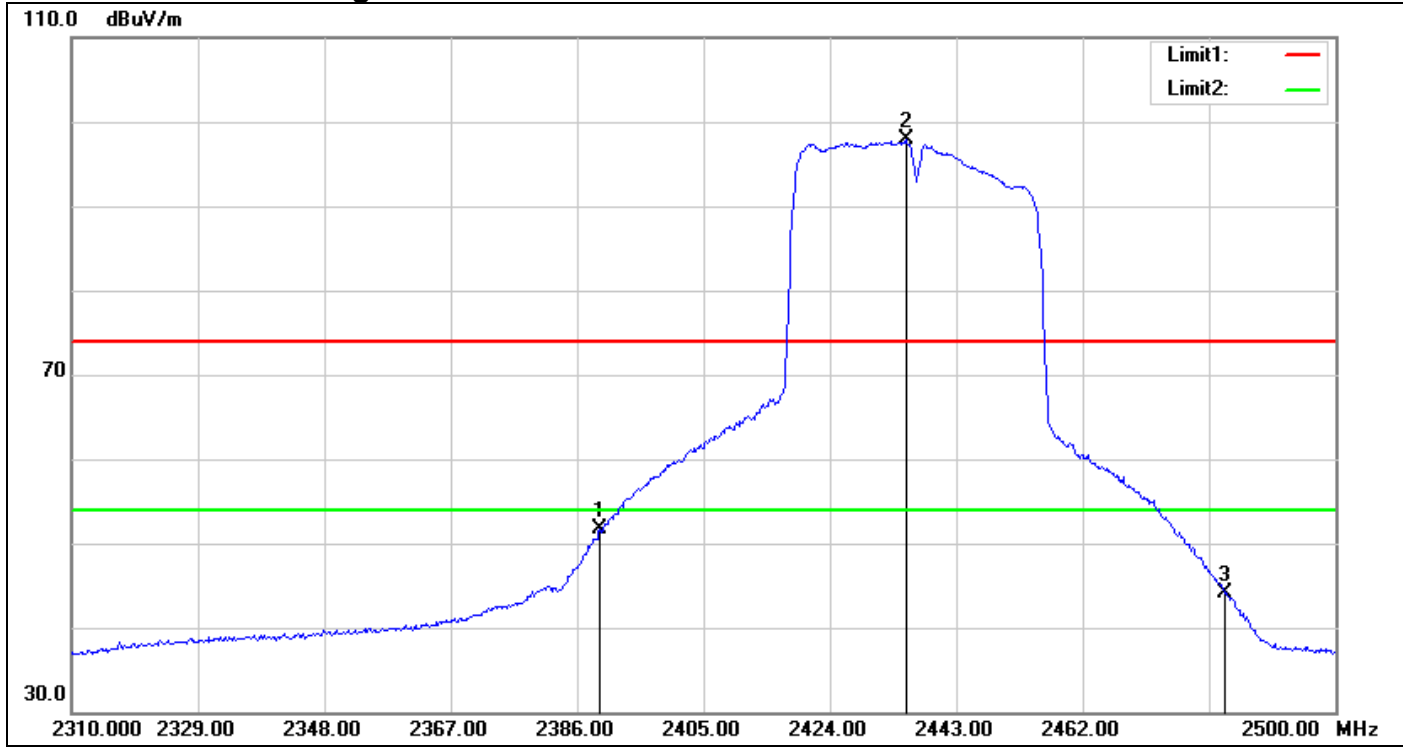

No.	Frequency (MHz)	Reading (dBuV)	Correct Factor(dB/m)	Result (dBuV/m)	Limit (dBuV/m)	Margin (dB)	Remark
1	2389.420	54.15	-2.50	51.65	54.00	-2.35	AVG
2	2435.400	100.06	-2.25	97.81	-	-	AVG
3	2483.470	46.11	-2.00	44.11	54.00	-9.89	AVG

Band Edges

IEEE 802.11n HT 40 MHz Mode / CH High

Detector mode: Peak

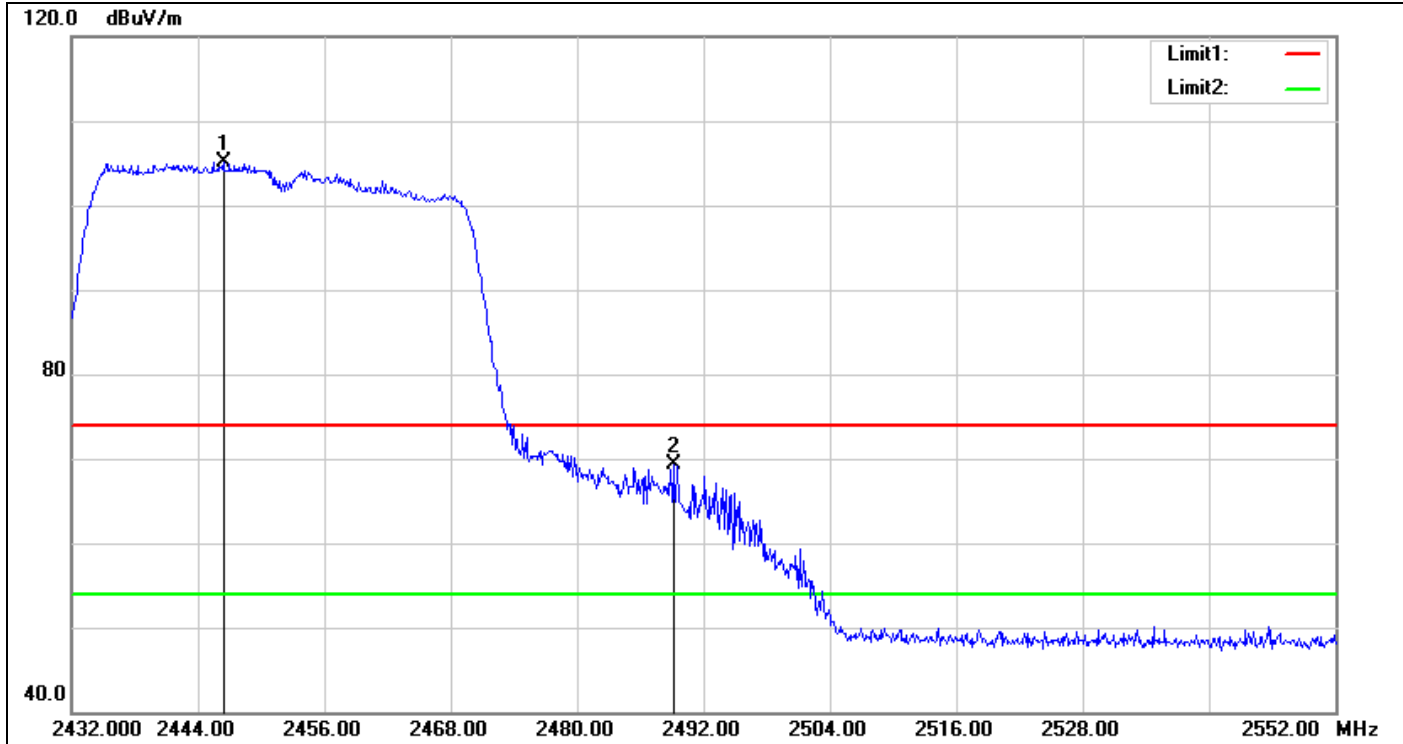

No.	Frequency (MHz)	Reading (dBuV)	Correct Factor(dB/m)	Result (dBuV/m)	Limit (dBuV/m)	Margin (dB)	Remark
1	2446.400	107.25	-2.17	105.08	-	-	peak
2	2489.120	71.23	-1.94	69.29	74.00	-4.71	peak

Detector mode: Average

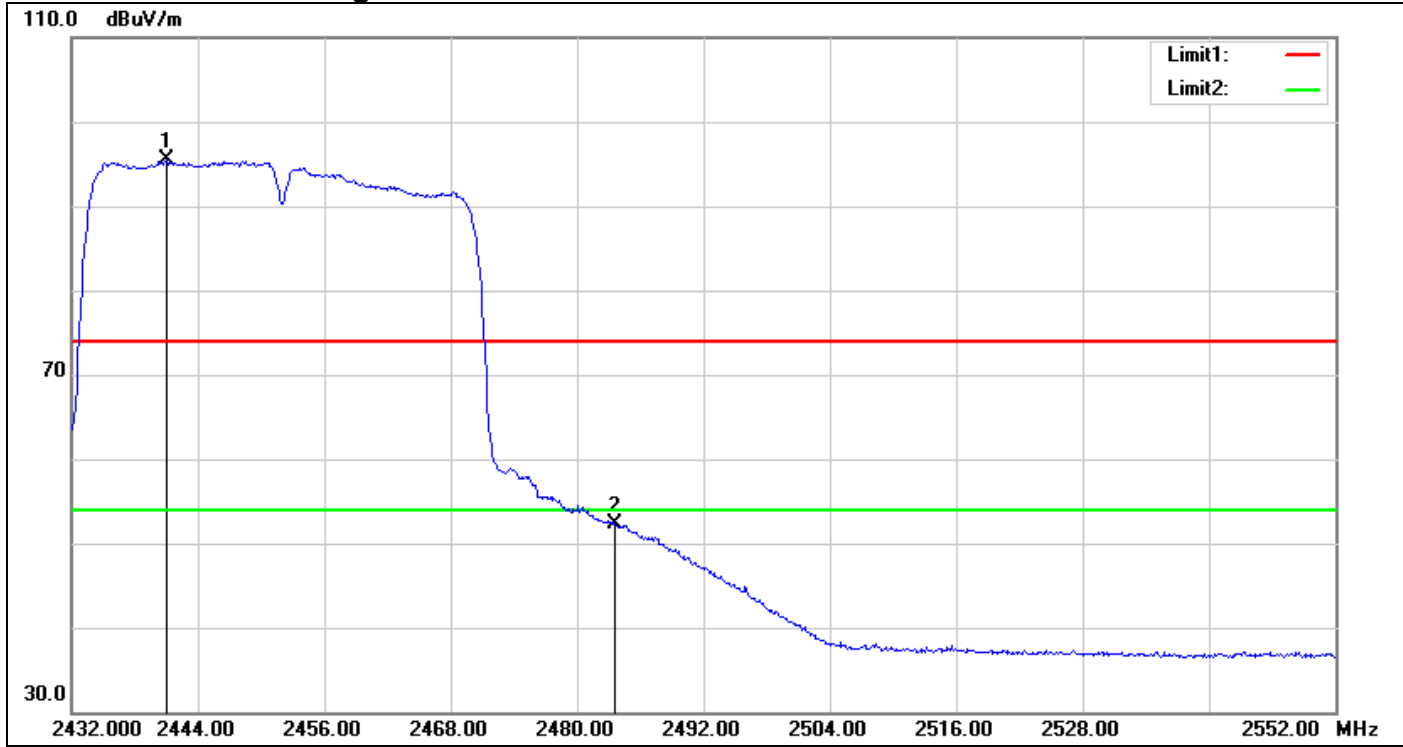

No.	Frequency (MHz)	Reading (dBuV)	Correct Factor(dB/m)	Result (dBuV/m)	Limit (dBuV/m)	Margin (dB)	Remark
1	2441.000	97.73	-2.21	95.52	-	-	AVG
2	2483.600	54.27	-1.99	52.28	54.00	-1.72	AVG

Test Plot

Un-restricted Band Emissions (IEEE 802.11b mode / CH Low)

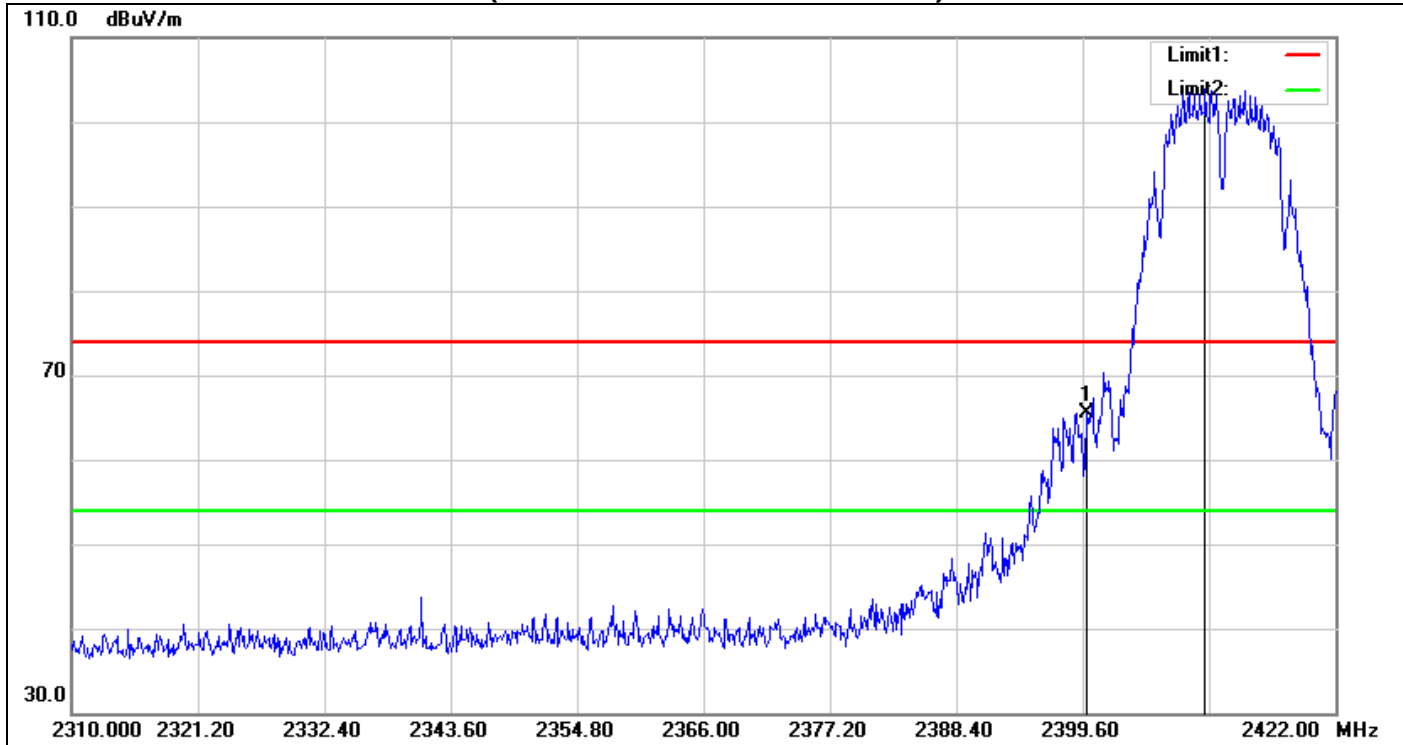

No.	Frequency (MHz)	Reading (dBuV)	Correct Factor(dB/m)	Result (dBuV/m)	Remark
1	2399.936	67.93	-2.41	65.52	peak
2	2410.464	106.41	-2.43	103.98	peak

Note: Spurious emission levels that exceed the level of 20 dB below the applicable limit.

Un-restricted Band Emissions (IEEE 802.11b mode / CH High)

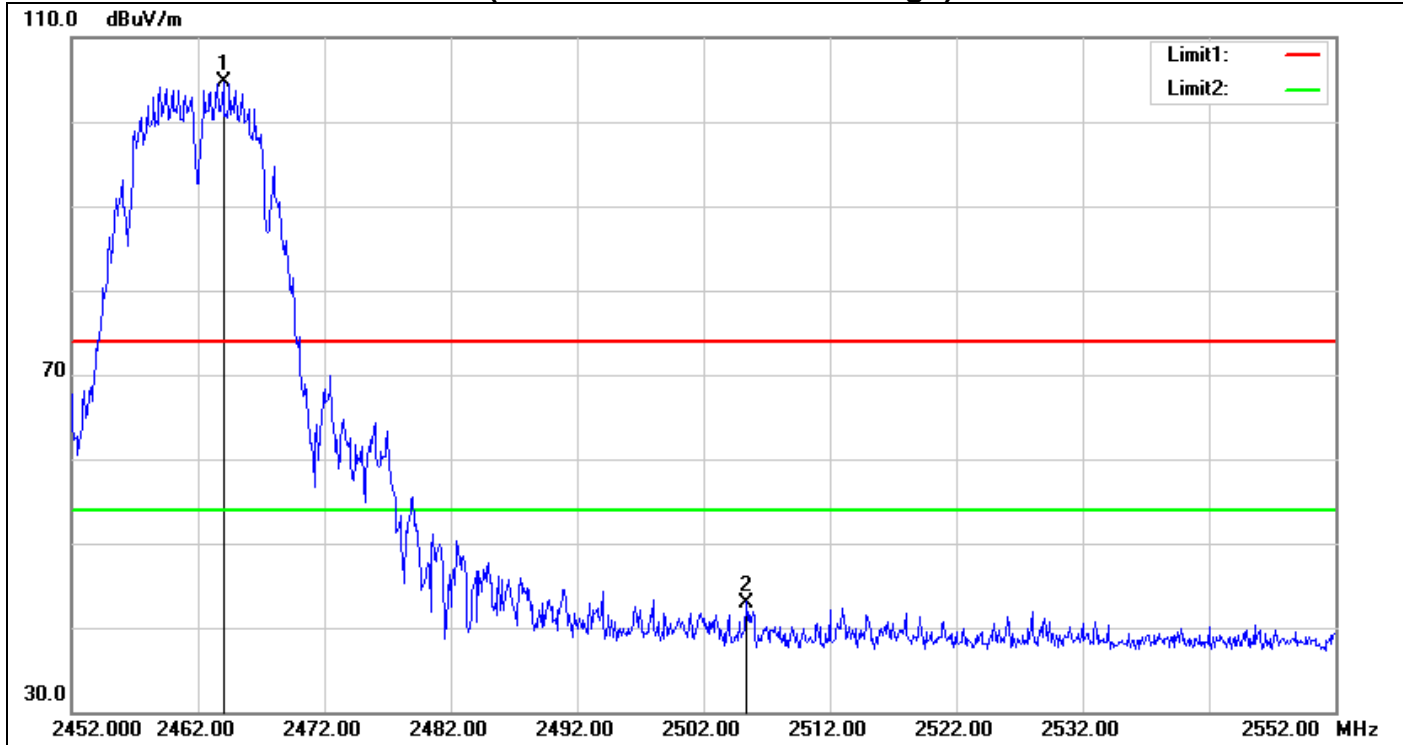

No.	Frequency (MHz)	Reading (dBuV)	Correct Factor(dB/m)	Result (dBuV/m)	Remark
1	2464.000	106.82	-2.09	104.73	peak
2	2505.400	44.85	-1.85	43.00	peak

Note: Spurious emission levels that exceed the level of 20 dB below the applicable limit.

Un-restricted Band Emissions (IEEE 802.11g mode / CH Low)

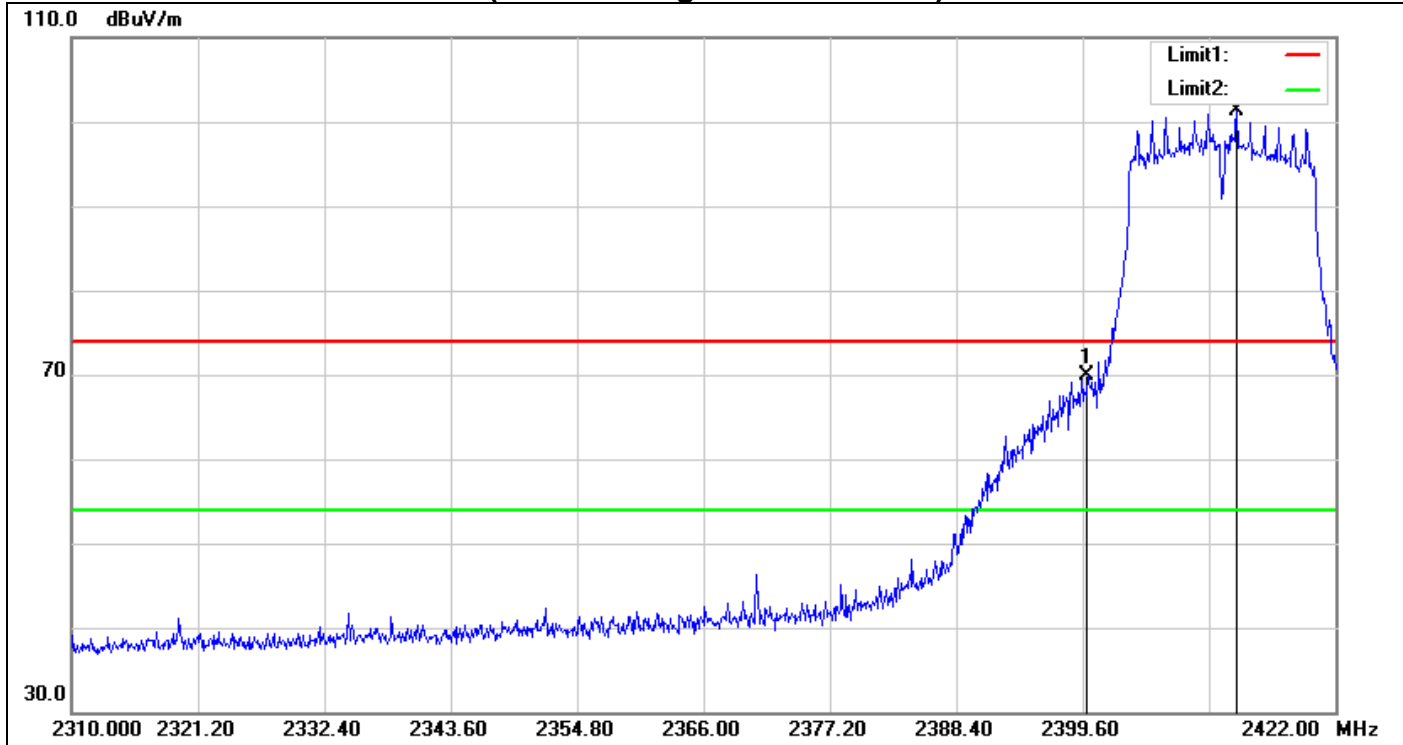

No.	Frequency (MHz)	Reading (dBuV)	Correct Factor(dB/m)	Result (dBuV/m)	Remark
1	2400.000	72.29	-2.41	69.88	peak
2	2413.264	103.73	-2.41	101.32	peak

Note: Spurious emission levels that exceed the level of 20 dB below the applicable limit.

Un-restricted Band Emissions (IEEE 802.11g mode / CH High)

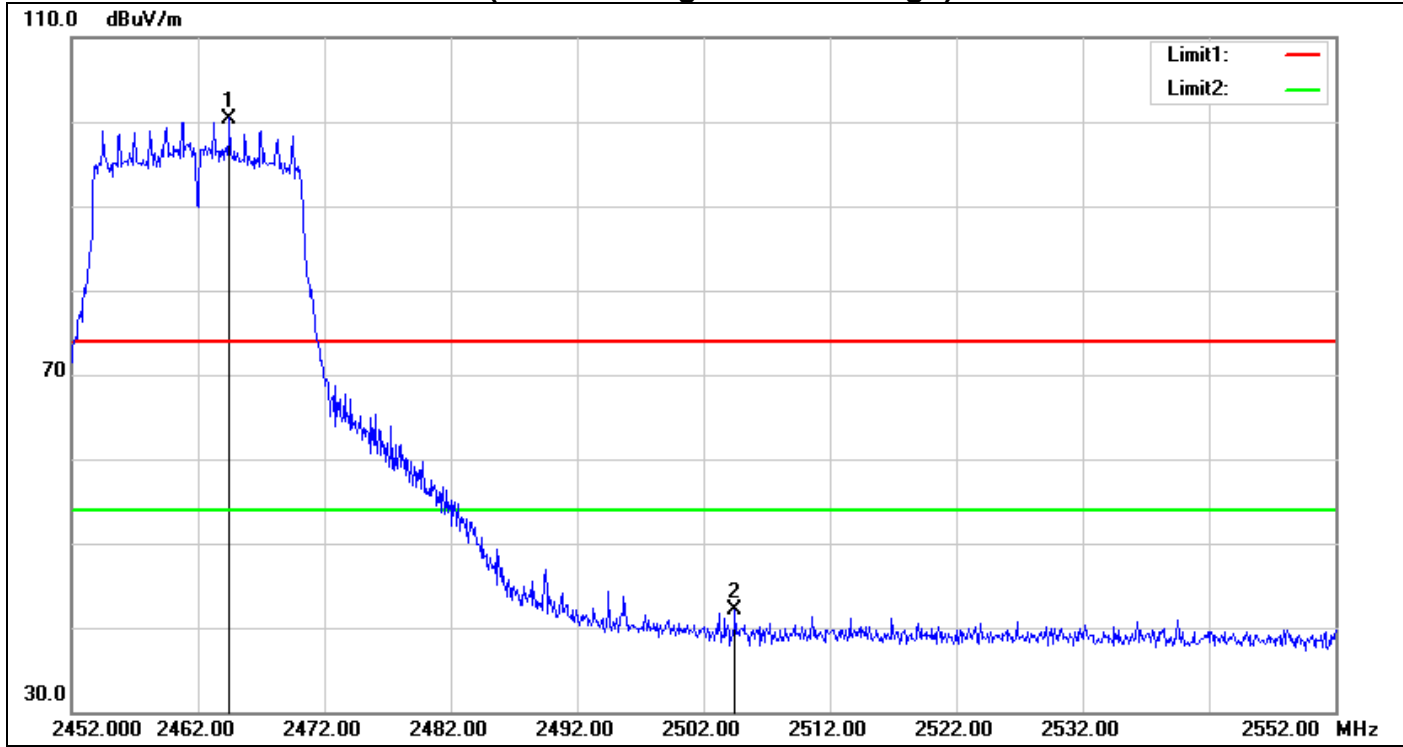

No.	Frequency (MHz)	Reading (dBuV)	Correct Factor(dB/m)	Result (dBuV/m)	Remark
1	2464.500	102.49	-2.09	100.40	peak
2	2504.500	43.88	-1.85	42.03	peak

Note: Spurious emission levels that exceed the level of 20 dB below the applicable limit.

Un-restricted Band Emissions (IEEE 802.11n HT 20 MHz mode / CH Low)

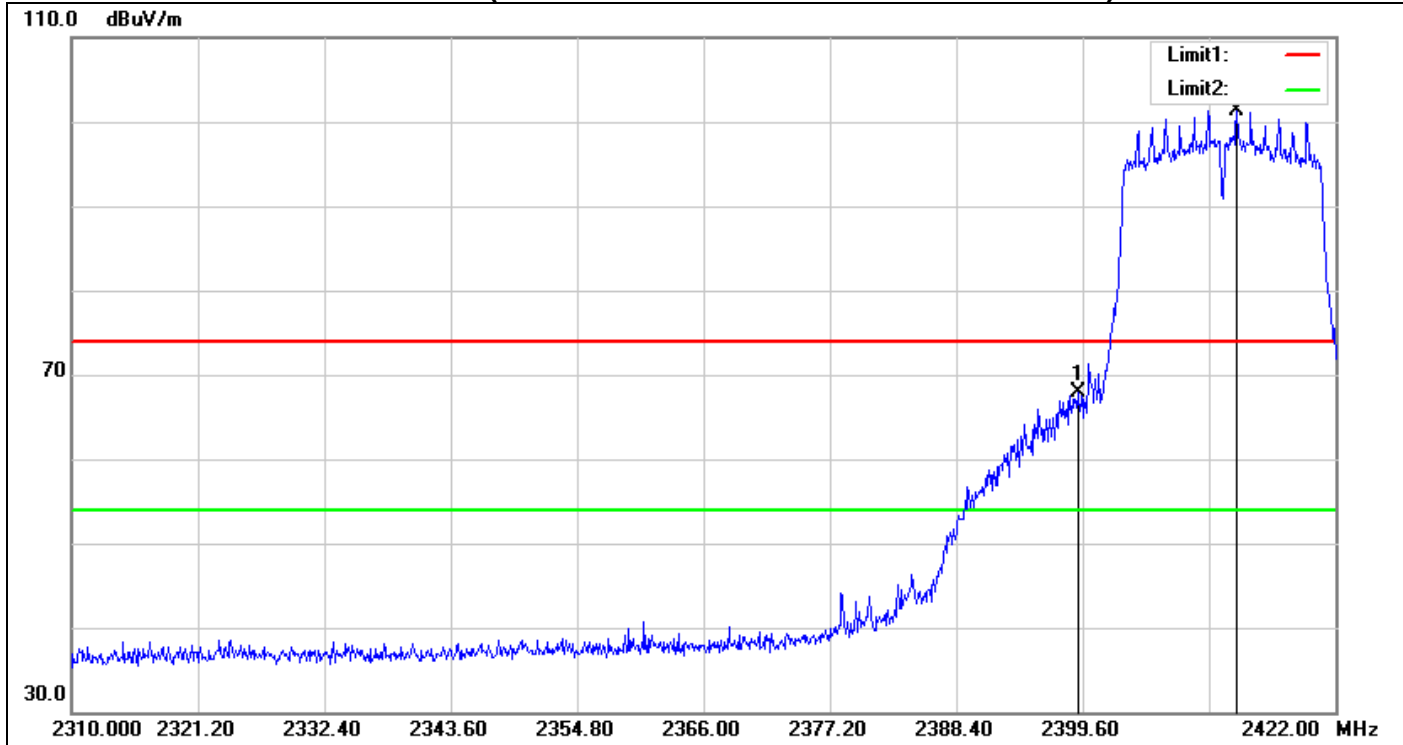

No.	Frequency (MHz)	Reading (dBuV)	Correct Factor(dB/m)	Result (dBuV/m)	Remark
1	2399.152	70.27	-2.42	67.85	peak
2	2413.264	103.78	-2.41	101.37	peak

Note: Spurious emission levels that exceed the level of 20 dB below the applicable limit.

Un-restricted Band Emissions (IEEE 802.11n HT 20 MHz mode / CH High)

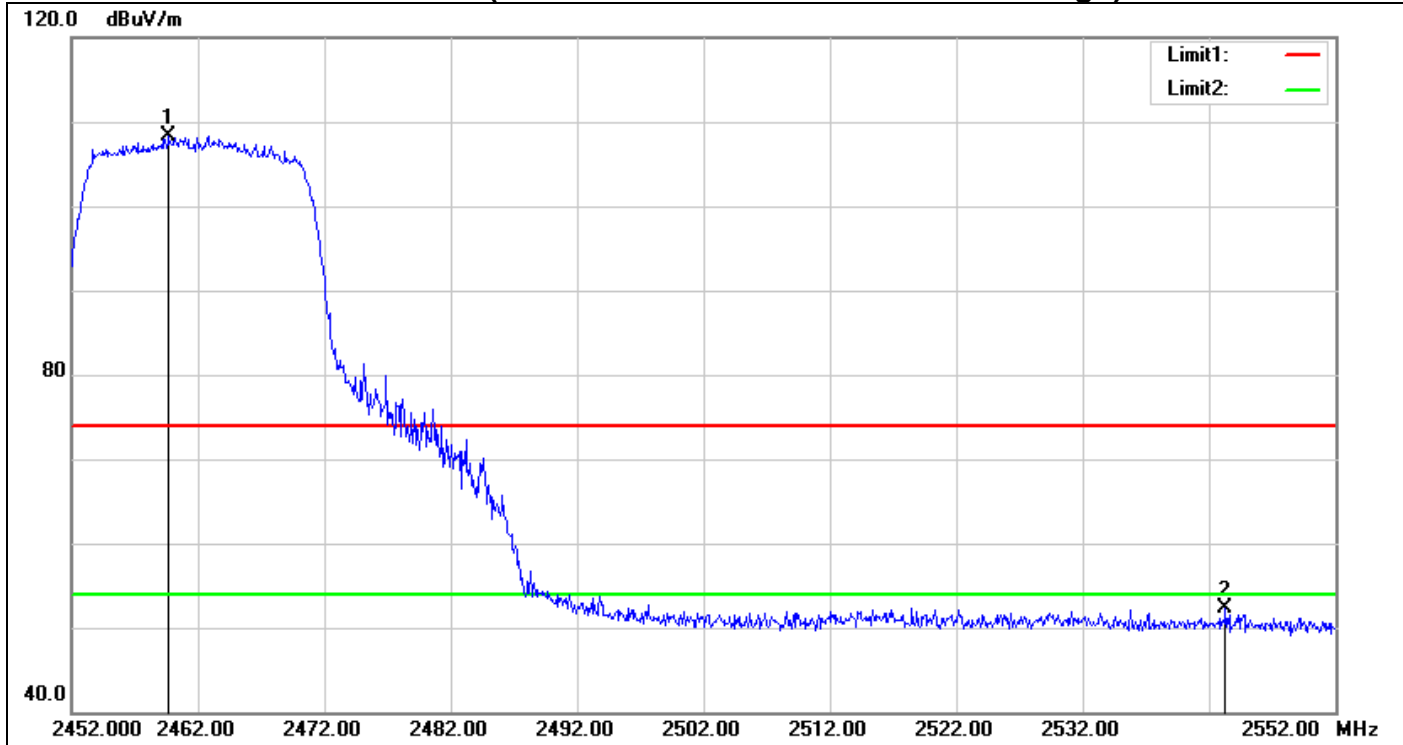

No.	Frequency (MHz)	Reading (dBuV)	Correct Factor(dB/m)	Result (dBuV/m)	Remark
1	2459.700	110.39	-2.10	108.29	peak
2	2543.300	54.08	-1.75	52.33	peak

Note: Spurious emission levels that exceed the level of 20 dB below the applicable limit.

Un-restricted Band Emissions (IEEE 802.11n HT 40 MHz mode / CH Low)

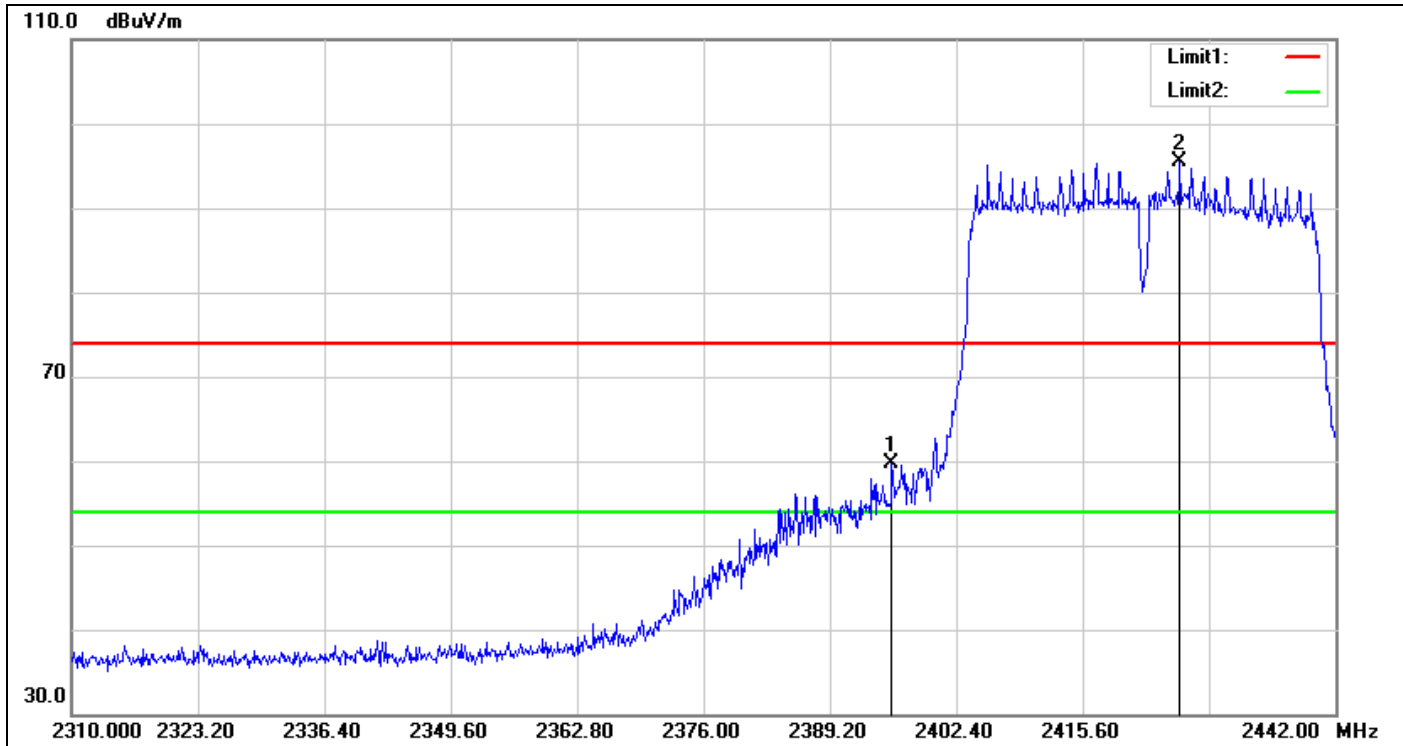

No.	Frequency (MHz)	Reading (dBuV)	Correct Factor(dB/m)	Result (dBuV/m)	Remark
1	2395.668	62.18	-2.44	59.74	peak
2	2425.764	97.73	-2.32	95.41	peak

Note: Spurious emission levels that exceed the level of 20 dB below the applicable limit.

Un-restricted Band Emissions (IEEE 802.11n HT 40 MHz mode / CH High)

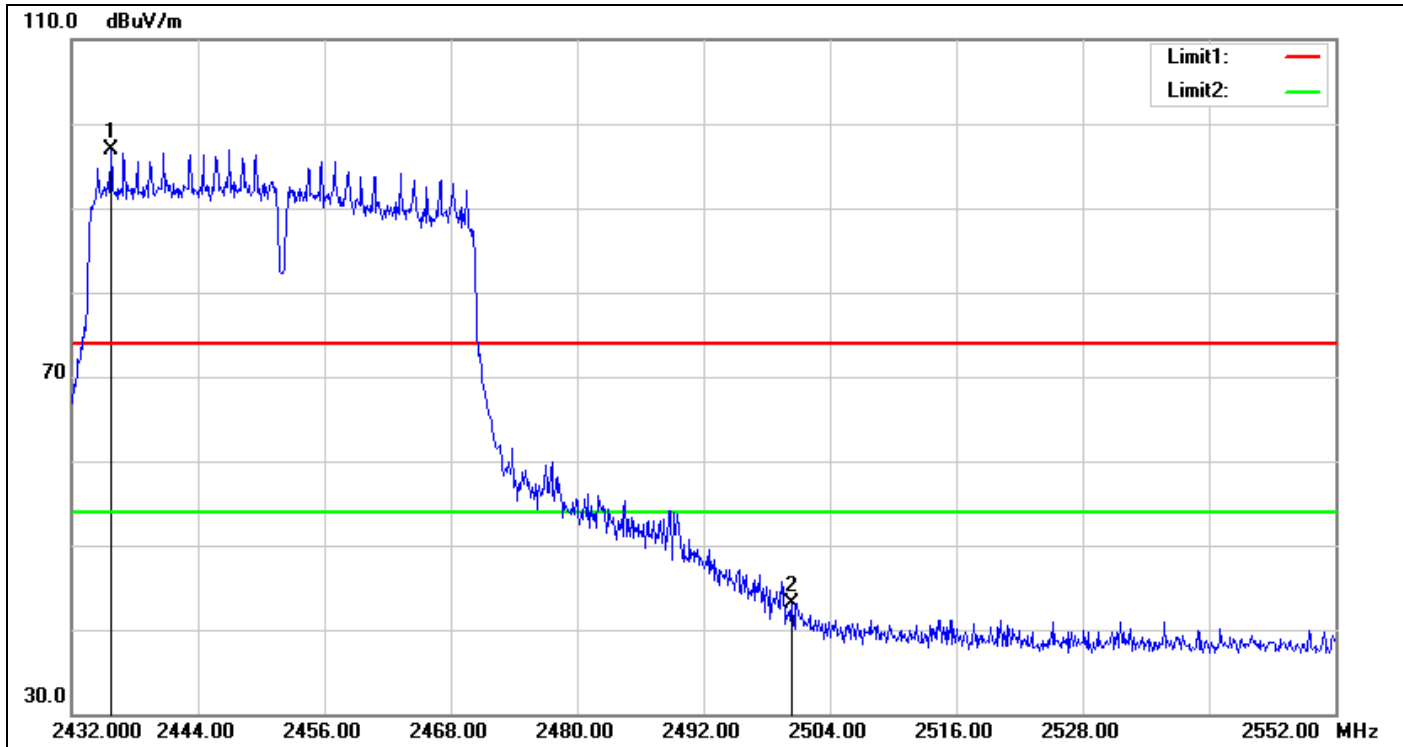

No.	Frequency (MHz)	Reading (dBuV)	Correct Factor(dB/m)	Result (dBuV/m)	Remark
1	2435.720	99.19	-2.24	96.95	peak
2	2500.400	44.99	-1.86	43.13	peak

Note: Spurious emission levels that exceed the level of 20 dB below the applicable limit.

7.6 PEAK POWER SPECTRAL DENSITY

LIMIT

1. According to §15.247(e) & RSS-247, for digitally modulated systems, the power spectral density conducted from the intentional radiator to the antenna shall not be greater than 8 dBm in any 3 kHz band during any time interval of continuous transmission.
2. According to §15.247(f) & RSS-247, the digital modulation operation of the hybrid system, with the frequency hopping turned off, shall comply with the power density requirements of paragraph (d) of this section.

Test Configuration

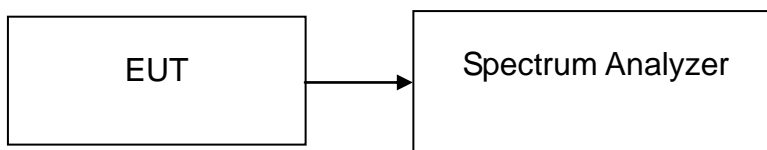

TEST PROCEDURE

1. Place the EUT on the table and set it in transmitting mode. Remove the antenna from the EUT and then connect a low loss RF cable from the antenna port to the spectrum analyzer.
2. Set the spectrum analyzer as RBW = 3 kHz, VBW = 30 kHz, Span = 1.5MHz, Sweep time = 100 s
3. Record the max reading.
4. Repeat the above procedure until the measurements for all frequencies are completed.

TEST RESULTS

No non-compliance noted

Test Data

IEEE 802.11b mode

Duty Cycle: 98.56% Duty Fac:0.06

Channel	Frequency (MHz)	PPSD (dBm)	Limit (dBm)	Result
Low	2412	-7.56	8.00	PASS
Mid	2437	-7.75		PASS
High	2462	-6.95		PASS

IEEE 802.11g mode

Duty Cycle: 92.16% Duty Fac:0.35

Channel	Frequency (MHz)	PPSD (dBm)	Limit (dBm)	Result
Low	2412	-7.48	8.00	PASS
Mid	2437	-9.40		PASS
High	2462	-7.89		PASS

IEEE 802.11n HT 20 MHz mode

Duty Cycle: 89.79% Duty Fac:0.47

Channel	Frequency (MHz)	Chain 0 PPSD (dBm)	Chain 1 PPSD (dBm)	PPSD (dBm)	Limit (dBm)	Result
Low	2412	-6.44	-8.49	-4.33	8.00	PASS
Mid	2437	-10.18	-8.29	-6.12		PASS
High	2462	-9.08	-8.23	-5.62		PASS

IEEE 802.11n HT 40 MHz mode

Duty Cycle: 85.18% Duty Fac:0.70

Channel	Frequency (MHz)	Chain 0 PPSD (dBm)	Chain 1 PPSD (dBm)	PPSD (dBm)	Limit (dBm)	Result
Low	2422	-14.90	-13.26	-10.99	8.00	PASS
Mid	2437	-15.17	-14.73	-11.93		PASS
High	2452	-13.86	-13.30	-10.56		PASS

Remark:

1. Total PPSD (dBm) = 10*LOG(10^(Chain 0 PPSD / 10)+10^(Chain 1 PPSD / 10))

Test Plot

IEEE 802.11b mode

PPSD (CH Low)

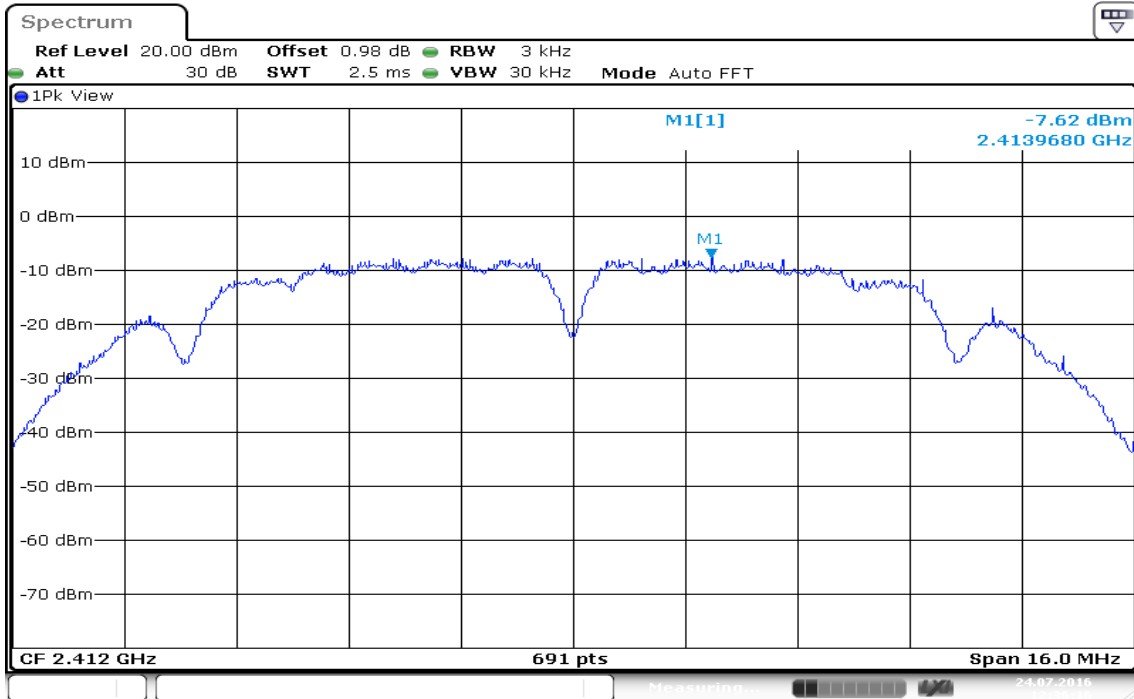

Date: 24 JUL 2016 12:36:16

PPSD (CH Mid)

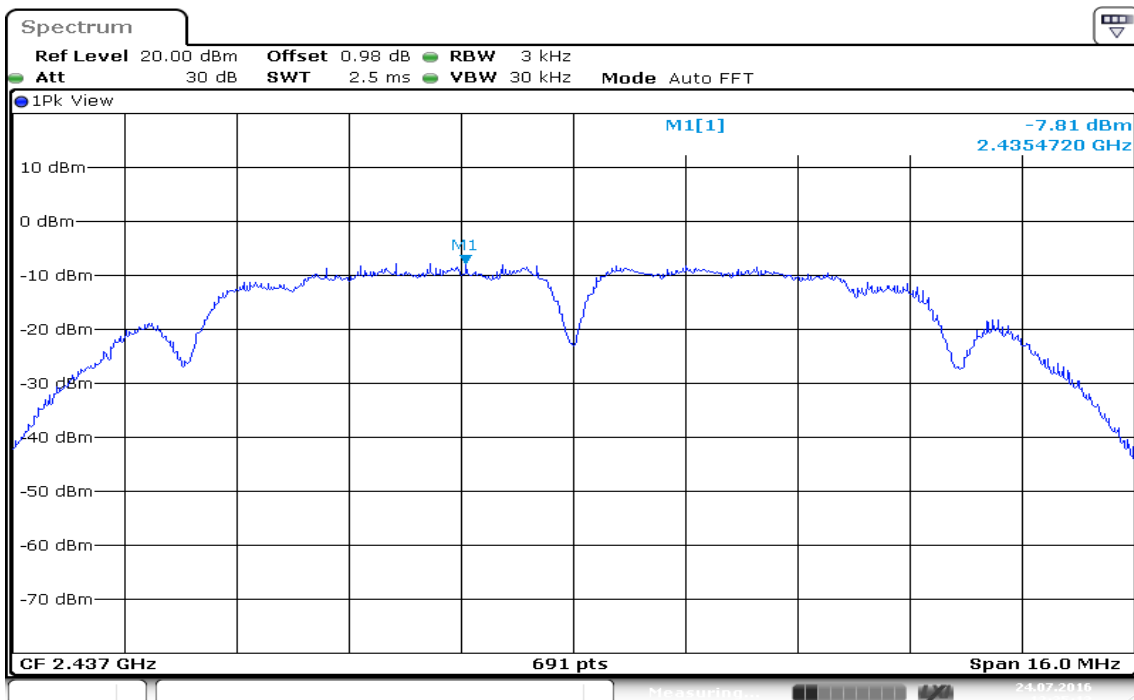

Date: 24 JUL 2016 12:35:13

PPSD (CH High)

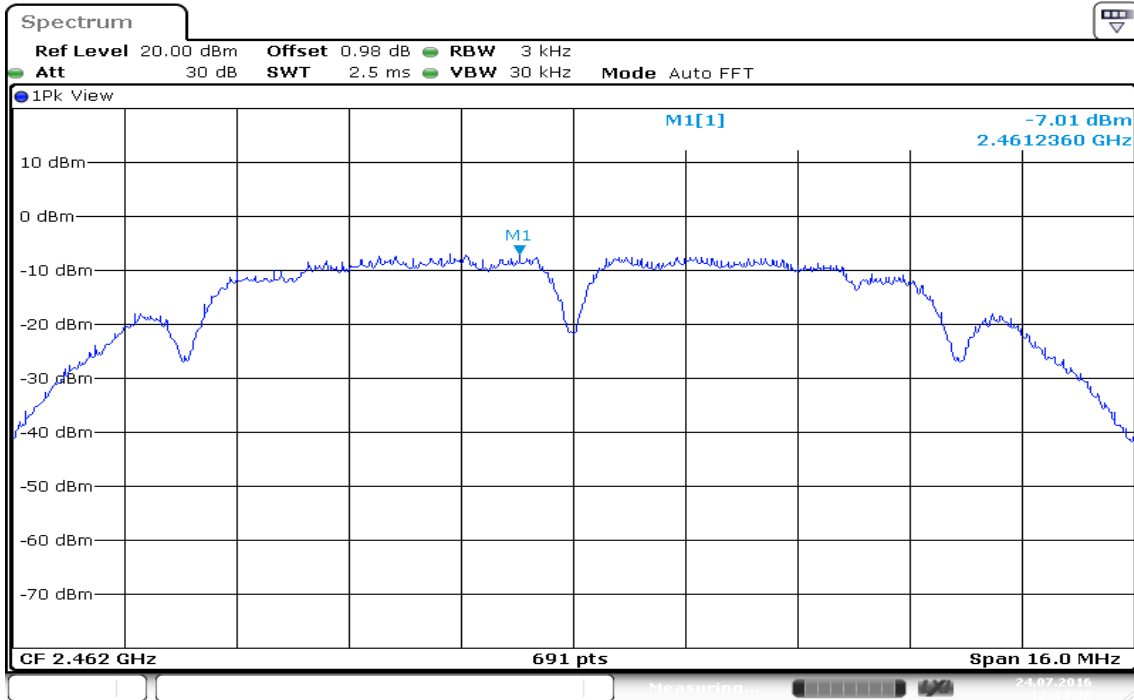

Date: 24 JUL 2016 12:34:28

IEEE 802.11g mode

PPSD (CH Low)

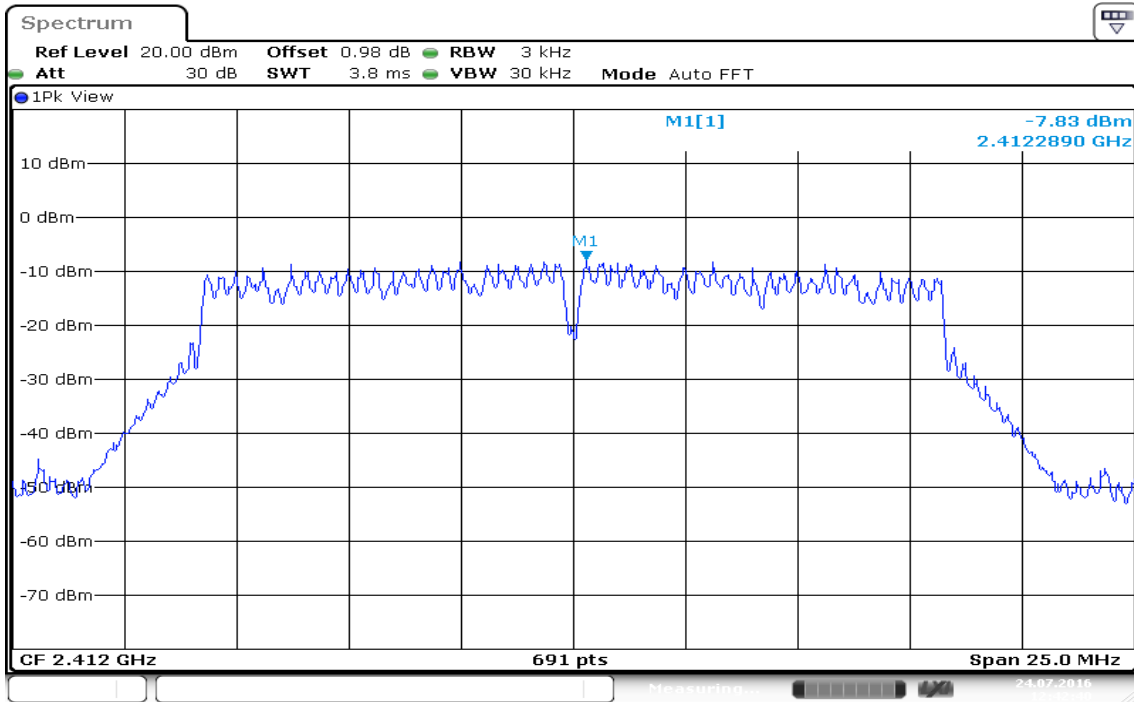

PPSD (CH Mid)

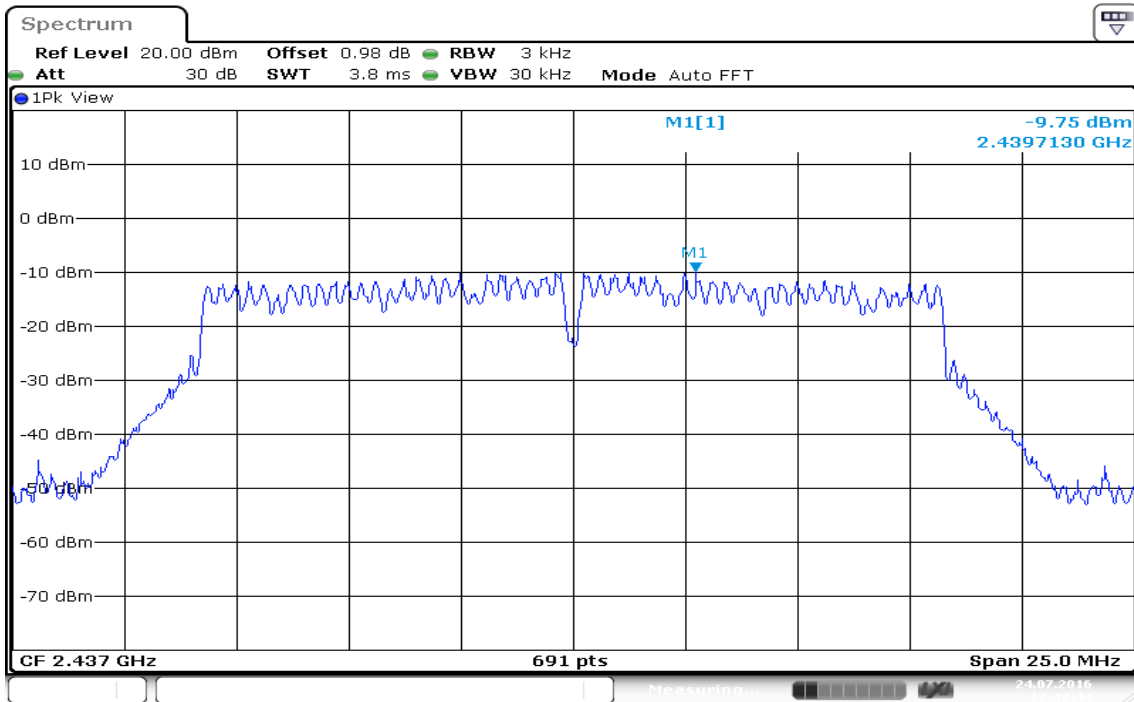

PPSD (CH High)

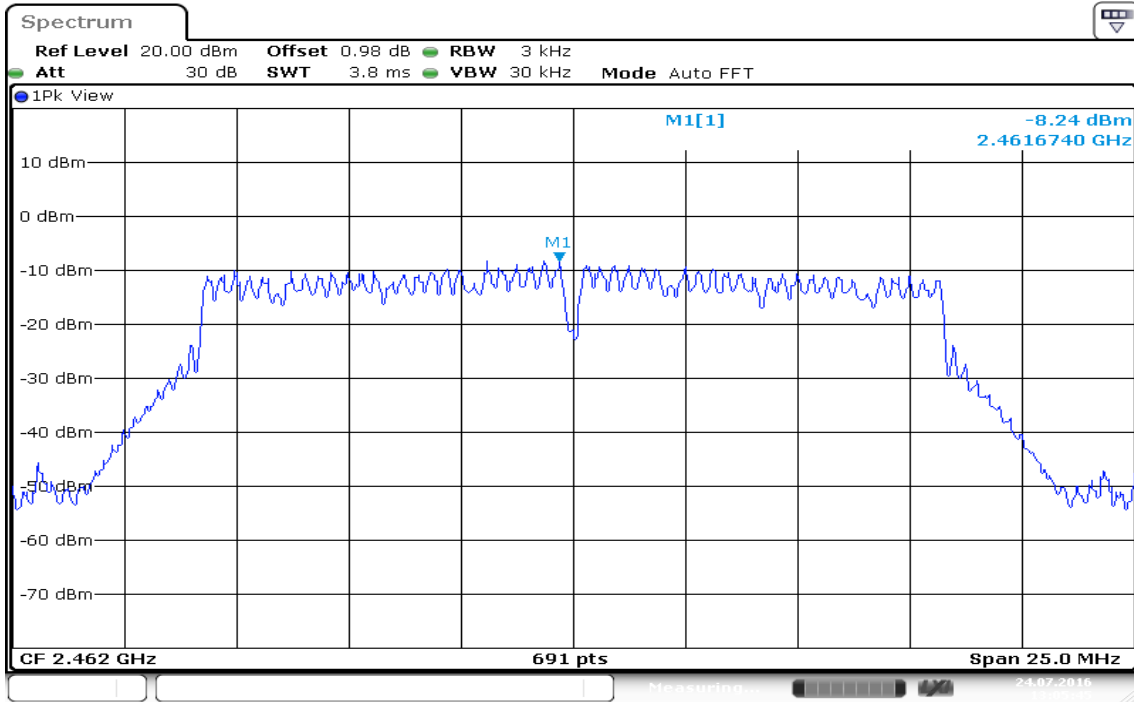

Date: 24 JUL 2016 13:05:45

IEEE 802.11n HT 20 MHz mode / Chain 0

PPSD (CH Low)

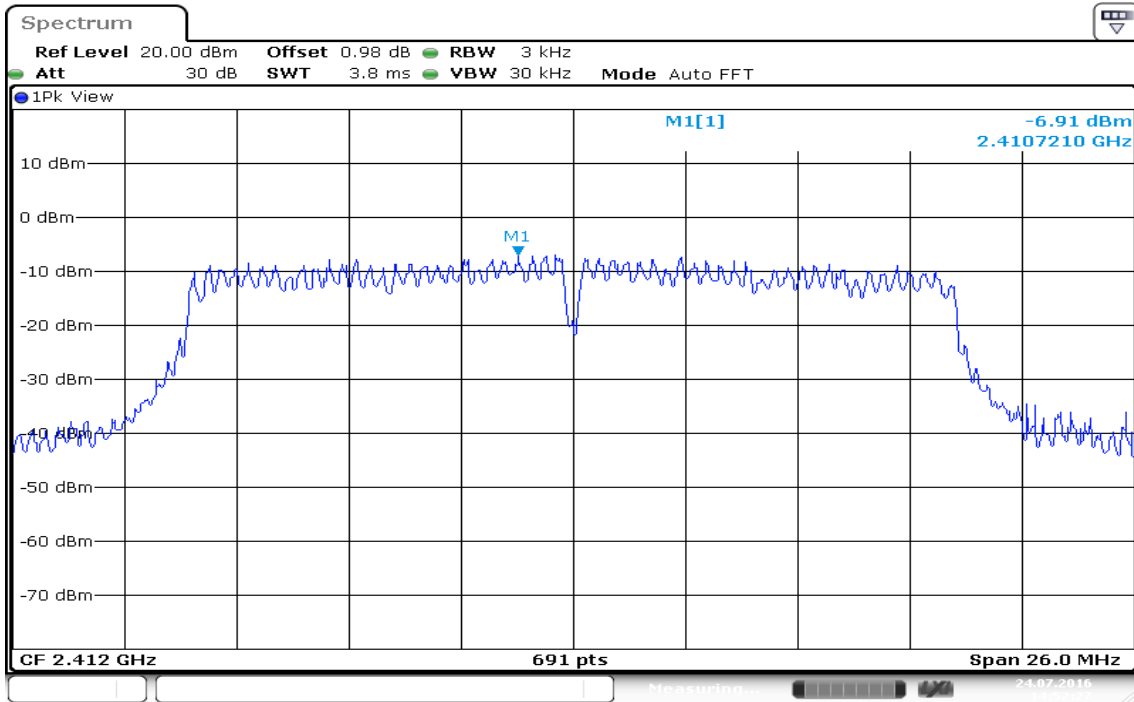

Date: 24 JUL 2016 14:52:27

PPSD (CH Mid)

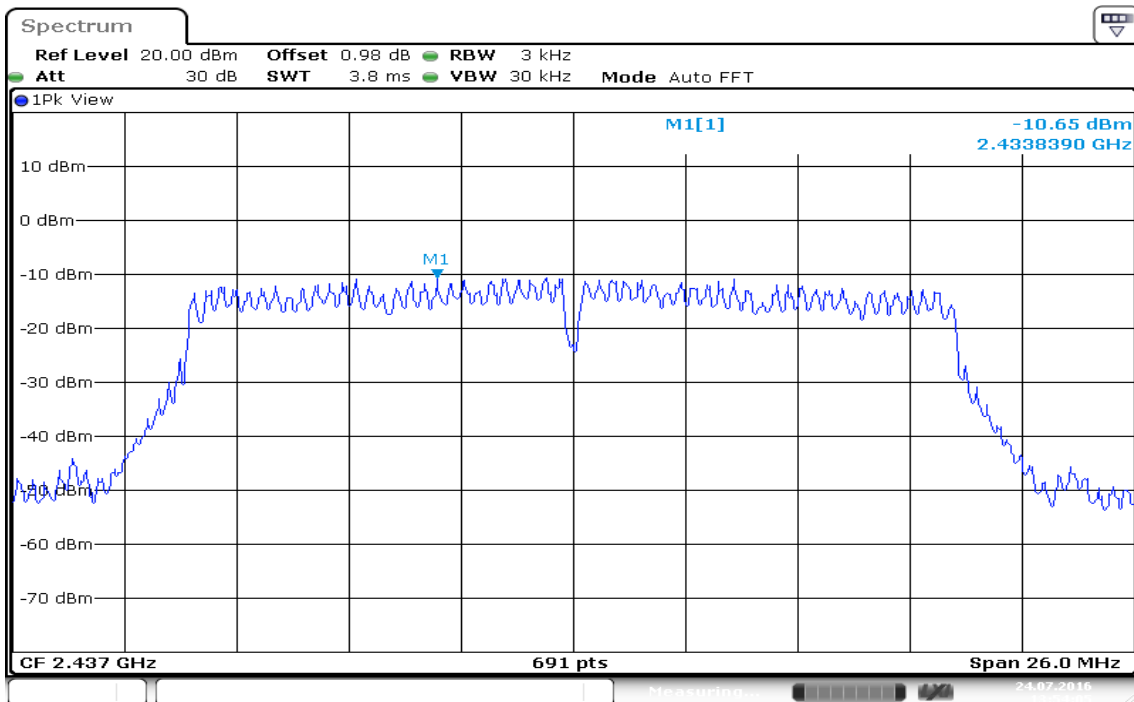

Date: 24 JUL 2016 13:54:04

PPSD (CH High)

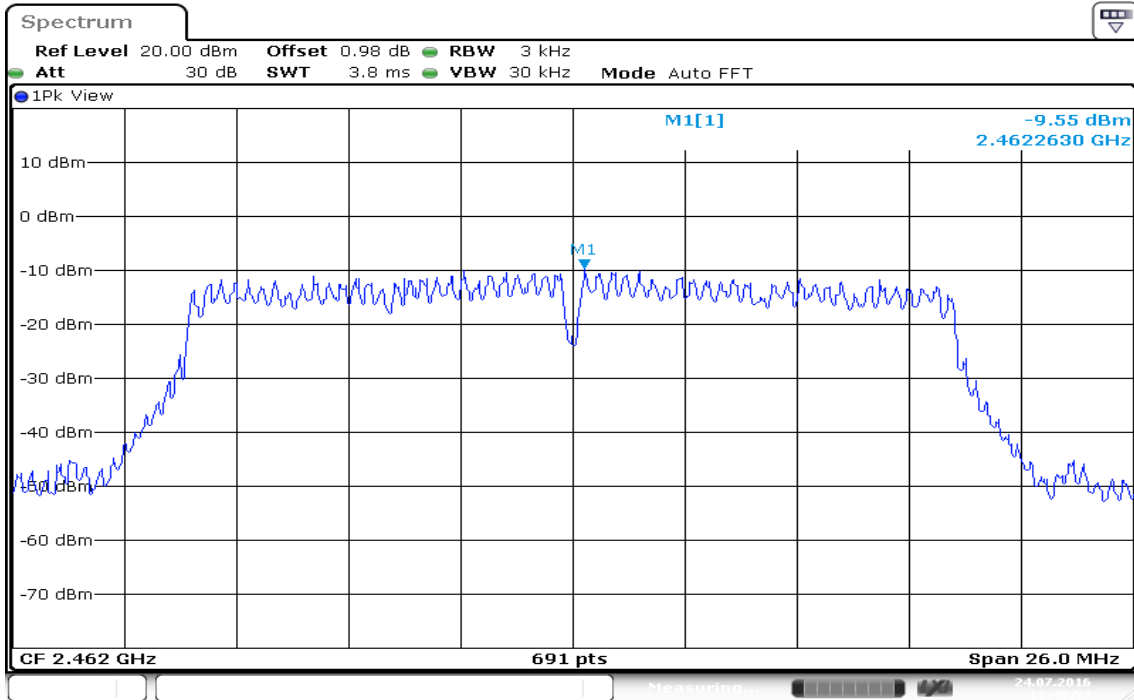

Date: 24 JUL 2016 13:45:53

IEEE 802.11n HT 20 MHz mode / Chain 1

PPSD (CH Low)

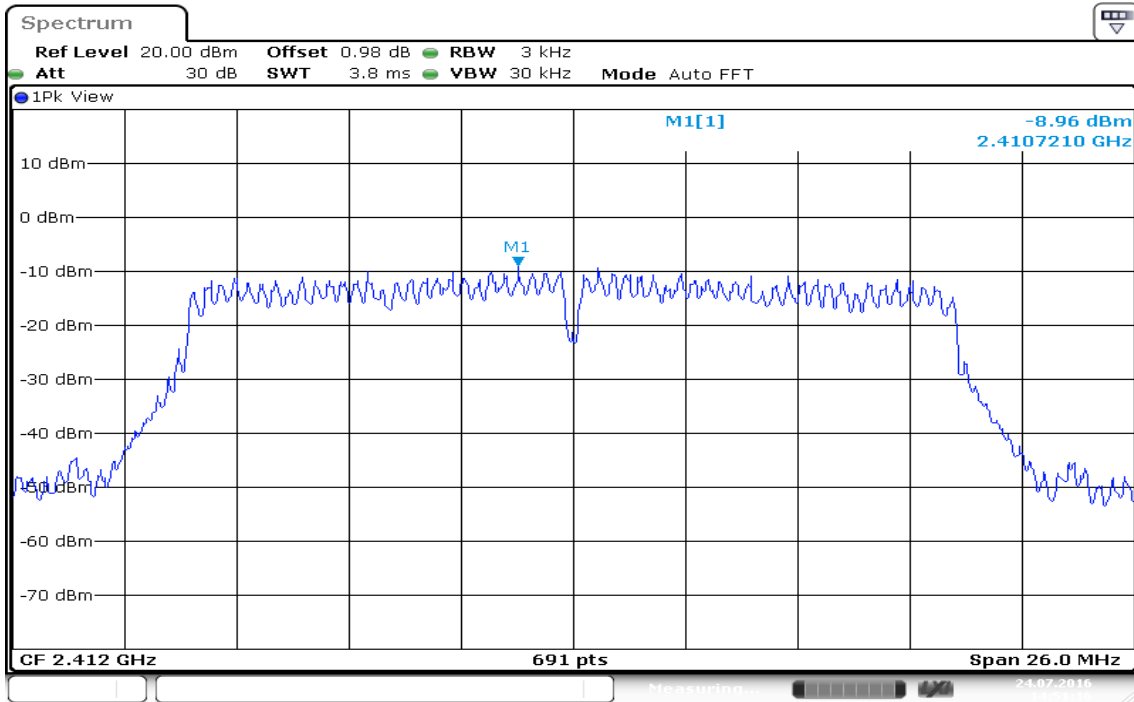

PPSD (CH Mid)

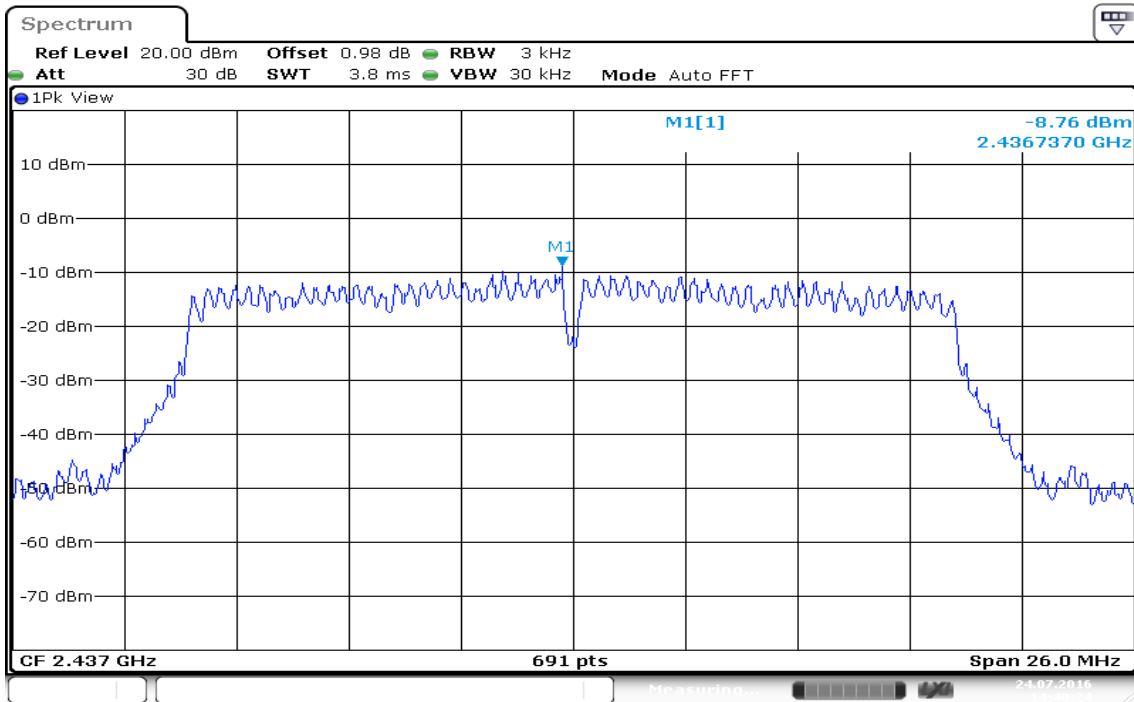

PPSD (CH High)

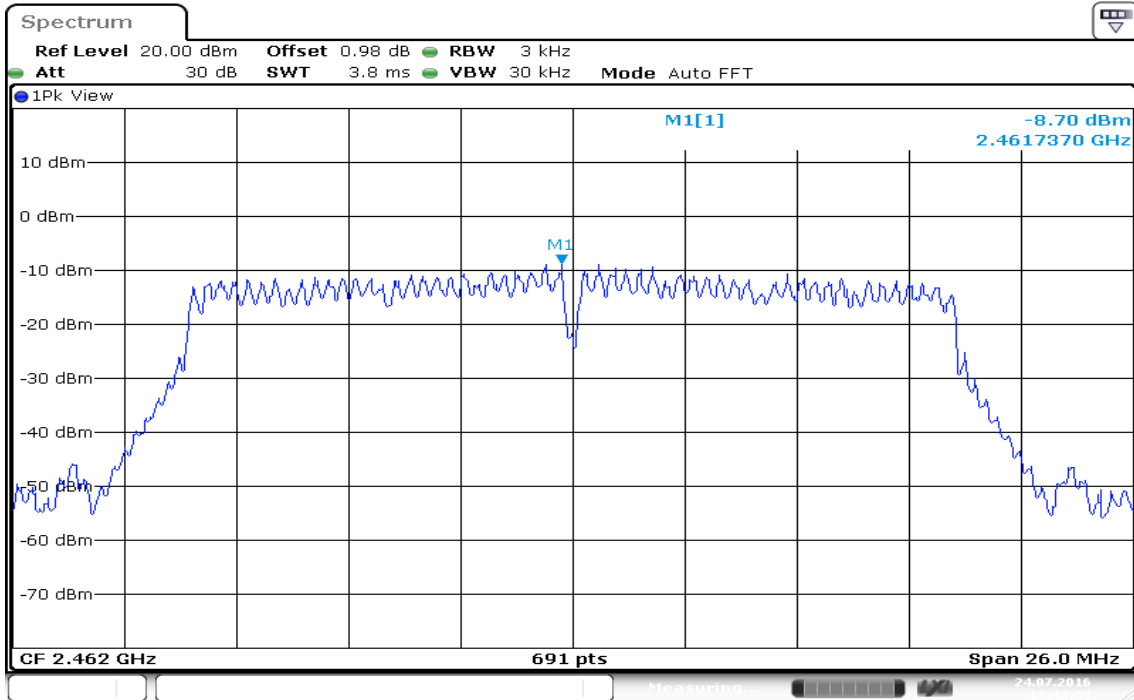

Date: 24 JUL 2016 13:43:04

IEEE 802.11n HT 40 MHz mode / Chain 0

PPSD (CH Low)

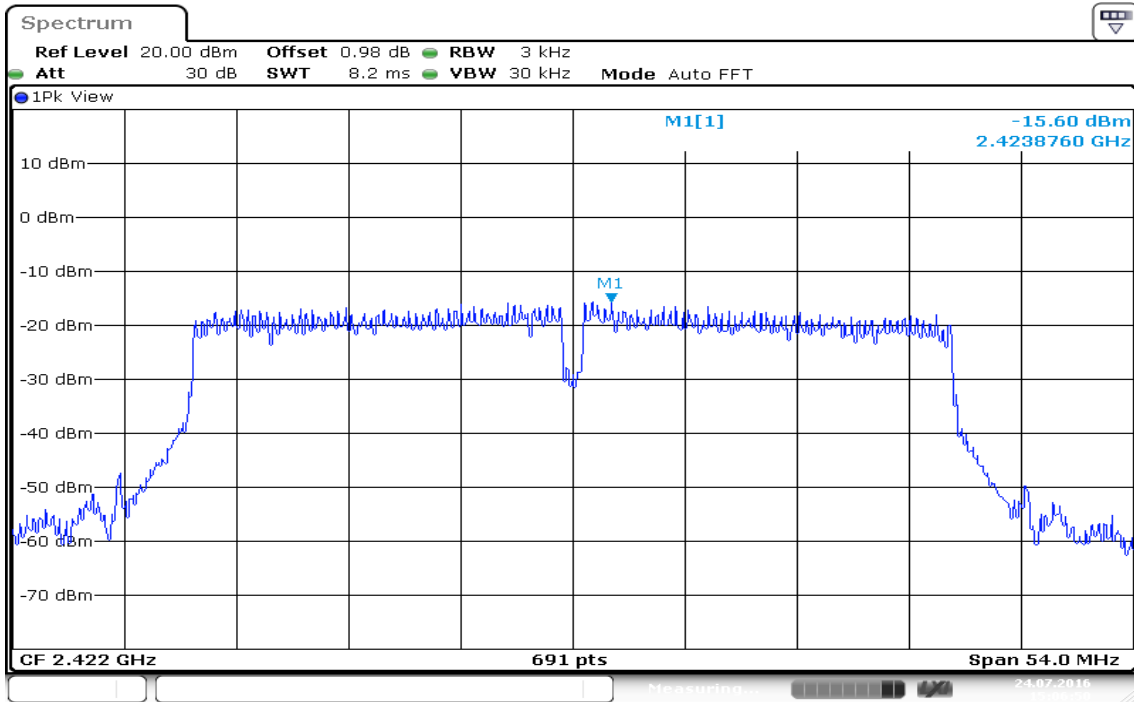

PPSD (CH Mid)

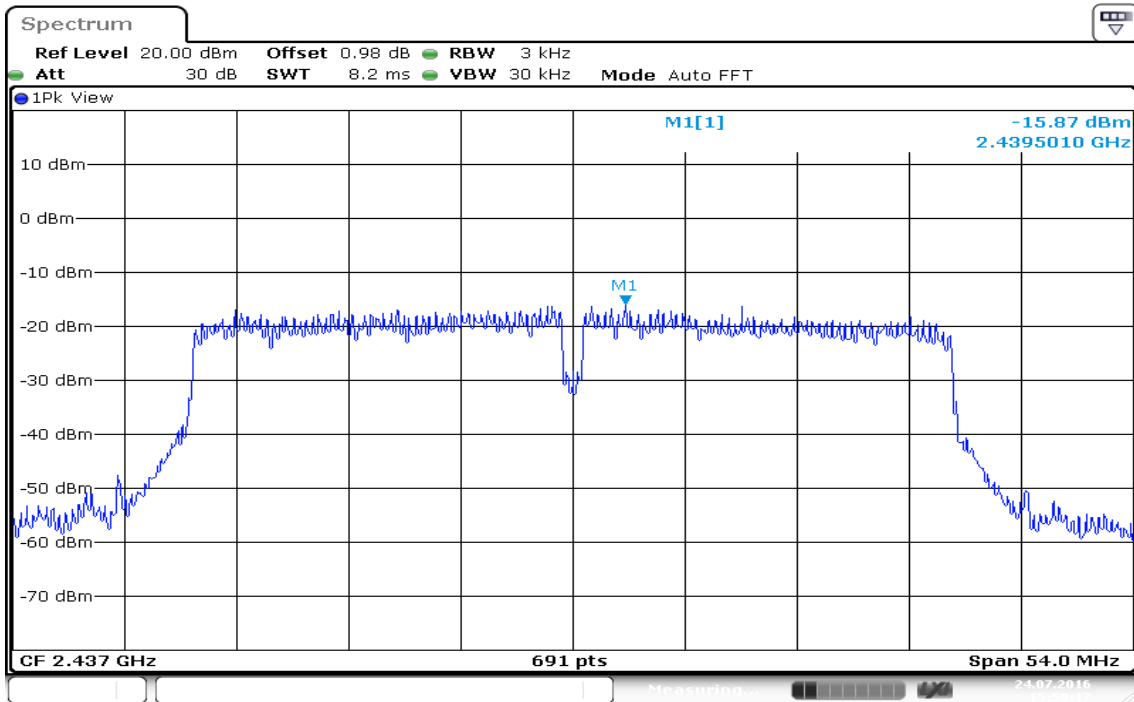

PPSD (CH High)

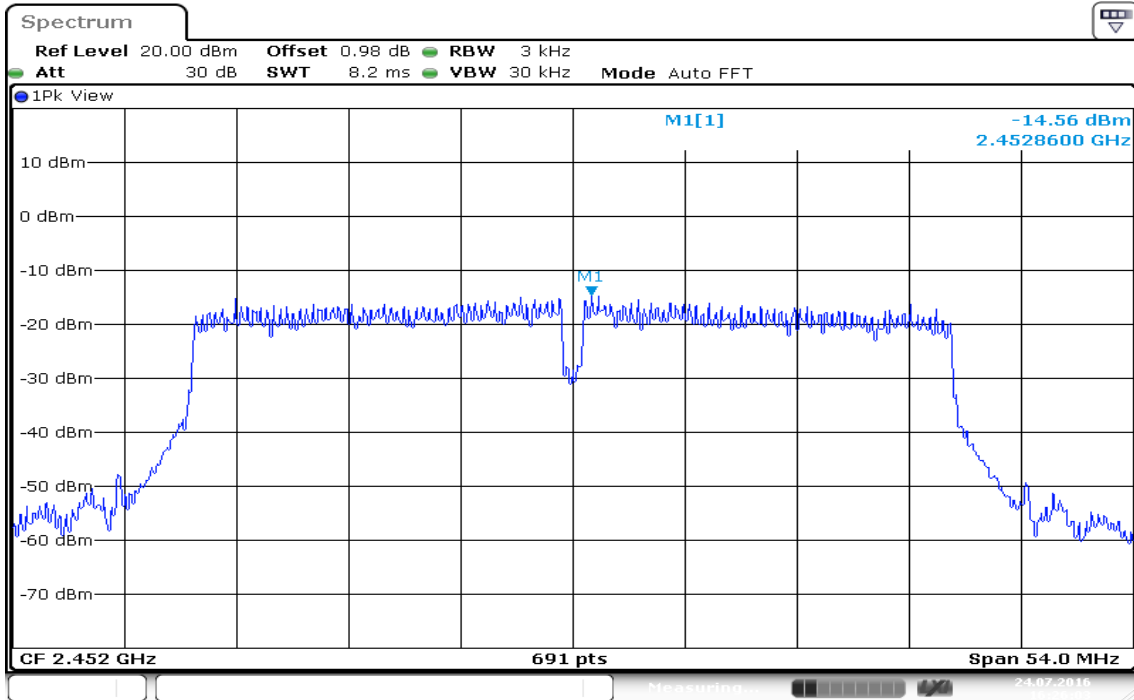

Date: 24 JUL 2016 16:26:03

IEEE 802.11n HT 40 MHz mode / Chain 1

PPSD (CH Low)

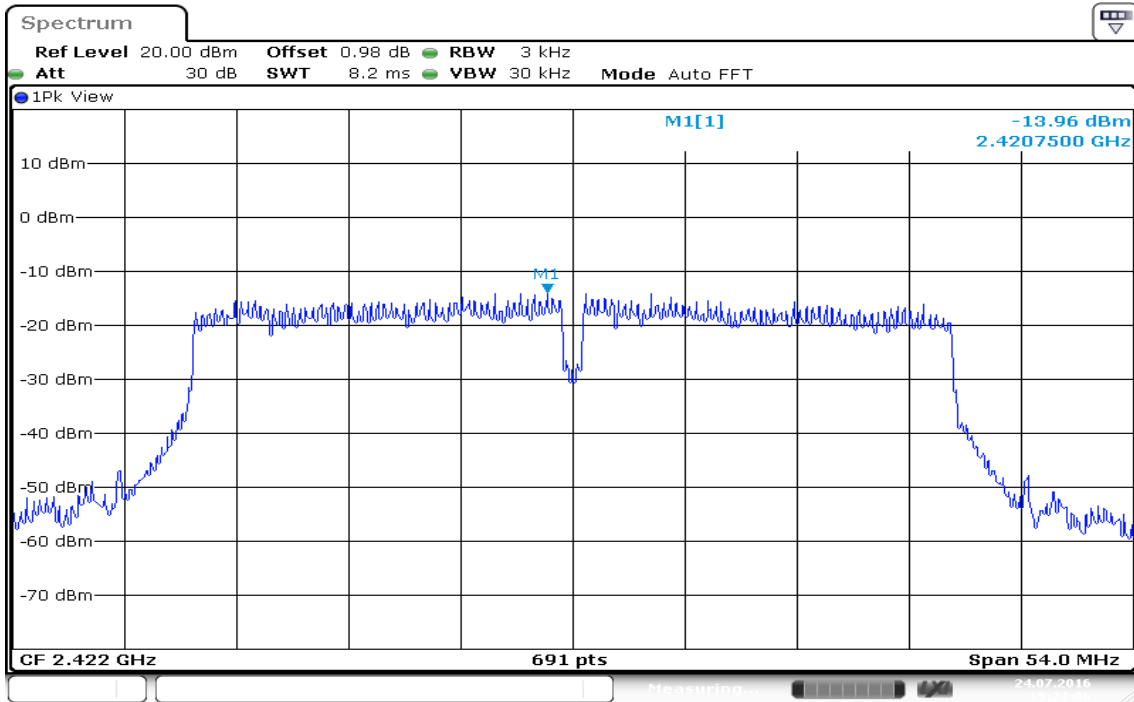

Date: 24 JUL 2016 15:23:07

PPSD (CH Mid)

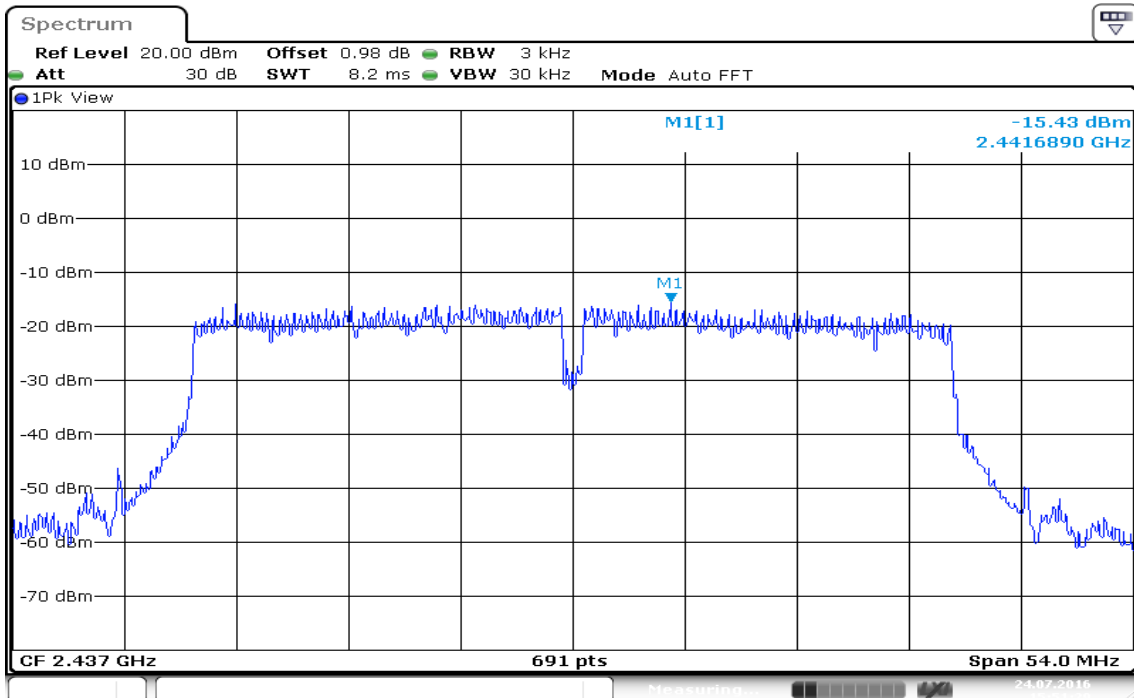

Date: 24 JUL 2016 15:51:29

PPSD (CH High)

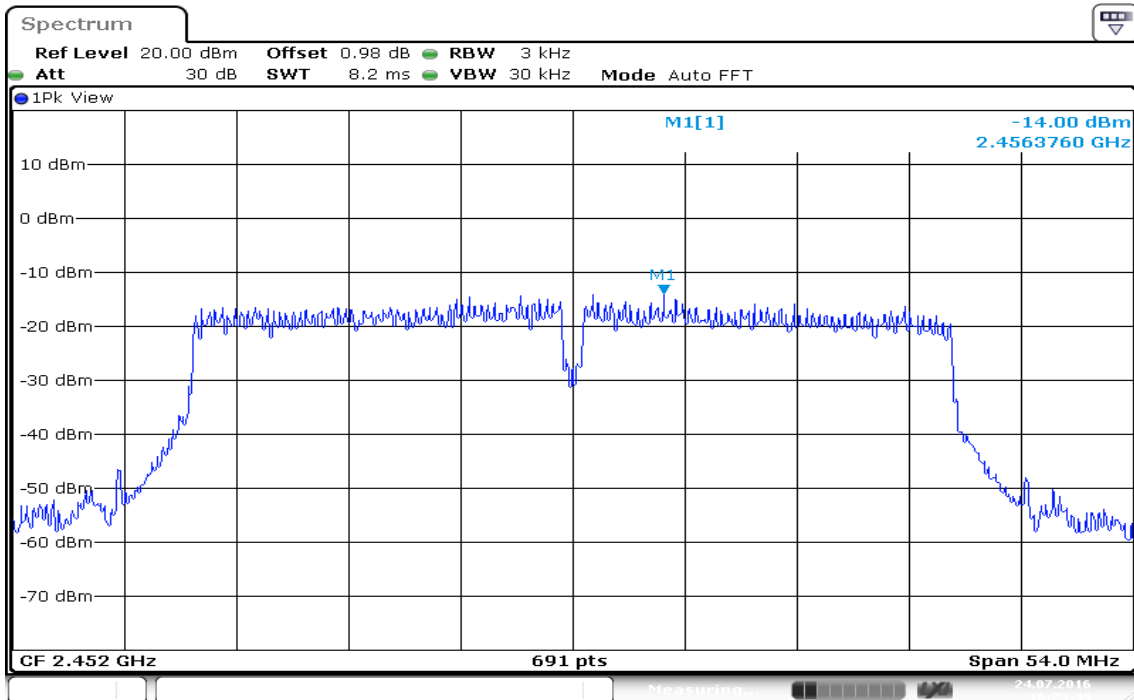

Date: 24 JUL 2016 16:23:49

7.7 RADIATED EMISSIONS

LIMIT

All spurious emissions shall comply with the limits of §15.209(a) and RSS-Gen Table 2 & Table 5.

RSS-Gen Table 2 & Table 5: General Field Strength Limits for Transmitters and Receivers at Frequencies Above 30 MHz ^(Note)

Frequency (MHz)	Field Strength microvolts/m at 3 metres (watts, e.i.r.p.)	
	Transmitters	Receivers
30-88	100 (3 nW)	100 (3 nW)
88-216	150 (6.8 nW)	150 (6.8 nW)
216-960	200 (12 nW)	200 (12 nW)
Above 960	500 (75 nW)	500 (75 nW)

Note: *Measurements for compliance with limits in the above table may be performed at distances other than 3 metres, in accordance with Section 7.2.7.

Transmitting devices are not permitted in Table 1 bands or, unless stated otherwise, in TV bands (54-72 MHz, 76-88 MHz, 174-216 MHz, 470-608 MHz and 614-806 MHz).

RSS-Gen Table 6: General Field Strength Limits for Transmitters at Frequencies Below 30 MHz (Transmit)

Frequency	Field Strength (microvolts/m)	Magnetic H-Field (microamperes/m)	Measurement Distance (metres)
9-490 kHz	2,400/F (F in kHz)	2,400/377F (F in kHz)	3000
490-1,705 kHz	24,000/F (F in kHz)	24,000/377F (F in kHz)	30
1.705-30 MHz	30	N/A	30

Note: The emission limits for the bands 9-90 kHz and 110-490 kHz are based on measurements employing an average detector.

Test Configuration

9kHz ~ 30MHz

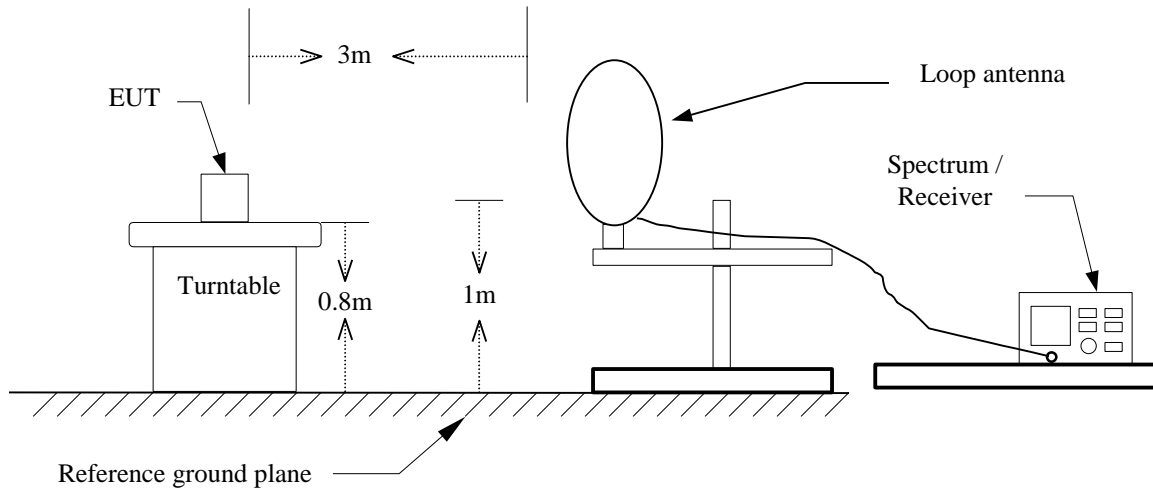

30MHz ~ 1GHz

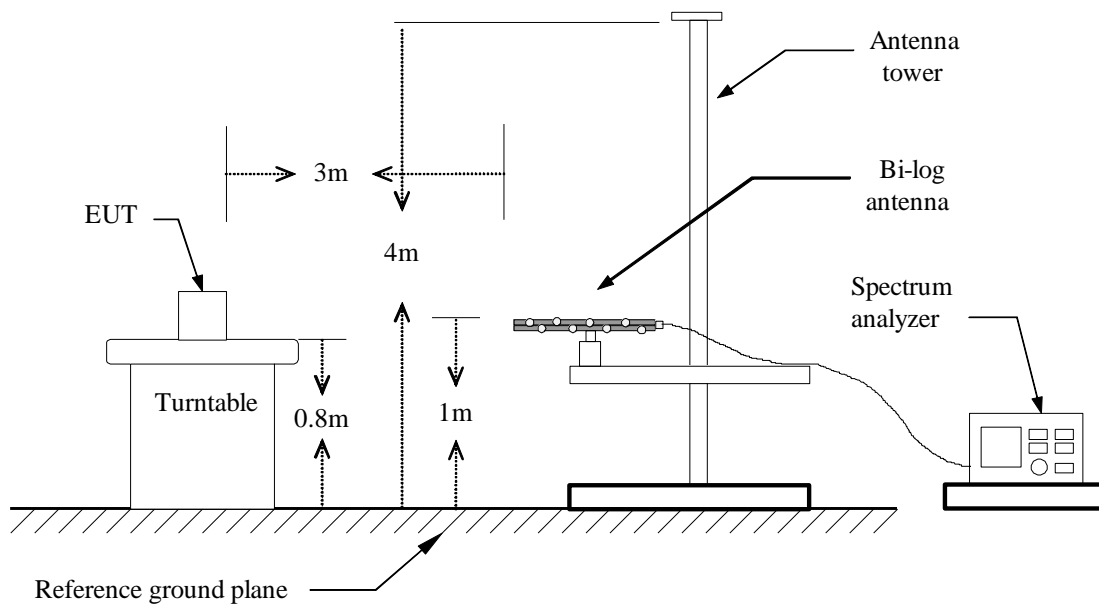

Above 1 GHz

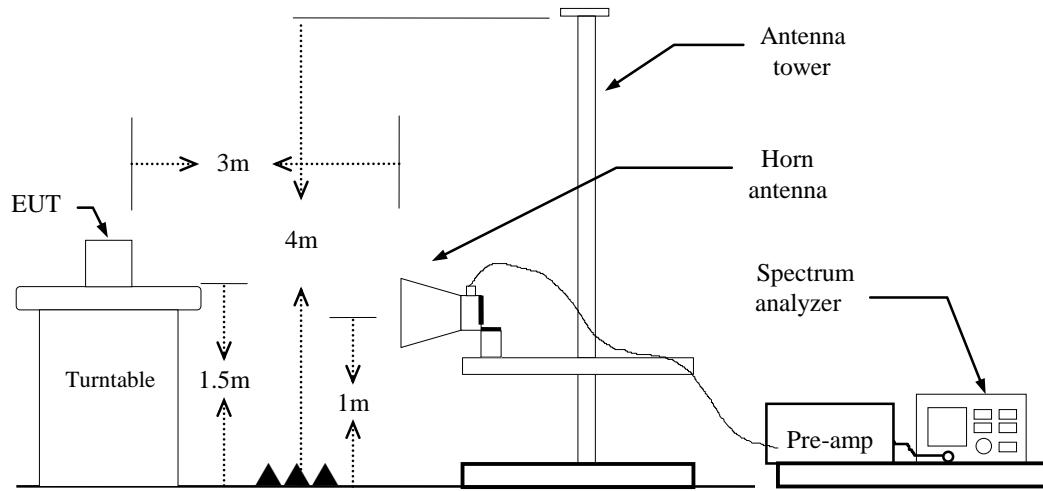

TEST PROCEDURE

1. The EUT is placed on a turntable, Above 1 GHz is 1.5m high and below 1 GHz is 0.8m high above ground plane.
2. The turntable shall be rotated for 360 degrees to determine the position of maximum emission level.
3. EUT is set 3m away from the receiving antenna, which is varied from 1m to 4m to find out the highest emissions.
4. Maximum procedure was performed on the six highest emissions to ensure EUT compliance.
5. And also, each emission was to be maximized by changing the polarization of receiving antenna both horizontal and vertical.
6. Set the spectrum analyzer in the following setting as:

Below 1GHz:

RBW=100kHz / VBW=300kHz / Sweep=AUTO

Above 1GHz:

(a) PEAK: RBW=1MHz / VBW=3MHz / Sweep=AUTO

(b) AVERAGE: RBW=1MHz,
if duty cycle \geq 98%, VBW=10Hz.
if duty cycle < 98% VBW=1/T.

IEEE 802.11b mode: \geq 98%, VBW=10Hz

IEEE 802.11g mode: =89%, VBW=680Hz

IEEE 802.11n HT 20 MHz mode: \geq 89%, VBW=750Hz

IEEE 802.11n HT 40 MHz mode: \geq 68%, VBW=2.7kHz

7. Repeat above procedures until the measurements for all frequencies are complete.
8. Result = Spectrum Reading + cable loss(spectrum to Amp) - Amp Gain + Cable loss(Amp to receive Ant)+ Receive Ant

Note: We checked every harmonics frequencies from Fundamental frequencies with reduced VBW, and we mark a point to prove pass or not if we find any emission. For this case, there are no emissions hidden in the noise floor.

Below 1GHz

Operation Mode: Normal Link

Test Date: August 5, 2016

Temperature: 27°C

Tested by: Dennis Li

Humidity: 53% RH

Polarity: Ver.

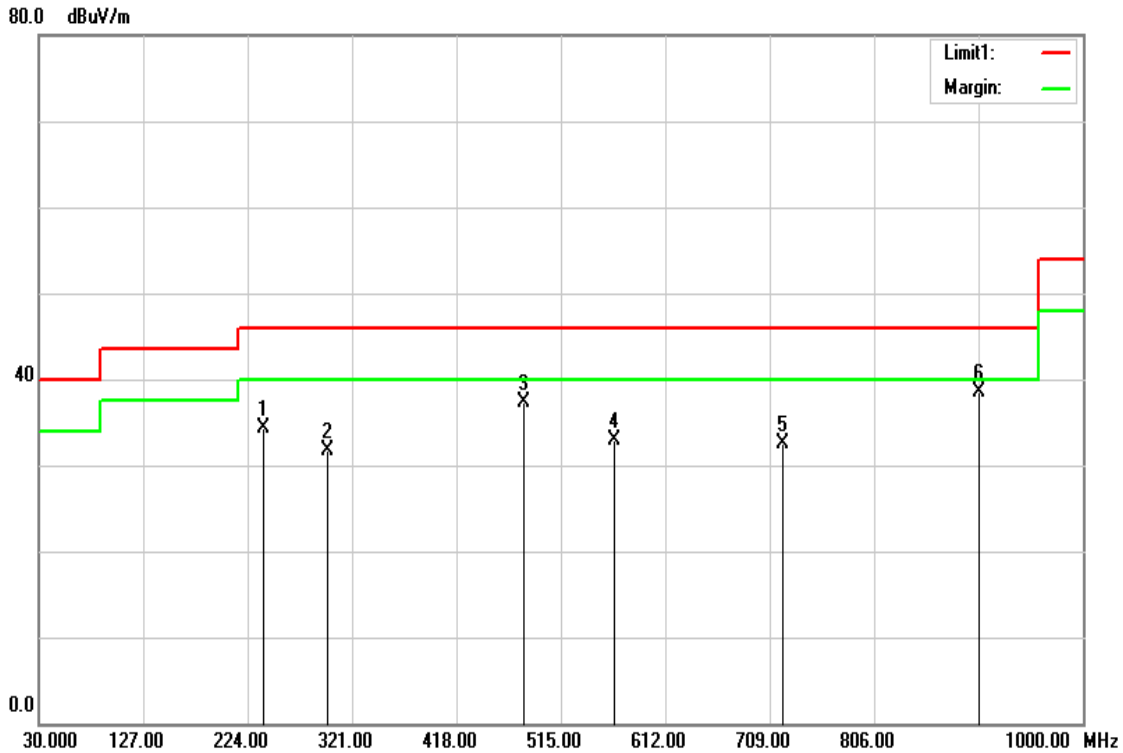

Frequency (MHz)	Reading (dBuV)	Correction Factor (dB/m)	Result (dBuV/m)	Limit (dBuV/m)	Margin (dB)	Remark	Ant. Pol. (H/V)
239.2000	50.77	-16.52	34.25	46.00	-11.75	peak	V
298.6900	45.89	-14.26	31.63	46.00	-14.37	peak	V
480.0800	46.85	-9.62	37.23	46.00	-8.77	peak	V
564.4700	41.15	-8.28	32.87	46.00	-13.13	peak	V
720.6400	38.16	-5.60	32.56	46.00	-13.44	peak	V
903.0000	41.62	-3.14	38.48	46.00	-7.52	QP	V

Remark:

1. Measuring frequencies from 30 MHz to the 1GHz.
2. Radiated emissions measured in frequency range from 30 MHz to 1000MHz were made with an instrument using peak/quasi-peak detector mode.
3. Quasi-peak test would be performed if the peak result were greater than the quasi-peak limit or as required by the applicant.
4. Measurements above show only up to 6 maximum emissions noted, or would be lesser, with " N/A " remark, if no specific emissions from the EUT are recorded (ie: margin>20dB from the applicable limit) and considered that's already beyond the background noise floor.
5. Margin (dB) = Result (dBuV/m) – Limit (dBuV/m).

Operation Mode: Normal Link

Test Date: August 5, 2016

Temperature: 27°C

Tested by: Dennis Li

Humidity: 53% RH

Polarity: Hor.

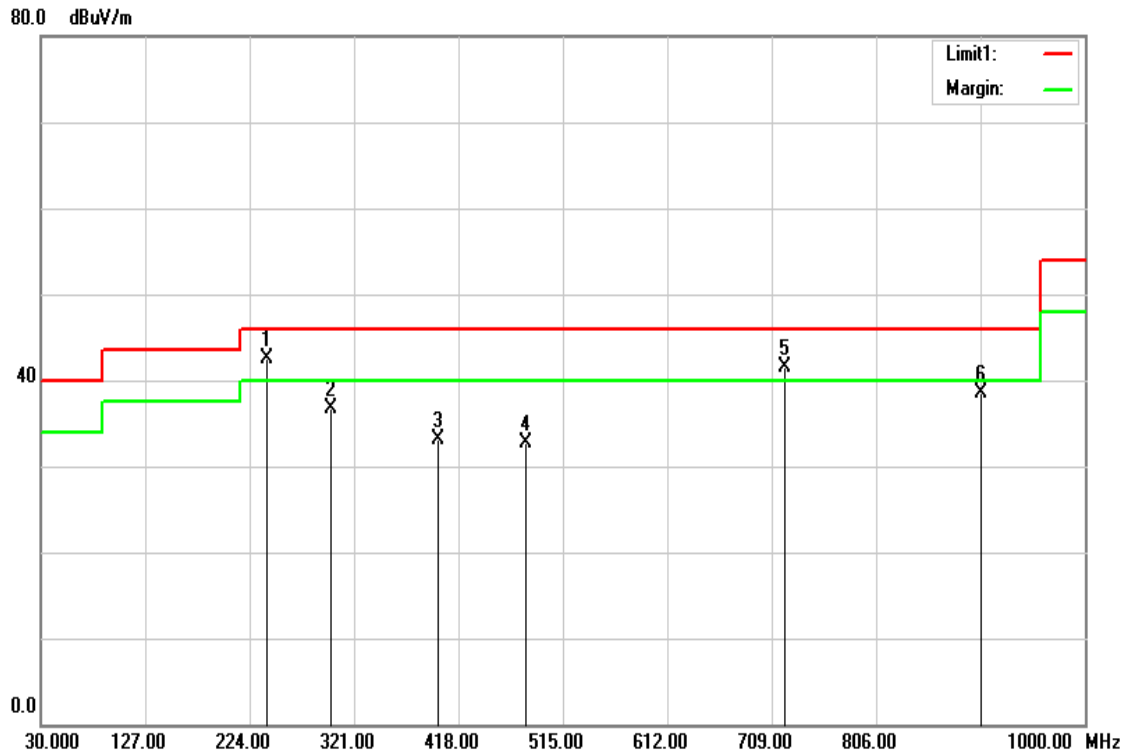

Frequency (MHz)	Reading (dBuV)	Correction Factor (dB/m)	Result (dBuV/m)	Limit (dBuV/m)	Margin (dB)	Remark	Ant. Pol. (H/V)
240.4900	59.04	-16.50	42.54	46.00	-3.46	QP	H
299.6600	50.97	-14.25	36.72	46.00	-9.28	peak	H
399.5700	44.89	-11.71	33.18	46.00	-12.82	peak	H
480.0800	42.35	-9.62	32.73	46.00	-13.27	peak	H
720.6400	47.14	-5.60	41.54	46.00	-4.46	QP	H
903.0000	41.71	-3.14	38.57	46.00	-7.43	QP	H

Remark:

1. Measuring frequencies from 30 MHz to the 1GHz.
2. Radiated emissions measured in frequency range from 30 MHz to 1000MHz were made with an instrument using peak/quasi-peak detector mode.
3. Quasi-peak test would be performed if the peak result were greater than the quasi-peak limit or as required by the applicant.
4. Measurements above show only up to 6 maximum emissions noted, or would be lesser, with " N/A " remark, if no specific emissions from the EUT are recorded (ie: margin>20dB from the applicable limit) and considered that's already beyond the background noise floor.
5. Margin (dB) = Result (dBuV/m) – Limit (dBuV/m).

Above 1 GHz

TX / IEEE 802.11b / CH Low

Polarity: Vertical

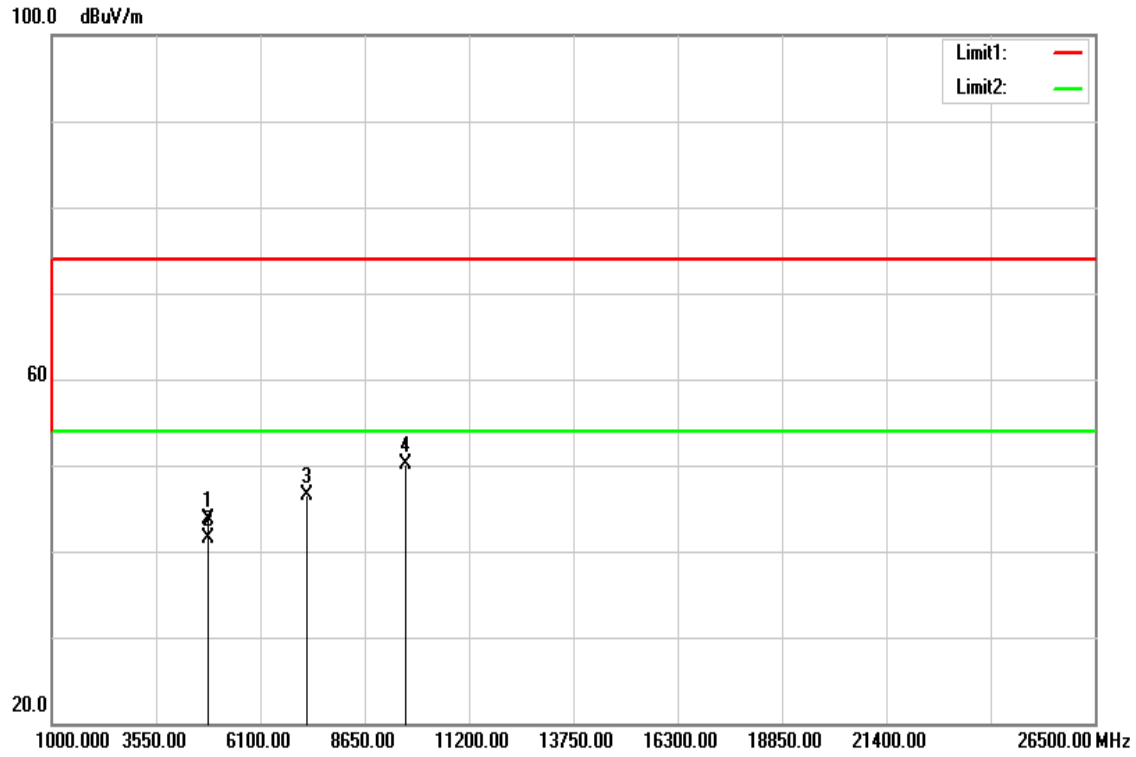

Polarity: Horizontal

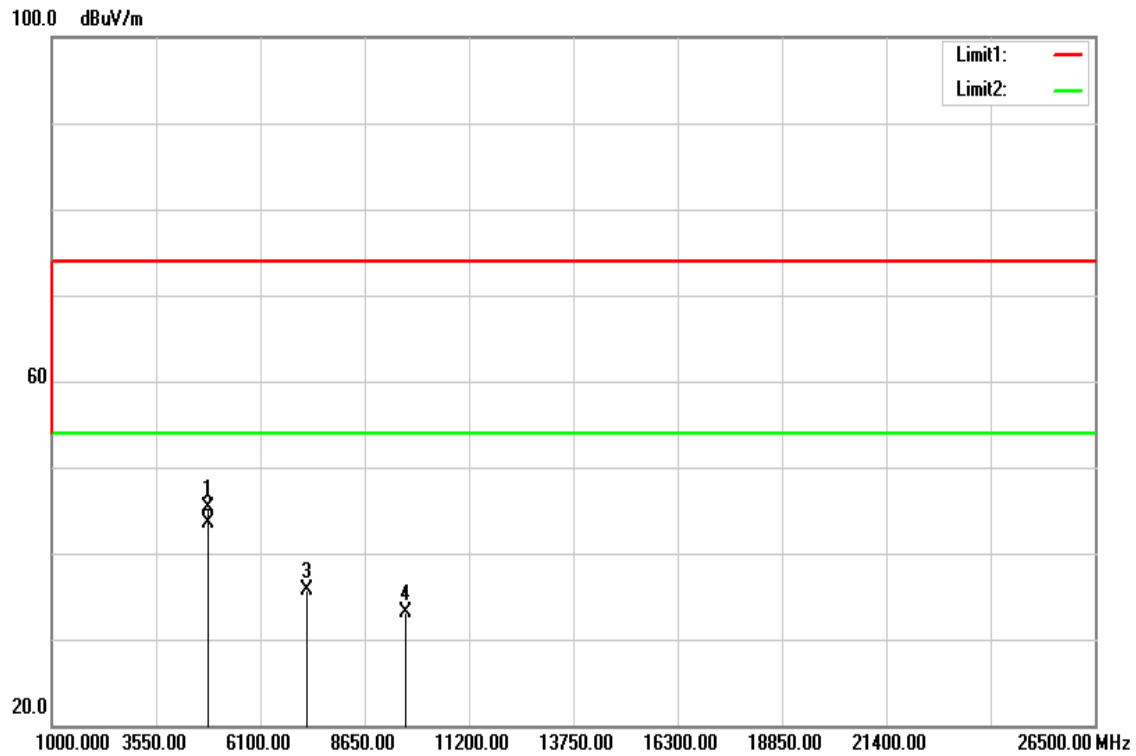

Above 1 GHz

Operation Mode: TX / IEEE 802.11b / CH Low

Test Date: July 29, 2016

Temperature: 27°C

Tested by: Dennis Li

Humidity: 53% RH

Polarity: Ver. / Hor.

Frequency (MHz)	Reading (dBuV)	Correction Factor (dB/m)	Result (dBuV/m)	Limit (dBuV/m)	Margin (dB)	Remark	Ant. Pol. (H/V)
4827.000	38.60	5.11	43.71	74.00	-30.29	peak	V
4827.000	36.30	5.11	41.41	54.00	-12.59	AVG	V
7236.000	33.71	12.71	46.42	74.00	-27.58	peak	V
9648.000	32.55	17.60	50.15	74.00	-23.85	peak	V
N/A							
4827.000	40.22	5.11	45.33	74.00	-28.67	peak	H
4827.000	38.35	5.11	43.46	54.00	-10.54	AVG	H
7236.000	22.92	12.71	35.63	74.00	-38.37	peak	H
9648.000	15.50	17.60	33.10	74.00	-40.90	peak	H
N/A							

Remark:

1. Measuring frequencies from 1 GHz to the 10th harmonic of highest fundamental frequency.
2. Radiated emissions measured in frequency above 1000MHz were made with an instrument using peak/average detector mode.
3. Average test would be performed if the peak result were greater than the average limit or as required by the applicant.
4. Data of measurement within this frequency range shown " --- " in the table above means the reading of emissions are attenuated more than 20dB below the permissible limits or the field strength is too small to be measured.
5. Measurements above show only up to 6 maximum emissions noted, or would be lesser, with " N/A " remark, if no specific emissions from the EUT are recorded (ie: margin>20dB from the applicable limit) and considered that's already beyond the background noise floor.
6. Margin (dB) = Remark result (dBuV/m) – Average limit (dBuV/m).

TX / IEEE 802.11b / CH Mid

Polarity: Vertical

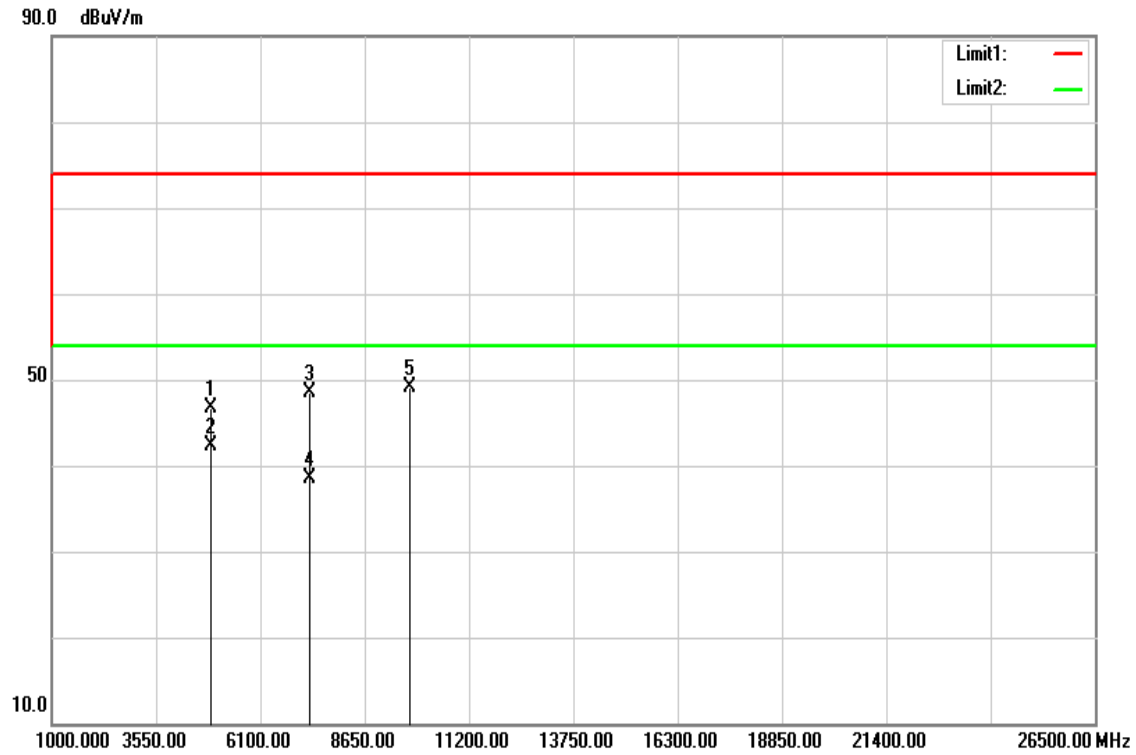

Polarity: Horizontal

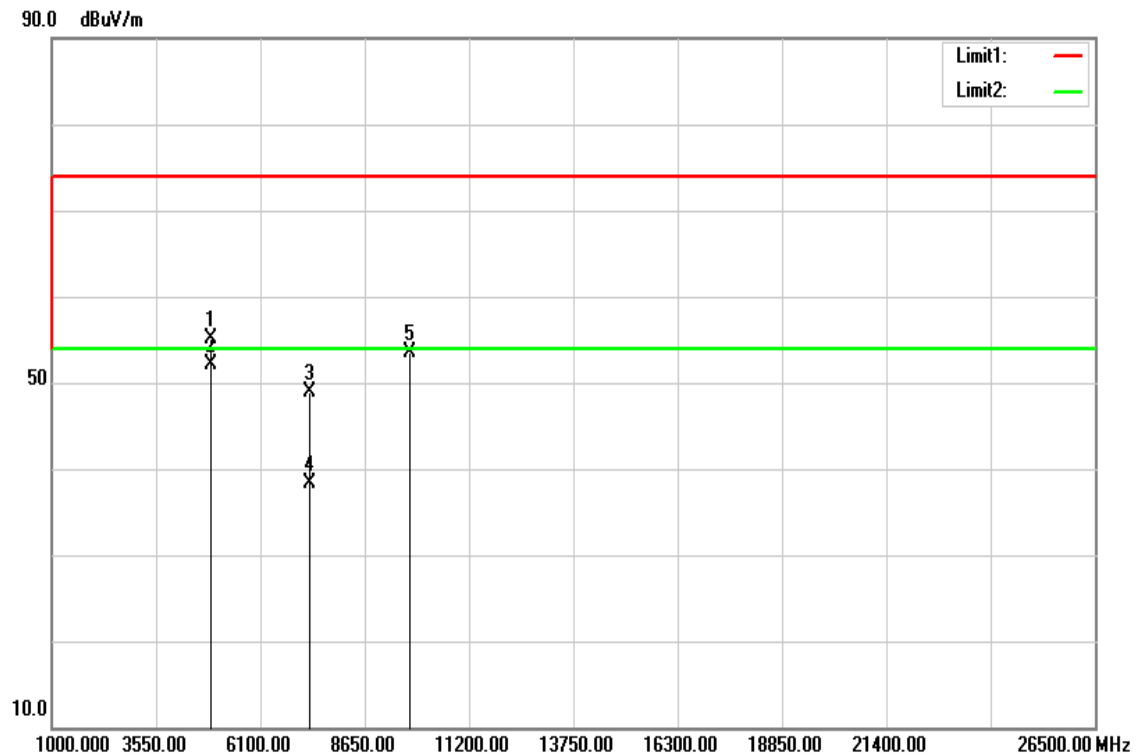

Operation Mode: TX / IEEE 802.11b / CH Mid

Test Date: July 29, 2016

Temperature: 27°C

Tested by: Dennis Li

Humidity: 53% RH

Polarity: Ver. / Hor.

Frequency (MHz)	Reading (dBuV)	Correction Factor (dB/m)	Result (dBuV/m)	Limit (dBuV/m)	Margin (dB)	Remark	Ant. Pol. (H/V)
4876.000	41.41	5.24	46.65	74.00	-27.35	peak	V
4876.000	37.04	5.24	42.28	54.00	-11.72	AVG	V
7311.000	35.63	12.94	48.57	74.00	-25.43	peak	V
7311.000	25.63	12.94	38.57	54.00	-15.43	AVG	V
9748.000	31.53	17.60	49.13	74.00	-24.87	peak	V
N/A							
4876.000	49.87	5.24	55.11	74.00	-18.89	peak	H
4876.000	46.96	5.24	52.20	54.00	-1.80	AVG	H
7311.000	36.04	12.94	48.98	74.00	-25.02	peak	H
7311.000	25.44	12.94	38.38	54.00	-15.62	AVG	H
9748.000	35.96	17.60	53.56	74.00	-20.44	peak	H
N/A							

Remark:

1. Measuring frequencies from 1 GHz to the 10th harmonic of highest fundamental frequency.
2. Radiated emissions measured in frequency above 1000MHz were made with an instrument using peak/average detector mode.
3. Average test would be performed if the peak result were greater than the average limit or as required by the applicant.
4. Data of measurement within this frequency range shown " --- " in the table above means the reading of emissions are attenuated more than 20dB below the permissible limits or the field strength is too small to be measured.
5. Measurements above show only up to 6 maximum emissions noted, or would be lesser, with " N/A " remark, if no specific emissions from the EUT are recorded (ie: margin>20dB from the applicable limit) and considered that's already beyond the background noise floor.
6. Margin (dB) = Remark result (dBuV/m) – Average limit (dBuV/m).

TX / IEEE 802.11b / CH High

Polarity: Vertical

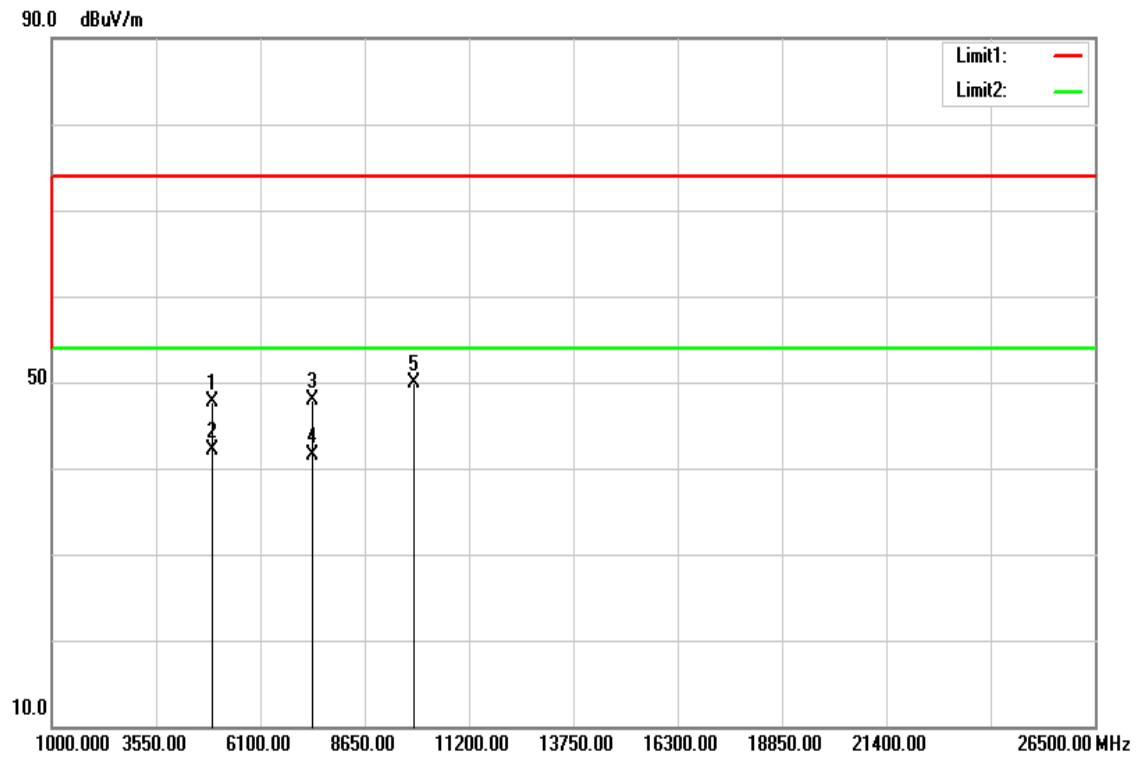

Polarity: Horizontal

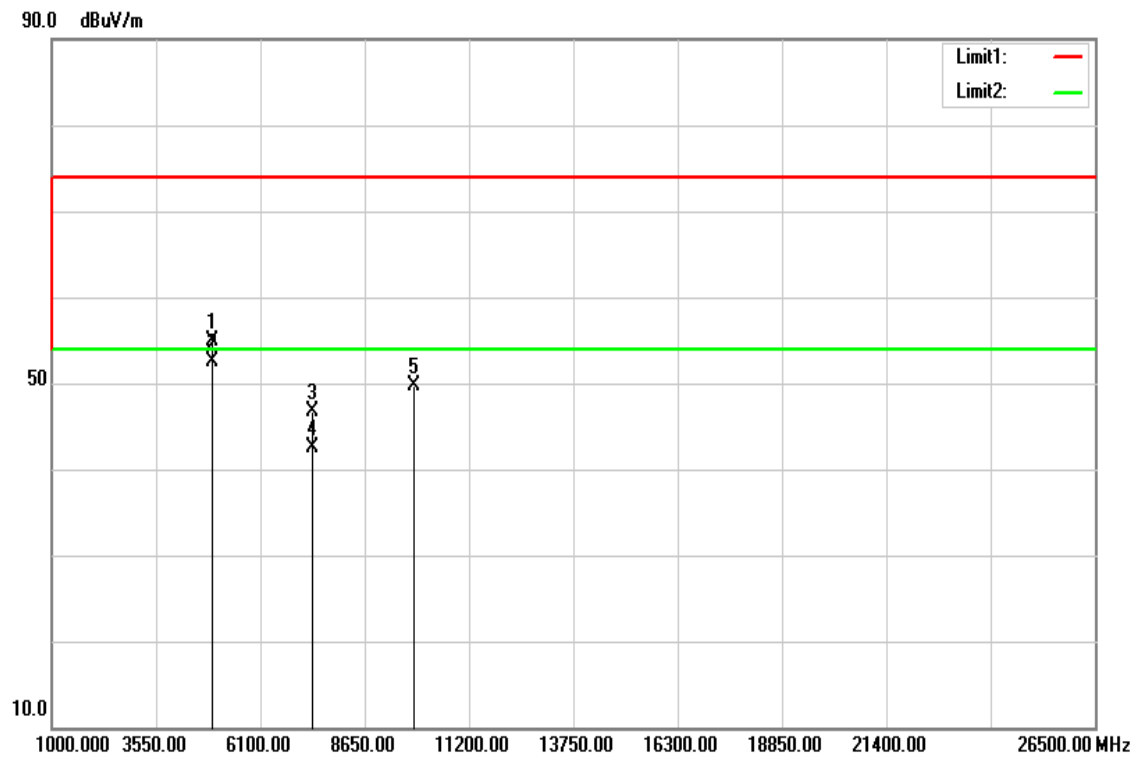

Operation Mode: TX / IEEE 802.11b / CH High

Test Date: July 29, 2016

Temperature: 27°C

Tested by: Dennis Li

Humidity: 53% RH

Polarity: Ver. / Hor.

Frequency (MHz)	Reading (dBuV)	Correction Factor (dB/m)	Result (dBuV/m)	Limit (dBuV/m)	Margin (dB)	Remark	Ant. Pol. (H/V)
4925.000	42.38	5.37	47.75	74.00	-26.25	peak	V
4925.000	36.78	5.37	42.15	54.00	-11.85	AVG	V
7386.000	34.68	13.17	47.85	74.00	-26.15	peak	V
7386.000	28.41	13.17	41.58	54.00	-12.42	AVG	V
9848.000	32.32	17.60	49.92	74.00	-24.08	peak	V
N/A							
4925.000	49.44	5.37	54.81	74.00	-19.19	peak	H
4925.000	47.15	5.37	52.52	54.00	-1.48	AVG	H
7386.000	33.63	13.17	46.80	74.00	-27.20	peak	H
7386.000	29.38	13.17	42.55	54.00	-11.45	AVG	H
9848.000	32.03	17.60	49.63	74.00	-24.37	peak	H
N/A							

Remark:

1. Measuring frequencies from 1 GHz to the 10th harmonic of highest fundamental frequency.
2. Radiated emissions measured in frequency above 1000MHz were made with an instrument using peak/average detector mode.
3. Average test would be performed if the peak result were greater than the average limit or as required by the applicant.
4. Data of measurement within this frequency range shown " --- " in the table above means the reading of emissions are attenuated more than 20dB below the permissible limits or the field strength is too small to be measured.
5. Measurements above show only up to 6 maximum emissions noted, or would be lesser, with " N/A " remark, if no specific emissions from the EUT are recorded (ie: margin>20dB from the applicable limit) and considered that's already beyond the background noise floor.
6. Margin (dB) = Remark result (dBuV/m) – Average limit (dBuV/m).

TX / IEEE 802.11g / CH Low

Polarity: Vertical

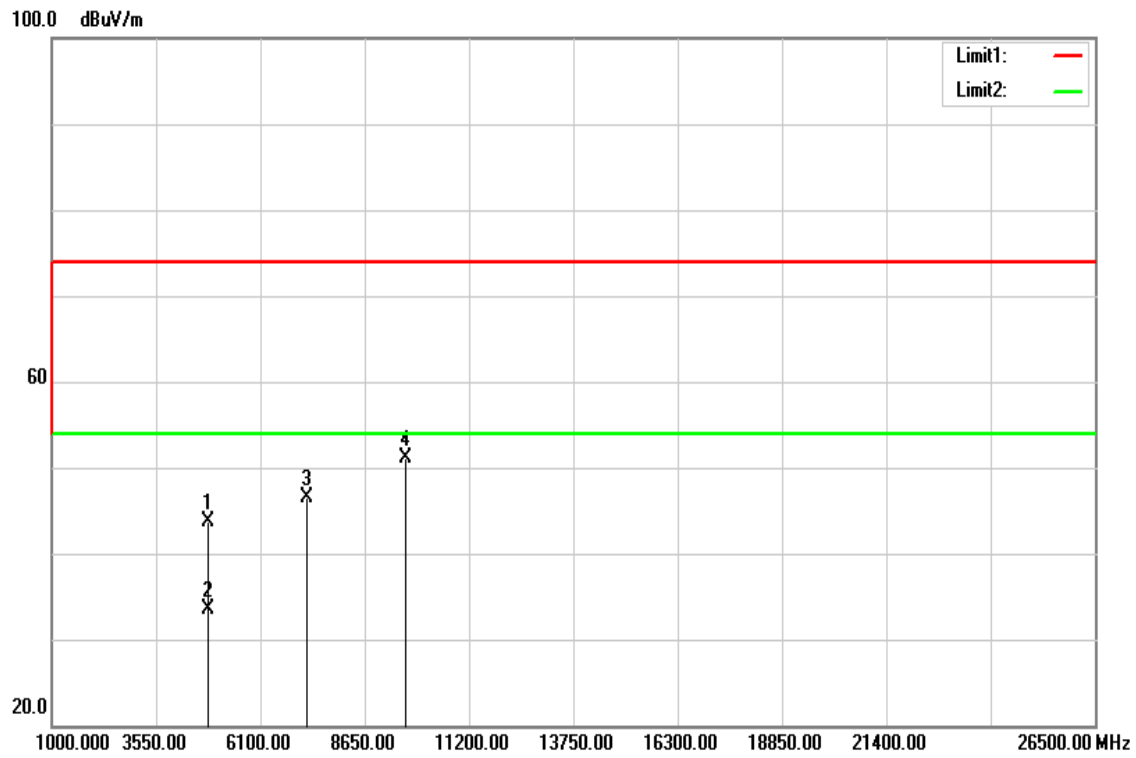

Polarity: Horizontal

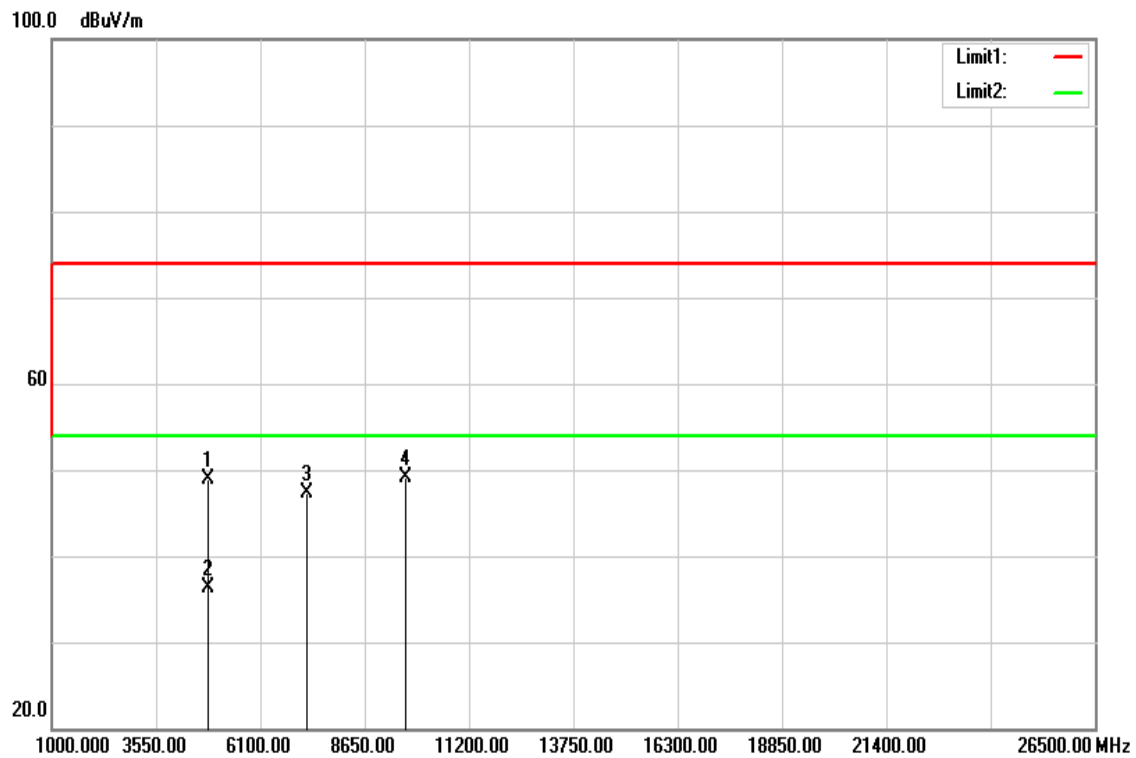

Operation Mode: TX / IEEE 802.11g / CH Low

Test Date: July 29, 2016

Temperature: 27°C

Tested by: Dennis Li

Humidity: 53% RH

Polarity: Ver. / Hor.

Frequency (MHz)	Reading (dBuV)	Correction Factor (dB/m)	Result (dBuV/m)	Limit (dBuV/m)	Margin (dB)	Remark	Ant. Pol. (H/V)
4827.000	38.55	5.11	43.66	74.00	-30.34	peak	V
4827.000	28.48	5.11	33.59	54.00	-20.41	AVG	V
7236.000	33.80	12.71	46.51	74.00	-27.49	peak	V
9648.000	33.54	17.60	51.14	74.00	-22.86	peak	V
N/A							
4827.000	43.76	5.11	48.87	74.00	-25.13	peak	H
4827.000	31.13	5.11	36.24	54.00	-17.76	AVG	H
7236.000	34.69	12.71	47.40	74.00	-26.60	peak	H
9648.000	31.42	17.60	49.02	74.00	-24.98	peak	H
N/A							

Remark:

1. *Measuring frequencies from 1 GHz to the 10th harmonic of highest fundamental frequency.*
2. *Radiated emissions measured in frequency above 1000MHz were made with an instrument using peak/average detector mode.*
3. *Average test would be performed if the peak result were greater than the average limit or as required by the applicant.*
4. *Data of measurement within this frequency range shown “ --- ” in the table above means the reading of emissions are attenuated more than 20dB below the permissible limits or the field strength is too small to be measured.*
5. *Measurements above show only up to 6 maximum emissions noted, or would be lesser, with “ N/A ” remark, if no specific emissions from the EUT are recorded (ie: margin>20dB from the applicable limit) and considered that's already beyond the background noise floor.*
6. *Margin (dB) = Remark result (dBuV/m) – Average limit (dBuV/m).*

TX / IEEE 802.11g / CH Mid

Polarity: Vertical

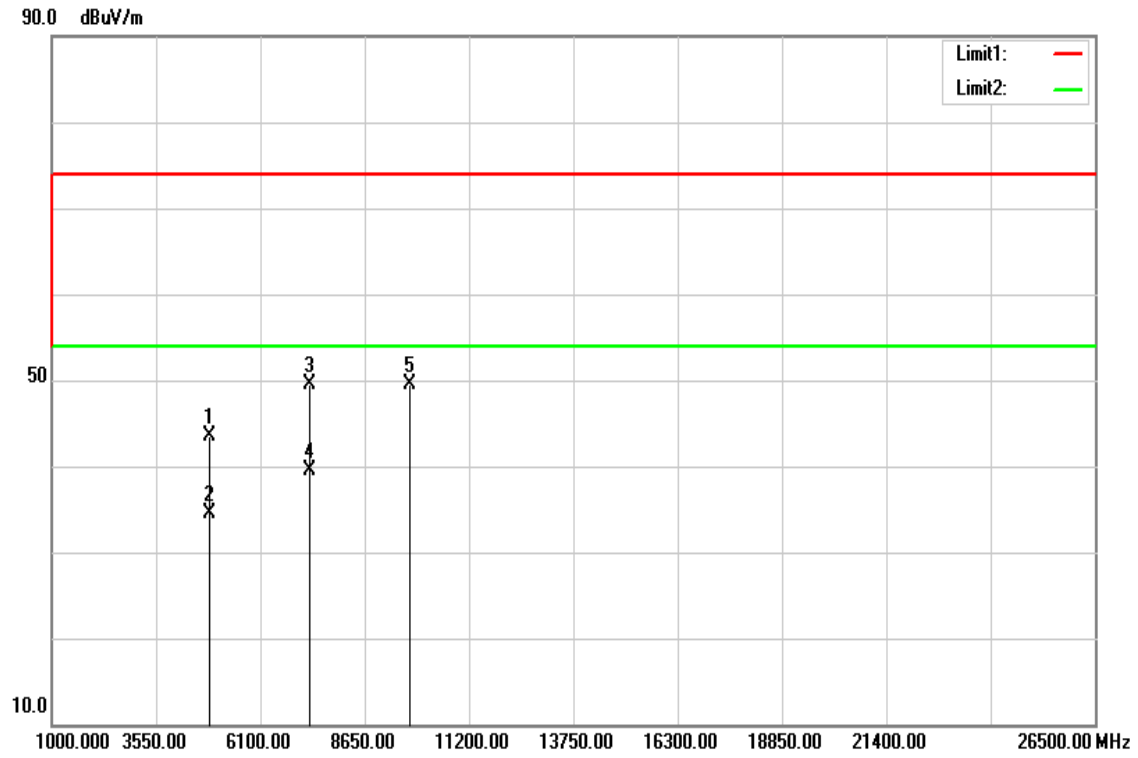

Polarity: Horizontal

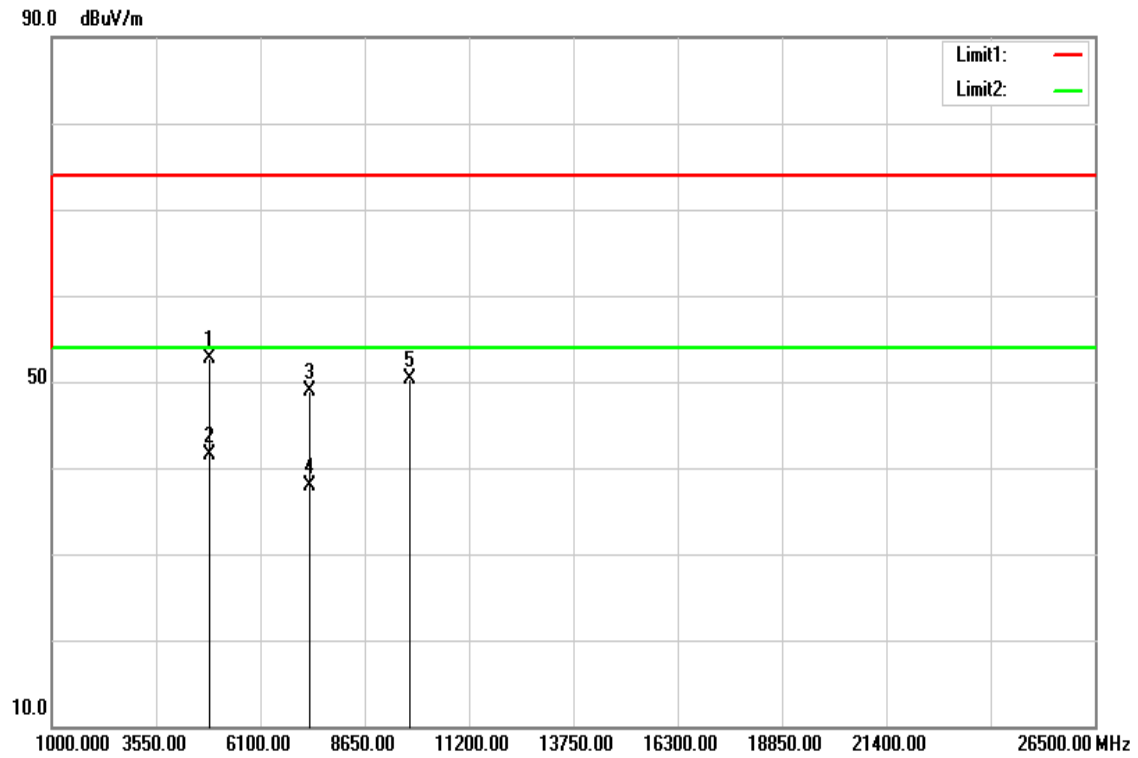

Operation Mode: TX / IEEE 802.11g / CH Mid

Test Date: July 29, 2016

Temperature: 27°C

Tested by: Dennis Li

Humidity: 53% RH

Polarity: Ver. / Hor.

Frequency (MHz)	Reading (dBuV)	Correction Factor (dB/m)	Result (dBuV/m)	Limit (dBuV/m)	Margin (dB)	Remark	Ant. Pol. (H/V)
4874.000	38.31	5.23	43.54	74.00	-30.46	peak	V
4874.000	29.31	5.23	34.54	54.00	-19.46	AVG	V
7311.000	36.63	12.94	49.57	74.00	-24.43	peak	V
7311.000	26.60	12.94	39.54	54.00	-14.46	AVG	V
9748.000	31.93	17.60	49.53	74.00	-24.47	peak	V
N/A							
4869.000	47.47	5.22	52.69	74.00	-21.31	peak	H
4869.000	36.35	5.22	41.57	54.00	-12.43	AVG	H
7311.000	35.93	12.94	48.87	74.00	-25.13	peak	H
7311.000	24.93	12.94	37.87	54.00	-16.13	AVG	H
9748.000	32.64	17.60	50.24	74.00	-23.76	peak	H
N/A							

Remark:

1. Measuring frequencies from 1 GHz to the 10th harmonic of highest fundamental frequency.
2. Radiated emissions measured in frequency above 1000MHz were made with an instrument using peak/average detector mode.
3. Average test would be performed if the peak result were greater than the average limit or as required by the applicant.
4. Data of measurement within this frequency range shown " --- " in the table above means the reading of emissions are attenuated more than 20dB below the permissible limits or the field strength is too small to be measured.
5. Measurements above show only up to 6 maximum emissions noted, or would be lesser, with " N/A " remark, if no specific emissions from the EUT are recorded (ie: margin>20dB from the applicable limit) and considered that's already beyond the background noise floor.
6. Margin (dB) = Remark result (dBuV/m) – Average limit (dBuV/m).

TX / IEEE 802.11g / CH High

Polarity: Vertical

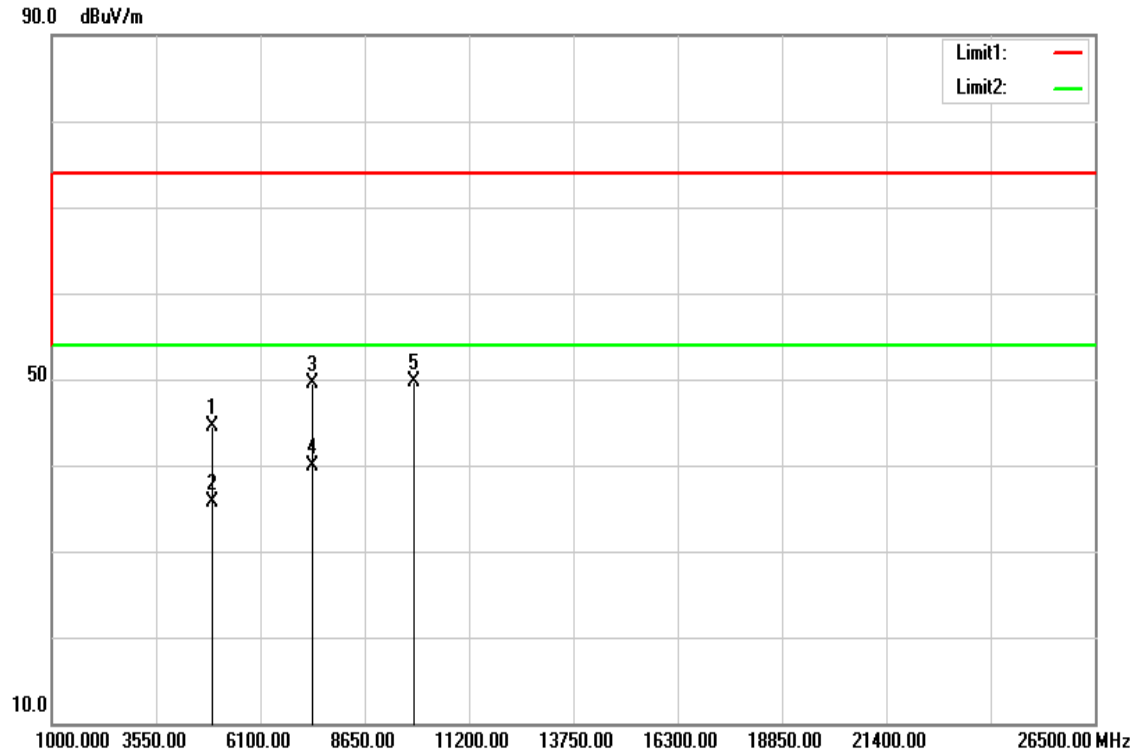

Polarity: Horizontal

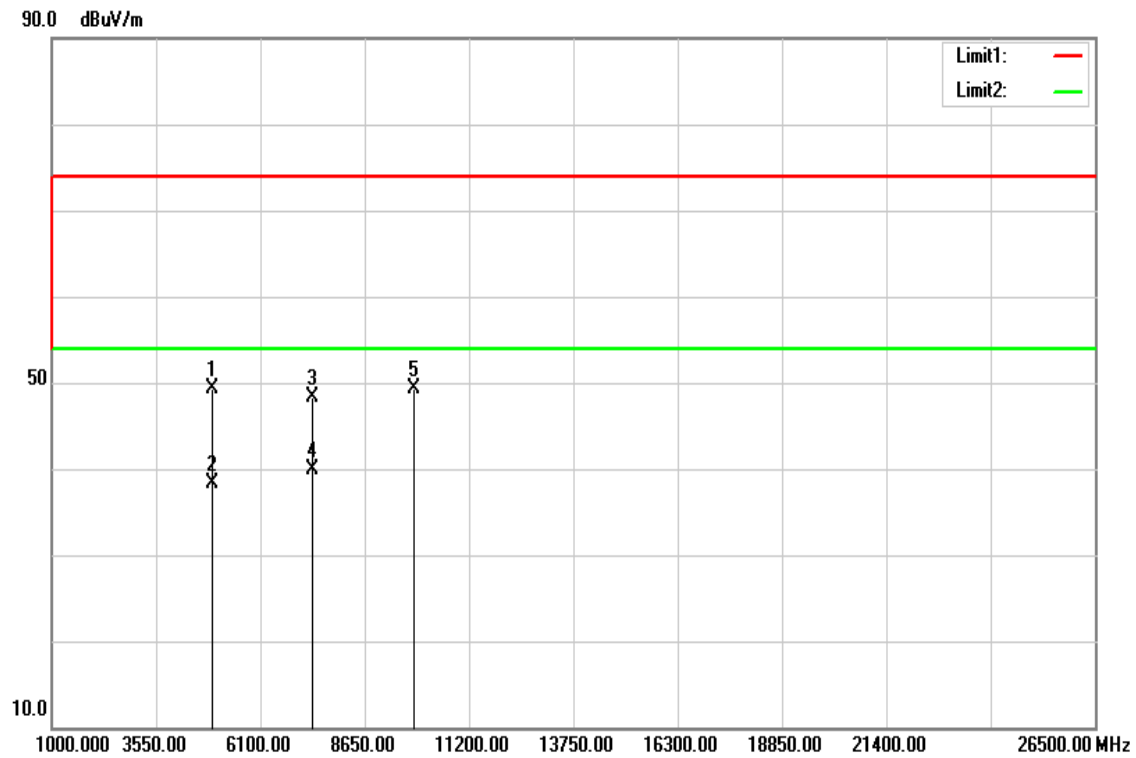

Operation Mode: TX / IEEE 802.11g / CH High

Test Date: July 29, 2016

Temperature: 27°C

Tested by: Dennis Li

Humidity: 53% RH

Polarity: Ver. / Hor.

Frequency (MHz)	Reading (dBuV)	Correction Factor (dB/m)	Result (dBuV/m)	Limit (dBuV/m)	Margin (dB)	Remark	Ant. Pol. (H/V)
4925.000	39.20	5.37	44.57	74.00	-29.43	peak	V
4925.000	30.41	5.37	35.78	54.00	-18.22	AVG	V
7386.000	36.34	13.17	49.51	74.00	-24.49	peak	V
7386.000	26.70	13.17	39.87	54.00	-14.13	AVG	V
9848.000	32.18	17.60	49.78	74.00	-24.22	peak	V
N/A							
4925.000	43.98	5.37	49.35	74.00	-24.65	peak	H
4925.000	32.98	5.37	38.35	54.00	-15.65	AVG	H
7386.000	35.18	13.17	48.35	74.00	-25.65	peak	H
7386.000	26.70	13.17	39.87	54.00	-14.13	AVG	H
9848.000	31.74	17.60	49.34	74.00	-24.66	peak	H
N/A							

Remark:

1. Measuring frequencies from 1 GHz to the 10th harmonic of highest fundamental frequency.
2. Radiated emissions measured in frequency above 1000MHz were made with an instrument using peak/average detector mode.
3. Average test would be performed if the peak result were greater than the average limit or as required by the applicant.
4. Data of measurement within this frequency range shown " --- " in the table above means the reading of emissions are attenuated more than 20dB below the permissible limits or the field strength is too small to be measured.
5. Measurements above show only up to 6 maximum emissions noted, or would be lesser, with " N/A " remark, if no specific emissions from the EUT are recorded (ie: margin>20dB from the applicable limit) and considered that's already beyond the background noise floor.
6. Margin (dB) = Remark result (dBuV/m) – Average limit (dBuV/m).

TX / IEEE 802.11n HT 20 MHz mode / CH Low

Polarity: Vertical

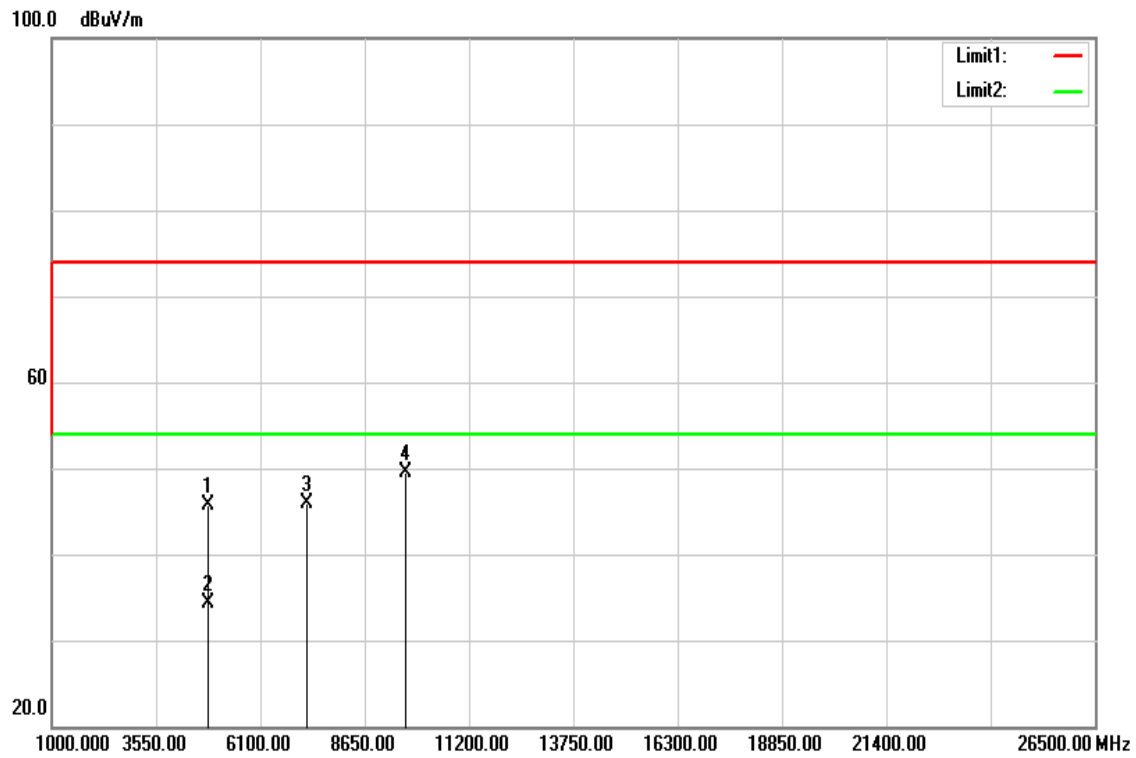

Polarity: Horizontal

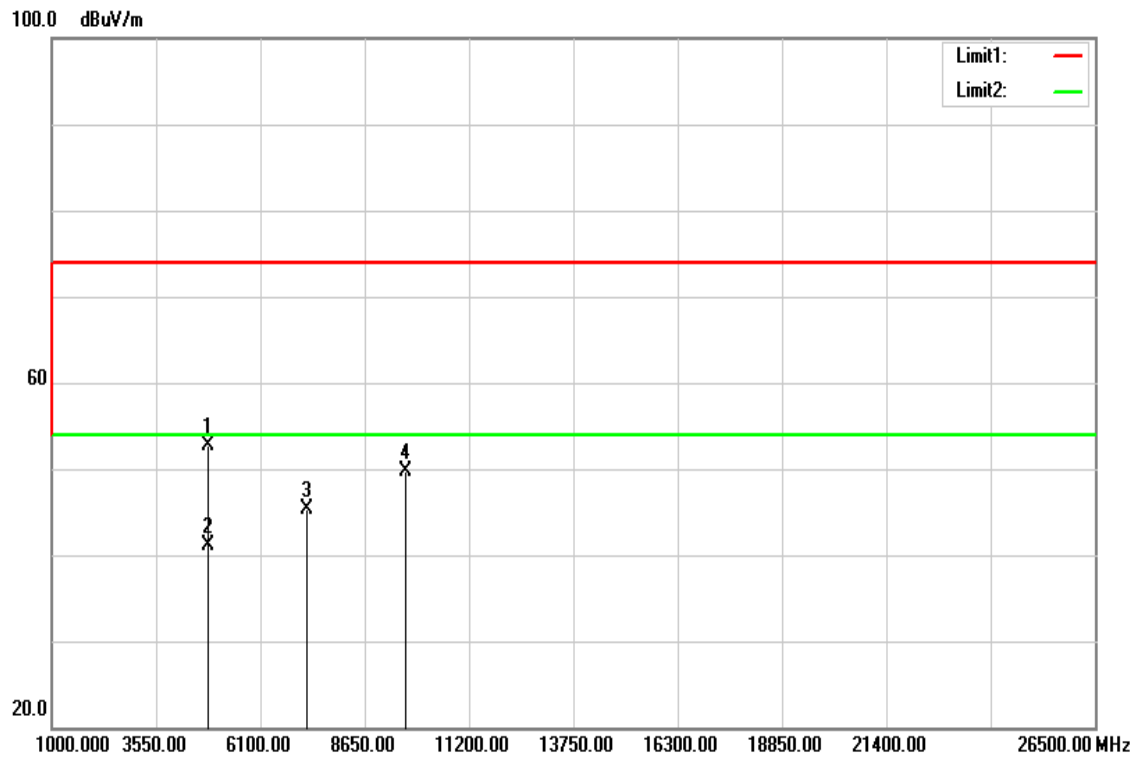

Operation Mode: TX / IEEE 802.11n HT 20 MHz mode / CH Low **Test Date:** July 29, 2016

Temperature: 27°C

Tested by: Dennis Li

Humidity: 53% RH

Polarity: Ver. / Hor.

Frequency (MHz)	Reading (dBuV)	Correction Factor (dB/m)	Result (dBuV/m)	Limit (dBuV/m)	Margin (dB)	Remark	Ant. Pol. (H/V)
4827.000	40.56	5.11	45.67	74.00	-28.33	peak	V
4827.000	29.12	5.11	34.23	54.00	-19.77	AVG	V
7236.000	33.18	12.71	45.89	74.00	-28.11	peak	V
9648.000	31.95	17.60	49.55	74.00	-24.45	peak	V
N/A							
4827.000	47.69	5.11	52.80	74.00	-21.20	peak	H
4827.000	36.05	5.11	41.16	54.00	-12.84	AVG	H
7236.000	32.68	12.71	45.39	74.00	-28.61	peak	H
9648.000	32.07	17.60	49.67	74.00	-24.33	peak	H
N/A							

Remark:

1. Measuring frequencies from 1 GHz to the 10th harmonic of highest fundamental frequency.
2. Radiated emissions measured in frequency above 1000MHz were made with an instrument using peak/average detector mode.
3. Average test would be performed if the peak result were greater than the average limit or as required by the applicant.
4. Data of measurement within this frequency range shown " --- " in the table above means the reading of emissions are attenuated more than 20dB below the permissible limits or the field strength is too small to be measured.
5. Measurements above show only up to 6 maximum emissions noted, or would be lesser, with " N/A " remark, if no specific emissions from the EUT are recorded (ie: margin>20dB from the applicable limit) and considered that's already beyond the background noise floor.
6. Margin (dB) = Remark result (dBuV/m) – Average limit (dBuV/m).

TX / IEEE 802.11n HT 20 MHz mode / CH Mid

Polarity: Vertical

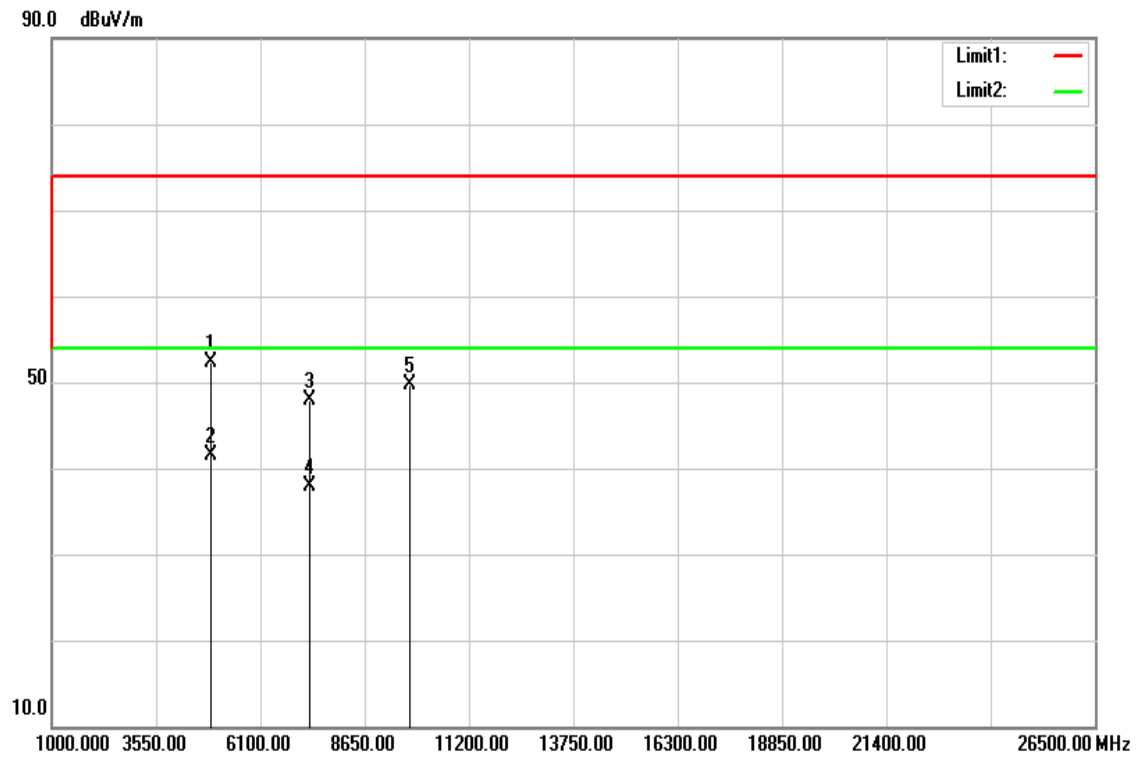

Polarity: Horizontal

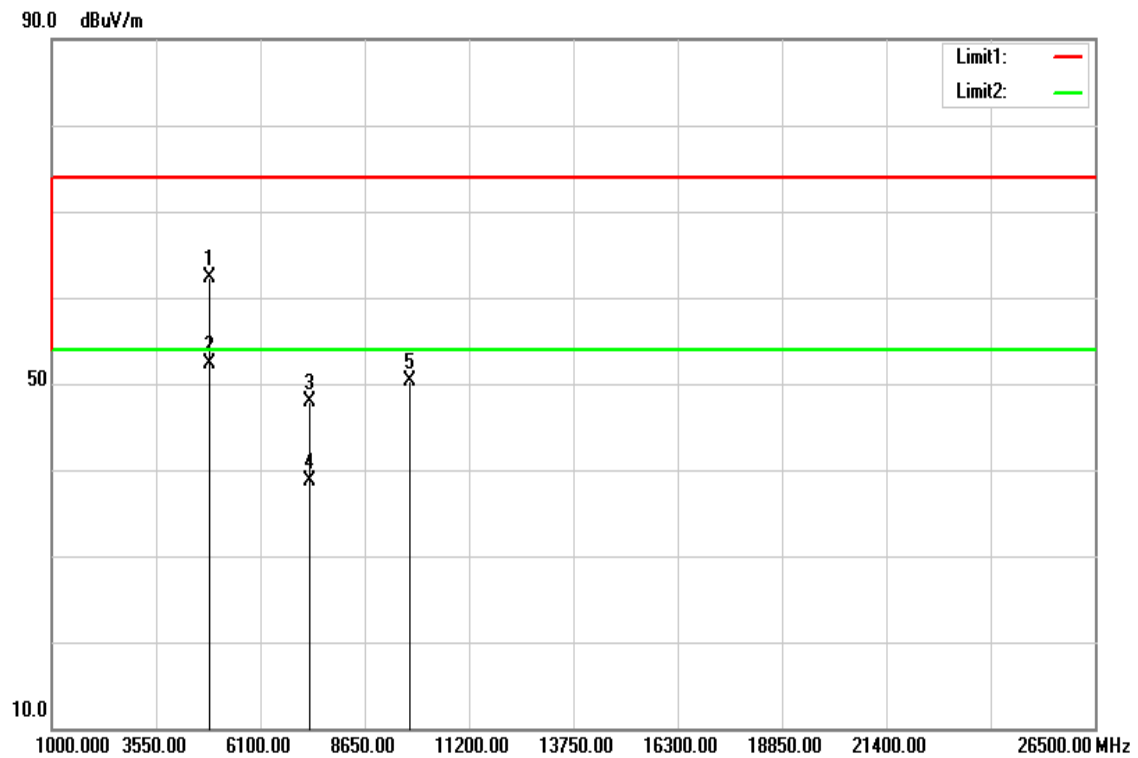

Operation Mode: TX / IEEE 802.11n HT 20 MHz mode / CH Mid **Test Date:** July 29, 2016

Temperature: 27°C

Tested by: Dennis Li

Humidity: 53% RH

Polarity: Ver. / Hor.

Frequency (MHz)	Reading (dBuV)	Correction Factor (dB/m)	Result (dBuV/m)	Limit (dBuV/m)	Margin (dB)	Remark	Ant. Pol. (H/V)
4876.000	47.06	5.24	52.30	74.00	-21.70	peak	V
4876.000	36.31	5.24	41.55	54.00	-12.45	AVG	V
7311.000	34.99	12.94	47.93	74.00	-26.07	peak	V
7311.000	24.93	12.94	37.87	54.00	-16.13	AVG	V
9748.000	32.12	17.60	49.72	74.00	-24.28	peak	V
N/A							
4869.000	57.10	5.22	62.32	74.00	-11.68	peak	H
4869.000	47.11	5.22	52.33	54.00	-1.67	AVG	H
7311.000	34.89	12.94	47.83	74.00	-26.17	peak	H
7311.000	25.71	12.94	38.65	54.00	-15.35	AVG	H
9748.000	32.72	17.60	50.32	74.00	-23.68	peak	H
N/A							

Remark:

1. Measuring frequencies from 1 GHz to the 10th harmonic of highest fundamental frequency.
2. Radiated emissions measured in frequency above 1000MHz were made with an instrument using peak/average detector mode.
3. Average test would be performed if the peak result were greater than the average limit or as required by the applicant.
4. Data of measurement within this frequency range shown " --- " in the table above means the reading of emissions are attenuated more than 20dB below the permissible limits or the field strength is too small to be measured.
5. Measurements above show only up to 6 maximum emissions noted, or would be lesser, with " N/A " remark, if no specific emissions from the EUT are recorded (ie: margin>20dB from the applicable limit) and considered that's already beyond the background noise floor.
6. Margin (dB) = Remark result (dBuV/m) – Average limit (dBuV/m).

TX / IEEE 802.11n HT 20 MHz mode / CH High

Polarity: Vertical

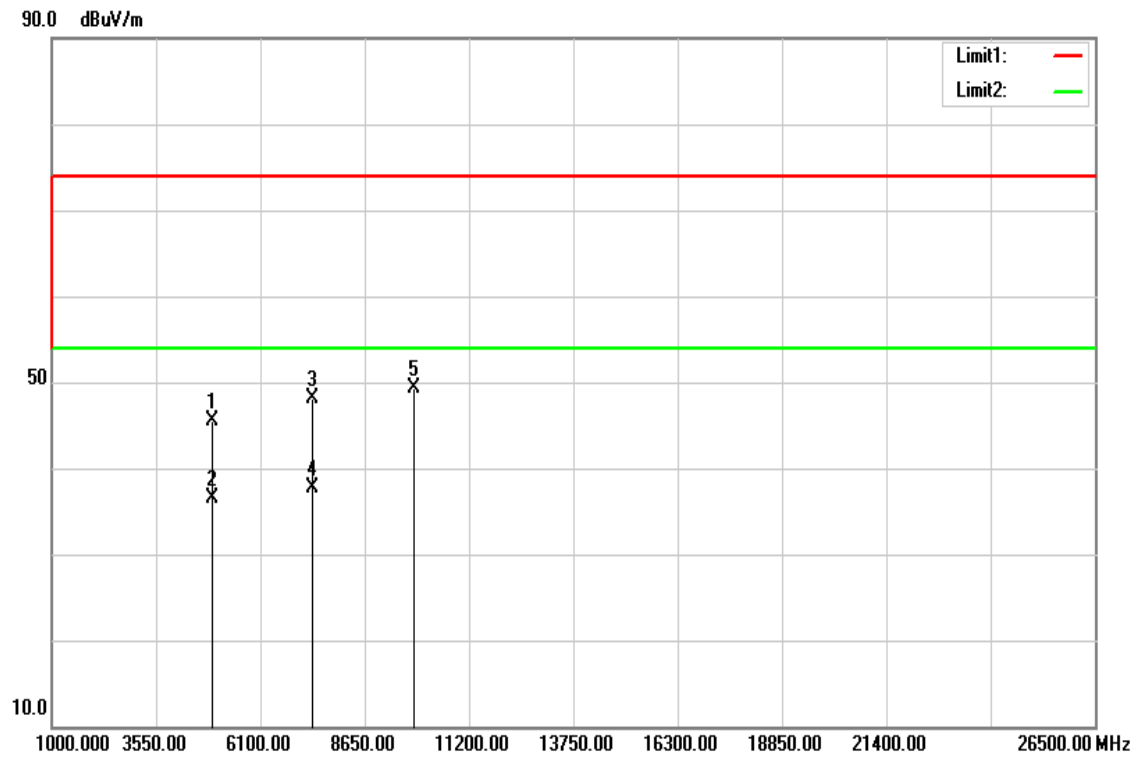

Polarity: Horizontal

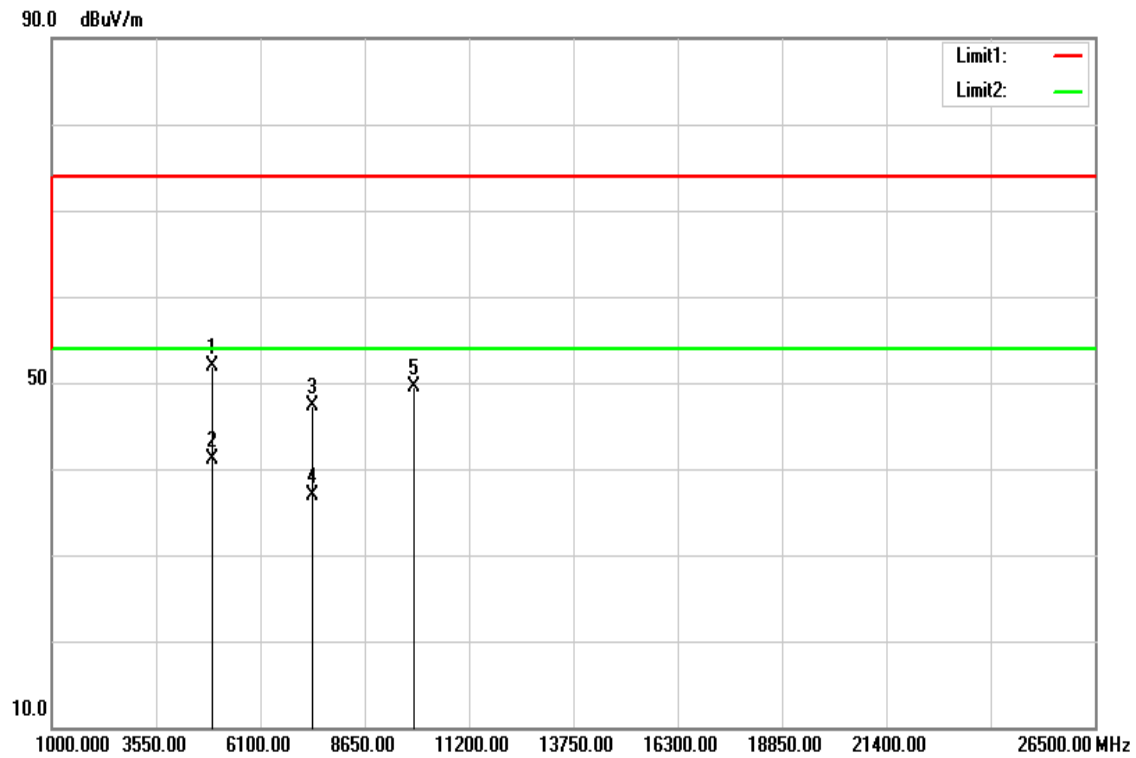

Operation Mode: TX / IEEE 802.11n HT 20 MHz mode / CH High **Test Date:** July 29, 2016

Temperature: 27°C

Tested by: Dennis Li

Humidity: 53% RH

Polarity: Ver. / Hor.

Frequency (MHz)	Reading (dBuV)	Correction Factor (dB/m)	Result (dBuV/m)	Limit (dBuV/m)	Margin (dB)	Remark	Ant. Pol. (H/V)
4925.000	40.16	5.37	45.53	74.00	-28.47	peak	V
4925.000	31.16	5.37	36.53	54.00	-17.47	AVG	V
7386.000	34.89	13.17	48.06	74.00	-25.94	peak	V
7386.000	24.51	13.17	37.68	54.00	-16.32	AVG	V
9848.000	31.65	17.60	49.25	74.00	-24.75	peak	V
N/A							
4925.000	46.50	5.37	51.87	74.00	-22.13	peak	H
4925.000	35.78	5.37	41.15	54.00	-12.85	AVG	H
7386.000	34.04	13.17	47.21	74.00	-26.79	peak	H
7386.000	23.68	13.17	36.85	54.00	-17.15	AVG	H
9848.000	31.87	17.60	49.47	74.00	-24.53	peak	H
N/A							

Remark:

1. Measuring frequencies from 1 GHz to the 10th harmonic of highest fundamental frequency.
2. Radiated emissions measured in frequency above 1000MHz were made with an instrument using peak/average detector mode.
3. Average test would be performed if the peak result were greater than the average limit or as required by the applicant.
4. Data of measurement within this frequency range shown " --- " in the table above means the reading of emissions are attenuated more than 20dB below the permissible limits or the field strength is too small to be measured.
5. Measurements above show only up to 6 maximum emissions noted, or would be lesser, with " N/A " remark, if no specific emissions from the EUT are recorded (ie: margin>20dB from the applicable limit) and considered that's already beyond the background noise floor.
6. Margin (dB) = Remark result (dBuV/m) – Average limit (dBuV/m).

TX / IEEE 802.11n HT 40 MHz mode / CH Low

Polarity: Vertical

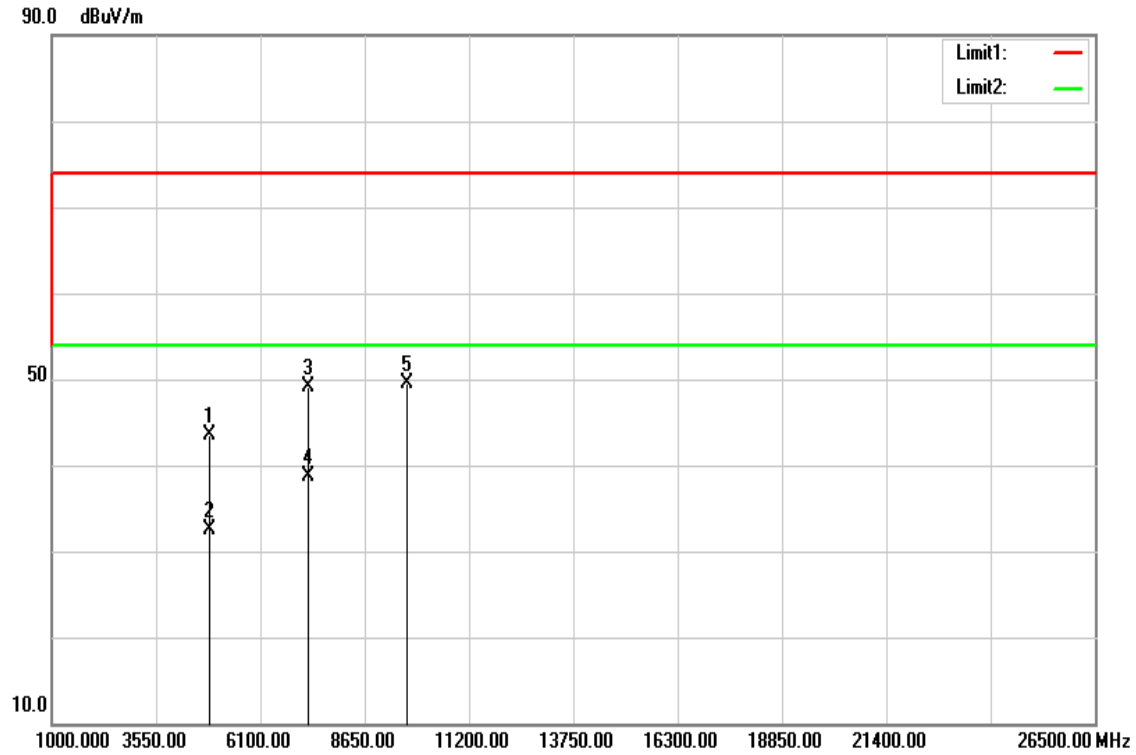

Polarity: Horizontal

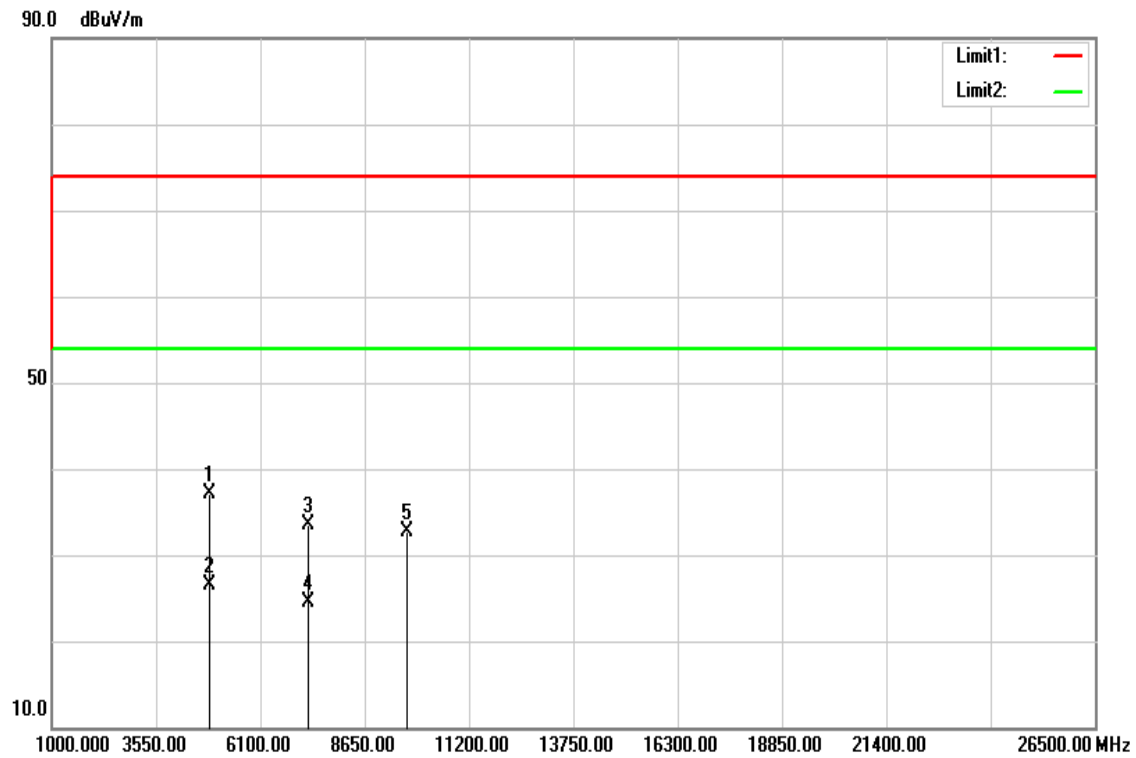

Operation Mode: TX / IEEE 802.11n HT 40 MHz mode / CH Low **Test Date:** July 29, 2016

Temperature: 27°C

Tested by: Dennis Li

Humidity: 53% RH

Polarity: Ver. / Hor.

Frequency (MHz)	Reading (dBuV)	Correction Factor (dB/m)	Result (dBuV/m)	Limit (dBuV/m)	Margin (dB)	Remark	Ant. Pol. (H/V)
4844.000	38.34	5.15	43.49	74.00	-30.51	peak	V
4844.000	27.42	5.15	32.57	54.00	-21.43	AVG	V
7266.000	36.33	12.80	49.13	74.00	-24.87	peak	V
7266.000	25.87	12.80	38.67	54.00	-15.33	AVG	V
9688.000	31.97	17.60	49.57	74.00	-24.43	peak	V
N/A							
4844.000	32.03	5.15	37.18	74.00	-36.82	peak	H
4844.000	21.32	5.15	26.47	54.00	-27.53	AVG	H
7266.000	20.79	12.80	33.59	74.00	-40.41	peak	H
7266.000	11.64	12.80	24.44	54.00	-29.56	AVG	H
9688.000	15.10	17.60	32.70	74.00	-41.30	peak	H
N/A							

Remark:

1. Measuring frequencies from 1 GHz to the 10th harmonic of highest fundamental frequency.
2. Radiated emissions measured in frequency above 1000MHz were made with an instrument using peak/average detector mode.
3. Average test would be performed if the peak result were greater than the average limit or as required by the applicant.
4. Data of measurement within this frequency range shown " --- " in the table above means the reading of emissions are attenuated more than 20dB below the permissible limits or the field strength is too small to be measured.
5. Measurements above show only up to 6 maximum emissions noted, or would be lesser, with " N/A " remark, if no specific emissions from the EUT are recorded (ie: margin>20dB from the applicable limit) and considered that's already beyond the background noise floor.
6. Margin (dB) = Remark result (dBuV/m) – Average limit (dBuV/m).

TX / IEEE 802.11n HT 40 MHz mode / CH Mid

Polarity: Vertical

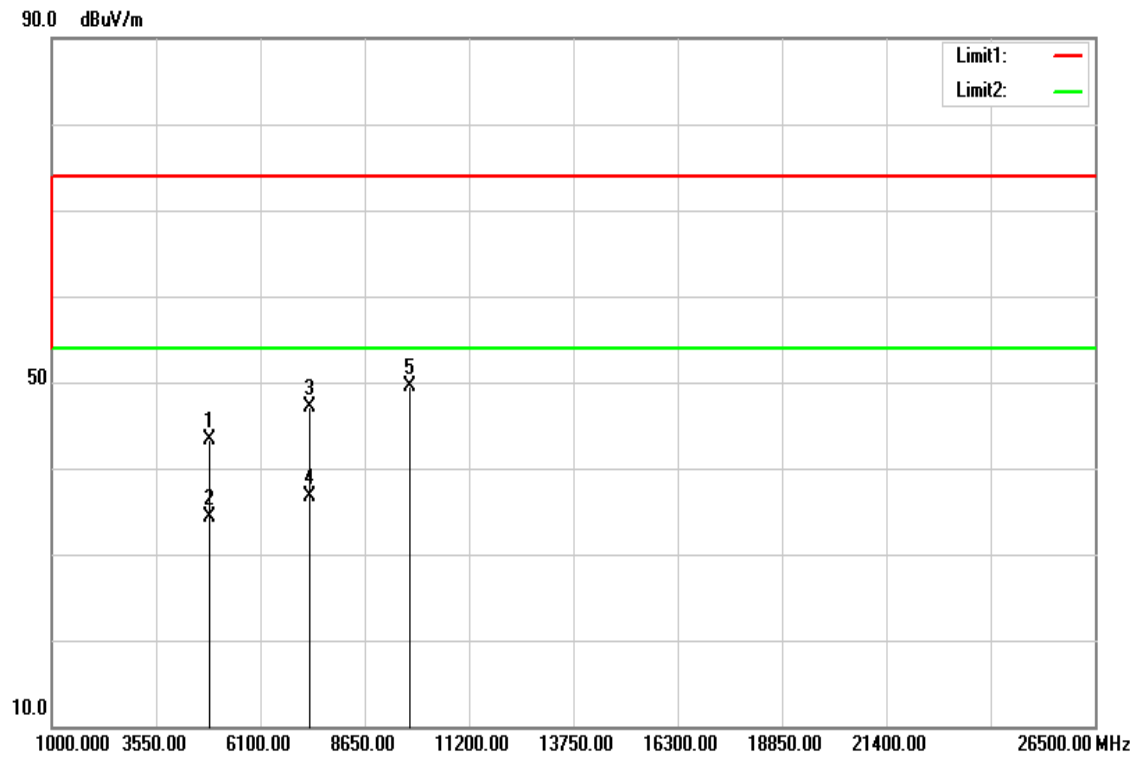

Polarity: Horizontal

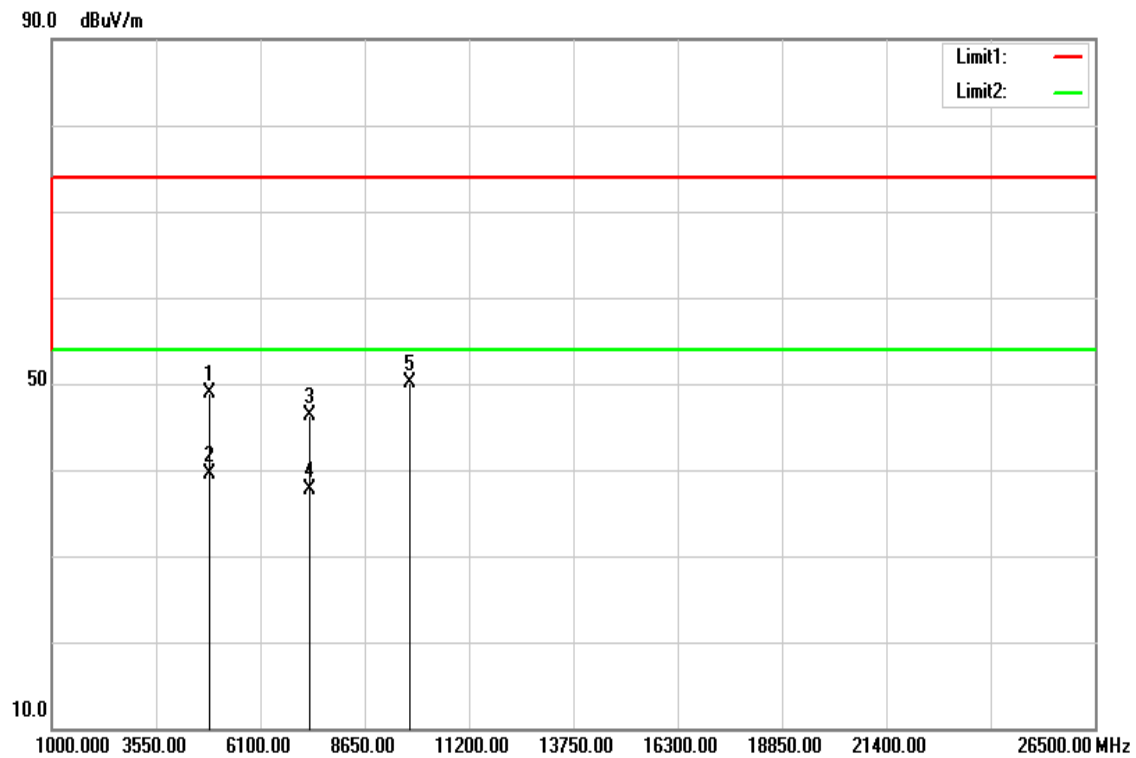

Operation Mode: TX / IEEE 802.11n HT 40 MHz mode / CH Mid **Test Date:** July 29, 2016

Temperature: 27°C

Tested by: Dennis Li

Humidity: 53% RH

Polarity: Ver. / Hor.

Frequency (MHz)	Reading (dBuV)	Correction Factor (dB/m)	Result (dBuV/m)	Limit (dBuV/m)	Margin (dB)	Remark	Ant. Pol. (H/V)
4874.000	37.98	5.23	43.21	74.00	-30.79	peak	V
4874.000	29.12	5.23	34.35	54.00	-19.65	AVG	V
7311.000	34.08	12.94	47.02	74.00	-26.98	peak	V
7311.000	23.74	12.94	36.68	54.00	-17.32	AVG	V
9748.000	31.99	17.60	49.59	74.00	-24.41	peak	V
N/A							
4869.000	43.63	5.22	48.85	74.00	-25.15	peak	H
4869.000	34.36	5.22	39.58	54.00	-14.42	AVG	H
7311.000	33.39	12.94	46.33	74.00	-27.67	peak	H
7311.000	24.74	12.94	37.68	54.00	-16.32	AVG	H
9748.000	32.43	17.60	50.03	74.00	-23.97	peak	H
N/A							

Remark:

1. Measuring frequencies from 1 GHz to the 10th harmonic of highest fundamental frequency.
2. Radiated emissions measured in frequency above 1000MHz were made with an instrument using peak/average detector mode.
3. Average test would be performed if the peak result were greater than the average limit or as required by the applicant.
4. Data of measurement within this frequency range shown " --- " in the table above means the reading of emissions are attenuated more than 20dB below the permissible limits or the field strength is too small to be measured.
5. Measurements above show only up to 6 maximum emissions noted, or would be lesser, with " N/A " remark, if no specific emissions from the EUT are recorded (ie: margin>20dB from the applicable limit) and considered that's already beyond the background noise floor.
6. Margin (dB) = Remark result (dBuV/m) – Average limit (dBuV/m).

TX / IEEE 802.11n HT 40 MHz mode / CH High

Polarity: Vertical

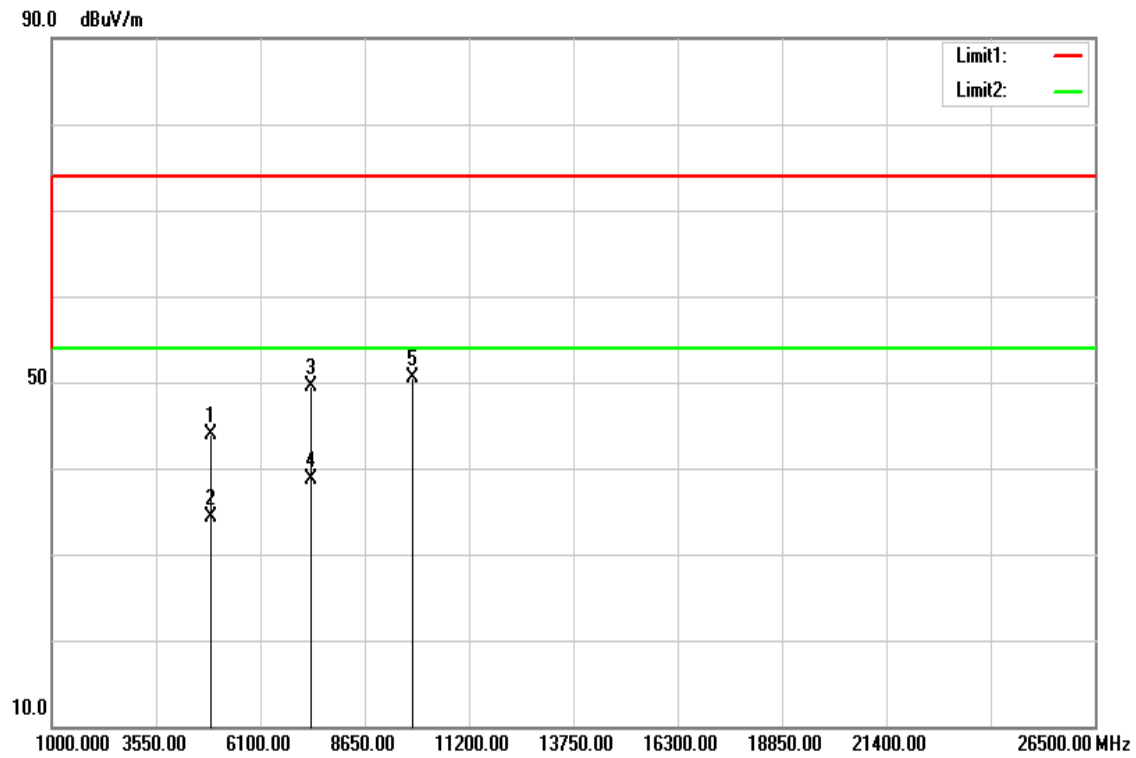

Polarity: Horizontal

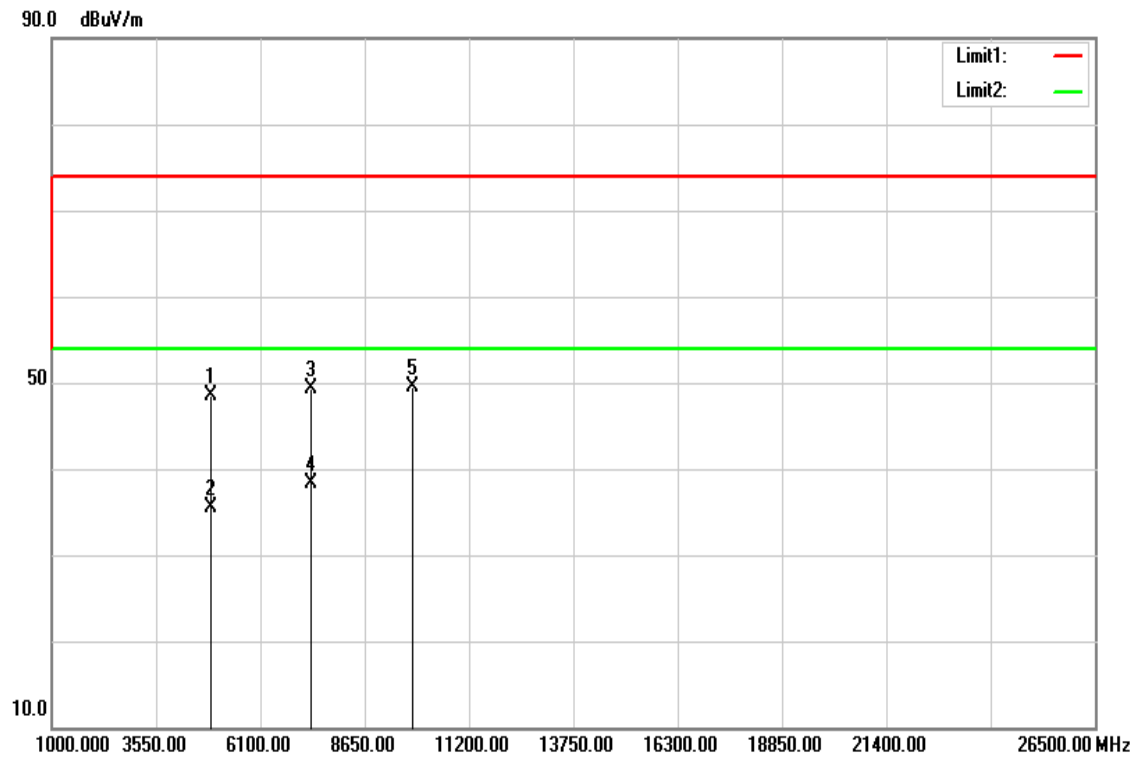

Operation Mode: TX / IEEE 802.11n HT 40 MHz mode / CH High **Test Date:** July 29, 2016

Temperature: 27°C

Tested by: Dennis Li

Humidity: 53% RH

Polarity: Ver. / Hor.

Frequency (MHz)	Reading (dBuV)	Correction Factor (dB/m)	Result (dBuV/m)	Limit (dBuV/m)	Margin (dB)	Remark	Ant. Pol. (H/V)
4904.000	38.63	5.31	43.94	74.00	-30.06	peak	V
4904.000	28.90	5.31	34.21	54.00	-19.79	AVG	V
7356.000	36.39	13.08	49.47	74.00	-24.53	peak	V
7356.000	25.60	13.08	38.68	54.00	-15.32	AVG	V
9808.000	32.84	17.60	50.44	74.00	-23.56	peak	V
N/A							
4904.000	43.20	5.31	48.51	74.00	-25.49	peak	H
4904.000	30.14	5.31	35.45	54.00	-18.55	AVG	H
7356.000	36.28	13.08	49.36	74.00	-24.64	peak	H
7356.000	25.30	13.08	38.38	54.00	-15.62	AVG	H
9808.000	31.82	17.60	49.42	74.00	-24.58	peak	H
N/A							

Remark:

1. Measuring frequencies from 1 GHz to the 10th harmonic of highest fundamental frequency.
2. Radiated emissions measured in frequency above 1000MHz were made with an instrument using peak/average detector mode.
3. Average test would be performed if the peak result were greater than the average limit or as required by the applicant.
4. Data of measurement within this frequency range shown " --- " in the table above means the reading of emissions are attenuated more than 20dB below the permissible limits or the field strength is too small to be measured.
5. Measurements above show only up to 6 maximum emissions noted, or would be lesser, with " N/A " remark, if no specific emissions from the EUT are recorded (ie: margin>20dB from the applicable limit) and considered that's already beyond the background noise floor.
6. Margin (dB) = Remark result (dBuV/m) – Average limit (dBuV/m).

7.8 POWERLINE CONDUCTED EMISSIONS

LIMIT

According to §15.207(a) & RSS-Gen §7.2.4, except as shown in paragraphs (b) and (c) of this section, for an intentional radiator that is designed to be connected to the public utility (AC) power line, the radio frequency voltage that is conducted back onto the AC power line on any frequency or frequencies within the band 150 kHz to 30 MHz shall not exceed the limits in the following table, as measured using a 50 μ H/50 ohms line impedance stabilization network (LISN). Compliance with the provisions of this paragraph shall be based on the measurement of the radio frequency voltage between each power line and ground at the power terminal. The lower limit applies at the boundary between the frequency ranges.

Frequency Range (MHz)	Limits (dB μ V)	
	Quasi-peak	Average
0.15 to 0.50	66 to 56*	56 to 46*
0.50 to 5	56	46
5 to 30	60	50

* Decreases with the logarithm of the frequency.

Test Configuration

See test photographs attached in Appendix II for the actual connections between EUT and support equipment.

TEST PROCEDURE

1. The EUT was placed on a table, which is 0.8m above ground plane.
2. Maximum procedure was performed on the six highest emissions to ensure EUT compliance.
3. Repeat above procedures until all frequency measured were complete.

Test Plots

Conducted emissions (Line 1)

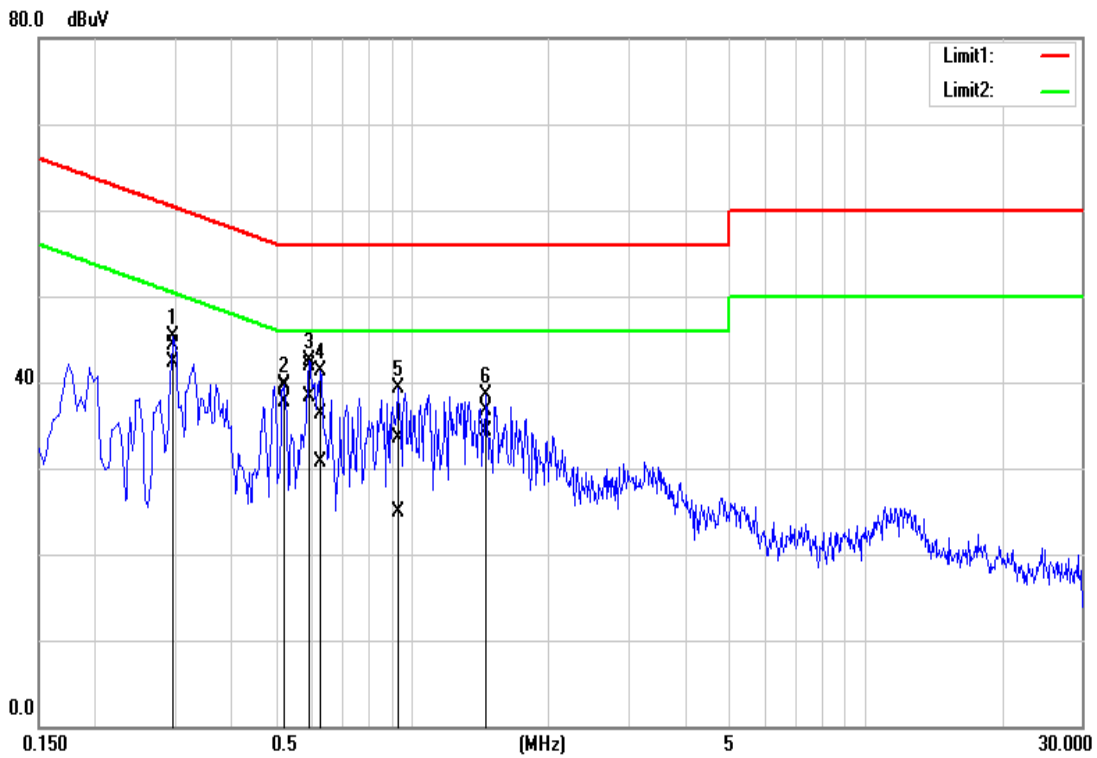

Conducted emissions (Line 2)

