



SPORTON International Inc.

No. 52, Hwa Ya 1st Rd., Hwa Ya Technology Park, Kwei-Shan Hsiang, Tao Yuan Hsien, Taiwan, R.O.C.
Ph: 886-3-327-3456 / FAX: 886-3-327-0973 / www.sporton.com.tw

FCC RADIO TEST REPORT

Applicant's company	Lite-On Technology Corp.
Applicant Address	Bldg. C, 90, Chien 1 Road, Chung Ho, New Taipei City 23585, Taiwan, R.O.C
FCC ID	PPQ-WCBN4506R
Manufacturer's company	LITE-ON TECHNOLOGY (Changzhou) CO., LTD
Manufacturer Address	A9 Building, No.88 Yanghu Road, Wujin Hi-Tech Industrial Development Zone, Changzhou City, Jiangsu Province 213100 China

Product Name	WLAN + BT Combo Module
Brand Name	LITE-ON
Model Name	WCBN4506R
Test Rule	47 CFR FCC Part 15 Subpart C § 15.247
Test Freq. Range	2402 ~ 2480MHz
Received Date	Sep. 08, 2015
Final Test Date	Oct. 08, 2015
Submission Type	Original Equipment

Statement

Test result included is only for the Bluetooth LE of the product.

The test result in this report refers exclusively to the presented test model / sample.

Without written approval of SPORTON International Inc., the test report shall not be reproduced except in full.

The measurements and test results shown in this test report were made in accordance with the procedures and found in compliance with the limit given in **ANSI C63.10-2013, 47 CFR FCC Part 15 Subpart C** and **KDB558074 D01 v03r03**.

The test equipment used to perform the test is calibrated and traceable to NML/ROC.



Table of Contents

1. VERIFICATION OF COMPLIANCE	1
2. SUMMARY OF THE TEST RESULT	2
3. GENERAL INFORMATION	3
3.1. Product Details.....	3
3.2. Table for Filed Antenna.....	3
3.3. Table for Carrier Frequencies	7
3.4. Table for Test Modes	7
3.5. Table for Testing Locations.....	8
3.6. Table for Multiple List.....	8
3.7. Table for Supporting Units	9
3.8. Table for Parameters of Test Software Setting	10
3.9. EUT Operation during Test	10
3.10. Duty Cycle	10
3.11. Test Configurations	11
4. TEST RESULT	14
4.1. AC Power Line Conducted Emissions Measurement.....	14
4.2. Maximum Conducted Output Power Measurement.....	18
4.3. Power Spectral Density Measurement	20
4.4. 6dB Spectrum Bandwidth Measurement	24
4.5. Radiated Emissions Measurement	28
4.6. Emissions Measurement	38
4.7. Antenna Requirements	44
5. LIST OF MEASURING EQUIPMENTS	45
6. MEASUREMENT UNCERTAINTY.....	46
APPENDIX A. TEST PHOTOS	A1 ~ A8
APPENDIX B. RADIATED EMISSION CO-LOCATION REPORT.....	B1 ~ B5



History of This Test Report

REPORT NO.	VERSION	DESCRIPTION	ISSUED DATE
FR590501AD	Rev. 01	Initial issue of report	Nov. 04, 2015

1. VERIFICATION OF COMPLIANCE

Product Name : WLAN + BT Combo Module
Brand Name : LITE-ON
Model No. : WCBN4506R
Applicant : Life-On Technology Corp.
Test Rule Part(s) : 47 CFR FCC Part 15 Subpart C § 15.247

Sporton International as requested by the applicant to evaluate the EMC performance of the product sample received on Sep. 08, 2015 would like to declare that the tested sample has been evaluated and found to be in compliance with the tested rule parts. The data recorded as well as the test configuration specified is true and accurate for showing the sample's EMC nature.

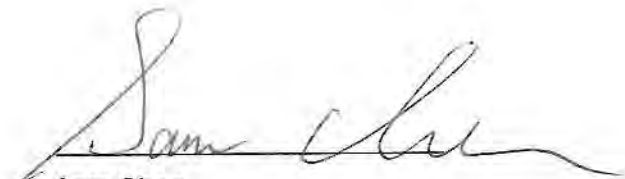

Sam Chen

SPORTON INTERNATIONAL INC.

2. SUMMARY OF THE TEST RESULT

Applied Standard: 47 CFR FCC Part 15 Subpart C				
Part	Rule Section	Description of Test	Result	Under Limit
4.1	15.207	AC Power Line Conducted Emissions	Complies	15.35 dB
4.2	15.247(b)(3)	Maximum Conducted Output Power	Complies	21.50 dB
4.3	15.247(e)	Power Spectral Density	Complies	20.60 dB
4.4	15.247(a)(2)	6dB Spectrum Bandwidth	Complies	-
4.5	15.247(d)	Radiated Emissions	Complies	3.23 dB
4.6	15.247(d)	Band Edge Emissions	Complies	5.14 dB
4.7	15.203	Antenna Requirements	Complies	-

3. GENERAL INFORMATION

3.1. Product Details

Items	Description
Power Type	From host system
Modulation	DSSS
Data Rate (Mbps)	GFSK: 1
Frequency Range	2402 ~ 2480MHz
Channel Number	40 (37 hopping + 3 advertising channel)
Channel Band Width (99%)	1.38 MHz
Maximum Conducted Output Power	8.50 dBm
Carrier Frequencies	Please refer to section 3.4
Antenna	Please refer to section 3.3
Accessories	N/A

3.2. Table for Filed Antenna

Set	Ant.	Brand Holder	Model Name	Antenna Type	Connector	Remark
1	1	SONY corporation	WCBN4506R	PIFA Antenna	N/A	Only for EUT 2 WiFi use
	2	SONY corporation	WCBN4506R	PIFA Antenna	N/A	Only for EUT 2 WiFi use
2	3	SONY corporation	WCBN4506R	Dipole Antenna	I-PEX	For EUT 1 WiFi and BT use For EUT 2 BT use
	4	SONY corporation	WCBN4506R	Dipole Antenna	I-PEX	For EUT 1 WiFi and BT use For EUT 2 BT use
3	5	Waka manufacturing Co.,Ltd.	01S1072-00	Dipole Antenna	I-PEX	Only for EUT 1 WiFi use
	6	Waka manufacturing Co.,Ltd.	01S1072-00	Dipole Antenna	I-PEX	Only for EUT 1 WiFi use

Set	Ant.	Gain (dBi)						Cable Length [mm]
		BT-2.4GHz	WIFI-2.4GHz	WIFI-5GHz Band 1	WIFI-5GHz Band 2	WIFI-5GHz Band 3	WIFI-5GHz Band 4	
1	1	-	0.71	1.81	1.81	2.14	1.8	N/A
	2	-	0.13	0.72	1.78	2.12	1.67	N/A
2 Note1	3	1.61	1.61	2.13	2.13	2.31	2.68	100-910mm Note2
	4	1.61	1.61	2.13	2.13	2.31	2.68	100-910mm Note2
3 Note1	5	-	2.06	2.41	2.87	1.89	2.7	90mm
	6	-	2.06	2.41	2.87	1.89	2.7	90mm

3. The EUT has three sets of antennas and there are two antennas for each set.

For 2.4GHz function:

For IEEE 802.11b/g/n mode (2TX/2RX)

Chain 1 and Chain 2 can be used as transmitting/receiving antenna.

Chain 1 and Chain 2 could transmit/receive simultaneously.

For 5GHz function:

For IEEE 802.11a/n mode (2TX/2RX)

Chain 1 and Chain 2 can be used as transmitting/receiving antenna.

Chain 1 and Chain 2 could transmit/receive simultaneously.

For Bluetooth function: (1TX/1RX)

Only Chain 3 can be used as transmitting/receiving antenna.

For EUT 1:

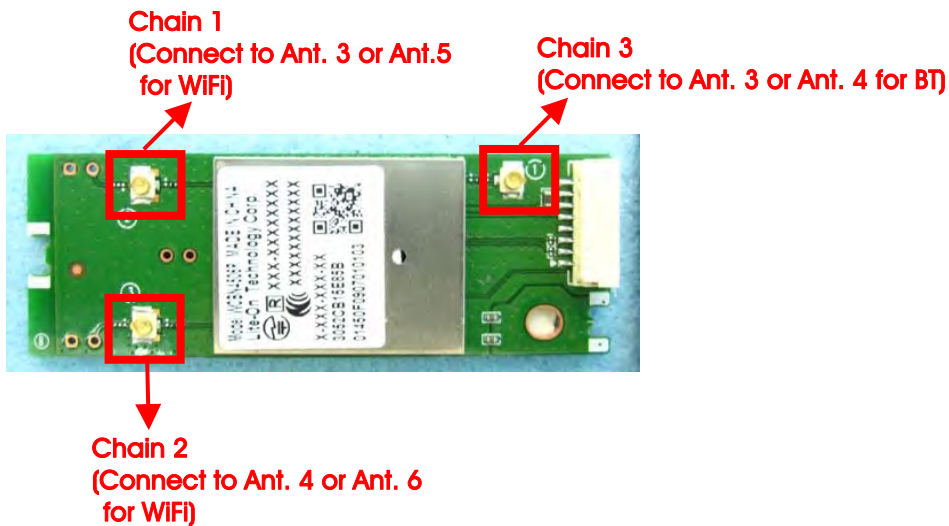

For EUT 2:

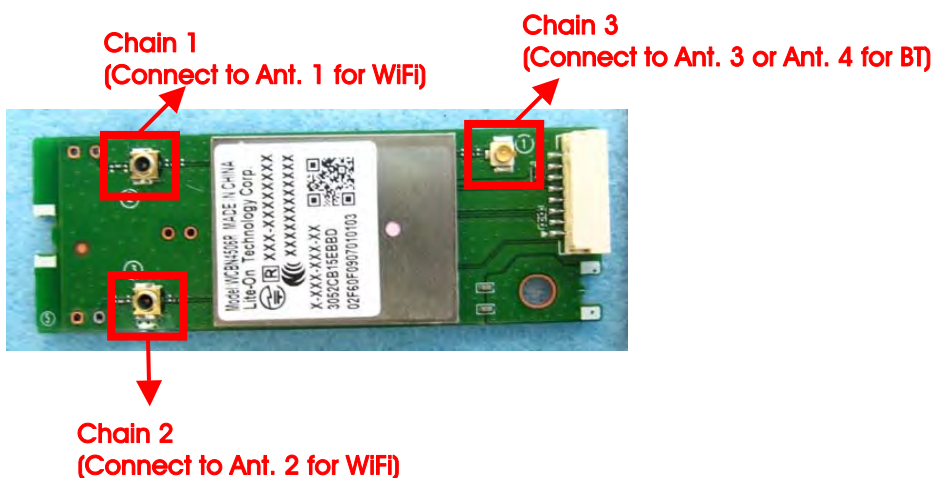

3.3. Table for Carrier Frequencies

Frequency Band	Channel No.	Frequency	Channel No.	Frequency
2400~2483.5MHz	0	2402 MHz	20	2442 MHz
	1	2404 MHz	:	:
	2	2406 MHz	37	2476 MHz
	:	:	38	2478 MHz
	18	2438 MHz	39	2480 MHz
	19	2440 MHz	-	-

3.4. Table for Test Modes

Preliminary tests were performed in different data rate to find the worst radiated emission. The data rate shown in the table below is the worst-case rate with respect to the specific test item. Investigation has been done on all the possible configurations for searching the worst cases. The following table is a list of the test modes shown in this test report.

Test Items	Mode	Data Rate	Channel	Chain
AC Power Line Conducted Emissions	Normal Link	-	-	-
Maximum Conducted Output Power Power Spectral Density	GFSK	1 Mbps	0/20/39	3
6dB Spectrum Bandwidth	GFSK	1 Mbps	0/20/39	3
Radiated Emissions 9kHz~1GHz	Normal Link	-	-	-
Radiated Emissions 1GHz~10 th Harmonic	GFSK	1 Mbps	0/20/39	3
Band Edge Emissions	GFSK	1 Mbps	0/20/39	3

The following test modes were performed for all tests:

For Conducted Emission test:

Mode 1. Place EUT 1 in Z axis + Set 3 antenna (2.4GHz function) + Set 2 antenna (BT function)

Mode 2. Place EUT 1 in Z axis + Set 3 antenna (5GHz function) + Set 2 antenna (BT function)

Mode 3. Place EUT 2 in Z axis + Set 1 antenna (2.4GHz function) + Set 2 antenna (BT function)

Mode 4. Place EUT 2 in Z axis + Set 1 antenna (5GHz function) + Set 2 antenna (BT function)

Mode 2 is the worst case, so it was selected to record in this test report.

For Radiated Emission test below 1GHz:

Mode 1. Place EUT 1 in Z axis + Set 3 antenna (2.4GHz function) + Set 2 antenna (BT function)

Mode 2. Place EUT 1 in Z axis + Set 3 antenna (5GHz function) + Set 2 antenna (BT function)

Mode 3. Place EUT 2 in Z axis + Set 1 antenna (2.4GHz function) + Set 2 antenna (BT function)

Mode 4. Place EUT 2 in Z axis + Set 1 antenna (5GHz function) + Set 2 antenna (BT function)

Mode 1 is the worst case, so it was selected to record in this test report.

For Radiated Emission test above 1GHz:

The EUT 2 was performed at X axis, Y axis and Z axis position. The worst case was found at Z axis, so it was selected to perform test and its test result was written in the report.

Mode 1. Place EUT 2 in Z axis + Set 2 antenna

For Radiated Emission Co-location test:

Place EUT 1 in Z axis generated the worst test result for Radiated emission below 1GHz test, thus the measurement for Radiated emission co-location test will follow this same test configuration.

Mode 1. Place EUT 1 in Z axis + Set 3 antenna (2.4GHz function) + Set 2 antenna (BT function)

Mode 2. Place EUT 1 in Z axis + Set 3 antenna (5GHz function) + Set 2 antenna (BT function).

For Co-location MPE and Radiated Emission Co-location Test:

The EUT could be applied with 2.4GHz WLAN function + BT function and 5GHz WLAN function + BT function; therefore Co-location Maximum Permissible Exposure (Please refer to FA590501) and Radiated Emission Co-location (please refer to Appendix B) tests are added for simultaneously transmit between 2.4GHz WLAN function + BT function and 5GHz WLAN function + BT function.

3.5. Table for Testing Locations

Test Site Location				
Address:	No.8, Lane 724, Bo-ai St., Jhubei City, Hsinchu County 302, Taiwan, R.O.C.			
TEL:	886-3-656-9065			
FAX:	886-3-656-9085			
Test Site No.	Site Category	Location	FCC Reg. No.	IC File No.
03CH01-CB	SAC	Hsin Chu	262045	IC 4086D
CO01-CB	Conduction	Hsin Chu	262045	IC 4086D
TH01-CB	OVEN Room	Hsin Chu	-	-

Open Area Test Site (OATS); Semi Anechoic Chamber (SAC).

3.6. Table for Multiple List

The brand/model names in the following table are all refer to the identical product.

EUT	Model Name	WiFi Antenna (Internal)	WiFi Antenna (External)	BT Antenna (External)
1	WCBN4506R	X	V	V
2		V	X	V

Note: EUT 1 and EUT 2's BT function are the same, so only EUT 2 was tested and recorded in this report.

3.7. Table for Supporting Units

For Test Site No: 03CH01-CB

For Radiated Emission test below 1GHz

Support Unit	Brand	Model	FCC ID
NB	DELL	E6300	DoC
CBT Bluetooth tester	Anritsu	MT8852B	N/A
Mouse	HP	FM100	DoC
Earphone	SHYARO CHI	MIC-04	N/A
Wireless ac AP	Netgear	R6300V2	PY313200227
Fixtute	Liteon	TB006	N/A

For Radiated Emission test above 1GHz

Support Unit	Brand	Model	FCC ID
NB	DELL	E6300	DoC
Fixtute	Liteon	TB006	N/A

For Test Site No: CO01-CB

Support Unit	Brand	Model	FCC ID
AP Router	Planex	GW-AP54SGX	KA220030603014-1
NB	DELL	E6430	DoC
CBT Bluetooth tester	Anritsu	MT8852B	N/A
Fixture	Liteon	TB006	N/A
Mouse	HP	FM100	DoC
Earphone	e-Power	S90W	N/A

For Test Site No: TH01-CB

Support Unit	Brand	Model	FCC ID
NB	DELL	E6300	DoC
Fixture	Liteon	TB006	N/A

3.8. Table for Parameters of Test Software Setting

During testing, Channel and Power Controlling Software provided by the customer was used to control the operating channel as well as the output power level. The RF output power selection is for the setting of RF output power expected by the customer and is going to be fixed on the firmware of the final end product.

Power Parameters:

Test Software Version	WCN_Combol_Tool		
Frequency	2402 MHz	2442 MHz	2480 MHz
Power Parameters	Default	Default	Default

3.9. EUT Operation during Test

The EUT was programmed to be in continuously transmitting mode.

3.10. Duty Cycle

Mode	On Time (ms)	On+Off Time (ms)	Duty Cycle (%)	Duty Factor (dB)	1/T Minimum VBW (kHz)
GFSK	0.372	0.621	59.90%	2.23	2.69

3.11. Test Configurations

3.11.1. AC Power Line Conduction Emissions Test Configuration

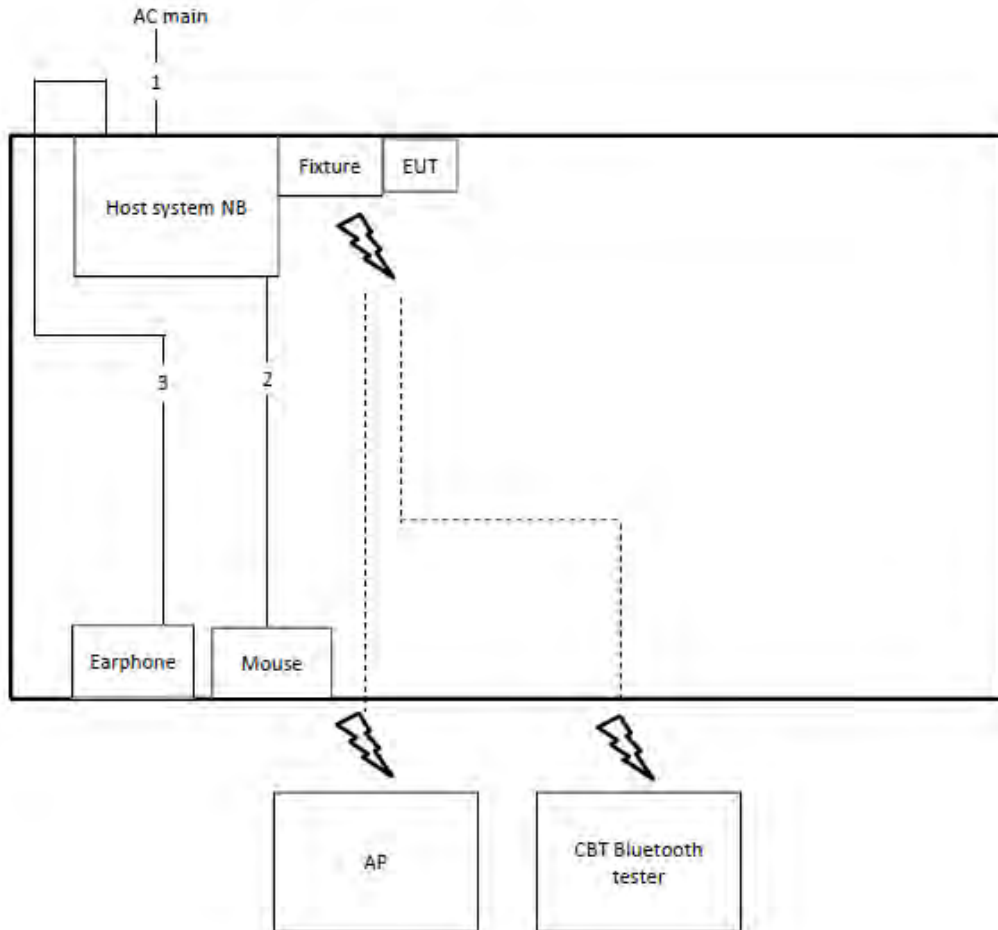

Item	Connection	Shielded	Length
1	Power cable	No	2.6m
2	USB cable	No	1.8m
3	Audio cable	No	1.1m

3.11.2. Radiation Emissions Test Configuration

Test Configuration: 30MHz~1GHz

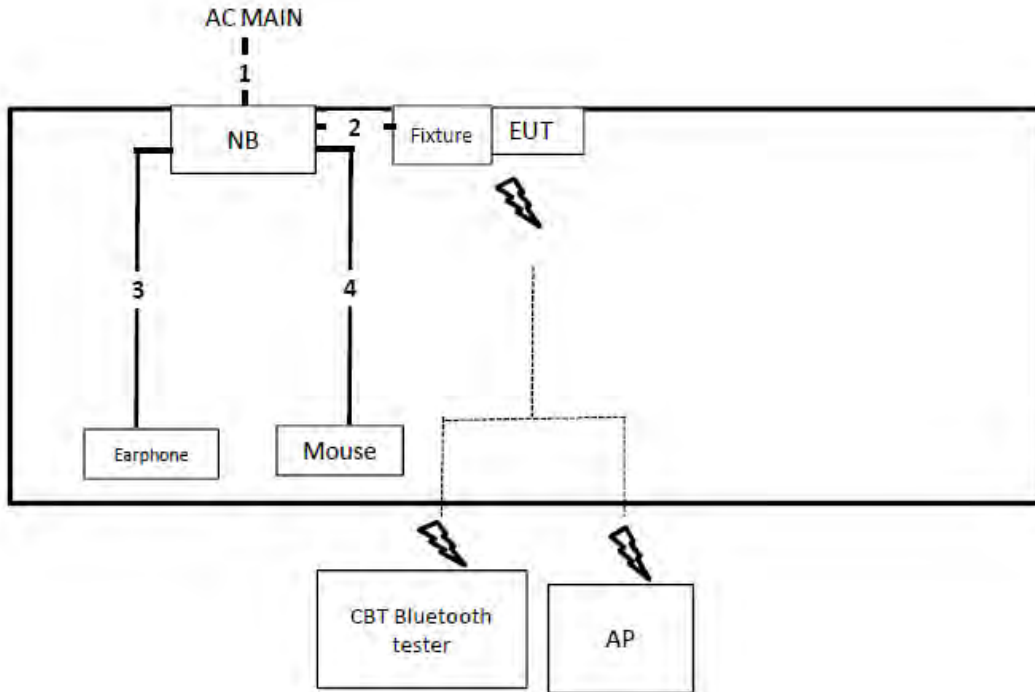

Item	Connection	Shielded	Length
1	Power cable	No	2.6m
2	USB cable	No	0.1m
3	Audio cable	No	1.1m
4	USB cable	No	1.8m

Test Configuration: above 1GHz

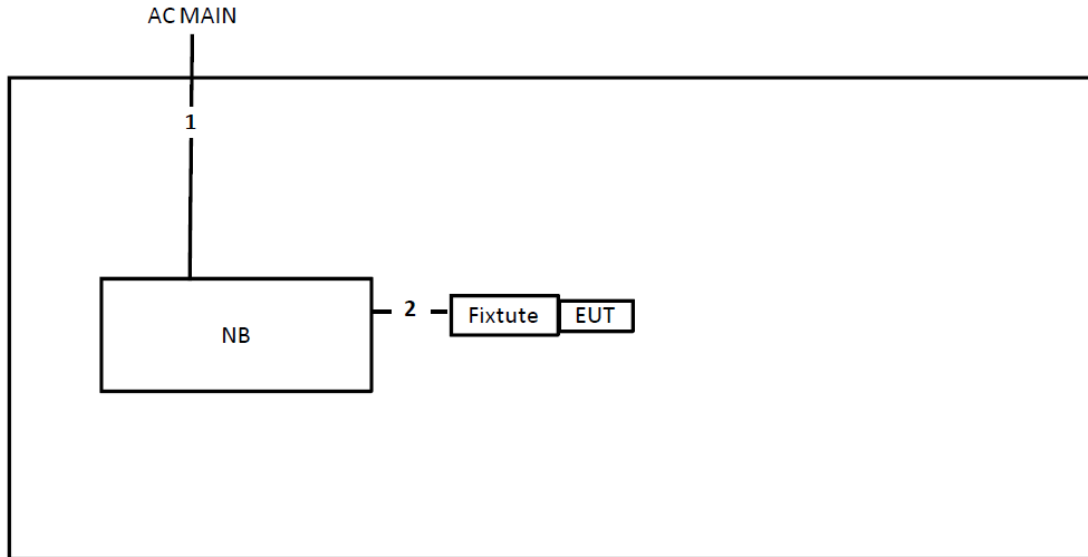

Item	Connection	Shielded	Length
1	Power cable	No	2.6m
2	USB cable	No	0.1m

4. TEST RESULT

4.1. AC Power Line Conducted Emissions Measurement

4.1.1. Limit

For this product which is designed to be connected to the AC power line, the radio frequency voltage that is conducted back onto the AC power line on any frequency or frequencies within the band 150 kHz to 30 MHz shall not exceed below limits table.

Frequency (MHz)	QP Limit (dBuV)	AV Limit (dBuV)
0.15~0.5	66~56	56~46
0.5~5	56	46
5~30	60	50

4.1.2. Measuring Instruments and Setting

Please refer to section 5 of equipments list in this report. The following table is the setting of the receiver.

Receiver Parameters	Setting
Attenuation	10 dB
Start Frequency	0.15 MHz
Stop Frequency	30 MHz
IF Bandwidth	9 kHz

4.1.3. Test Procedures

1. Configure the EUT according to ANSI C63.10. The EUT or host of EUT has to be placed 0.4 meter far from the conducting wall of the shielding room and at least 80 centimeters from any other grounded conducting surface.
2. Connect EUT or host of EUT to the power mains through a line impedance stabilization network (LISN).
3. All the support units are connected to the other LISNs. The LISN should provide 50uH/50ohms coupling impedance.
4. The frequency range from 150 kHz to 30 MHz was searched.
5. Set the test-receiver system to Peak Detect Function and Specified Bandwidth with Maximum Hold Mode.
6. The measurement has to be done between each power line and ground at the power terminal.

4.1.4. Test Setup Layout

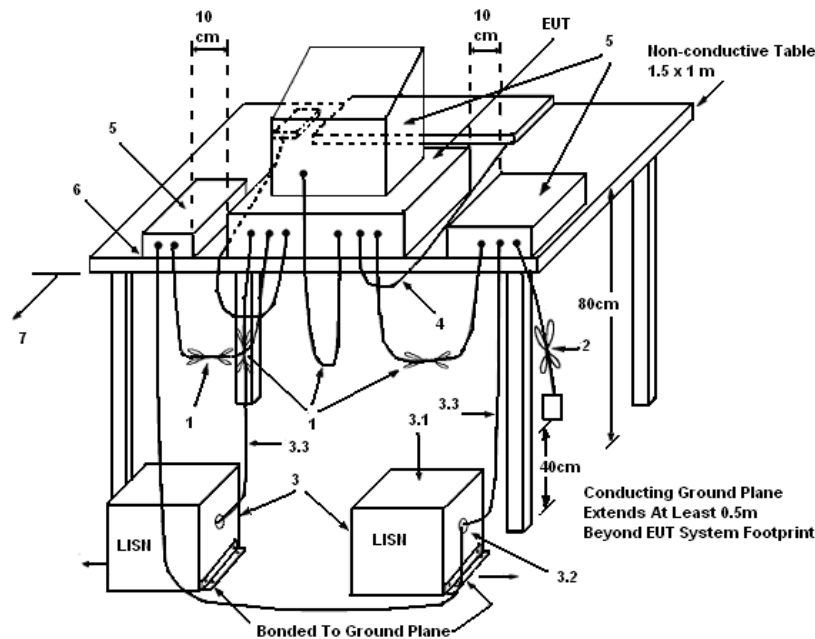

LEGEND:

- (1) Interconnecting cables that hang closer than 40 cm to the ground plane shall be folded back and forth in the center forming a bundle 30 to 40 cm long.
- (2) I/O cables that are not connected to a peripheral shall be bundled in the center. The end of the cable may be terminated, if required, using the correct terminating impedance. The overall length shall not exceed 1 m.
- (3) EUT connected to one LISN. Unused LISN measuring port connectors shall be terminated in 50 Ω. LISN can be placed on top of, or immediately beneath, reference ground plane.
 - (3.1) All other equipment powered from additional LISN(s).
 - (3.2) Multiple outlet strip can be used for multiple power cords of non-EUT equipment.
 - (3.3) LISN at least 80 cm from nearest part of EUT chassis.
- (4) Cables of hand-operated devices, such as keyboards, mice, etc., shall be placed as for normal use.
- (5) Non-EUT components of EUT system being tested.
- (6) Rear of EUT, including peripherals, shall all be aligned and flush with rear of tabletop.
- (7) Rear of tabletop shall be 40 cm removed from a vertical conducting plane that is bonded to the ground plane.

4.1.5. Test Deviation

There is no deviation with the original standard.

4.1.6. EUT Operation during Test

The EUT was placed on the test table and programmed in normal function.

4.1.7. Results of AC Power Line Conducted Emissions Measurement

Temperature	24°C	Humidity	59%
Test Engineer	Ryo Fan	Phase	Line
Configuration	Normal Link	Test Mode	Mode 2

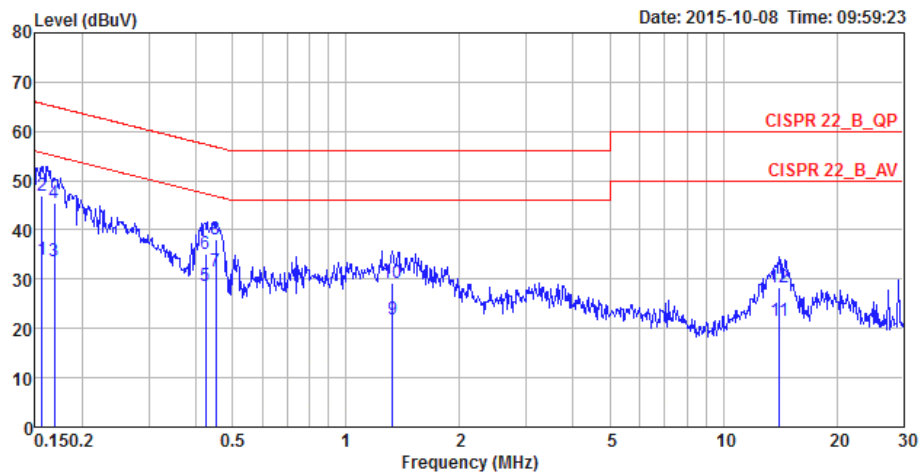

	Freq	Level	Over Limit	Limit Line	Read Level	LISN Factor	Cable Loss	Pol/Phase	Remark
	MHz	dBuV	dB	dBuV	dBuV	dB	dB		
1	0.1565	34.08	-21.57	55.65	24.13	9.93	0.02	LINE	Average
2	0.1565	47.08	-18.57	65.65	37.13	9.93	0.02	LINE	QP
3	0.1685	33.53	-21.50	55.03	23.58	9.93	0.02	LINE	Average
4	0.1685	45.56	-19.47	65.03	35.61	9.93	0.02	LINE	QP
5	0.4237	28.66	-18.71	47.37	18.69	9.93	0.04	LINE	Average
6	0.4237	35.04	-22.33	57.37	25.07	9.93	0.04	LINE	QP
7	0.4516	31.50	-15.35	46.85	21.53	9.93	0.04	LINE	Average
8	0.4516	38.14	-18.71	56.85	28.17	9.93	0.04	LINE	QP
9	1.3308	21.99	-24.01	46.00	11.97	9.97	0.05	LINE	Average
10	1.3308	29.12	-26.88	56.00	19.10	9.97	0.05	LINE	QP
11	14.0629	21.68	-28.32	50.00	11.12	10.31	0.25	LINE	Average
12	14.0629	28.21	-31.79	60.00	17.65	10.31	0.25	LINE	QP

Temperature	24°C	Humidity	59%
Test Engineer	Ryo Fan	Phase	Neutral
Configuration	Normal Link	Test Mode	Mode 2

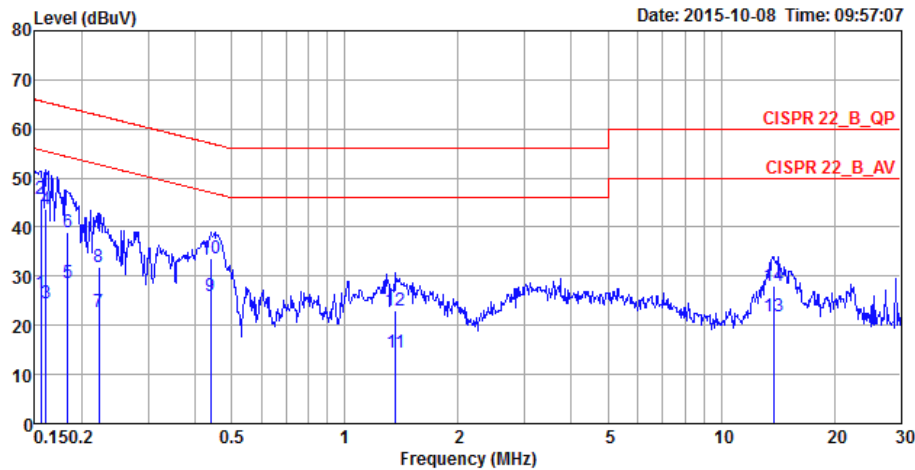

	Freq	Level	Over Limit	Limit Line	Read Level	LISN Factor	Cable Loss	Pol/Phase	Remark
	MHz	dBuV	dB	dBuV	dBuV	dB	dB		
1	0.1557	26.49	-29.20	55.69	16.69	9.78	0.02	NEUTRAL	Average
2	0.1557	45.69	-20.00	65.69	35.89	9.78	0.02	NEUTRAL	QP
3	0.1607	24.53	-30.90	55.43	14.73	9.78	0.02	NEUTRAL	Average
4	0.1607	43.63	-21.80	65.43	33.83	9.78	0.02	NEUTRAL	QP
5	0.1835	28.75	-25.58	54.33	18.94	9.79	0.02	NEUTRAL	Average
6	0.1835	38.90	-25.43	64.33	29.09	9.79	0.02	NEUTRAL	QP
7	0.2220	22.82	-29.92	52.74	13.00	9.79	0.03	NEUTRAL	Average
8	0.2220	31.80	-30.94	62.74	21.98	9.79	0.03	NEUTRAL	QP
9	0.4397	25.85	-21.22	47.07	16.02	9.79	0.04	NEUTRAL	Average
10	0.4397	33.58	-23.49	57.07	23.75	9.79	0.04	NEUTRAL	QP
11	1.3665	14.45	-31.55	46.00	4.58	9.82	0.05	NEUTRAL	Average
12	1.3665	22.93	-33.07	56.00	13.06	9.82	0.05	NEUTRAL	QP
13	13.7680	21.77	-28.23	50.00	11.43	10.09	0.25	NEUTRAL	Average
14	13.7680	28.01	-31.99	60.00	17.67	10.09	0.25	NEUTRAL	QP

Note:

Level = Read Level + LISN Factor + Cable Loss.

4.2. Maximum Conducted Output Power Measurement

4.2.1. Limit

The limit for output power is 30dBm.

4.2.2. Measuring Instruments and Setting

Please refer to section 5 of equipments list in this report. The following table is the setting of the power meter.

Power Meter Parameter	Setting
Bandwidth	50MHz bandwidth is greater than the EUT emission bandwidth
Detector	Average

4.2.3. Test Procedures

1. Test procedures refer KDB558074 D01 v03r03 section 9.2.3.2.
2. This procedure provides an alternative for determining the RMS output power using a broadband RF average power meter with a thermocouple detector.

4.2.4. Test Setup Layout

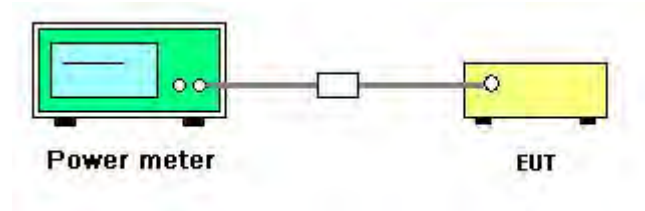

4.2.5. Test Deviation

There is no deviation with the original standard.

4.2.6. EUT Operation during Test

The EUT was programmed to be in continuously transmitting mode.

4.2.7. Test Result of Maximum Conducted Output Power

Temperature	24°C	Humidity	65%
Test Engineer	Clemens Fang & Andy Tsai & Lucas Huang	Configurations	GFSK
Test Date	Sep. 15, 2015		

Channel	Frequency	Conducted Power (dBm)	Max. Limit (dBm)	Result
0	2402 MHz	8.50	30.00	Complies
20	2442 MHz	8.43	30.00	Complies
39	2480 MHz	8.49	30.00	Complies

4.3. Power Spectral Density Measurement

4.3.1. Limit

For digitally modulated systems, the power spectral density conducted from the intentional radiator to the antenna shall not be greater than 8 dBm in any 3 kHz band during any time interval of continuous transmission.

4.3.2. Measuring Instruments and Setting

Please refer to section 5 of equipments list in this report. The following table is the setting of the spectrum analyzer.

Spectrum Parameter	Setting
Attenuation	Auto
Span Frequency	5-30 % greater than the DTS channel bandwidth.
RBW	$3 \text{ kHz} \leq \text{RBW} \leq 100\text{kHz}$
VBW	$\geq 3 \times \text{RBW}$
Detector	Peak
Trace	Max Hold
Sweep Time	Auto couple

4.3.3. Test Procedures

1. Test was performed in accordance with KDB558074 D01 v03r03 for Performing Compliance Measurements on Digital Transmission Systems (DTS) - section 10.2 Method PKPSD (peak PSD).
2. Use this procedure when the maximum conducted output power in the fundamental emission is used to demonstrate compliance. The EUT must be configured to transmit continuously at full power over the measurement duration.
3. Ensure that the number of measurement points in the sweep $\geq 2 \times \text{span}/\text{RBW}$ (use of a greater number of measurement points than this minimum requirement is recommended).
4. Use the peak marker function to determine the maximum level in any 3 kHz band segment within the fundamental EBW.
5. The resulting PSD level must be $\leq 8 \text{ dBm}$.

4.3.4. Test Setup Layout

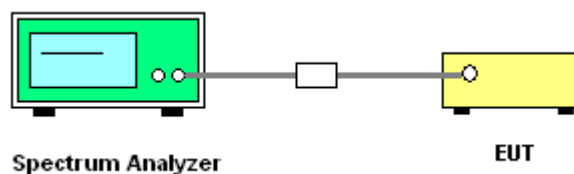

4.3.5. Test Deviation

There is no deviation with the original standard.

4.3.6. EUT Operation during Test

The EUT was programmed to be in continuously transmitting mode.

4.3.7. Test Result of Power Spectral Density

Temperature	24°C	Humidity	65%
Test Engineer	Clemens Fang & Andy Tsai & Lucas Huang	Configurations	GFSK

Channel	Frequency	Power Density (dBm/3kHz)	Power Density Limit (dBm/3kHz)	Result
		Chain 3		
0	2402 MHz	-12.62	8.00	Complies
20	2442 MHz	-12.60	8.00	Complies
39	2480 MHz	-12.89	8.00	Complies

Note: All the test values were listed in the report.

For plots, only the channel with worse result was shown.

Power Density Plot on Configuration Bluetooth / 2442 MHz

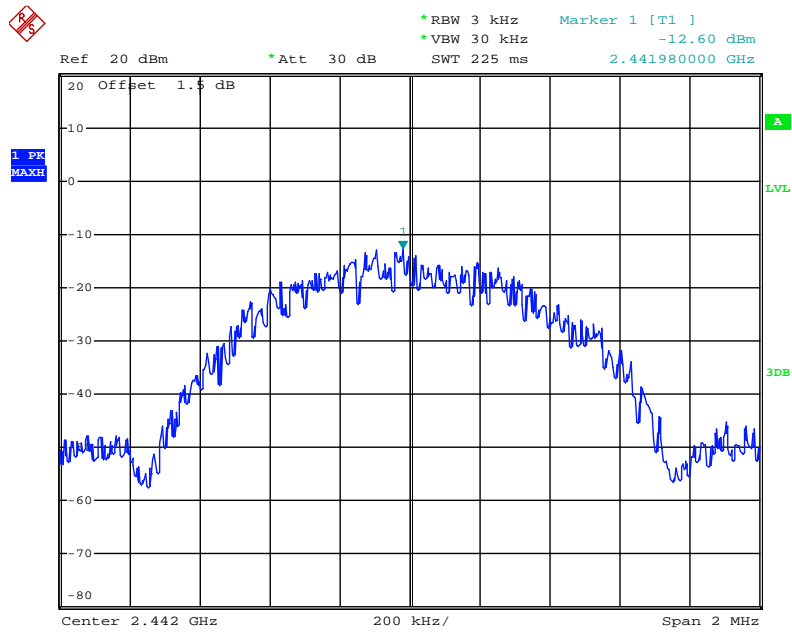

Date: 15.SEP.2015 00:39:02

4.4. 6dB Spectrum Bandwidth Measurement

4.4.1. Limit

For digital modulation systems, the minimum 6dB bandwidth shall be at least 500 kHz.

4.4.2. Measuring Instruments and Setting

Please refer to section 5 of equipments list in this report. The following table is the setting of the spectrum analyzer.

6dB Spectrum Bandwidth	
Spectrum Parameters	Setting
Attenuation	Auto
Span Frequency	> 6dB Bandwidth
RBW	100kHz
VBW	$\geq 3 \times \text{RBW}$
Detector	Peak
Trace	Max Hold
Sweep Time	Auto
99% Occupied Bandwidth	
Spectrum Parameters	Setting
Span	1.5 times to 5.0 times the OBW
RBW	1 % to 5 % of the OBW
VBW	$\geq 3 \times \text{RBW}$
Detector	Peak
Trace	Max Hold

4.4.3. Test Procedures

For Radiated 6dB Bandwidth Measurement:

1. The transmitter was radiated to the spectrum analyzer in peak hold mode.
2. Test was performed in accordance with KDB558074 D01 v03r03 for Performing Compliance Measurements on Digital Transmission Systems (DTS) - section 8.0 DTS bandwidth=> 8.1 Option 1.
3. Measured the spectrum width with power higher than 6dB below carrier.

4.4.4. Test Setup Layout

For Radiated 6dB Bandwidth Measurement:

This test setup layout is the same as that shown in section 4.5.4.

4.4.5. Test Deviation

There is no deviation with the original standard.

4.4.6. EUT Operation during Test

The EUT was programmed to be in continuously transmitting mode.

4.4.7. Test Result of 6dB Spectrum Bandwidth

Temperature	24°C	Humidity	65%
Test Engineer	Clemens Fang & Andy Tsai & Lucas Huang	Configurations	GFSK

Channel	Frequency	6dB Bandwidth (MHz)	99% Occupied Bandwidth (MHz)	Min. Limit (kHz)	Test Result
0	2402 MHz	0.70	1.38	500	Complies
20	2442 MHz	0.70	1.37	500	Complies
39	2480 MHz	0.70	1.38	500	Complies

Note: All the test values were listed in the report.

For plots, only the channel with worse result was shown.

6 dB Bandwidth Plot on Configuration Bluetooth / 2402 MHz

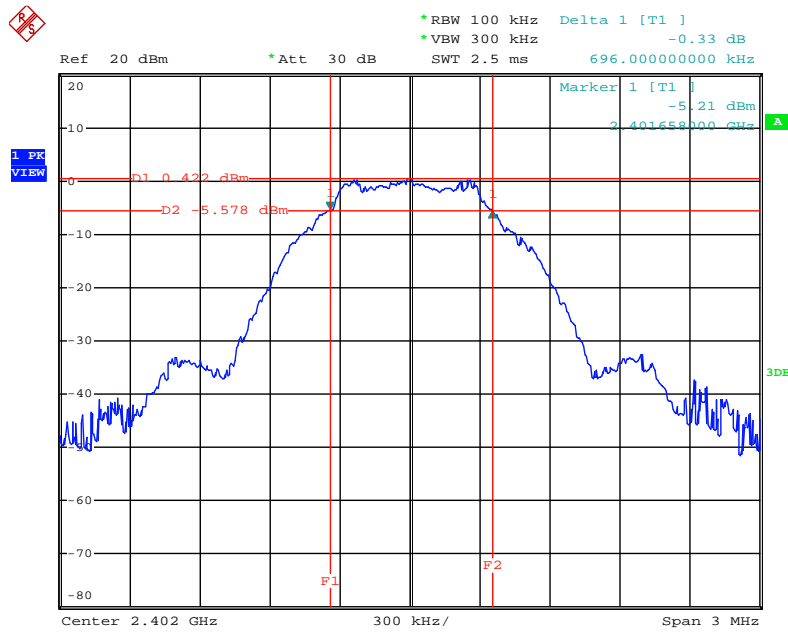

Date: 15.SEP.2015 00:45:38

99% Occupied Bandwidth Plot on Configuration Bluetooth / 2402 MHz

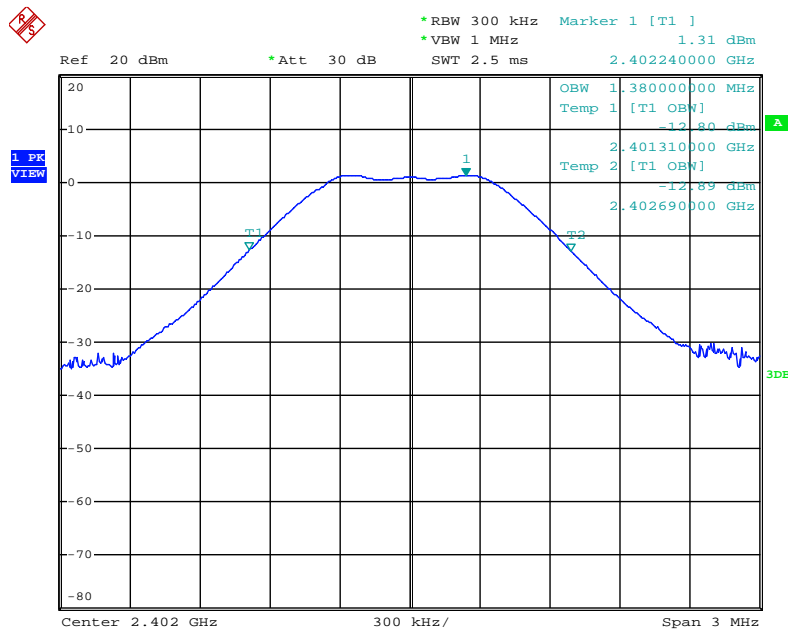

Date: 15.SEP.2015 00:50:10

4.5. Radiated Emissions Measurement

4.5.1. Limit

30dBc in any 100 kHz bandwidth outside the operating frequency band. In case the emission fall within the restricted band specified on 15.205(a), then the 15.209(a) limit in the table below has to be followed.

Frequencies (MHz)	Field Strength (micovolts/meter)	Measurement Distance (meters)
0.009~0.490	2400/F(kHz)	300
0.490~1.705	24000/F(kHz)	30
1.705~30.0	30	30
30~88	100	3
88~216	150	3
216~960	200	3
Above 960	500	3

4.5.2. Measuring Instruments and Setting

Please refer to section 5 of equipments list in this report. The following table is the setting of spectrum analyzer and receiver.

Spectrum Parameter	Setting
Attenuation	Auto
Start Frequency	1000 MHz
Stop Frequency	10th carrier harmonic
RBW / VBW (Emission in restricted band)	1 MHz / 3MHz for Peak, 1 MHz / 1/T for Average
RBW / VBW (Emission in non-restricted band)	100kHz / 300kHz for peak

Receiver Parameter	Setting
Attenuation	Auto
Start ~ Stop Frequency	9kHz~150kHz / RBW 200Hz for QP
Start ~ Stop Frequency	150kHz~30MHz / RBW 9kHz for QP
Start ~ Stop Frequency	30MHz~1000MHz / RBW 120kHz for QP

4.5.3. Test Procedures

1. Configure the EUT according to ANSI C63.10. The EUT was placed on the top of the turntable 1.5 meter above ground. The phase center of the receiving antenna mounted on the top of a height-variable antenna tower was placed 1m & 3m far away from the turntable.
2. Power on the EUT and all the supporting units. The turntable was rotated by 360 degrees to determine the position of the highest radiation.
3. The height of the broadband receiving antenna was varied between one meter and four meters above ground to find the maximum emissions field strength of both horizontal and vertical polarization.
4. For each suspected emissions, the antenna tower was scan (from 1 M to 4 M) and then the turntable was rotated (from 0 degree to 360 degrees) to find the maximum reading.
5. Set the test-receiver system to Peak or CISPR quasi-peak Detect Function with specified bandwidth under Maximum Hold Mode.
6. For emissions above 1GHz, use 1MHz VBW and 3MHz RBW for peak reading. Then 1MHz RBW and 1/T VBW for average reading in spectrum analyzer.
7. If the emissions level of the EUT in peak mode was 3 dB lower than the average limit specified, then testing will be stopped and peak values of EUT will be reported, otherwise, the emissions which do not have 3 dB margin will be repeated one by one using the quasi-peak method for below 1GHz.
8. For testing above 1GHz, the emissions level of the EUT in peak mode was lower than average limit (that means the emissions level in peak mode also complies with the limit in average mode), then testing will be stopped and peak values of EUT will be reported, otherwise, the emissions will be measured in average mode again and reported.
9. In case the emission is lower than 30MHz, loop antenna has to be used for measurement and the recorded data should be QP measured by receiver. High – Low scan is not required in this case.

4.5.4. Test Setup Layout

For Radiated Emissions: 9kHz ~30MHz

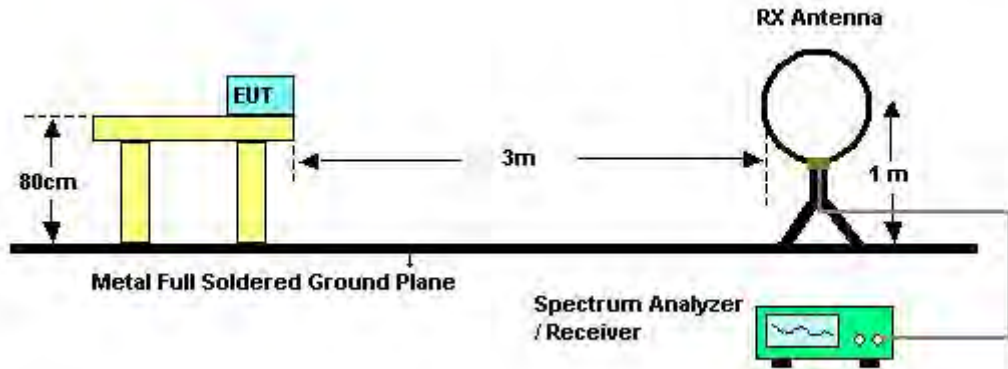

For Radiated Emissions: 30MHz~1GHz

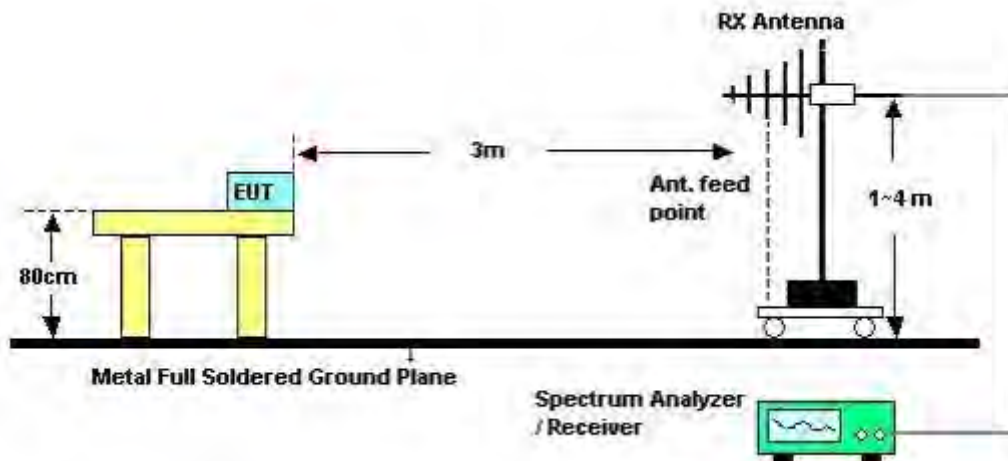

For Radiated Emissions: Above 1GHz

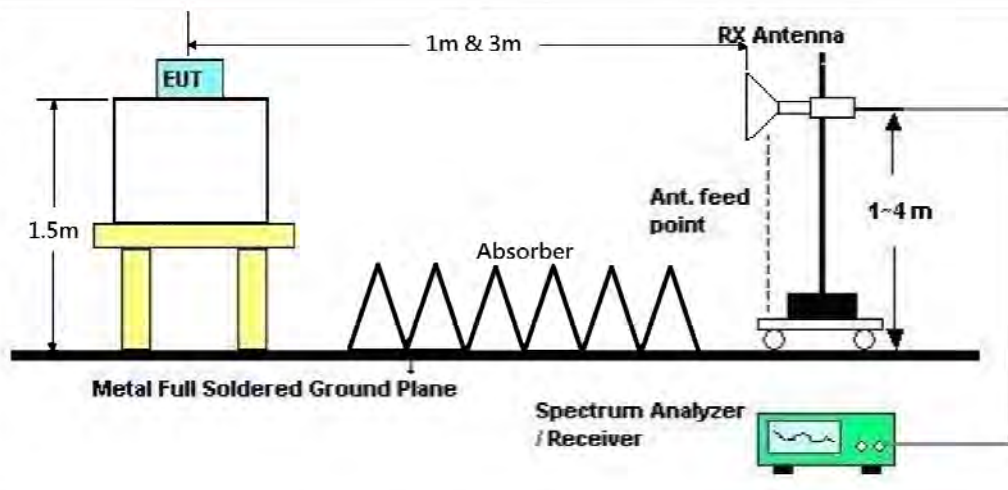

4.5.5. Test Deviation

There is no deviation with the original standard.

4.5.6. EUT Operation during Test

The EUT was programmed to be in continuously transmitting mode.

4.5.7. Results of Radiated Emissions (9kHz~30MHz)

Temperature	25°C	Humidity	69%
Test Engineer	Paul Chen & Peter Wu	Configurations	Normal Link
Test Date	Sep. 16, 2015	Test Mode	Mode 1

Freq. (MHz)	Level (dBuV)	Over Limit (dB)	Limit Line (dBuV)	Remark
-	-	-	-	See Note

Note:

The amplitude of spurious emissions that are attenuated by more than 20 dB below the permissible value has no need to be reported.

Distance extrapolation factor = $40 \log(\text{specific distance} / \text{test distance})$ (dB);

Limit line = specific limits (dBuV) + distance extrapolation factor.

4.5.8. Results of Radiated Emissions (30MHz~1GHz)

Temperature	25°C	Humidity	69%
Test Engineer	Paul Chen & Peter Wu	Configurations	Normal Link
Test Mode	Mode 1		

Horizontal

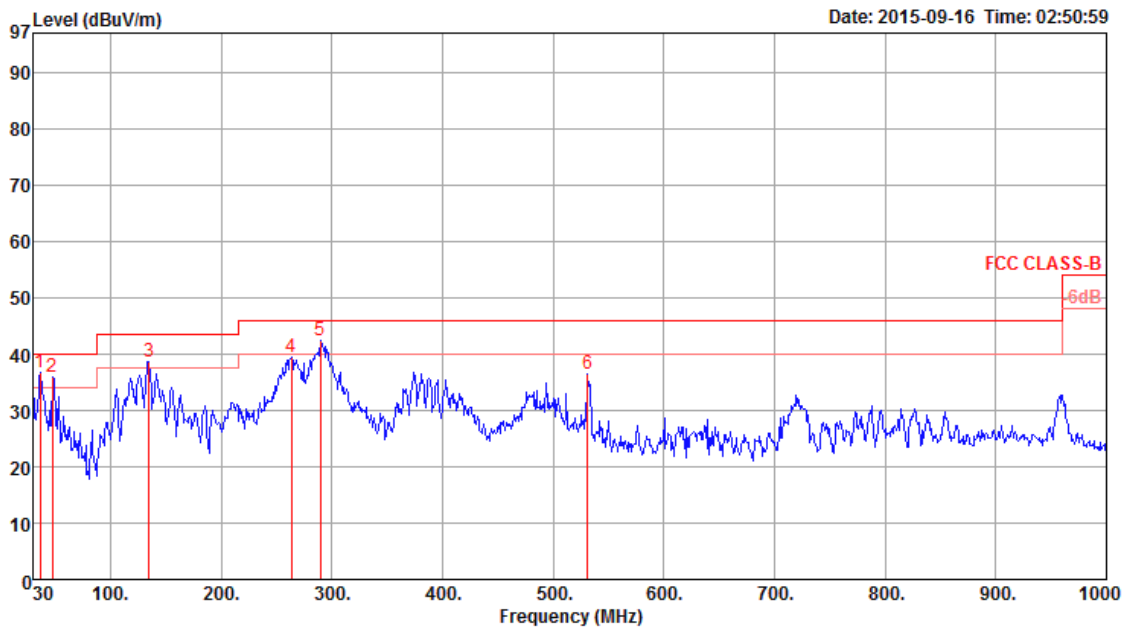

	Freq	Level	Limit	Over	Read	CableAntenna	Preamp	Remark	A/Pos	T/Pos	Pol/Phase
	MHz	dBuV/m	dBuV/m	dB	dBuV	dB	dB/m	dB	cm	deg	
1	36.79	36.77	40.00	-3.23	47.57	0.68	16.04	27.52 Peak	100	0	HORIZONTAL
2	47.46	35.92	40.00	-4.08	53.05	0.80	10.35	28.28 Peak	100	0	HORIZONTAL
3	134.76	38.61	43.50	-4.89	53.05	1.40	12.25	28.09 Peak	100	0	HORIZONTAL
4	263.77	39.49	46.00	-6.51	51.31	1.85	13.90	27.57 Peak	100	0	HORIZONTAL
5	289.96	42.30	46.00	-3.70	54.12	1.98	13.70	27.50 Peak	100	0	HORIZONTAL
6	531.49	36.56	46.00	-9.44	44.08	2.74	18.43	28.69 Peak	100	0	HORIZONTAL

Vertical

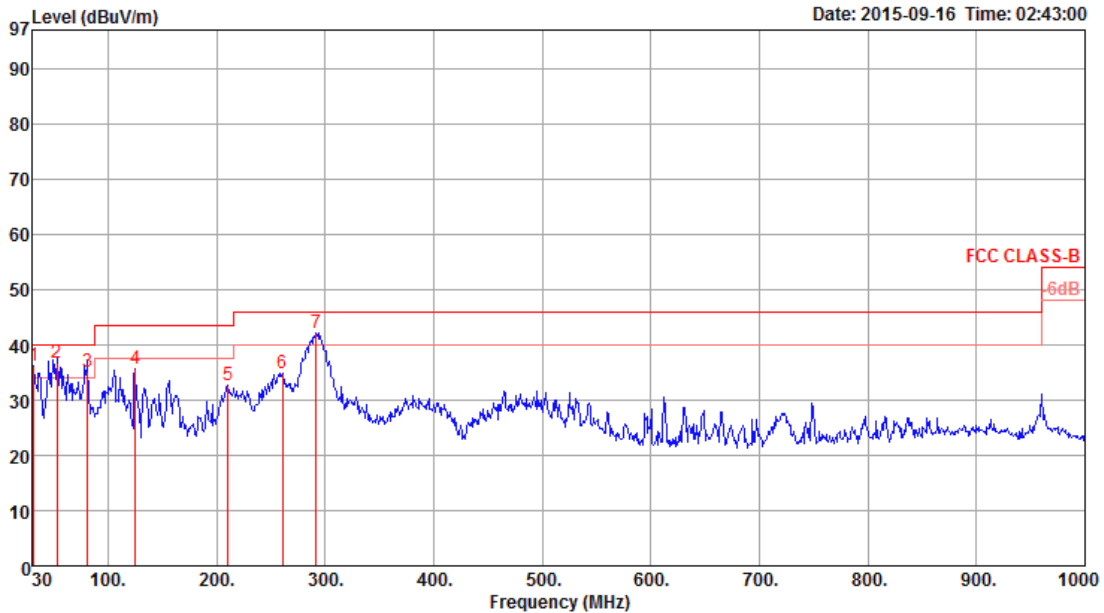

	Freq	Level	Limit	Over	Read	CableAntenna	Preamp		A/Pos	T/Pos	
	MHz	dBuV/m	dBuV/m	dB	dBuV	dB	dB/m	dB	cm	deg	Pol/Phase
1	31.94	36.16	40.00	-3.84	43.72	0.65	18.94	27.15	400	0	VERTICAL
2	53.28	36.61	40.00	-3.39	55.71	0.85	8.51	28.46	198	261	VERTICAL
3	81.41	35.15	40.00	-4.85	54.74	1.00	7.77	28.36	158	203	VERTICAL
4	125.06	35.60	43.50	-7.90	49.87	1.33	12.55	28.15	400	0	VERTICAL
5	210.42	32.59	43.50	-10.91	47.80	1.69	10.80	27.70	400	0	VERTICAL
6	260.86	34.81	46.00	-11.19	46.51	1.83	14.05	27.58	400	0	VERTICAL
7	291.90	42.15	46.00	-3.85	53.92	1.99	13.74	27.50	400	0	VERTICAL

Note:

The amplitude of spurious emissions which are attenuated by more than 20 dB below the permissible value has no need to be reported.

Emission level (dBuV/m) = 20 log Emission level (uV/m).

Corrected Reading: Antenna Factor + Cable Loss + Read Level - Preamp Factor = Level.

4.5.9. Results for Radiated Emissions (1GHz~10th Harmonic)

Temperature	25°C	Humidity	69%
Test Engineer	Paul Chen & Peter Wu	Configurations	Channel 0 / Chain 3
Test Date	Sep. 10, 2015		

Horizontal

	Freq	Level	Limit Line	Over Limit	Read Level	CableAntenna Loss	Antenna Factor	Preamp Factor	A/Pos	T/Pos	Pol/Phase	Remark
	MHz	dBuV/m	dBuV/m	dB	dBuV	dB	dB/m	dB	cm	deg		
1	4803.73	44.38	54.00	-9.62	40.88	5.37	32.52	34.39	100	144	HORIZONTAL	Average
2	4804.10	52.26	74.00	-21.74	48.76	5.37	32.52	34.39	100	144	HORIZONTAL	Peak

Vertical

	Freq	Level	Limit Line	Over Limit	Read Level	CableAntenna Loss	Antenna Factor	Preamp Factor	A/Pos	T/Pos	Pol/Phase	Remark
	MHz	dBuV/m	dBuV/m	dB	dBuV	dB	dB/m	dB	cm	deg		
1	4804.00	38.52	54.00	-15.48	35.02	5.37	32.52	34.39	100	133	VERTICAL	Average
2	4804.23	48.59	74.00	-25.41	45.09	5.37	32.52	34.39	100	133	VERTICAL	Peak

Temperature	25°C	Humidity	69%
Test Engineer	Paul Chen & Peter Wu	Configurations	Channel 20 / Chain 3
Test Date	Sep. 10, 2015		

Horizontal

	Freq	Level	Limit	Over	Read	CableAntenna	Preamp	A/Pos	T/Pos	Pol/Phase	Remark
	MHz	dBuV/m	dBuV/m	dB	dBuV	dB	dB/m	dB	cm	deg	
1	4883.73	43.06	54.00	-10.94	39.36	5.40	32.68	34.38	104	148	HORIZONTAL Average
2	4883.82	51.71	74.00	-22.29	48.01	5.40	32.68	34.38	104	148	HORIZONTAL Peak

Vertical

	Freq	Level	Limit	Over	Read	CableAntenna	Preamp	A/Pos	T/Pos	Pol/Phase	Remark
	MHz	dBuV/m	dBuV/m	dB	dBuV	dB	dB/m	dB	cm	deg	
1	4883.51	38.89	54.00	-15.11	35.19	5.40	32.68	34.38	106	154	VERTICAL Average
2	4883.74	49.02	74.00	-24.98	45.32	5.40	32.68	34.38	106	154	VERTICAL Peak

Temperature	25°C	Humidity	69%
Test Engineer	Paul Chen & Peter Wu	Configurations	Channel 39 / Chain 3
Test Date	Sep. 10, 2015		

Horizontal

	Freq	Level	Limit	Over	Read	Cable	Antenna	Preamp	A/Pos	T/Pos	Pol/Phase	Remark
	MHz	dBuV/m	dBuV/m	dB	dBuV	dB	dB/m	dB	cm	deg		
1	4959.52	38.65	54.00	-15.35	34.76	5.44	32.82	34.37	100	146	HORIZONTAL	Average
2	4960.02	49.69	74.00	-24.31	45.80	5.44	32.82	34.37	100	146	HORIZONTAL	Peak

Vertical

	Freq	Level	Limit	Over	Read	Cable	Antenna	Preamp	A/Pos	T/Pos	Pol/Phase	Remark
	MHz	dBuV/m	dBuV/m	dB	dBuV	dB	dB/m	dB	cm	deg		
1	4959.52	37.88	54.00	-16.12	33.99	5.44	32.82	34.37	100	154	VERTICAL	Average
2	4960.49	48.74	74.00	-25.26	44.85	5.44	32.82	34.37	100	154	VERTICAL	Peak

Note:

The amplitude of spurious emissions that are attenuated by more than 20dB below the permissible value has no need to be reported.

Emission level (dBuV/m) = 20 log Emission level (uV/m).

Corrected Reading: Antenna Factor + Cable Loss + Read Level - Preamp Factor = Level.

4.6. Emissions Measurement

4.6.1. Limit

30dBc in any 100 kHz bandwidth outside the operating frequency band. In case the emission fall within the restricted band specified on 15.205(a), then the 15.209(a) limit in the table below has to be followed.

Frequencies (MHz)	Field Strength (micorvolts/meter)	Measurement Distance (meters)
0.009~0.490	2400/F(kHz)	300
0.490~1.705	24000/F(kHz)	30
1.705~30.0	30	30
30~88	100	3
88~216	150	3
216~960	200	3
Above 960	500	3

4.6.2. Measuring Instruments and Setting

Please refer to section 5 of equipments list in this report. The following table is the setting of the spectrum analyzer.

Spectrum Parameter	Setting
Attenuation	Auto
Span Frequency	100 MHz
RBW / VBW (Emission in restricted band)	1MHz / 3MHz for Peak, 1MHz / 1/T for Average
RBW / VBW (30dBc in any 100 kHz bandwidth emission)	100 kHz / 300 kHz for Peak

4.6.3. Test Procedures

For Radiated band edges Measurement:

1. The test procedure is the same as section 4.5.3.

For Radiated Out of Band Emission Measurement:

1. Test was performed in accordance with KDB558074 D01 v03r03 for Performing Compliance Measurements on Digital Transmission Systems (DTS) Operating Under §15.247 section 10.1 Unwanted Emissions into Non-Restricted Frequency Bands Measurement Procedure.

4.6.4. Test Setup Layout

For Radiated band edges Measurement:

This test setup layout is the same as that shown in section 4.5.4.

For Radiated Out of Band Emission Measurement:

This test setup layout is the same as that shown in section 4.5.4.

4.6.5. Test Deviation

There is no deviation with the original standard.

4.6.6. EUT Operation during Test

The EUT was programmed to be in continuously transmitting mode.

4.6.7. Test Result of Band Edge and Fundamental Emissions

Temperature	25°C	Humidity	69%
Test Engineer	Paul Chen & Peter Wu	Configurations	Channel 0, 20, 39
Test Date	Sep. 10, 2015		

Channel 0

	Freq	Level	Limit Line	Over Limit	Read Level	Cable Loss	Antenna Factor	Preamp Factor	A/Pos	T/Pos	PoI/Phase	Remark
	MHz	dBuV/m	dBuV/m	dB	dBuV	dB	dB/m	dB	cm	deg		
1	2367.99	60.19	74.00	-13.81	28.52	3.72	27.95	0.00	250	85	VERTICAL	Peak
2	2375.23	48.17	54.00	-5.83	16.51	3.72	27.94	0.00	250	85	VERTICAL	Average
* 3	2402.00	98.20			66.55	3.74	27.91	0.00	250	85	VERTICAL	Average
* 4	2402.29	99.28			67.63	3.74	27.91	0.00	250	85	VERTICAL	Peak

Item 3, 4 are the fundamental frequency at 2402 MHz.

Channel 20

	Freq	Level	Limit Line	Over Limit	Read Level	Cable Loss	Antenna Factor	Preamp Factor	A/Pos	T/Pos	PoI/Phase	Remark
	MHz	dBuV/m	dBuV/m	dB	dBuV	dB	dB/m	dB	cm	deg		
1	2354.59	48.21	54.00	-5.79	16.55	3.70	27.96	0.00	280	188	HORIZONTAL	Average
2	2366.85	61.34	74.00	-12.66	29.68	3.71	27.95	0.00	280	188	HORIZONTAL	Peak
* 3	2442.00	104.40			72.76	3.78	27.86	0.00	280	188	HORIZONTAL	Average
* 4	2442.00	105.52			73.88	3.78	27.86	0.00	280	188	HORIZONTAL	Peak
5	2483.50	48.30	54.00	-5.70	16.66	3.82	27.82	0.00	280	188	HORIZONTAL	Average
6	2494.50	60.76	74.00	-13.24	29.13	3.82	27.81	0.00	280	188	HORIZONTAL	Peak

Item 3, 4 are the fundamental frequency at 2442 MHz.

Channel 39

	Freq	Level	Limit Line	Over Limit	Read Level	Cable Loss	Antenna Factor	Preamp Factor	A/Pos	T/Pos	PoI/Phase	Remark
	MHz	dBuV/m	dBuV/m	dB	dBuV	dB	dB/m	dB	cm	deg		
* 1	2480.00	103.95			72.31	3.82	27.82	0.00	300	188	HORIZONTAL	Average
* 2	2480.29	105.07			73.43	3.82	27.82	0.00	300	188	HORIZONTAL	Peak
3	2483.50	48.86	54.00	-5.14	17.22	3.82	27.82	0.00	300	188	HORIZONTAL	Average
4	2484.66	60.69	74.00	-13.31	29.05	3.82	27.82	0.00	300	188	HORIZONTAL	Peak

Item 1, 2 are the fundamental frequency at 2480 MHz.

Note:

Emission level (dBuV/m) = 20 log Emission level (uV/m).

Corrected Reading: Antenna Factor + Cable Loss + Read Level - Preamp Factor = Level.

For Emission not in Restricted Band
Plot on Configuration / Reference Level

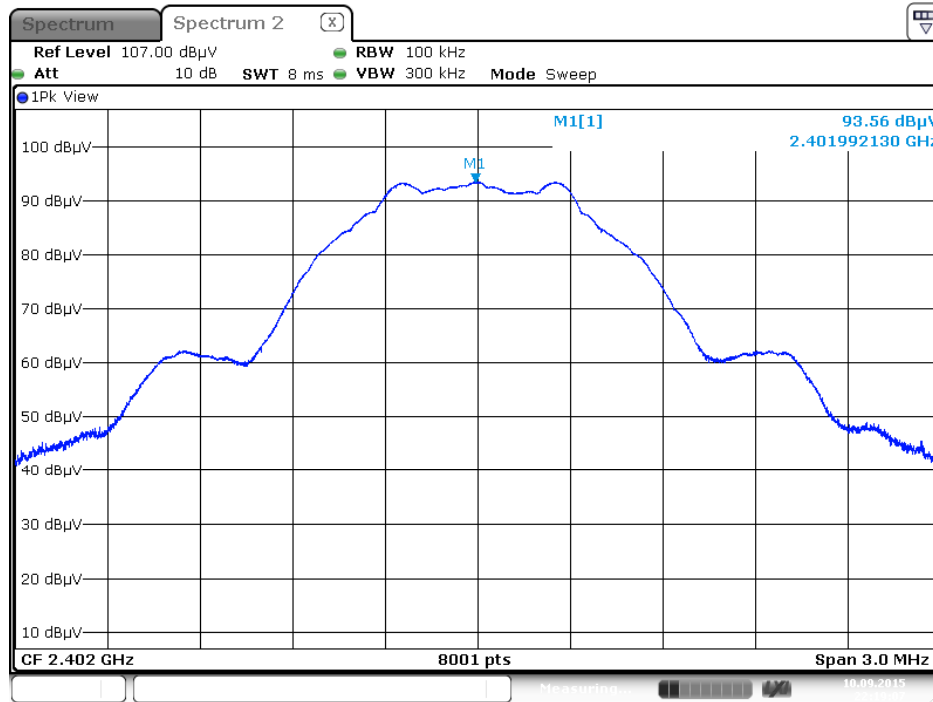

Plot on Configuration For Bluetooth 4.0 / Channel 0 / 30MHz~2400MHz (down 30dBc)

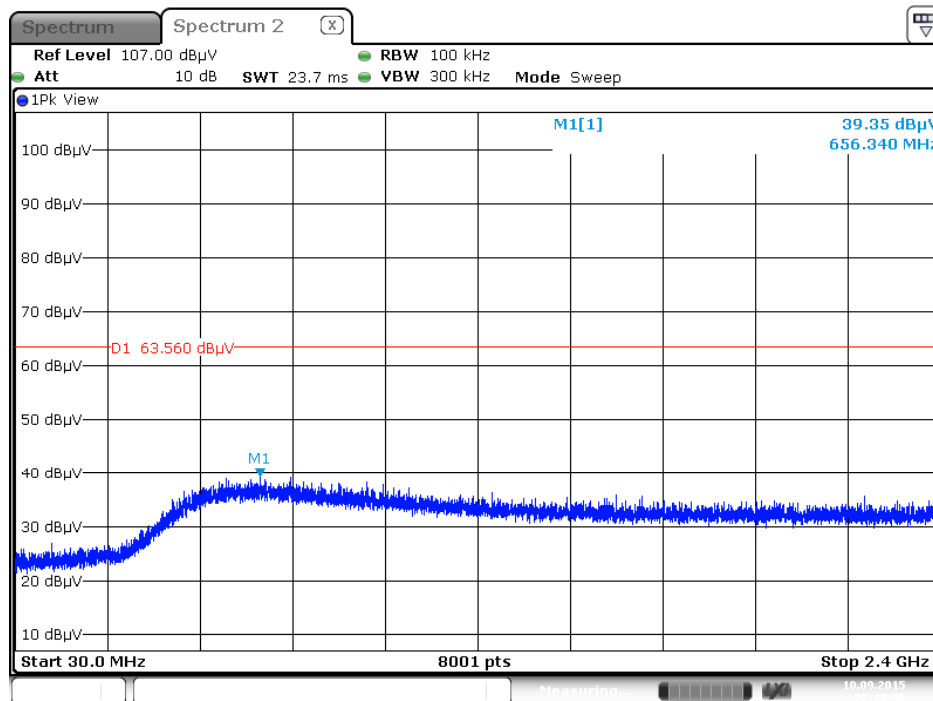

Plot on Configuration For Bluetooth 4.0 / Channel 0 / 2500MHz~26500MHz (down 30dBc)

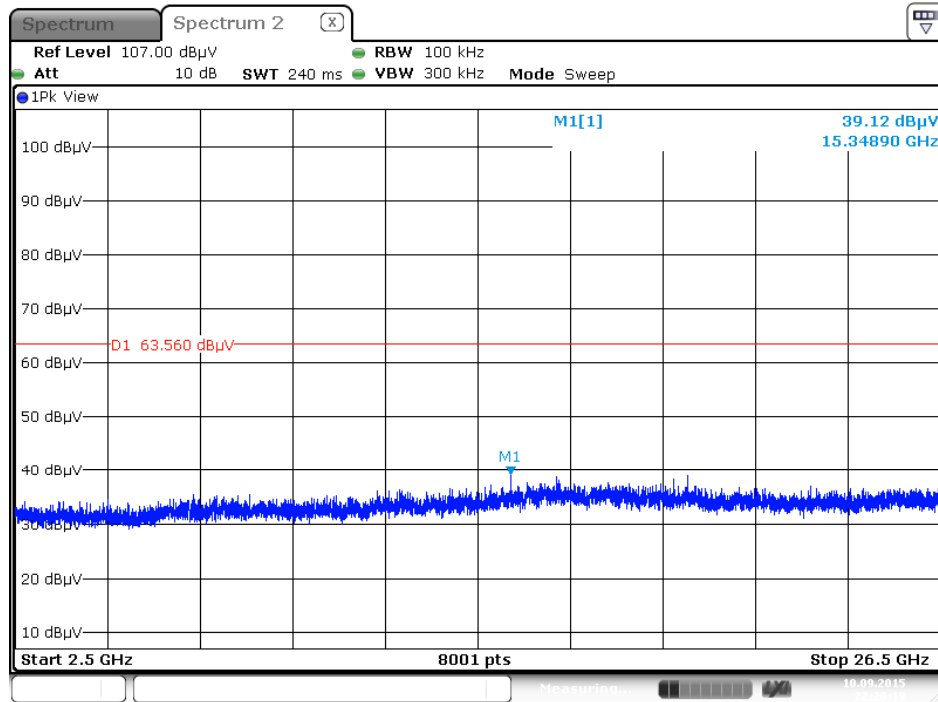

Plot on Configuration For Bluetooth 4.0 / Channel 39 / 30MHz~2400MHz (down 30dBc)

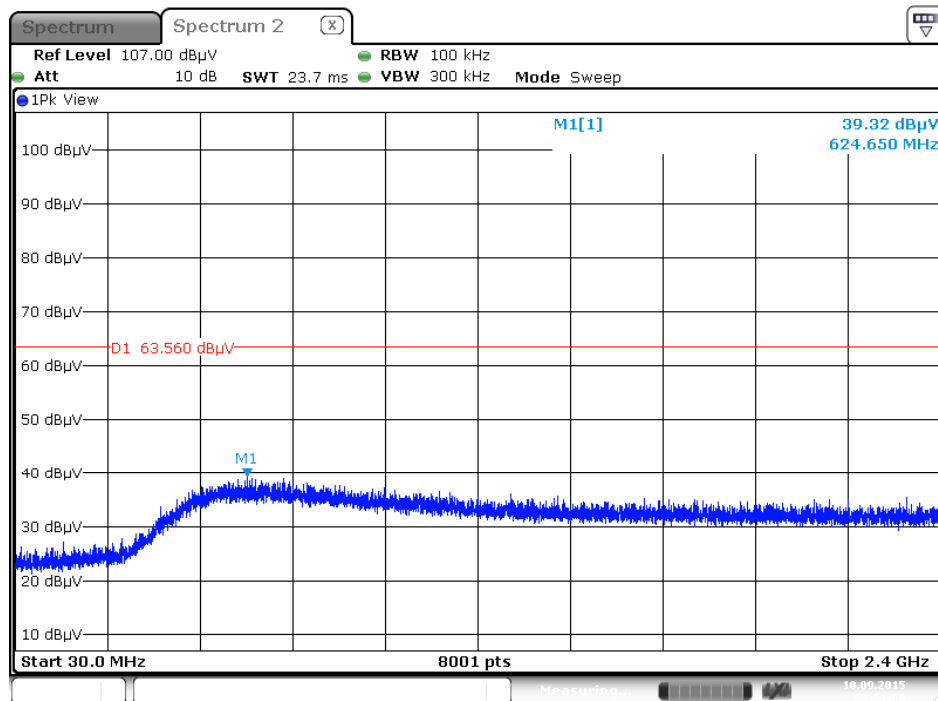

Plot on Configuration For Bluetooth 4.0 / Channel 39 / 2500MHz~26500MHz (down 30dBc)

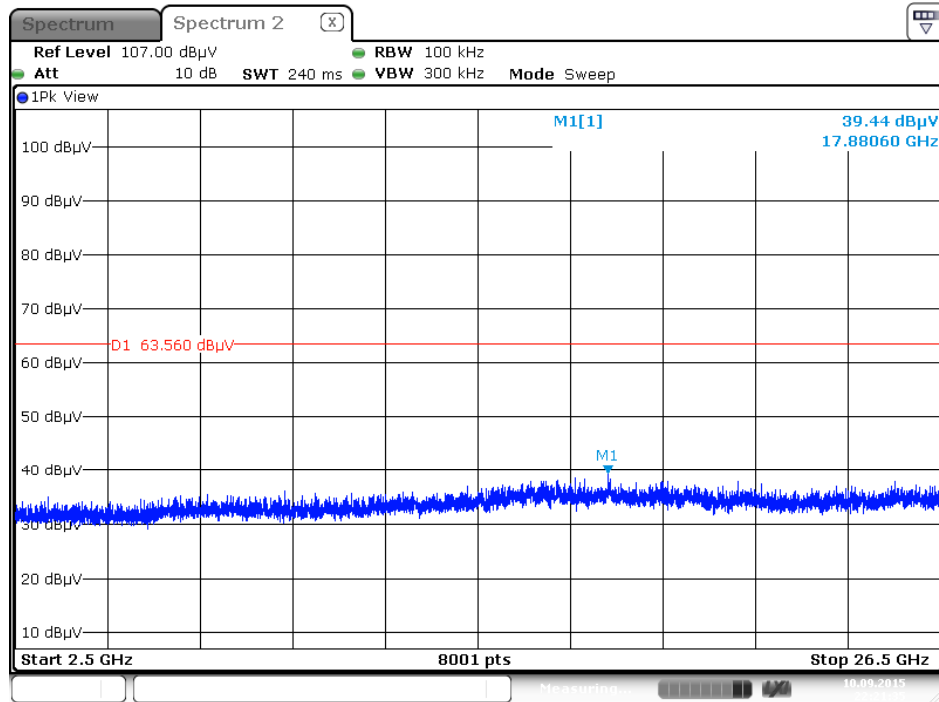

Date: 10 SEP 2015 22:21:35

4.7. Antenna Requirements

4.7.1. Limit

Except for special regulations, the Low-power Radio-frequency Devices must not be equipped with any jacket for installing an antenna with extension cable. An intentional radiator shall be designed to ensure that no antenna other than that furnished by the responsible party shall be used with the device. The use of a permanently attached antenna or of an antenna that uses a unique coupling to the intentional radiator shall be considered sufficient to comply with the provisions of this Section. The manufacturer may design the unit so that the user can replace a broken antenna, but the use of a standard antenna jack or electrical connector is prohibited. Further, this requirement does not apply to intentional radiators that must be professionally installed.

4.7.2. Antenna Connector Construction

Please refer to section 3.3 in this test report; antenna connector complied with the requirements.

5. LIST OF MEASURING EQUIPMENTS

Instrument	Manufacturer	Model No.	Serial No.	Characteristics	Calibration Date	Remark
EMI Test Receiver	R&S	ESCS 30	100355	9kHz ~ 2.75GHz	Apr. 22, 2015	Conduction (CO01-CB)
LISN	F.C.C.	FCC-LISN-50-16-2	04083	150kHz ~ 100MHz	Dec. 02, 2014	Conduction (CO01-CB)
LISN	Schwarzbeck	NSLK 8127	8127647	9kHz ~ 30MHz	Dec. 02, 2014	Conduction (CO01-CB)
COND Cable	Woken	Cable	01	150kHz ~ 30MHz	Dec. 03, 2014	Conduction (CO01-CB)
Software	Audix	E3	5.410e	-	N.C.R.	Conduction (CO01-CB)
BILOG ANTENNA	Schaffner	CBL6112D	22021	20MHz ~ 2GHz	May 06, 2015	Radiation (03CH01-CB)
Horn Antenna	EMCO	3115	00075790	750MHz ~ 18GHz	Oct. 28, 2014	Radiation (03CH01-CB)
Horn Antenna	Schwarzbeck	BBHA 9170	BBHA9170252	15GHz ~ 40GHz	Jul. 21, 2015	Radiation (03CH01-CB)
Pre-Amplifier	Agilent	8447D	2944A10991	0.1MHz ~ 1.3GHz	Feb. 24, 2015	Radiation (03CH01-CB)
Pre-Amplifier	Agilent	8449B	3008A02310	1GHz ~ 26.5GHz	Jan. 12, 2015	Radiation (03CH01-CB)
Pre-Amplifier	WM	TF-130N-R1	923365	26GHz ~ 40GHz	Nov. 25, 2014	Radiation (03CH01-CB)
Spectrum Analyzer	R&S	FSP40	100056	9kHz ~ 40GHz	Nov. 06, 2014	Radiation (03CH01-CB)
EMI Receiver	Agilent	N9038A	MY52260123	9kHz ~ 8.4GHz	Jan. 21, 2015	Radiation (03CH01-CB)
RF Cable-low	Woken	Low Cable-1	N/A	30 MHz ~ 1 GHz	Nov. 15, 2014	Radiation (03CH01-CB)
RF Cable-high	Woken	High Cable-40G-1	N/A	1 GHz ~ 40 GHz	Nov. 15, 2014	Radiation (03CH01-CB)
RF Cable-high	Woken	High Cable-40G-2	N/A	1 GHz ~ 40 GHz	Nov. 15, 2014	Radiation (03CH01-CB)
Loop Antenna	Teseq	HLA 6120	24155	9kHz - 30 MHz	Mar. 12, 2015*	Radiation (03CH01-CB)
Spectrum analyzer	R&S	FSP40	100979	9kHz~40GHz	Dec. 12, 2014	Conducted (TH01-CB)
RF Cable-high	Woken	RG402	High Cable-7	1 GHz – 26.5 GHz	Nov. 15, 2014	Conducted (TH01-CB)
RF Cable-high	Woken	RG402	High Cable-8	1 GHz – 26.5 GHz	Nov. 15, 2014	Conducted (TH01-CB)
RF Cable-high	Woken	RG402	High Cable-9	1 GHz – 26.5 GHz	Nov. 15, 2014	Conducted (TH01-CB)
RF Cable-high	Woken	RG402	High Cable-10	1 GHz – 26.5 GHz	Nov. 15, 2014	Conducted (TH01-CB)
RF Cable-high	Woken	RG402	High Cable-6	1 GHz – 26.5 GHz	Nov. 15, 2014	Conducted (TH01-CB)
Power Sensor	Agilent	U2021XA	MY53410001	50MHz~18GHz	Nov. 03, 2014	Conducted (TH01-CB)

Note: Calibration Interval of instruments listed above is one year.

“*” Calibration Interval of instruments listed above is two years.

N.C.R. means Non-Calibration required.

6. MEASUREMENT UNCERTAINTY

Test Items	Uncertainty	Remark
Conducted Emission (150kHz ~ 30MHz)	3.2 dB	Confidence levels of 95%
Radiated Emission (30MHz ~ 1,000MHz)	3.6 dB	Confidence levels of 95%
Radiated Emission (1GHz ~ 18GHz)	3.7 dB	Confidence levels of 95%
Radiated Emission (18GHz ~ 40GHz)	3.5 dB	Confidence levels of 95%
Conducted Emission	1.7 dB	Confidence levels of 95%