

FCC DFS Test Report

FCC ID : PPQ-WCBN3514A
Equipment : Wi-Fi (11a/b/g/n/ac 2Tx2R)+BT (V4.2LE) SDIO Combo Module
Brand Name : LITE-ON
Model Name : WCBN3514A
Applicant : LITE-ON Technology Corp.
Bldg. C, 90, Chien 1 Road, Chung Ho, New Taipei City 23585, Taiwan, R.O.C
Manufacturer : LITE-ON TECHNOLOGY (Changzhou) CO., LTD
A9 Building, No.88 Yanghu Road, Wujin Hi-Tech Industrial Development Zone, Changzhou City,
Standard : 47 CFR FCC Part 15.407

The product was received on Jan. 04, 2019, and testing was started from Mar. 29, 2019 and completed on Mar. 29, 2019. We, SPORTON INTERNATIONAL INC. EMC & Wireless Communications Laboratory, would like to declare that the tested sample has been evaluated in accordance with the procedures given in KDB 905462 D02 UNII DFS Compliance Procedures New Rules v02 and shown compliance with the applicable technical standards.

The report must not be used by the client to claim product certification, approval, or endorsement by TAF or any agency of United States government.

The test results in this report apply exclusively to the tested model / sample. Without written approval of SPORTON INTERNATIONAL INC. EMC & Wireless Communications Laboratory, the test report shall not be reproduced except in full.



Approved by: Allen Lin

SPORTON INTERNATIONAL INC. EMC & Wireless Communications Laboratory

No. 52, Huaya 1st Rd., Guishan Dist., Taoyuan City, Taiwan (R.O.C.)



Table of Contents

HISTORY OF THIS TEST REPORT3

SUMMARY OF TEST RESULT4

1 GENERAL DESCRIPTION5

1.1 Information.....5

1.2 Testing Applied Standards10

1.3 Testing Location Information10

2 TEST CONFIGURATION OF EUT.....11

2.1 Test Channel Frequencies Configuration.....11

2.2 The Worst Case Measurement Configuration.....11

2.3 Support Equipment.....11

3 DYNAMIC FREQUENCY SELECTION (DFS) TEST RESULT12

3.1 General DFS Information12

3.2 Radar Test Waveform Calibration15

3.3 In-service Monitoring21

4 TEST EQUIPMENT AND CALIBRATION DATA.....25

5 MEASUREMENT UNCERTAINTY26

Appendix A. Test Photos

Photographs of EUT V01



History of this test report

Report No.	Version	Description	Issued Date
FZ910405	01	Initial issue of report	May 30, 2019



Summary of Test Result

Report Clause	Ref. Std. Clause	Test Items	Result (PASS/FAIL)	Remark
3.3	KDB 905462 7.8.3	DFS: In-Service Monitoring for Channel Move Time (CMT)	PASS	CMT ≤ 10sec
3.3	KDB 905462 7.8.3	DFS: In-Service Monitoring for Channel Closing Transmission Time (CCTT)	PASS	CCTT ≤ 60 ms starting at CMT 200ms
3.3	KDB 905462 7.8.3	DFS: In-Service Monitoring for Non-Occupancy Period (NOP)	PASS	NOP ≥ 30 min

Note: Since the product is client without radar detection function, only Channel Move Time, Channel Closing Transmission Time and Non-Occupancy Period are required to perform.

Declaration of Conformity:
The test results with all measurement uncertainty excluded are presented in accordance with the regulation limits or requirements declared by manufacturers.
Comments and explanations:
None

Reviewed by: Ben Tseng

Report Producer: Debby Hung



1 General Description

1.1 Information

1.1.1 RF General Information

Specification Items	Description	
Product Type	WLAN (2TX, 2RX)	
Radio Type	Intentional Transceiver	
Power Type	From power adapter	
Modulation	IEEE 802.11a/n/ac: OFDM (BPSK / QPSK / 16QAM / 64QAM) IEEE 802.11: see the below table	
Data Rate (Mbps)	IEEE 802.11a: OFDM (6/9/12/18/24/36/48/54) IEEE 802.11n/ac: see the below table	
Channel Bandwidth	20/40/80 MHz operating channel bandwidth	
Operating Mode	<input type="checkbox"/>	Master
	<input type="checkbox"/>	Bridge
	<input type="checkbox"/>	Mesh
	<input type="checkbox"/>	Client with radar detection
	<input checked="" type="checkbox"/>	Client without radar detection
Communication Mode	<input checked="" type="checkbox"/> IP Based (Load Based)	<input type="checkbox"/> Frame Based
TPC Function	<input checked="" type="checkbox"/> With TPC	<input type="checkbox"/> Without TPC
Weather Band (5600~5650MHz)	<input checked="" type="checkbox"/> With 5600~5650MHz	<input type="checkbox"/> Without 5600~5650MHz
Software / Firmware Version	2.0.0.56	
Note: EUT employ a TPC mechanism and TPC have the capability to operate at least 6 dB below highest RF output power.		



Antenna & Bandwidth

Antenna	One (TX)		
	20 MHz	40 MHz	80 MHz
Band width Mode			
IEEE 802.11a	V	V	V
IEEE 802.11n	V	V	V
IEEE 802.11ac	V	V	V

IEEE 11n/ac Spec.

Protocol	Number of Transmit Chains (NTX)	Data Rate / MCS
802.11n (HT20)	2	MCS 0-15
802.11n (HT40)	2	MCS 0-15
802.11ac (VHT20)	2	MCS 0-8/Nss1
802.11ac (VHT40)	2	MCS 0-9/Nss1
802.11ac (VHT80)	2	MCS 0-9/Nss1

Note 1: IEEE Std. 802.11n modulation consists of HT20 and HT40 (HT: High Throughput). Then EUT support HT20 and HT40.
 Note 2: HT20 and HT40 use a combination of OFDM-BPSK, QPSK, 16QAM, 64QAM modulation.
 Note 3: IEEE Std. 802.11ac modulation consists of VHT20, VHT40 and VHT80 (VHT: Very High Throughput). Then EUT support VHT20, VHT40 and VHT80.
 Note 4: VHT20, VHT40, VHT80 use a combination of OFDM-BPSK, QPSK, 16QAM, 64QAM, 256QAM modulation.
 Note 5: Modulation modes consist of below configuration:
 11a: IEEE 802.11a, HT20/HT40: IEEE 802.11n, VHT20/VHT40/VHT80: IEEE 802.11ac



1.1.2 Antenna Information

Group.	Ant.	Project	Brand	P/N	Antenna Type	Connector
1	1	-	Walsin	RFMTA401020IMLB701	PIFA	Mini i-Pex
	2					
	3					
2	4	(Sparrow 10 inch)	Shenzhen South Star Technology Co., LTD	N12-4140-R0A	PIFA	N/A
	5			N12-4141-R0A		
	6			N14-0594-R0A		
3	7	(Sparrow 8 inch)	Shenzhen South Star Technology Co., LTD	N12-4142-R0A	PIFA	N/A
	8			N12-4143-R0A		
	9			N14-0595-R0A		
4	10	-	INPAQ	EAA65404602	PIFA	N/A
	11			EAA65404601		
	12			EAA65404701		
5	13	-	Airgain	N2420SDAR-T6-G120U4LI (Rev B)	PIFA	Mini i-Pex
	14			N2420DCB3-T10-G200U4LI (Rev B)		
	15			N2410MST-T-G85U4LI (Rev G)		



Group.	Ant.	Port	Gain (dBi)		
			2.4G	5G	BT
1	1	1	3.52	4.18	-
	2	2	3.52	4.18	-
	3	1	-	-	3.52
2	4	1	2.97	4.04	-
	5	2	3.41	4.05	-
	6	1	-	-	3.31
3	7	1	3.35	3.97	-
	8	2	3.35	3.86	-
	9	1	-	-	2.86
4	10	1	2.99	3.46	-
	11	2	3.06	3.23	-
	12	1	-	-	2.74
5	13	1	4.00	4.80	-
	14	2	4.00	4.30	-
	15	1	-	-	2.70

Note : EUT can match with above antennas for using. Higher gain in each type of antenna was used to perform the worst configuration and result of that was recorded as the final test result.

For 2.4GHz function:

For IEEE 802.11 b/g/n mode (2TX/2RX)

Ant 1, 2, 4, 5, 7, 8, 10, 11, 13, 14 could transmit/receive.

For BT function:

For IEEE 802.15.1 Bluetooth mode (1TX/1RX)

Ant 3, 6, 9, 12, 15 could transmit/receive.

For 5GHz function:

For IEEE 802.11 a/n/ac mode (2TX/2RX)

Ant 1, 2, 4, 5, 7, 8, 10, 11, 13, 14 could transmit/receive.



1.1.3 DFS Band Carrier Frequencies

There are three bandwidth systems.

For 20MHz bandwidth systems, use Channel 52, 56, 60, 64, 100, 104, 108, 112, 116, 120, 124, 128, 132, 136, 140.

For 40MHz bandwidth systems, use Channel 54, 62, 102, 110, 118, 126, 134.

For 80MHz bandwidth systems, use Channel 58, 106, 122.

Frequency Band	Channel No.	Frequency	Channel No.	Frequency
5250~5350 MHz U-NII-2A	52	5260 MHz	60	5300 MHz
	54	5270 MHz	62	5310 MHz
	56	5280 MHz	64	5320 MHz
	58	5290 MHz	-	-
5470~5725 MHz U-NII-2C	100	5500 MHz	120	5600 MHz
	102	5510 MHz	122	5610 MHz
	104	5520 MHz	124	5620 MHz
	106	5530 MHz	126	5630 MHz
	108	5540 MHz	128	5640 MHz
	110	5550 MHz	132	5660 MHz
	112	5560 MHz	134	5670 MHz
	116	5580 MHz	136	5680 MHz
118	5590 MHz	140	5700 MHz	



1.2 Testing Applied Standards

According to the specifications of the manufacturer, the EUT must comply with the requirements of the following standards:

- ◆ KDB 905462 D02 UNII DFS Compliance Procedures New Rules v02
- ◆ KDB 905462 D03 Client Without DFS New Rules v01r02

1.3 Testing Location Information

Testing Location				
<input checked="" type="checkbox"/>	HWA YA	ADD : No. 52, Huaya 1st Rd., Guishan Dist., Taoyuan City, Taiwan (R.O.C.)		
		TEL : 886-3-327-3456	FAX : 886-3-327-0973	
Test site Designation No. TW1190 with FCC.				
<input type="checkbox"/>	JHUBEI	ADD : No.8, Lane 724, Bo-ai St., Jhubei City, HsinChu County 302, Taiwan, R.O.C.		
		TEL : 886-3-656-9065	FAX : 886-3-656-9085	
Test site Designation No. TW0006 with FCC.				
Test Condition	Test Site No.	Test Engineer	Test Environment	Test Date
DFS Site	DFS01-HY	Terry	25.3~26.1°C / 59.2~60.1%	29/Mar/2019

2 Test Configuration of EUT

2.1 Test Channel Frequencies Configuration

Test Channel Frequencies Configuration	
IEEE Std.	Test Channel Freq. (MHz)
802.11ac (VHT80)	5530 MHz

2.2 The Worst Case Measurement Configuration

The Worst Case Mode for Following Conformance Tests	
Tests Item	Dynamic Frequency Selection (DFS)
Test Condition	Conducted measurement at transmit chains The EUT shall be configured to operate at the highest transmitter output power setting. If more than one antenna assembly is intended for this power setting, the gain of the antenna assembly with the lowest gain shall be used.
Modulation Mode	802.11ac (VHT80)

2.3 Support Equipment

Support Equipment			
No.	Equipment	Brand Name	Model Name
1	AP (Master)	EDIMAX	EW-7479WAC
2	NoteBook	DELL	Latitude E5550
3	Adapter for NB	DELL	FA90PSO-00
4	Shielding Box	EMEC	EM-SHB-650550300-M

3 Dynamic Frequency Selection (DFS) Test Result

3.1 General DFS Information

3.1.1 DFS Parameters

Table D.1: DFS requirement values	
Parameter	Value
Non-occupancy period	Minimum 30 minutes
Channel Availability Check Time	60 seconds
Channel Move Time	10 seconds (Note 1).
Channel Closing Transmission Time	200 milliseconds + an aggregate of 60 milliseconds over remaining 10 second periods. (Notes 1 and 2).
U-NII Detection Bandwidth	Minimum 100% of the 99% power bandwidth (Note 3).

Note 1: Channel Move Time and the Channel Closing Transmission Time should be performed with Radar Type 0. The measurement timing begins at the end of the Radar Type 0 burst.

Note 2: The Channel Closing Transmission Time is comprised of 200 milliseconds starting at the beginning of the Channel Move Time plus any additional intermittent control signals required to facilitate Channel changes (an aggregate of 60 milliseconds) during the remainder of the 10 second period. The aggregate duration of control signals will not count quiet periods in between transmissions.

Note 3: During the U-NII Detection Bandwidth detection test, radar type 0 is used and for each frequency step the minimum percentage of detection is 90%. Measurements are performed with no data traffic.

Table D.2: Interference threshold values	
Maximum Transmit Power	Value (see note)
EIRP ≥ 200 mW	-64 dBm
EIRP < 200 mW and PSD < 10dBm/MHz	-62 dBm
EIRP < 200 mW and PSD ≥ 10dBm/MHz	-64 dBm

Note 1: This is the level at the input of the receiver assuming a 0 dBi receive antenna.

Note 2: Throughout these test procedures an additional 1 dB has been added to the amplitude of the test transmission waveforms to account for variations in measurement equipment. This will ensure that the test signal is at or above the detection threshold level to trigger a DFS response.

Note3: EIRP is based on the highest antenna gain. For MIMO devices refer to KDB Publication 662911.



3.1.2 Applicability of DFS Requirements Prior to Use of a Channel

Requirement	DFS Operational mode		
	Master	Client without radar detection	Client with radar detection
<i>Non-Occupancy Period</i>	Yes	Not required (See the note)	Yes
<i>DFS Detection Threshold</i>	Yes	Not required	Yes
<i>Channel Availability Check Time</i>	Yes	Not required	Not required
<i>U-NII Detection Bandwidth</i>	Yes	Not required	Yes

Note :

According to KDB 905462 D03 Client Without DFS New Rules v01r02 (b) 6."An analyzer plot that contains a single 30-minute sweep on the original channel "

3.1.3 Applicability of DFS Requirements during Normal Operation

Requirement	DFS Operational mode		
	Master	Client without radar detection	Client with radar detection
<i>DFS Detection Threshold</i>	Yes	Not required	Yes
<i>Channel Closing Transmission Time</i>	Yes	Yes	Yes
<i>Channel Move Time</i>	Yes	Yes	Yes
<i>U-NII Detection Bandwidth</i>	Yes	Not required	Yes

Additional requirements for devices with multiple bandwidth modes	Master Device or Client with Radar Detection	Client Without Radar Detection
U-NII Detection Bandwidth and Statistical Performance Check	All BW modes must be tested	Not required
Channel Move Time and Channel Closing Transmission Time	Test using widest BW mode available	Test using the widest BW mode available for the link
All other tests	Any single BW mode	Not required

Note: Frequencies selected for statistical performance check (Section 7.8.4) should include several frequencies within the radar detection bandwidth and frequencies near the edge of the radar detection bandwidth. For 802.11 devices it is suggested to select frequencies in each of the bonded 20 MHz channels and the channel center frequency.



3.1.4 Channel Loading/Data Streaming

<input type="checkbox"/>	The data file (MPEG-4) has been transmitting in a streaming mode.
<input checked="" type="checkbox"/>	Software to ping the client is permitted to simulate data transfer with random ping intervals.
<input checked="" type="checkbox"/>	Minimum channel loading of approximately 17%.
<input type="checkbox"/>	Unicast protocol has been used.



3.2 Radar Test Waveform Calibration

3.2.1 Short Pulse Radar Test Waveforms

Radar Type	Pulse Width (µsec)	PRI (µsec)	Number of Pulses	Minimum Percentage of Successful Detection	Minimum Trials
0	1	1428	18	See Note 1	See Note 1
1A	1	15 unique PRI in KDB 905462 D02 Table 5a	$\text{Roundup} \left\{ \left(\frac{1}{360} \right) \times \left(\frac{19 \times 10^6}{PRI} \right) \right\}$	60%	15
1B	1	15 unique PRI within 518-3066, Excluding 1A PRI		60%	15
2	1-5	150-230	23-29	60%	30
3	6-10	200-500	16-18	60%	30
4	11-20	200-500	12-16	60%	30
Aggregate (Radar Types 1-4)				80%	120
Note 1: Short Pulse Radar Type 0 should be used for the detection bandwidth test, channel move time, and channel closing time tests.					

A minimum of 30 unique waveforms are required for each of the short pulse radar types 1 through 4. If more than 30 waveforms are used for short pulse radar types 1 through 4, then each additional waveform must also be unique and not repeated from the previous waveforms. The aggregate is the average of the percentage of successful detections of short pulse radar types 1-4.

3.2.2 Long Pulse Radar Test Waveform

Radar Type	Pulse Width (µsec)	Chirp Width (MHz)	PRI (µsec)	Number of Pulses per Burst	Number of Bursts	Minimum Percentage of Successful Detection	Minimum Trials
5	50-100	5-20	1000-2000	1-3	8-20	80%	30

Each waveform is defined as follows:

- The transmission period for the Long Pulse Radar test signal is 12 seconds.
- There are a total of 8 to 20 Bursts in the 12 second period, with the number of Bursts being randomly chosen. This number is Burst Count.
- Each Burst consists of 1 to 3 pulses, with the number of pulses being randomly chosen. Each Burst within the 12 second sequence may have a different number of pulses.
- The pulse width is between 50 and 100 microseconds, with the pulse width being randomly chosen. Each pulse within a Burst will have the same pulse width. Pulses in different Bursts may have different pulse widths.
- Each pulse has a linear FM chirp between 5 and 20 MHz, with the chirp width being randomly chosen. Each pulse within a transmission period will have the same chirp width. The chirp is centered on the pulse. For example, with a radar frequency of 5300 MHz and a 20 MHz chirped signal, the chirp starts at 5290 MHz and

ends at 5310 MHz.

- If more than one pulse is present in a Burst, the time between the pulses will be between 1000 and 2000 microseconds, with the time being randomly chosen. If three pulses are present in a Burst, the time between the first and second pulses is chosen independently of the time between the second and third pulses.
- The 12 second transmission period is divided into even intervals. The number of intervals is equal to Burst Count. Each interval is of length $(12,000,000 / \text{Burst Count})$ microseconds. Each interval contains one Burst. The start time for the Burst, relative to the beginning of the interval, is between 1 and $[(12,000,000 / \text{Burst Count}) - (\text{Total Burst Length}) + (\text{One Random PRI Interval})]$ microseconds, with the start time being randomly chosen. The step interval for the start time is 1 microsecond. The start time for each Burst is chosen independently.

3.2.3 Frequency Hopping Radar Test Waveform

Radar Type	Pulse Width (µsec)	PRI (µsec)	Pulses per Hop	Hopping Rate (kHz)	Hopping Sequence Length (ms)	Minimum Percentage of Successful Detection	Minimum Trials
6	1	333	9	0.333	300	70%	30

The FCC Type 6 waveform uses a static waveform with 100 bursts in the instruments ARB. In addition, the RF list mode is operated with a list containing 100 frequencies from a randomly generated list and it had be ensured that at least one of the random frequencies falls into the UNII Detection Bandwidth of the DUT. Each burst from the waveform file initiates a trigger pulse at the beginning that switches the RF list from one item to the next one.

3.2.4 DFS Threshold Level

DFS Threshold Level	
DFS Threshold level: -63 dBm	<input checked="" type="checkbox"/> at the antenna connector
	<input type="checkbox"/> in front of the antenna
The Interference Radar Detection Threshold Level is $-64 \text{ dBm} + 0 [\text{dBi}] + 1 \text{ dB} = -63 \text{ dBm}$. That had been taken into account the output power range and antenna gain.	

3.2.5 Calibration Setup

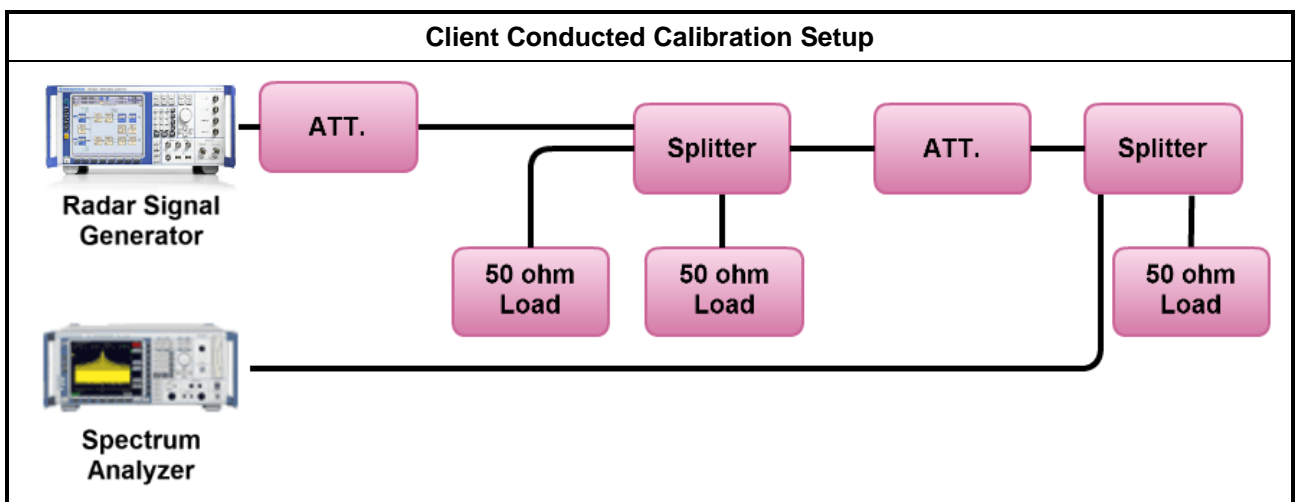

3.2.6 Radar Waveform calibration Plot

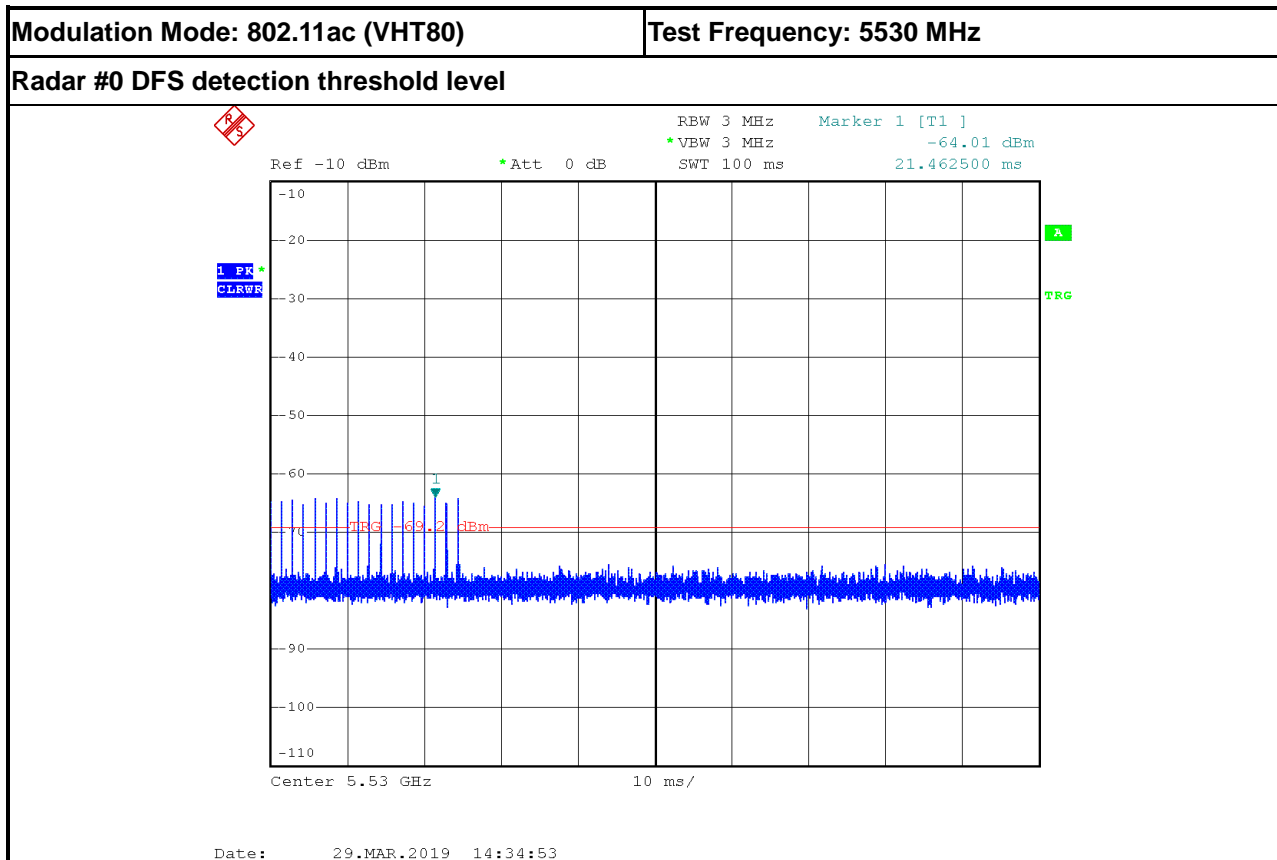

3.2.7 Test Setup

A spectrum analyzer is used as a monitor to verify that the EUT has vacated the Channel within the (Channel Closing Transmission Time and Channel Move Time, and does not transmit on a Channel during the Non-Occupancy Period after the detection and Channel move.

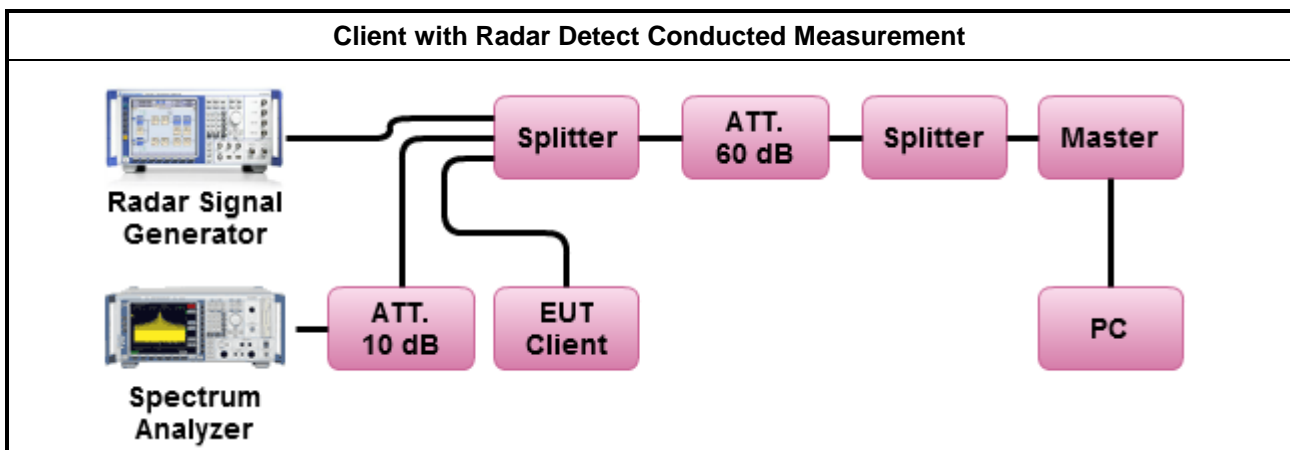



3.2.8 Data traffic Plot

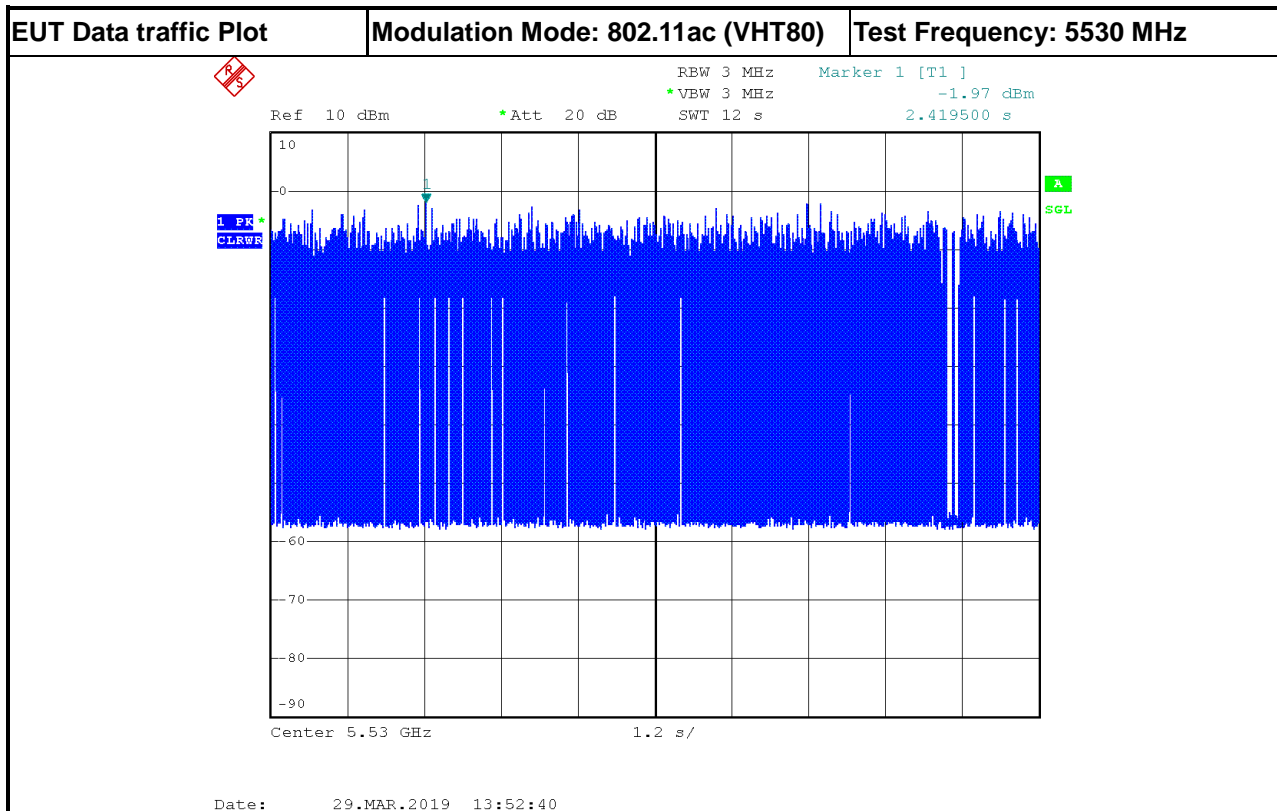

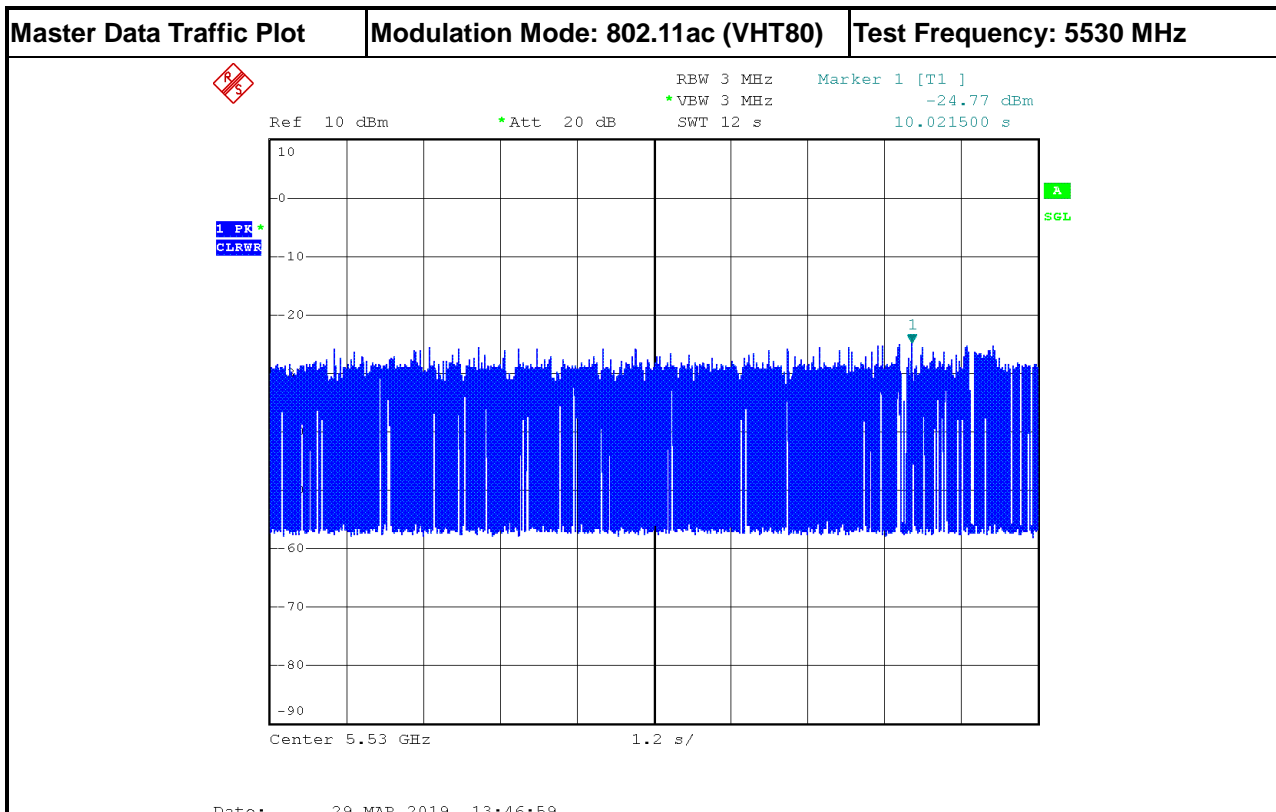

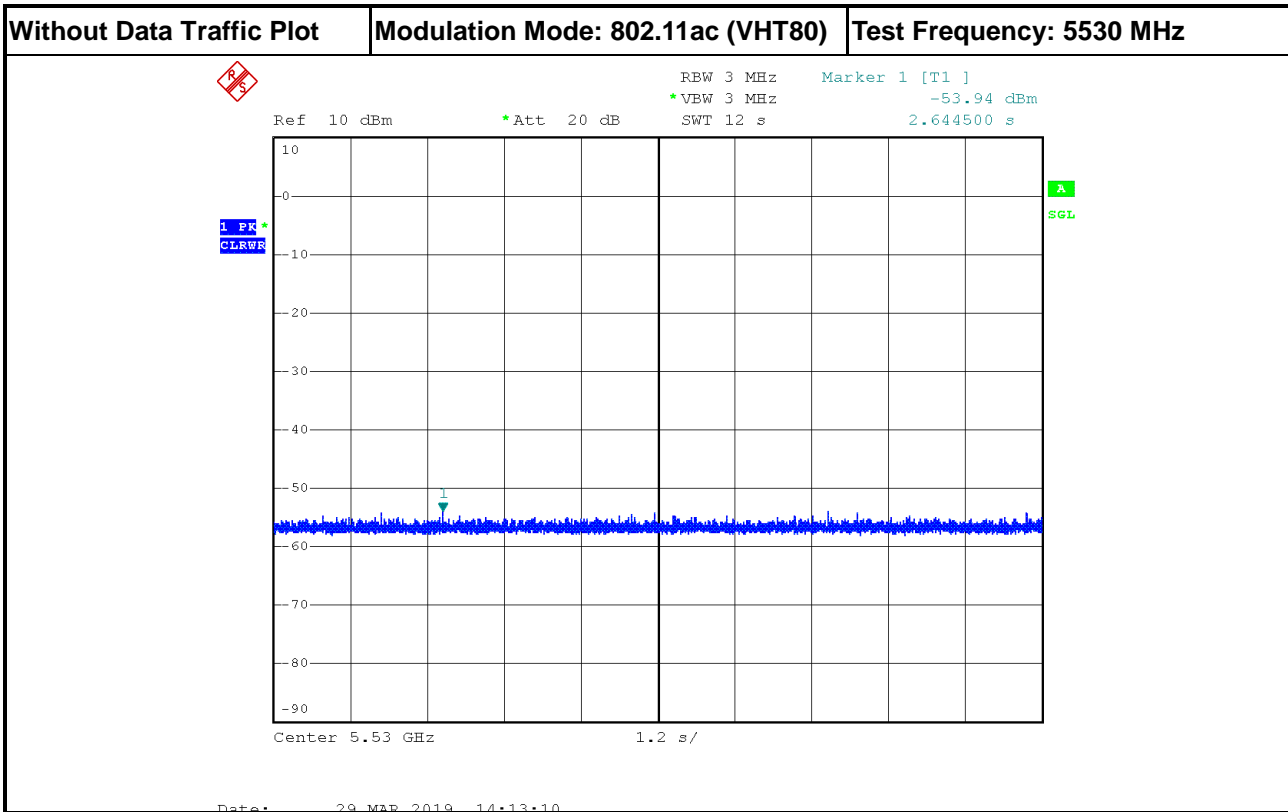

Date: 29 MAR 2019 14:13:10



3.3 In-service Monitoring

3.3.1 In-service Monitoring Limit

In-service Monitoring Limit	
Channel Move Time	10 sec
Channel Closing Transmission Time	200 ms + an aggregate of 60 ms over remaining 10 sec periods.
Non-occupancy period	Minimum 30 minutes

3.3.2 Measuring Instruments

Refer a test equipment and calibration data table in this test report.

3.3.3 Test Procedures

Test Method	
<input checked="" type="checkbox"/>	Verified during In-Service Monitoring; Channel Closing Transmission Time, Channel Move Time. Client Device will associate with the EUT. Observe the transmissions of the EUT at the end of the radar Burst on the Operating Channel for duration greater than 10 seconds. Measure and record the transmissions from the EUT during the observation time (Channel Move Time). Compare the Channel Move Time and Channel Closing Transmission Time limits.
<input checked="" type="checkbox"/>	Verified during In-Service Monitoring; Channel Closing Transmission Time, Channel Move Time. One 12 sec plot needs to be reported for the Short Pulse Radar Types 0. And zoom-in a 60 ms plot verified channel closing time for the aggregate transmission time starting from 200ms after the end of the radar signal to the completion of the channel move.
<input checked="" type="checkbox"/>	Verified during In-Service Monitoring; Non-Occupancy Period. Client Device will associate with the EUT. Observe the transmissions of the EUT at the end of the radar Burst on the Operating Channel for duration greater than 10 seconds. Measure and record the transmissions from the EUT during the observation time (Non-Occupancy Period). Compare the Non-Occupancy Period limits.

3.3.4 Test Result of In-service Monitoring

Modulation Mode: 802.11ac (VHT80)

Parameter	Test Result	Limit
	Type 0	
Test Channel (MHz)	5530 MHz	-
Channel Move Time (sec.)	0.0129	< 10s
Channel Closing Transmission Time (ms) (Note)	0.000	< 60ms
Non-Occupancy Period (min.)	≥ 30	≥ 30 min

Note: The Channel Closing Transmission Time is comprised of 200 milliseconds starting at the beginning of the Channel Move Time plus any additional intermittent control signals required to facilitate a Channel move (an aggregate of 60 milliseconds) during the remainder of the 10 seconds period. The aggregate duration of control signals will not count quiet periods in between transmissions.



3.3.5 Test Plot of In-Service Monitoring for Channel Move Time

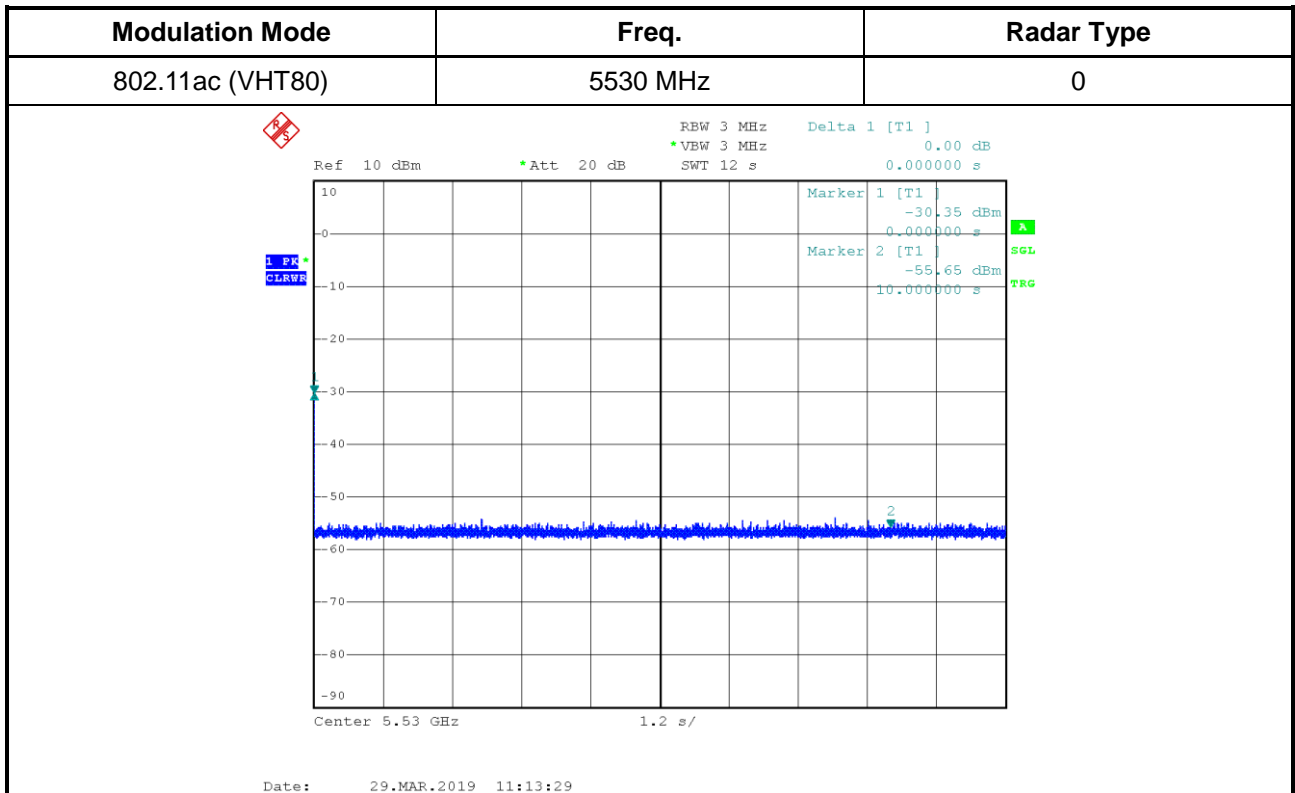



3.3.6 Test Plot of In-Service Monitoring for Channel Closing Transmission Time

Modulation Mode	Freq.	Radar Type
802.11ac (VHT80)	5530 MHz	0

Channel Closing Transmission Time is comprised of 200ms starting at the beginning of the Channel Move Time plus 60ms additional intermittent control signals

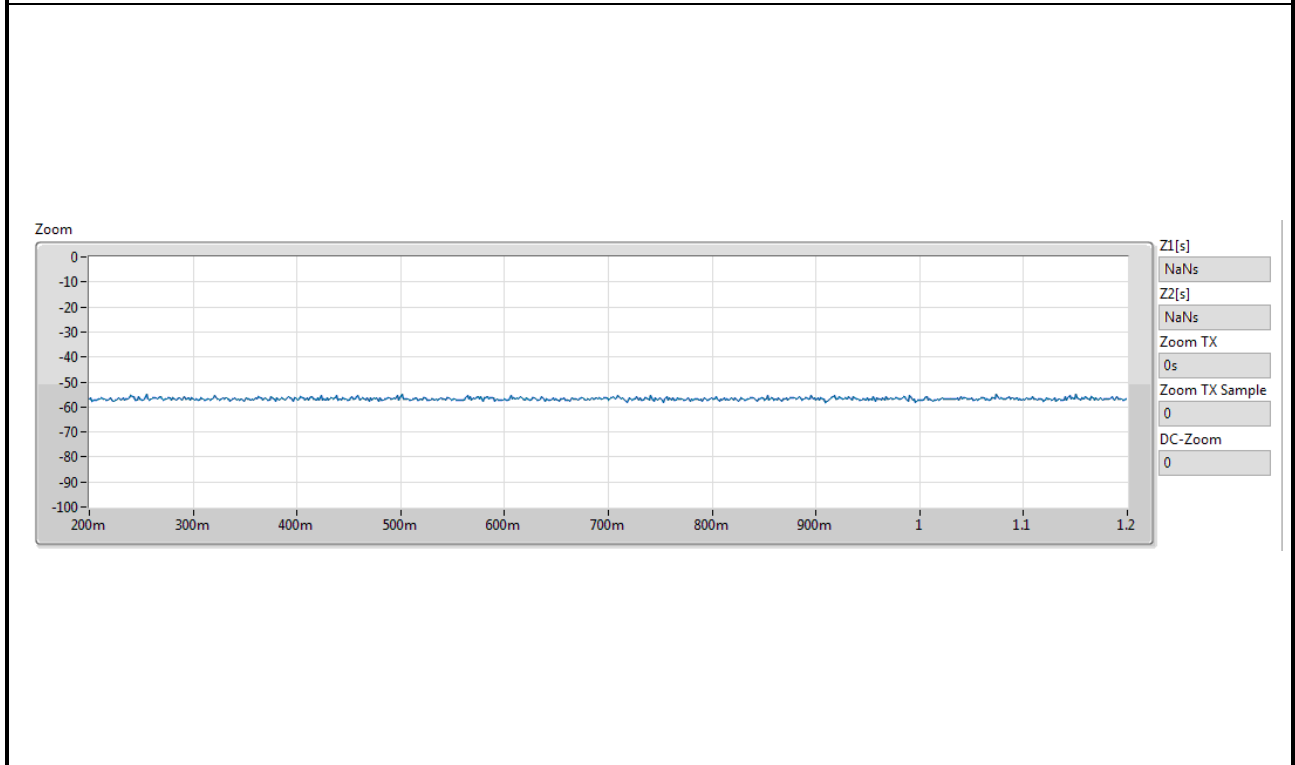



3.3.7 Test Plot of In-Service Monitoring for Non-Occupancy Period

Modulation Mode	Freq.
802.11ac (VHT80)	5530 MHz

Non-Occupancy Period

During the 30 minutes observation time, UUT did not make any transmissions on a channel after a radar signal was detected on that channel by either the Channel Availability Check or the In-Service Monitoring.

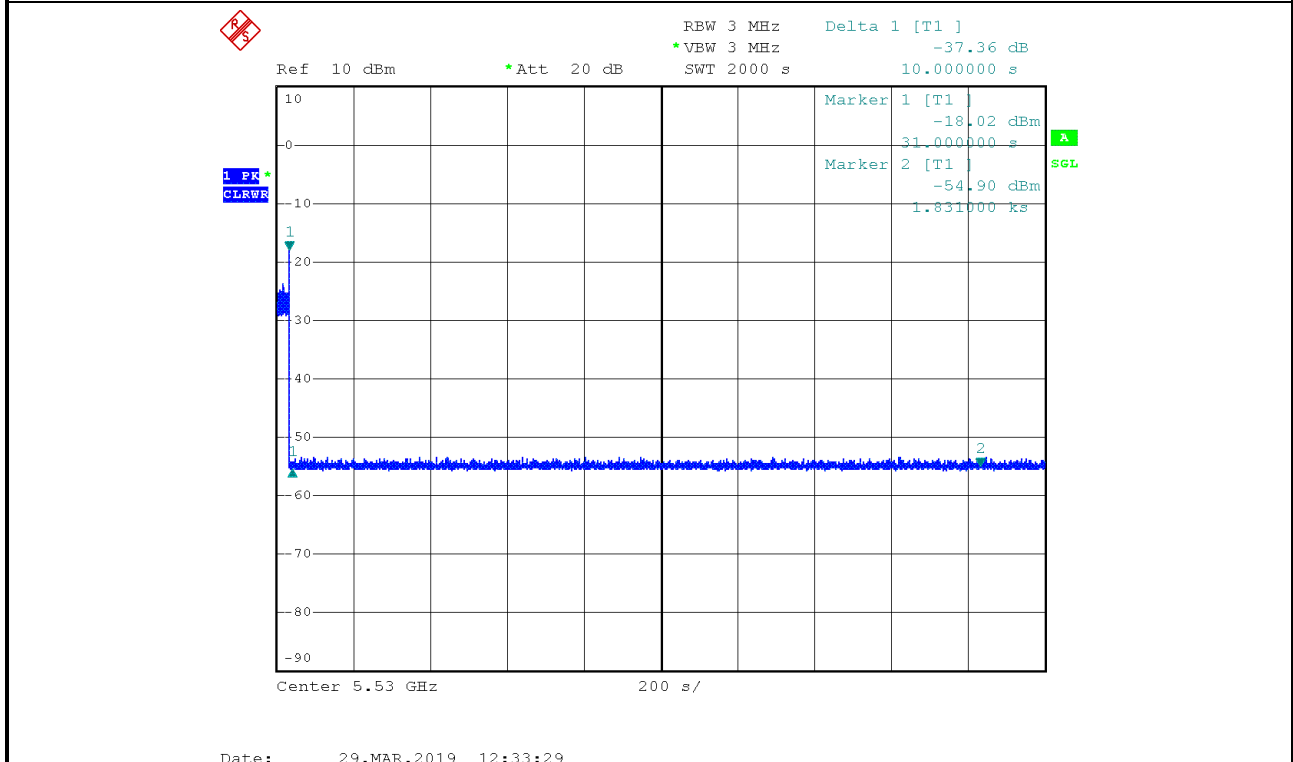



4 Test Equipment and Calibration Data

Instrument	Manufacturer	Model No.	Serial No.	Spec.	Calibration Date	Calibration Due Date
Spectrum Analyzer	R&S	FSP7	100645	9kHz ~ 7GHz	27/Sep/2018	26/Sep/2019
Vector Signal Generator	R&S	SMU200A	102098	100kHz ~ 6GHz	26/Feb/2019	25/Feb/2020
RF cable 1m	HUBER+SUHNER	SUCOFLEX 104	MY37334/4	25 MHz ~ 26.5 GHz	01/Nov/2018	31/Oct/2019
RF cable 1m	HUBER+SUHNER	SUCOFLEX 104	MY37335/4	25 MHz ~ 26.5 GHz	01/Nov/2018	31/Oct/2019
RF cable 1m	HUBER+SUHNER	SUCOFLEX 104	MY37336/4	25 MHz ~ 26.5 GHz	01/Nov/2018	31/Oct/2019
RF cable 1.5m	HUBER+SUHNER	SUCOFLEX 104	MY33066/4	25 MHz ~ 26.5 GHz	01/Nov/2018	31/Oct/2019



5 Measurement Uncertainty

Test Items	Uncertainty	Remark
Conducted Emission	1.3 dB	Confidence levels of 95%
Temperature	0.7 °C	Confidence levels of 95%
Humidity	4 %	Confidence levels of 95%