

RADIO TEST REPORT

FCC 47 CFR PART 15 SUBPART C

INDUSTRY CANADA RSS-247

Test Standard	FCC Part 15.247 and IC RSS-247 issue 2
FCC ID	PPQ-WCBN3509A
ISED ID	4491A-WCBN3509A
Product name	802.11a/b/g/n/ac 2Tx2R+BT V4.1LE USB Combo Module
Brand Name	LITE-ON
Model Name	WCBN3509A
Test Result	Pass

The test Result was tested by Compliance Certification Services Inc. The test data, data evaluation, test procedures, and equipment configurations shown in this report were given in ANSI C63.10: 2013 and compliance standards.

The test results of this report relate only to the tested sample (EUT) identified in this report.

The test Report of full or partial shall not copy. Without written approval of Compliance Certification Services Inc.(Wugu Laboratory)



Approved by:

A handwritten signature in black ink that reads "Sam Chuang".

Sam Chuang
Manager

Tested by:

A handwritten signature in black ink that reads "Kevin.Kuo".

Kevin Kuo
Engineer

Revision History

Rev.	Issue Date	Revisions	Effect Page	Revised By
00	December 5, 2017	Initial Issue	ALL	Allison Chen

Table of contents

- 1. GENERAL INFORMATION 4
 - 1.1 EUT INFORMATION 4
 - 1.2 EUT CHANNEL INFORMATION 5
 - 1.3 ANTENNA INFORMATION 5
 - 1.4 MEASUREMENT UNCERTAINTY..... 6
 - 1.5 FACILITIES AND TEST LOCATION 7
 - 1.6 INSTRUMENT CALIBRATION 7
 - 1.7 SUPPORT AND EUT ACCESSORIES EQUIPMENT 8
- 2. TEST SUMMERY 9
- 3. DESCRIPTION OF TEST MODES..... 10
 - 3.1 THE WORST MODE OF OPERATING CONDITION 10
 - 3.2 THE WORST MODE OF MEASUREMENT 11
 - 3.3 EUT DUTY CYCLE..... 12
- 4. TEST RESULT 13
 - 4.1 AC POWER LINE CONDUCTED EMISSION 13
 - 4.2 6DB BANDWIDTH AND OCCUPIED BANDWIDTH(99%) 16
 - 4.3 OUTPUT POWER MEASUREMENT 18
 - 4.4 POWER SPECTRAL DENSITY 20
 - 4.5 CONDUCTED BAND EDGE AND SPURIOUS EMISSION 22
 - 4.6 RADIATION BANDEDGE AND SPURIOUS EMISSION 26

APPENDIX 1 - PHOTOGRAPHS OF EUT

1. GENERAL INFORMATION

1.1 EUT INFORMATION

Applicant	LITE-ON Technology Corp. Bldg. C, 90, Chien 1 Road, Chung Ho, New Taipei City 23585, Taiwan, R.O.C
Manufacturer	LITE-ON TECHNOLOGY (Changzhou) CO., LTD A9 Building, No.88 Yanghu Road, Wujin Hi-Tech Industrial Development Zone, Changzhou City, Jiangsu Province 213100 China
Equipment	802.11a/b/g/n/ac 2Tx2R+BT V4.1LE USB Combo Module
Model No.	WCBN3509A
Model Discrepancy	N/A
Trade Name	LITE-ON
Received Date	November 28, 2017
Date of Test	November 30 ~ December 2, 2017
Output Power (W)	BLE : 0.0024 (EIRP : 0.0058)
Power Supply	Powered from host device: DC 5V
H/W Version	V05
F/W Version	V37.27

1.2 EUT CHANNEL INFORMATION

Frequency Range	2402MHz-2480MHz
Modulation Type	GFSK for BLE-1Mbps
Number of channel	40 Channels

Remark:

Refer as ANSI 63.10:2013 clause 5.6.1 Table 4 and RSS-GEN Table A1 for test channels

Number of frequencies to be tested		
Frequency range in which device operates	Number of frequencies	Location in frequency range of operation
<input type="checkbox"/> 1 MHz or less	1	Middle
<input type="checkbox"/> 1 MHz to 10 MHz	2	1 near top and 1 near bottom
<input checked="" type="checkbox"/> More than 10 MHz	3	1 near top, 1 near middle, and 1 near bottom

1.3 ANTENNA INFORMATION

Antenna Type	<input checked="" type="checkbox"/> PIFA <input type="checkbox"/> PCB <input type="checkbox"/> Dipole <input type="checkbox"/> Coils					
Antenna Gain	Brand	P/N	Type	Cable length	Peak Gain	Worst case
	HongBo	290-10569	PIFA	300mm	3.74dBi	V
	1. Power Directional Gain: 3.74					
	2. Power Density Directional Gain: 3.74					
	Other antenna information:					
	Brand	P/N	Type	Cable length	Peak Gain	
HongBo	290-10310	PIFA	500mm	2.85dBi		
Walsin	RFMTA401032IMLB702	PIFA	320mm	3.16dBi		
Walsin	RFMTA401080IMLB701	PIFA	800mm	1.85dBi		
Walsin	RFMTA401082IMLB701	PIFA	820mm	1.72dBi		

Notes:

1. Power Directional Gain: $10\text{LOG}(((10^{Ant1/10})+10^{Ant2/10})/2)$
2. Power Density Directional Gain: $10\text{LOG}(((10^{Ant1/10})+10^{Ant2/10})/2))+10\text{log}(NTX/NSS)$

1.4 MEASUREMENT UNCERTAINTY

PARAMETER	UNCERTAINTY
AC Powerline Conducted Emission	+/- 1.2575
Emission bandwidth, 20dB bandwidth	+/- 1.4003
RF output power, conducted	+/- 1.1372
Power density, conducted	+/- 1.4003
3M Semi Anechoic Chamber / 30M~200M	+/- 4.0138
3M Semi Anechoic Chamber / 200M~1000M	+/- 3.9483
3M Semi Anechoic Chamber / 1G~8G	+/- 2.5975
3M Semi Anechoic Chamber / 8G~18G	+/- 2.6112
3M Semi Anechoic Chamber / 18G~26G	+/- 2.7389
3M Semi Anechoic Chamber / 26G~40G	+/- 2.9683
3M Semi Anechoic Chamber / 40G~60G	+/- 1.8509
3M Semi Anechoic Chamber / 60G~75G	+/- 1.9869
3M Semi Anechoic Chamber / 75G~110G	+/- 2.9651
3M Semi Anechoic Chamber / 110G~170G	+/- 2.7807
3M Semi Anechoic Chamber / 170G~220G	+/- 3.6437
3M Semi Anechoic Chamber / 220G~325G	+/- 4.2982

Remark:

1. This uncertainty represents an expanded uncertainty expressed at approximately the 95% confidence level using a coverage factor of $k=2$
2. ISO/IEC 17025 requires that an estimate of the measurement uncertainties associated with the emissions test results be included in the report.

1.5 FACILITIES AND TEST LOCATION

All measurement facilities used to collect the measurement data are located at
No.11, Wugong 6th Rd., Wugu Dist., New Taipei City 24891, Taiwan. (R.O.C.)

Test site	Test Engineer	Remark
AC Conduction Room	Eric Lee	
Radiation	Kevin Kuo	
RF Conducted	Eric Lee	

Remark: The sites are constructed in conformance with the requirements of ANSI C63.7, ANSI C63.4 and CISPR Publication 22.

1.6 INSTRUMENT CALIBRATION

RF Conducted Test Site					
Equipment	Manufacturer	Model	S/N	Cal Date	Cal Due
Power Meter	Anritsu	ML2495A	1033009	04/11/2017	04/10/2018
Power Sensor	Anritsu	MA2411B	917072	07/03/2017	07/02/2018
Spectrum Analyzer	R&S	FSV 40	101073	10/02/2017	10/01/2018
Thermostatic/Hrgrosatic Chamber	GWINSTEK	GTC-288MH-CC	TH160402	05/23/2017	05/22/2018

3M 966 Chamber Test Site					
Equipment	Manufacturer	Model	S/N	Cal Date	Cal Due
Bilog Antenna	Sunol Sciences	JB3	A030105	06/20/2017	06/19/2018
Horn Antenna	EMCO	3117	00055165	02/20/2017	02/19/2018
Horn Antenna	ETS LINDGREN	3116	00026370	01/12/2017	01/11/2018
K Type Cable	Huber+Suhner	SUCOFLEX 102	29406/2	01/10/2017	01/09/2018
K Type Cable	Huber+Suhner	SUCOFLEX 102	22470/2	01/10/2017	01/09/2018
Pre-Amplifier	MITEQ	AMF-6F-260400-40-8P	985646	01/10/2017	01/09/2018
Pre-Amplifier	EMCI	EMC 012635	980151	08/01/2017	07/31/2018
Pre-Amplifier	EMEC	EM01M26G	60570	08/01/2017	07/31/2018
Pre-Amplifier	EMEC	EM330	060609	06/07/2017	06/06/2018
Spectrum Analyzer	Agilent	E4446A	US42510252	11/27/2017	11/26/2018
Loop Ant	COM-POWER	AL-130	121051	03/02/2017	03/01/2018
Antenna Tower	CCS	CC-A-1F	N/A	N.C.R	N.C.R
Controller	CCS	CC-C-1F	N/A	N.C.R	N.C.R
Turn Table	CCS	CC-T-1F	N/A	N.C.R	N.C.R
Wideband Radio Communication Tester	R&S	CMW 500	116875	04/25/2017	04/24/2018

AC Conducted Emissions Test Site					
Equipment	Manufacturer	Model	S/N	Cal Date	Cal Due
LISN	R&S	ENV216	101054	05/18/2017	05/17/2018
LISN	SCHWARZBECK	NSLK 8127	8127-541	02/14/2017	02/13/2018
EMI Test Receiver	R&S	ESCI	100064	05/17/2017	05/16/2018

Remark: Each piece of equipment is scheduled for calibration once a year.

1.7 SUPPORT AND EUT ACCESSORIES EQUIPMENT

EUT Accessories Equipment					
No.	Equipment	Brand	Model	Series No.	FCC ID
	N/A				

Support Equipment					
No.	Equipment	Brand	Model	Series No.	FCC ID
1	NB(H)	Acer	Aspire 4320 series	N/A	QDS-BRCM1018

1.8 Test methodology and applied standards

The test methodology, setups and results comply with all requirements in accordance with ANSI C63.10:2013, FCC Part 2, FCC Part 15.247, KDB 558074 D01 v04, RSS-247 Issue 2 and RSS-GEN Issue 4

2. TEST SUMMERY

FCC Standard Section	IC Standard Section	Report Section	Test Item	Result
15.203	-	1.2	Antenna Requirement	Pass
15.207(a)	RSS-GEN 8.8	4.1	AC Conducted Emission	Pass
15.247(a)(2)	RSS-247(5.2)(a)	4.2	6 dB Bandwidth	Pass
-	RSS-GEN 6.6	4.2	Occupied Bandwidth (99%)	Pass
15.247(b)	RSS-247(5.4)(d)	4.3	Output Power Measurement	Pass
15.247(e)	RSS-247(5.2)(b)	4.4	Power Spectral Density	Pass
15.247(d)	RSS-247(5.5)	4.5	Conducted Band Edge	Pass
15.247(d)	RSS-247(5.5)	4.5	Conducted Emission	Pass
15.247(d)	RSS-GEN 8.9, 8.10	4.6	Radiation Band Edge	Pass
15.247(d)	RSS-GEN 8.9, 8.10	4.6	Radiation Spurious Emission	Pass

3. DESCRIPTION OF TEST MODES

3.1 THE WORST MODE OF OPERATING CONDITION

Operation mode	BT4.0 Mode (1Mbps)
Test Channel Frequencies	1.Lowest Channel : 2402MHz 2.Middle Channel : 2440MHz 3.Highest Channel : 2480MHz

Remark:

1. EUT pre-scanned data rate of output power for each mode, the worst data rate were recorded in this report.

.

3.2 THE WORST MODE OF MEASUREMENT

AC Power Line Conducted Emission	
Test Condition	AC Power line conducted emission for line and neutral
Voltage/Hz	5V
Test Mode	Mode 1:EUT power by Host System
Worst Mode	<input checked="" type="checkbox"/> Mode 1 <input type="checkbox"/> Mode 2 <input type="checkbox"/> Mode 3 <input type="checkbox"/> Mode 4

Radiated Emission Measurement Above 1G	
Test Condition	Band edge, Emission for Unwanted and Fundamental
Voltage/Hz	5V
Test Mode	Mode 1:EUT power by Host System
Worst Mode	<input checked="" type="checkbox"/> Mode 1 <input type="checkbox"/> Mode 2 <input type="checkbox"/> Mode 3 <input type="checkbox"/> Mode 4
Worst Position	<input type="checkbox"/> Placed in fixed position. <input type="checkbox"/> Placed in fixed position at X-Plane (E2-Plane) <input type="checkbox"/> Placed in fixed position at Y-Plane (E1-Plane) <input checked="" type="checkbox"/> Placed in fixed position at Z-Plane (H-Plane)
Worst Polarity	<input type="checkbox"/> Horizontal <input checked="" type="checkbox"/> Vertical

Radiated Emission Measurement Below 1G	
Test Condition	Radiated Emission Below 1G
Voltage/Hz	5V
Test Mode	Mode 1:EUT power by Host System
Worst Mode	<input checked="" type="checkbox"/> Mode 1 <input type="checkbox"/> Mode 2 <input type="checkbox"/> Mode 3 <input type="checkbox"/> Mode 4

Remark:

1. The worst mode was record in this test report.
2. EUT pre-scanned in three axis, X, Y, Z and two polarity, Horizontal and Vertical for radiated measurement. The worst case (Z-Plane and Vertical) were recorded in this report
3. For below 1G, AC power line conducted emission and radiation emission were performed the EUT transmit at the highest output power channel as worse case.

3.3 EUT DUTY CYCLE

Duty Cycle				
Configuration	TX ON (ms)	TX ALL (ms)	Duty Cycle (%)	Duty Factor(dB)
BLE	0.4800	0.6500	73.85%	1.32

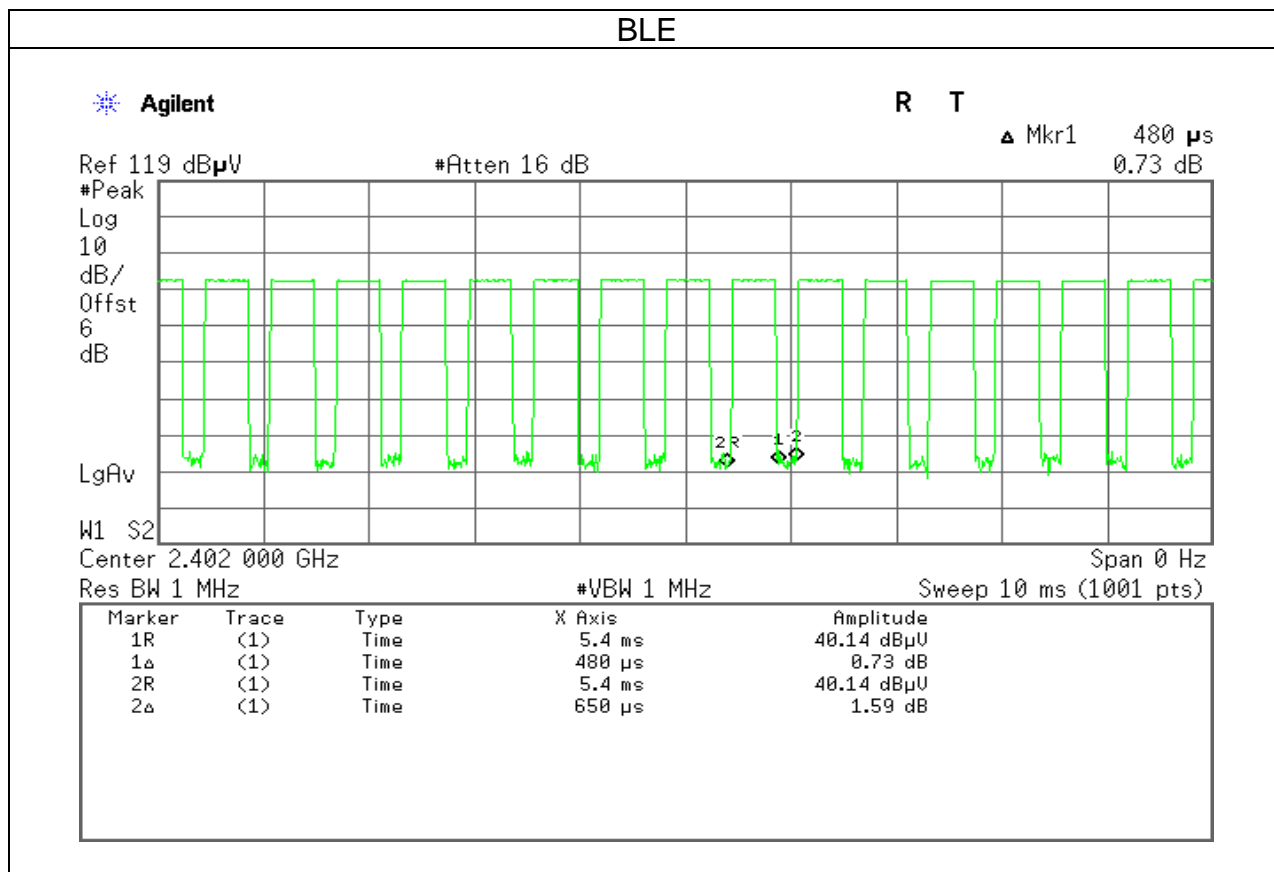

4. TEST RESULT

4.1 AC POWER LINE CONDUCTED EMISSION

4.1.1 Test Limit

According to §15.207(a) and RSS-GEN section 8.8,

Frequency Range (MHz)	Limits(dBμV)	
	Quasi-peak	Average
0.15 to 0.50	66 to 56*	56 to 46*
0.50 to 5	56	46
5 to 30	60	50

* Decreases with the logarithm of the frequency.

4.1.2 Test Procedure

Test method Refer as ANSI 63.10:2013 clause 6.2,

1. The EUT was placed on a non-conducted table, which is 0.8m above horizontal ground plane and 0.4m above vertical ground plane.
2. EUT connected to the line impedance stabilization network (LISN)
3. Receiver set RBW of 9kHz and Detector Peak, and note as quasi-peak and average.
4. Maximum procedure was performed on the six highest emissions to ensure EUT compliance.
5. Recorded Line for Neutral and Line.

4.1.3 Test Setup

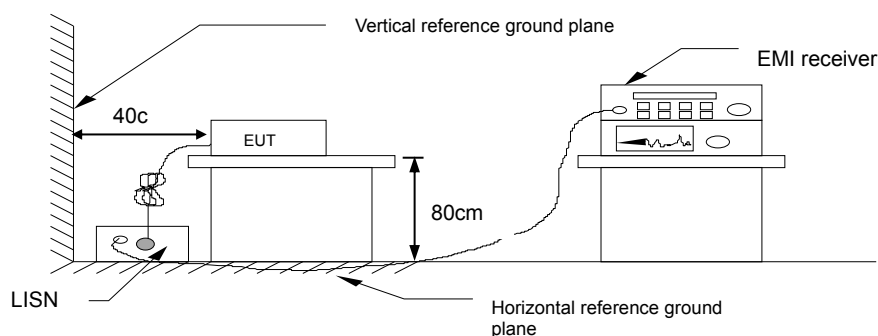

4.1.4 Test Result

Pass

Test Data

Test Mode:	Mode 1	Temp/Hum	24.5(°C)/ 52.1%RH
Test Voltage:	120Vac / 60Hz	Test Date	November 30, 2017
Phase:	Line	Test Engineer	Eric Lee

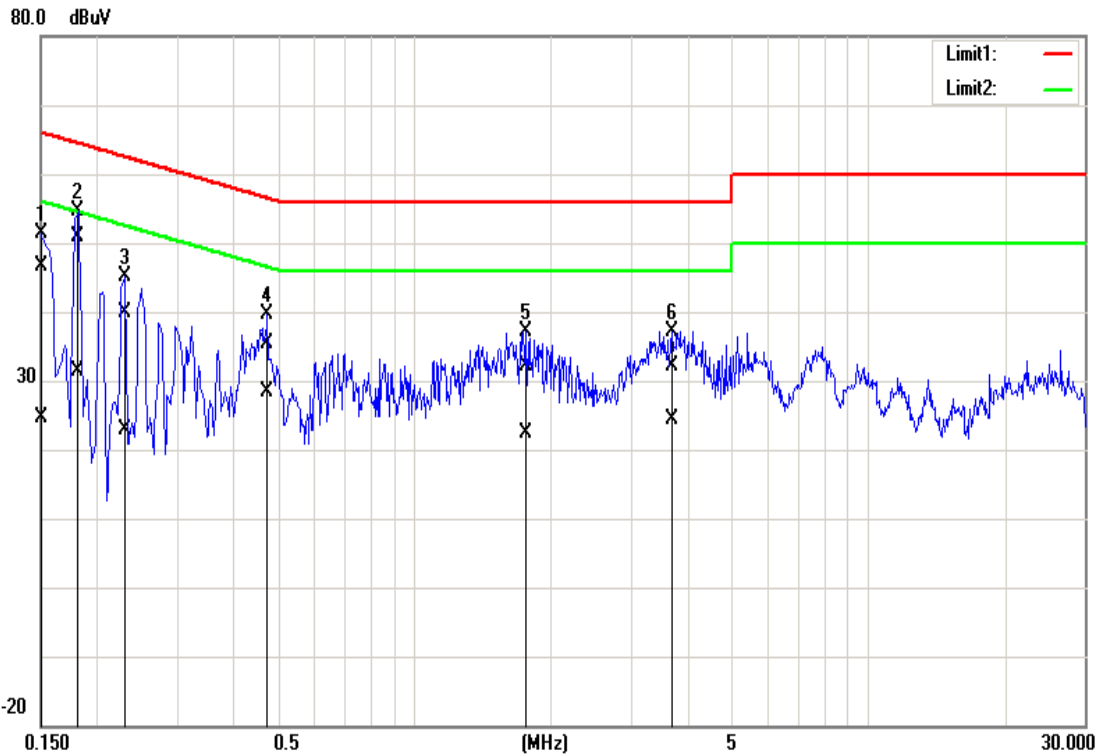

Frequency (MHz)	Quasi Peak reading (dBuV)	Average reading (dBuV)	Correction factor (dB)	Quasi Peak result (dBuV)	Average result (dBuV)	Quasi Peak limit (dBuV)	Average limit (dBuV)	Quasi Peak margin (dB)	Average margin (dB)	Remark
0.1500	46.67	24.58	0.08	46.75	24.66	66.00	56.00	-19.25	-31.34	Pass
0.1820	50.67	31.37	0.09	50.76	31.46	64.39	54.39	-13.63	-22.93	Pass
0.2300	39.89	22.89	0.09	39.98	22.98	62.45	52.45	-22.47	-29.47	Pass
0.4740	35.26	28.39	0.10	35.36	28.49	56.44	46.44	-21.08	-17.95	Pass
1.7700	31.86	22.27	0.16	32.02	22.43	56.00	46.00	-23.98	-23.57	Pass
3.7020	31.99	24.15	0.22	32.21	24.37	56.00	46.00	-23.79	-21.63	Pass

Test Mode:	Mode 1	Temp/Hum	24.5(°C)/ 52.1%RH
Test Voltage:	120Vac / 60Hz	Test Date	November 30, 2017
Phase:	Neutral	Test Engineer	Eric Lee

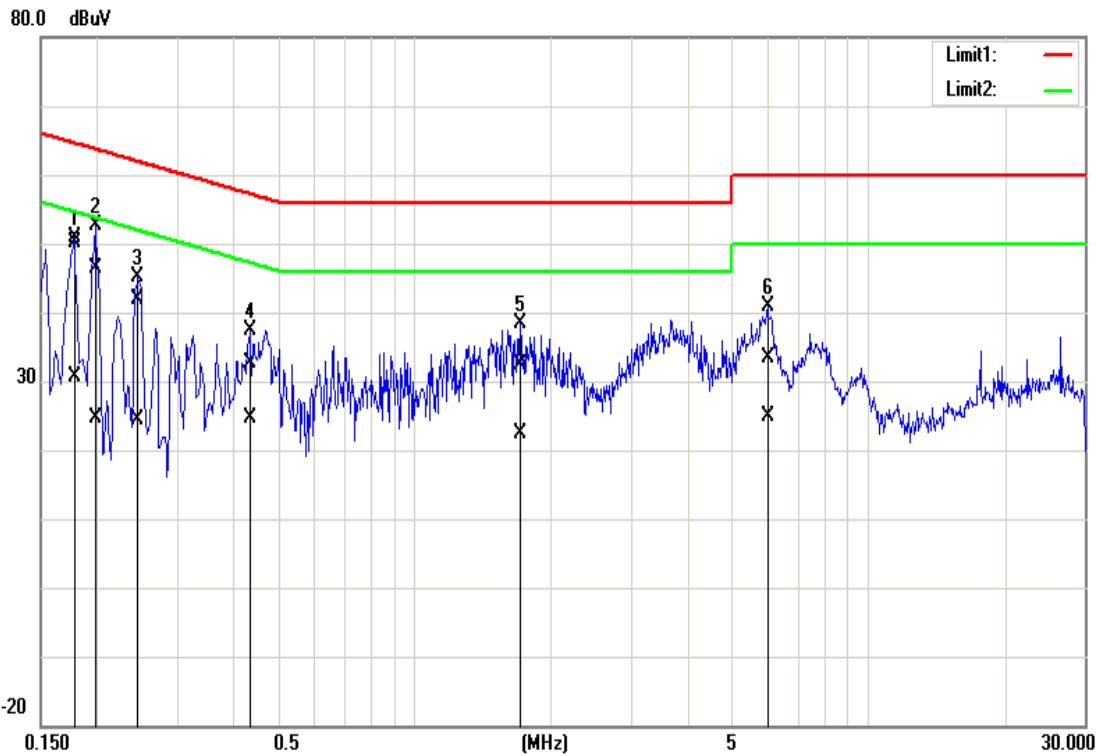

Frequency (MHz)	Quasi Peak reading (dBuV)	Average reading (dBu)	Correction factor (dB)	Quasi Peak result (dBuV)	Average result (dBuV)	Quasi Peak limit (dBuV)	Average limit (dBuV)	Quasi Peak margin (dB)	Average margin (dB)	Remark
0.1780	50.05	30.43	0.16	50.21	30.59	64.57	54.58	-14.36	-23.99	Pass
0.1980	46.25	24.43	0.16	46.41	24.59	63.69	53.69	-17.28	-29.10	Pass
0.2460	41.66	24.15	0.16	41.82	24.31	61.89	51.89	-20.07	-27.58	Pass
0.4340	32.43	24.52	0.18	32.61	24.70	57.18	47.18	-24.57	-22.48	Pass
1.7100	32.18	22.20	0.23	32.41	22.43	56.00	46.00	-23.59	-23.57	Pass
6.0180	32.94	24.63	0.37	33.31	25.00	60.00	50.00	-26.69	-25.00	Pass

4.2 6DB BANDWIDTH AND OCCUPIED BANDWIDTH(99%)

4.2.1 Test Limit

According to §15.247(a)(2) and RSS-247 section 5.2(a)

6 dB Bandwidth :

Limit	Shall be at least 500kHz
-------	--------------------------

Occupied Bandwidth(99%) : For reporting purposes only.

4.2.2 Test Procedure

Test method Refer as KDB 558074 D01 v04, section 8.1 and ANSI 63.10:2013 clause 6.9.2 & 6.9.3.

1. The EUT RF output connected to the spectrum analyzer by RF cable.
2. Setting maximum power transmit of EUT
3. SA set RBW = 100kHz, VBW = 300kHz and Detector = Peak, to measurement 6 dB Bandwidth and 99% Bandwidth.
4. Measure and record the result of 6 dB Bandwidth and 99% Bandwidth. in the test report.

4.2.3 Test Setup

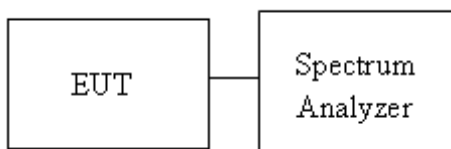

4.2.4 Test Result

Test mode: BLE mode / 2402-2480 MHz				
Channel	Frequency (MHz)	OBW(99%) (MHz)	6dB BW (MHz)	6dB limit (kHz)
Low	2402	1.0549	0.6739	>500
Mid	2440	1.0549	0.6782	
High	2480	1.0549	0.6826	

Test Data

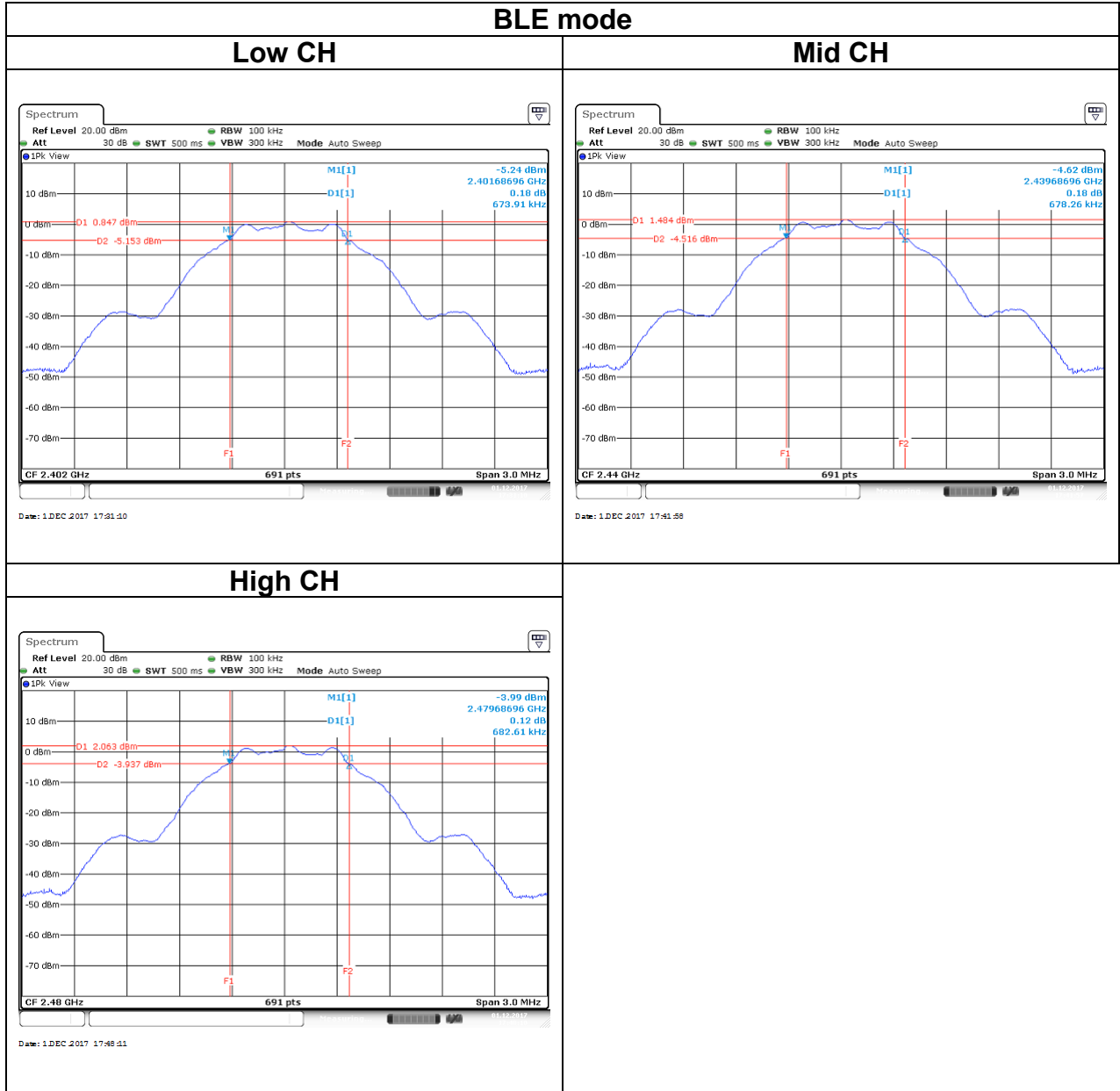

4.3 OUTPUT POWER MEASUREMENT

4.3.1 Test Limit

According to §15.247(b) and RSS-247 section 5.4(d)

Peak output power :

For systems using digital modulation in the 2400-2483.5 MHz, and 5725-5850 MHz bands: 1 Watt(30 dBm), base on the use of antennas with directional gain not exceed 6 dBi If transmitting antennas of directional gain greater than 6dBi are used the peak output power the conducted output power from the intentional radiator shall be reduced by the amount in dB that the directional gain of the antenna exceeds 6 dBi. In case of point-to-point operation, the limit has to be reduced by 1dB for every 3 dB that the directional gain of the antenna exceeds 6 dBi.

Limit	<input checked="" type="checkbox"/> Antenna not exceed 6 dBi : 30dBm <input type="checkbox"/> Antenna with DG greater than 6 dBi [Limit = 30 – (DG – 6)] <input type="checkbox"/> Point-to-point operation
-------	---

Average output power : For reporting purposes only.

4.3.2 Test Procedure

Test method Refer as KDB 558074 D01 v04, section 9.1.2.

1. The EUT RF output connected to the power meter by RF cable.
2. Setting maximum power transmit of EUT.
3. The path loss was compensated to the results for each measurement.
4. Measure and record the result of Peak output power and Average output power. in the test report.

4.3.3 Test Setup

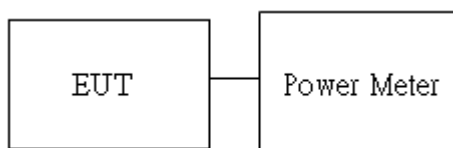

4.3.4 Test Result

Peak output power :

BLE Mode								
Config.	CH	Freq. (MHz)	PK Power (dBm)	ERP PK Power (dBm)	PK Power (W)	ERP PK Power (W)	FCC/IC Limit (dBm)	FCC/IC Limit (dBm)
BLE Data rate: 1Mbps	0	2402	2.96	6.70	0.0020	0.0047	30	36
	19	2440	3.35	7.09	0.0022	0.0051		
	39	2480	3.86	7.60	0.0024	0.0058		

Average output power :

BLE Mode			
Config.	CH	Freq. (MHz)	AV Power (dBm)
BLE Data rate: 1Mbps	0	2402	0.75
	19	2440	1.13
	39	2480	1.73

4.4 POWER SPECTRAL DENSITY

4.4.1 Test Limit

According to §15.247(e) and RSS-247 section 5.2(b)

For digitally modulated systems, the power spectral density conducted from the intentional radiator to the antenna shall not be greater than 8 dBm in any 3 kHz band during any time interval of continuous transmission.

Limit	<input checked="" type="checkbox"/> Antenna not exceed 6 dBi : 8dBm <input type="checkbox"/> Antenna with DG greater than 6 dBi [Limit = 8 – (DG – 6)] <input type="checkbox"/> Point-to-point operation :
-------	---

4.4.2 Test Procedure

Test method Refer as KDB 558074 D01 v04, Section 10.2

1. The EUT RF output connected to the spectrum analyzer by RF cable.
2. Setting maximum power transmit of EUT
3. SA set RBW = 3kHz, VBW = 30kHz, Span = 1.5 times DTS Bandwidth (6 dB BW), Detector = Peak, Sweep Time = Auto and Trace = Max hold.
4. The path loss and Duty Factor were compensated to the results for each measurement by SA.
5. Mark the maximum level.
6. Measure and record the result of power spectral density. in the test report.

4.4.3 Test Setup

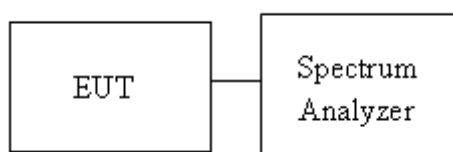

4.4.4 Test Result

Test mode: BLE mode / 2402-2480 MHz			
Channel	Frequency (MHz)	PSD (dBm)	IC/FCC limit (dBm)
Low	2402	-12.88	8
Mid	2440	-12.39	
High	2480	-11.91	

Test Data

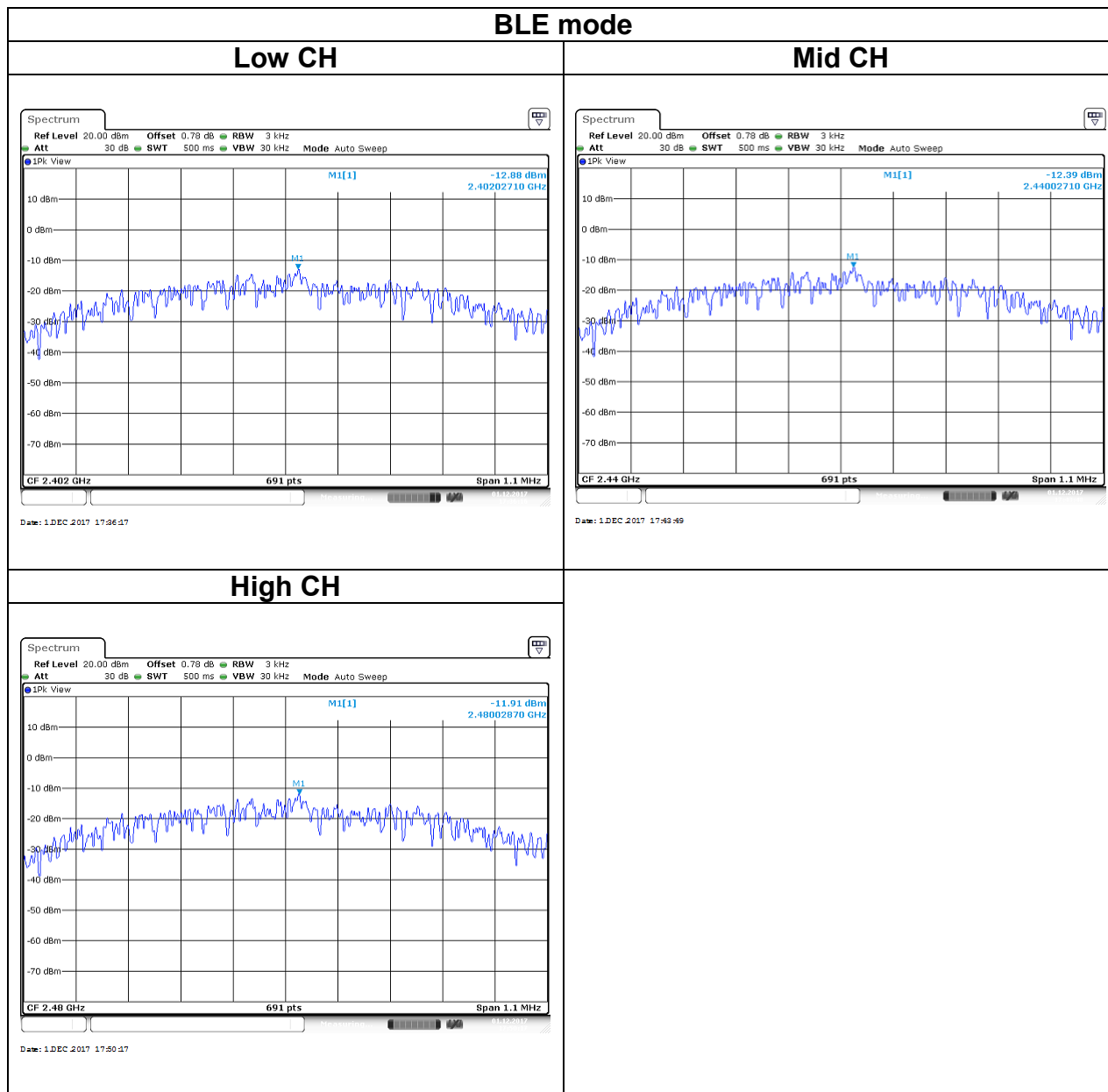

4.5 CONDUCTED BAND EDGE AND SPURIOUS EMISSION

4.5.1 Test Limit

According to §15.247(d) and RSS-247 section 5.5

In any 100 kHz bandwidth outside the authorized frequency band,

Non-restricted bands shall be attenuated at least 20 dB/30 dB relative to the maximum PSD level in 100 kHz by RF conducted or a radiated measurement which fall in the restricted bands, as defined in §15.205(a), must also comply with the radiated emission limits specified in §15.209(a).

4.5.2 Test Procedure

Test method Refer as KDB 558074 D01 v04, Section 11.

1. EUT RF output port connected to the SA by RF cable, and the path loss was compensated to result.
2. SA setting, RBW=100kHz, VBW=300kHz, Detector=Peak, Trace mode = max hold, SWT = Auto.
3. In any 100 kHz bandwidth outside the authorized frequency band, shall be attenuated at least 20 dB relative to the maximum in-band peak PSD level in 100 kHz when conducted power procedure is used. If the transmitter complies with the conducted power limits based on the use of RMS averaging over a time interval, the attenuation required under this paragraph shall be 30 dB instead of 20 dB.

4.5.3 Test Setup

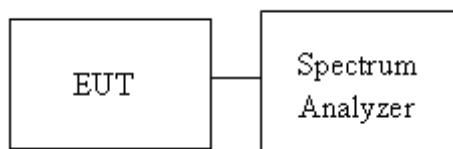

4.5.4 Test Result

Test Data

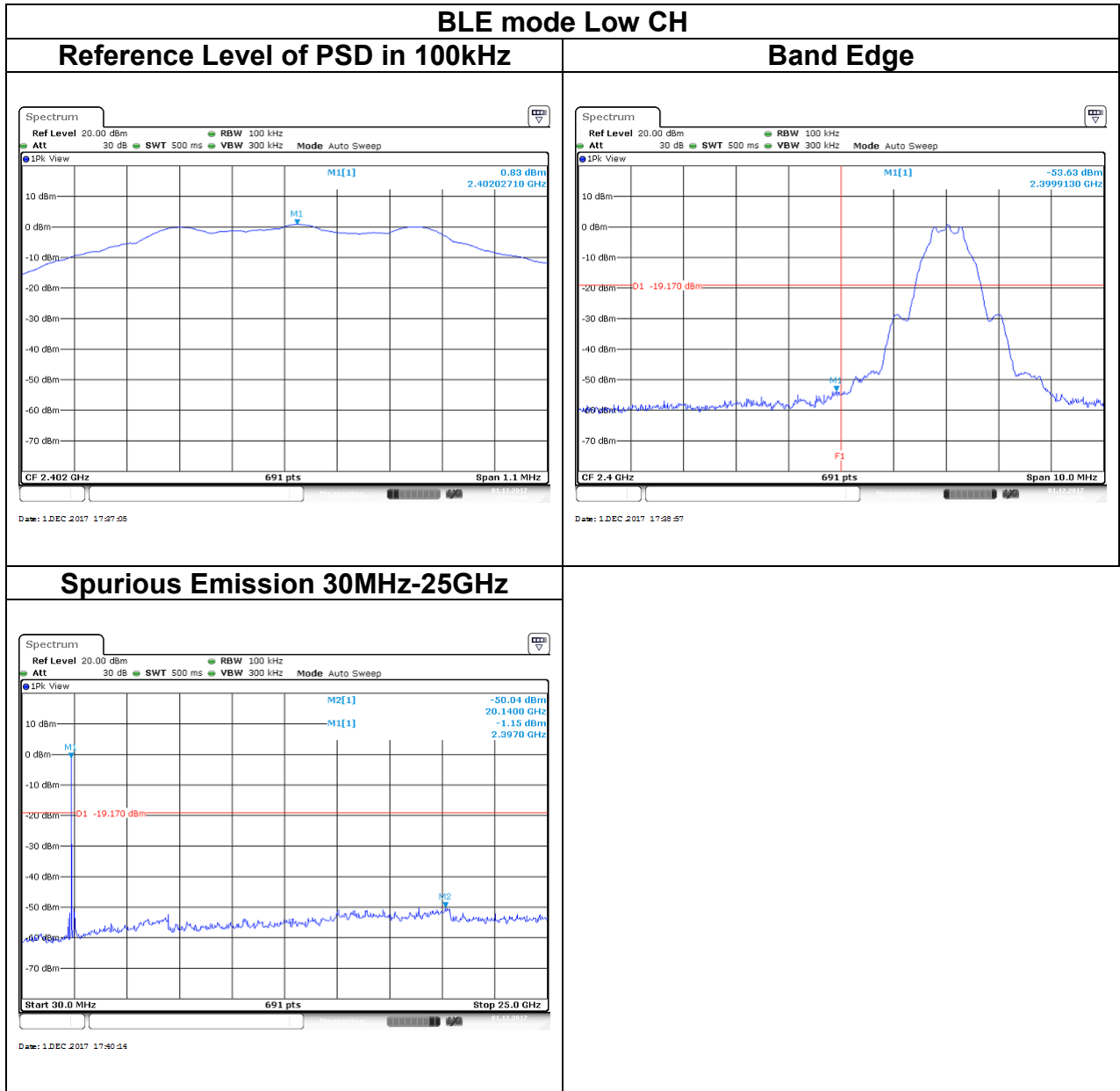

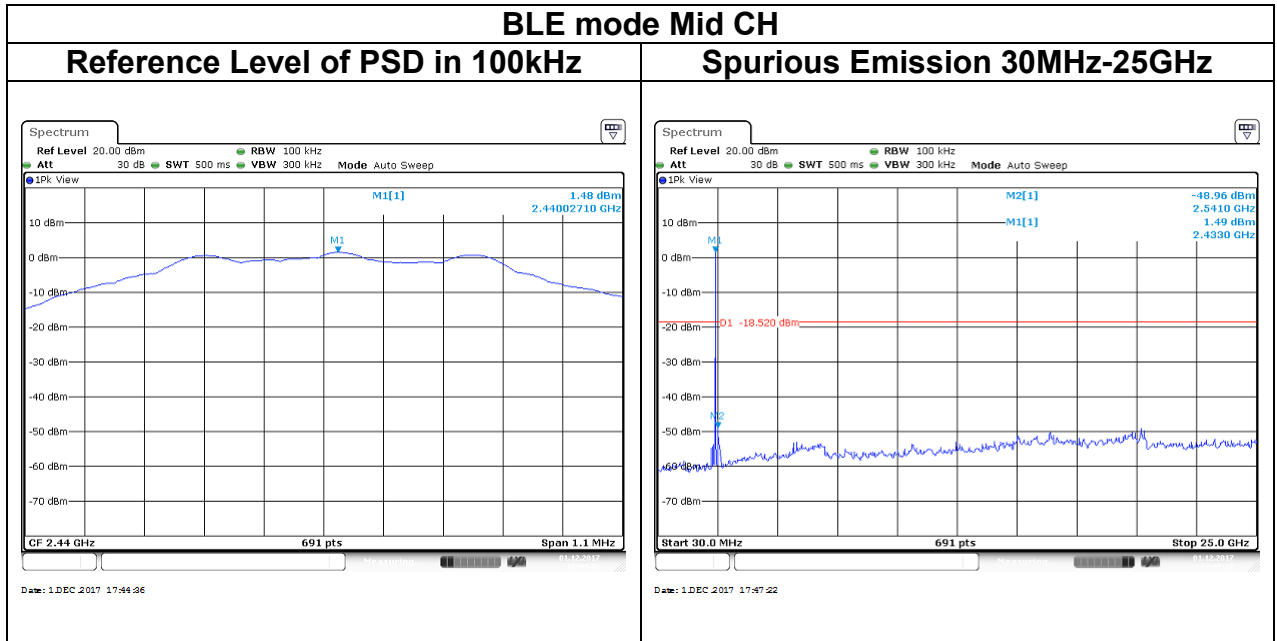

BLE mode High CH

Reference Level of PSD in 100kHz

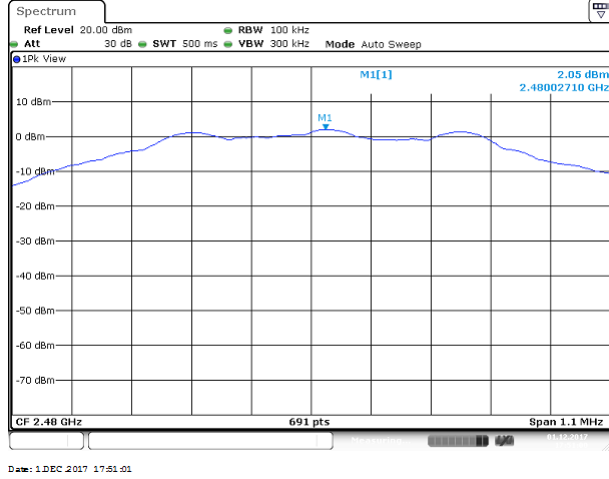

Band Edge

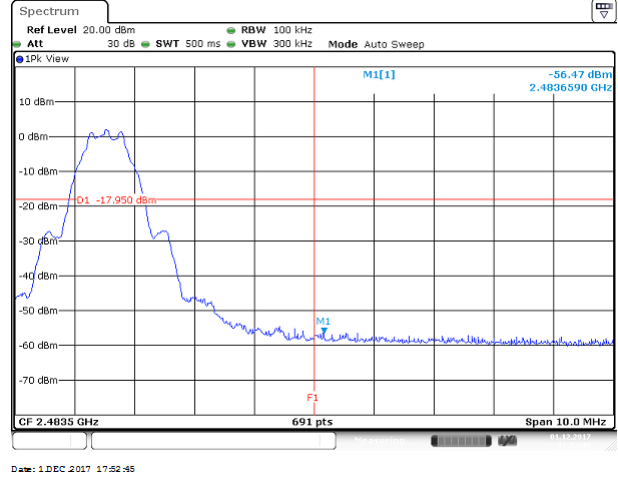

Spurious Emission 30MHz-25GHz

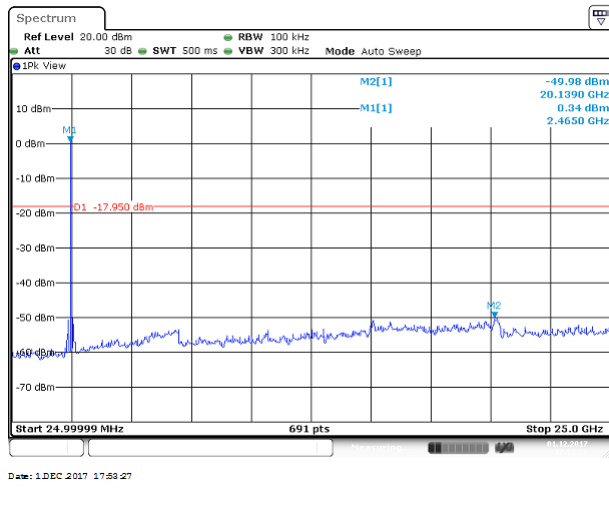

4.6 RADIATION BANDEGE AND SPURIOUS EMISSION

4.6.1 Test Limit

FCC according to §15.247(d), §15.209 and §15.205,

IC according to RSS-247 section 5.5, RSS-Gen, Section 8.9 and 8.10

In any 100 kHz bandwidth outside the authorized frequency band, all harmonic and spurious must be least 20 dB below the highest emission level with the authorized frequency band. Radiation emission which fall in the restricted bands must also follow the FCC section 15.209 as below limit in table.

Below 30 MHz

Frequency	Field Strength (microvolts/m)	Magnetic H-Field (microamperes/m)	Measurement Distance (metres)
9-490 kHz	2,400/F (F in kHz)	2,400/F (F in kHz)	300
490-1,705 kHz	24,000/F (F in kHz)	24,000/F (F in kHz)	30
1.705-30 MHz	30	N/A	30

Above 30 MHz

Frequency (MHz)	Field Strength microvolts/m at 3 metres (watts, e.i.r.p.)	
	Transmitters	Receivers
30-88	100 (3 nW)	100 (3 nW)
88-216	150 (6.8 nW)	150 (6.8 nW)
216-960	200 (12 nW)	200 (12 nW)
Above 960	500 (75 nW)	500 (75 nW)

Remark:

Although these tests were performed other than open area test site, adequate comparison measurements were confirmed against 30 m open are test site. Therefore sufficient tests were made to demonstrate that the alternative site produces results that correlate with the ones of tests made in an open field based on KDB 937606.

4.6.2 Test Procedure

Test method Refer as KDB 558074 D01 v04, Section 12.1.

1. The EUT is placed on a turntable, Above 1 GHz is 1.5m and below 1 GHz is 0.8m above ground plane. The EUT Configured un accordance with ANSI C63.10, and the EUT set in a continuous mode.
2. The turntable shall be rotated for 360 degrees to determine the position of maximum emission level. And EUT is set 3m away from the receiving antenna, which is scanned from 1m to 4m above the ground plane to find out the highest emissions. Measurement are made polarized in both the vertical and the horizontal positions with antenna.
3. Span shall wide enough to full capture the emission measured. The SA from 30MHz to 26.5GHz set to the low, Mid and High channels with the EUT transmit.

Remark:

Although these tests were performed other than open area test site, adequate comparison measurements were confirmed against 30 m open are test site. Therefore sufficient tests were made to demonstrate that the alternative site produces results that correlate with the ones of tests made in an open field based on KDB 937606.

4. The SA setting following :

- (1) Below 1G : RBW = 100kHz, VBW \geq 3 RBW, Sweep = Auto, Detector = Peak, Trace = Max hold.
- (2) Above 1G :
 - (2.1) For Peak measurement : RBW = 1MHz, VBW \geq 3 RBW, Sweep = Auto, Detector = Peak, Trace = Max hold.
 - (2.2) For Average measurement : RBW = 1MHz, VBW
 - If Duty Cycle \geq 98%, VBW=10Hz.
 - If Duty Cycle < 98%, VBW=1/T.

Configuration	Duty Cycle (%)	T(ms)	1/T (kHz)	VBW Setting
BLE	74%	0.4800	2.083	2.2K

4.6.3 Test Setup

9kHz ~ 30MHz

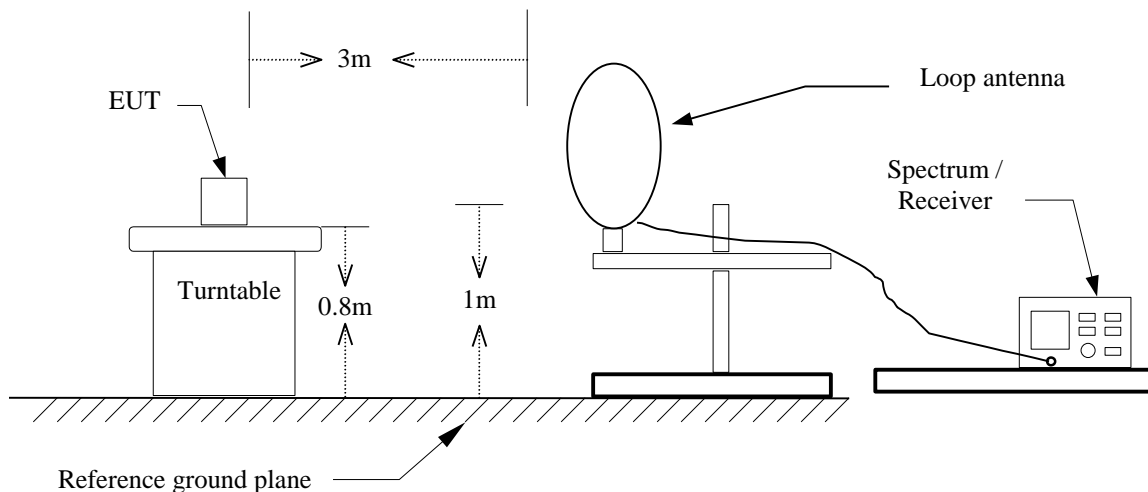

30MHz ~ 1GHz

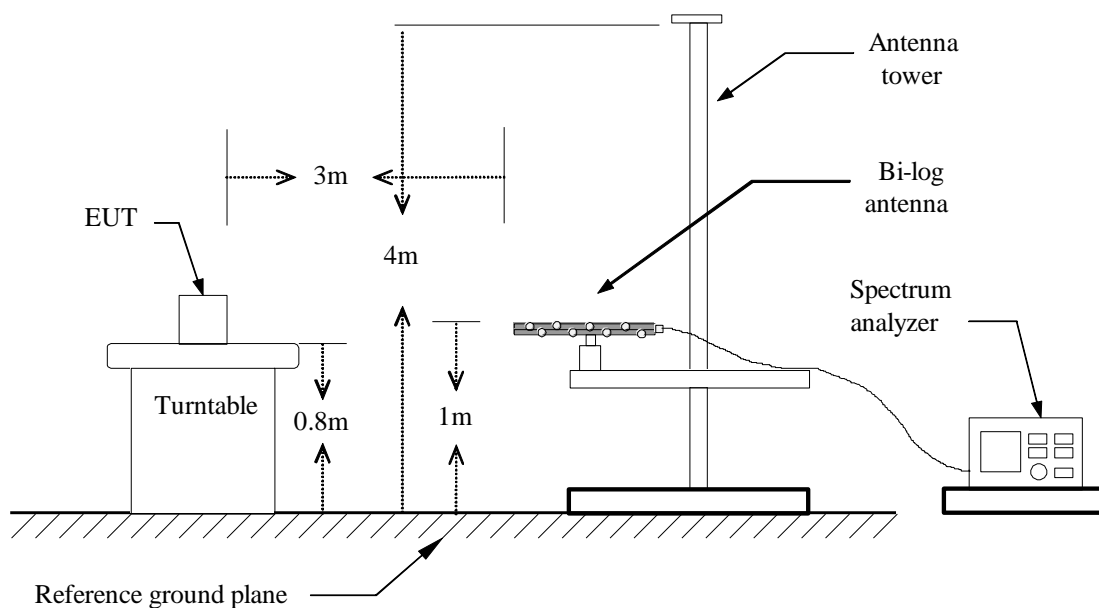

Above 1 GHz

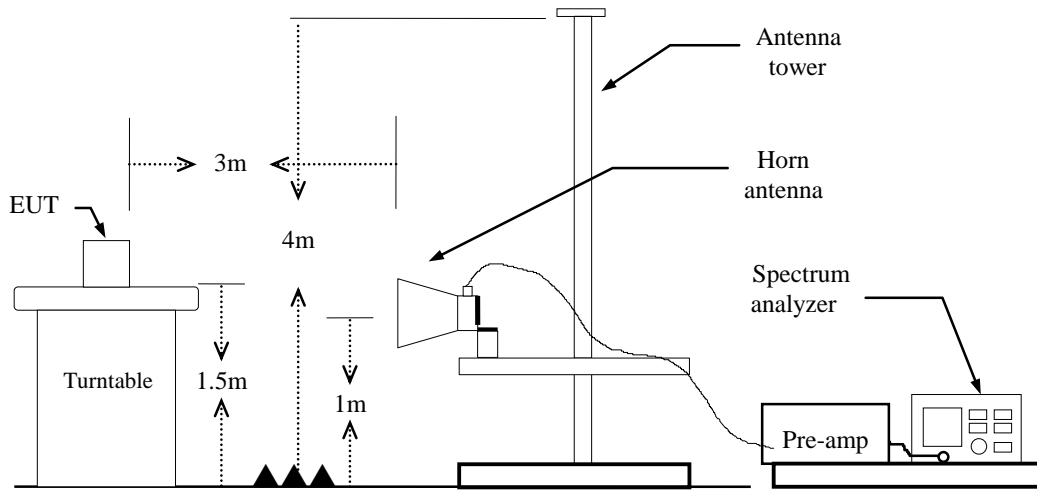

4.6.4 Test Result

Band Edge Test Data

Test Mode:	BLE Low CH	Temp/Hum	24(°C)/ 33%RH
Test Item	Band Edge	Test Date	December 2, 2017
Polarize	Vertical	Test Engineer	Kevin Kuo
Detector	Peak	Test Voltage:	120Vac / 60Hz

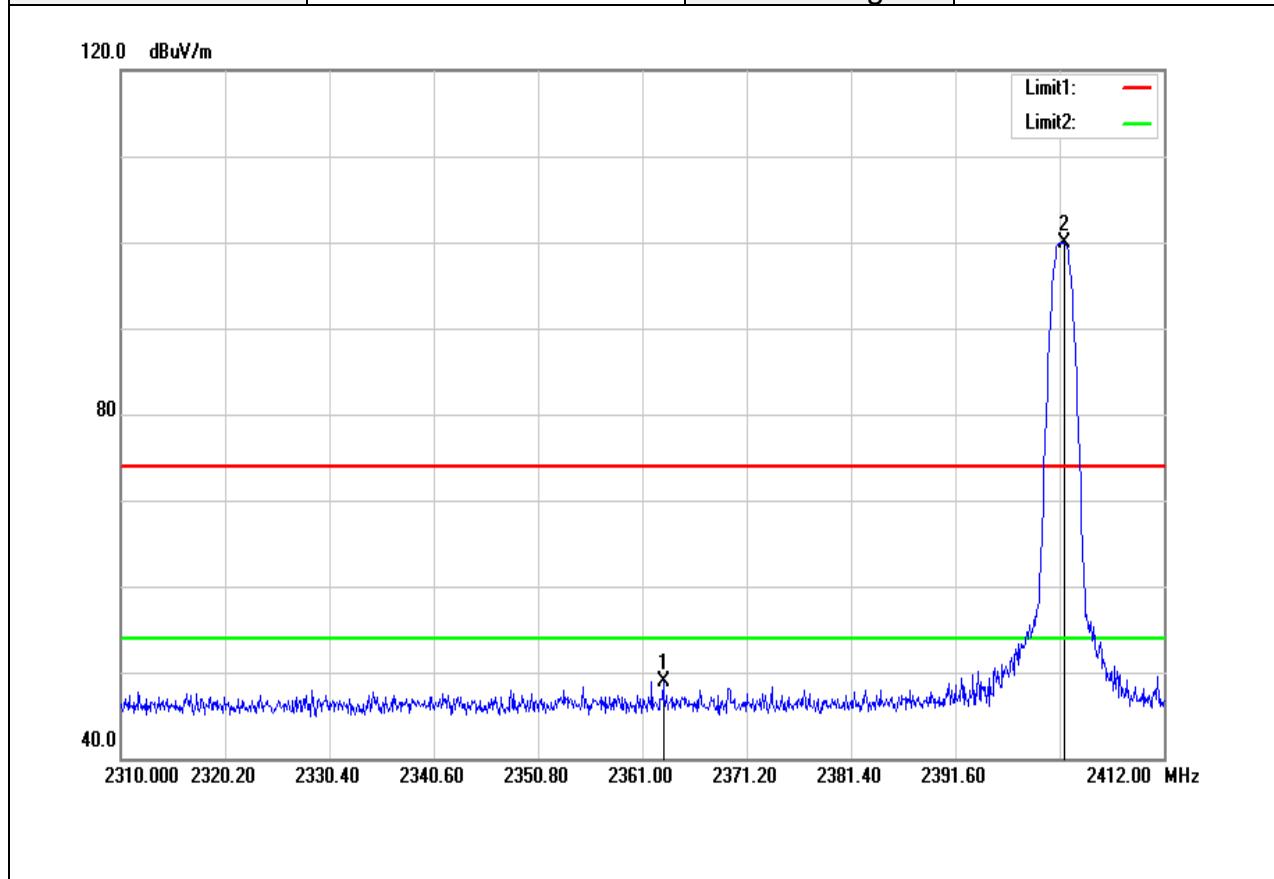

No.	Frequency (MHz)	Reading (dBuV)	Correct Factor(dB/m)	Result (dBuV/m)	Limit (dBuV/m)	Margin (dB)	Remark
1	2363.040	52.03	-3.07	48.96	74.00	-25.04	peak
2	2402.310	102.86	-2.95	99.91	-	-	peak

Test Mode:	BLE Low CH	Temp/Hum	24(C)/ 33%RH
Test Item	Band Edge	Test Date	December 2, 2017
Polarize	Vertical	Test Engineer	Kevin Kuo
Detector	Average	Test Voltage:	120Vac / 60Hz

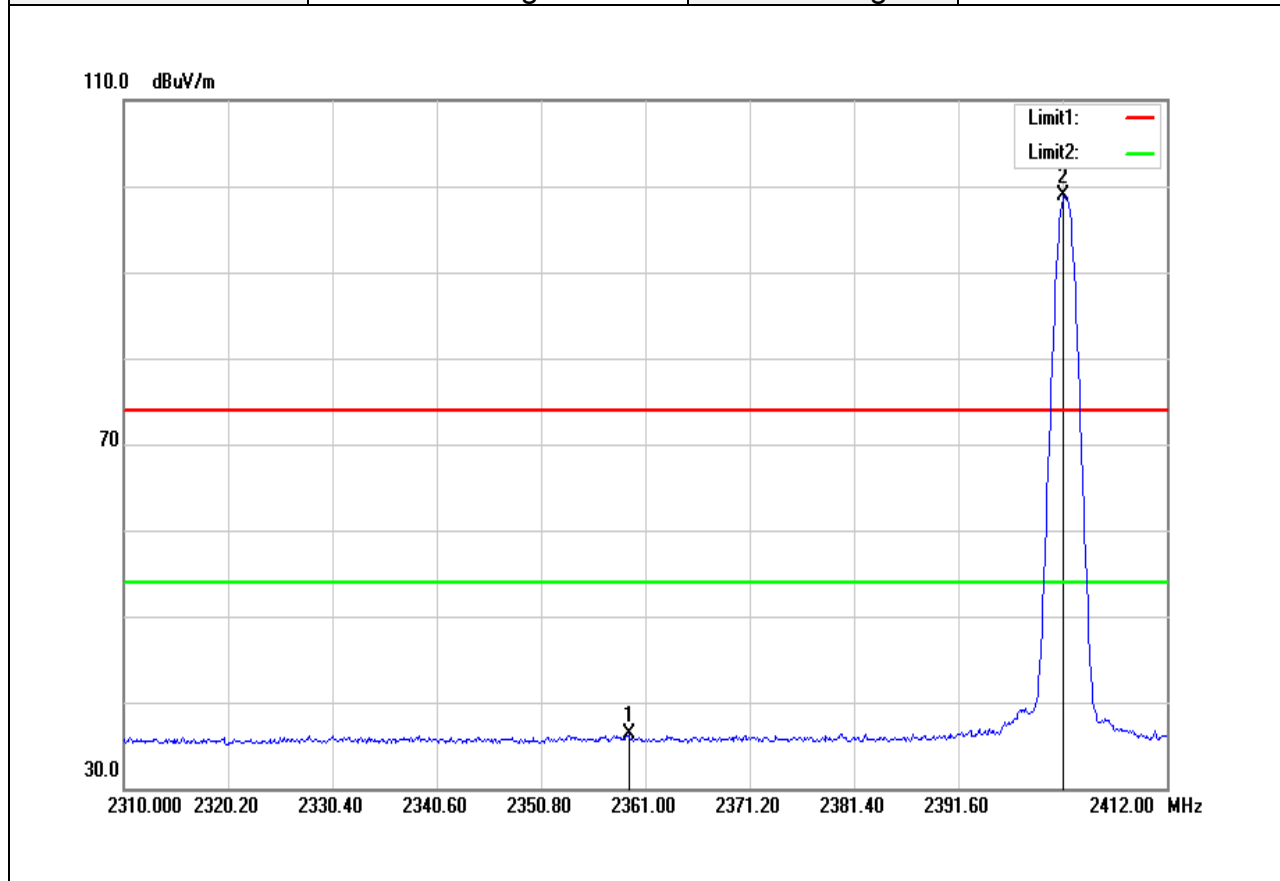

No.	Frequency (MHz)	Reading (dBuV)	Correct Factor(dB/m)	Result (dBuV/m)	Limit (dBuV/m)	Margin (dB)	Remark
1	2359.368	39.42	-3.08	36.34	54.00	-17.66	AVG
2	2401.902	101.80	-2.95	98.85	-	-	AVG

Test Mode:	BLE High CH	Temp/Hum	24(°C)/ 33%RH
Test Item	Band Edge	Test Date	December 2, 2017
Polarize	Vertical	Test Engineer	Kevin Kuo
Detector	Peak	Test Voltage:	120Vac / 60Hz

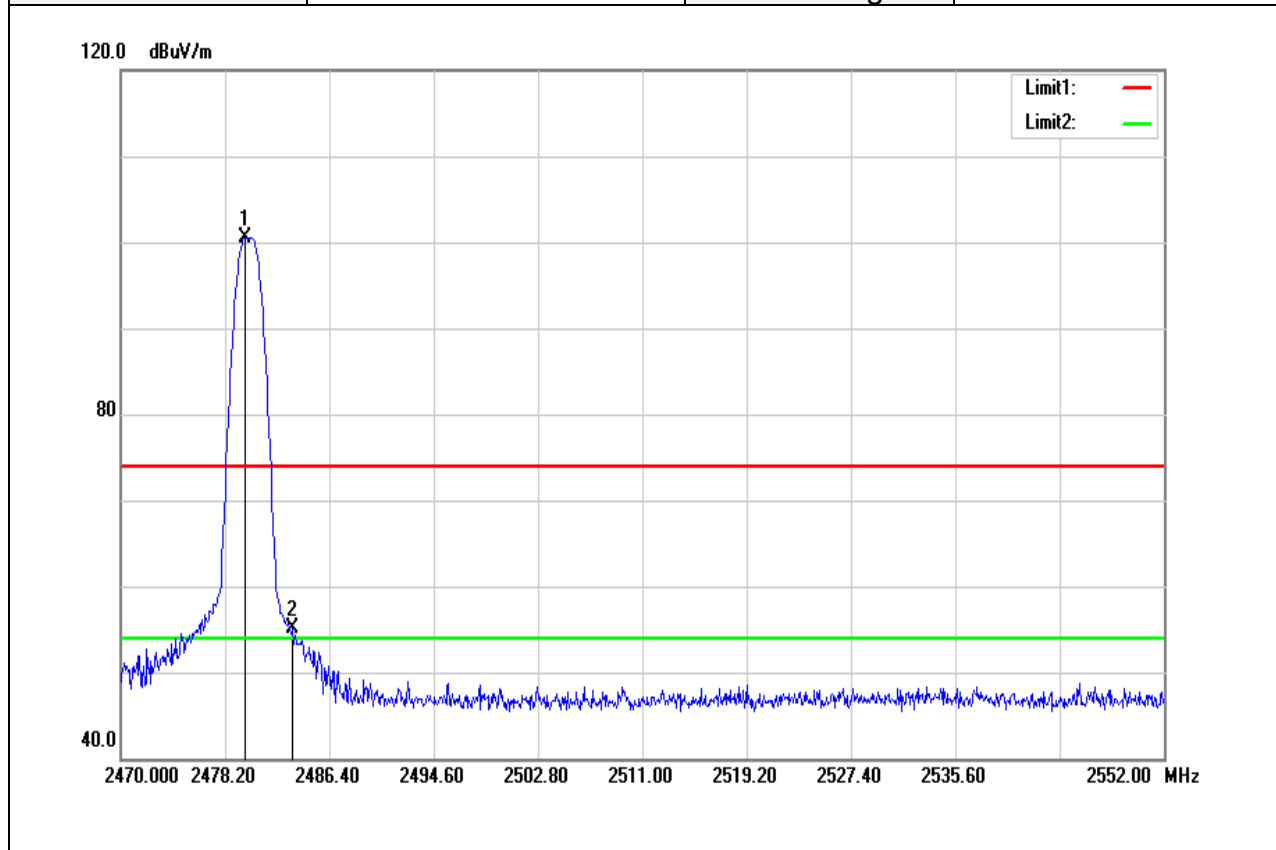

No.	Frequency (MHz)	Reading (dBuV)	Correct Factor(dB/m)	Result (dBuV/m)	Limit (dBuV/m)	Margin (dB)	Remark
1	2479.758	103.21	-2.70	100.51	-	-	peak
2	2483.500	57.82	-2.69	55.13	74.00	-18.87	peak

Test Mode:	BLE High CH	Temp/Hum	24(°C)/ 33%RH
Test Item	Band Edge	Test Date	December 2, 2017
Polarize	Vertical	Test Engineer	Kevin Kuo
Detector	Average	Test Voltage:	120Vac / 60Hz

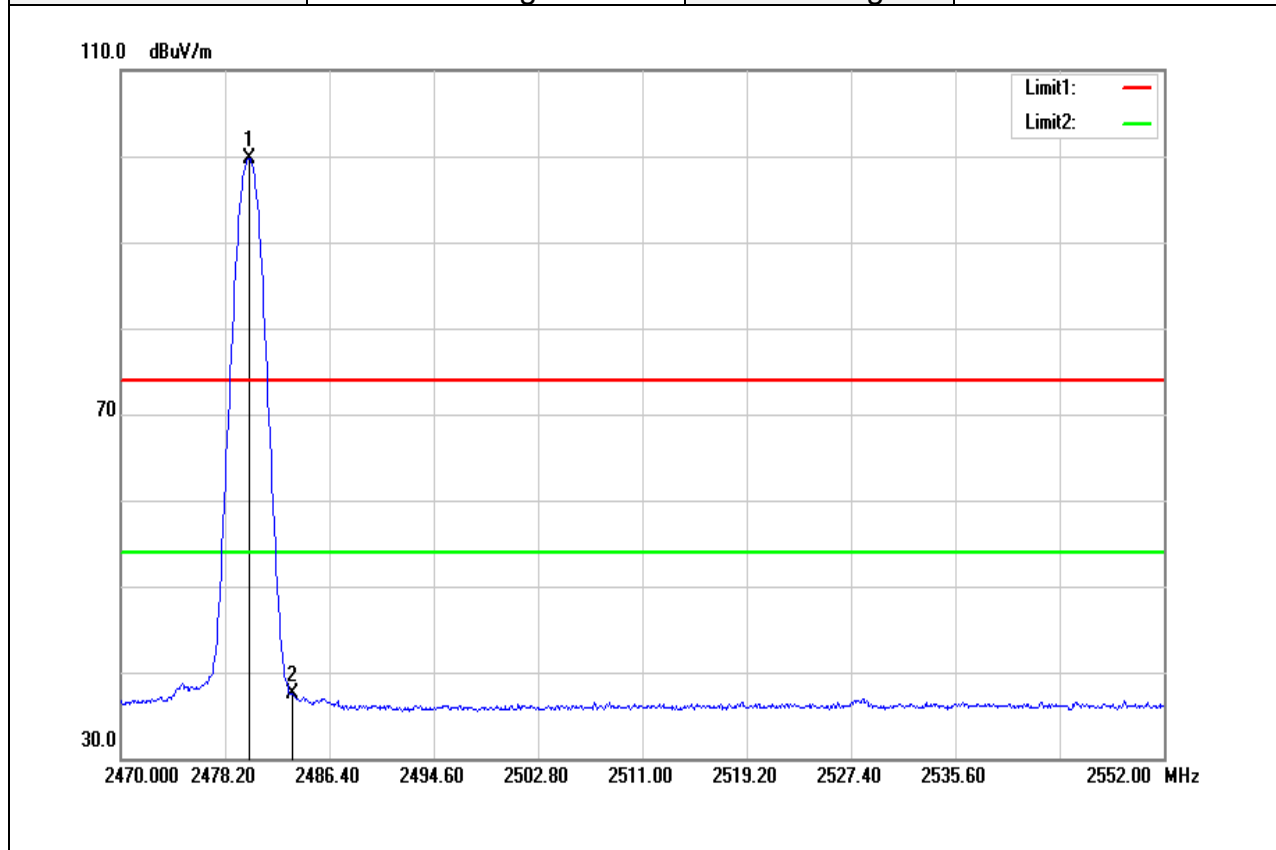

No.	Frequency (MHz)	Reading (dBuV)	Correct Factor(dB/m)	Result (dBuV/m)	Limit (dBuV/m)	Margin (dB)	Remark
1	2480.086	102.37	-2.70	99.67	-	-	AVG
2	2483.500	40.11	-2.69	37.42	54.00	-16.58	AVG

Above 1G Test Data

Test Mode:	BLE Low CH	Temp/Hum	24(°C)/ 33%RH
Test Item	Harmonic	Test Date	December 2, 2017
Polarize	Vertical	Test Engineer	Kevin Kuo
Detector	Peak and Average	Test Voltage:	120Vac / 60Hz

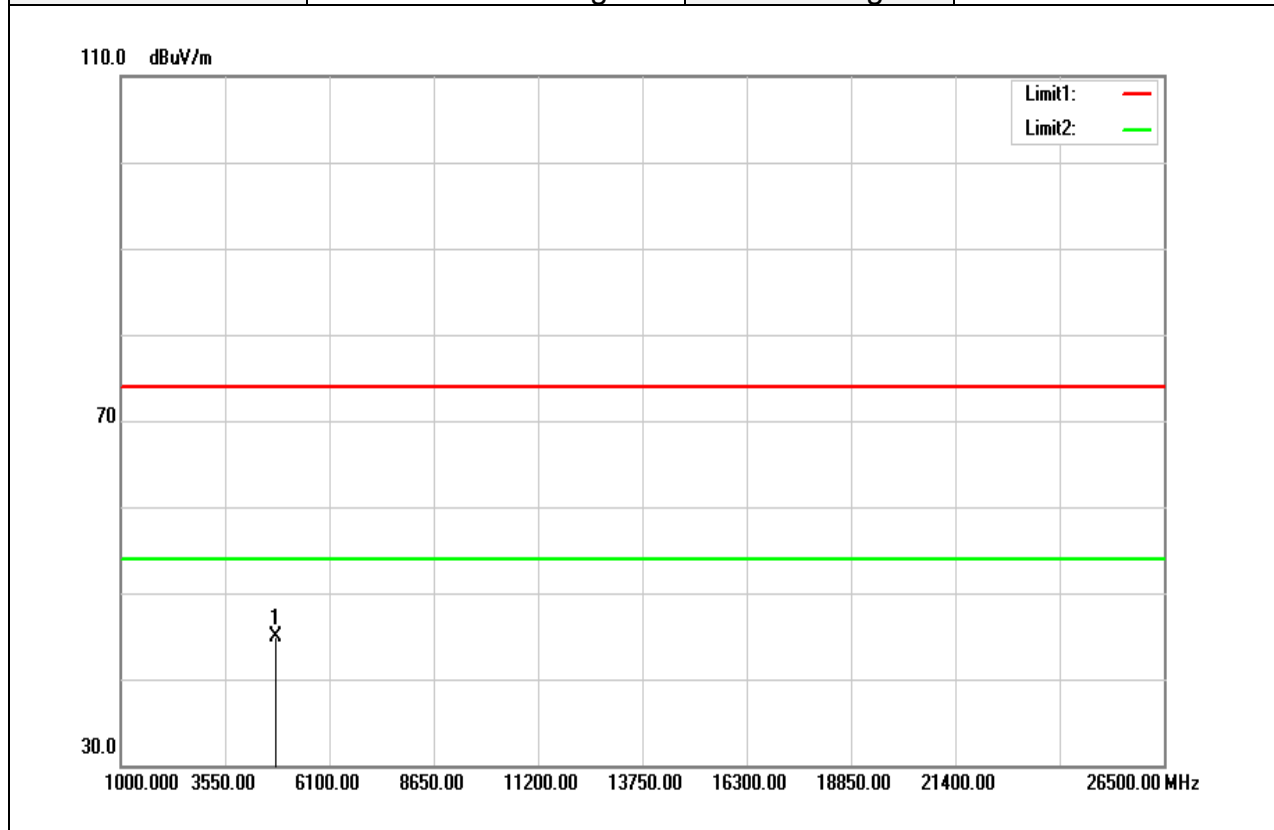

Frequency (MHz)	Reading (dBuV)	Correct Factor (dB/m)	Result (dBuV/m)	Limit (dBuV/m)	Margin (dB)	Remark
4806.000	40.51	4.35	44.86	74.00	-29.14	peak
N/A						

Remark:

1. Measuring frequencies from 1 GHz to the 10th harmonic of highest fundamental frequency.
2. For above 1GHz, the EUT peak value was under average limit, therefore the Average value compliance with the average limit

Test Mode:	BLE Low CH	Temp/Hum	24(°C)/ 33%RH
Test Item	Harmonic	Test Date	December 2, 2017
Polarize	Horizontal	Test Engineer	Kevin Kuo
Detector	Peak and Average	Test Voltage:	120Vac / 60Hz

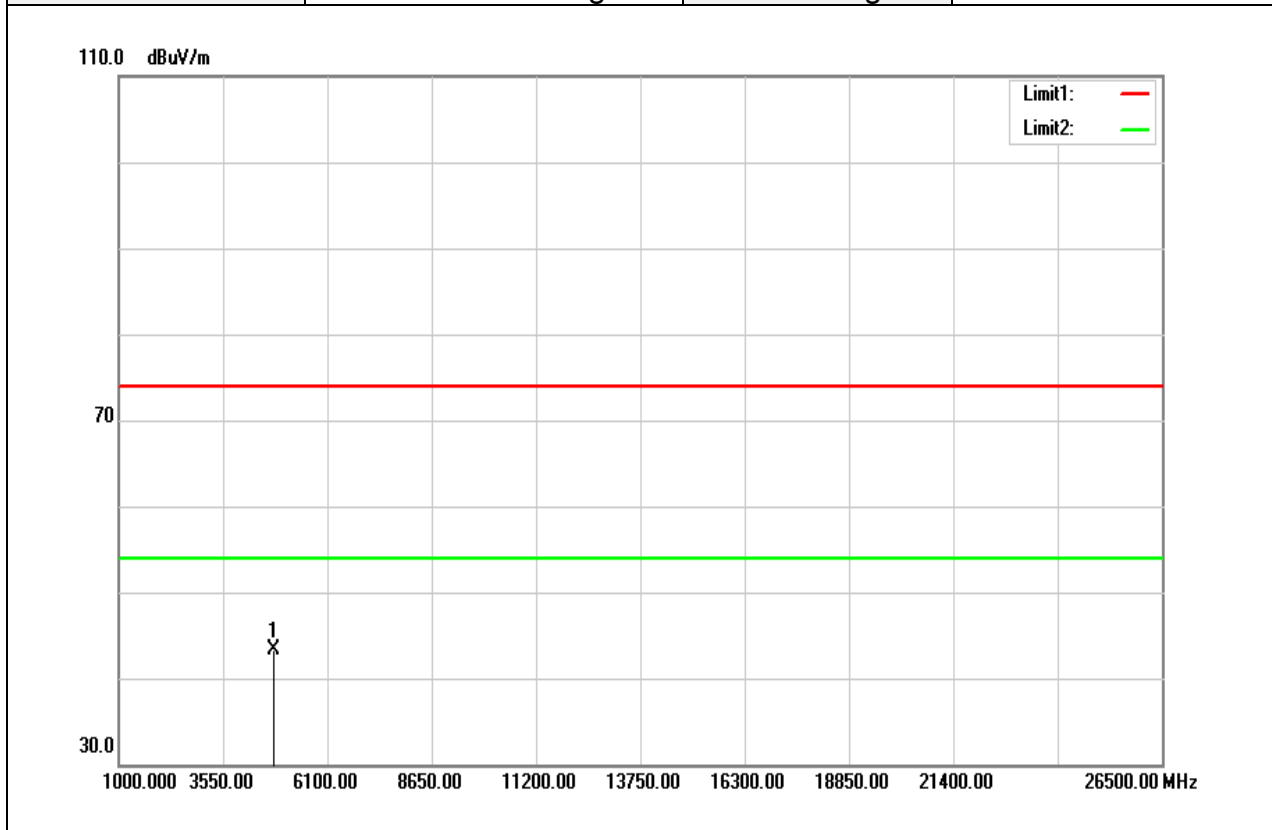

Frequency (MHz)	Reading (dBuV)	Correct Factor (dB/m)	Result (dBuV/m)	Limit (dBuV/m)	Margin (dB)	Remark
4806.000	38.89	4.34	43.23	74.00	-30.76	peak
N/A						

Remark:

1. Measuring frequencies from 1 GHz to the 10th harmonic of highest fundamental frequency.
2. For above 1GHz, the EUT peak value was under average limit, therefore the Average value compliance with the average limit

Test Mode:	BLE Mid CH	Temp/Hum	24(°C)/ 33%RH
Test Item	Harmonic	Test Date	December 2, 2017
Polarize	Vertical	Test Engineer	Kevin Kuo
Detector	Peak and Average	Test Voltage:	120Vac / 60Hz

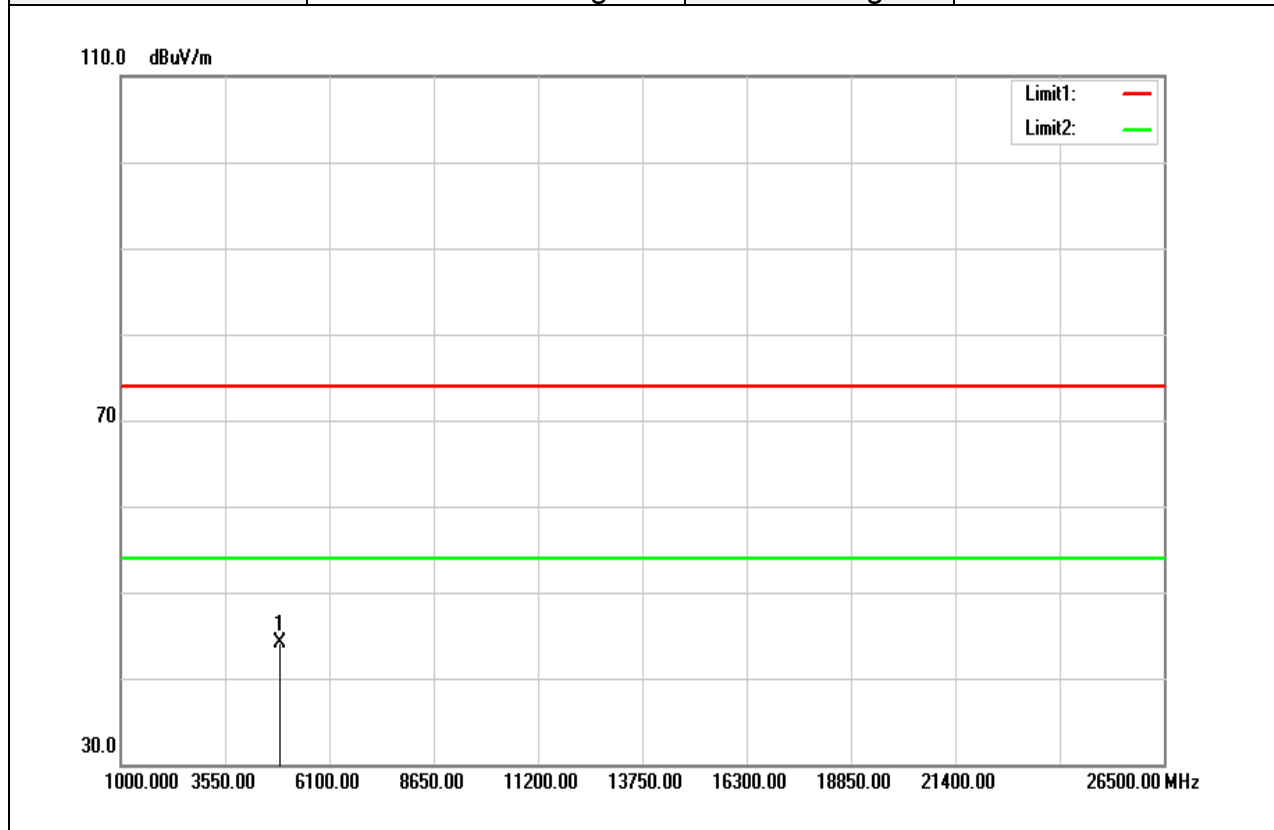

Frequency (MHz)	Reading (dBuV)	Correct Factor (dB/m)	Result (dBuV/m)	Limit (dBuV/m)	Margin (dB)	Remark
4880.000	39.56	4.48	44.04	74.00	-29.96	peak
N/A						

Remark:

1. Measuring frequencies from 1 GHz to the 10th harmonic of highest fundamental frequency.
2. For above 1GHz, the EUT peak value was under average limit, therefore the Average value compliance with the average limit

Test Mode:	BLE Mid CH	Temp/Hum	24(°C)/ 33%RH
Test Item	Harmonic	Test Date	December 2, 2017
Polarize	Horizontal	Test Engineer	Kevin Kuo
Detector	Peak and Average	Test Voltage:	120Vac / 60Hz

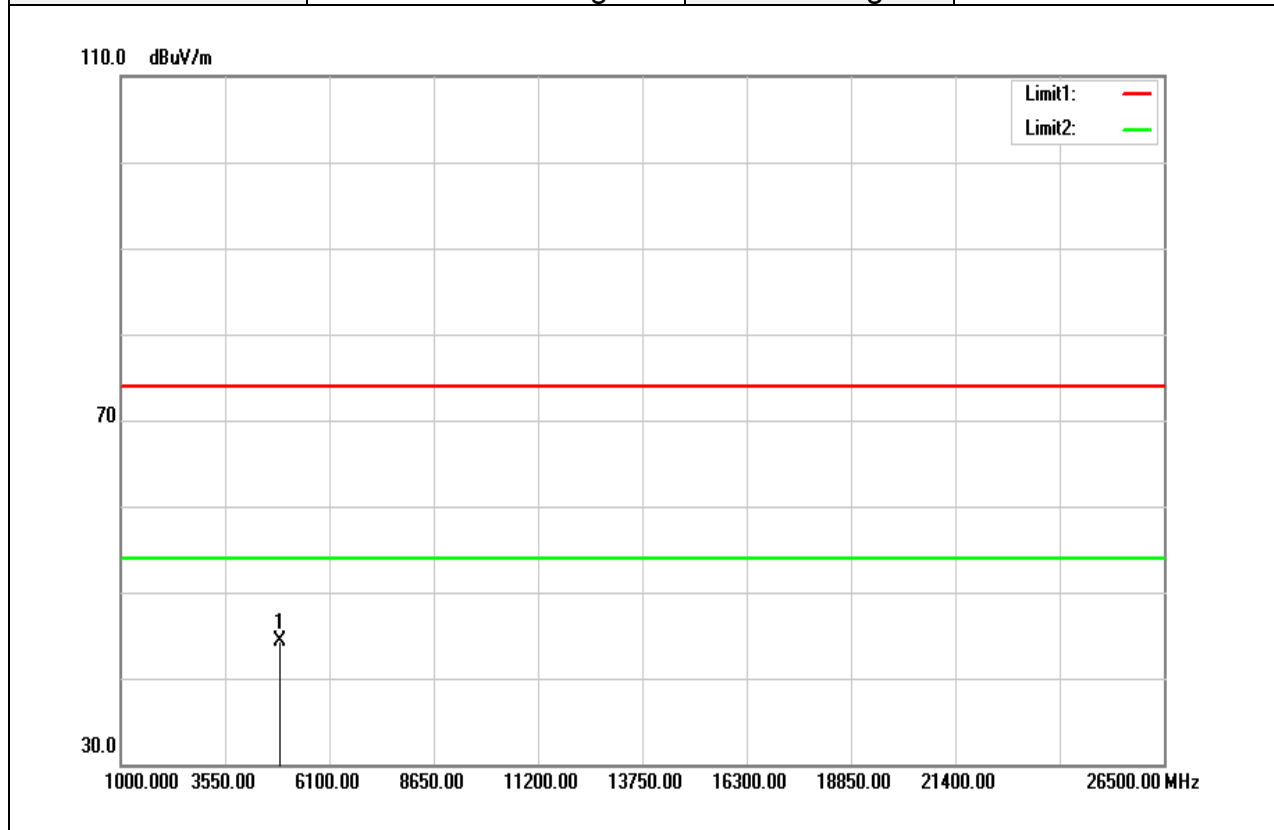

Frequency (MHz)	Reading (dBuV)	Correct Factor (dB/m)	Result (dBuV/m)	Limit (dBuV/m)	Margin (dB)	Remark
4880.000	39.82	4.48	44.30	74.00	-29.70	peak
N/A						

Remark:

1. Measuring frequencies from 1 GHz to the 10th harmonic of highest fundamental frequency.
2. For above 1GHz, the EUT peak value was under average limit, therefore the Average value compliance with the average limit

Test Mode:	BLE High CH	Temp/Hum	24(°C)/ 33%RH
Test Item	Harmonic	Test Date	December 2, 2017
Polarize	Vertical	Test Engineer	Kevin Kuo
Detector	Peak and Average	Test Voltage:	120Vac / 60Hz

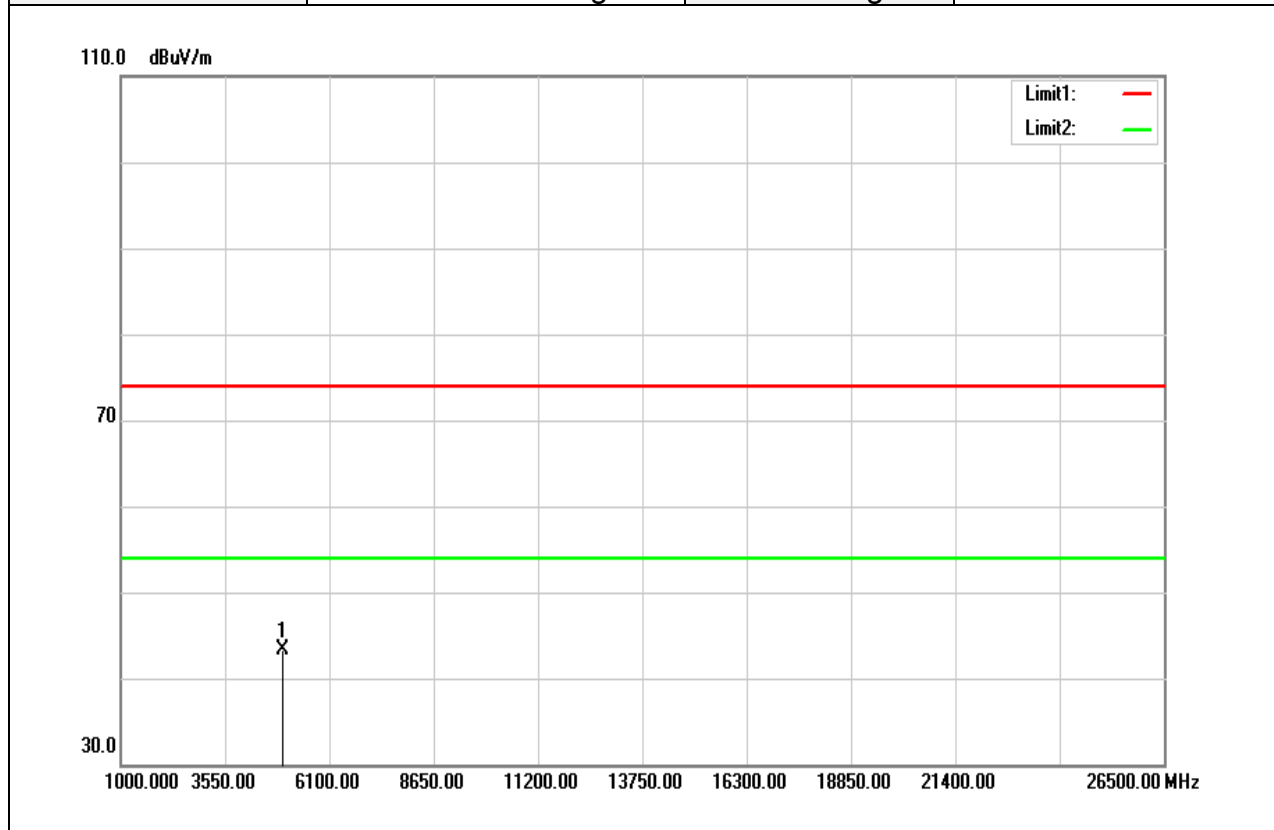

Frequency (MHz)	Reading (dBuV)	Correct Factor (dB/m)	Result (dBuV/m)	Limit (dBuV/m)	Margin (dB)	Remark
4960.000	38.70	4.61	43.31	74.00	-30.69	peak
N/A						

Remark:

1. Measuring frequencies from 1 GHz to the 10th harmonic of highest fundamental frequency.
2. For above 1GHz, the EUT peak value was under average limit, therefore the Average value compliance with the average limit

Test Mode:	BLE High CH	Temp/Hum	24(°C)/ 33%RH
Test Item	Harmonic	Test Date	December 2, 2017
Polarize	Horizontal	Test Engineer	Kevin Kuo
Detector	Peak and Average	Test Voltage:	120Vac / 60Hz

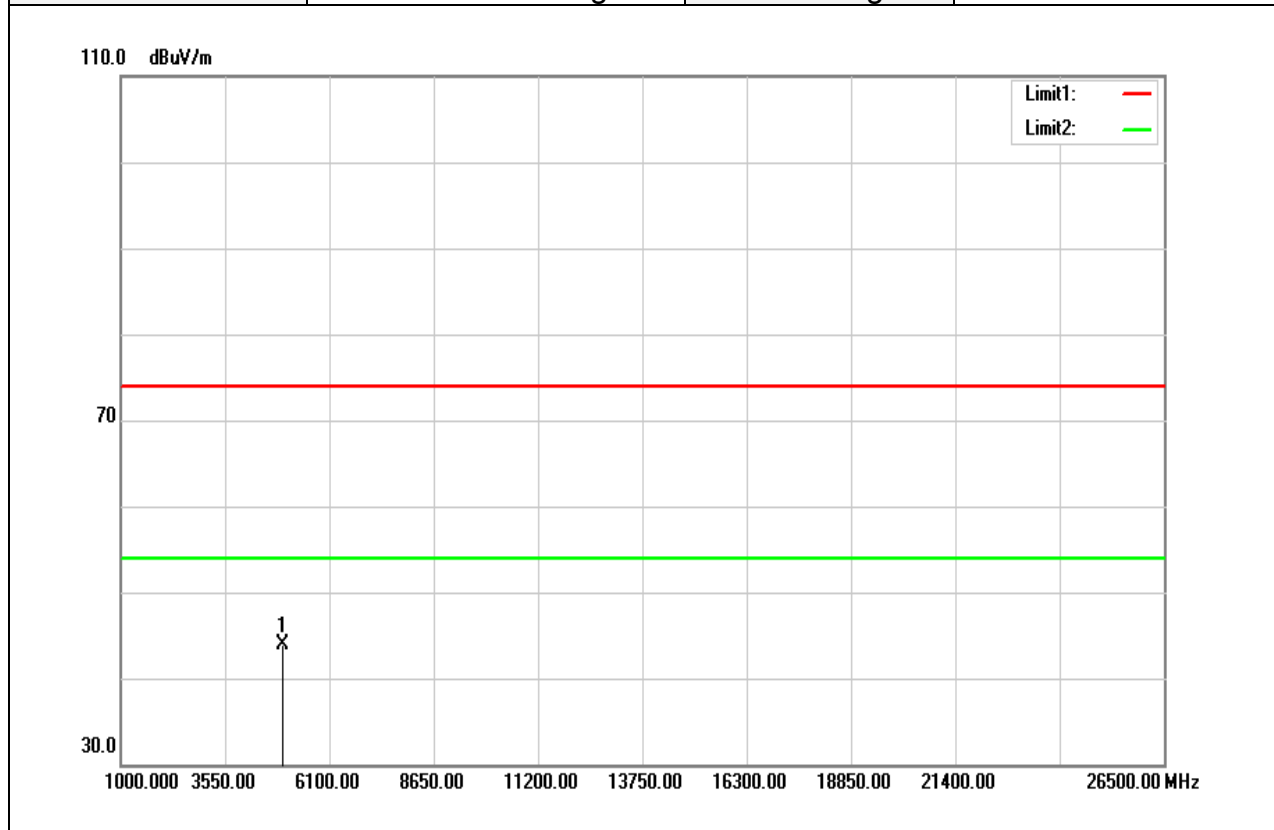

Frequency (MHz)	Reading (dBuV)	Correct Factor (dB/m)	Result (dBuV/m)	Limit (dBuV/m)	Margin (dB)	Remark
4960.000	39.27	4.61	43.88	74.00	-30.12	peak
N/A						

Remark:

1. Measuring frequencies from 1 GHz to the 10th harmonic of highest fundamental frequency.
2. For above 1GHz, the EUT peak value was under average limit, therefore the Average value compliance with the average limit

Below 1G Test Data

Test Mode:	BT Mode	Temp/Hum	24(°C)/ 33%RH
Test Item	30MHz-1GHz	Test Date	December 2, 2017
Polarize	Vertical	Test Engineer	Kevin Kuo
Detector	Peak and Quasi-peak	Test Voltage:	120Vac / 60Hz

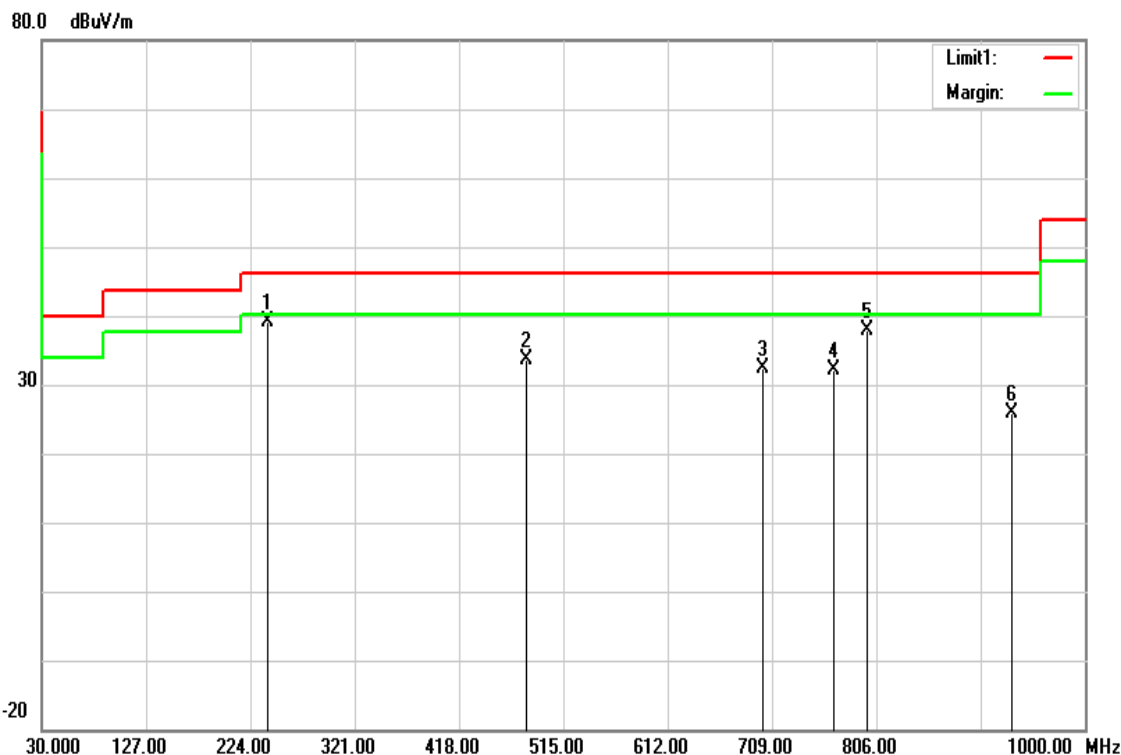

Frequency (MHz)	Reading (dBuV)	Correct Factor (dB/m)	Result (dBuV/m)	Limit (dBuV/m)	Margin (dB)	Remark
240.4900	55.35	-16.12	39.23	46.02	-6.79	QP
480.0800	42.64	-8.94	33.70	46.02	-12.32	peak
700.2700	37.28	-4.89	32.39	46.02	-13.63	peak
766.2300	36.01	-4.00	32.01	46.02	-14.01	peak
797.2700	41.21	-3.43	37.78	46.02	-8.24	peak
932.1000	27.31	-1.48	25.83	46.02	-20.19	peak

Note: No emission found between lowest internal used/generated frequency to 30MHz(9KHz~30MHz)

Test Mode:	BT Mode	Temp/Hum	24(°C)/ 33%RH
Test Item	30MHz-1GHz	Test Date	December 2, 2017
Polarize	Horizontal	Test Engineer	Kevin Kuo
Detector	Peak and Quasi-peak	Test Voltage:	120Vac / 60Hz

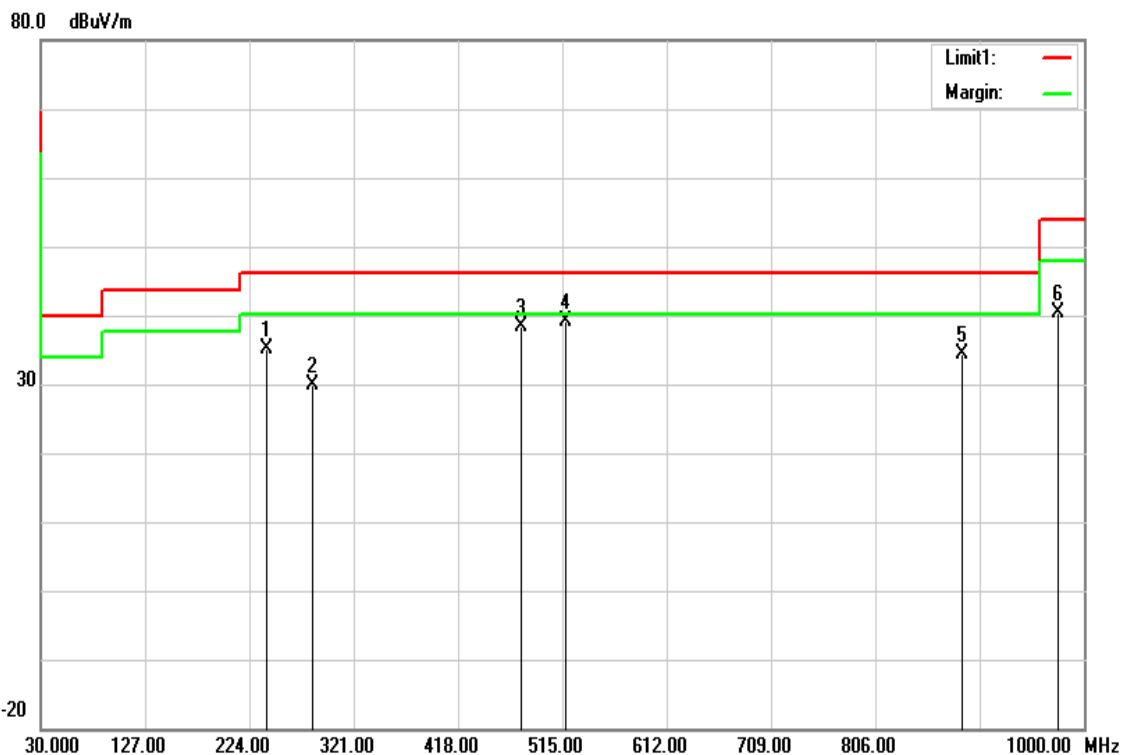

Frequency (MHz)	Reading (dBuV)	Correct Factor (dB/m)	Result (dBuV/m)	Limit (dBuV/m)	Margin (dB)	Remark
239.5200	51.34	-16.16	35.18	46.02	-10.84	peak
282.2000	44.17	-14.25	29.92	46.02	-16.10	peak
476.2000	47.38	-9.02	38.36	46.02	-7.66	peak
517.9100	47.37	-8.15	39.22	46.02	-6.80	peak
886.5100	36.56	-2.24	34.32	46.02	-11.70	peak
975.7500	41.27	-0.92	40.35	54.00	-13.65	peak

Note: No emission found between lowest internal used/generated frequency to 30MHz(9KHz~30MHz)