



Test Report

| | |
|--------------|----------------|
| Product Name | PS1 Speaker |
| Model No | PS1 Speaker |
| FCC ID. | PPQ-PS1SPEAKER |

| | |
|-----------|---|
| Applicant | Lite-On Technology Corp. |
| Address | 4F, 90, Chien 1 Road, Chung-Ho, Taipei Hsien 235, Taiwan, R.O.C. |

| | |
|-----------------|--------------------|
| Date of Receipt | Mar. 19, 2012 |
| Issue Date | Nov. 14, 2012 |
| Report No. | 12B212R-RFUSP42V01 |
| Report Version | V1.0 |



The test results relate only to the samples tested.
 The test report shall not be reproduced except in full without the written approval of Quietek Corporation.
 This report must not be used to claim product endorsement by NVLAP any agency of the U.S. Government

Test Report Certification

Issue Date: Nov. 14, 2012

Report No.: 12B212R-RFUSP42V01

Accredited by NIST (NVLAP)

NVLAP Lab Code: 200533-0

| | |
|---------------------|---|
| Product Name | PS1 Speaker |
| Applicant | Lite-On Technology Corp. |
| Address | 4F, 90, Chien 1 Road, Chung-Ho, Taipei Hsien 235, Taiwan, R.O.C. |
| Manufacturer | DONG GUAN G-COM COMPUTER CO., LTD. |
| Model No. | PS1 Speaker |
| EUT Rated Voltage | AC 100-240V, 50-60Hz |
| EUT Test Voltage | AC 120V/60Hz |
| Trade Name | Phorus |
| Applicable Standard | FCC CFR Title 47 Part 15 Subpart C: 2010 ANSI C63.4: 2003, ANSI C63.10: 2009 |
| Test Result | Complied |

The test results relate only to the samples tested.

The test report shall not be reproduced except in full without the written approval of Quietek Corporation.

This report must not be used to claim product endorsement by NVLAP any agency of the U.S. Government

Documented By : Leven Huang
(Senior Adm. Specialist / Leven Huang)

Tested By : Nowal Kuo
(Engineer / Nowal Kuo)

Approved By : Vincent Lin
(Manager / Vincent Lin)

TABLE OF CONTENTS

| Description | Page |
|--|------------|
| 1. GENERAL INFORMATION | 5 |
| 1.1. EUT Description..... | 5 |
| 1.2. Operational Description | 7 |
| 1.3. Tested System Details..... | 8 |
| 1.4. Configuration of Tested System | 9 |
| 1.5. EUT Exercise Software | 9 |
| 1.6. Test Facility | 10 |
| 2. Conducted Emission..... | 11 |
| 2.1. Test Equipment..... | 11 |
| 2.2. Test Setup | 11 |
| 2.3. Limits | 12 |
| 2.4. Test Procedure | 12 |
| 2.5. Uncertainty | 12 |
| 2.6. Test Result of Conducted Emission..... | 13 |
| 3. Peak Power Output | 23 |
| 3.1. Test Equipment..... | 23 |
| 3.2. Test Setup | 23 |
| 3.3. Limits | 23 |
| 3.4. Test Procedure | 24 |
| 3.5. Uncertainty | 24 |
| 3.6. Test Result of Peak Power Output..... | 25 |
| 4. Radiated Emission..... | 41 |
| 4.1. Test Equipment..... | 41 |
| 4.2. Test Setup | 42 |
| 4.3. Limits | 43 |
| 4.4. Test Procedure | 44 |
| 4.5. Uncertainty | 44 |
| 4.6. Test Result of Radiated Emission..... | 45 |
| 5. RF antenna conducted test..... | 89 |
| 5.1. Test Equipment..... | 89 |
| 5.2. Test Setup | 89 |
| 5.3. Limits | 89 |
| 5.4. Test Procedure | 90 |
| 5.5. Uncertainty | 90 |
| 5.6. Test Result of RF antenna conducted test..... | 91 |
| 6. Band Edge | 131 |
| 6.1. Test Equipment..... | 131 |
| 6.2. Test Setup | 132 |
| 6.3. Limits | 132 |
| 6.4. Test Procedure | 133 |
| 6.5. Uncertainty | 133 |
| 6.6. Test Result of Band Edge | 134 |

| | | |
|---------------|---|------------|
| 7. | Occupied Bandwidth..... | 166 |
| 7.1. | Test Equipment..... | 166 |
| 7.2. | Test Setup | 166 |
| 7.3. | Limits | 166 |
| 7.4. | Test Procedure | 166 |
| 7.5. | Uncertainty | 166 |
| 7.6. | Test Result of Occupied Bandwidth | 167 |
| 8. | Power Density | 191 |
| 8.1. | Test Equipment..... | 191 |
| 8.2. | Test Setup | 191 |
| 8.3. | Limits | 191 |
| 8.4. | Test Procedure | 191 |
| 8.5. | Uncertainty | 191 |
| 8.6. | Test Result of Power Density | 192 |
| 9. | EMI Reduction Method During Compliance Testing | 216 |
| Attachment 1: | EUT Test Photographs | |
| Attachment 2: | EUT Detailed Photographs | |

1. GENERAL INFORMATION

1.1. EUT Description

| | |
|--------------------|---|
| Product Name | PS1 Speaker |
| Trade Name | Phorus |
| Model No. | PS1 Speaker |
| FCC ID. | PPQ-PS1SPEAKER |
| Frequency Range | 802.11b/g/n-20MHz:2412-2462MHz,802.11n-40MHz:2422-2452MHz |
| Number of Channels | 802.11b/g/n-20MHz: 11, n-40MHz: 7 |
| Data Speed | 802.11b: 1-11Mbps, 802.11g: 6-54Mbps, 802.11n: up to 150Mbps |
| Channel separation | 802.11b/g/n-20MHz: 5 MHz |
| Type of Modulation | 802.11b:DSSS DBPSK, DQPSK, CCK 802.11g/n: OFDM BPSK, QPSK, 16QAM, 64QAM |
| Antenna Type | PIFA Antenna |
| Antenna Gain | Refer to the table "Antenna List" |
| Channel Control | Auto |
| Micro USB Cable | Shielded, 0.3m |
| Mini USB Cable | Shielded, 0.3m |
| Power Adapter (1) | MFR: Asian Power Devices INC., M/N: WA-24E12FU Input: AC 100-240V, 50-60Hz, 0.65A Output: DC 12V, 2A Cable Out: Non-Shielded, 1.5m |
| Power Adapter (2) | MFR: Asian Power Devices INC., M/N: WA-24E12 Input: AC 100-240V, 50-60Hz, 0.65A Output: DC 12V, 2A Cable Out: Non-Shielded, 1.5m |

Antenna List

| No. | Manufacturer | Part No. | Antenna Type | Peak Gain |
|-----|--------------|-------------------|--------------|----------------------|
| 1 | MAG. LAYERS | MSA-3810-2G4C1-A2 | PIFA | 4.47 dBi for 2.4 GHz |

Note: The antenna of EUT is conform to FCC 15.203

802.11b/g/n-20MHz Center Frequency of Each Channel:

| Channel | Frequency | Channel | Frequency | Channel | Frequency | Channel | Frequency |
|-------------|-----------|-------------|-----------|-------------|-----------|-------------|-----------|
| Channel 01: | 2412 MHz | Channel 02: | 2417 MHz | Channel 03: | 2422 MHz | Channel 04: | 2427 MHz |
| Channel 05: | 2432 MHz | Channel 06: | 2437 MHz | Channel 07: | 2442 MHz | Channel 08: | 2447 MHz |
| Channel 09: | 2452 MHz | Channel 10: | 2457 MHz | Channel 11: | 2462 MHz | | |

802.11n-40MHz Center Working Frequency of Each Channel:

| Channel | Frequency | Channel | Frequency | Channel | Frequency | Channel | Frequency |
|------------|-----------|------------|-----------|------------|-----------|------------|-----------|
| Channel 1: | 2422 MHz | Channel 2: | 2427 MHz | Channel 3: | 2432 MHz | Channel 4: | 2437 MHz |
| Channel 5: | 2442 MHz | Channel 6: | 2447 MHz | Channel 7: | 2452 MHz | | |

Note:

1. This device is a PS1 Speaker with a built-in 2.4GHz WLAN +Bluetooth transceiver, this report for WLAN.
2. Regarding to the operation frequency, the lowest, middle and highest frequency are selected to perform the test.
3. Lowest and highest data rates are tested in each mode. Only worst case is shown in the report. (802.11b is 1Mbps 、 802.11g is 6Mbps 、 802.11n(20M-BW) is 7.2Mbps and 、 802.11n(40M-BW) is 15Mbps).
4. These tests are conducted on a sample for the purpose of demonstrating compliance of 802.11b/g/n transmitter with Part 15 Subpart C Paragraph 15.247 of spread spectrum devices.
5. The different of the each model is shown as below:

| MCU Name | MCU Frequency | SDRAM | Note |
|---------------------|---------------|---------|----------------|
| 88AP1-8JD2(88AP162) | 162MHz | winbond | WLAN Module #1 |
| | | hynix | WLAN Module #2 |
| 88AP1-8JD2(88AP166) | 166MHz | winbond | WLAN Module #3 |
| | | hynix | WLAN Module #4 |

6. The MCU and SDRAM are digital circuits function and not part of RF circuits.
7. The test item conducted emission and 30MHz – 1GHz radiated emission are tested at four WLAN modules which describe in above note.
8. After tested conducted emission and 30MHz – 1GHz radiated emission, the worst case are system include WLAN module #1 and WLAN module #4. The worst case are tested all test item.
9. At result of pretests, Adapter #1(M/N: WA-24E12FU) is the worst case is shown in the report.

| | |
|------------|--|
| Test Mode: | Mode 1: Transmit (802.11b 1Mbps) |
| | Mode 2: Transmit (802.11g 6Mbps) |
| | Mode 3: Transmit - 802.11n-20BW_7.2Mbps(2.4G Band) |
| | Mode 4: Transmit - 802.11n-40BW_15Mbps(2.4G Band) |

1.3. Tested System Details

The types for all equipment, plus descriptions of all cables used in the tested system (including inserted cards) are:

| | Product | Manufacturer | Model No. | Serial No. | Power Cord |
|---|-----------------------|--------------|-----------|--------------|--------------------|
| 1 | USB Dongle | Kamera | N/A | N/A | N/A |
| 2 | Test Fixture | Lite-On | N/A | N/A | N/A |
| 3 | Notebook PC | DELL | PPT | N/A | Non-Shielded, 0.8m |
| 4 | iPod nano | Apple | A1236 | 7K823E51Y0P | N/A |
| 5 | DVD | DELL | PD01S | N/A | N/A |
| 6 | Microphone & Earphone | PCHOME | N/A | N/A | N/A |
| 7 | Monitor | LG | W2261VT | 907YHZK07373 | Non-Shielded, 1.8m |

| | Signal Cable Type | Signal cable Description |
|---|-----------------------------|--|
| A | Test Fixture Cable | Non-Shielded, 0.2m |
| B | RS-232 Cable | Non-Shielded, 2.0m |
| C | IPOD-NANO Cable | Non-Shielded, 1.8m |
| D | DVD Cable | Non-Shielded, 0.5m |
| E | Microphone & Earphone Cable | Non-Shielded, 1.2m |
| F | D-SUB Cable | Shielded, 1.8m, with two ferrite cores bonded. |
| G | USB Cable | Non-Shielded, 1.0m |

1.4. Configuration of Tested System

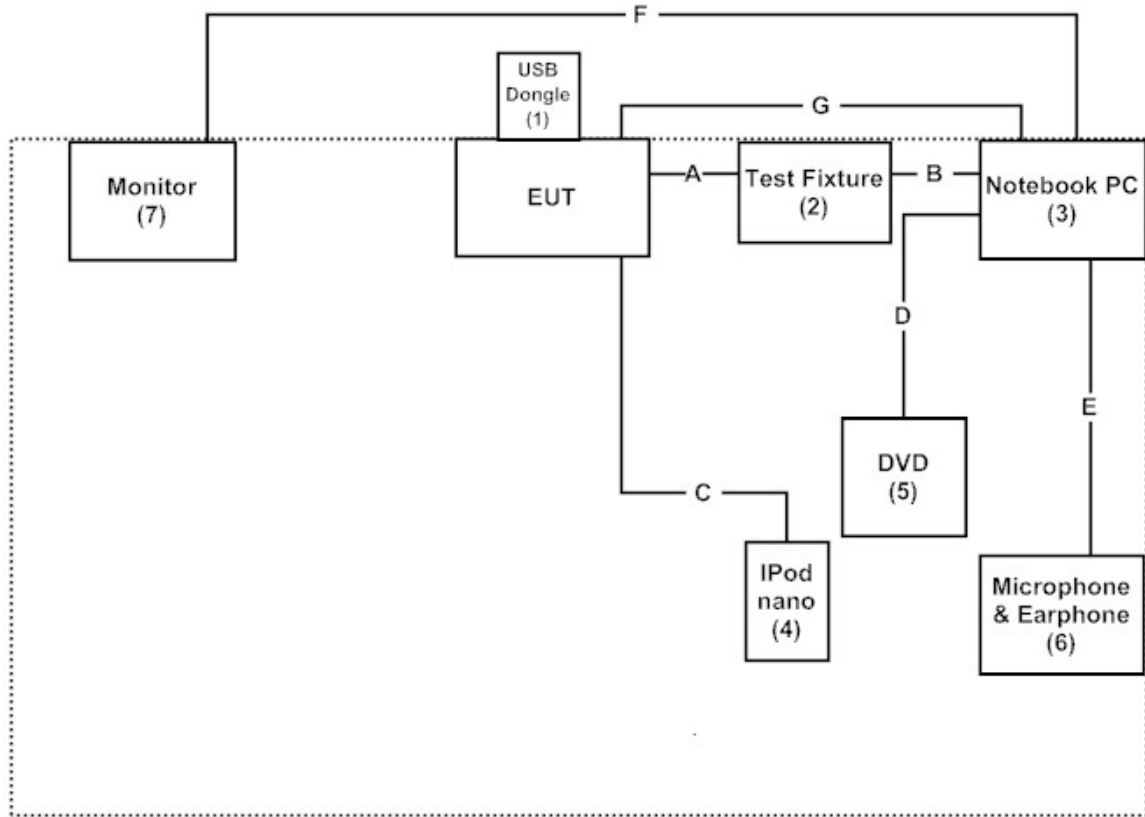

1.5. EUT Exercise Software

- (1) Connect EUT and Notebook via test fixture.
- (2) Execute program on the Notebook.
- (3) Configure the test mode, the test channel, and the data rate.
- (4) Press “OK” to start the continuous transmission.
- (5) Verify that the EUT works properly.

1.6. Test Facility

Ambient conditions in the laboratory:

| Items | Required (IEC 68-1) | Actual |
|----------------------------|---------------------|----------|
| Temperature (°C) | 15-35 | 20-35 |
| Humidity (%RH) | 25-75 | 50-65 |
| Barometric pressure (mbar) | 860-1060 | 950-1000 |

The related certificate for our laboratories about the test site and management system can be downloaded from

Quietek Corporation's Web Site : <http://www.quietek.com/tw/ctg/cts/accreditations.htm>

The address and introduction of Quietek Corporation's laboratories can be founded in our Web site : <http://www.quietek.com/>

Site Description: File on
 Federal Communications Commission
 FCC Engineering Laboratory
 7435 Oakland Mills Road
 Columbia, MD 21046
 Registration Number: 92195

Accreditation on NVLAP
 NVLAP Lab Code: 200533-0

Site Name: Quietek Corporation
 Site Address: No.5-22, Ruishukeng,
 Linkou Dist. New Taipei City 24451,
 Taiwan, R.O.C.
 TEL: 886-2-8601-3788 / FAX : 886-2-8601-3789
 E-Mail : service@quietek.com

FCC Accreditation Number: TW1014

2. Conducted Emission

2.1. Test Equipment

| | Equipment | Manufacturer | Model No. / Serial No. | Last Cal. | Remark |
|---|--------------------------|--------------|------------------------|------------|-------------|
| X | Test Receiver | R & S | ESCS 30 / 825442/018 | Sep., 2012 | |
| X | Artificial Mains Network | R & S | ENV4200 / 848411/10 | Feb., 2012 | Peripherals |
| X | LISN | R & S | ESH3-Z5 / 825562/002 | Feb., 2012 | EUT |
| | DC LISN | Schwarzbeck | 8226 / 176 | Mar, 2012 | EUT |
| X | Pulse Limiter | R & S | ESH3-Z2 / 357.8810.52 | Feb., 2012 | |
| | No.1 Shielded Room | | | | |

Note:

1. All equipments are calibrated every one year.
2. The test instruments marked by "X" are used to measure the final test results.

2.2. Test Setup

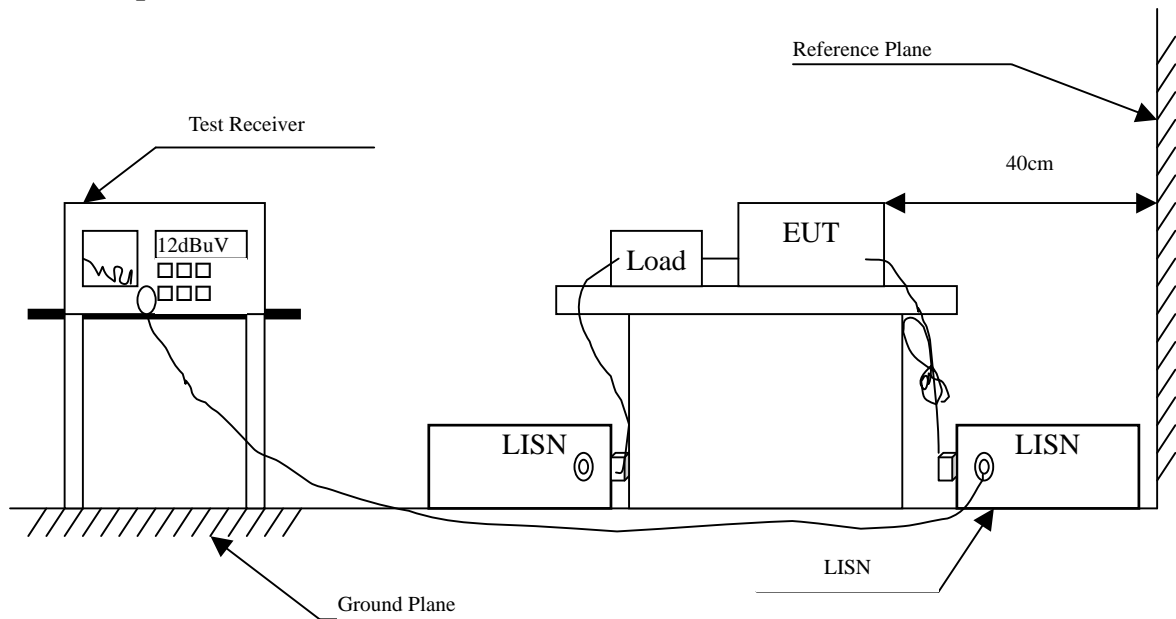

2.3. Limits

| FCC Part 15 Subpart C Paragraph 15.207 (dBuV) Limit | | |
|--|--------|-------|
| Frequency MHz | Limits | |
| | QP | AVG |
| 0.15 - 0.50 | 66-56 | 56-46 |
| 0.50-5.0 | 56 | 46 |
| 5.0 - 30 | 60 | 50 |

2.4. Test Procedure

The EUT and simulators are connected to the main power through a line impedance stabilization network (L.I.S.N.). This provides a 50 ohm /50uH coupling impedance for the measuring equipment. The peripheral devices are also connected to the main power through a LISN that provides a 50ohm /50uH coupling impedance with 50ohm termination. (Please refers to the block diagram of the test setup and photographs.)

Both sides of A.C. line are checked for maximum conducted interference. In order to find the maximum emission, the relative positions of equipment and all of the interface cables must be changed according to ANSI C63.4: 2003 on conducted measurement.

Conducted emissions were invested over the frequency range from 0.15MHz to 30MHz using a receiver bandwidth of 9kHz.

2.5. Uncertainty

± 2.26 dB

2.6. Test Result of Conducted Emission

Product : PS1 Speaker
 Test Item : Conducted Emission Test
 Power Line : Line 1
 Test Mode : Mode 4: Transmit - 802.11n-40BW_15Mbps(2.4G Band) (2437MHz)
 main chip_162 (winbond) (Adapter- M/N: WA-24E12FU)

| Frequency MHz | Correct Factor dB | Reading Level dBuV | Measurement Level dBuV | Margin dB | Limit dBuV |
|-------------------|-------------------------|--------------------------|------------------------------|--------------|---------------|
| Line 1 | | | | | |
| Quasi-Peak | | | | | |
| 0.150 | 9.697 | 35.250 | 44.947 | -21.053 | 66.000 |
| 0.193 | 9.804 | 30.640 | 40.444 | -24.327 | 64.771 |
| 0.248 | 9.831 | 22.900 | 32.731 | -30.469 | 63.200 |
| 0.470 | 9.807 | 23.630 | 33.437 | -23.420 | 56.857 |
| 1.127 | 9.820 | 20.420 | 30.240 | -25.760 | 56.000 |
| 11.353 | 10.054 | 18.520 | 28.574 | -31.426 | 60.000 |
| Average | | | | | |
| 0.150 | 9.697 | 20.110 | 29.807 | -26.193 | 56.000 |
| 0.193 | 9.804 | 18.950 | 28.754 | -26.017 | 54.771 |
| 0.248 | 9.831 | 11.150 | 20.981 | -32.219 | 53.200 |
| 0.470 | 9.807 | 16.140 | 25.947 | -20.910 | 46.857 |
| 1.127 | 9.820 | 14.140 | 23.960 | -22.040 | 46.000 |
| 11.353 | 10.054 | 12.270 | 22.324 | -27.676 | 50.000 |

Note:

1. All Reading Levels are Quasi-Peak and average value.
2. “” means the worst emission level.
3. Measurement Level = Reading Level + Correct Factor

Product : PS1 Speaker
 Test Item : Conducted Emission Test
 Power Line : Line 2
 Test Mode : Mode 4: Transmit - 802.11n-40BW_15Mbps(2.4G Band) (2437MHz)
 main chip_162 (winbond) (Adapter- M/N: WA-24E12FU)

| Frequency MHz | Correct Factor dB | Reading Level dBuV | Measurement Level dBuV | Margin dB | Limit dBuV |
|-------------------|-------------------------|--------------------------|------------------------------|--------------|---------------|
| Line 2 | | | | | |
| Quasi-Peak | | | | | |
| 0.166 | 9.786 | 34.660 | 44.446 | -21.097 | 65.543 |
| 0.224 | 9.771 | 29.640 | 39.411 | -24.475 | 63.886 |
| 0.470 | 9.823 | 30.970 | 40.793 | -16.064 | 56.857 |
| 1.752 | 9.860 | 19.090 | 28.950 | -27.050 | 56.000 |
| 3.752 | 9.870 | 16.680 | 26.550 | -29.450 | 56.000 |
| 11.966 | 10.105 | 15.670 | 25.775 | -34.225 | 60.000 |
| Average | | | | | |
| 0.166 | 9.786 | 23.630 | 33.416 | -22.127 | 55.543 |
| 0.224 | 9.771 | 22.270 | 32.041 | -21.845 | 53.886 |
| 0.470 | 9.823 | 20.810 | 30.633 | -16.224 | 46.857 |
| 1.752 | 9.860 | 13.000 | 22.860 | -23.140 | 46.000 |
| 3.752 | 9.870 | 9.790 | 19.660 | -26.340 | 46.000 |
| 11.966 | 10.105 | 9.550 | 19.655 | -30.345 | 50.000 |

Note:

1. All Reading Levels are Quasi-Peak and average value.
2. “” means the worst emission level.
3. Measurement Level = Reading Level + Correct Factor

Product : PS1 Speaker
 Test Item : Conducted Emission Test
 Power Line : Line 1
 Test Mode : Mode 4: Transmit - 802.11n-40BW_15Mbps(2.4G Band) (2437MHz)
 main chip_166 (Hynix) (Adapter- M/N: WA-24E12FU)

| Frequency MHz | Correct Factor dB | Reading Level dBuV | Measurement Level dBuV | Margin dB | Limit dBuV |
|-------------------|-------------------------|--------------------------|------------------------------|--------------|---------------|
| Line 1 | | | | | |
| Quasi-Peak | | | | | |
| 0.150 | 9.697 | 30.430 | 40.127 | -25.873 | 66.000 |
| 0.185 | 9.782 | 28.970 | 38.752 | -26.248 | 65.000 |
| 0.228 | 9.837 | 24.630 | 34.467 | -29.304 | 63.771 |
| 0.459 | 9.810 | 29.070 | 38.880 | -18.291 | 57.171 |
| 1.150 | 9.820 | 21.350 | 31.170 | -24.830 | 56.000 |
| 10.990 | 10.047 | 19.810 | 29.857 | -30.143 | 60.000 |
| Average | | | | | |
| 0.150 | 9.697 | 13.970 | 23.667 | -32.333 | 56.000 |
| 0.185 | 9.782 | 18.050 | 27.832 | -27.168 | 55.000 |
| 0.228 | 9.837 | 19.110 | 28.947 | -24.824 | 53.771 |
| 0.459 | 9.810 | 21.380 | 31.190 | -15.981 | 47.171 |
| 1.150 | 9.820 | 15.740 | 25.560 | -20.440 | 46.000 |
| 10.990 | 10.047 | 13.160 | 23.207 | -26.793 | 50.000 |

Note:

1. All Reading Levels are Quasi-Peak and average value.
2. "■" means the worst emission level.
3. Measurement Level = Reading Level + Correct Factor

Product : PS1 Speaker
 Test Item : Conducted Emission Test
 Power Line : Line 2
 Test Mode : Mode 4: Transmit - 802.11n-40BW_15Mbps(2.4G Band) (2437MHz)
 main chip_166 (Hynix) (Adapter- M/N: WA-24E12FU)

| Frequency MHz | Correct Factor dB | Reading Level dBuV | Measurement Level dBuV | Margin dB | Limit dBuV |
|-------------------|-------------------------|--------------------------|------------------------------|--------------|---------------|
| Line 2 | | | | | |
| Quasi-Peak | | | | | |
| 0.170 | 9.784 | 32.070 | 41.854 | -23.575 | 65.429 |
| 0.240 | 9.777 | 25.260 | 35.037 | -28.392 | 63.429 |
| 0.455 | 9.820 | 29.160 | 38.980 | -18.306 | 57.286 |
| 0.841 | 9.840 | 18.960 | 28.800 | -27.200 | 56.000 |
| 1.529 | 9.850 | 21.780 | 31.630 | -24.370 | 56.000 |
| 12.818 | 10.120 | 19.270 | 29.390 | -30.610 | 60.000 |
| Average | | | | | |
| 0.170 | 9.784 | 20.450 | 30.234 | -25.195 | 55.429 |
| 0.240 | 9.777 | 14.570 | 24.347 | -29.082 | 53.429 |
| 0.455 | 9.820 | 21.380 | 31.200 | -16.086 | 47.286 |
| 0.841 | 9.840 | 11.730 | 21.570 | -24.430 | 46.000 |
| 1.529 | 9.850 | 15.430 | 25.280 | -20.720 | 46.000 |
| 12.818 | 10.120 | 13.210 | 23.330 | -26.670 | 50.000 |

Note:

1. All Reading Levels are Quasi-Peak and average value.
2. “” means the worst emission level.
3. Measurement Level = Reading Level + Correct Factor

Product : PS1 Speaker
 Test Item : Conducted Emission Test
 Power Line : Line 1
 Test Mode : Mode 4: Transmit - 802.11n-40BW_15Mbps(2.4G Band) (2437MHz)
 main chip_162 (Hynix) (Adapter- M/N: WA-24E12FU)

| Frequency MHz | Correct Factor dB | Reading Level dBuV | Measurement Level dBuV | Margin dB | Limit dBuV |
|-------------------|-------------------------|--------------------------|------------------------------|--------------|---------------|
| Line 1 | | | | | |
| Quasi-Peak | | | | | |
| 0.166 | 9.820 | 31.350 | 41.170 | -24.373 | 65.543 |
| 0.189 | 9.820 | 28.390 | 38.210 | -26.676 | 64.886 |
| 0.420 | 9.820 | 25.250 | 35.070 | -23.216 | 58.286 |
| 1.431 | 9.820 | 19.690 | 29.510 | -26.490 | 56.000 |
| 3.287 | 9.840 | 17.190 | 27.030 | -28.970 | 56.000 |
| 12.494 | 10.013 | 16.750 | 26.763 | -33.237 | 60.000 |
| Average | | | | | |
| 0.166 | 9.820 | 19.390 | 29.210 | -26.333 | 55.543 |
| 0.189 | 9.820 | 13.440 | 23.260 | -31.626 | 54.886 |
| 0.420 | 9.820 | 18.760 | 28.580 | -19.706 | 48.286 |
| 1.431 | 9.820 | 13.140 | 22.960 | -23.040 | 46.000 |
| 3.287 | 9.840 | 10.920 | 20.760 | -25.240 | 46.000 |
| 12.494 | 10.013 | 10.870 | 20.883 | -29.117 | 50.000 |

Note:

1. All Reading Levels are Quasi-Peak and average value.
2. "■" means the worst emission level.
3. Measurement Level = Reading Level + Correct Factor

Product : PS1 Speaker
 Test Item : Conducted Emission Test
 Power Line : Line 2
 Test Mode : Mode 4: Transmit - 802.11n-40BW_15Mbps(2.4G Band) (2437MHz)
 main chip_162 (Hynix) (Adapter- M/N: WA-24E12FU)

| Frequency MHz | Correct Factor dB | Reading Level dBuV | Measurement Level dBuV | Margin dB | Limit dBuV |
|-------------------|-------------------------|--------------------------|------------------------------|--------------|---------------|
| Line 2 | | | | | |
| Quasi-Peak | | | | | |
| 0.170 | 9.860 | 30.650 | 40.510 | -24.919 | 65.429 |
| 0.193 | 9.860 | 28.050 | 37.910 | -26.861 | 64.771 |
| 0.416 | 9.870 | 25.230 | 35.100 | -23.300 | 58.400 |
| 1.087 | 9.870 | 17.770 | 27.640 | -28.360 | 56.000 |
| 1.752 | 9.880 | 16.010 | 25.890 | -30.110 | 56.000 |
| 11.400 | 10.090 | 15.890 | 25.980 | -34.020 | 60.000 |
| Average | | | | | |
| 0.170 | 9.860 | 19.910 | 29.770 | -25.659 | 55.429 |
| 0.193 | 9.860 | 16.740 | 26.600 | -28.171 | 54.771 |
| 0.416 | 9.870 | 17.140 | 27.010 | -21.390 | 48.400 |
| 1.087 | 9.870 | 10.970 | 20.840 | -25.160 | 46.000 |
| 1.752 | 9.880 | 9.850 | 19.730 | -26.270 | 46.000 |
| 11.400 | 10.090 | 9.440 | 19.530 | -30.470 | 50.000 |

Note:

1. All Reading Levels are Quasi-Peak and average value.
2. “” means the worst emission level.
3. Measurement Level = Reading Level + Correct Factor

Product : PS1 Speaker
 Test Item : Conducted Emission Test
 Power Line : Line 1
 Test Mode : Mode 4: Transmit - 802.11n-40BW_15Mbps(2.4G Band) (2437MHz)
 main chip_166 (winbond) (Adapter- M/N: WA-24E12FU)

| Frequency MHz | Correct Factor dB | Reading Level dBuV | Measurement Level dBuV | Margin dB | Limit dBuV |
|-------------------|-------------------------|--------------------------|------------------------------|--------------|---------------|
| Line 1 | | | | | |
| Quasi-Peak | | | | | |
| 0.181 | 9.820 | 27.410 | 37.230 | -27.884 | 65.114 |
| 0.205 | 9.820 | 25.430 | 35.250 | -29.179 | 64.429 |
| 0.404 | 9.820 | 25.270 | 35.090 | -23.653 | 58.743 |
| 1.197 | 9.820 | 18.330 | 28.150 | -27.850 | 56.000 |
| 1.920 | 9.830 | 18.010 | 27.840 | -28.160 | 56.000 |
| 11.935 | 10.010 | 16.210 | 26.220 | -33.780 | 60.000 |
| Average | | | | | |
| 0.181 | 9.820 | 22.330 | 32.150 | -22.964 | 55.114 |
| 0.205 | 9.820 | 12.570 | 22.390 | -32.039 | 54.429 |
| 0.404 | 9.820 | 19.830 | 29.650 | -19.093 | 48.743 |
| 1.197 | 9.820 | 11.790 | 21.610 | -24.390 | 46.000 |
| 1.920 | 9.830 | 11.120 | 20.950 | -25.050 | 46.000 |
| 11.935 | 10.010 | 9.900 | 19.910 | -30.090 | 50.000 |

Note:

1. All Reading Levels are Quasi-Peak and average value.
2. "■" means the worst emission level.
3. Measurement Level = Reading Level + Correct Factor

Product : PS1 Speaker
 Test Item : Conducted Emission Test
 Power Line : Line 2
 Test Mode : Mode 4: Transmit - 802.11n-40BW_15Mbps(2.4G Band) (2437MHz)
 main chip_166 (winbond) (Adapter- M/N: WA-24E12FU)

| Frequency MHz | Correct Factor dB | Reading Level dBuV | Measurement Level dBuV | Margin dB | Limit dBuV |
|-------------------|-------------------------|--------------------------|------------------------------|--------------|---------------|
| Line 2 | | | | | |
| Quasi-Peak | | | | | |
| 0.170 | 9.860 | 26.450 | 36.310 | -29.119 | 65.429 |
| 0.228 | 9.860 | 23.250 | 33.110 | -30.661 | 63.771 |
| 0.396 | 9.870 | 25.150 | 35.020 | -23.951 | 58.971 |
| 1.154 | 9.870 | 15.450 | 25.320 | -30.680 | 56.000 |
| 2.259 | 9.880 | 15.930 | 25.810 | -30.190 | 56.000 |
| 12.431 | 10.100 | 15.410 | 25.510 | -34.490 | 60.000 |
| Average | | | | | |
| 0.170 | 9.860 | 21.170 | 31.030 | -24.399 | 55.429 |
| 0.228 | 9.860 | 13.290 | 23.150 | -30.621 | 53.771 |
| 0.396 | 9.870 | 19.540 | 29.410 | -19.561 | 48.971 |
| 1.154 | 9.870 | 8.880 | 18.750 | -27.250 | 46.000 |
| 2.259 | 9.880 | 10.820 | 20.700 | -25.300 | 46.000 |
| 12.431 | 10.100 | 10.510 | 20.610 | -29.390 | 50.000 |

Note:

1. All Reading Levels are Quasi-Peak and average value.
2. “” means the worst emission level.
3. Measurement Level = Reading Level + Correct Factor

Product : PS1 Speaker
 Test Item : Conducted Emission Test
 Power Line : Line 1
 Test Mode : Mode 4: Transmit - 802.11n-40BW_15Mbps(2.4G Band) (2437MHz)
 (Adapter- M/N: WA-24E12)

| Frequency MHz | Correct Factor dB | Reading Level dBuV | Measurement Level dBuV | Margin dB | Limit dBuV |
|-------------------|-------------------------|--------------------------|------------------------------|--------------|---------------|
| Line 1 | | | | | |
| Quasi-Peak | | | | | |
| 0.158 | 9.821 | 34.490 | 44.311 | -21.460 | 65.771 |
| 0.197 | 9.821 | 26.510 | 36.331 | -28.326 | 64.657 |
| 0.232 | 9.821 | 25.580 | 35.401 | -28.256 | 63.657 |
| 0.416 | 9.822 | 27.980 | 37.802 | -20.598 | 58.400 |
| 1.587 | 9.837 | 20.730 | 30.567 | -25.433 | 56.000 |
| 25.232 | 10.164 | 26.910 | 37.074 | -22.926 | 60.000 |
| Average | | | | | |
| 0.158 | 9.821 | 20.620 | 30.441 | -25.330 | 55.771 |
| 0.197 | 9.821 | 12.800 | 22.621 | -32.036 | 54.657 |
| 0.232 | 9.821 | 13.560 | 23.381 | -30.276 | 53.657 |
| 0.416 | 9.822 | 20.740 | 30.562 | -17.838 | 48.400 |
| 1.587 | 9.837 | 14.970 | 24.807 | -21.193 | 46.000 |
| 25.232 | 10.164 | 23.790 | 33.954 | -16.046 | 50.000 |

Note:

1. All Reading Levels are Quasi-Peak and average value.
2. “█” means the worst emission level.
3. Measurement Level = Reading Level + Correct Factor

Product : PS1 Speaker
 Test Item : Conducted Emission Test
 Power Line : Line 2
 Test Mode : Mode 4: Transmit - 802.11n-40BW_15Mbps(2.4G Band) (2437MHz)
 (Adapter- M/N: WA-24E12)

| Frequency MHz | Correct Factor dB | Reading Level dBuV | Measurement Level dBuV | Margin dB | Limit dBuV |
|-------------------|-------------------------|--------------------------|------------------------------|--------------|---------------|
| Line 2 | | | | | |
| Quasi-Peak | | | | | |
| 0.166 | 9.861 | 33.640 | 43.501 | -22.042 | 65.543 |
| 0.189 | 9.861 | 30.170 | 40.031 | -24.855 | 64.886 |
| 0.232 | 9.861 | 24.330 | 34.191 | -29.466 | 63.657 |
| 0.412 | 9.872 | 27.660 | 37.532 | -20.982 | 58.514 |
| 1.255 | 9.876 | 20.450 | 30.326 | -25.674 | 56.000 |
| 25.232 | 10.344 | 26.690 | 37.034 | -22.966 | 60.000 |
| Average | | | | | |
| 0.166 | 9.861 | 22.630 | 32.491 | -23.052 | 55.543 |
| 0.189 | 9.861 | 19.800 | 29.661 | -25.225 | 54.886 |
| 0.232 | 9.861 | 14.690 | 24.551 | -29.106 | 53.657 |
| 0.412 | 9.872 | 21.310 | 31.182 | -17.332 | 48.514 |
| 1.255 | 9.876 | 15.010 | 24.886 | -21.114 | 46.000 |
| 25.232 | 10.344 | 23.590 | 33.934 | -16.066 | 50.000 |

Note:

1. All Reading Levels are Quasi-Peak and average value.
2. “” means the worst emission level.
3. Measurement Level = Reading Level + Correct Factor

1.

3. Peak Power Output

3.1. Test Equipment

| | Equipment | Manufacturer | Model No./Serial No. | Last Cal. |
|---|-------------------|--------------|----------------------|------------|
| X | Power Meter | Anritsu | ML2495A/6K00003357 | May, 2012 |
| X | Power Sensor | Anritsu | MA2411B/0738448 | Jun, 2012 |
| | Spectrum Analyzer | R&S | FSP40 / 100170 | Jun, 2012 |
| | Spectrum Analyzer | Agilent | E4407B / US39440758 | Jun, 2012 |
| X | Spectrum Analyzer | Agilent | N9010A / MY48030495 | Apr., 2012 |

Note:

1. All equipments are calibrated with traceable calibrations. Each calibration is traceable to the national or international standards.
2. The test instruments marked with “X” are used to measure the final test results.

3.2. Test Setup

Average Power For different Data Rate (Mbps)

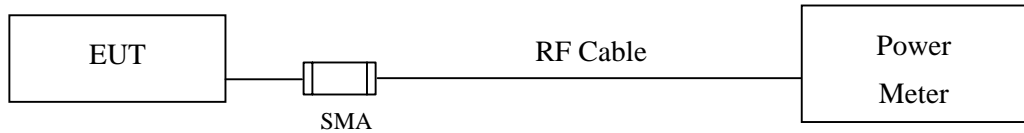

Peak Power Measurement

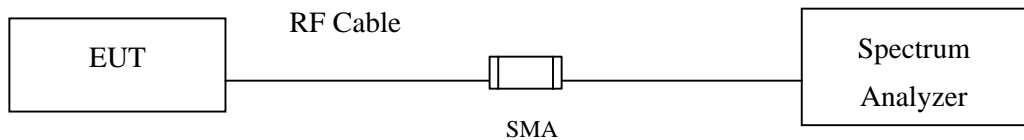

3.3. Limits

The maximum peak power shall be less 1 Watt.

3.4. Test Procedure

The EUT was tested according to DTS test procedure of ANSI C63.10: 2009 for compliance to FCC 47CFR 15.247 requirements.

3.5. Uncertainty

± 1.27 dB

3.6. Test Result of Peak Power Output

Product : PS1 Speaker
 Test Item : Peak Power Output Data
 Test Site : No.3 OATS
 Test Mode : Mode 1: Transmit (802.11b 1Mbps) main chip_162

| Channel No | Frequency (MHz) | Average Power For different Data Rate (Mbps) | | | | Peak Power | Required Limit | Result |
|------------|-----------------|---|-------|-------|-------|------------|----------------|--------|
| | | 1 | 2 | 5.5 | 11 | | | |
| | | Measurement Level (dBm) | | | | | | |
| 01 | 2412 | 15.11 | -- | -- | -- | 17.10 | <30dBm | Pass |
| 06 | 2437 | 15.01 | 14.98 | 14.95 | 14.93 | 16.59 | <30dBm | Pass |
| 11 | 2462 | 13.68 | -- | -- | -- | 15.27 | <30dBm | Pass |

Note:

1. Peak Power Output Value = Reading value on Spectrum Analyzer + cable loss
 (Use the spectrum analyzer's integrated channel power measurement function)
2. Average Power for different data rate = Reading value on Power Meter + cable loss

Figure Channel 1:

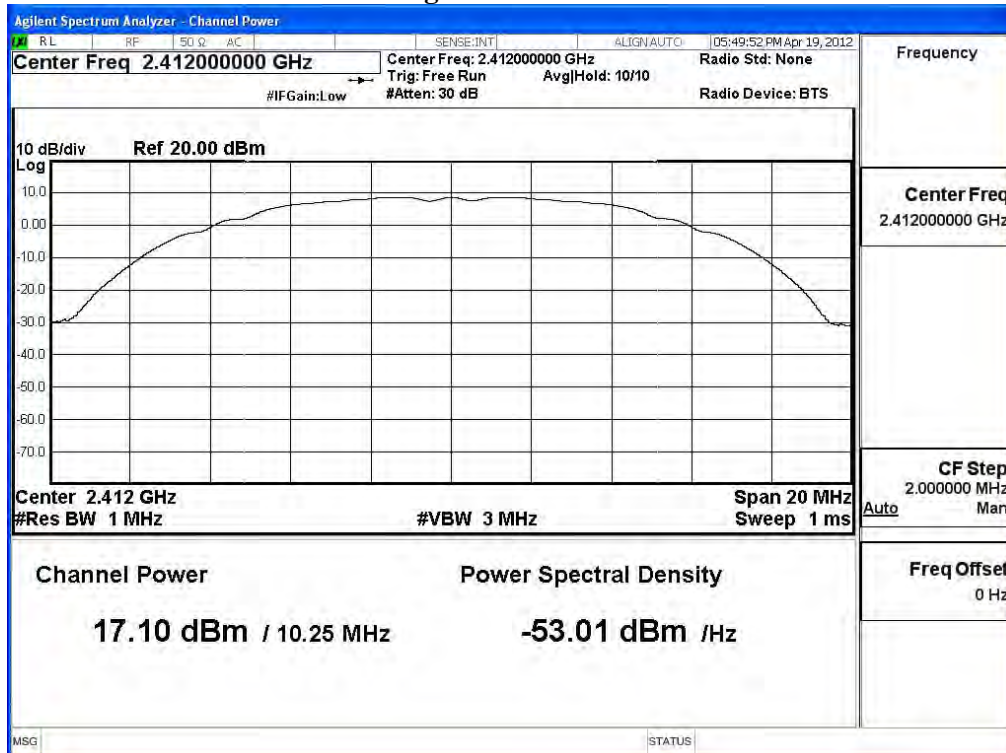

Figure Channel 6:

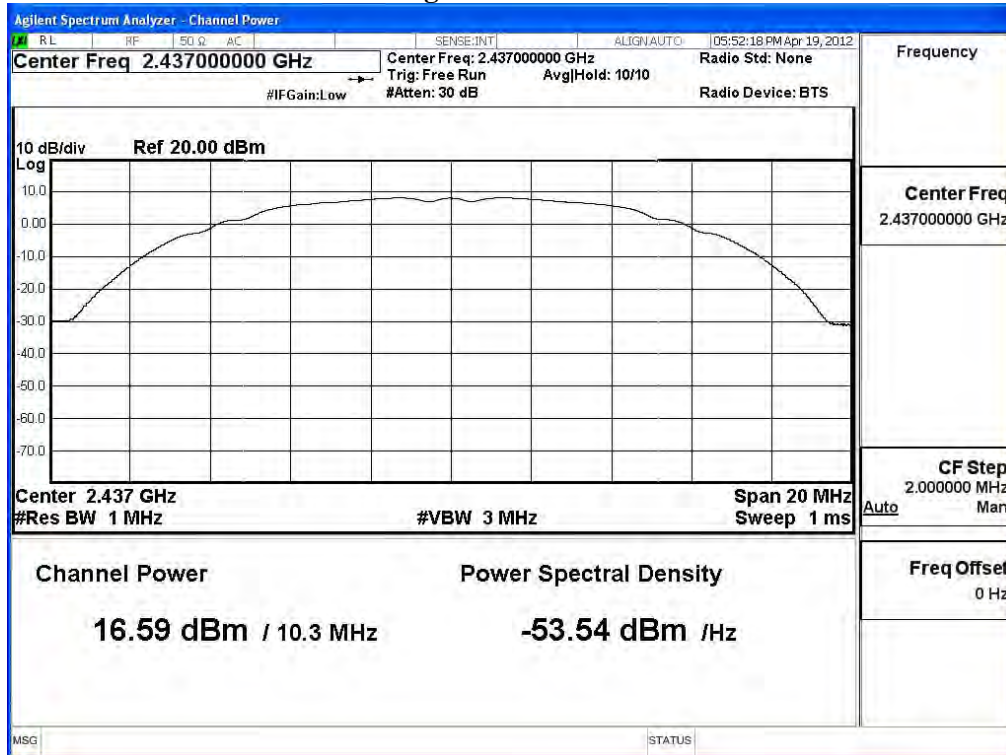
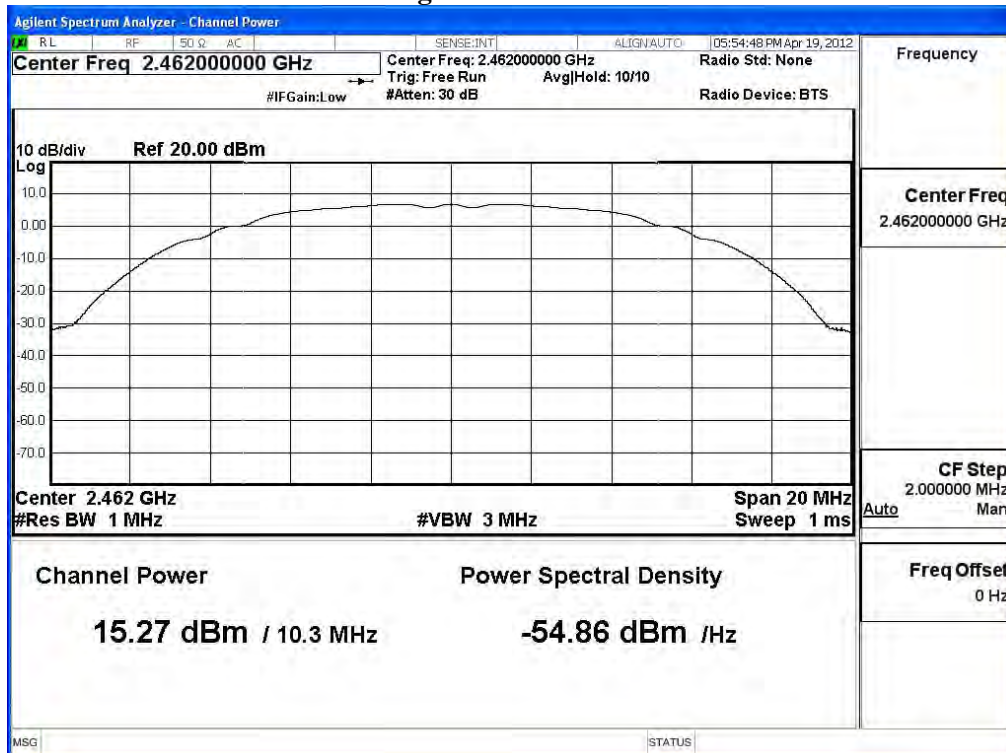

Figure Channel 11:



Product : PS1 Speaker
 Test Item : Peak Power Output Data
 Test Site : No.3 OATS
 Test Mode : Mode 2: Transmit (802.11g 6Mbps) main chip_162

| Channel No | Frequency (MHz) | Average Power For different Data Rate (Mbps) | | | | | | | | Peak Power | Required Limit | Result |
|------------|-----------------|---|-------|-------|-------|-------|-------|-------|-------|------------|----------------|--------|
| | | 6 | 9 | 12 | 18 | 24 | 36 | 48 | 54 | | | |
| | | Measurement Level (dBm) | | | | | | | | | | |
| 01 | 2412 | 12.07 | -- | -- | -- | -- | -- | -- | -- | 18.78 | <30dBm | Pass |
| 06 | 2437 | 11.88 | 11.85 | 11.84 | 11.81 | 11.78 | 11.75 | 11.71 | 11.69 | 18.66 | <30dBm | Pass |
| 11 | 2462 | 11.41 | -- | -- | -- | -- | -- | -- | -- | 17.76 | <30dBm | Pass |

Note:

1. Peak Power Output Value = Reading value on Spectrum Analyzer + cable loss
(Use the spectrum analyzer's integrated channel power measurement function)
2. Average Power for different data rate = Reading value on Power Meter +cable loss

Figure Channel 1:

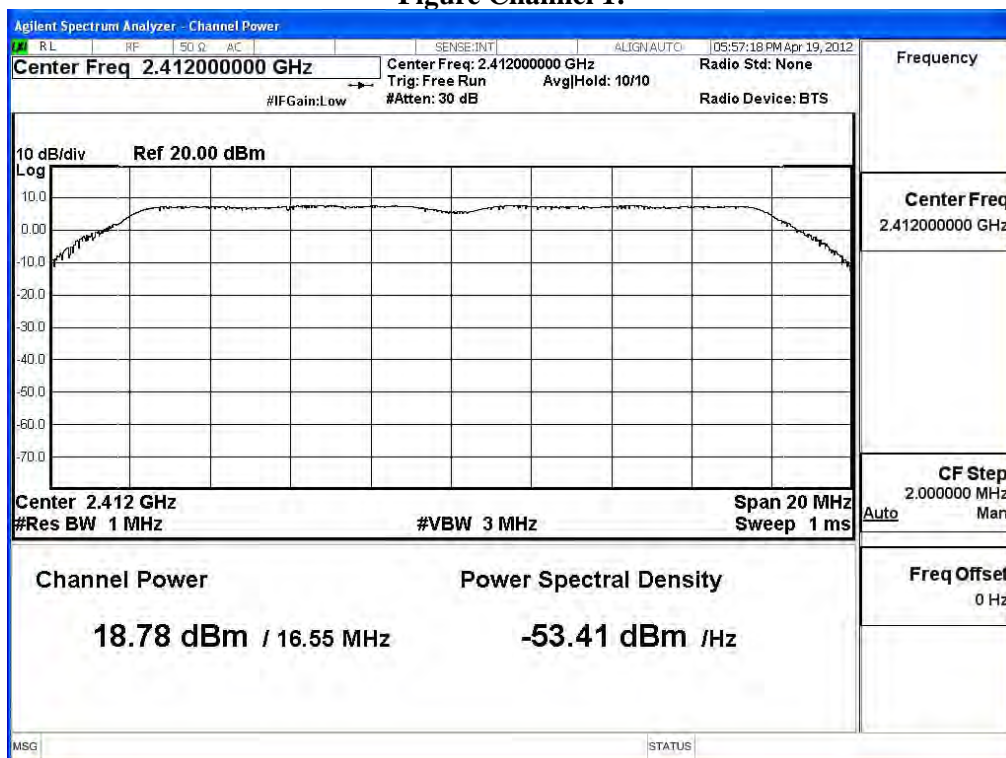

Figure Channel 6:

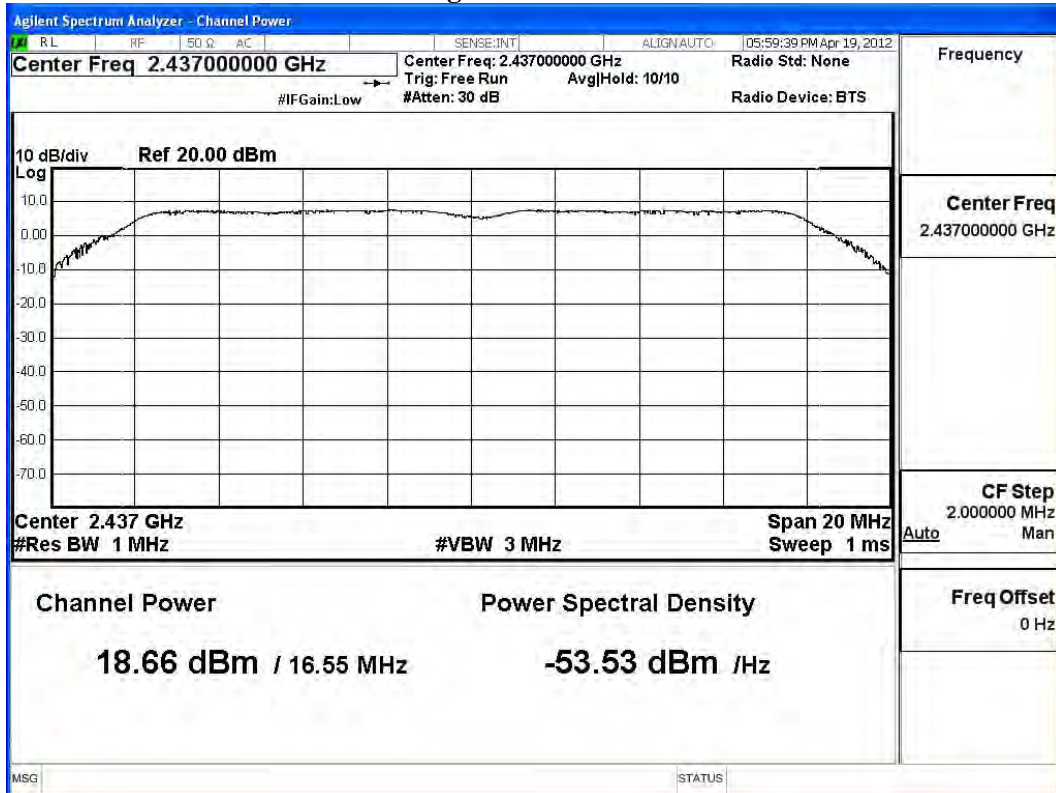
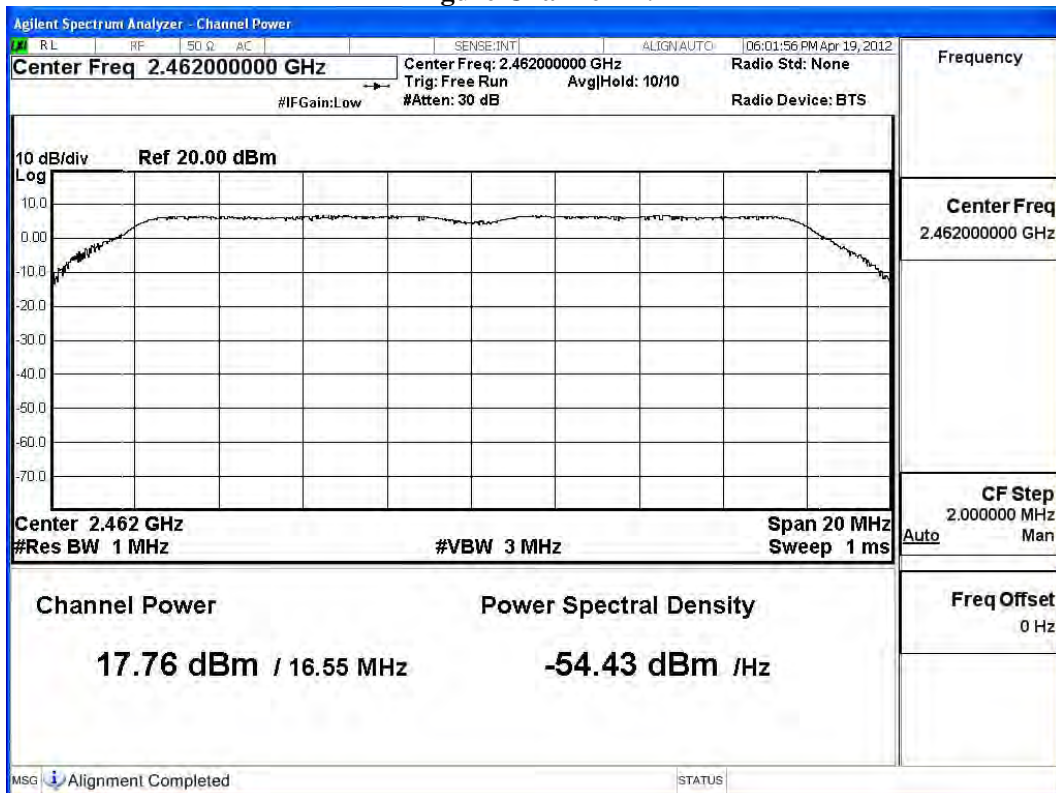

Figure Channel 11:



Product : PS1 Speaker
 Test Item : Peak Power Output Data
 Test Site : No.3 OATS
 Test Mode : Mode 3: Transmit - 802.11n-20BW_7.2Mbps(2.4G Band) main chip_162

| Channel No | Frequency (MHz) | Average Power For different Data Rate (Mbps) | | | | | | | | Peak Power |
|------------|-----------------|---|-------|------|-------|-------|-------|-------|-------|------------|
| | | 7.2 | 14.4 | 21.7 | 28.9 | 43.3 | 57.8 | 65 | 72.2 | |
| | | Measurement Level (dBm) | | | | | | | | |
| 01 | 2412 | 12.16 | -- | -- | -- | -- | -- | -- | -- | 19.09 |
| 06 | 2437 | 11.85 | 11.84 | 11.8 | 11.79 | 11.75 | 11.73 | 11.71 | 11.69 | 19.01 |
| 11 | 2462 | 12.02 | -- | -- | -- | -- | -- | -- | -- | 19.12 |

Note:

1. Peak Power Output Value = Reading value on Spectrum Analyzer + cable loss
(Use the spectrum analyzer's integrated channel power measurement function)
2. Average Power for different data rate = Reading value on Power Meter + cable loss

Figure Channel 1:

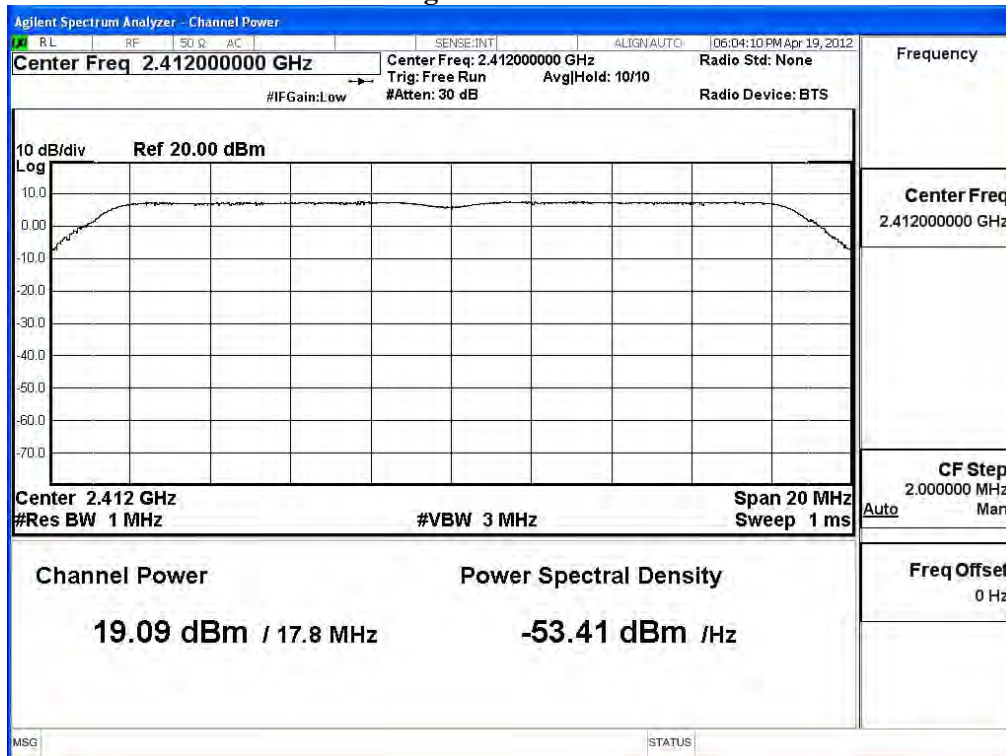

Figure Channel 6:

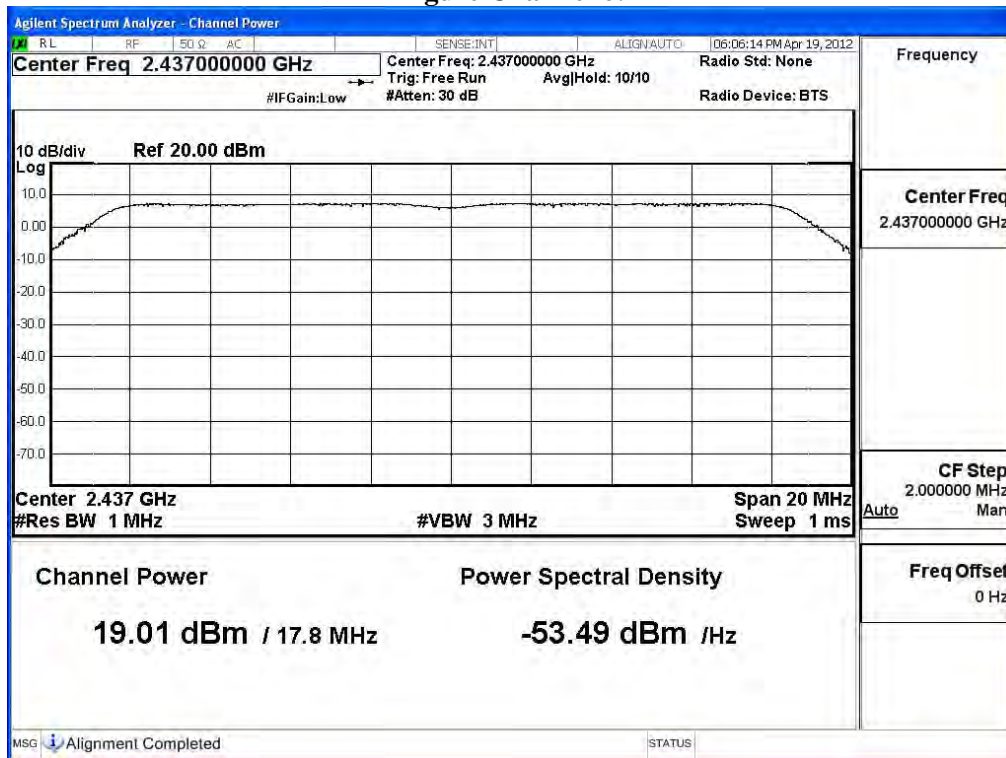
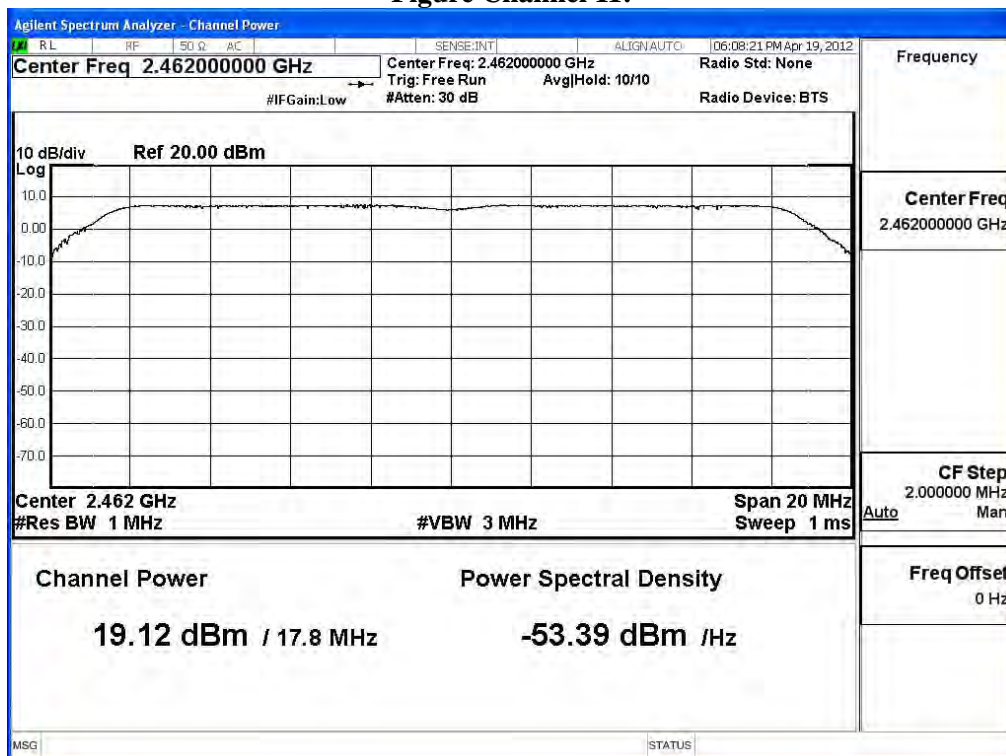

Figure Channel 11:



Product : PS1 Speaker
 Test Item : Peak Power Output Data
 Test Site : No.3 OATS
 Test Mode : Mode 4: Transmit - 802.11n-40BW_15Mbps(2.4G Band) main chip_162

| Channel No | Frequency (MHz) | Average Power For different Data Rate (Mbps) | | | | | | | | Peak Power |
|------------|-----------------|---|-------|-------|-------|-------|-------|-------|-------|------------|
| | | 15 | 30 | 45 | 60 | 90 | 120 | 135 | 150 | |
| | | Measurement Level (dBm) | | | | | | | | |
| 3 | 2422 | 11.88 | -- | -- | -- | -- | -- | -- | -- | 18.95 |
| 6 | 2437 | 12.04 | 12.01 | 11.99 | 11.97 | 11.95 | 11.94 | 11.91 | 11.88 | 19.20 |
| 9 | 2452 | 11.71 | -- | -- | -- | -- | -- | -- | -- | 18.83 |

Note:

1. Peak Power Output Value = Reading value on Spectrum Analyzer + cable loss
(Use the spectrum analyzer's integrated channel power measurement function)
2. Average Power for different data rate = Reading value on Power Meter +cable loss

Figure Channel 3:

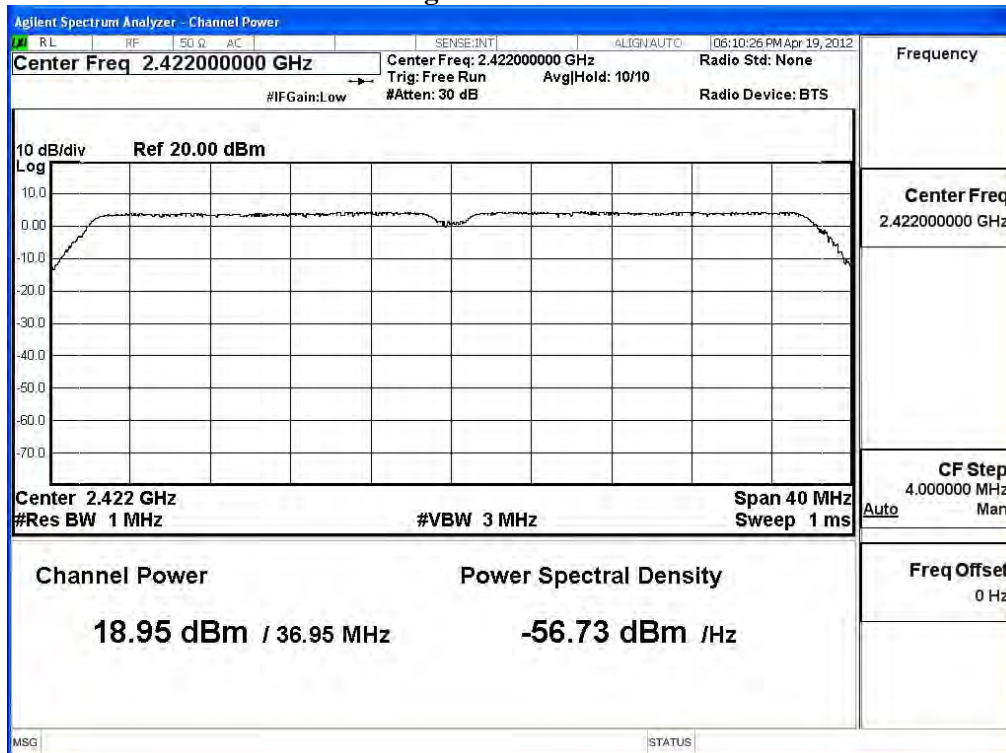

Figure Channel 6:

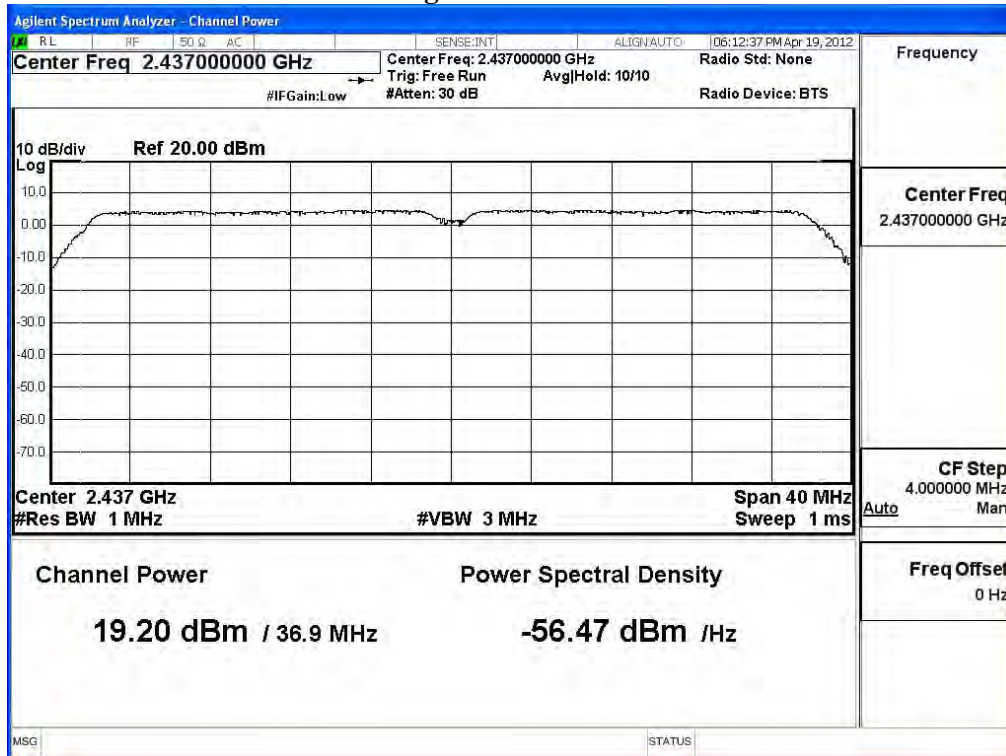
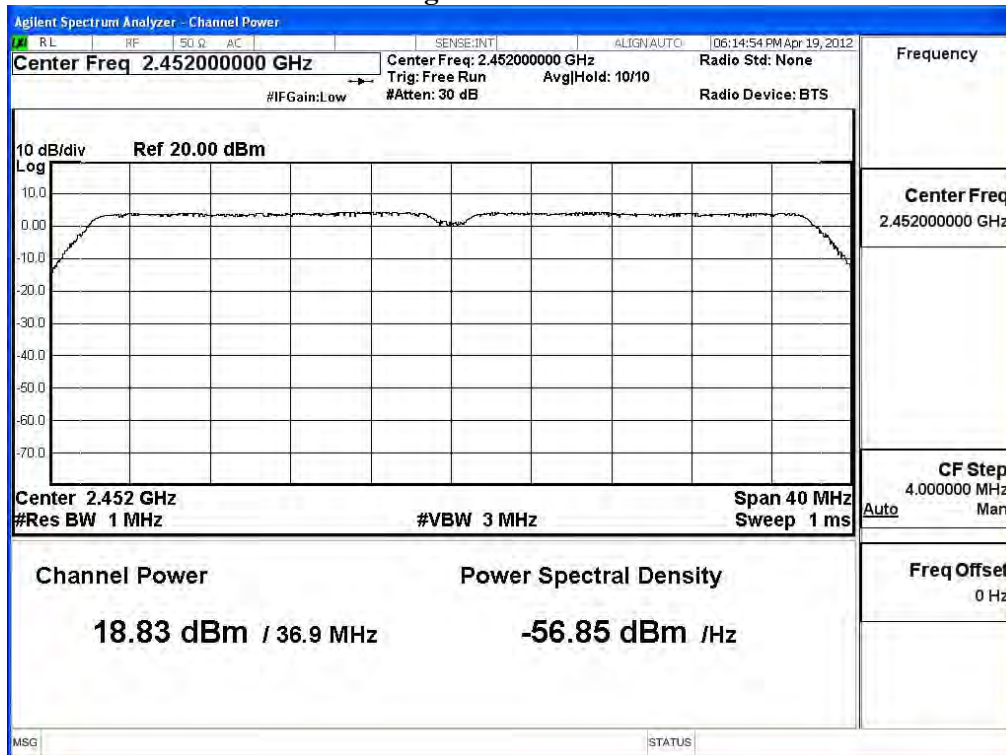

Figure Channel 9:



Product : PS1 Speaker
 Test Item : Peak Power Output Data
 Test Site : No.3 OATS
 Test Mode : Mode 1: Transmit (802.11b 1Mbps) main chip_166

| Channel No | Frequency (MHz) | Average Power For different Data Rate (Mbps) | | | | Peak Power 1 | Required Limit | Result |
|------------|-----------------|---|-------|-------|-------|-----------------|----------------|--------|
| | | 1 | 2 | 5.5 | 11 | | | |
| | | Measurement Level (dBm) | | | | | | |
| 01 | 2412 | 15.28 | -- | -- | -- | 17.48 | <30dBm | Pass |
| 06 | 2437 | 15.13 | 15.11 | 15.07 | 15.03 | 16.52 | <30dBm | Pass |
| 11 | 2462 | 13.77 | -- | -- | -- | 15.75 | <30dBm | Pass |

Note:

1. Peak Power Output Value = Reading value on Spectrum Analyzer + cable loss
(Use the spectrum analyzer's integrated channel power measurement function)
2. Average Power for different data rate = Reading value on Power Meter +cable loss

Figure Channel 1:

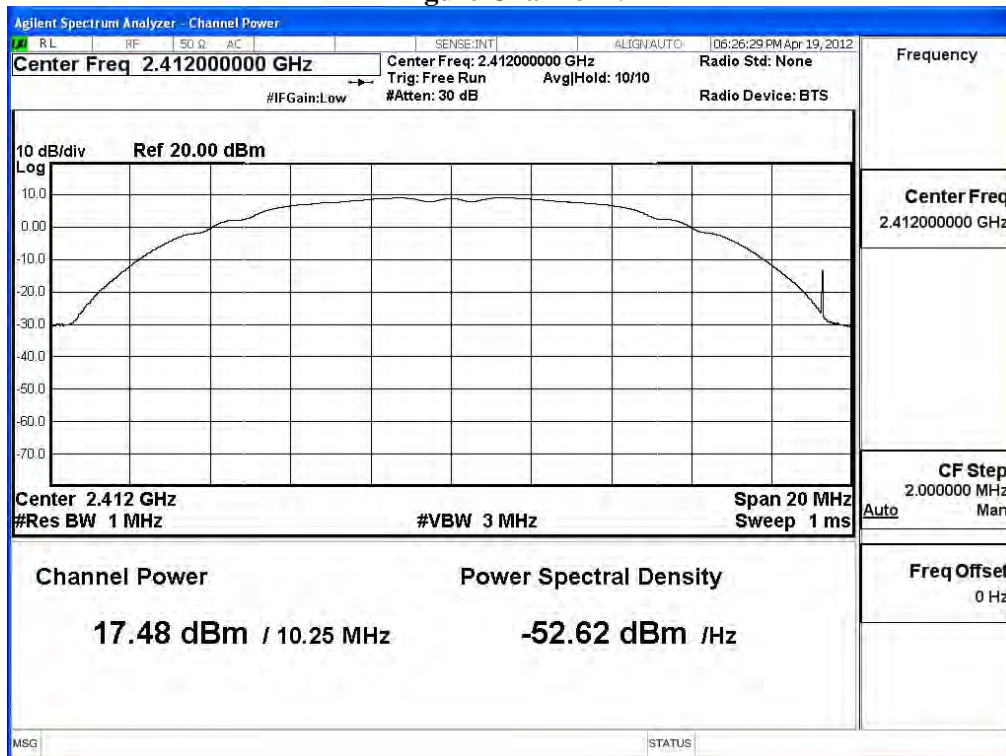

Figure Channel 6:

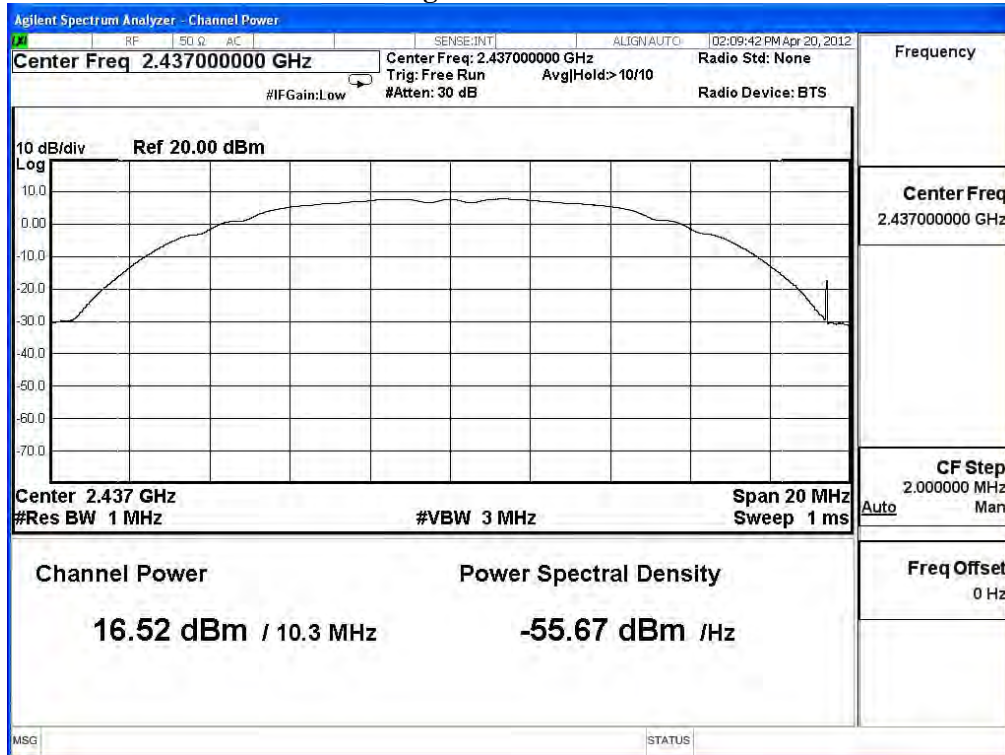
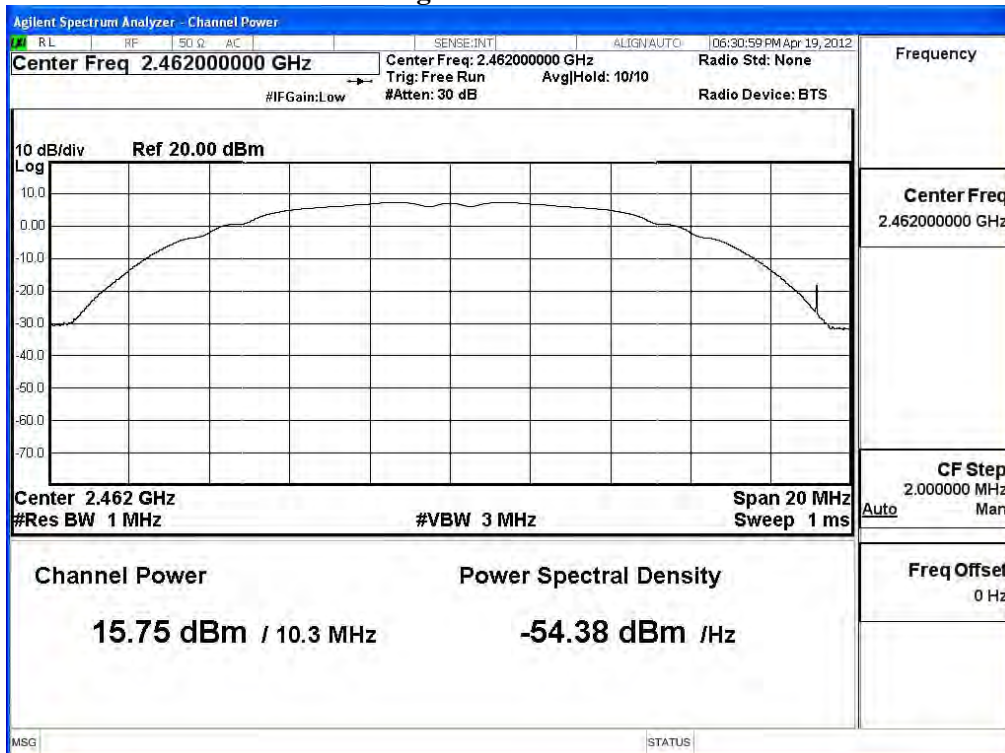

Figure Channel 11:



Product : PS1 Speaker
 Test Item : Peak Power Output Data
 Test Site : No.3 OATS
 Test Mode : Mode 2: Transmit (802.11g 6Mbps) main chip_166

| Channel No | Frequency (MHz) | Average Power For different Data Rate (Mbps) | | | | | | | | Peak Power | Required Limit | Result |
|------------|-----------------|--|------|-------|-------|-------|----|-------|-------|------------|----------------|--------|
| | | 6 | 9 | 12 | 18 | 24 | 36 | 48 | 54 | | | |
| | | Measurement Level (dBm) | | | | | | | | | | |
| 01 | 2412 | 12.37 | -- | -- | -- | -- | -- | -- | -- | 19.20 | <30dBm | Pass |
| 06 | 2437 | 12.13 | 12.1 | 12.08 | 12.05 | 12.04 | 12 | 11.98 | 11.95 | 18.68 | <30dBm | Pass |
| 11 | 2462 | 12.22 | -- | -- | -- | -- | -- | -- | -- | 17.99 | <30dBm | Pass |

Note:

1. Peak Power Output Value = Reading value on Spectrum Analyzer + cable loss
 (Use the spectrum analyzer's integrated channel power measurement function)
2. Average Power for different data rate = Reading value on Power Meter + cable loss

Figure Channel 1:

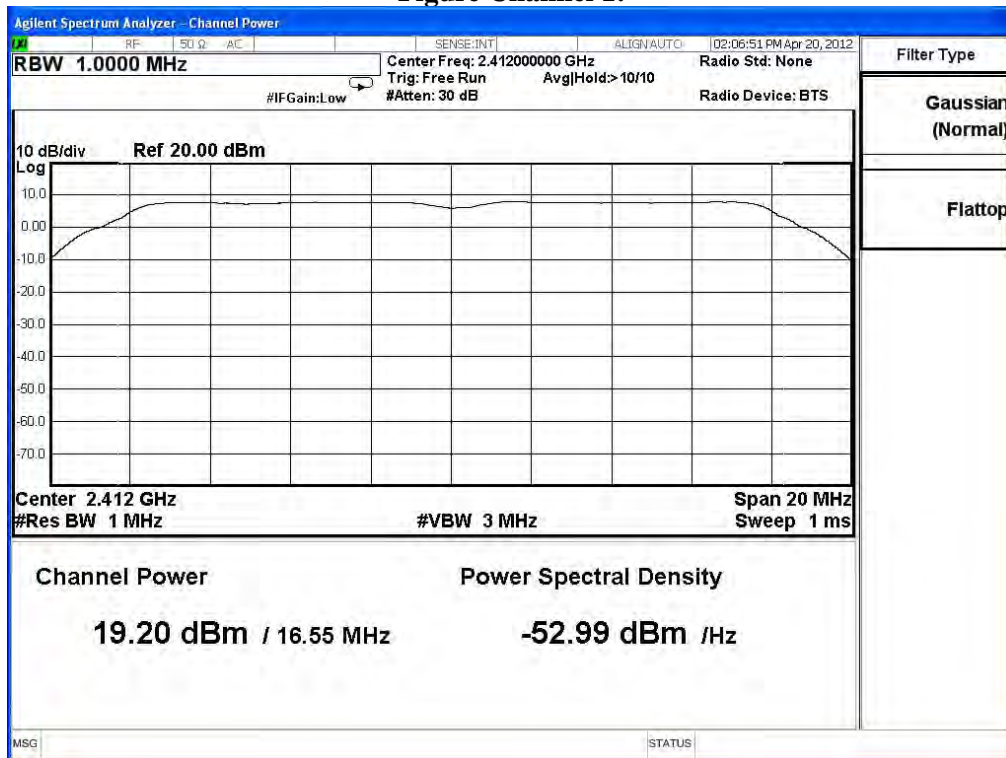

Figure Channel 6:

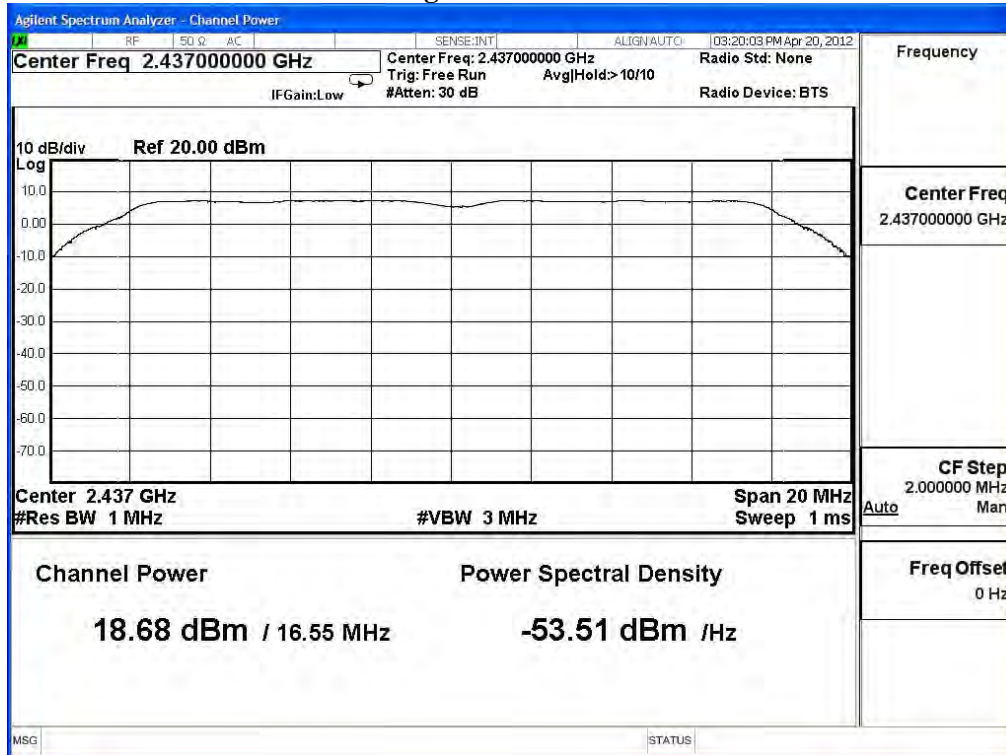
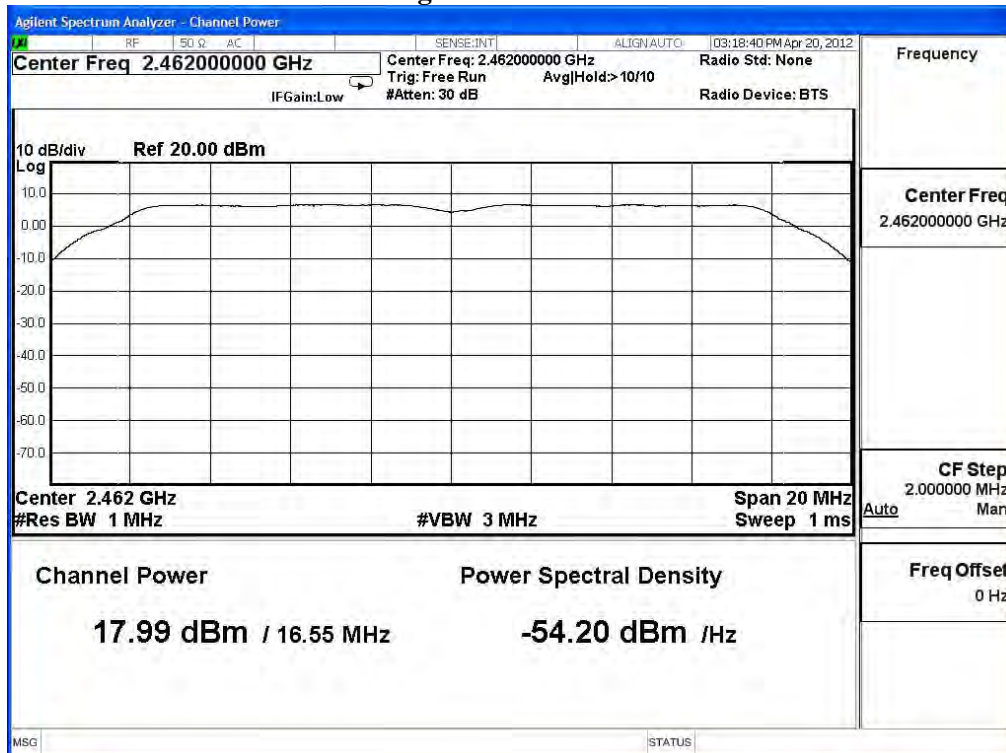

Figure Channel 11:



Product : PS1 Speaker
 Test Item : Peak Power Output Data
 Test Site : No.3 OATS
 Test Mode : Mode 3: Transmit - 802.11n-20BW_7.2Mbps(2.4G Band) main chip_166

| Channel No | Frequency (MHz) | Average Power For different Data Rate (Mbps) | | | | | | | | Peak Power |
|------------|-----------------|---|-------|-------|-------|-------|-------|-------|-------|------------|
| | | 7.2 | 14.4 | 21.7 | 28.9 | 43.3 | 57.8 | 65 | 72.2 | |
| | | Measurement Level (dBm) | | | | | | | | |
| 01 | 2412 | 12.26 | -- | -- | -- | -- | -- | -- | -- | 19.46 |
| 06 | 2437 | 12.06 | 12.03 | 11.99 | 11.98 | 11.95 | 11.93 | 11.91 | 11.87 | 19.40 |
| 11 | 2462 | 12.22 | -- | -- | -- | -- | -- | -- | -- | 19.48 |

Note:

1. Peak Power Output Value = Reading value on Spectrum Analyzer + cable loss
(Use the spectrum analyzer's integrated channel power measurement function)
2. Average Power for different data rate = Reading value on Power Meter + cable loss

Figure Channel 1:

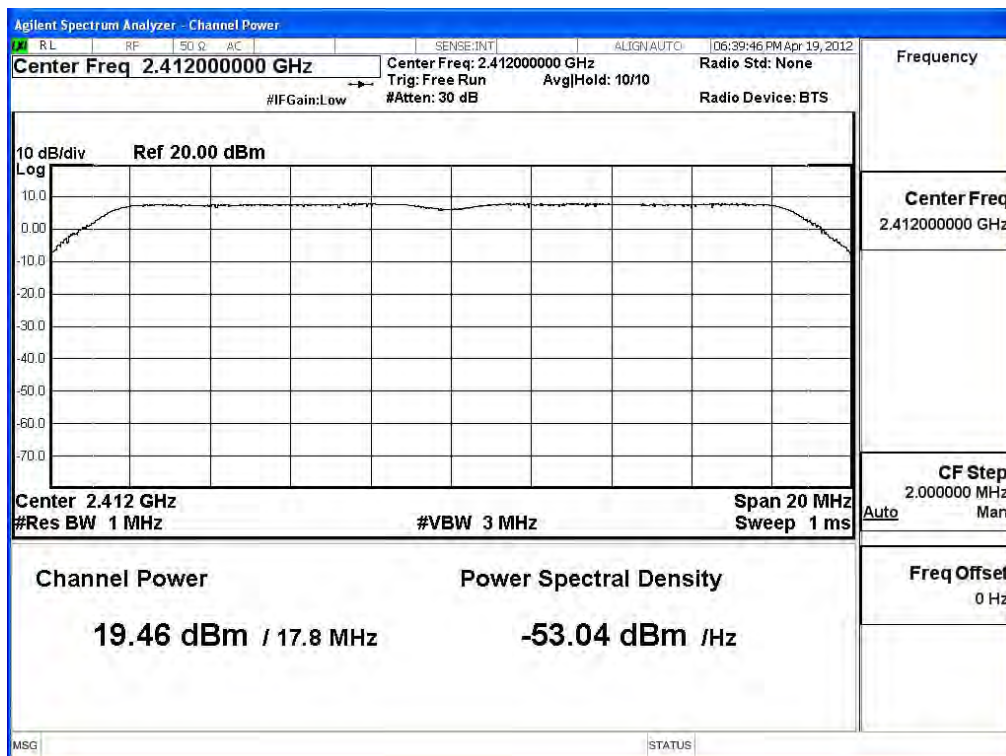

Figure Channel 6:

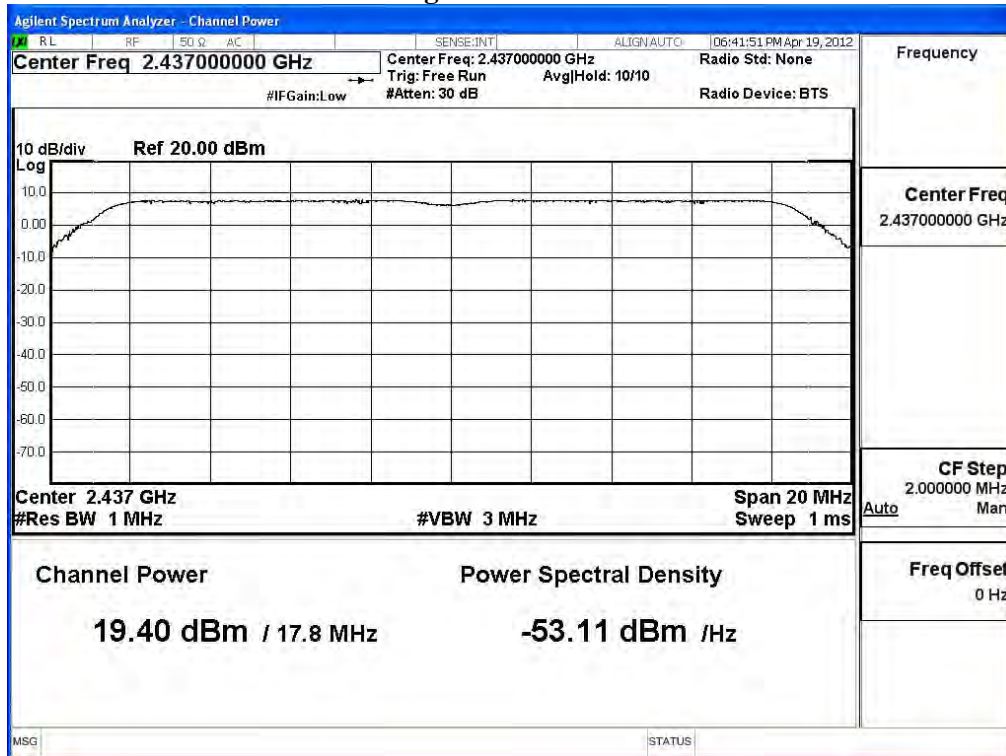
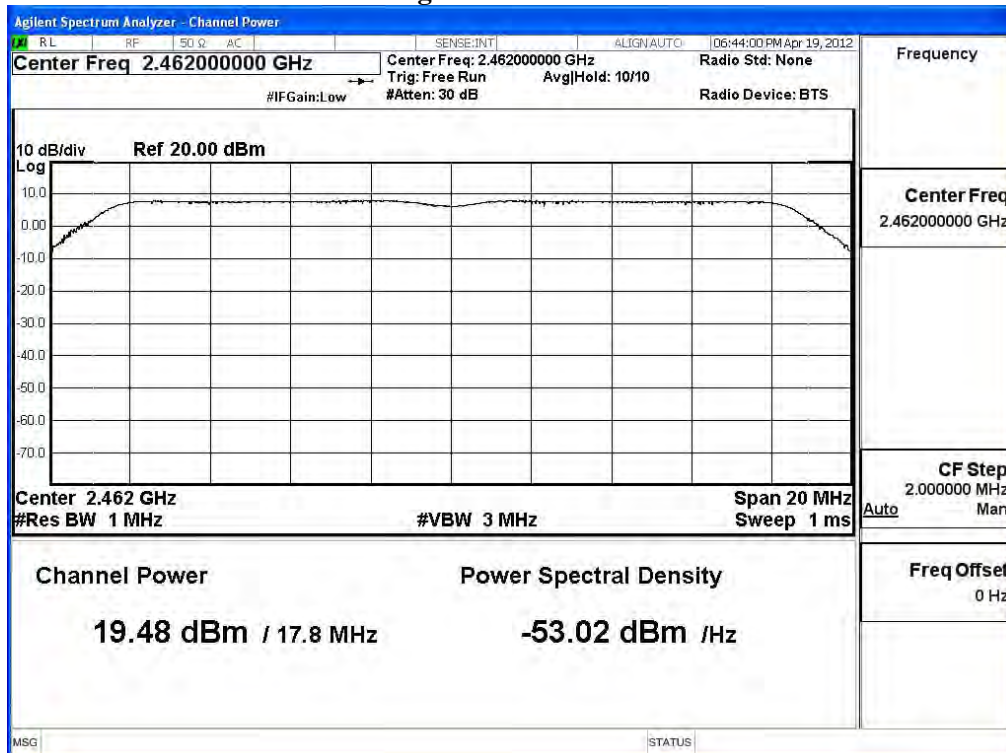

Figure Channel 11:



Product : PS1 Speaker
 Test Item : Peak Power Output Data
 Test Site : No.3 OATS
 Test Mode : Mode 4: Transmit - 802.11n-40BW_15Mbps(2.4G Band) main chip_166

| Channel No | Frequency (MHz) | Average Power For different Data Rate (Mbps) | | | | | | | | Peak Power |
|------------|-----------------|---|-------|-------|-------|-------|-------|-------|-------|------------|
| | | 15 | 30 | 45 | 60 | 90 | 120 | 135 | 150 | 15 |
| | | Measurement Level (dBm) | | | | | | | | |
| 3 | 2422 | 12.32 | -- | -- | -- | -- | -- | -- | -- | 19.32 |
| 6 | 2437 | 12.43 | 12.41 | 12.38 | 12.35 | 12.34 | 12.31 | 12.29 | 12.25 | 19.50 |
| 9 | 2452 | 12.14 | -- | -- | -- | -- | -- | -- | -- | 19.14 |

Note:

1. Peak Power Output Value = Reading value on Spectrum Analyzer + cable loss
(Use the spectrum analyzer's integrated channel power measurement function)
2. Average Power for different data rate = Reading value on Power Meter +cable loss

Figure Channel 3:

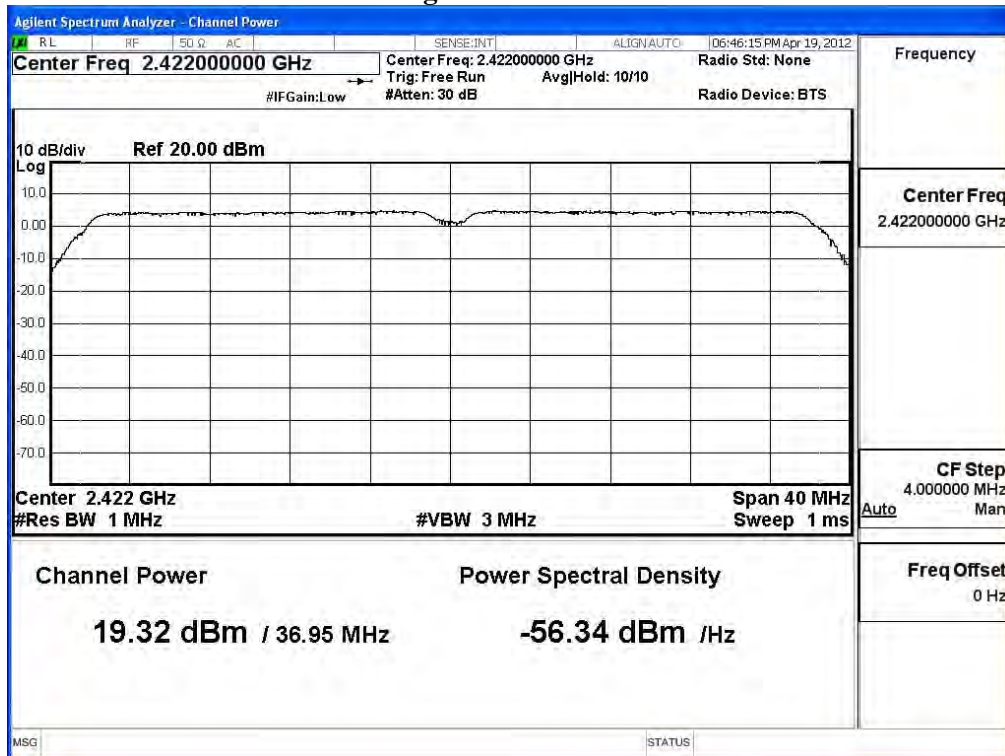

Figure Channel 6:

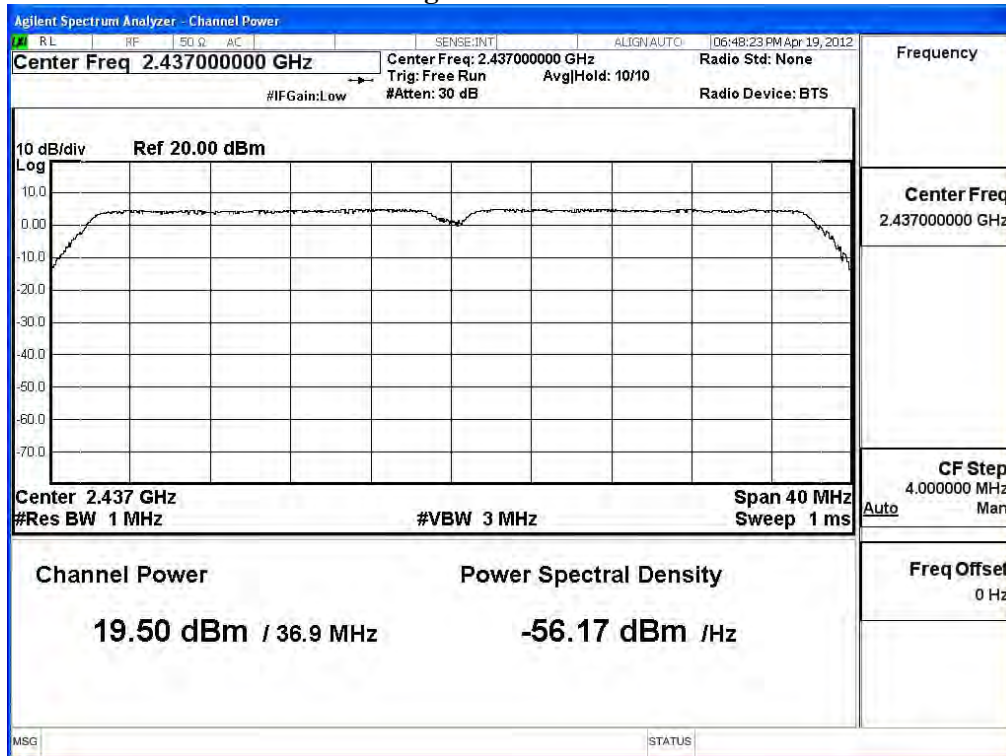
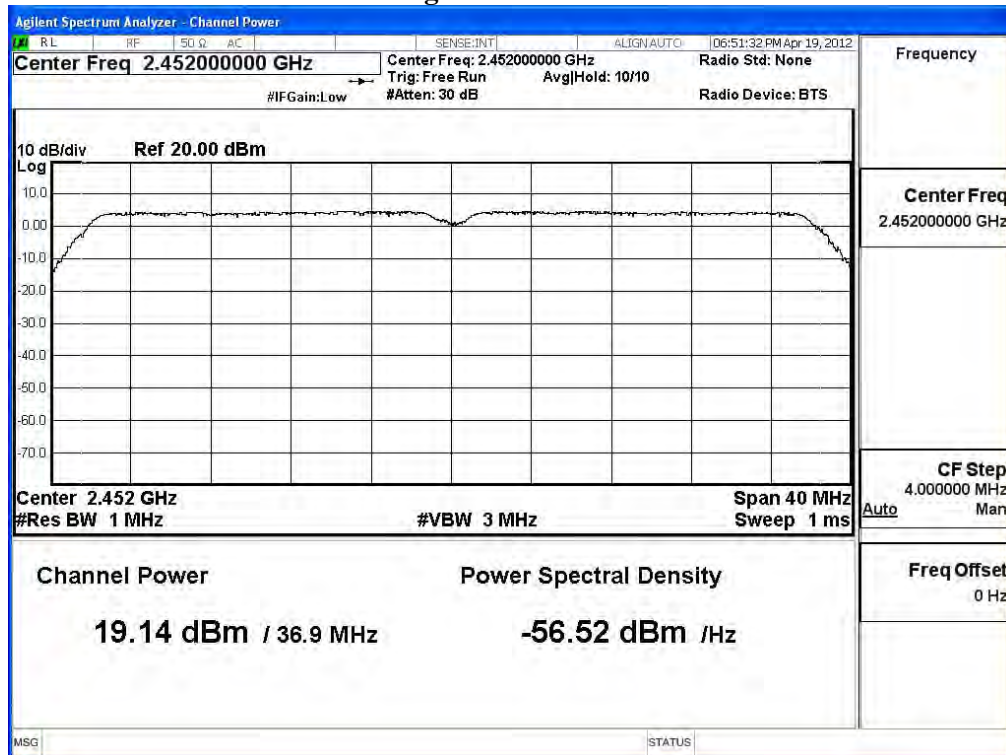

Figure Channel 9:



4. Radiated Emission

4.1. Test Equipment

The following test equipment are used during the radiated emission test:

| Test Site | Equipment | Manufacturer | Model No./Serial No. | Last Cal. |
|------------|---------------------|-----------------|-----------------------------|------------|
| ☒ Site # 3 | X Bilog Antenna | Schaffner Chase | CBL6112B/2673 | Sep., 2012 |
| | X Horn Antenna | Schwarzbeck | BBHA9120D/D305 | Sep., 2012 |
| | X Horn Antenna | Schwarzbeck | BBHA9170/208 | Jul., 2012 |
| | X Pre-Amplifier | QTK | QTK-AMP-03 / 0003 | May, 2012 |
| | X Pre-Amplifier | QTK | AP-180C / CHM_0906076 | Sep., 2012 |
| | X Pre-Amplifier | MITEQ | AMF-4D-180400-45-6P/ 925975 | Mar, 2012 |
| | X Spectrum Analyzer | Agilent | E4407B / US39440758 | May, 2012 |
| | X Test Receiver | R & S | ESCS 30/ 825442/018 | Sep., 2012 |
| | X Coaxial Cable | Quietek | QTK-CABLE/ CAB5 | Feb., 2012 |
| | X Controller | Quietek | QTK-CONTROLLER/ CTRL3 | N/A |
| | X Coaxial Switch | Anritsu | MP59B/6200265729 | N/A |

- Note:
1. All equipments are calibrated with traceable calibrations. Each calibration is traceable to the national or international standards.
 2. The test instruments marked with “X” are used to measure the final test results.

4.2. Test Setup

Radiated Emission Below 1GHz

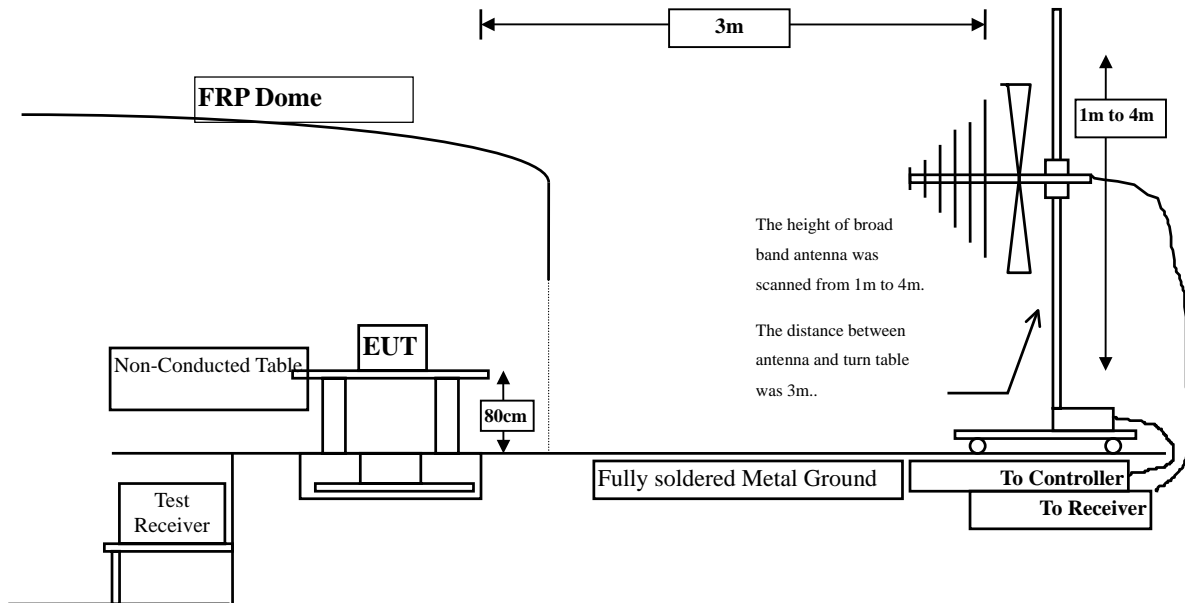

Radiated Emission Above 1GHz

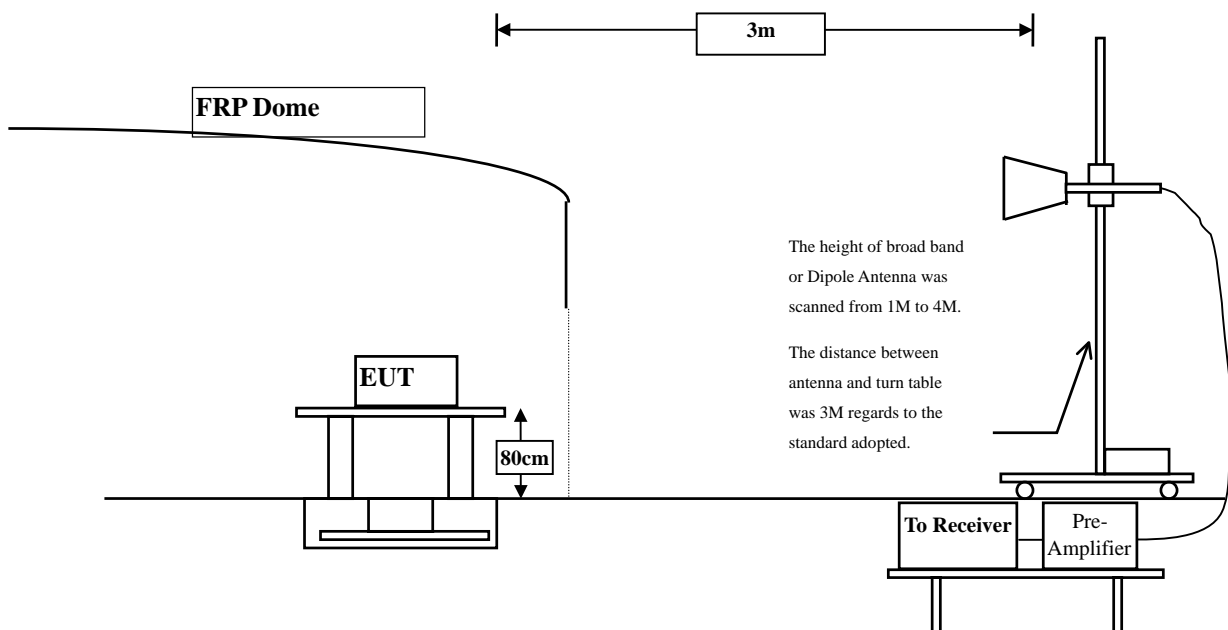

4.3. Limits

Emissions radiated outside of the specified frequency bands, except for harmonics, shall be attenuated by at least 20dB below the level of the fundamental or to the general radiated emission limits in paragraph 15.209, whichever is the lesser attenuation.

| FCC Part 15 Subpart C Paragraph 15.209(a) Limits | | |
|---|----------|-----------|
| Frequency MHz | uV/m @3m | dBuV/m@3m |
| 30-88 | 100 | 40 |
| 88-216 | 150 | 43.5 |
| 216-960 | 200 | 46 |
| Above 960 | 500 | 54 |

Remarks: E field strength (dBuV/m) = 20 log E field strength (uV/m)

4.4. Test Procedure

The EUT was setup according to ANSI C63.4, 2003 and tested according to DTS test procedure of ANSI C63.10: 2009 for compliance to FCC 47CFR 15.247 requirements.

The EUT is placed on a turn table which is 0.8 meter above ground. The turn table is rotated 360 degrees to determine the position of the maximum emission level. The EUT was positioned such that the distance from antenna to the EUT was 3 meters.

The antenna is scanned between 1 meter and 4 meters to find out the maximum emission level. This is repeated for both horizontal and vertical polarization of the antenna. In order to find the maximum emission, all of the interface cables were manipulated according to ANSI C63.4:2003 on radiated measurement.

The resolution bandwidth below 1GHz setting on the field strength meter is 120 kHz and above 1GHz is 1MHz.

Radiated emission measurements below 1GHz are made using broadband Bilog antenna and above 1GHz are made using Horn Antennas.

The measurement is divided into the Preliminary Measurement and the Final Measurement.

The suspected frequencies are searched for in Preliminary Measurement with the measurement antenna kept pointed at the source of the emission both in azimuth and elevation, with the polarization of the antenna oriented for maximum response. The antenna is pointed at an angle towards the source of the emission, and the EUT is rotated in both height and polarization to maximize the measured emission. The emission is kept within the illumination area of the 3 dB bandwidth of the antenna.

The worst radiated emission is measured in the Open Area Test Site on the Final Measurement.

The measurement frequency range form 30MHz - 10th Harmonic of fundamental was investigated.

4.5. Uncertainty

± 3.9 dB above 1GHz

± 3.8 dB below 1GHz

4.6. Test Result of Radiated Emission

Product : PS1 Speaker
 Test Item : Harmonic Radiated Emission Data
 Test Site : No.3 OATS
 Test Mode : Mode 1: Transmit (802.11b 1Mbps) (2412MHz) main chip_162

| Frequency MHz | Correct Factor dB | Reading Level dBuV | Measurement Level dBuV/m | Margin dB | Limit dBuV/m |
|--------------------------|-------------------------|--------------------------|--------------------------------|--------------|-----------------|
| Horizontal | | | | | |
| Peak Detector: | | | | | |
| 4824.000 | 3.261 | 43.180 | 46.441 | -27.559 | 74.000 |
| 7236.000 | 10.650 | 39.540 | 50.190 | -23.810 | 74.000 |
| 9648.000 | 13.337 | 37.380 | 50.716 | -23.284 | 74.000 |
| Average Detector: | | | | | |
| -- | | | | | |
| Vertical | | | | | |
| Peak Detector: | | | | | |
| 4824.000 | 6.421 | 45.890 | 52.311 | -21.689 | 74.000 |
| 7236.000 | 11.495 | 40.970 | 52.465 | -21.535 | 74.000 |
| 9648.000 | 13.807 | 39.460 | 53.266 | -20.734 | 74.000 |
| Average Detector: | | | | | |
| -- | | | | | |

Note:

1. All Readings below 1GHz are Quasi-Peak, above 1GHz are performed with peak and/or average measurements as necessary.
2. Peak measurements: RBW = 1MHz, VBW = 3 MHz, Sweep: Auto.
3. Average measurements: RBW = 1MHz, VBW = 10 Hz, Sweep: Auto.
4. Measurement Level = Reading Level + Correct Factor.
5. Correct Factor = Antenna factor + Cable loss – Amplifier gain.
6. The average measurement was not performed when the peak measured data under the limit of average detection.
7. The emission levels of other frequencies are very lower than the limit and not show in test report.

Product : PS1 Speaker
 Test Item : Harmonic Radiated Emission Data
 Test Site : No.3 OATS
 Test Mode : Mode 1: Transmit (802.11b 1Mbps) (2437 MHz) main chip_162

| Frequency MHz | Correct Factor dB | Reading Level dBuV | Measurement Level dBuV/m | Margin dB | Limit dBuV/m |
|--------------------------|-------------------------|--------------------------|--------------------------------|--------------|-----------------|
| Horizontal | | | | | |
| Peak Detector: | | | | | |
| 4874.000 | 3.038 | 43.140 | 46.177 | -27.823 | 74.000 |
| 7311.000 | 11.795 | 38.870 | 50.664 | -23.336 | 74.000 |
| 9748.000 | 12.635 | 37.550 | 50.185 | -23.815 | 74.000 |
| Average Detector: | | | | | |
| -- | | | | | |
| Vertical | | | | | |
| Peak Detector: | | | | | |
| 4874.000 | 5.812 | 49.210 | 55.021 | -18.979 | 74.000 |
| 7311.000 | 12.630 | 39.990 | 52.619 | -21.381 | 74.000 |
| 9748.000 | 13.126 | 42.330 | 55.456 | -18.544 | 74.000 |
| Average Detector: | | | | | |
| 4874.000 | 5.812 | 46.990 | 52.801 | -1.199 | 54.000 |
| 9748.000 | 13.126 | 36.870 | 49.996 | -4.004 | 54.000 |

Note:

1. All Readings below 1GHz are Quasi-Peak, above 1GHz are performed with peak and/or average measurements as necessary.
2. Peak measurements: RBW = 1MHz, VBW = 3 MHz, Sweep: Auto.
3. Average measurements: RBW = 1MHz, VBW = 10 Hz, Sweep: Auto.
4. Measurement Level = Reading Level + Correct Factor.
5. Correct Factor = Antenna factor + Cable loss – Amplifier gain.
6. The average measurement was not performed when the peak measured data under the limit of average detection.
7. The emission levels of other frequencies are very lower than the limit and not show in test report.

Product : PS1 Speaker
 Test Item : Harmonic Radiated Emission Data
 Test Site : No.3 OATS
 Test Mode : Mode 1: Transmit (802.11b 1Mbps) (2462 MHz) main chip_162

| Frequency MHz | Correct Factor dB | Reading Level dBuV | Measurement Level dBuV/m | Margin dB | Limit dBuV/m |
|--------------------------|-------------------------|--------------------------|--------------------------------|--------------|-----------------|
| Horizontal | | | | | |
| Peak Detector: | | | | | |
| 4924.000 | 2.858 | 43.580 | 46.437 | -27.563 | 74.000 |
| 7386.000 | 12.127 | 37.380 | 49.508 | -24.492 | 74.000 |
| 9848.000 | 12.852 | 37.360 | 50.213 | -23.787 | 74.000 |
| Average Detector: | | | | | |
| -- | | | | | |
| Vertical | | | | | |
| Peak Detector: | | | | | |
| 4924.000 | 5.521 | 49.300 | 54.820 | -19.180 | 74.000 |
| 7386.000 | 13.254 | 37.690 | 50.944 | -23.056 | 74.000 |
| 9848.000 | 13.367 | 41.200 | 54.567 | -19.433 | 74.000 |
| Average Detector: | | | | | |
| 4924.000 | 5.521 | 47.050 | 52.570 | -1.430 | 54.000 |
| 9848.000 | 13.367 | 35.310 | 48.677 | -5.323 | 54.000 |

Note:

1. All Readings below 1GHz are Quasi-Peak, above 1GHz are performed with peak and/or average measurements as necessary.
2. Peak measurements: RBW = 1MHz, VBW = 3 MHz, Sweep: Auto.
3. Average measurements: RBW = 1MHz, VBW = 10 Hz, Sweep: Auto.
4. Measurement Level = Reading Level + Correct Factor.
5. Correct Factor = Antenna factor + Cable loss – Amplifier gain.
6. The average measurement was not performed when the peak measured data under the limit of average detection.
7. The emission levels of other frequencies are very lower than the limit and not show in test report.

Product : PS1 Speaker
 Test Item : Harmonic Radiated Emission Data
 Test Site : No.3 OATS
 Test Mode : Mode 2: Transmit (802.11g 6Mbps) (2412MHz) main chip_162

| Frequency MHz | Correct Factor dB | Reading Level dBuV | Measurement Level dBuV/m | Margin dB | Limit dBuV/m |
|--------------------------|-------------------------|--------------------------|--------------------------------|--------------|-----------------|
| Horizontal | | | | | |
| Peak Detector: | | | | | |
| 4824.000 | 3.261 | 37.850 | 41.111 | -32.889 | 74.000 |
| 7236.000 | 10.650 | 39.540 | 50.190 | -23.810 | 74.000 |
| 9648.000 | 13.337 | 36.040 | 49.376 | -24.624 | 74.000 |
| Average Detector: | | | | | |
| -- | | | | | |
| Vertical | | | | | |
| Peak Detector: | | | | | |
| 4824.000 | 6.421 | 42.640 | 49.061 | -24.939 | 74.000 |
| 7236.000 | 11.495 | 41.340 | 52.835 | -21.165 | 74.000 |
| 9648.000 | 13.807 | 36.340 | 50.146 | -23.854 | 74.000 |
| Average Detector: | | | | | |
| -- | | | | | |

Note:

1. All Readings below 1GHz are Quasi-Peak, above 1GHz are performed with peak and/or average measurements as necessary.
2. Peak measurements: RBW = 1MHz, VBW = 3 MHz, Sweep: Auto.
3. Average measurements: RBW = 1MHz, VBW = 10 Hz, Sweep: Auto.
4. Measurement Level = Reading Level + Correct Factor.
5. Correct Factor = Antenna factor + Cable loss – Amplifier gain.
6. The average measurement was not performed when the peak measured data under the limit of average detection.
7. The emission levels of other frequencies are very lower than the limit and not show in test report.

Product : PS1 Speaker
 Test Item : Harmonic Radiated Emission Data
 Test Site : No.3 OATS
 Test Mode : Mode 2: Transmit (802.11g 6Mbps) (2437 MHz) main chip_162

| Frequency MHz | Correct Factor dB | Reading Level dBUV | Measurement Level dBUV/m | Margin dB | Limit dBUV/m |
|--------------------------|-------------------------|--------------------------|--------------------------------|--------------|-----------------|
| Horizontal | | | | | |
| Peak Detector: | | | | | |
| 4874.000 | 3.038 | 38.060 | 41.097 | -32.903 | 74.000 |
| 7311.000 | 11.795 | 36.850 | 48.644 | -25.356 | 74.000 |
| 9748.000 | 12.635 | 36.530 | 49.165 | -24.835 | 74.000 |
| Average Detector: | | | | | |
| -- | | | | | |
| Vertical | | | | | |
| Peak Detector: | | | | | |
| 4874.000 | 5.812 | 44.250 | 50.061 | -23.939 | 74.000 |
| 7311.000 | 12.630 | 40.470 | 53.099 | -20.901 | 74.000 |
| 9748.000 | 13.126 | 36.650 | 49.776 | -24.224 | 74.000 |
| Average Detector: | | | | | |
| -- | | | | | |

Note:

1. All Readings below 1GHz are Quasi-Peak, above 1GHz are performed with peak and/or average measurements as necessary.
2. Peak measurements: RBW = 1MHz, VBW = 3 MHz, Sweep: Auto.
3. Average measurements: RBW = 1MHz, VBW = 10 Hz, Sweep: Auto.
4. Measurement Level = Reading Level + Correct Factor.
5. Correct Factor = Antenna factor + Cable loss – Amplifier gain.
6. The average measurement was not performed when the peak measured data under the limit of average detection.
7. The emission levels of other frequencies are very lower than the limit and not show in test report.

Product : PS1 Speaker
 Test Item : Harmonic Radiated Emission Data
 Test Site : No.3 OATS
 Test Mode : Mode 2: Transmit (802.11g 6Mbps) (2462 MHz) main chip_162

| Frequency MHz | Correct Factor dB | Reading Level dBuV | Measurement Level dBuV/m | Margin dB | Limit dBuV/m |
|--------------------------|-------------------------|--------------------------|--------------------------------|--------------|-----------------|
| Horizontal | | | | | |
| Peak Detector: | | | | | |
| 4924.000 | 2.858 | 41.070 | 43.927 | -30.073 | 74.000 |
| 7386.000 | 12.127 | 36.280 | 48.408 | -25.592 | 74.000 |
| 9848.000 | 12.852 | 36.480 | 49.333 | -24.667 | 74.000 |
| Average Detector: | | | | | |
| -- | | | | | |
| Vertical | | | | | |
| Peak Detector: | | | | | |
| 4924.000 | 5.521 | 45.780 | 51.300 | -22.700 | 74.000 |
| 7386.000 | 13.254 | 37.310 | 50.564 | -23.436 | 74.000 |
| 9848.000 | 13.367 | 36.890 | 50.257 | -23.743 | 74.000 |
| Average Detector: | | | | | |
| -- | | | | | |

Note:

1. All Readings below 1GHz are Quasi-Peak, above 1GHz are performed with peak and/or average measurements as necessary.
2. Peak measurements: RBW = 1MHz, VBW = 3 MHz, Sweep: Auto.
3. Average measurements: RBW = 1MHz, VBW = 10 Hz, Sweep: Auto.
4. Measurement Level = Reading Level + Correct Factor.
5. Correct Factor = Antenna factor + Cable loss – Amplifier gain.
6. The average measurement was not performed when the peak measured data under the limit of average detection.
7. The emission levels of other frequencies are very lower than the limit and not show in test report.

Product : PS1 Speaker
 Test Item : Harmonic Radiated Emission Data
 Test Site : No.3 OATS
 Test Mode : Mode 3: Transmit - 802.11n-20BW_7.2Mbps(2.4G Band) (2412MHz)
 main chip_162

| Frequency MHz | Correct Factor dB | Reading Level dBuV | Measurement Level dBuV/m | Margin dB | Limit dBuV/m |
|--------------------------|-------------------------|--------------------------|--------------------------------|--------------|-----------------|
| Horizontal | | | | | |
| Peak Detector: | | | | | |
| 4824.000 | 3.261 | 37.550 | 40.811 | -33.189 | 74.000 |
| 7236.000 | 10.650 | 40.530 | 51.180 | -22.820 | 74.000 |
| 9648.000 | 13.337 | 35.760 | 49.096 | -24.904 | 74.000 |
| Average Detector: | | | | | |
| -- | | | | | |
| Vertical | | | | | |
| Peak Detector: | | | | | |
| 4824.000 | 6.421 | 42.650 | 49.071 | -24.929 | 74.000 |
| 7236.000 | 11.495 | 42.660 | 54.155 | -19.845 | 74.000 |
| 9648.000 | 13.807 | 35.940 | 49.746 | -24.254 | 74.000 |
| Average Detector: | | | | | |
| 7236.000 | 11.495 | 24.790 | 36.285 | -17.715 | 54.000 |

Note:

1. All Readings below 1GHz are Quasi-Peak, above 1GHz are performed with peak and/or average measurements as necessary.
2. Peak measurements: RBW = 1MHz, VBW = 3 MHz, Sweep: Auto.
3. Average measurements: RBW = 1MHz, VBW = 10 Hz, Sweep: Auto.
4. Measurement Level = Reading Level + Correct Factor.
5. Correct Factor = Antenna factor + Cable loss – Amplifier gain.
6. The average measurement was not performed when the peak measured data under the limit of average detection.
7. The emission levels of other frequencies are very lower than the limit and not show in test report.

Product : PS1 Speaker
 Test Item : Harmonic Radiated Emission Data
 Test Site : No.3 OATS
 Test Mode : Mode 3: Transmit - 802.11n-20BW_7.2Mbps(2.4G Band) (2437 MHz)
 main chip_162

| Frequency MHz | Correct Factor dB | Reading Level dBuV | Measurement Level dBuV/m | Margin dB | Limit dBuV/m |
|--------------------------|-------------------------|--------------------------|--------------------------------|--------------|-----------------|
| Horizontal | | | | | |
| Peak Detector: | | | | | |
| 4874.000 | 3.038 | 40.650 | 43.687 | -30.313 | 74.000 |
| 7311.000 | 11.795 | 38.450 | 50.244 | -23.756 | 74.000 |
| 9748.000 | 12.635 | 36.410 | 49.045 | -24.955 | 74.000 |
| Average Detector: | | | | | |
| -- | | | | | |
| Vertical | | | | | |
| Peak Detector: | | | | | |
| 4874.000 | 5.812 | 45.360 | 51.171 | -22.829 | 74.000 |
| 7311.000 | 12.630 | 41.060 | 53.689 | -20.311 | 74.000 |
| 9748.000 | 13.126 | 36.560 | 49.686 | -24.314 | 74.000 |
| Average Detector: | | | | | |
| -- | | | | | |

Note:

1. All Readings below 1GHz are Quasi-Peak, above 1GHz are performed with peak and/or average measurements as necessary.
2. Peak measurements: RBW = 1MHz, VBW = 3 MHz, Sweep: Auto.
3. Average measurements: RBW = 1MHz, VBW = 10 Hz, Sweep: Auto.
4. Measurement Level = Reading Level + Correct Factor.
5. Correct Factor = Antenna factor + Cable loss – Amplifier gain.
6. The average measurement was not performed when the peak measured data under the limit of average detection.
7. The emission levels of other frequencies are very lower than the limit and not show in test report.

Product : PS1 Speaker
 Test Item : Harmonic Radiated Emission Data
 Test Site : No.3 OATS
 Test Mode : Mode 3: Transmit - 802.11n-20BW_7.2Mbps(2.4G Band) (2462 MHz)
 main chip_162

| Frequency MHz | Correct Factor dB | Reading Level dBUV | Measurement Level dBUV/m | Margin dB | Limit dBUV/m |
|--------------------------|-------------------------|--------------------------|--------------------------------|--------------|-----------------|
| Horizontal | | | | | |
| Peak Detector: | | | | | |
| 4924.000 | 2.858 | 41.530 | 44.387 | -29.613 | 74.000 |
| 7386.000 | 12.127 | 37.970 | 50.098 | -23.902 | 74.000 |
| 9848.000 | 12.852 | 36.920 | 49.773 | -24.227 | 74.000 |
| Average Detector: | | | | | |
| -- | | | | | |
| Vertical | | | | | |
| Peak Detector: | | | | | |
| 4924.000 | 5.521 | 47.660 | 53.180 | -20.820 | 74.000 |
| 7386.000 | 13.254 | 38.300 | 51.554 | -22.446 | 74.000 |
| 9848.000 | 13.367 | 37.220 | 50.587 | -23.413 | 74.000 |
| Average Detector: | | | | | |
| -- | | | | | |

Note:

1. All Readings below 1GHz are Quasi-Peak, above 1GHz are performed with peak and/or average measurements as necessary.
2. Peak measurements: RBW = 1MHz, VBW = 3 MHz, Sweep: Auto.
3. Average measurements: RBW = 1MHz, VBW = 10 Hz, Sweep: Auto.
4. Measurement Level = Reading Level + Correct Factor.
5. Correct Factor = Antenna factor + Cable loss – Amplifier gain.
6. The average measurement was not performed when the peak measured data under the limit of average detection.
7. The emission levels of other frequencies are very lower than the limit and not show in test report.

Product : PS1 Speaker
 Test Item : Harmonic Radiated Emission Data
 Test Site : No.3 OATS
 Test Mode : Mode 4: Transmit - 802.11n-40BW_15Mbps(2.4G Band) (2422MHz)
 main chip_162

| Frequency MHz | Correct Factor dB | Reading Level dBuV | Measurement Level dBuV/m | Margin dB | Limit dBuV/m |
|--------------------------|-------------------------|--------------------------|--------------------------------|--------------|-----------------|
| Horizontal | | | | | |
| Peak Detector: | | | | | |
| 4844.000 | 3.171 | 37.010 | 40.181 | -33.819 | 74.000 |
| 7266.000 | 11.162 | 36.370 | 47.532 | -26.468 | 74.000 |
| 9688.000 | 13.507 | 37.400 | 50.908 | -23.092 | 74.000 |
| Average Detector: | | | | | |
| -- | | | | | |
| Vertical | | | | | |
| Peak Detector: | | | | | |
| 4844.000 | 6.178 | 40.970 | 47.148 | -26.852 | 74.000 |
| 7266.000 | 11.982 | 41.130 | 53.112 | -20.888 | 74.000 |
| 9688.000 | 13.507 | 36.610 | 50.118 | -23.882 | 74.000 |
| Average Detector: | | | | | |
| -- | | | | | |

Note:

1. All Readings below 1GHz are Quasi-Peak, above 1GHz are performed with peak and/or average measurements as necessary.
2. Peak measurements: RBW = 1MHz, VBW = 3 MHz, Sweep: Auto.
3. Average measurements: RBW = 1MHz, VBW = 10 Hz, Sweep: Auto.
4. Measurement Level = Reading Level + Correct Factor.
5. Correct Factor = Antenna factor + Cable loss – Amplifier gain.
6. The average measurement was not performed when the peak measured data under the limit of average detection.
7. The emission levels of other frequencies are very lower than the limit and not show in test report.

Product : PS1 Speaker
 Test Item : Harmonic Radiated Emission Data
 Test Site : No.3 OATS
 Test Mode : Mode 4: Transmit - 802.11n-40BW_15Mbps(2.4G Band) (2437 MHz)
 main chip_162

| Frequency MHz | Correct Factor dB | Reading Level dBuV | Measurement Level dBuV/m | Margin dB | Limit dBuV/m |
|--------------------------|-------------------------|--------------------------|--------------------------------|--------------|-----------------|
| Horizontal | | | | | |
| Peak Detector: | | | | | |
| 4874.000 | 3.038 | 37.310 | 40.347 | -33.653 | 74.000 |
| 7311.000 | 11.795 | 35.640 | 47.434 | -26.566 | 74.000 |
| 9748.000 | 12.635 | 36.890 | 49.525 | -24.475 | 74.000 |
| Average Detector: | | | | | |
| -- | | | | | |
| Vertical | | | | | |
| Peak Detector: | | | | | |
| 4874.000 | 5.812 | 42.860 | 48.671 | -25.329 | 74.000 |
| 7311.000 | 12.630 | 39.400 | 52.029 | -21.971 | 74.000 |
| 9748.000 | 13.126 | 37.200 | 50.326 | -23.674 | 74.000 |
| Average Detector: | | | | | |
| -- | | | | | |

Note:

1. All Readings below 1GHz are Quasi-Peak, above 1GHz are performed with peak and/or average measurements as necessary.
2. Peak measurements: RBW = 1MHz, VBW = 3 MHz, Sweep: Auto.
3. Average measurements: RBW = 1MHz, VBW = 10 Hz, Sweep: Auto.
4. Measurement Level = Reading Level + Correct Factor.
5. Correct Factor = Antenna factor + Cable loss – Amplifier gain.
6. The average measurement was not performed when the peak measured data under the limit of average detection.
7. The emission levels of other frequencies are very lower than the limit and not show in test report.

Product : PS1 Speaker
 Test Item : Harmonic Radiated Emission Data
 Test Site : No.3 OATS
 Test Mode : Mode 4: Transmit - 802.11n-40BW_15Mbps(2.4G Band) (2452 MHz)
 main chip_162

| Frequency MHz | Correct Factor dB | Reading Level dBuV | Measurement Level dBuV/m | Margin dB | Limit dBuV/m |
|--------------------------|-------------------------|--------------------------|--------------------------------|--------------|-----------------|
| Horizontal | | | | | |
| Peak Detector: | | | | | |
| 4904.000 | 2.914 | 37.980 | 40.895 | -33.105 | 74.000 |
| 7356.000 | 11.995 | 35.640 | 47.634 | -26.366 | 74.000 |
| 9808.000 | 12.475 | 36.590 | 49.065 | -24.935 | 74.000 |
| Average Detector: | | | | | |
| -- | | | | | |
| Vertical | | | | | |
| Peak Detector: | | | | | |
| 4904.000 | 5.530 | 43.850 | 49.381 | -24.619 | 74.000 |
| 7356.000 | 13.005 | 35.860 | 48.864 | -25.136 | 74.000 |
| 9808.000 | 12.901 | 37.040 | 49.941 | -24.059 | 74.000 |
| Average Detector: | | | | | |
| -- | | | | | |

Note:

1. All Readings below 1GHz are Quasi-Peak, above 1GHz are performed with peak and/or average measurements as necessary.
2. Peak measurements: RBW = 1MHz, VBW = 3 MHz, Sweep: Auto.
3. Average measurements: RBW = 1MHz, VBW = 10 Hz, Sweep: Auto.
4. Measurement Level = Reading Level + Correct Factor.
5. Correct Factor = Antenna factor + Cable loss – Amplifier gain.
6. The average measurement was not performed when the peak measured data under the limit of average detection.
7. The emission levels of other frequencies are very lower than the limit and not show in test report.

Product : PS1 Speaker
 Test Item : Harmonic Radiated Emission Data
 Test Site : No.3 OATS
 Test Mode : Mode 1: Transmit (802.11b 1Mbps) (2412MHz) main chip_166

| Frequency MHz | Correct Factor dB | Reading Level dBuV | Measurement Level dBuV/m | Margin dB | Limit dBuV/m |
|--------------------------|-------------------------|--------------------------|--------------------------------|--------------|-----------------|
| Horizontal | | | | | |
| Peak Detector: | | | | | |
| 4824.000 | 3.261 | 41.340 | 44.601 | -29.399 | 74.000 |
| 7236.000 | 10.650 | 39.410 | 50.060 | -23.940 | 74.000 |
| 9648.000 | 13.337 | 36.420 | 49.756 | -24.244 | 74.000 |
| Average Detector: | | | | | |
| -- | | | | | |
| Vertical | | | | | |
| Peak Detector: | | | | | |
| 4824.000 | 6.421 | 43.410 | 49.831 | -24.169 | 74.000 |
| 7236.000 | 11.495 | 39.470 | 50.965 | -23.035 | 74.000 |
| 9648.000 | 13.807 | 35.950 | 49.756 | -24.244 | 74.000 |
| Average Detector: | | | | | |
| -- | | | | | |

Note:

1. All Readings below 1GHz are Quasi-Peak, above 1GHz are performed with peak and/or average measurements as necessary.
2. Peak measurements: RBW = 1MHz, VBW = 3 MHz, Sweep: Auto.
3. Average measurements: RBW = 1MHz, VBW = 10 Hz, Sweep: Auto.
4. Measurement Level = Reading Level + Correct Factor.
5. Correct Factor = Antenna factor + Cable loss – Amplifier gain.
6. The average measurement was not performed when the peak measured data under the limit of average detection.
7. The emission levels of other frequencies are very lower than the limit and not show in test report.

Product : PS1 Speaker
 Test Item : Harmonic Radiated Emission Data
 Test Site : No.3 OATS
 Test Mode : Mode 1: Transmit (802.11b 1Mbps) (2437 MHz) main chip_166

| Frequency MHz | Correct Factor dB | Reading Level dBUV | Measurement Level dBUV/m | Margin dB | Limit dBUV/m |
|--------------------------|-------------------------|--------------------------|--------------------------------|--------------|-----------------|
| Horizontal | | | | | |
| Peak Detector: | | | | | |
| 4874.000 | 3.038 | 42.940 | 45.977 | -28.023 | 74.000 |
| 7311.000 | 11.795 | 40.780 | 52.574 | -21.426 | 74.000 |
| 9748.000 | 12.635 | 37.890 | 50.525 | -23.475 | 74.000 |
| Average Detector: | | | | | |
| -- | | | | | |
| Vertical | | | | | |
| Peak Detector: | | | | | |
| 4874.000 | 5.812 | 45.670 | 51.481 | -22.519 | 74.000 |
| 7311.000 | 12.630 | 40.870 | 53.499 | -20.501 | 74.000 |
| 9748.000 | 13.126 | 37.120 | 50.246 | -23.754 | 74.000 |
| Average Detector: | | | | | |
| -- | | | | | |

Note:

1. All Readings below 1GHz are Quasi-Peak, above 1GHz are performed with peak and/or average measurements as necessary.
2. Peak measurements: RBW = 1MHz, VBW = 3 MHz, Sweep: Auto.
3. Average measurements: RBW = 1MHz, VBW = 10 Hz, Sweep: Auto.
4. Measurement Level = Reading Level + Correct Factor.
5. Correct Factor = Antenna factor + Cable loss – Amplifier gain.
6. The average measurement was not performed when the peak measured data under the limit of average detection.
7. The emission levels of other frequencies are very lower than the limit and not show in test report.

Product : PS1 Speaker
 Test Item : Harmonic Radiated Emission Data
 Test Site : No.3 OATS
 Test Mode : Mode 1: Transmit (802.11b 1Mbps) (2462 MHz) main chip_166

| Frequency MHz | Correct Factor dB | Reading Level dBuV | Measurement Level dBuV/m | Margin dB | Limit dBuV/m |
|--------------------------|-------------------------|--------------------------|--------------------------------|--------------|-----------------|
| Horizontal | | | | | |
| Peak Detector: | | | | | |
| 4924.000 | 2.858 | 42.080 | 44.937 | -29.063 | 74.000 |
| 7386.000 | 12.127 | 37.490 | 49.618 | -24.382 | 74.000 |
| 9848.000 | 12.852 | 37.030 | 49.883 | -24.117 | 74.000 |
| Average Detector: | | | | | |
| -- | | | | | |
| Vertical | | | | | |
| Peak Detector: | | | | | |
| 4924.000 | 5.521 | 44.500 | 50.020 | -23.980 | 74.000 |
| 7386.000 | 13.254 | 37.320 | 50.574 | -23.426 | 74.000 |
| 9848.000 | 13.367 | 37.050 | 50.417 | -23.583 | 74.000 |
| Average Detector: | | | | | |
| -- | | | | | |

Note:

1. All Readings below 1GHz are Quasi-Peak, above 1GHz are performed with peak and/or average measurements as necessary.
2. Peak measurements: RBW = 1MHz, VBW = 3 MHz, Sweep: Auto.
3. Average measurements: RBW = 1MHz, VBW = 10 Hz, Sweep: Auto.
4. Measurement Level = Reading Level + Correct Factor.
5. Correct Factor = Antenna factor + Cable loss – Amplifier gain.
6. The average measurement was not performed when the peak measured data under the limit of average detection.
7. The emission levels of other frequencies are very lower than the limit and not show in test report.

Product : PS1 Speaker
 Test Item : Harmonic Radiated Emission Data
 Test Site : No.3 OATS
 Test Mode : Mode 2: Transmit (802.11g 6Mbps) (2412MHz) main chip_166

| Frequency MHz | Correct Factor dB | Reading Level dBuV | Measurement Level dBuV/m | Margin dB | Limit dBuV/m |
|--------------------------|-------------------------|--------------------------|--------------------------------|--------------|-----------------|
| Horizontal | | | | | |
| Peak Detector: | | | | | |
| 4824.000 | 3.261 | 39.270 | 42.531 | -31.469 | 74.000 |
| 7236.000 | 10.650 | 40.360 | 51.010 | -22.990 | 74.000 |
| 9648.000 | 13.337 | 36.150 | 49.486 | -24.514 | 74.000 |
| Average Detector: | | | | | |
| -- | | | | | |
| Vertical | | | | | |
| Peak Detector: | | | | | |
| 4824.000 | 6.421 | 39.960 | 46.381 | -27.619 | 74.000 |
| 7236.000 | 11.495 | 41.210 | 52.705 | -21.295 | 74.000 |
| 9648.000 | 13.807 | 36.080 | 49.886 | -24.114 | 74.000 |
| Average Detector: | | | | | |
| -- | | | | | |

Note:

1. All Readings below 1GHz are Quasi-Peak, above 1GHz are performed with peak and/or average measurements as necessary.
2. Peak measurements: RBW = 1MHz, VBW = 3 MHz, Sweep: Auto.
3. Average measurements: RBW = 1MHz, VBW = 10 Hz, Sweep: Auto.
4. Measurement Level = Reading Level + Correct Factor.
5. Correct Factor = Antenna factor + Cable loss – Amplifier gain.
6. The average measurement was not performed when the peak measured data under the limit of average detection.
7. The emission levels of other frequencies are very lower than the limit and not show in test report.

Product : PS1 Speaker
 Test Item : Harmonic Radiated Emission Data
 Test Site : No.3 OATS
 Test Mode : Mode 2: Transmit (802.11g 6Mbps) (2437 MHz) main chip_166

| Frequency MHz | Correct Factor dB | Reading Level dBUV | Measurement Level dBUV/m | Margin dB | Limit dBUV/m |
|--------------------------|-------------------------|--------------------------|--------------------------------|--------------|-----------------|
| Horizontal | | | | | |
| Peak Detector: | | | | | |
| 4874.000 | 3.038 | 38.750 | 41.787 | -32.213 | 74.000 |
| 7311.000 | 11.795 | 40.230 | 52.024 | -21.976 | 74.000 |
| 9748.000 | 12.635 | 36.530 | 49.165 | -24.835 | 74.000 |
| Average Detector: | | | | | |
| -- | | | | | |
| Vertical | | | | | |
| Peak Detector: | | | | | |
| 4874.000 | 5.812 | 40.720 | 46.531 | -27.469 | 74.000 |
| 7311.000 | 12.630 | 41.090 | 53.719 | -20.281 | 74.000 |
| 9748.000 | 13.126 | 36.830 | 49.956 | -24.044 | 74.000 |
| Average Detector: | | | | | |
| -- | | | | | |

Note:

1. All Readings below 1GHz are Quasi-Peak, above 1GHz are performed with peak and/or average measurements as necessary.
2. Peak measurements: RBW = 1MHz, VBW = 3 MHz, Sweep: Auto.
3. Average measurements: RBW = 1MHz, VBW = 10 Hz, Sweep: Auto.
4. Measurement Level = Reading Level + Correct Factor.
5. Correct Factor = Antenna factor + Cable loss – Amplifier gain.
6. The average measurement was not performed when the peak measured data under the limit of average detection.
7. The emission levels of other frequencies are very lower than the limit and not show in test report.

Product : PS1 Speaker
 Test Item : Harmonic Radiated Emission Data
 Test Site : No.3 OATS
 Test Mode : Mode 2: Transmit (802.11g 6Mbps) (2462 MHz) main chip_166

| Frequency MHz | Correct Factor dB | Reading Level dBuV | Measurement Level dBuV/m | Margin dB | Limit dBuV/m |
|--------------------------|-------------------------|--------------------------|--------------------------------|--------------|-----------------|
| Horizontal | | | | | |
| Peak Detector: | | | | | |
| 4924.000 | 2.858 | 40.560 | 43.417 | -30.583 | 74.000 |
| 7386.000 | 12.127 | 39.020 | 51.148 | -22.852 | 74.000 |
| 9848.000 | 12.852 | 36.520 | 49.373 | -24.627 | 74.000 |
| Average Detector: | | | | | |
| -- | | | | | |
| Vertical | | | | | |
| Peak Detector: | | | | | |
| 4924.000 | 5.521 | 41.240 | 46.760 | -27.240 | 74.000 |
| 7386.000 | 13.254 | 39.550 | 52.804 | -21.196 | 74.000 |
| 9848.000 | 13.367 | 36.400 | 49.767 | -24.233 | 74.000 |
| Average Detector: | | | | | |
| -- | | | | | |

Note:

1. All Readings below 1GHz are Quasi-Peak, above 1GHz are performed with peak and/or average measurements as necessary.
2. Peak measurements: RBW = 1MHz, VBW = 3 MHz, Sweep: Auto.
3. Average measurements: RBW = 1MHz, VBW = 10 Hz, Sweep: Auto.
4. Measurement Level = Reading Level + Correct Factor.
5. Correct Factor = Antenna factor + Cable loss – Amplifier gain.
6. The average measurement was not performed when the peak measured data under the limit of average detection.
7. The emission levels of other frequencies are very lower than the limit and not show in test report.

Product : PS1 Speaker
 Test Item : Harmonic Radiated Emission Data
 Test Site : No.3 OATS
 Test Mode : Mode 3: Transmit - 802.11n-20BW_7.2Mbps(2.4G Band) (2412MHz)
 main chip_166

| Frequency MHz | Correct Factor dB | Reading Level dBuV | Measurement Level dBuV/m | Margin dB | Limit dBuV/m |
|--------------------------|-------------------------|--------------------------|--------------------------------|--------------|-----------------|
| Horizontal | | | | | |
| Peak Detector: | | | | | |
| 4824.000 | 3.261 | 39.760 | 43.021 | -30.979 | 74.000 |
| 7236.000 | 10.650 | 43.280 | 53.930 | -20.070 | 74.000 |
| 9648.000 | 13.337 | 35.340 | 48.676 | -25.324 | 74.000 |
| Average Detector: | | | | | |
| -- | | | | | |
| Vertical | | | | | |
| Peak Detector: | | | | | |
| 4824.000 | 6.254 | 40.290 | 46.544 | -27.456 | 74.000 |
| 7236.000 | 11.495 | 41.950 | 53.445 | -20.555 | 74.000 |
| 9648.000 | 13.536 | 36.350 | 49.886 | -24.114 | 74.000 |
| Average Detector: | | | | | |
| -- | | | | | |

Note:

1. All Readings below 1GHz are Quasi-Peak, above 1GHz are performed with peak and/or average measurements as necessary.
2. Peak measurements: RBW = 1MHz, VBW = 3 MHz, Sweep: Auto.
3. Average measurements: RBW = 1MHz, VBW = 10 Hz, Sweep: Auto.
4. Measurement Level = Reading Level + Correct Factor.
5. Correct Factor = Antenna factor + Cable loss – Amplifier gain.
6. The average measurement was not performed when the peak measured data under the limit of average detection.
7. The emission levels of other frequencies are very lower than the limit and not show in test report.

Product : PS1 Speaker
 Test Item : Harmonic Radiated Emission Data
 Test Site : No.3 OATS
 Test Mode : Mode 3: Transmit - 802.11n-20BW_7.2Mbps(2.4G Band) (2437 MHz)
 main chip_166

| Frequency MHz | Correct Factor dB | Reading Level dBuV | Measurement Level dBuV/m | Margin dB | Limit dBuV/m |
|--------------------------|-------------------------|--------------------------|--------------------------------|--------------|-----------------|
| Horizontal | | | | | |
| Peak Detector: | | | | | |
| 4874.000 | 3.038 | 38.740 | 41.777 | -32.223 | 74.000 |
| 7311.000 | 11.795 | 40.020 | 51.814 | -22.186 | 74.000 |
| 9748.000 | 12.635 | 36.280 | 48.915 | -25.085 | 74.000 |
| Average Detector: | | | | | |
| -- | | | | | |
| Vertical | | | | | |
| Peak Detector: | | | | | |
| 4874.000 | 5.812 | 40.980 | 46.791 | -27.209 | 74.000 |
| 7311.000 | 12.630 | 40.660 | 53.289 | -20.711 | 74.000 |
| 9748.000 | 13.126 | 36.790 | 49.916 | -24.084 | 74.000 |
| Average Detector: | | | | | |
| -- | | | | | |

Note:

1. All Readings below 1GHz are Quasi-Peak, above 1GHz are performed with peak and/or average measurements as necessary.
2. Peak measurements: RBW = 1MHz, VBW = 3 MHz, Sweep: Auto.
3. Average measurements: RBW = 1MHz, VBW = 10 Hz, Sweep: Auto.
4. Measurement Level = Reading Level + Correct Factor.
5. Correct Factor = Antenna factor + Cable loss – Amplifier gain.
6. The average measurement was not performed when the peak measured data under the limit of average detection.
7. The emission levels of other frequencies are very lower than the limit and not show in test report.

Product : PS1 Speaker
 Test Item : Harmonic Radiated Emission Data
 Test Site : No.3 OATS
 Test Mode : Mode 3: Transmit - 802.11n-20BW_7.2Mbps(2.4G Band) (2462 MHz)
 main chip_166

| Frequency MHz | Correct Factor dB | Reading Level dBuV | Measurement Level dBuV/m | Margin dB | Limit dBuV/m |
|--------------------------|-------------------------|--------------------------|--------------------------------|--------------|-----------------|
| Horizontal | | | | | |
| Peak Detector: | | | | | |
| 4924.000 | 2.858 | 38.830 | 41.687 | -32.313 | 74.000 |
| 7386.000 | 12.127 | 39.440 | 51.568 | -22.432 | 74.000 |
| 9848.000 | 12.852 | 36.280 | 49.133 | -24.867 | 74.000 |
| Average Detector: | | | | | |
| -- | | | | | |
| Vertical | | | | | |
| Peak Detector: | | | | | |
| 4924.000 | 5.521 | 41.640 | 47.160 | -26.840 | 74.000 |
| 7386.000 | 13.254 | 40.410 | 53.664 | -20.336 | 74.000 |
| 9848.000 | 13.367 | 35.950 | 49.317 | -24.683 | 74.000 |
| Average Detector: | | | | | |
| -- | | | | | |

Note:

1. All Readings below 1GHz are Quasi-Peak, above 1GHz are performed with peak and/or average measurements as necessary.
2. Peak measurements: RBW = 1MHz, VBW = 3 MHz, Sweep: Auto.
3. Average measurements: RBW = 1MHz, VBW = 10 Hz, Sweep: Auto.
4. Measurement Level = Reading Level + Correct Factor.
5. Correct Factor = Antenna factor + Cable loss – Amplifier gain.
6. The average measurement was not performed when the peak measured data under the limit of average detection.
7. The emission levels of other frequencies are very lower than the limit and not show in test report.

Product : PS1 Speaker
 Test Item : Harmonic Radiated Emission Data
 Test Site : No.3 OATS
 Test Mode : Mode 4: Transmit - 802.11n-40BW_15Mbps(2.4G Band) (2422MHz)
 main chip_166

| Frequency MHz | Correct Factor dB | Reading Level dBuV | Measurement Level dBuV/m | Margin dB | Limit dBuV/m |
|--------------------------|-------------------------|--------------------------|--------------------------------|--------------|-----------------|
| Horizontal | | | | | |
| Peak Detector: | | | | | |
| 4844.000 | 3.171 | 37.080 | 40.251 | -33.749 | 74.000 |
| 7266.000 | 11.162 | 36.610 | 47.772 | -26.228 | 74.000 |
| 9688.000 | 12.964 | 36.100 | 49.065 | -24.935 | 74.000 |
| Average Detector: | | | | | |
| -- | | | | | |
| Vertical | | | | | |
| Peak Detector: | | | | | |
| 4844.000 | 6.178 | 37.740 | 43.918 | -30.082 | 74.000 |
| 7266.000 | 11.982 | 37.410 | 49.392 | -24.608 | 74.000 |
| 9688.000 | 13.507 | 36.140 | 49.648 | -24.352 | 74.000 |
| Average Detector: | | | | | |
| -- | | | | | |

Note:

1. All Readings below 1GHz are Quasi-Peak, above 1GHz are performed with peak and/or average measurements as necessary.
2. Peak measurements: RBW = 1MHz, VBW = 3 MHz, Sweep: Auto.
3. Average measurements: RBW = 1MHz, VBW = 10 Hz, Sweep: Auto.
4. Measurement Level = Reading Level + Correct Factor.
5. Correct Factor = Antenna factor + Cable loss – Amplifier gain.
6. The average measurement was not performed when the peak measured data under the limit of average detection.
7. The emission levels of other frequencies are very lower than the limit and not show in test report.

Product : PS1 Speaker
 Test Item : Harmonic Radiated Emission Data
 Test Site : No.3 OATS
 Test Mode : Mode 4: Transmit - 802.11n-40BW_15Mbps(2.4G Band) (2437 MHz)
 main chip_166

| Frequency MHz | Correct Factor dB | Reading Level dBuV | Measurement Level dBuV/m | Margin dB | Limit dBuV/m |
|--------------------------|-------------------------|--------------------------|--------------------------------|--------------|-----------------|
| Horizontal | | | | | |
| Peak Detector: | | | | | |
| 4874.000 | 3.038 | 37.340 | 40.377 | -33.623 | 74.000 |
| 7311.000 | 11.795 | 36.370 | 48.164 | -25.836 | 74.000 |
| 9748.000 | 12.635 | 36.020 | 48.655 | -25.345 | 74.000 |
| Average Detector: | | | | | |
| -- | | | | | |
| Vertical | | | | | |
| Peak Detector: | | | | | |
| 4874.000 | 5.812 | 36.450 | 42.261 | -31.739 | 74.000 |
| 7311.000 | 12.630 | 38.470 | 51.099 | -22.901 | 74.000 |
| 9748.000 | 13.126 | 36.190 | 49.316 | -24.684 | 74.000 |
| Average Detector: | | | | | |
| -- | | | | | |

Note:

1. All Readings below 1GHz are Quasi-Peak, above 1GHz are performed with peak and/or average measurements as necessary.
2. Peak measurements: RBW = 1MHz, VBW = 3 MHz, Sweep: Auto.
3. Average measurements: RBW = 1MHz, VBW = 10 Hz, Sweep: Auto.
4. Measurement Level = Reading Level + Correct Factor.
5. Correct Factor = Antenna factor + Cable loss – Amplifier gain.
6. The average measurement was not performed when the peak measured data under the limit of average detection.
7. The emission levels of other frequencies are very lower than the limit and not show in test report.

Product : PS1 Speaker
 Test Item : Harmonic Radiated Emission Data
 Test Site : No.3 OATS
 Test Mode : Mode 4: Transmit - 802.11n-40BW_15Mbps(2.4G Band) (2452 MHz)
 main chip_166

| Frequency MHz | Correct Factor dB | Reading Level dBuV | Measurement Level dBuV/m | Margin dB | Limit dBuV/m |
|--------------------------|-------------------------|--------------------------|--------------------------------|--------------|-----------------|
| Horizontal | | | | | |
| Peak Detector: | | | | | |
| 4904.000 | 2.914 | 37.190 | 40.105 | -33.895 | 74.000 |
| 7356.000 | 11.995 | 35.690 | 47.684 | -26.316 | 74.000 |
| 9808.000 | 12.475 | 36.290 | 48.765 | -25.235 | 74.000 |
| Average Detector: | | | | | |
| -- | | | | | |
| Vertical | | | | | |
| Peak Detector: | | | | | |
| 4904.000 | 5.530 | 39.020 | 44.551 | -29.449 | 74.000 |
| 7356.000 | 13.005 | 36.210 | 49.214 | -24.786 | 74.000 |
| 9808.000 | 12.901 | 36.420 | 49.321 | -24.679 | 74.000 |
| Average Detector: | | | | | |
| -- | | | | | |

Note:

1. All Readings below 1GHz are Quasi-Peak, above 1GHz are performed with peak and/or average measurements as necessary.
2. Peak measurements: RBW = 1MHz, VBW = 3 MHz, Sweep: Auto.
3. Average measurements: RBW = 1MHz, VBW = 10 Hz, Sweep: Auto.
4. Measurement Level = Reading Level + Correct Factor.
5. Correct Factor = Antenna factor + Cable loss – Amplifier gain.
6. The average measurement was not performed when the peak measured data under the limit of average detection.
7. The emission levels of other frequencies are very lower than the limit and not show in test report.

Product : PS1 Speaker
 Test Item : General Radiated Emission Data
 Test Site : No.3 OATS
 Test Mode : Mode 1: Transmit (802.11b 1Mbps) (2437 MHz) main chip_162 (winbond)
 (Adapter- M/N: WA-24E12FU)

| Frequency MHz | Correct Factor dB | Reading Level dBuV | Measurement Level dBuV/m | Margin dB | Limit dBuV/m |
|-------------------|-------------------------|--------------------------|--------------------------------|--------------|-----------------|
| Horizontal | | | | | |
| 37.760 | -2.539 | 32.491 | 29.953 | -10.047 | 40.000 |
| 253.100 | -5.669 | 39.484 | 33.815 | -12.185 | 46.000 |
| 309.360 | -4.463 | 37.982 | 33.519 | -12.481 | 46.000 |
| 398.600 | 0.879 | 34.151 | 35.030 | -10.970 | 46.000 |
| 540.220 | 3.499 | 29.616 | 33.115 | -12.885 | 46.000 |
| 961.200 | 6.810 | 36.499 | 43.309 | -10.691 | 54.000 |
| Vertical | | | | | |
| 293.840 | -4.990 | 37.576 | 32.586 | -13.414 | 46.000 |
| 608.120 | 2.175 | 28.604 | 30.779 | -15.221 | 46.000 |
| 666.320 | -0.951 | 35.399 | 34.448 | -11.552 | 46.000 |
| 798.240 | 2.629 | 29.642 | 32.270 | -13.730 | 46.000 |
| 961.200 | 3.310 | 32.306 | 35.616 | -18.384 | 54.000 |
| 996.120 | -1.323 | 38.394 | 37.071 | -16.929 | 54.000 |

Note:

1. All Readings below 1GHz are Quasi-Peak, above 1GHz are performed with peak and/or average measurements as necessary.
2. Peak measurements: RBW = 1MHz, VBW = 3 MHz, Sweep: Auto.
3. Average measurements: RBW = 1MHz, VBW = 10 Hz, Sweep: Auto.
4. Measurement Level = Reading Level + Correct Factor.
5. Correct Factor = Antenna factor + Cable loss – Amplifier gain.
6. The average measurement was not performed when the peak measured data under the limit of average detection.
7. The emission levels of other frequencies are very lower than the limit and not show in test report.

Product : PS1 Speaker
 Test Item : General Radiated Emission Data
 Test Site : No.3 OATS
 Test Mode : Mode 2: Transmit (802.11g 6Mbps) (2437 MHz) main chip_162 (winbond)
 (Adapter- M/N: WA-24E12FU)

| Frequency MHz | Correct Factor dB | Reading Level dBuV | Measurement Level dBuV/m | Margin dB | Limit dBuV/m |
|-------------------|-------------------------|--------------------------|--------------------------------|--------------|-----------------|
| Horizontal | | | | | |
| 253.100 | -5.669 | 39.864 | 34.195 | -11.805 | 46.000 |
| 398.600 | 0.879 | 34.892 | 35.771 | -10.229 | 46.000 |
| 540.220 | 3.499 | 28.708 | 32.207 | -13.793 | 46.000 |
| 798.240 | 6.409 | 34.319 | 40.727 | -5.273 | 46.000 |
| 961.200 | 6.810 | 34.466 | 41.276 | -12.724 | 54.000 |
| 996.120 | 8.107 | 35.456 | 43.563 | -10.437 | 54.000 |
| Vertical | | | | | |
| 43.580 | -10.919 | 42.801 | 31.882 | -8.118 | 40.000 |
| 222.060 | -6.484 | 44.989 | 38.504 | -7.496 | 46.000 |
| 361.740 | -0.646 | 33.320 | 32.673 | -13.327 | 46.000 |
| 798.240 | 2.629 | 30.213 | 32.841 | -13.159 | 46.000 |
| 961.200 | 3.310 | 33.170 | 36.480 | -17.520 | 54.000 |
| 996.120 | -1.323 | 40.304 | 38.981 | -15.019 | 54.000 |

Note:

1. All Readings below 1GHz are Quasi-Peak, above 1GHz are performed with peak and/or average measurements as necessary.
2. Peak measurements: RBW = 1MHz, VBW = 3 MHz, Sweep: Auto.
3. Average measurements: RBW = 1MHz, VBW = 10 Hz, Sweep: Auto.
4. Measurement Level = Reading Level + Correct Factor.
5. Correct Factor = Antenna factor + Cable loss – Amplifier gain.
6. The average measurement was not performed when the peak measured data under the limit of average detection.
7. The emission levels of other frequencies are very lower than the limit and not show in test report.

Product : PS1 Speaker
 Test Item : General Radiated Emission Data
 Test Site : No.3 OATS
 Test Mode : Mode 3: Transmit - 802.11n-20BW_7.2Mbps(2.4G Band) (2437 MHz)
 main chip_162 (winbond) (Adapter- M/N: WA-24E12FU)

| Frequency MHz | Correct Factor dB | Reading Level dBuV | Measurement Level dBuV/m | Margin dB | Limit dBuV/m |
|-------------------|-------------------------|--------------------------|--------------------------------|--------------|-----------------|
| Horizontal | | | | | |
| 39.700 | -3.625 | 37.979 | 34.354 | -5.646 | 40.000 |
| 311.300 | -4.651 | 39.605 | 34.954 | -11.046 | 46.000 |
| 398.600 | 0.879 | 35.050 | 35.929 | -10.071 | 46.000 |
| 798.240 | 6.409 | 35.120 | 41.528 | -4.472 | 46.000 |
| 961.200 | 6.810 | 35.937 | 42.747 | -11.253 | 54.000 |
| 1000.000 | 9.564 | 36.184 | 45.748 | -8.252 | 54.000 |
| Vertical | | | | | |
| 41.640 | -11.715 | 42.478 | 30.764 | -9.236 | 40.000 |
| 375.320 | 0.388 | 30.708 | 31.096 | -14.904 | 46.000 |
| 664.380 | -0.978 | 32.827 | 31.849 | -14.151 | 46.000 |
| 798.240 | 2.629 | 30.696 | 33.324 | -12.676 | 46.000 |
| 961.200 | 3.310 | 32.927 | 36.237 | -17.763 | 54.000 |
| 1000.000 | -1.166 | 37.290 | 36.124 | -17.876 | 54.000 |

Note:

1. All Readings below 1GHz are Quasi-Peak, above 1GHz are performed with peak and/or average measurements as necessary.
2. Peak measurements: RBW = 1MHz, VBW = 3 MHz, Sweep: Auto.
3. Average measurements: RBW = 1MHz, VBW = 10 Hz, Sweep: Auto.
4. Measurement Level = Reading Level + Correct Factor.
5. Correct Factor = Antenna factor + Cable loss – Amplifier gain.
6. The average measurement was not performed when the peak measured data under the limit of average detection.
7. The emission levels of other frequencies are very lower than the limit and not show in test report.

Product : PS1 Speaker
 Test Item : General Radiated Emission Data
 Test Site : No.3 OATS
 Test Mode : Mode 4: Transmit - 802.11n-40BW_15Mbps(2.4G Band) (2437 MHz)
 main chip_162 (winbond) (Adapter- M/N: WA-24E12FU)

| Frequency MHz | Correct Factor dB | Reading Level dBuV | Measurement Level dBuV/m | Margin dB | Limit dBuV/m |
|-------------------|-------------------------|--------------------------|--------------------------------|--------------|-----------------|
| Horizontal | | | | | |
| 64.920 | -12.587 | 44.401 | 31.814 | -8.186 | 40.000 |
| 311.300 | -4.651 | 39.584 | 34.933 | -11.067 | 46.000 |
| 664.380 | 1.882 | 32.827 | 34.709 | -11.291 | 46.000 |
| 798.240 | 6.409 | 33.102 | 39.510 | -6.490 | 46.000 |
| 916.580 | 6.470 | 29.435 | 35.905 | -10.095 | 46.000 |
| 961.200 | 6.810 | 34.189 | 40.999 | -13.001 | 54.000 |
| Vertical | | | | | |
| 43.580 | -10.919 | 43.123 | 32.204 | -7.796 | 40.000 |
| 260.860 | -4.870 | 41.240 | 36.370 | -9.630 | 46.000 |
| 540.220 | 2.169 | 27.846 | 30.015 | -15.985 | 46.000 |
| 664.380 | -0.978 | 32.949 | 31.971 | -14.029 | 46.000 |
| 798.240 | 2.629 | 30.392 | 33.020 | -12.980 | 46.000 |
| 961.200 | 3.310 | 32.242 | 35.552 | -18.448 | 54.000 |

Note:

1. All Readings below 1GHz are Quasi-Peak, above 1GHz are performed with peak and/or average measurements as necessary.
2. Peak measurements: RBW = 1MHz, VBW = 3 MHz, Sweep: Auto.
3. Average measurements: RBW = 1MHz, VBW = 10 Hz, Sweep: Auto.
4. Measurement Level = Reading Level + Correct Factor.
5. Correct Factor = Antenna factor + Cable loss – Amplifier gain.
6. The average measurement was not performed when the peak measured data under the limit of average detection.
7. The emission levels of other frequencies are very lower than the limit and not show in test report.

Product : PS1 Speaker
 Test Item : General Radiated Emission Data
 Test Site : No.3 OATS
 Test Mode : Mode 1: Transmit (802.11b 1Mbps) (2437 MHz) main chip_166 (Hynix)
 (Adapter- M/N: WA-24E12FU)

| Frequency MHz | Correct Factor dB | Reading Level dBuV | Measurement Level dBuV/m | Margin dB | Limit dBuV/m |
|-------------------|-------------------------|--------------------------|--------------------------------|--------------|-----------------|
| Horizontal | | | | | |
| 107.600 | -7.058 | 35.325 | 28.267 | -15.233 | 43.500 |
| 249.220 | -6.014 | 40.969 | 34.955 | -11.045 | 46.000 |
| 375.320 | -1.209 | 38.663 | 37.454 | -8.546 | 46.000 |
| 600.360 | 3.977 | 33.202 | 37.179 | -8.821 | 46.000 |
| 798.240 | 5.148 | 33.319 | 38.467 | -7.533 | 46.000 |
| 961.200 | 6.450 | 40.151 | 46.601 | -7.399 | 54.000 |
| Vertical | | | | | |
| 105.660 | -0.253 | 36.088 | 35.835 | -7.665 | 43.500 |
| 249.220 | -7.634 | 42.972 | 35.338 | -10.662 | 46.000 |
| 398.600 | -4.678 | 42.316 | 37.638 | -8.362 | 46.000 |
| 497.540 | -1.393 | 32.035 | 30.642 | -15.358 | 46.000 |
| 825.400 | 3.430 | 30.383 | 33.813 | -12.187 | 46.000 |
| 961.200 | 7.260 | 39.482 | 46.742 | -7.258 | 54.000 |

Note:

1. All Readings below 1GHz are Quasi-Peak, above 1GHz are performed with peak and/or average measurements as necessary.
2. Peak measurements: RBW = 1MHz, VBW = 3 MHz, Sweep: Auto.
3. Average measurements: RBW = 1MHz, VBW = 10 Hz, Sweep: Auto.
4. Measurement Level = Reading Level + Correct Factor.
5. Correct Factor = Antenna factor + Cable loss – Amplifier gain.
6. The average measurement was not performed when the peak measured data under the limit of average detection.
7. The emission levels of other frequencies are very lower than the limit and not show in test report.

Product : PS1 Speaker
 Test Item : General Radiated Emission Data
 Test Site : No.3 OATS
 Test Mode : Mode 2: Transmit (802.11g 6Mbps) (2437 MHz) main chip_166 (Hynix)
 (Adapter- M/N: WA-24E12FU)

| Frequency MHz | Correct Factor dB | Reading Level dBuV | Measurement Level dBuV/m | Margin dB | Limit dBuV/m |
|-------------------|-------------------------|--------------------------|--------------------------------|--------------|-----------------|
| Horizontal | | | | | |
| 103.720 | -6.751 | 35.090 | 28.338 | -15.162 | 43.500 |
| 249.220 | -6.014 | 41.832 | 35.818 | -10.182 | 46.000 |
| 375.320 | -1.209 | 39.674 | 38.465 | -7.535 | 46.000 |
| 600.360 | 3.977 | 33.142 | 37.119 | -8.881 | 46.000 |
| 798.240 | 5.148 | 33.148 | 38.296 | -7.704 | 46.000 |
| 961.200 | 6.450 | 40.290 | 46.740 | -7.260 | 54.000 |
| Vertical | | | | | |
| 107.600 | -0.318 | 37.755 | 37.437 | -6.063 | 43.500 |
| 249.220 | -7.634 | 43.006 | 35.372 | -10.628 | 46.000 |
| 400.540 | -5.156 | 40.818 | 35.663 | -10.337 | 46.000 |
| 532.460 | -0.563 | 32.369 | 31.806 | -14.194 | 46.000 |
| 699.300 | 0.695 | 37.763 | 38.458 | -7.542 | 46.000 |
| 961.200 | 7.260 | 39.238 | 46.498 | -7.502 | 54.000 |

Note:

1. All Readings below 1GHz are Quasi-Peak, above 1GHz are performed with peak and/or average measurements as necessary.
2. Peak measurements: RBW = 1MHz, VBW = 3 MHz, Sweep: Auto.
3. Average measurements: RBW = 1MHz, VBW = 10 Hz, Sweep: Auto.
4. Measurement Level = Reading Level + Correct Factor.
5. Correct Factor = Antenna factor + Cable loss – Amplifier gain.
6. The average measurement was not performed when the peak measured data under the limit of average detection.
7. The emission levels of other frequencies are very lower than the limit and not show in test report.

Product : PS1 Speaker
 Test Item : General Radiated Emission Data
 Test Site : No.3 OATS
 Test Mode : Mode 3: Transmit - 802.11n-20BW_7.2Mbps(2.4G Band) (2437 MHz)
 main chip_166 (Hynix) (Adapter- M/N: WA-24E12FU)

| Frequency MHz | Correct Factor dB | Reading Level dBuV | Measurement Level dBuV/m | Margin dB | Limit dBuV/m |
|-------------------|-------------------------|--------------------------|--------------------------------|--------------|-----------------|
| Horizontal | | | | | |
| 107.600 | -7.058 | 35.872 | 28.814 | -14.686 | 43.500 |
| 249.220 | -6.014 | 41.674 | 35.660 | -10.340 | 46.000 |
| 400.540 | -2.276 | 37.898 | 35.622 | -10.378 | 46.000 |
| 600.360 | 3.977 | 32.829 | 36.806 | -9.194 | 46.000 |
| 798.240 | 5.148 | 33.796 | 38.944 | -7.056 | 46.000 |
| 961.200 | 6.450 | 39.163 | 45.613 | -8.387 | 54.000 |
| Vertical | | | | | |
| 132.820 | -4.440 | 39.674 | 35.234 | -8.266 | 43.500 |
| 249.220 | -7.634 | 42.673 | 35.039 | -10.961 | 46.000 |
| 398.600 | -4.678 | 43.160 | 38.482 | -7.518 | 46.000 |
| 532.460 | -0.563 | 33.000 | 32.437 | -13.563 | 46.000 |
| 769.140 | 2.923 | 32.876 | 35.799 | -10.201 | 46.000 |
| 961.200 | 7.260 | 39.725 | 46.985 | -7.015 | 54.000 |

Note:

1. All Readings below 1GHz are Quasi-Peak, above 1GHz are performed with peak and/or average measurements as necessary.
2. Peak measurements: RBW = 1MHz, VBW = 3 MHz, Sweep: Auto.
3. Average measurements: RBW = 1MHz, VBW = 10 Hz, Sweep: Auto.
4. Measurement Level = Reading Level + Correct Factor.
5. Correct Factor = Antenna factor + Cable loss – Amplifier gain.
6. The average measurement was not performed when the peak measured data under the limit of average detection.
7. The emission levels of other frequencies are very lower than the limit and not show in test report.

Product : PS1 Speaker
 Test Item : General Radiated Emission Data
 Test Site : No.3 OATS
 Test Mode : Mode 4: Transmit - 802.11n-40BW_15Mbps(2.4G Band) (2437 MHz)
 main chip_166 (Hynix) (Adapter- M/N: WA-24E12FU)

| Frequency MHz | Correct Factor dB | Reading Level dBuV | Measurement Level dBuV/m | Margin dB | Limit dBuV/m |
|-------------------|-------------------------|--------------------------|--------------------------------|--------------|-----------------|
| Horizontal | | | | | |
| 103.720 | -6.751 | 34.124 | 27.372 | -16.128 | 43.500 |
| 249.220 | -6.014 | 41.081 | 35.067 | -10.933 | 46.000 |
| 375.320 | -1.209 | 39.322 | 38.113 | -7.887 | 46.000 |
| 540.220 | 2.551 | 35.107 | 37.658 | -8.342 | 46.000 |
| 800.180 | 5.141 | 32.867 | 38.008 | -7.992 | 46.000 |
| 961.200 | 6.450 | 40.054 | 46.504 | -7.496 | 54.000 |
| Vertical | | | | | |
| 55.220 | -4.699 | 40.772 | 36.073 | -3.927 | 40.000 |
| 132.820 | -4.440 | 39.572 | 35.132 | -8.368 | 43.500 |
| 256.980 | -7.573 | 41.056 | 33.483 | -12.517 | 46.000 |
| 398.600 | -4.678 | 40.901 | 36.223 | -9.777 | 46.000 |
| 695.420 | 1.878 | 34.224 | 36.102 | -9.898 | 46.000 |
| 961.200 | 7.260 | 39.085 | 46.345 | -7.655 | 54.000 |

Note:

1. All Readings below 1GHz are Quasi-Peak, above 1GHz are performed with peak and/or average measurements as necessary.
2. Peak measurements: RBW = 1MHz, VBW = 3 MHz, Sweep: Auto.
3. Average measurements: RBW = 1MHz, VBW = 10 Hz, Sweep: Auto.
4. Measurement Level = Reading Level + Correct Factor.
5. Correct Factor = Antenna factor + Cable loss – Amplifier gain.
6. The average measurement was not performed when the peak measured data under the limit of average detection.
7. The emission levels of other frequencies are very lower than the limit and not show in test report.

Product : PS1 Speaker
 Test Item : General Radiated Emission Data
 Test Site : No.3 OATS
 Test Mode : Mode 1: Transmit (802.11b 1Mbps) (2437 MHz) main chip_162 (Hynix)
 (Adapter- M/N: WA-24E12FU)

| Frequency MHz | Correct Factor dB | Reading Level dBuV | Measurement Level dBuV/m | Margin dB | Limit dBuV/m |
|-------------------|-------------------------|--------------------------|--------------------------------|--------------|-----------------|
| Horizontal | | | | | |
| 97.900 | -7.650 | 34.414 | 26.763 | -16.737 | 43.500 |
| 388.900 | -1.684 | 42.668 | 40.984 | -5.016 | 46.000 |
| 480.080 | -0.329 | 31.842 | 31.513 | -14.487 | 46.000 |
| 540.220 | 2.551 | 31.814 | 34.365 | -11.635 | 46.000 |
| 598.420 | 3.991 | 31.973 | 35.964 | -10.036 | 46.000 |
| 798.240 | 5.148 | 34.304 | 39.452 | -6.548 | 46.000 |
| Vertical | | | | | |
| 119.240 | -3.541 | 42.178 | 38.637 | -4.863 | 43.500 |
| 386.960 | -3.064 | 40.877 | 37.813 | -8.187 | 46.000 |
| 540.220 | 0.121 | 29.973 | 30.094 | -15.906 | 46.000 |
| 749.740 | 2.510 | 31.346 | 33.856 | -12.144 | 46.000 |
| 798.240 | 2.808 | 29.634 | 32.442 | -13.558 | 46.000 |
| 852.560 | 0.452 | 31.062 | 31.514 | -14.486 | 46.000 |

Note:

1. All Readings below 1GHz are Quasi-Peak, above 1GHz are performed with peak and/or average measurements as necessary.
2. Peak measurements: RBW = 1MHz, VBW = 3 MHz, Sweep: Auto.
3. Average measurements: RBW = 1MHz, VBW = 10 Hz, Sweep: Auto.
4. Measurement Level = Reading Level + Correct Factor.
5. Correct Factor = Antenna factor + Cable loss – Amplifier gain.
6. The average measurement was not performed when the peak measured data under the limit of average detection.
7. The emission levels of other frequencies are very lower than the limit and not show in test report.

Product : PS1 Speaker
 Test Item : General Radiated Emission Data
 Test Site : No.3 OATS
 Test Mode : Mode 2: Transmit (802.11g 6Mbps) (2437 MHz) main chip_162 (Hynix)
 (Adapter- M/N: WA-24E12FU)

| Frequency MHz | Correct Factor dB | Reading Level dBuV | Measurement Level dBuV/m | Margin dB | Limit dBuV/m |
|-------------------|-------------------------|--------------------------|--------------------------------|--------------|-----------------|
| Horizontal | | | | | |
| 284.140 | -4.894 | 46.438 | 41.544 | -4.456 | 46.000 |
| 499.480 | 0.048 | 35.654 | 35.702 | -10.298 | 46.000 |
| 540.220 | 2.551 | 31.843 | 34.394 | -11.606 | 46.000 |
| 598.420 | 3.991 | 31.817 | 35.808 | -10.192 | 46.000 |
| 798.240 | 5.148 | 33.588 | 38.736 | -7.264 | 46.000 |
| 856.440 | 6.382 | 26.666 | 33.048 | -12.952 | 46.000 |
| Vertical | | | | | |
| 402.480 | -5.823 | 41.357 | 35.534 | -10.466 | 46.000 |
| 497.540 | -1.393 | 33.429 | 32.036 | -13.964 | 46.000 |
| 608.120 | -1.576 | 32.837 | 31.261 | -14.739 | 46.000 |
| 749.740 | 2.510 | 30.713 | 33.223 | -12.777 | 46.000 |
| 852.560 | 0.452 | 30.506 | 30.958 | -15.042 | 46.000 |
| 930.160 | 6.477 | 26.793 | 33.270 | -12.730 | 46.000 |

Note:

1. All Readings below 1GHz are Quasi-Peak, above 1GHz are performed with peak and/or average measurements as necessary.
2. Peak measurements: RBW = 1MHz, VBW = 3 MHz, Sweep: Auto.
3. Average measurements: RBW = 1MHz, VBW = 10 Hz, Sweep: Auto.
4. Measurement Level = Reading Level + Correct Factor.
5. Correct Factor = Antenna factor + Cable loss – Amplifier gain.
6. The average measurement was not performed when the peak measured data under the limit of average detection.
7. The emission levels of other frequencies are very lower than the limit and not show in test report.

Product : PS1 Speaker
 Test Item : General Radiated Emission Data
 Test Site : No.3 OATS
 Test Mode : Mode 3: Transmit - 802.11n-20BW_7.2Mbps(2.4G Band) (2437 MHz)
 main chip_162 (Hynix) (Adapter- M/N: WA-24E12FU)

| Frequency MHz | Correct Factor dB | Reading Level dBuV | Measurement Level dBuV/m | Margin dB | Limit dBuV/m |
|-------------------|-------------------------|--------------------------|--------------------------------|--------------|-----------------|
| Horizontal | | | | | |
| 92.080 | -8.819 | 35.978 | 27.159 | -16.341 | 43.500 |
| 392.780 | -2.096 | 40.734 | 38.638 | -7.362 | 46.000 |
| 540.220 | 2.551 | 31.681 | 34.232 | -11.768 | 46.000 |
| 598.420 | 3.991 | 30.414 | 34.405 | -11.595 | 46.000 |
| 798.240 | 5.148 | 33.834 | 38.982 | -7.018 | 46.000 |
| 895.240 | 4.988 | 29.278 | 34.265 | -11.735 | 46.000 |
| Vertical | | | | | |
| 92.080 | -3.339 | 36.422 | 33.083 | -10.417 | 43.500 |
| 385.020 | -2.820 | 39.564 | 36.744 | -9.256 | 46.000 |
| 540.220 | 0.121 | 31.006 | 31.127 | -14.873 | 46.000 |
| 598.420 | -2.979 | 31.509 | 28.530 | -17.470 | 46.000 |
| 798.240 | 2.808 | 33.169 | 35.977 | -10.023 | 46.000 |
| 932.100 | 6.152 | 24.344 | 30.496 | -15.504 | 46.000 |

Note:

1. All Readings below 1GHz are Quasi-Peak, above 1GHz are performed with peak and/or average measurements as necessary.
2. Peak measurements: RBW = 1MHz, VBW = 3 MHz, Sweep: Auto.
3. Average measurements: RBW = 1MHz, VBW = 10 Hz, Sweep: Auto.
4. Measurement Level = Reading Level + Correct Factor.
5. Correct Factor = Antenna factor + Cable loss – Amplifier gain.
6. The average measurement was not performed when the peak measured data under the limit of average detection.
7. The emission levels of other frequencies are very lower than the limit and not show in test report.

Product : PS1 Speaker
 Test Item : General Radiated Emission Data
 Test Site : No.3 OATS
 Test Mode : Mode 4: Transmit - 802.11n-40BW_15Mbps(2.4G Band) (2437 MHz)
 main chip_162 (Hynix) (Adapter- M/N: WA-24E12FU)

| Frequency MHz | Correct Factor dB | Reading Level dBuV | Measurement Level dBuV/m | Margin dB | Limit dBuV/m |
|-------------------|-------------------------|--------------------------|--------------------------------|--------------|-----------------|
| Horizontal | | | | | |
| 191.020 | -10.040 | 42.565 | 32.525 | -10.975 | 43.500 |
| 388.900 | -1.684 | 39.514 | 37.830 | -8.170 | 46.000 |
| 540.220 | 2.551 | 31.788 | 34.339 | -11.661 | 46.000 |
| 598.420 | 3.991 | 31.509 | 35.500 | -10.500 | 46.000 |
| 798.240 | 5.148 | 33.169 | 38.317 | -7.683 | 46.000 |
| 866.140 | 5.596 | 28.244 | 33.840 | -12.160 | 46.000 |
| Vertical | | | | | |
| 117.300 | -3.106 | 38.077 | 34.971 | -8.529 | 43.500 |
| 386.960 | -3.064 | 42.394 | 39.330 | -6.670 | 46.000 |
| 499.480 | -0.852 | 31.577 | 30.725 | -15.275 | 46.000 |
| 608.120 | -1.576 | 32.055 | 30.479 | -15.521 | 46.000 |
| 809.880 | 3.279 | 26.625 | 29.904 | -16.096 | 46.000 |
| 885.540 | 2.552 | 29.743 | 32.295 | -13.705 | 46.000 |

Note:

1. All Readings below 1GHz are Quasi-Peak, above 1GHz are performed with peak and/or average measurements as necessary.
2. Peak measurements: RBW = 1MHz, VBW = 3 MHz, Sweep: Auto.
3. Average measurements: RBW = 1MHz, VBW = 10 Hz, Sweep: Auto.
4. Measurement Level = Reading Level + Correct Factor.
5. Correct Factor = Antenna factor + Cable loss – Amplifier gain.
6. The average measurement was not performed when the peak measured data under the limit of average detection.
7. The emission levels of other frequencies are very lower than the limit and not show in test report.

Product : PS1 Speaker
 Test Item : General Radiated Emission Data
 Test Site : No.3 OATS
 Test Mode : Mode 1: Transmit (802.11b 1Mbps) (2437 MHz) main chip_166 (winbond)
 (Adapter- M/N: WA-24E12FU)

| Frequency MHz | Correct Factor dB | Reading Level dBuV | Measurement Level dBuV/m | Margin dB | Limit dBuV/m |
|-------------------|-------------------------|--------------------------|--------------------------------|--------------|-----------------|
| Horizontal | | | | | |
| 398.600 | -2.268 | 36.908 | 34.640 | -11.360 | 46.000 |
| 540.220 | 2.551 | 32.258 | 34.809 | -11.191 | 46.000 |
| 623.640 | 1.959 | 34.900 | 36.859 | -9.141 | 46.000 |
| 666.320 | 2.031 | 33.232 | 35.264 | -10.736 | 46.000 |
| 809.880 | 5.049 | 31.712 | 36.761 | -9.239 | 46.000 |
| 908.820 | 6.029 | 34.284 | 40.313 | -5.687 | 46.000 |
| Vertical | | | | | |
| 95.960 | -2.790 | 41.651 | 38.861 | -4.639 | 43.500 |
| 175.500 | -8.257 | 42.610 | 34.352 | -9.148 | 43.500 |
| 497.540 | -1.393 | 32.731 | 31.338 | -14.662 | 46.000 |
| 666.320 | -1.809 | 34.692 | 32.884 | -13.116 | 46.000 |
| 749.740 | 2.510 | 32.638 | 35.148 | -10.852 | 46.000 |
| 891.360 | 2.218 | 29.253 | 31.471 | -14.529 | 46.000 |

Note:

1. All Readings below 1GHz are Quasi-Peak, above 1GHz are performed with peak and/or average measurements as necessary.
2. Peak measurements: RBW = 1MHz, VBW = 3 MHz, Sweep: Auto.
3. Average measurements: RBW = 1MHz, VBW = 10 Hz, Sweep: Auto.
4. Measurement Level = Reading Level + Correct Factor.
5. Correct Factor = Antenna factor + Cable loss – Amplifier gain.
6. The average measurement was not performed when the peak measured data under the limit of average detection.
7. The emission levels of other frequencies are very lower than the limit and not show in test report.

Product : PS1 Speaker
 Test Item : General Radiated Emission Data
 Test Site : No.3 OATS
 Test Mode : Mode 2: Transmit (802.11g 6Mbps) (2437 MHz) main chip_166 (winbond)
 (Adapter- M/N: WA-24E12FU)

| Frequency MHz | Correct Factor dB | Reading Level dBuV | Measurement Level dBuV/m | Margin dB | Limit dBuV/m |
|-------------------|-------------------------|--------------------------|--------------------------------|--------------|-----------------|
| Horizontal | | | | | |
| 191.020 | -10.040 | 44.544 | 34.504 | -8.996 | 43.500 |
| 540.220 | 2.551 | 32.403 | 34.954 | -11.046 | 46.000 |
| 623.640 | 1.959 | 35.392 | 37.351 | -8.649 | 46.000 |
| 666.320 | 2.031 | 34.480 | 36.512 | -9.488 | 46.000 |
| 798.240 | 5.148 | 31.884 | 37.032 | -8.968 | 46.000 |
| 916.580 | 6.144 | 27.726 | 33.870 | -12.130 | 46.000 |
| Vertical | | | | | |
| 171.620 | -8.752 | 46.769 | 38.017 | -5.483 | 43.500 |
| 410.240 | -6.616 | 41.204 | 34.588 | -11.412 | 46.000 |
| 499.480 | -0.852 | 31.388 | 30.536 | -15.464 | 46.000 |
| 623.640 | -2.631 | 32.926 | 30.295 | -15.705 | 46.000 |
| 749.740 | 2.510 | 31.867 | 34.377 | -11.623 | 46.000 |
| 883.600 | 2.566 | 28.864 | 31.429 | -14.571 | 46.000 |

Note:

1. All Readings below 1GHz are Quasi-Peak, above 1GHz are performed with peak and/or average measurements as necessary.
2. Peak measurements: RBW = 1MHz, VBW = 3 MHz, Sweep: Auto.
3. Average measurements: RBW = 1MHz, VBW = 10 Hz, Sweep: Auto.
4. Measurement Level = Reading Level + Correct Factor.
5. Correct Factor = Antenna factor + Cable loss – Amplifier gain.
6. The average measurement was not performed when the peak measured data under the limit of average detection.
7. The emission levels of other frequencies are very lower than the limit and not show in test report.

Product : PS1 Speaker
 Test Item : General Radiated Emission Data
 Test Site : No.3 OATS
 Test Mode : Mode 3: Transmit - 802.11n-20BW_7.2Mbps(2.4G Band) (2437 MHz)
 main chip_166 (winbond) (Adapter- M/N: WA-24E12FU)

| Frequency MHz | Correct Factor dB | Reading Level dBuV | Measurement Level dBuV/m | Margin dB | Limit dBuV/m |
|-------------------|-------------------------|--------------------------|--------------------------------|--------------|-----------------|
| Horizontal | | | | | |
| 49.400 | -11.018 | 45.169 | 34.151 | -5.849 | 40.000 |
| 412.180 | -3.245 | 35.924 | 32.679 | -13.321 | 46.000 |
| 540.220 | 2.551 | 31.322 | 33.873 | -12.127 | 46.000 |
| 623.640 | 1.959 | 34.790 | 36.749 | -9.251 | 46.000 |
| 798.240 | 5.148 | 30.989 | 36.137 | -9.863 | 46.000 |
| 897.180 | 5.182 | 25.714 | 30.896 | -15.104 | 46.000 |
| Vertical | | | | | |
| 101.780 | -0.021 | 37.298 | 37.276 | -6.224 | 43.500 |
| 373.380 | -2.373 | 39.273 | 36.900 | -9.100 | 46.000 |
| 540.220 | 0.121 | 29.231 | 29.352 | -16.648 | 46.000 |
| 623.640 | -2.631 | 32.265 | 29.634 | -16.366 | 46.000 |
| 749.740 | 2.510 | 33.943 | 36.453 | -9.547 | 46.000 |
| 920.460 | 5.517 | 27.336 | 32.853 | -13.147 | 46.000 |

Note:

1. All Readings below 1GHz are Quasi-Peak, above 1GHz are performed with peak and/or average measurements as necessary.
2. Peak measurements: RBW = 1MHz, VBW = 3 MHz, Sweep: Auto.
3. Average measurements: RBW = 1MHz, VBW = 10 Hz, Sweep: Auto.
4. Measurement Level = Reading Level + Correct Factor.
5. Correct Factor = Antenna factor + Cable loss – Amplifier gain.
6. The average measurement was not performed when the peak measured data under the limit of average detection.
7. The emission levels of other frequencies are very lower than the limit and not show in test report.

Product : PS1 Speaker
 Test Item : General Radiated Emission Data
 Test Site : No.3 OATS
 Test Mode : Mode 4: Transmit - 802.11n-40BW_15Mbps(2.4G Band) (2437 MHz)
 main chip_166 (winbond) (Adapter- M/N: WA-24E12FU)

| Frequency MHz | Correct Factor dB | Reading Level dBuV | Measurement Level dBuV/m | Margin dB | Limit dBuV/m |
|-------------------|-------------------------|--------------------------|--------------------------------|--------------|-----------------|
| Horizontal | | | | | |
| 43.580 | -4.496 | 37.634 | 33.138 | -6.862 | 40.000 |
| 404.420 | -2.269 | 36.233 | 33.964 | -12.036 | 46.000 |
| 540.220 | 2.551 | 33.769 | 36.320 | -9.680 | 46.000 |
| 623.640 | 1.959 | 35.387 | 37.346 | -8.654 | 46.000 |
| 798.240 | 5.148 | 30.626 | 35.774 | -10.226 | 46.000 |
| 899.120 | 5.433 | 25.912 | 31.345 | -14.655 | 46.000 |
| Vertical | | | | | |
| 97.900 | -1.400 | 34.442 | 33.041 | -10.459 | 43.500 |
| 497.540 | -1.393 | 29.996 | 28.603 | -17.397 | 46.000 |
| 623.640 | -2.631 | 33.683 | 31.052 | -14.948 | 46.000 |
| 699.300 | 0.695 | 35.541 | 36.236 | -9.764 | 46.000 |
| 835.100 | 1.995 | 31.390 | 33.385 | -12.615 | 46.000 |
| 924.340 | 5.550 | 28.393 | 33.943 | -12.057 | 46.000 |

Note:

1. All Readings below 1GHz are Quasi-Peak, above 1GHz are performed with peak and/or average measurements as necessary.
2. Peak measurements: RBW = 1MHz, VBW = 3 MHz, Sweep: Auto.
3. Average measurements: RBW = 1MHz, VBW = 10 Hz, Sweep: Auto.
4. Measurement Level = Reading Level + Correct Factor.
5. Correct Factor = Antenna factor + Cable loss – Amplifier gain.
6. The average measurement was not performed when the peak measured data under the limit of average detection.
7. The emission levels of other frequencies are very lower than the limit and not show in test report.

Product : PS1 Speaker
 Test Item : General Radiated Emission Data
 Test Site : No.3 OATS
 Test Mode : Mode 1: Transmit (802.11b 1Mbps) (2437MHz) (Adapter- M/N: WA-24E12)

| Frequency MHz | Correct Factor dB | Reading Level dBuV | Measurement Level dBuV/m | Margin dB | Limit dBuV/m |
|-------------------|-------------------------|--------------------------|--------------------------------|--------------|-----------------|
| Horizontal | | | | | |
| 47.460 | -9.151 | 41.567 | 32.417 | -7.583 | 40.000 |
| 144.460 | -10.377 | 38.091 | 27.714 | -15.786 | 43.500 |
| 311.300 | -4.026 | 38.272 | 34.246 | -11.754 | 46.000 |
| 433.520 | -1.972 | 43.449 | 41.477 | -4.523 | 46.000 |
| 507.240 | 0.759 | 39.763 | 40.522 | -5.478 | 46.000 |
| 798.240 | 5.148 | 31.723 | 36.871 | -9.129 | 46.000 |
| Vertical | | | | | |
| 115.360 | -2.630 | 36.754 | 34.124 | -9.376 | 43.500 |
| 293.840 | -7.738 | 44.213 | 36.476 | -9.524 | 46.000 |
| 406.360 | -6.660 | 38.398 | 31.738 | -14.262 | 46.000 |
| 608.120 | -1.576 | 34.529 | 32.953 | -13.047 | 46.000 |
| 664.380 | -1.918 | 35.344 | 33.426 | -12.574 | 46.000 |
| 825.400 | 3.430 | 29.177 | 32.607 | -13.393 | 46.000 |

Note:

1. All Readings below 1GHz are Quasi-Peak, above 1GHz are performed with peak and/or average measurements as necessary.
2. Peak measurements: RBW = 1MHz, VBW = 3 MHz, Sweep: Auto.
3. Average measurements: RBW = 1MHz, VBW = 10 Hz, Sweep: Auto.
4. Measurement Level = Reading Level + Correct Factor.
5. Correct Factor = Antenna factor + Cable loss – Amplifier gain.
6. The average measurement was not performed when the peak measured data under the limit of average detection.
7. The emission levels of other frequencies are very lower than the limit and not show in test report.

Product : PS1 Speaker
 Test Item : General Radiated Emission Data
 Test Site : No.3 OATS
 Test Mode : Mode 2: Transmit (802.11g 6Mbps) (2437MHz) (Adapter- M/N: WA-24E12)

| Frequency MHz | Correct Factor dB | Reading Level dBuV | Measurement Level dBuV/m | Margin dB | Limit dBuV/m |
|-------------------|-------------------------|--------------------------|--------------------------------|--------------|-----------------|
| Horizontal | | | | | |
| 144.460 | -10.377 | 38.099 | 27.722 | -15.778 | 43.500 |
| 369.500 | -1.098 | 39.331 | 38.233 | -7.767 | 46.000 |
| 540.220 | 2.551 | 37.060 | 39.611 | -6.389 | 46.000 |
| 608.120 | 4.384 | 35.718 | 40.102 | -5.898 | 46.000 |
| 701.240 | 2.668 | 38.139 | 40.807 | -5.193 | 46.000 |
| 854.500 | 6.626 | 30.479 | 37.105 | -8.895 | 46.000 |
| Vertical | | | | | |
| 107.600 | -0.318 | 35.424 | 35.106 | -8.394 | 43.500 |
| 175.500 | -8.257 | 41.468 | 33.210 | -10.290 | 43.500 |
| 301.600 | -6.785 | 43.798 | 37.014 | -8.986 | 46.000 |
| 392.780 | -3.536 | 36.689 | 33.153 | -12.847 | 46.000 |
| 608.120 | -1.576 | 35.739 | 34.163 | -11.837 | 46.000 |
| 749.740 | 2.510 | 33.320 | 35.830 | -10.170 | 46.000 |

Note:

1. All Readings below 1GHz are Quasi-Peak, above 1GHz are performed with peak and/or average measurements as necessary.
2. Peak measurements: RBW = 1MHz, VBW = 3 MHz, Sweep: Auto.
3. Average measurements: RBW = 1MHz, VBW = 10 Hz, Sweep: Auto.
4. Measurement Level = Reading Level + Correct Factor.
5. Correct Factor = Antenna factor + Cable loss – Amplifier gain.
6. The average measurement was not performed when the peak measured data under the limit of average detection.
7. The emission levels of other frequencies are very lower than the limit and not show in test report.

Product : PS1 Speaker
 Test Item : General Radiated Emission Data
 Test Site : No.3 OATS
 Test Mode : Mode 3: Transmit - 802.11n-20BW_7.2Mbps(2.4G Band) (2437MHz)
 (Adapter- M/N: WA-24E12)

| Frequency MHz | Correct Factor dB | Reading Level dBuV | Measurement Level dBuV/m | Margin dB | Limit dBuV/m |
|-------------------|-------------------------|--------------------------|--------------------------------|--------------|-----------------|
| Horizontal | | | | | |
| 189.080 | -10.289 | 44.546 | 34.257 | -9.243 | 43.500 |
| 388.900 | -1.684 | 39.354 | 37.670 | -8.330 | 46.000 |
| 507.240 | 0.759 | 39.966 | 40.725 | -5.275 | 46.000 |
| 593.600 | 3.849 | 33.954 | 37.803 | -8.197 | 46.000 |
| 699.300 | 2.875 | 36.833 | 39.708 | -6.292 | 46.000 |
| 825.400 | 6.250 | 30.805 | 37.055 | -8.945 | 46.000 |
| Vertical | | | | | |
| 107.600 | -0.318 | 33.867 | 33.549 | -9.951 | 43.500 |
| 179.380 | -8.591 | 46.238 | 37.647 | -5.853 | 43.500 |
| 336.520 | -4.630 | 45.106 | 40.476 | -5.524 | 46.000 |
| 497.540 | -1.393 | 39.519 | 38.126 | -7.874 | 46.000 |
| 664.380 | -1.918 | 37.307 | 35.389 | -10.611 | 46.000 |
| 856.440 | 0.562 | 35.402 | 35.964 | -10.036 | 46.000 |

Note:

1. All Readings below 1GHz are Quasi-Peak, above 1GHz are performed with peak and/or average measurements as necessary.
2. Peak measurements: RBW = 1MHz, VBW = 3 MHz, Sweep: Auto.
3. Average measurements: RBW = 1MHz, VBW = 10 Hz, Sweep: Auto.
4. Measurement Level = Reading Level + Correct Factor.
5. Correct Factor = Antenna factor + Cable loss – Amplifier gain.
6. The average measurement was not performed when the peak measured data under the limit of average detection.
7. The emission levels of other frequencies are very lower than the limit and not show in test report.

Product : PS1 Speaker
 Test Item : General Radiated Emission Data
 Test Site : No.3 OATS
 Test Mode : Mode 4: Transmit - 802.11n-40BW_15Mbps(2.4G Band) (2437MHz)
 (Adapter- M/N: WA-24E12)

| Frequency MHz | Correct Factor dB | Reading Level dBuV | Measurement Level dBuV/m | Margin dB | Limit dBuV/m |
|-------------------|-------------------------|--------------------------|--------------------------------|--------------|-----------------|
| Horizontal | | | | | |
| 191.020 | -10.040 | 42.758 | 32.718 | -10.782 | 43.500 |
| 293.840 | -3.868 | 42.435 | 38.568 | -7.432 | 46.000 |
| 369.500 | -1.098 | 38.898 | 37.800 | -8.200 | 46.000 |
| 466.500 | 0.794 | 31.504 | 32.297 | -13.703 | 46.000 |
| 540.220 | 2.551 | 36.753 | 39.304 | -6.696 | 46.000 |
| 701.240 | 2.668 | 35.338 | 38.006 | -7.994 | 46.000 |
| Vertical | | | | | |
| 177.440 | -8.339 | 41.058 | 32.719 | -10.781 | 43.500 |
| 299.660 | -6.855 | 38.727 | 31.872 | -14.128 | 46.000 |
| 406.360 | -6.660 | 39.201 | 32.541 | -13.459 | 46.000 |
| 540.220 | 0.121 | 33.727 | 33.848 | -12.152 | 46.000 |
| 608.120 | -1.576 | 34.083 | 32.507 | -13.493 | 46.000 |
| 749.740 | 2.510 | 31.804 | 34.314 | -11.686 | 46.000 |

Note:

1. All Readings below 1GHz are Quasi-Peak, above 1GHz are performed with peak and/or average measurements as necessary.
2. Peak measurements: RBW = 1MHz, VBW = 3 MHz, Sweep: Auto.
3. Average measurements: RBW = 1MHz, VBW = 10 Hz, Sweep: Auto.
4. Measurement Level = Reading Level + Correct Factor.
5. Correct Factor = Antenna factor + Cable loss – Amplifier gain.
6. The average measurement was not performed when the peak measured data under the limit of average detection.
7. The emission levels of other frequencies are very lower than the limit and not show in test report.

5. RF antenna conducted test

5.1. Test Equipment

| | Equipment | Manufacturer | Model No./Serial No. | Last Cal. |
|---|-------------------|--------------|----------------------|------------|
| | Spectrum Analyzer | R&S | FSP40 / 100170 | Jun, 2012 |
| | Spectrum Analyzer | Agilent | E4407B / US39440758 | Jun, 2012 |
| X | Spectrum Analyzer | Agilent | N9010A / MY48030495 | Apr., 2012 |

- Note:
1. All equipments are calibrated with traceable calibrations. Each calibration is traceable to the national or international standards.
 2. The test instruments marked with “X” are used to measure the final test results.

5.2. Test Setup

RF antenna Conducted Measurement:

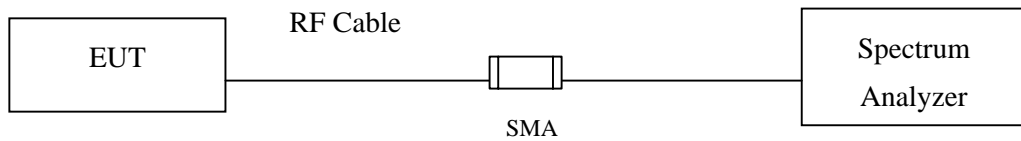

5.3. Limits

In any 100 kHz bandwidth outside the frequency band in which the spread spectrum intentional radiator is operating, the radio frequency power that is produced by the intentional radiator shall be at least 20 dB below that in the 100 kHz bandwidth within the band that contains the highest level of the desired power, based on either an RF conducted or a radiated measurement. Attenuation below the general limits specified in Section 15.209(a) is not required. In addition, radiated emissions which fall in the restricted bands, as defined in Section 15.205(a), must also comply with the radiated emission limits specified in Section 15.209(a) (see Section 15.205(c)).

5.4. Test Procedure

The EUT was tested according to DTS test procedure of ANSI C63.10: 2009 for compliance to FCC 47CFR 15.247 requirements.

Set RBW = 100 kHz, Set VBW > RBW, scan up through 10th harmonic.

5.5. Uncertainty

The measurement uncertainty

Conducted is defined as $\pm 1.27\text{dB}$

5.6. Test Result of RF antenna conducted test

Product : PS1 Speaker
 Test Item : RF antenna conducted test
 Test Site : No.3 OATS
 Test Mode : Mode 1: Transmit (802.11b 1Mbps) main chip_162

Channel 01 (2412MHz) 30MHz-25GHz

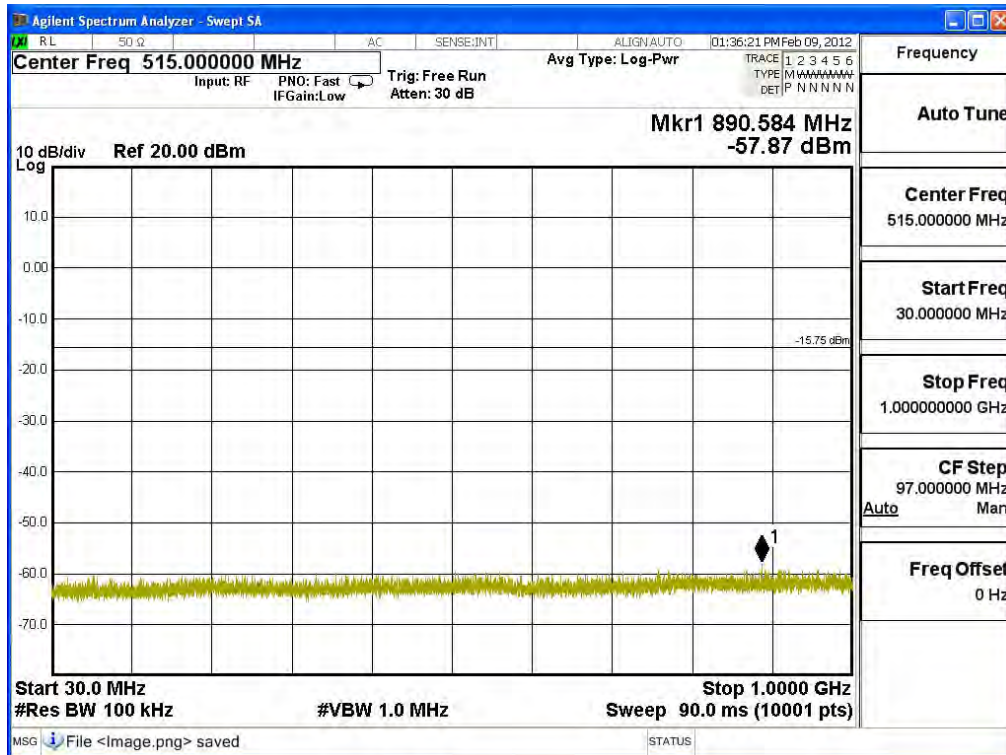

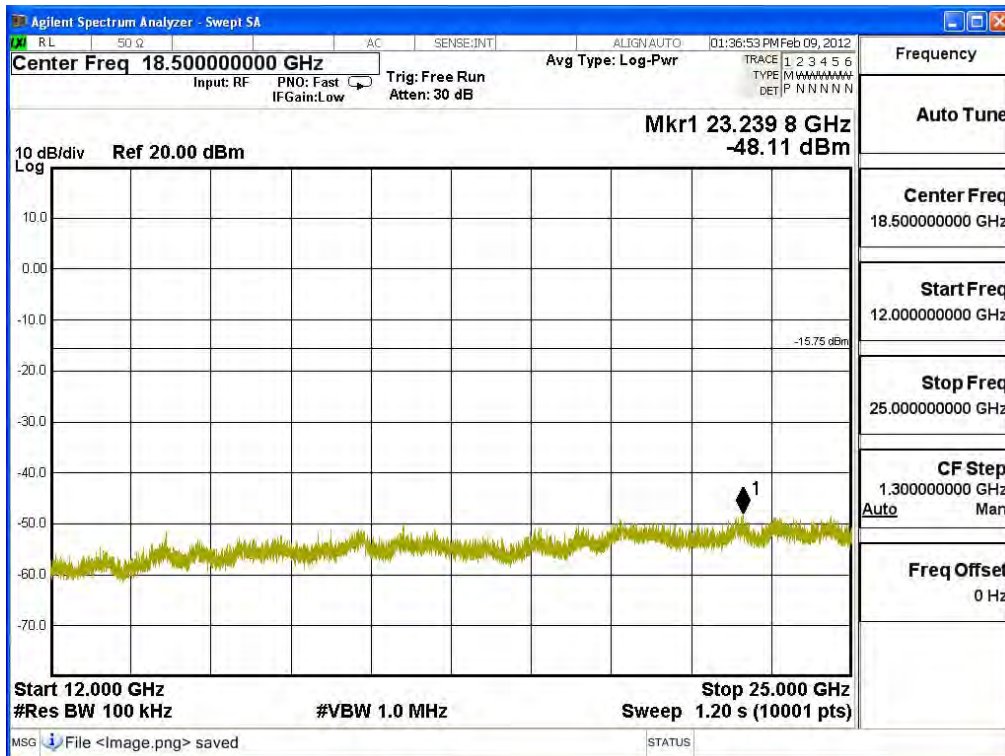
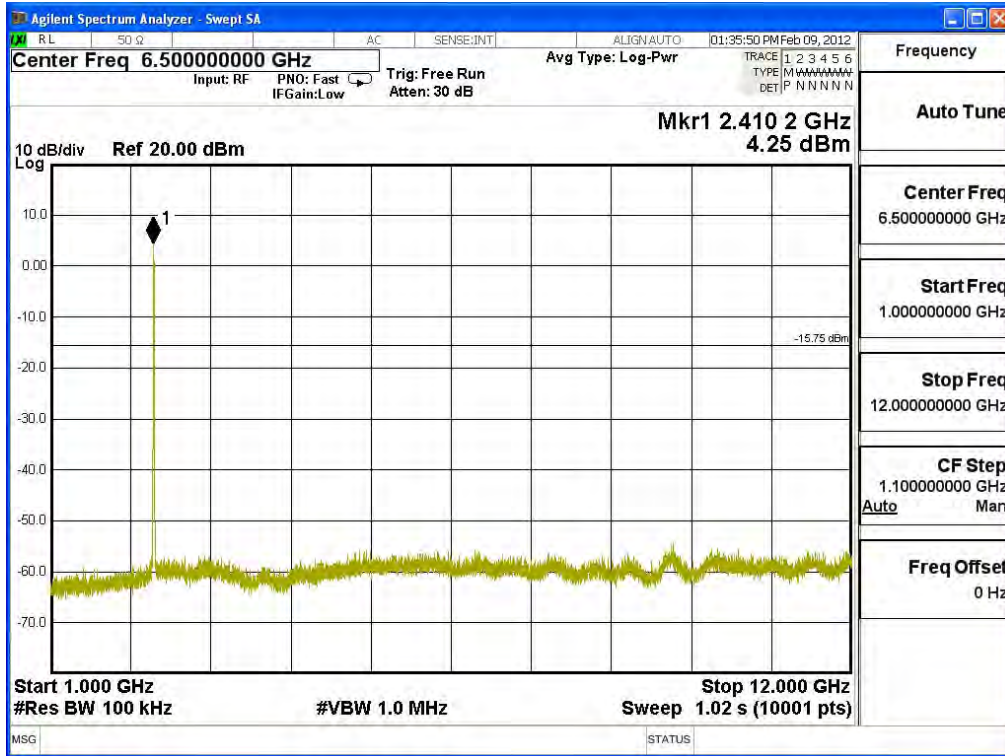

Channel 06 (2437MHz) 30MHz -25GHz

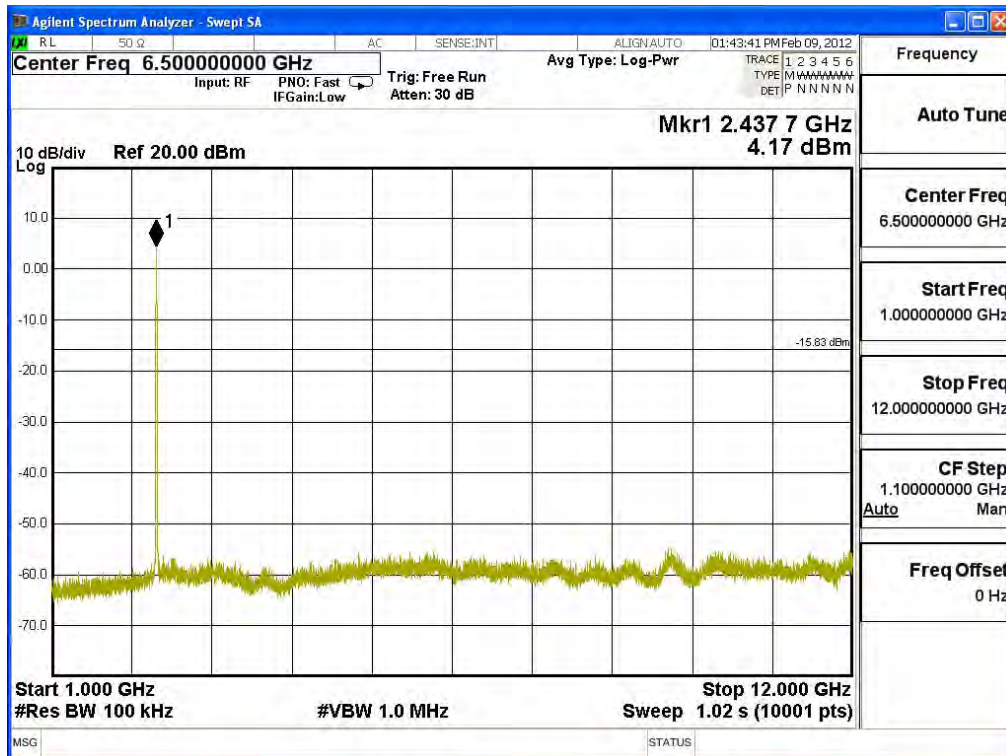
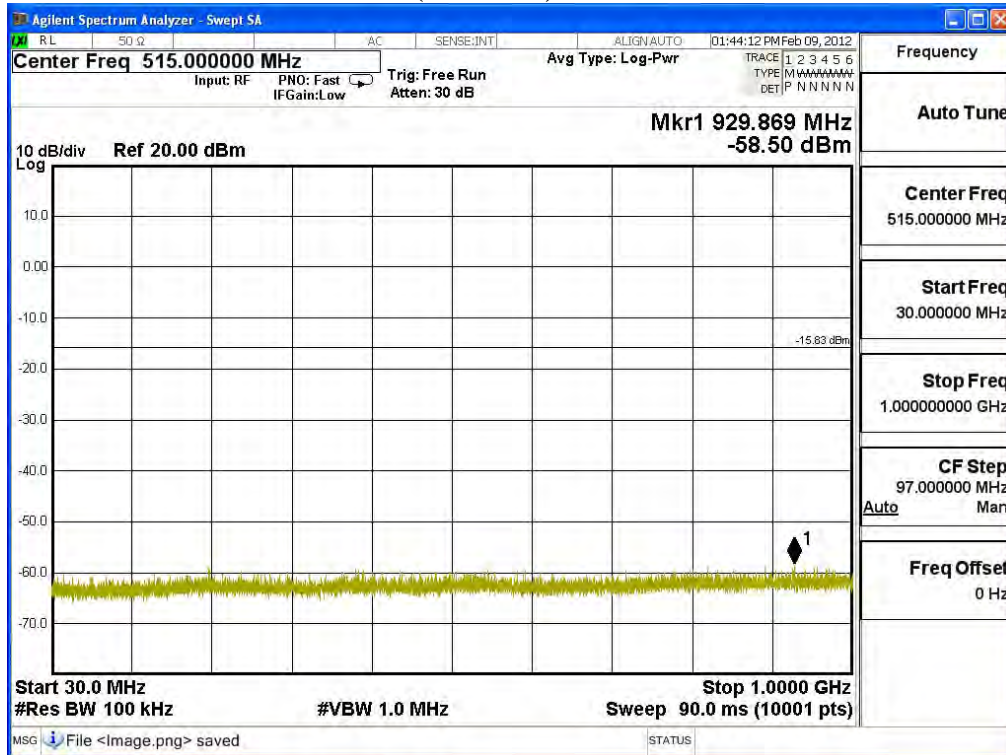

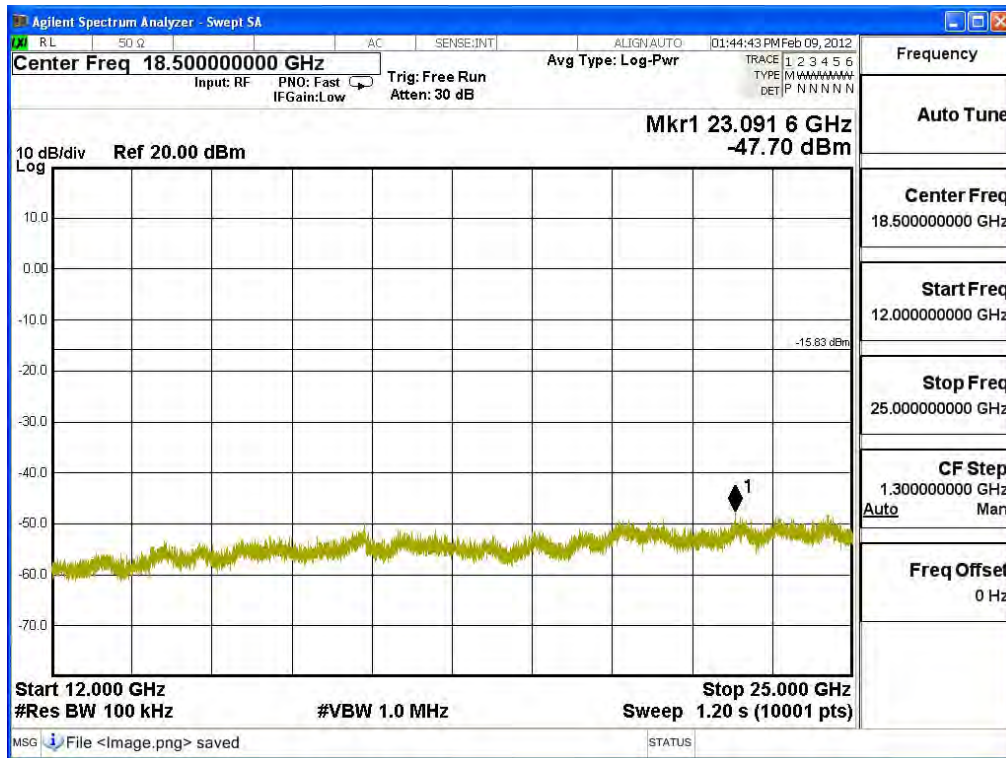

Channel 11 (2462MHz) 30MHz -25GHz

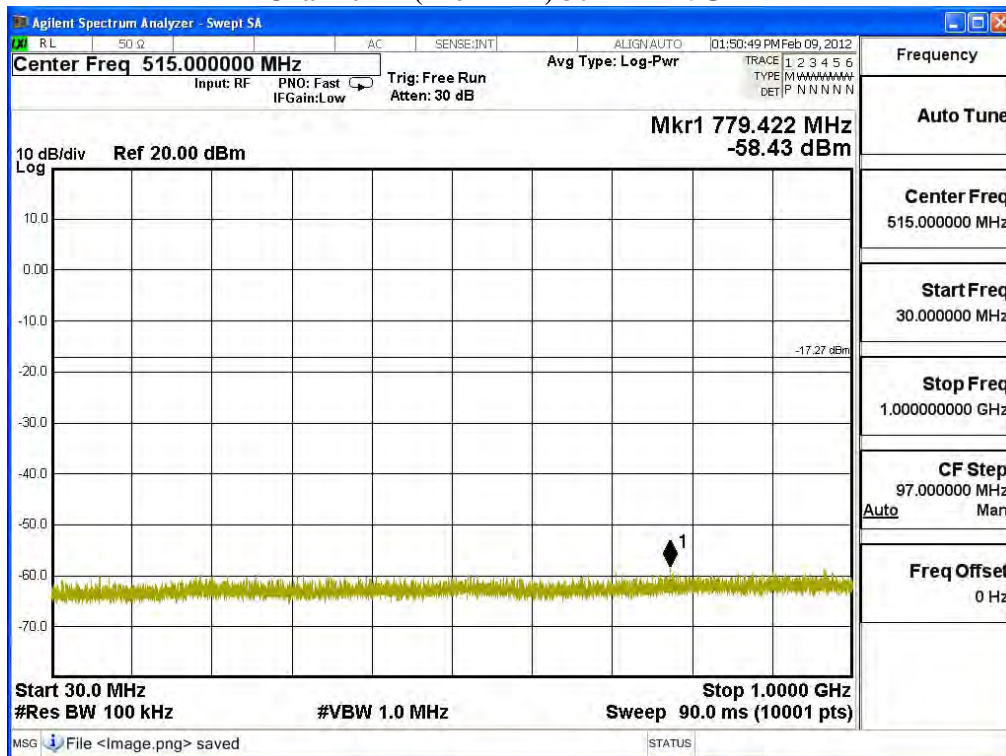

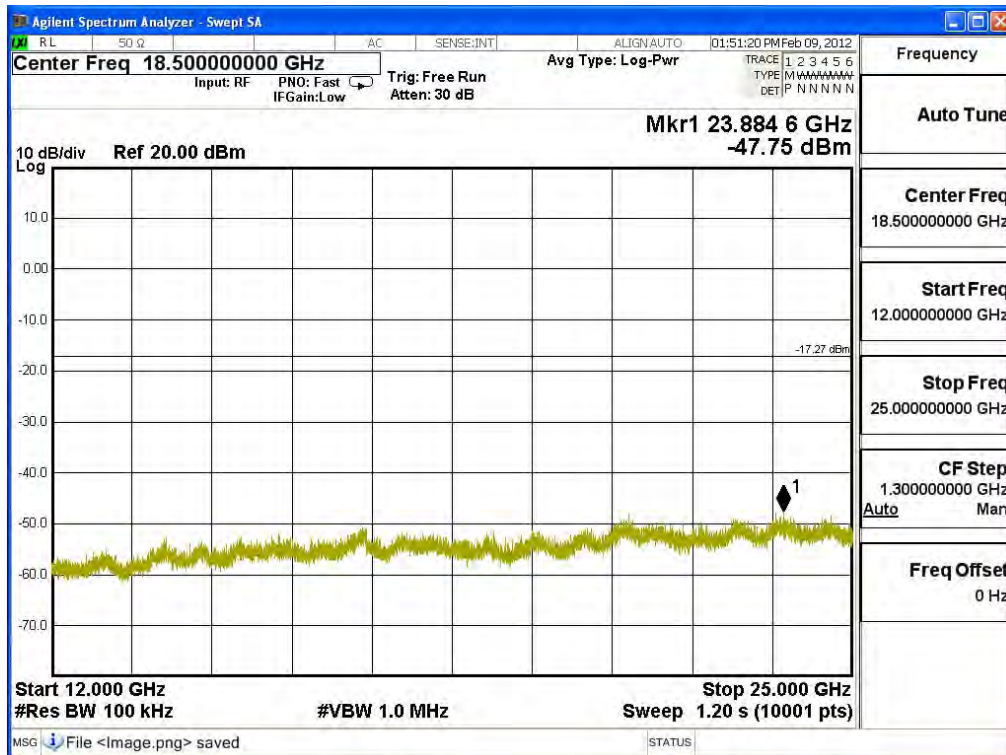
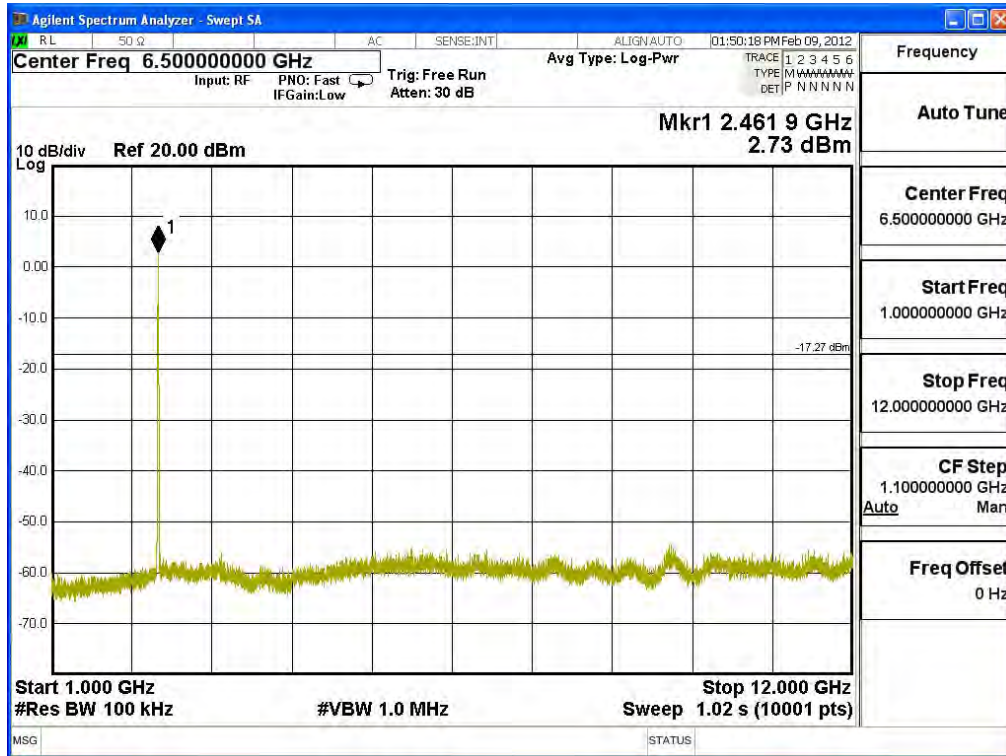

Product : PS1 Speaker
 Test Item : RF Antenna Conducted Spurious
 Test Site : No.3 OATS
 Test Mode : Mode 2: Transmit (802.11g 6Mbps) main chip_162

Channel 01 (2412MHz) 30MHz -25GHz

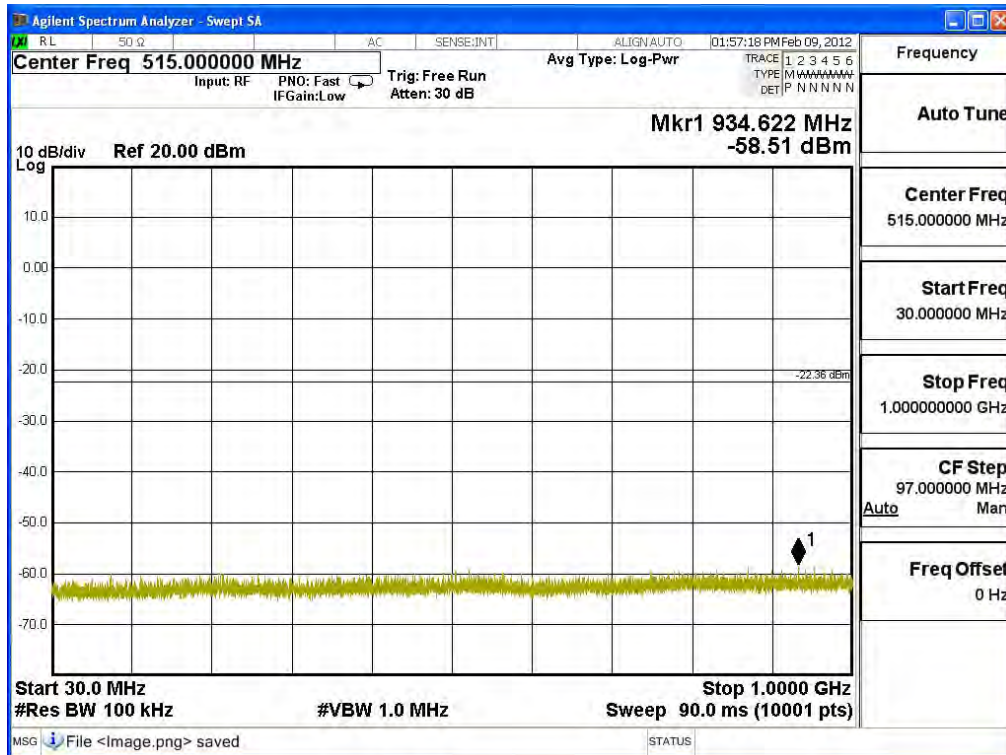

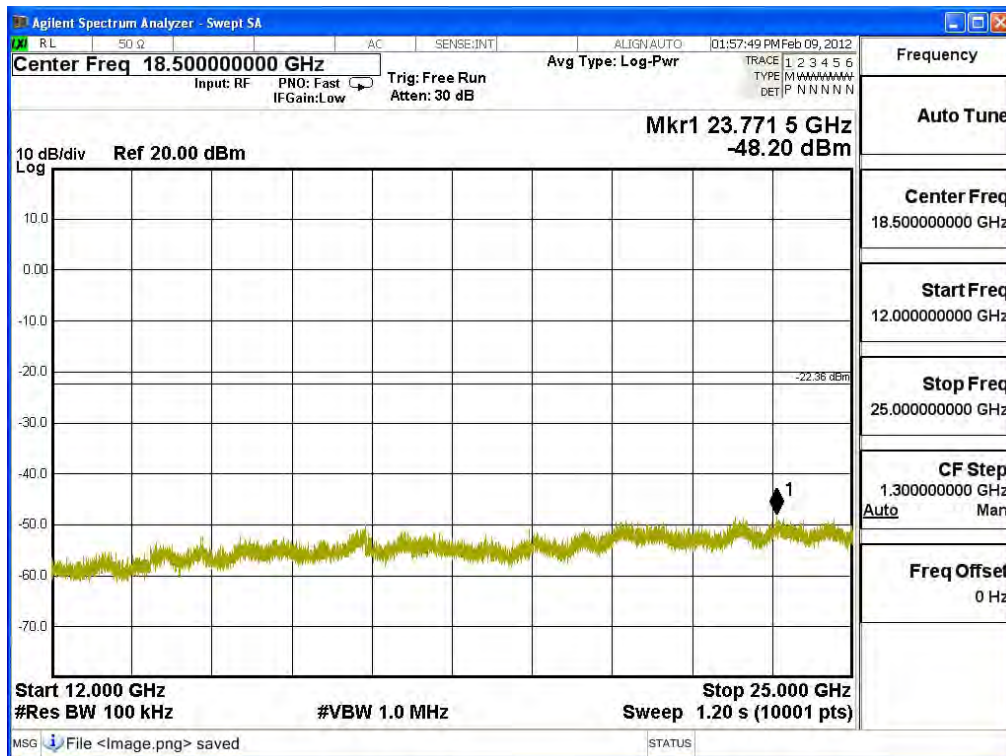
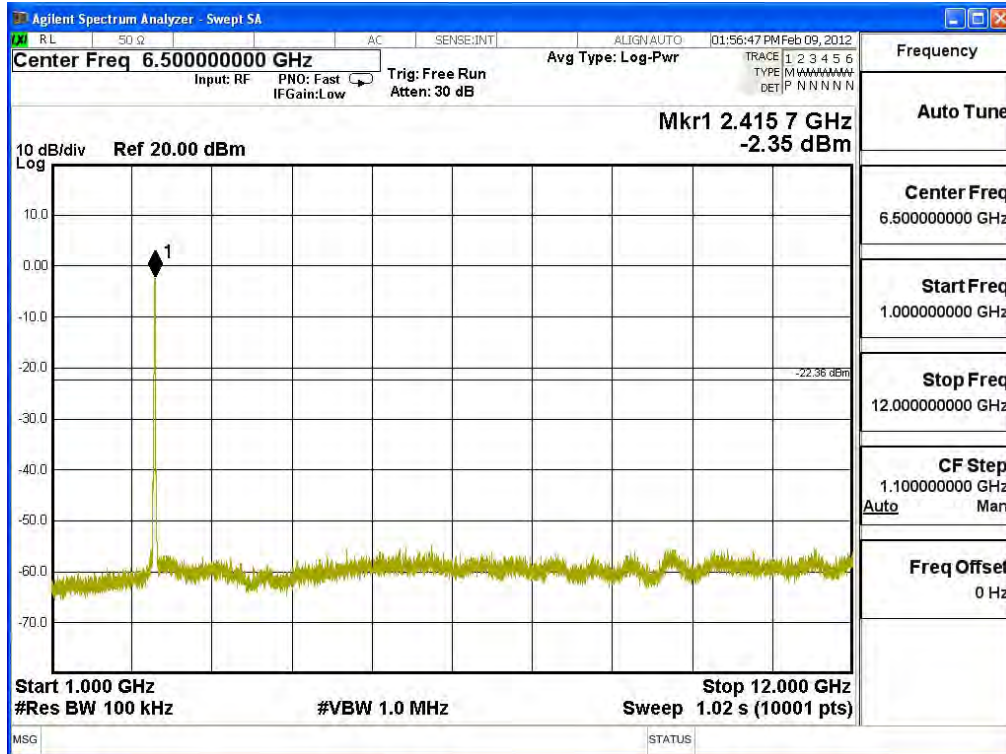

Channel 06 (2437MHz) 30MHz -25GHz

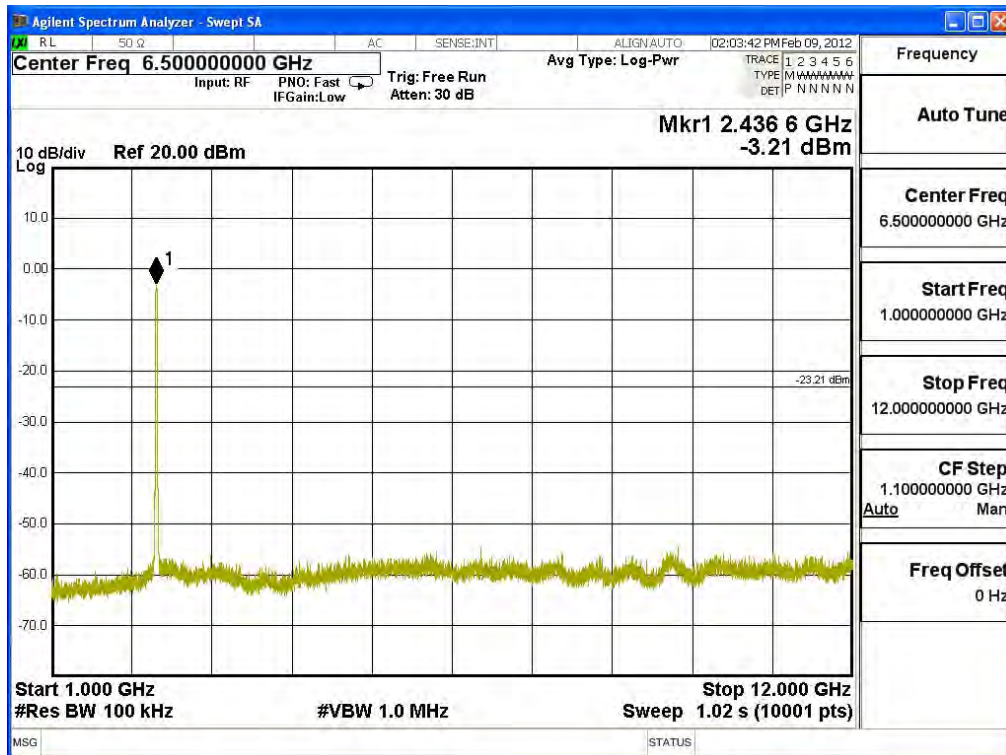
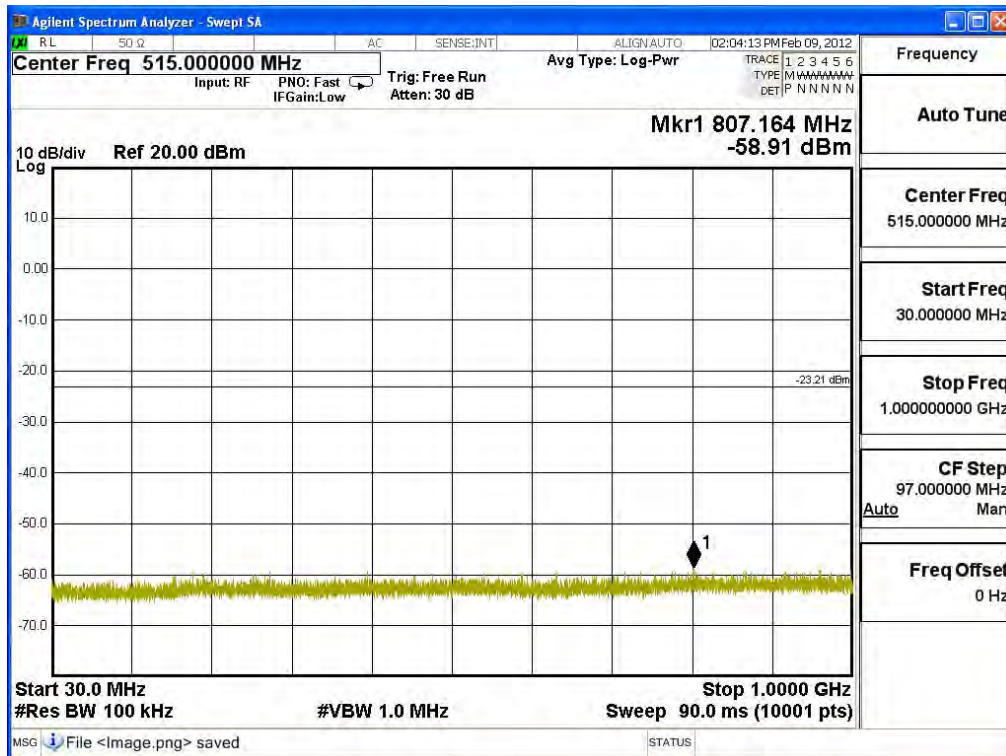

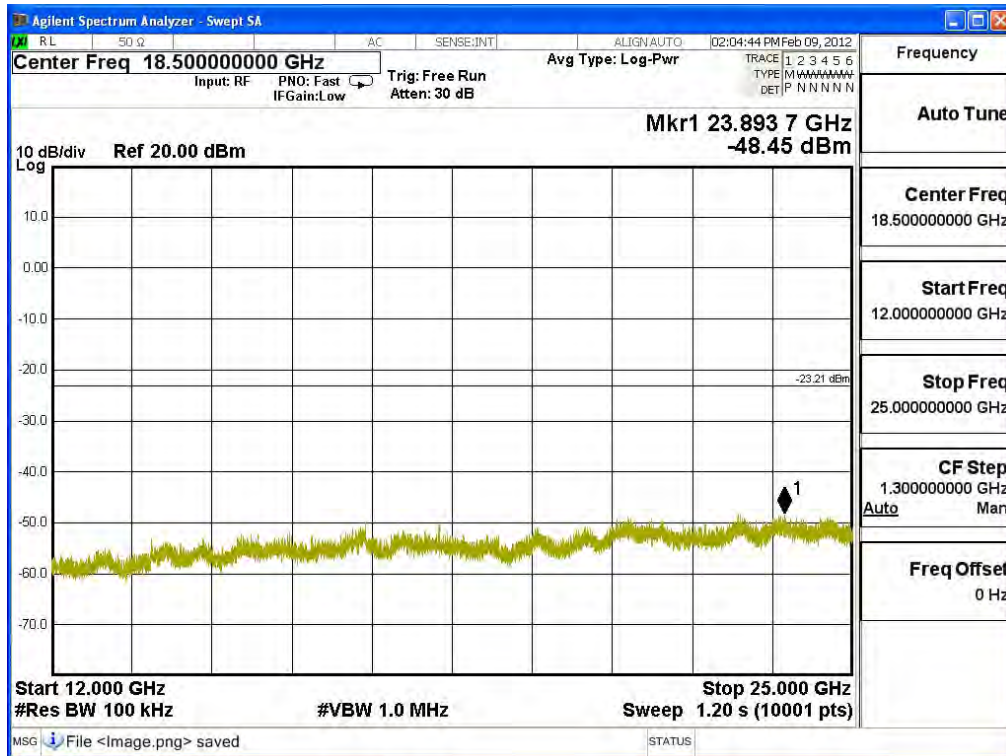

Channel 11 (2462MHz) 30MHz -25GHz

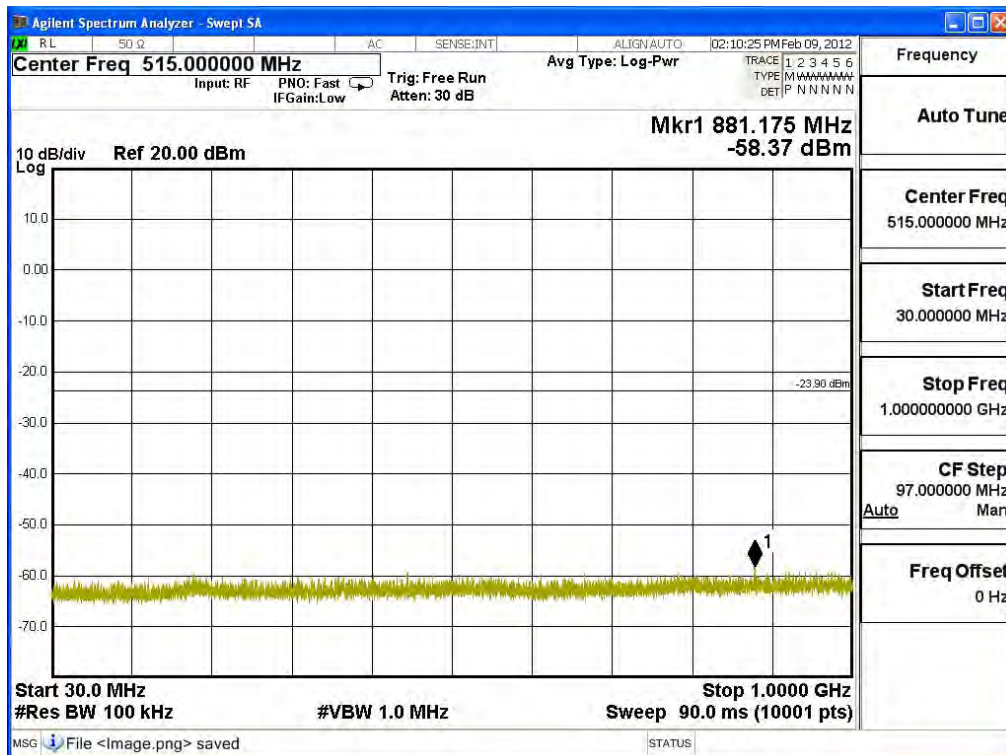

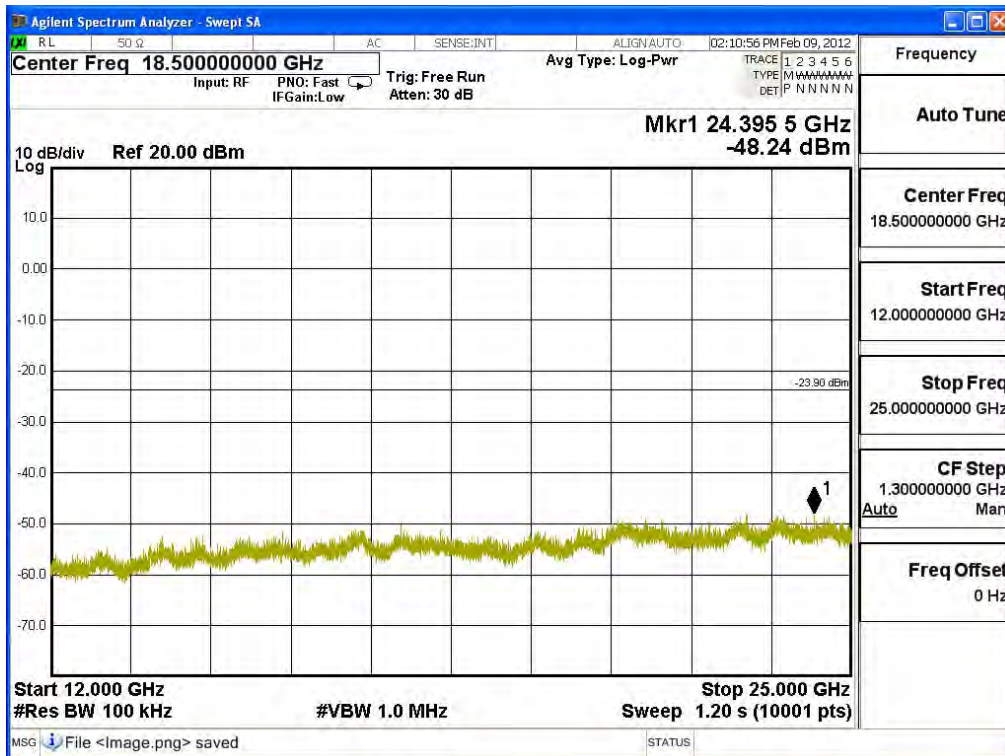
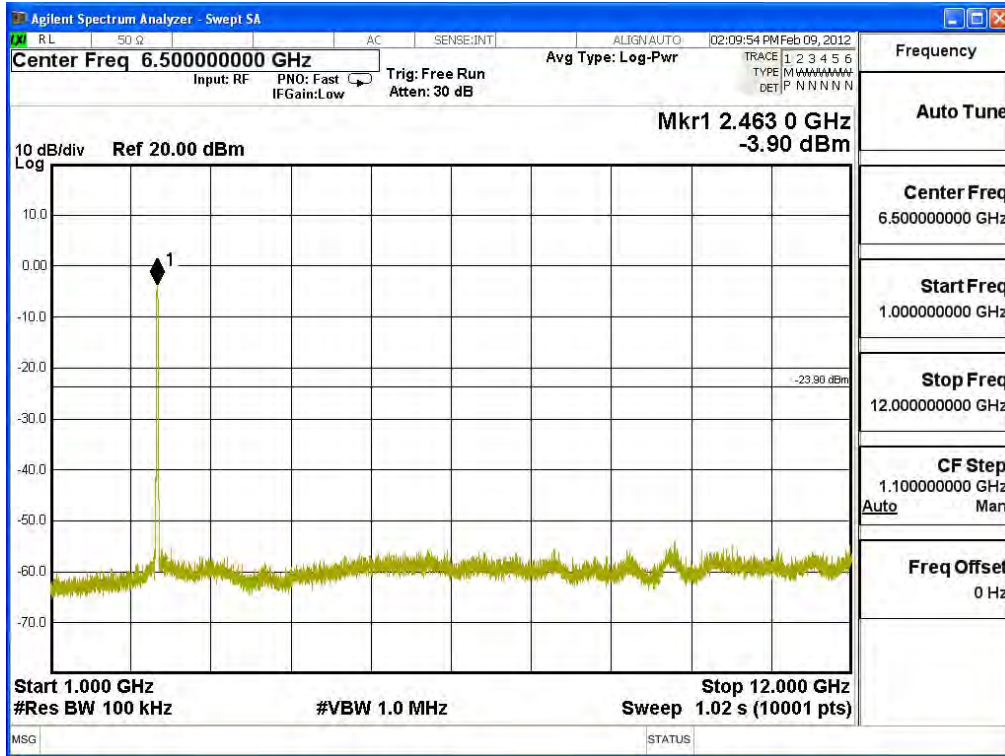

Product : PS1 Speaker
 Test Item : RF Antenna Conducted Spurious
 Test Site : No.3 OATS
 Test Mode : Mode 3: Transmit - 802.11n-20BW_7.2Mbps(2.4G Band) main chip_162

Channel 01 (2412MHz) 30MHz -25GHz

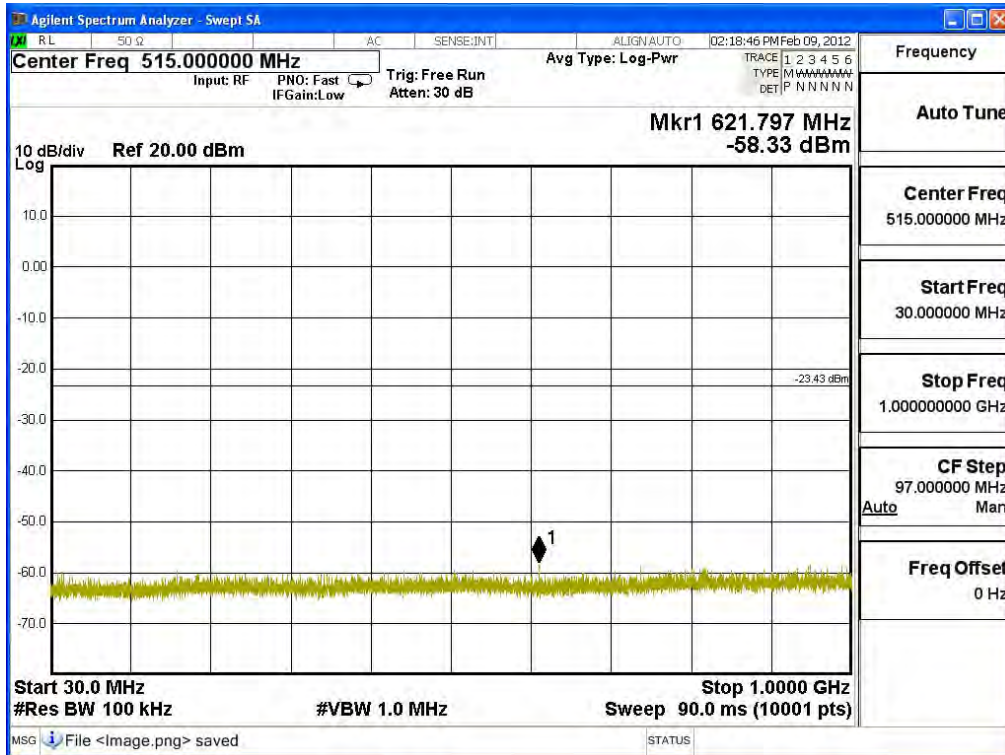

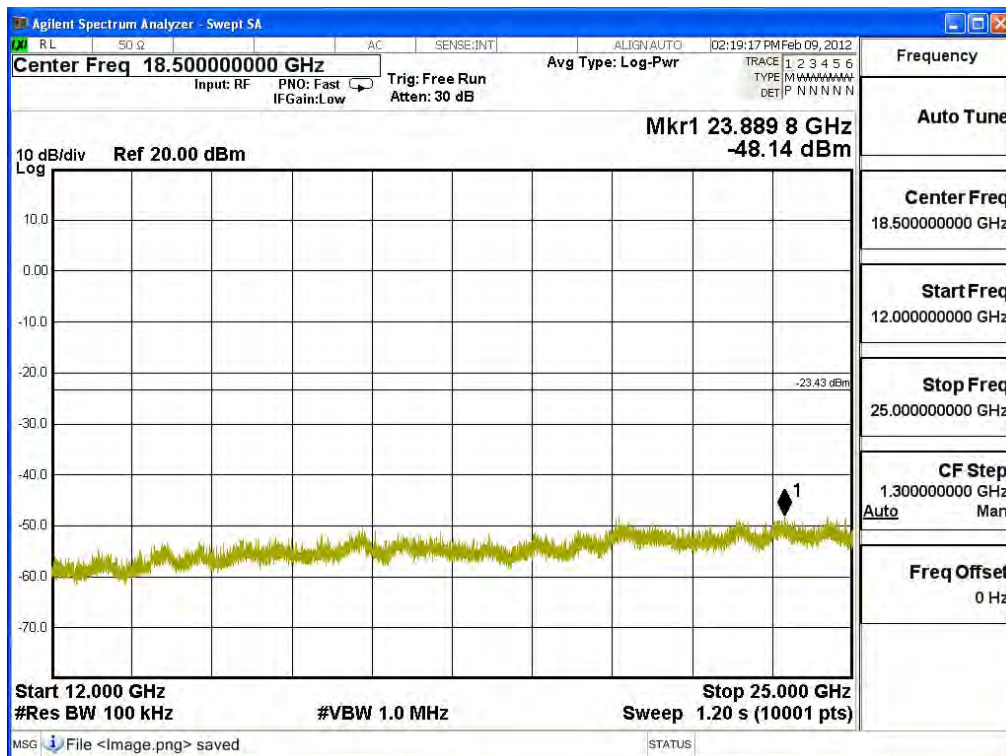
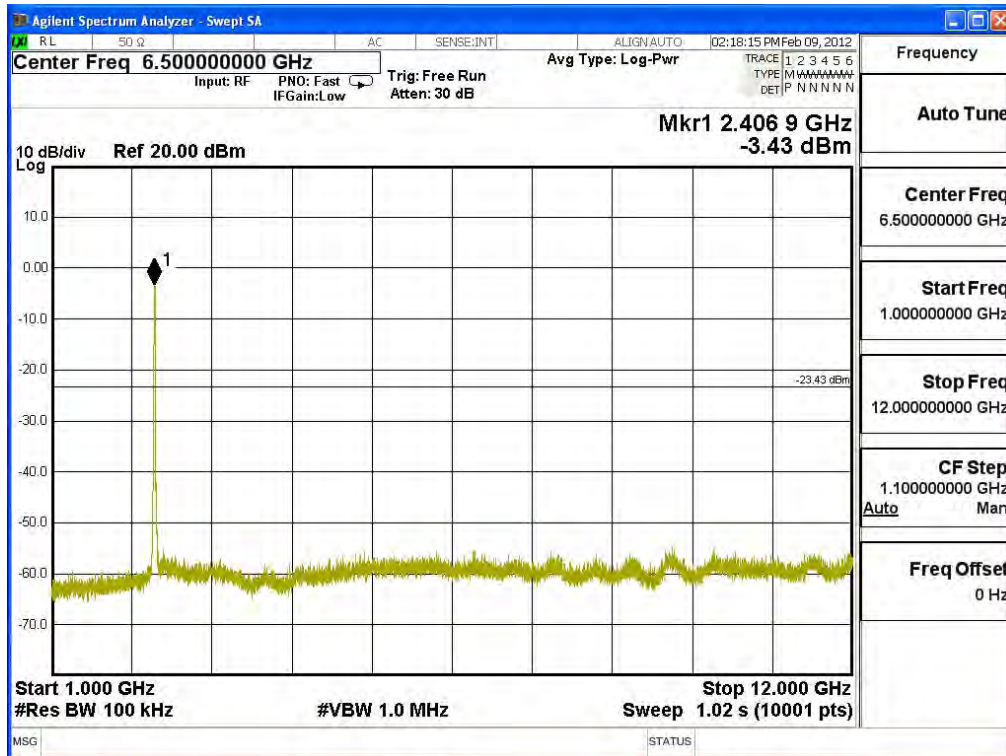

Channel 06 (2437MHz) 30MHz -25GHz

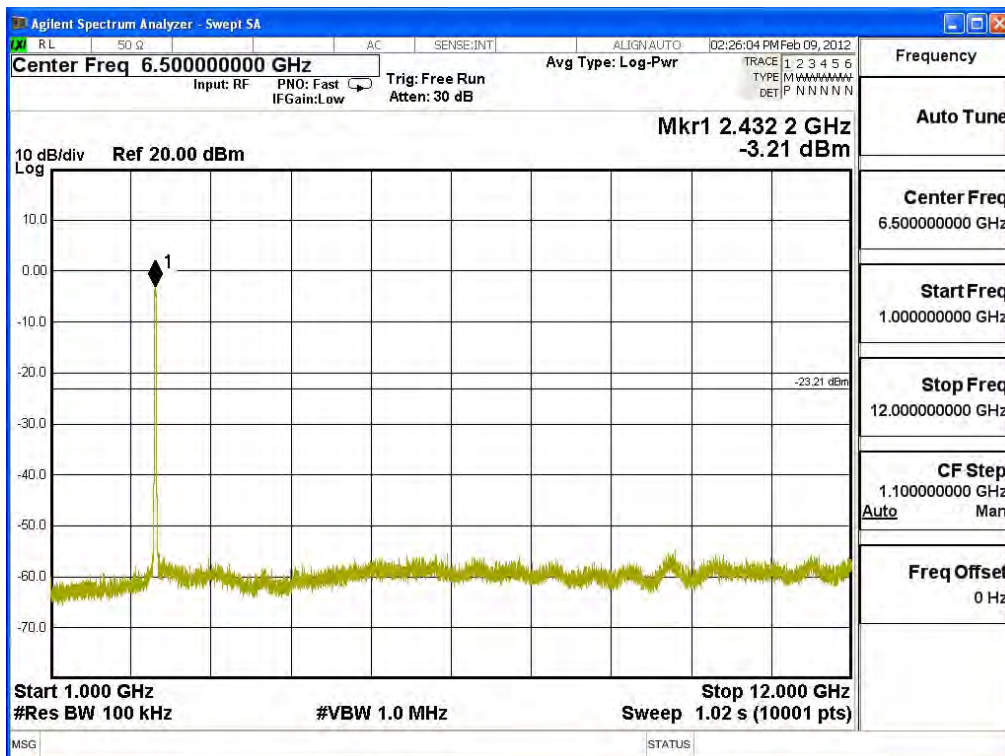
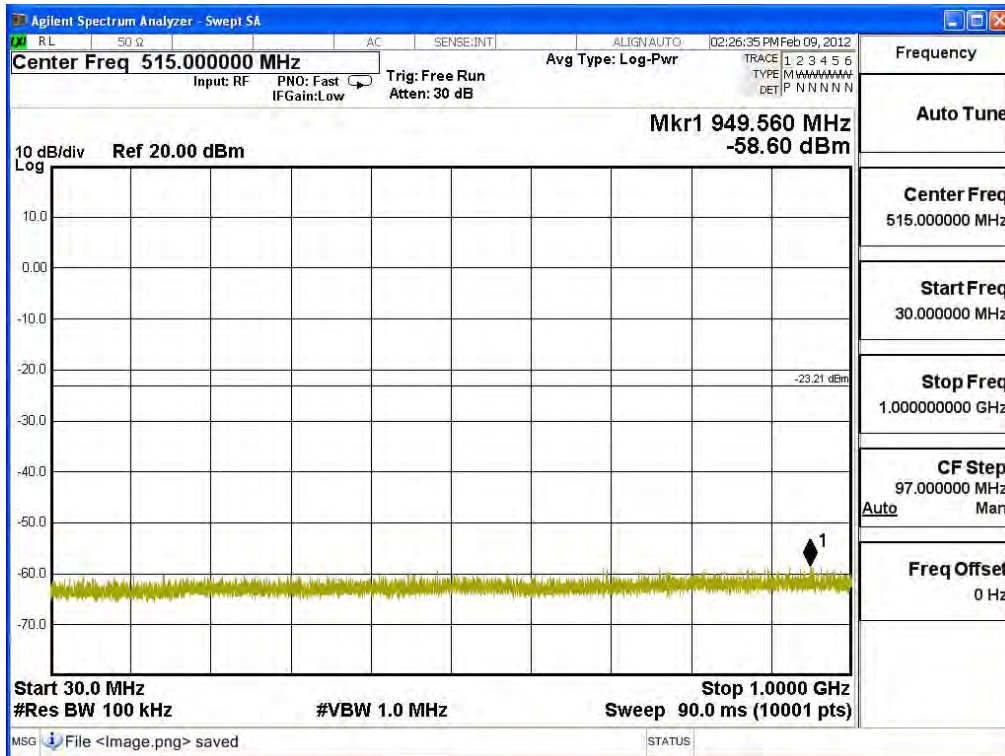

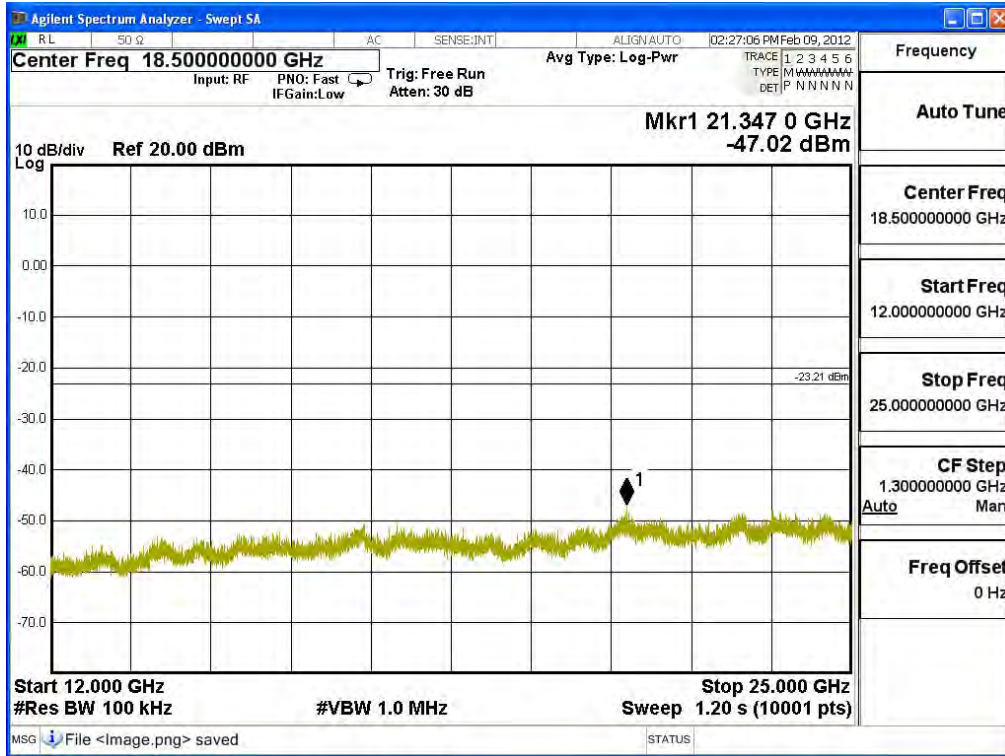

Channel 11 (2462MHz) 30MHz -25GHz

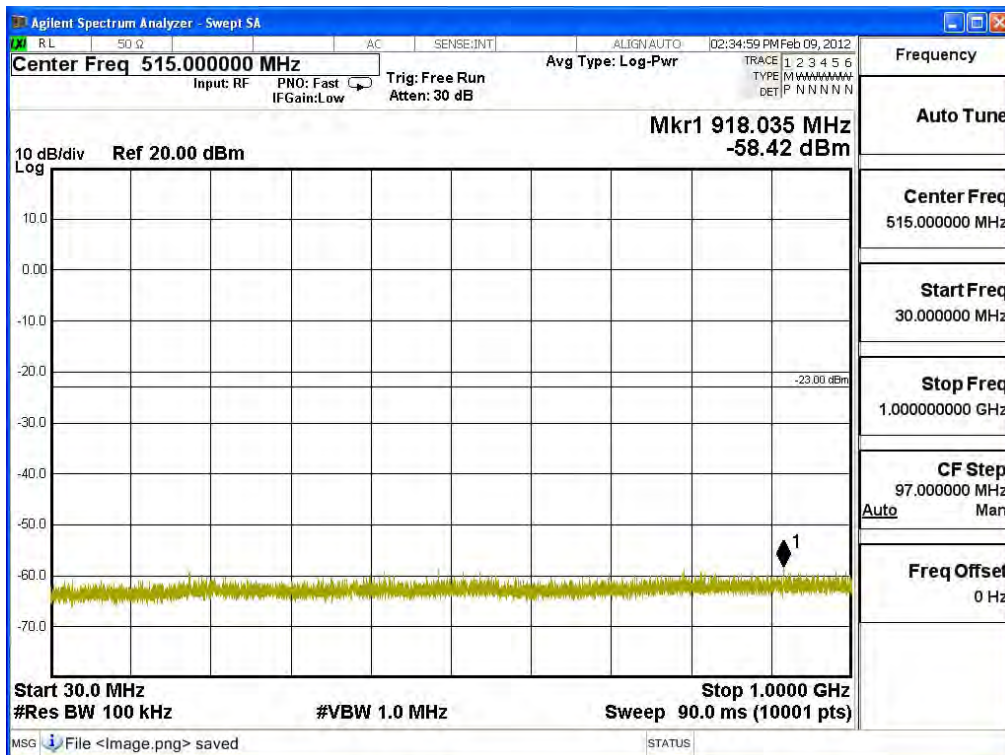

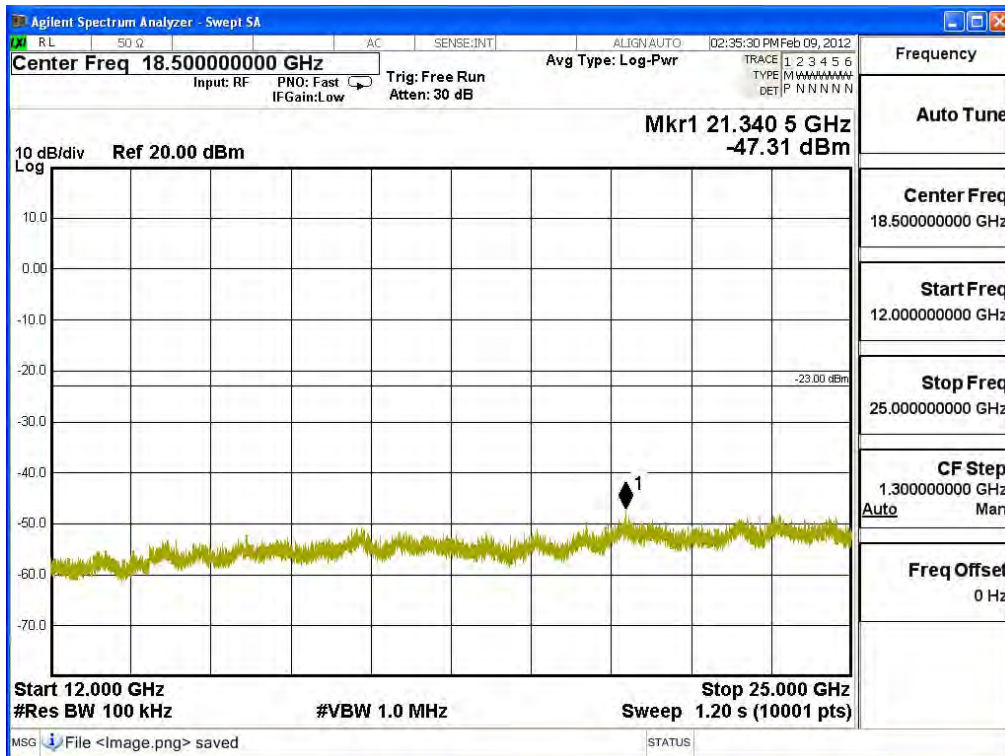
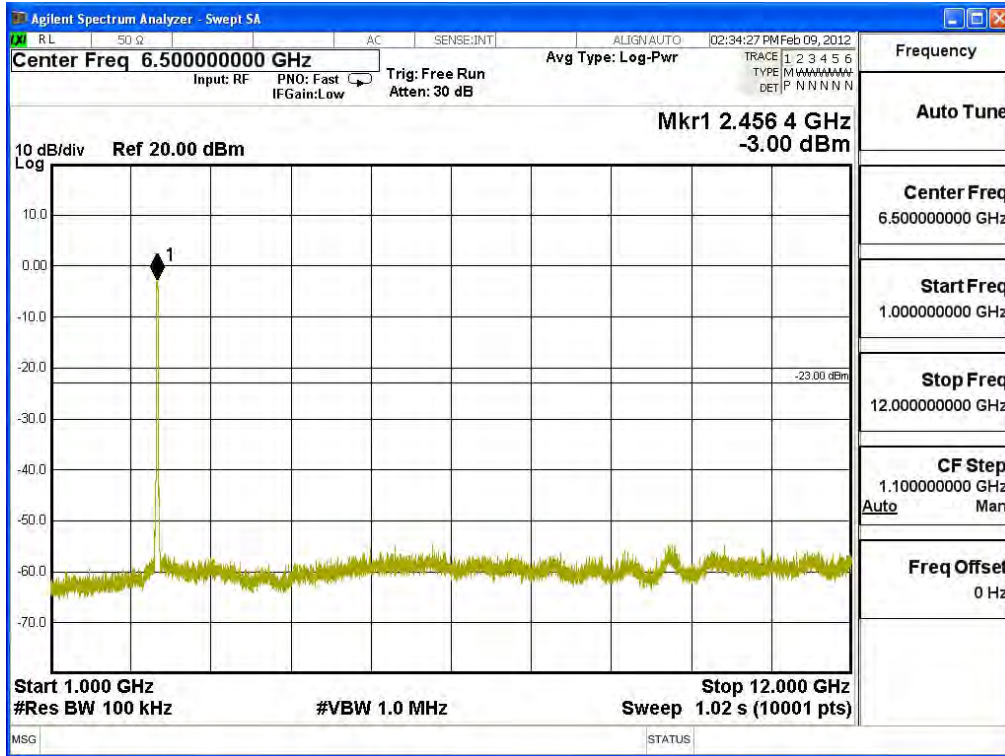

Product : PS1 Speaker
 Test Item : RF Antenna Conducted Spurious
 Test Site : No.3 OATS
 Test Mode : Mode 4: Transmit - 802.11n-40BW_15Mbps(2.4G Band) main chip_162

Channel 01 (2422MHz) 30MHz -25GHz

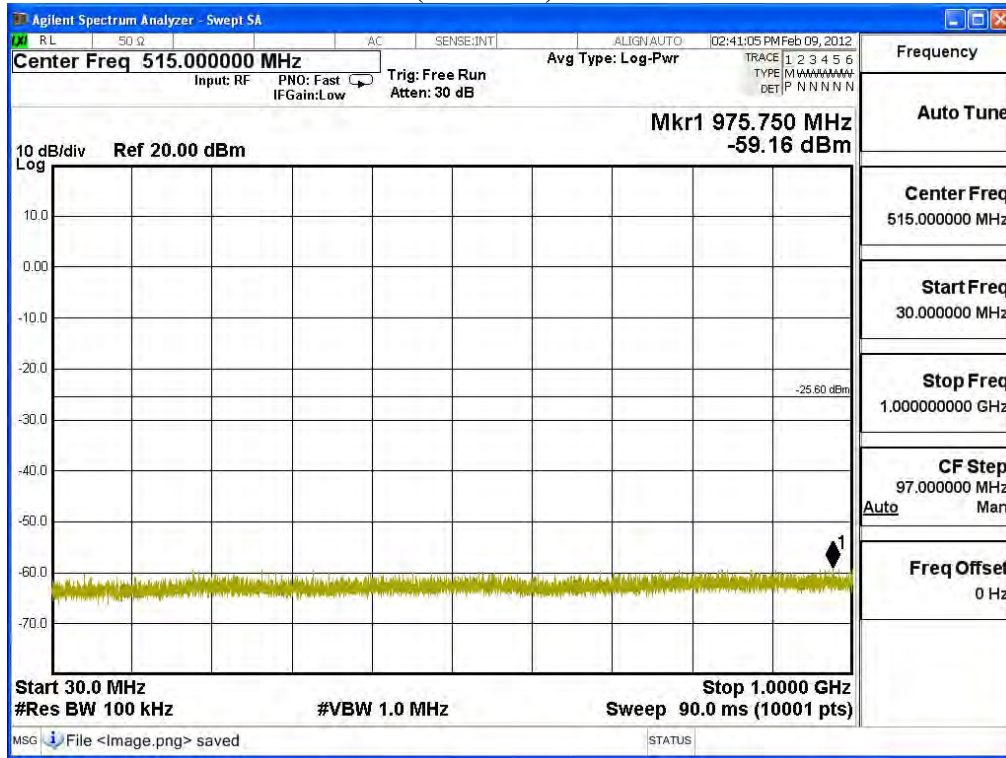

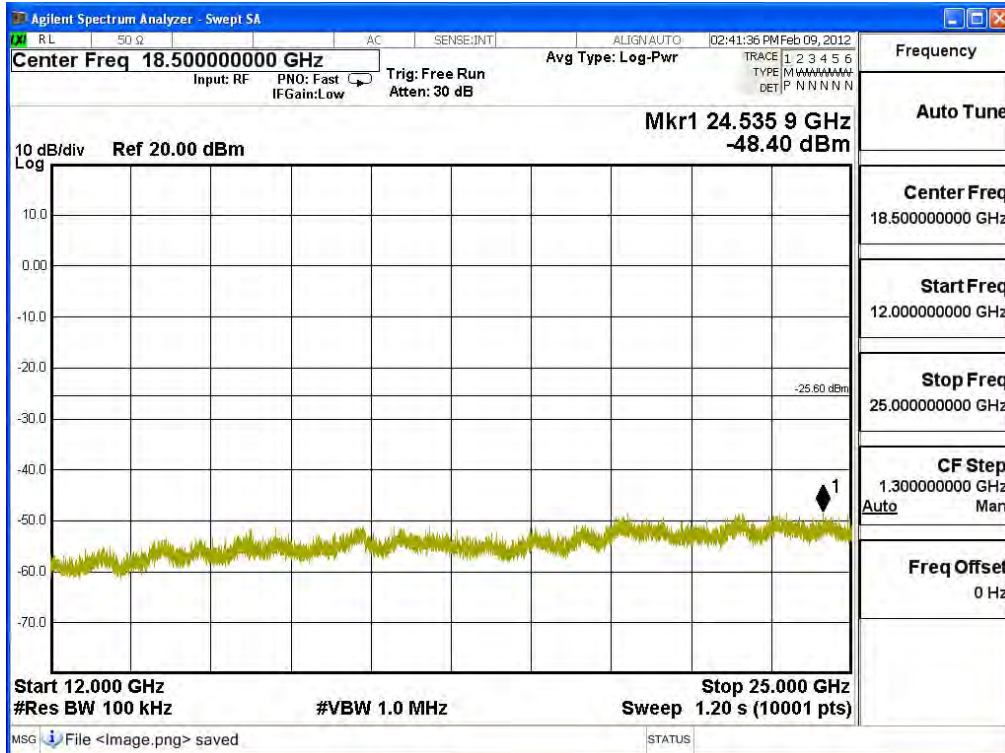
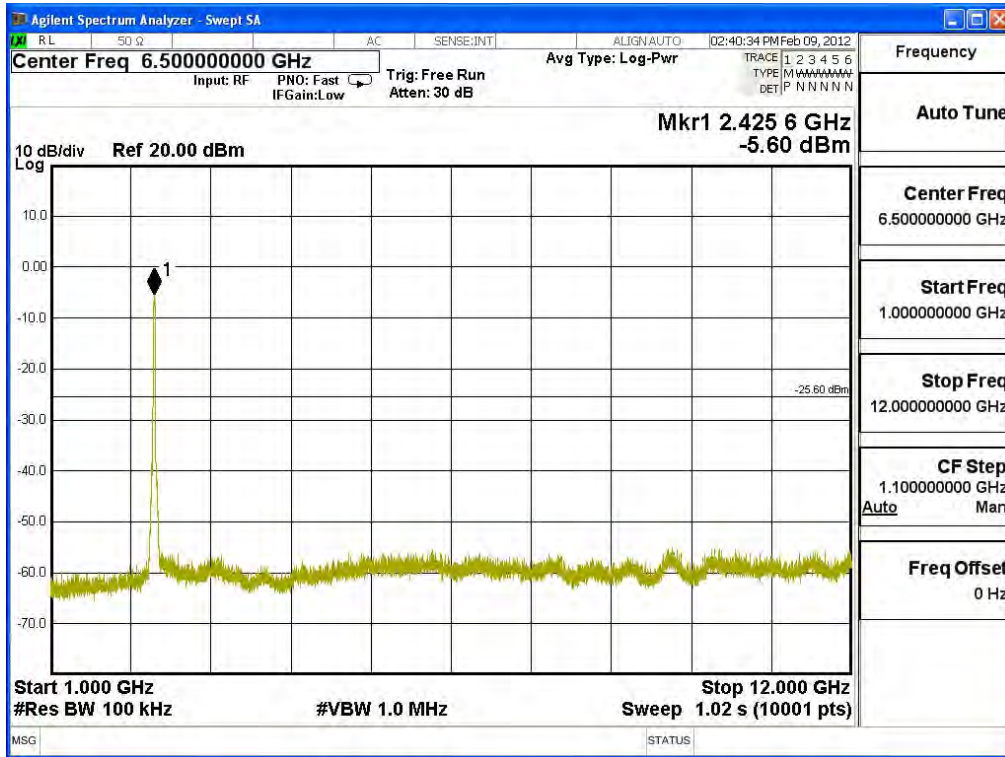

Channel 04 (2437MHz) 30MHz -25GHz

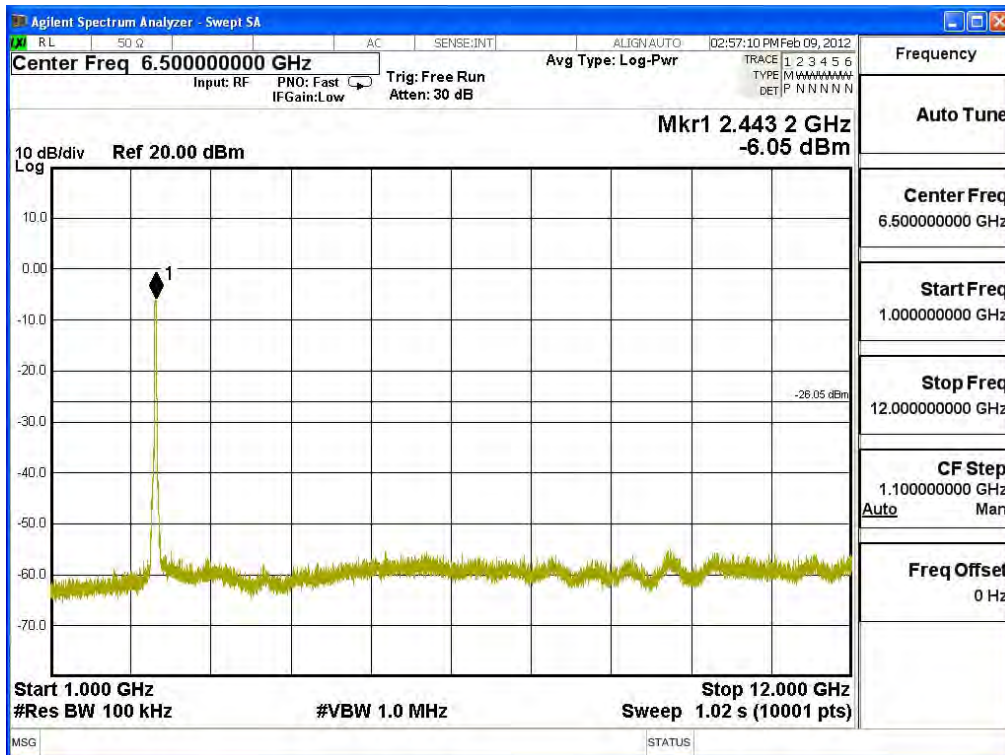
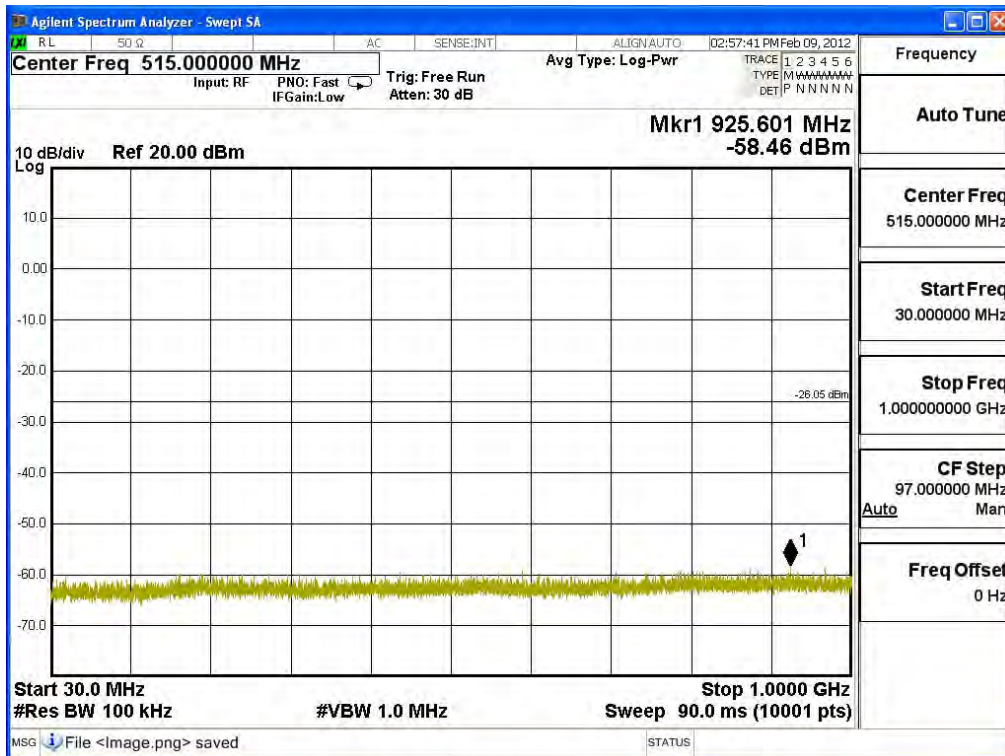

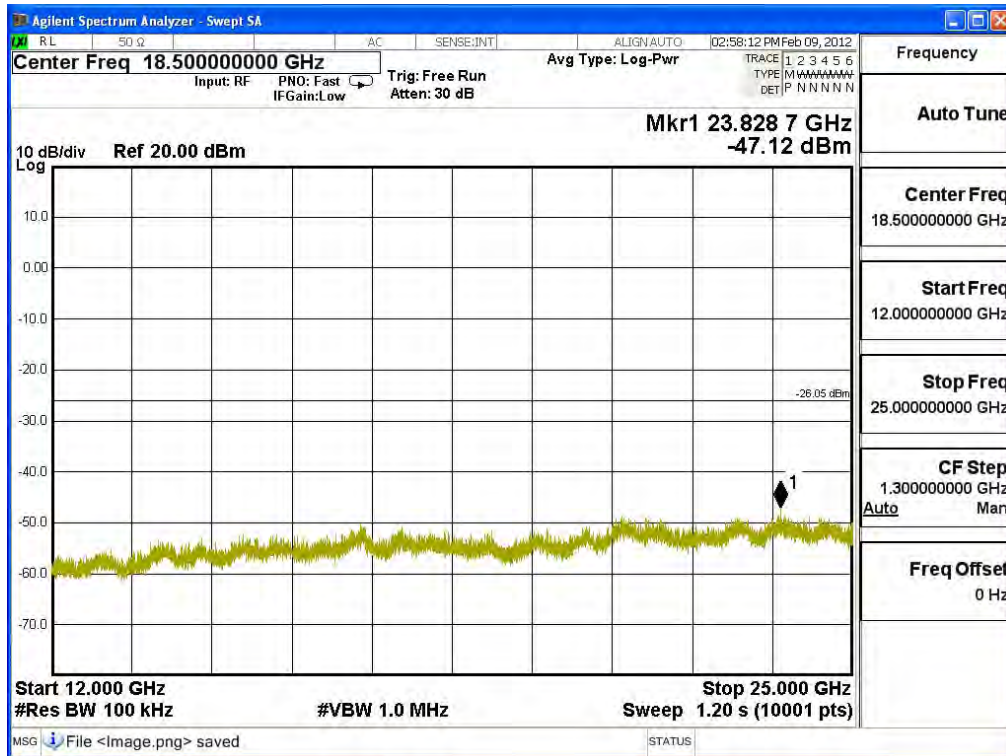

Channel 07 (2452MHz) 30MHz -25GHz

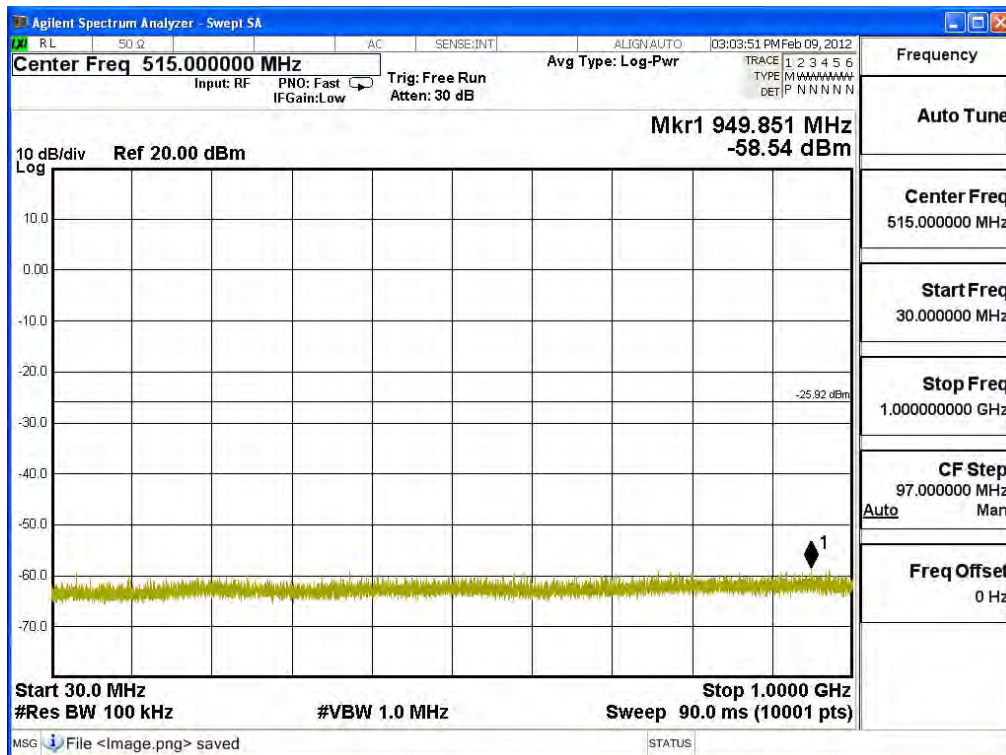

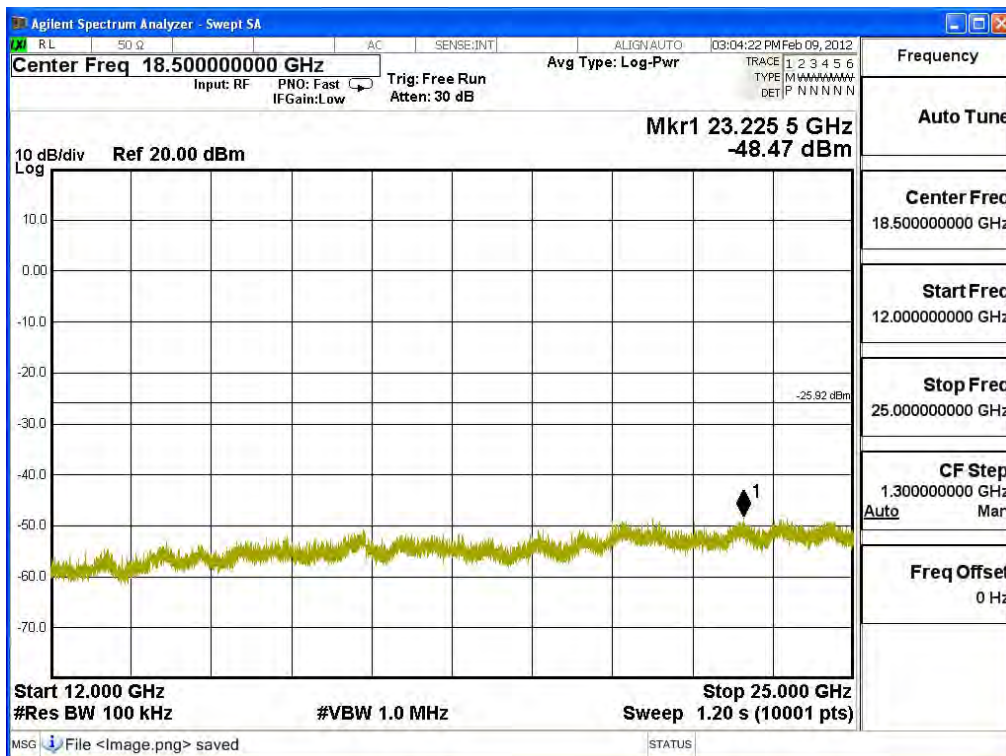
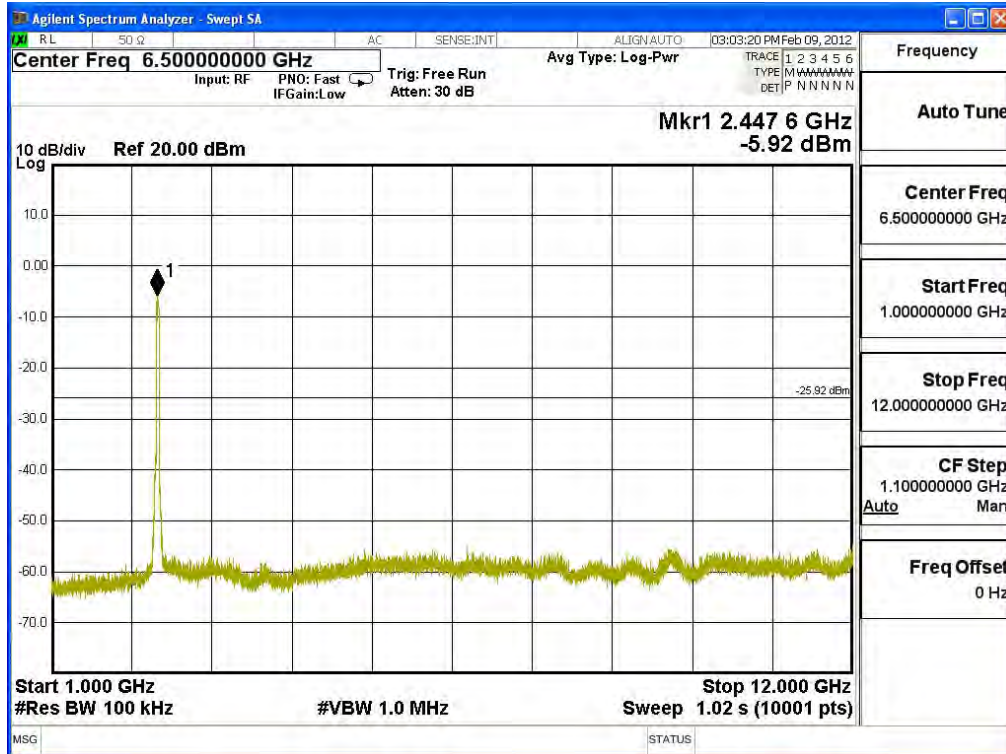

Product : PS1 Speaker
 Test Item : RF antenna conducted test
 Test Site : No.3 OATS
 Test Mode : Mode 1: Transmit (802.11b 1Mbps) main chip_166

Channel 01 (2412MHz) 30MHz-25GHz

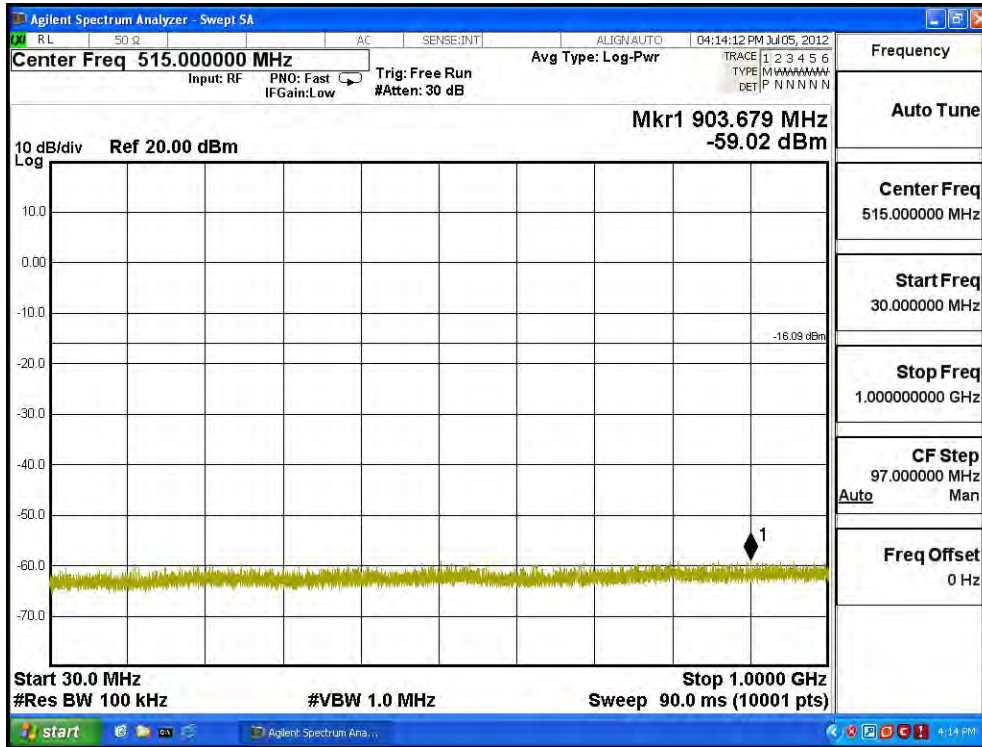

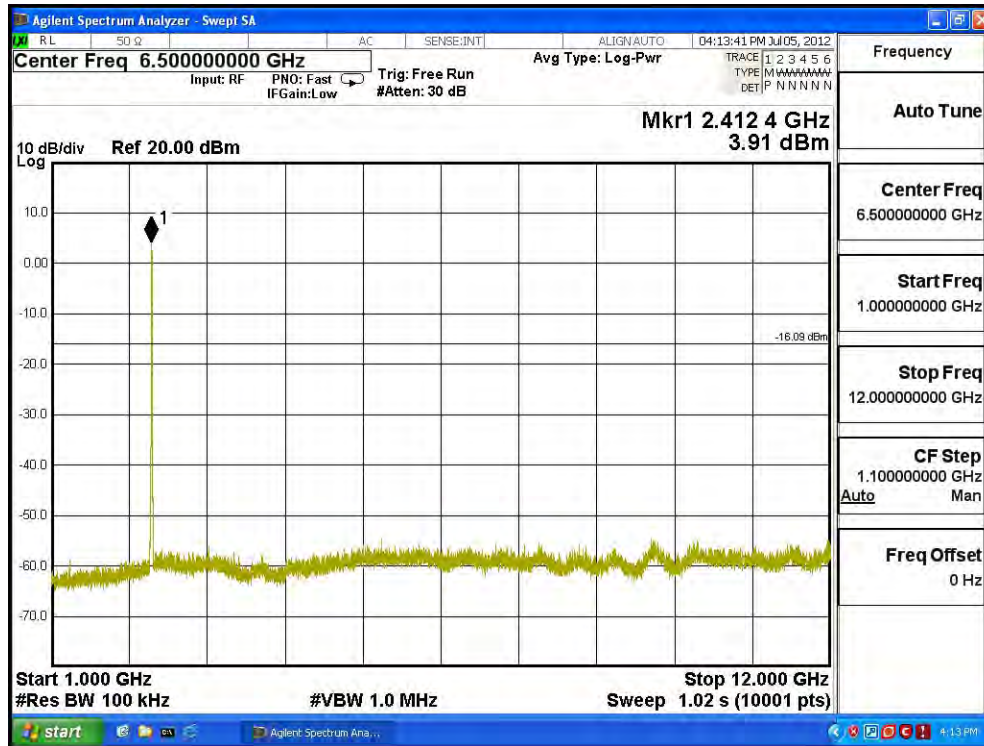

Channel 06 (2437MHz) 30MHz -25GHz

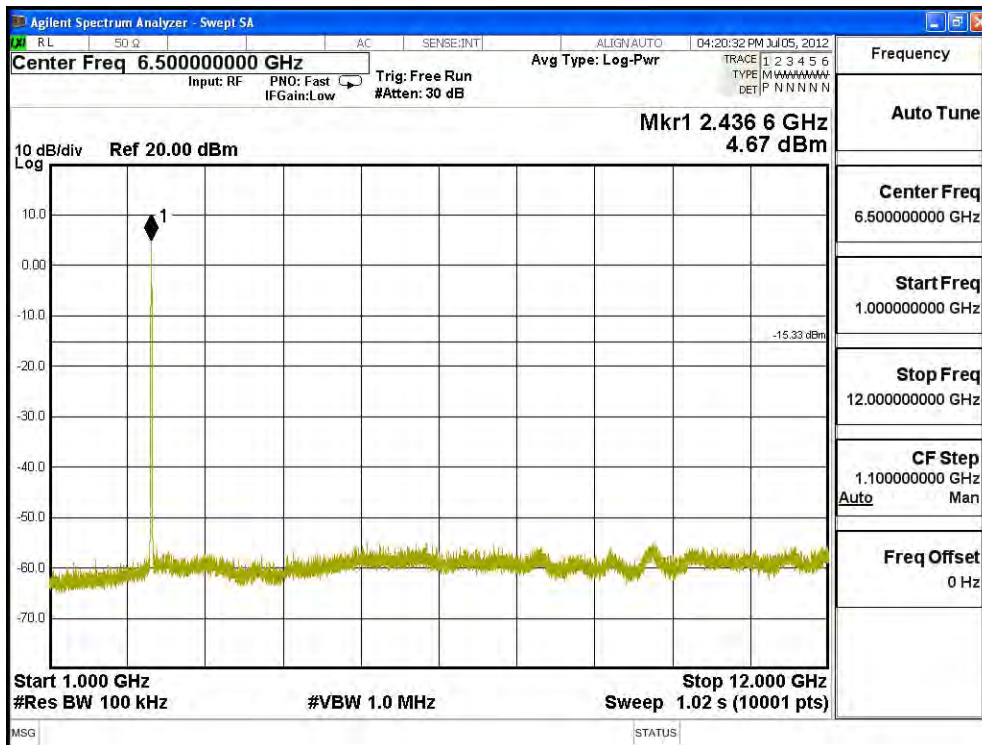
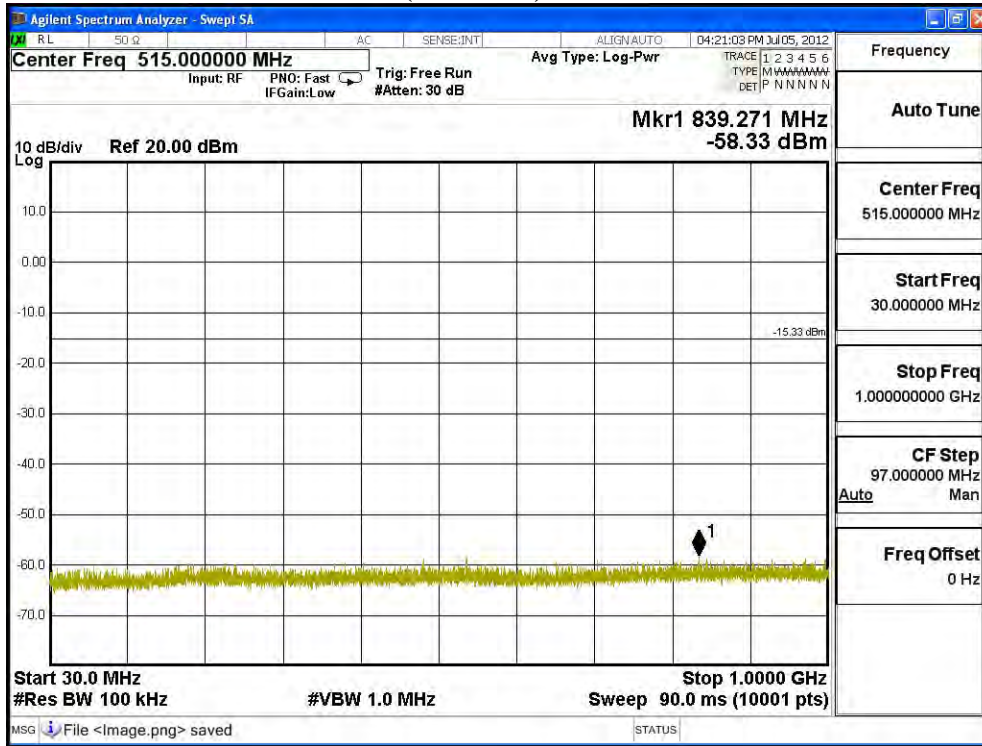

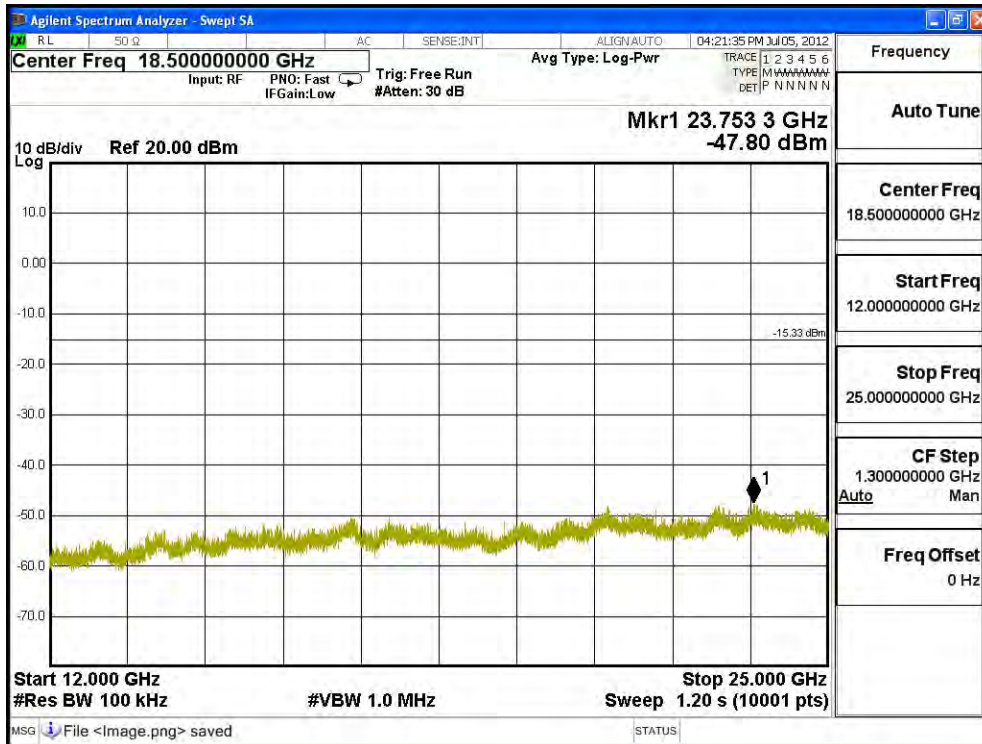

Channel 11 (2462MHz) 30MHz -25GHz

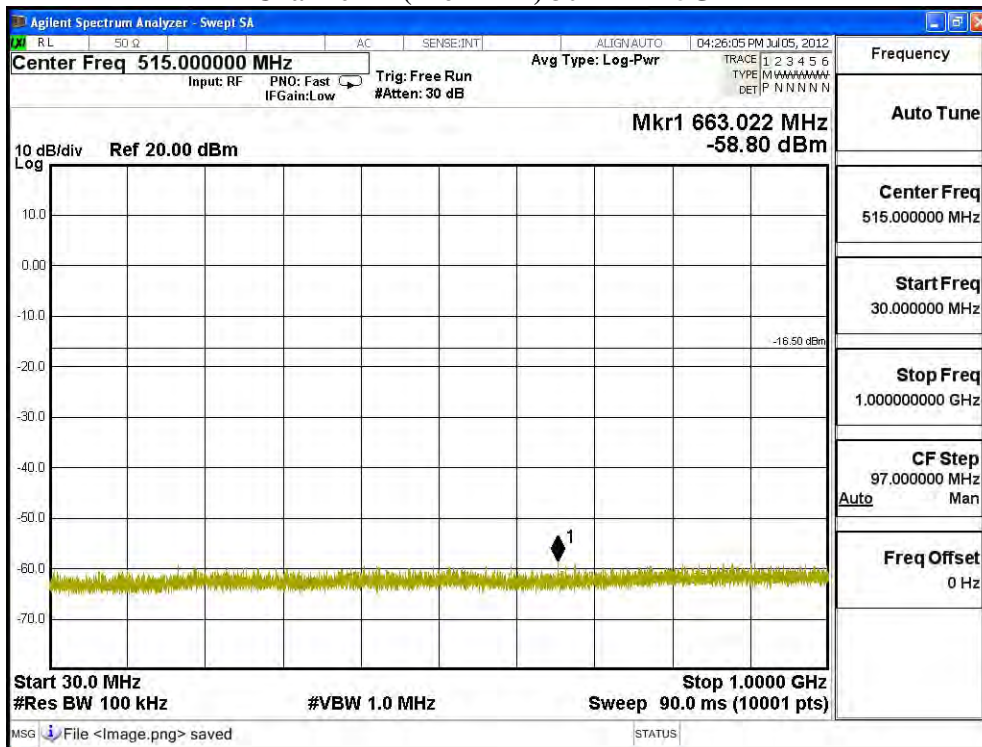

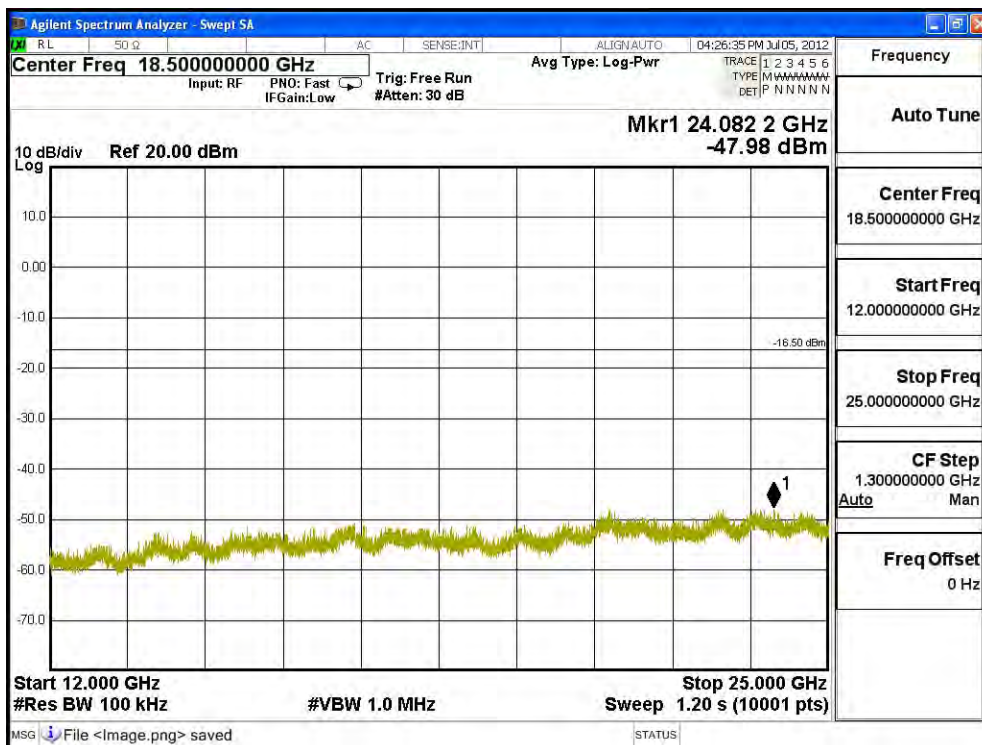
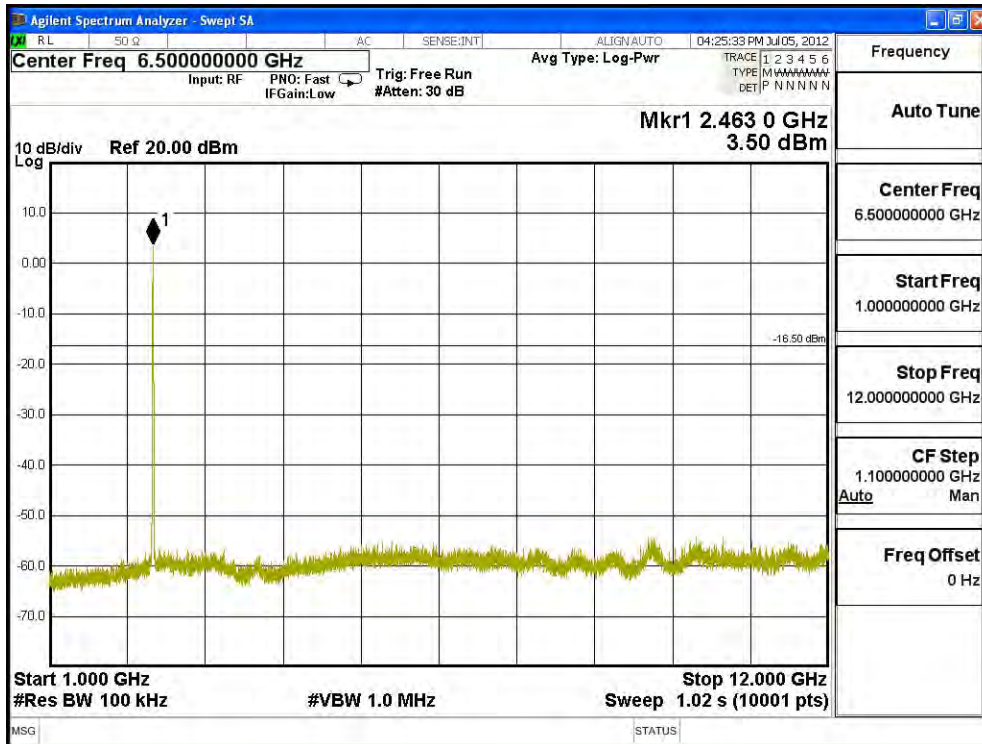

Product : PS1 Speaker
 Test Item : RF Antenna Conducted Spurious
 Test Site : No.3 OATS
 Test Mode : Mode 2: Transmit (802.11g 6Mbps) main chip_166

Channel 01 (2412MHz) 30MHz -25GHz

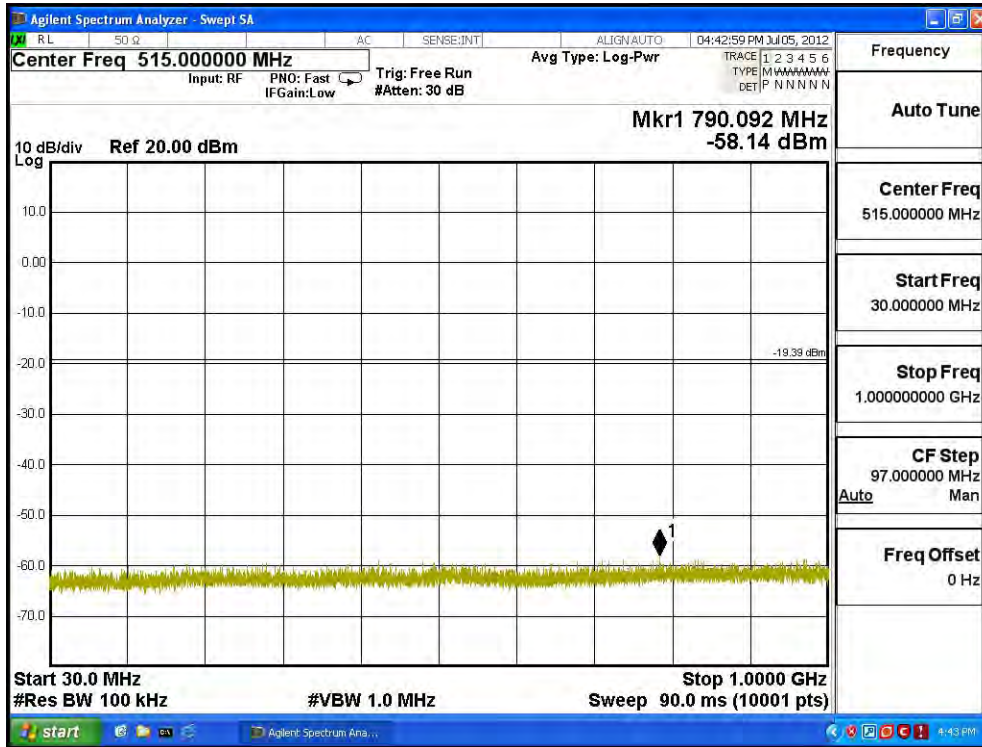

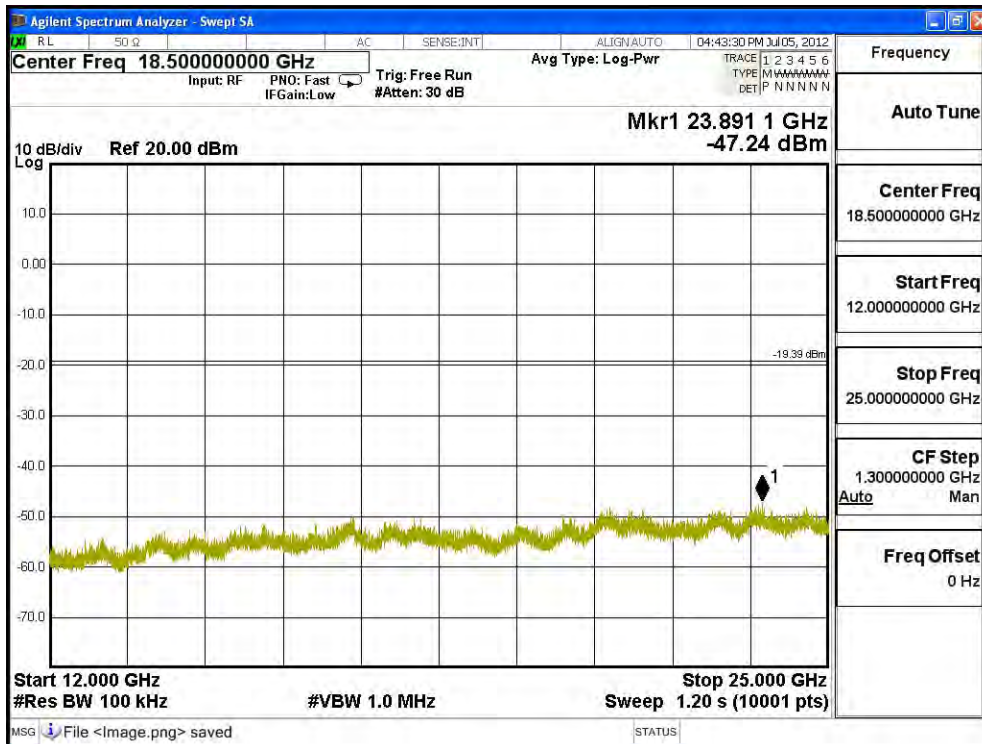
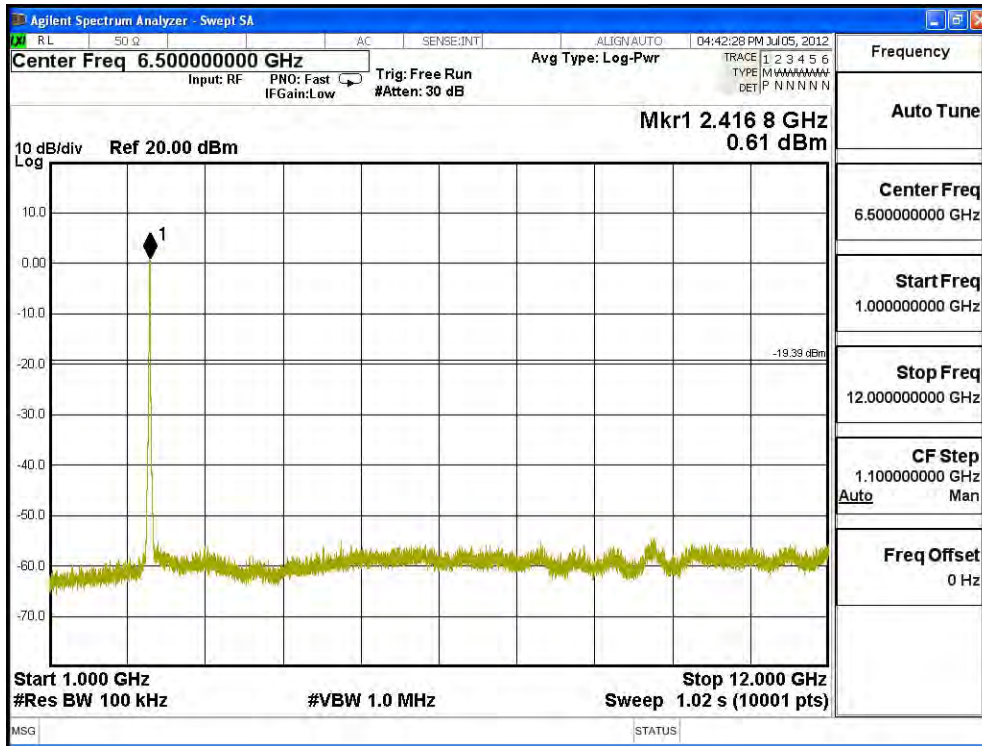

Channel 06 (2437MHz) 30MHz -25GHz

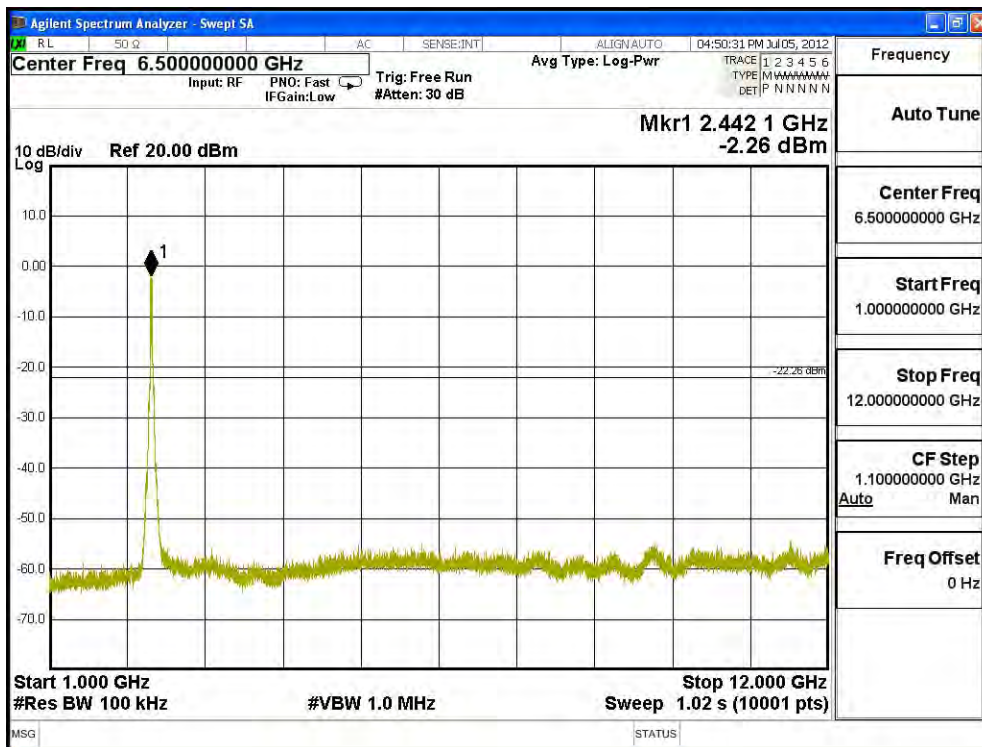
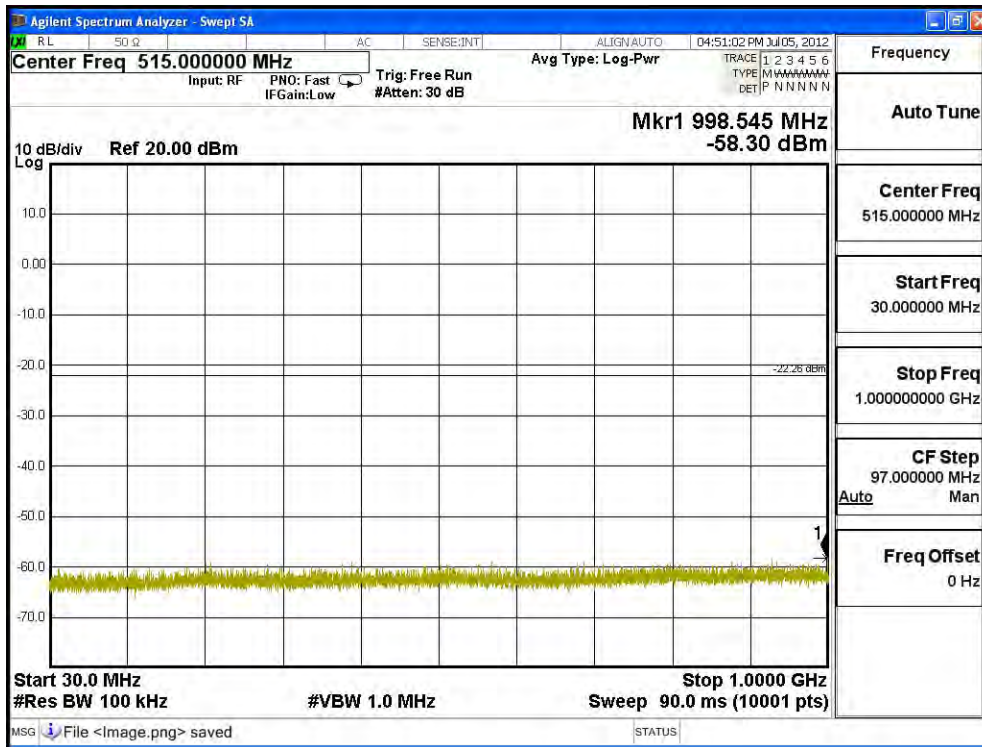

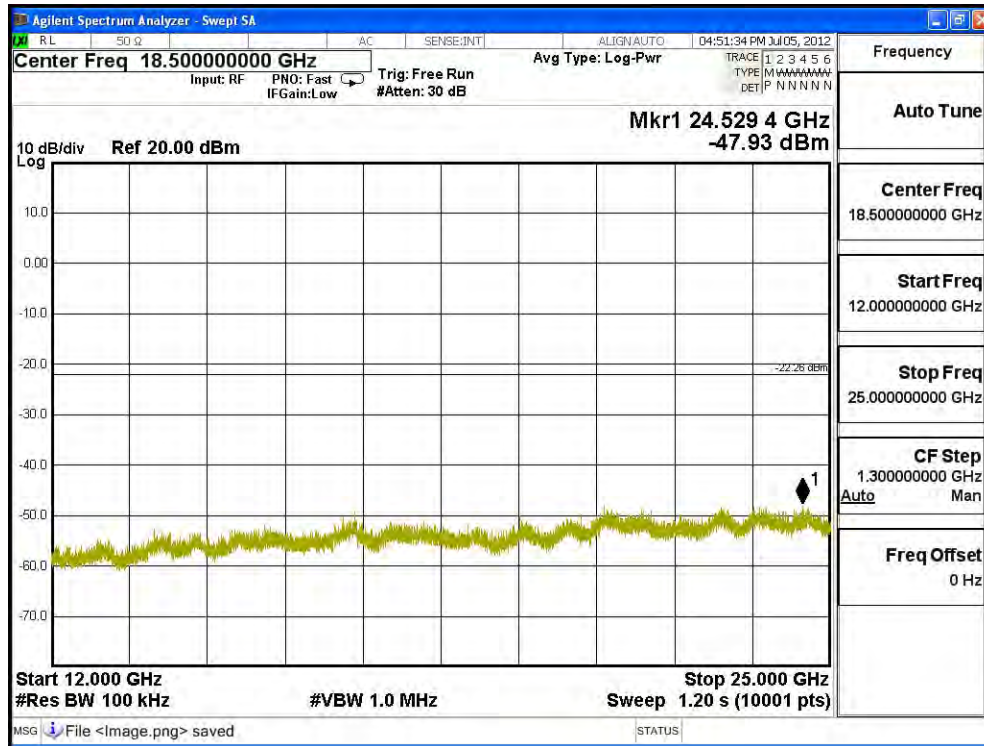

Channel 11 (2462MHz) 30MHz -25GHz

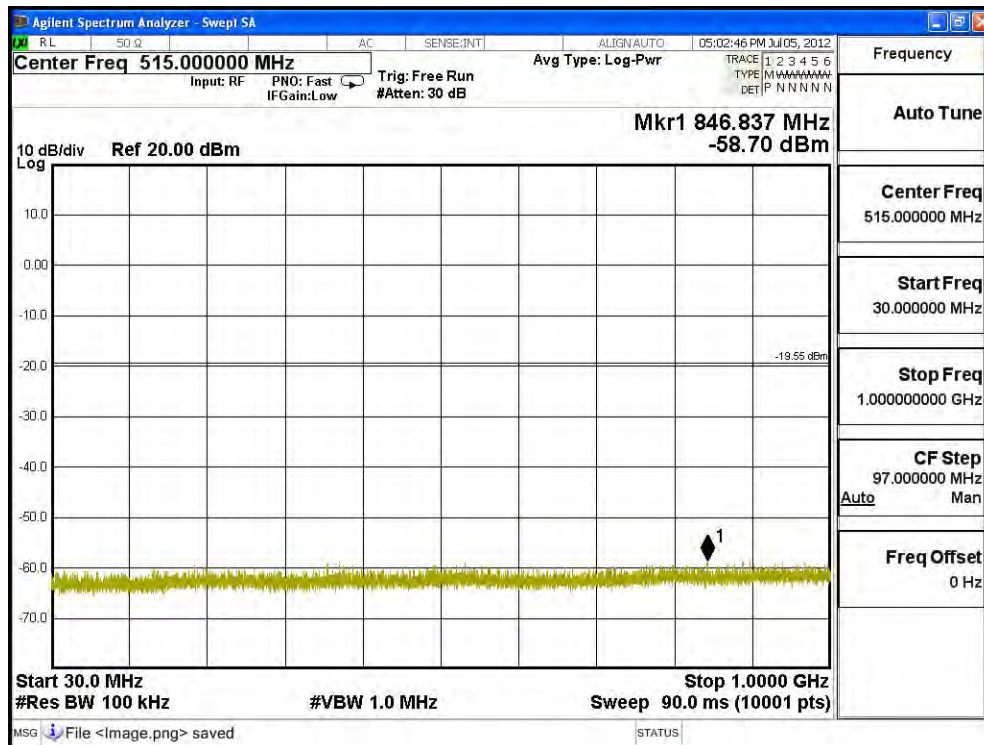

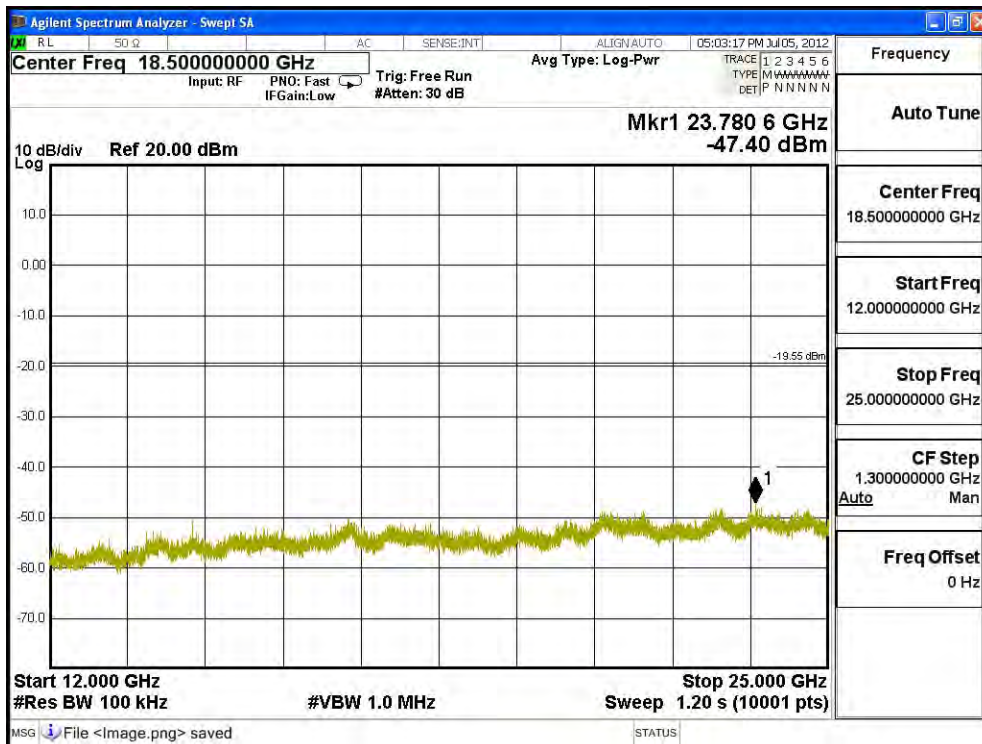
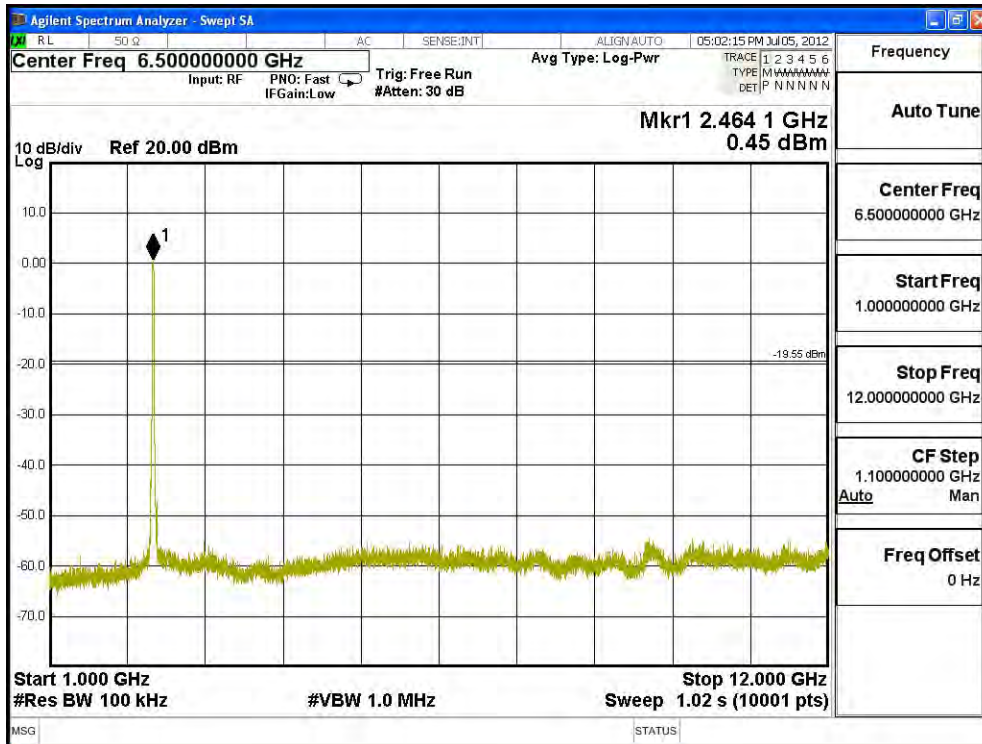

Product : PS1 Speaker
 Test Item : RF Antenna Conducted Spurious
 Test Site : No.3 OATS
 Test Mode : Mode 3: Transmit - 802.11n-20BW_7.2Mbps(2.4G Band) main chip_166

Channel 01 (2412MHz) 30MHz -25GHz

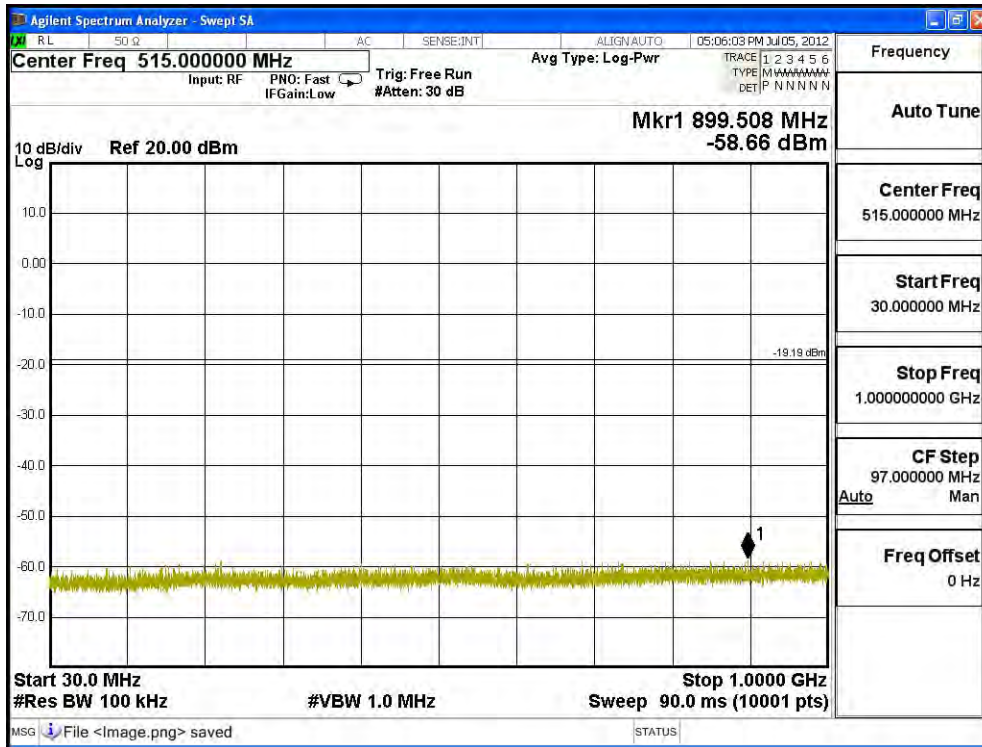

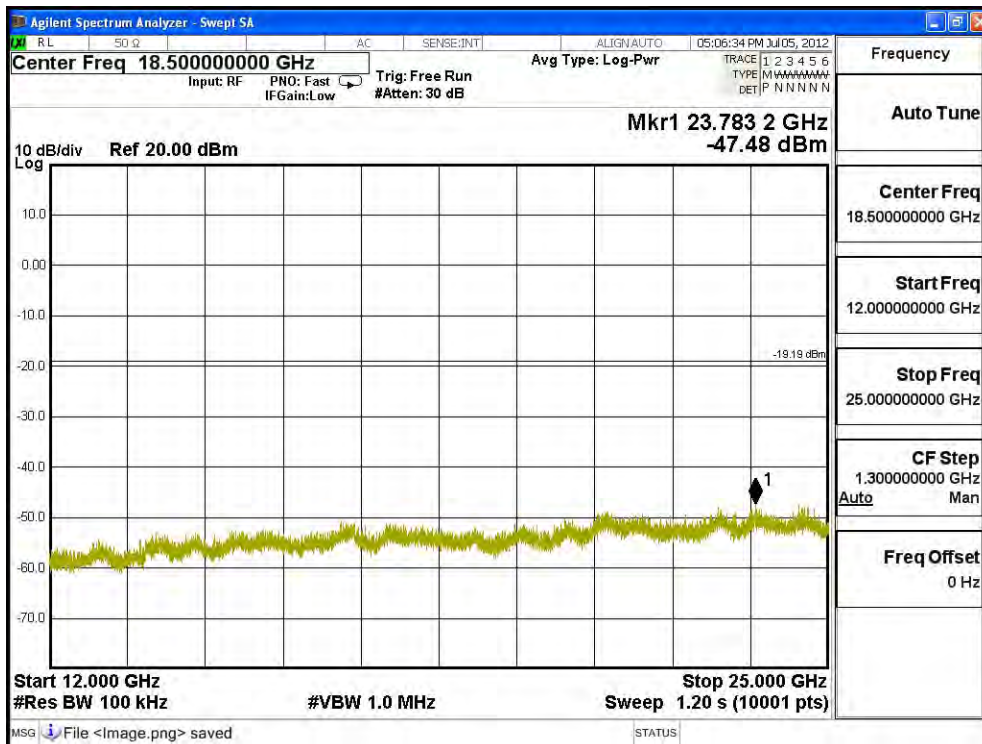
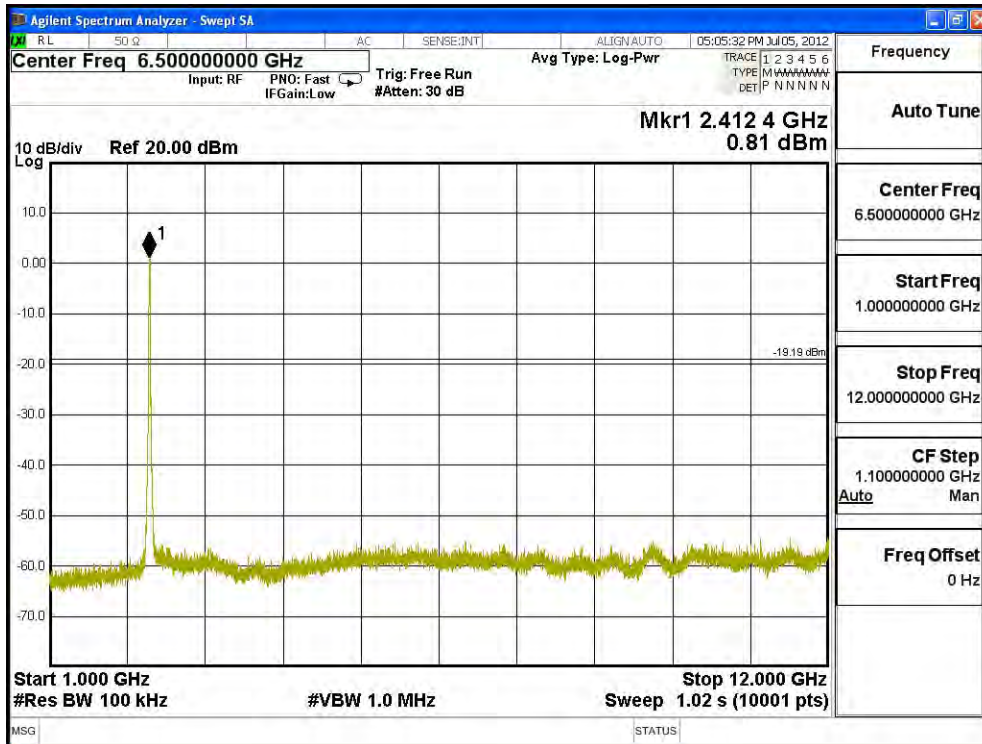

Channel 06 (2437MHz) 30MHz -25GHz

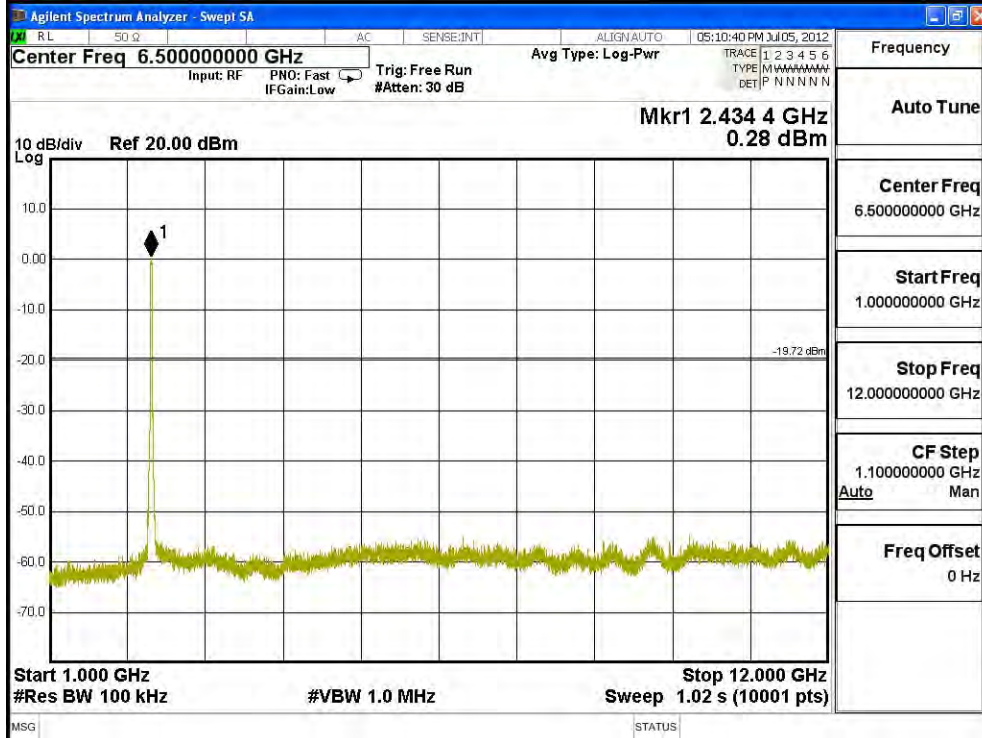
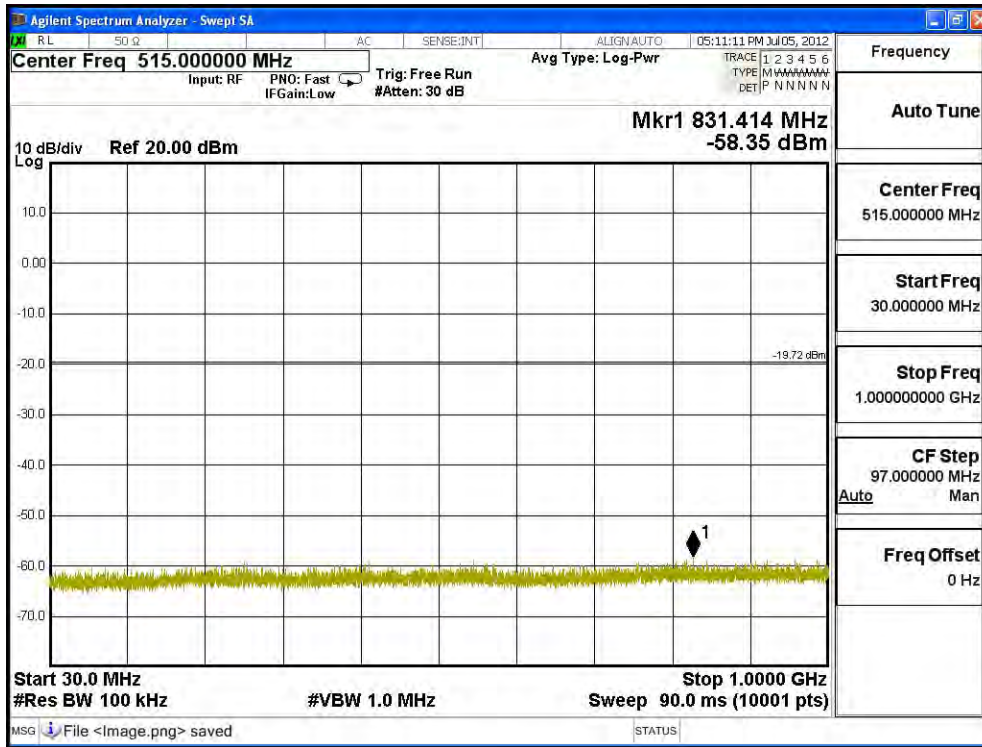

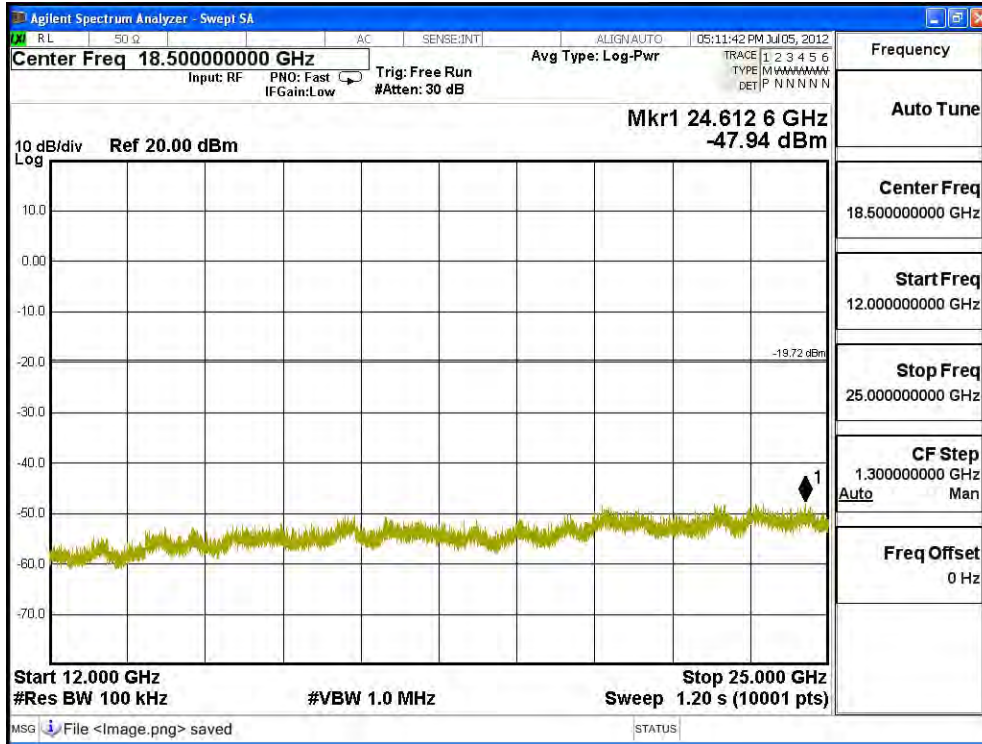

Channel 11 (2462MHz) 30MHz -25GHz

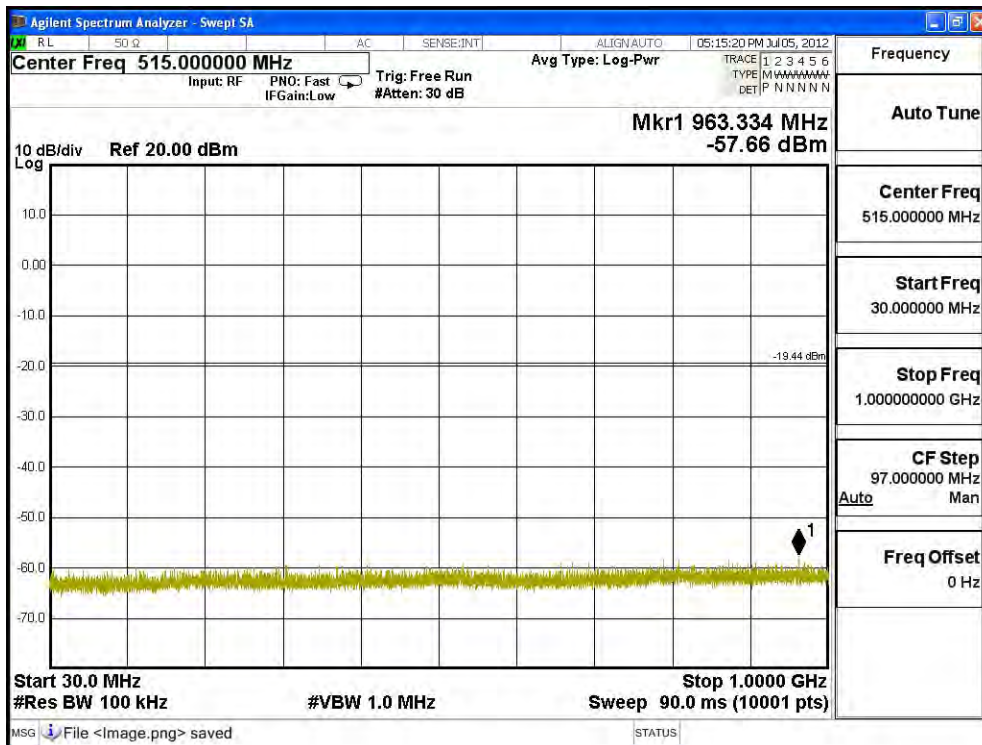

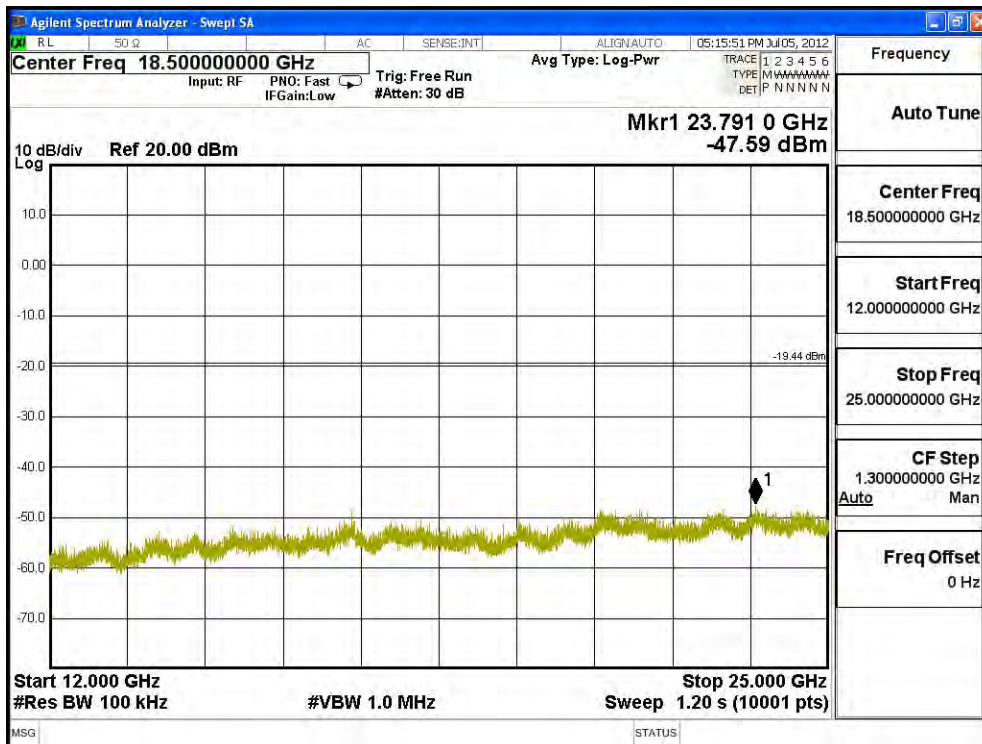
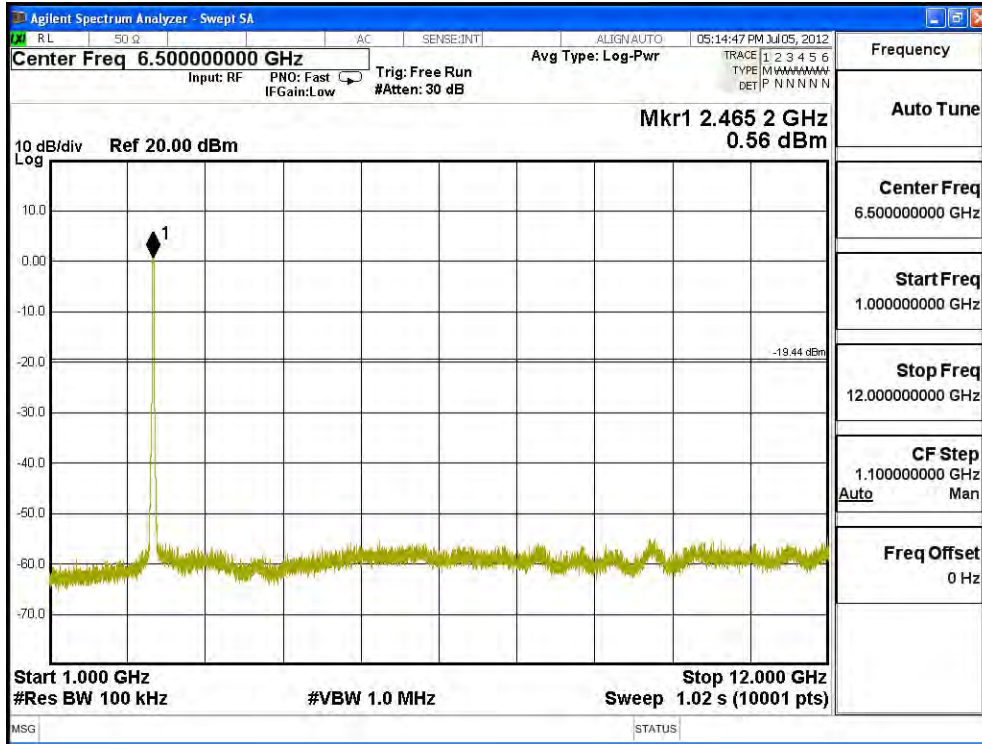

Product : PS1 Speaker
 Test Item : RF Antenna Conducted Spurious
 Test Site : No.3 OATS
 Test Mode : Mode 4: Transmit - 802.11n-40BW_15Mbps(2.4G Band) main chip_166

Channel 01 (2422MHz) 30MHz -25GHz

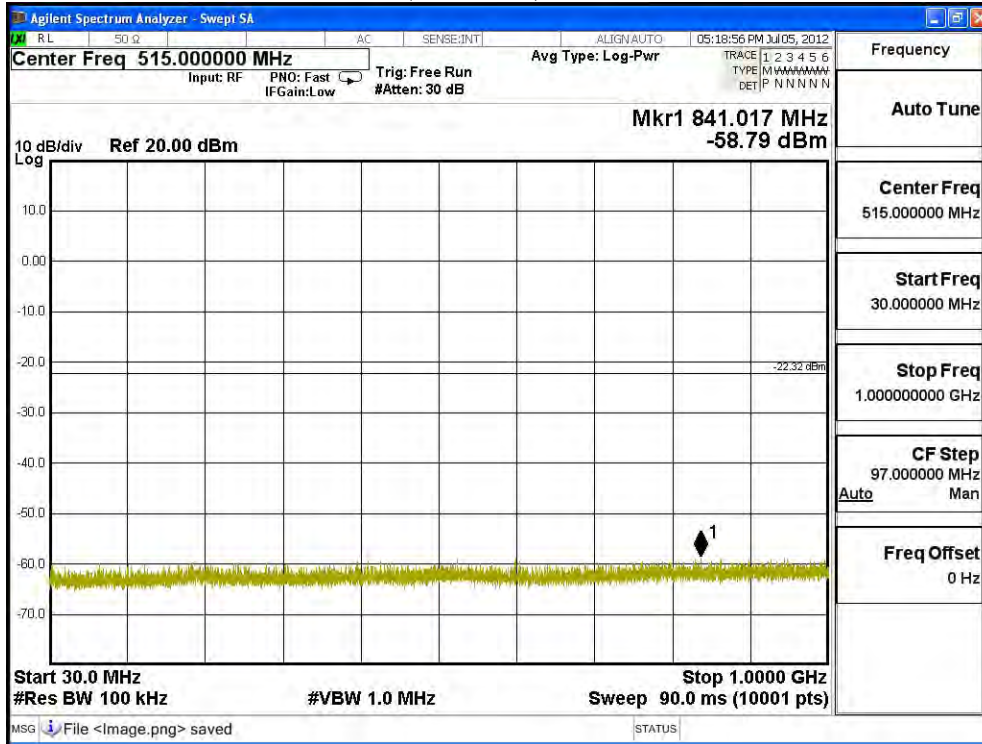

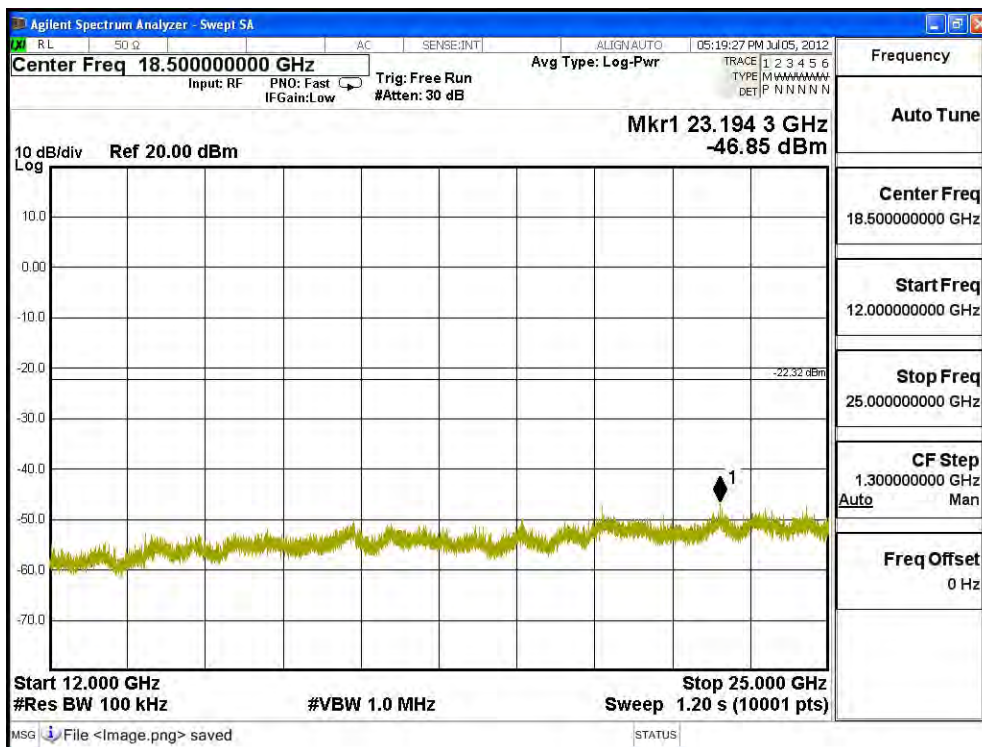
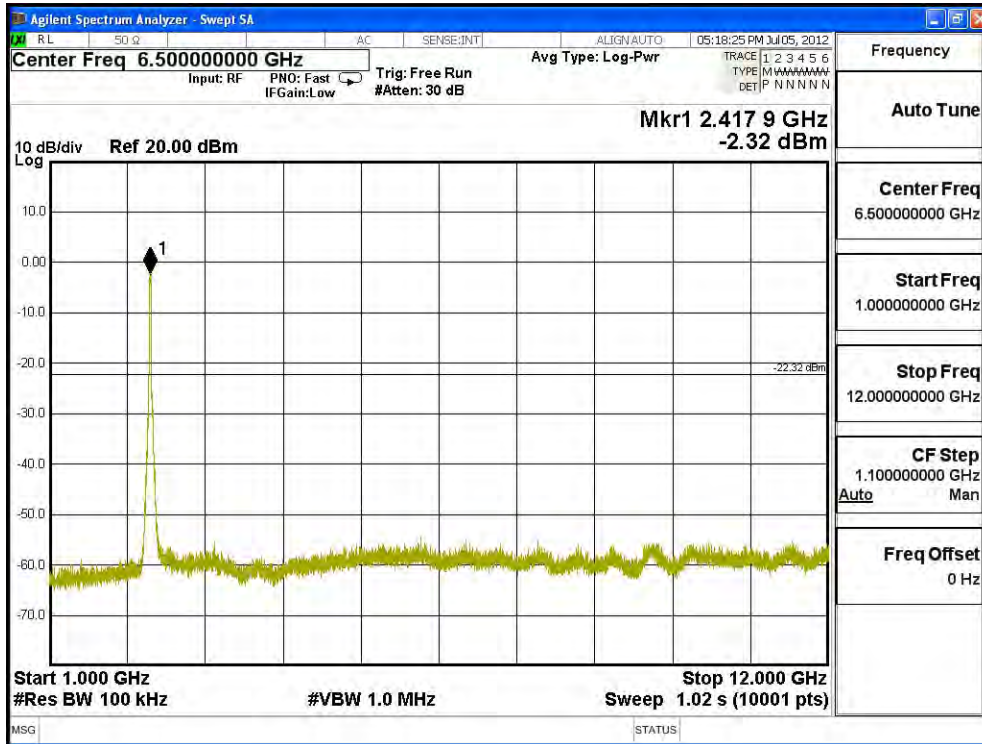

Channel 04 (2437MHz) 30MHz -25GHz

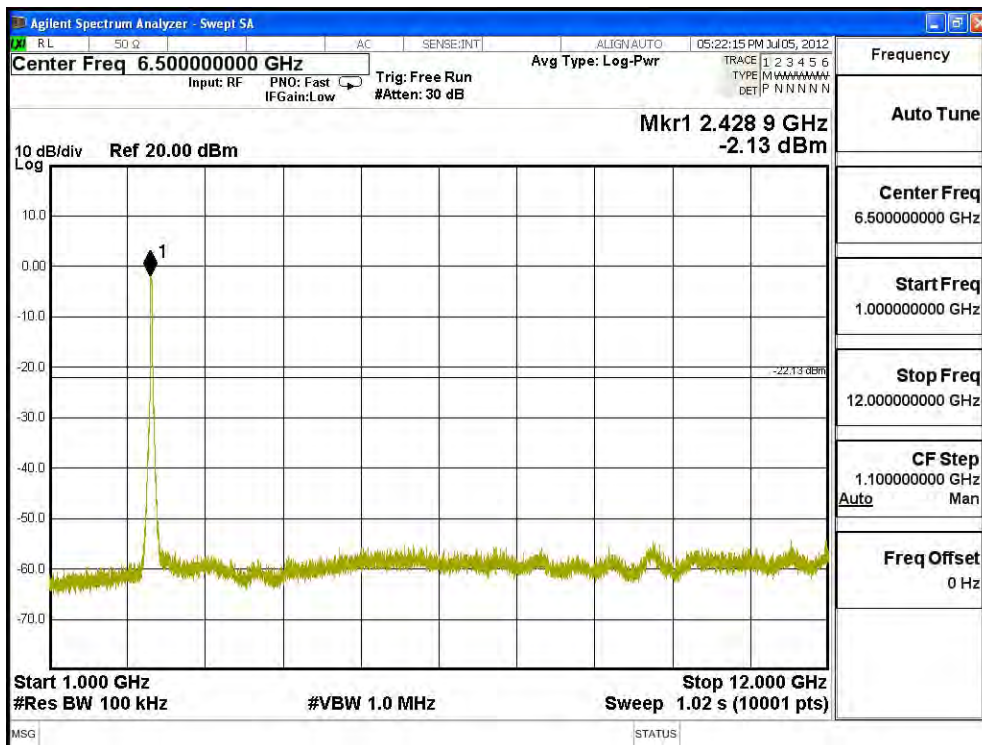
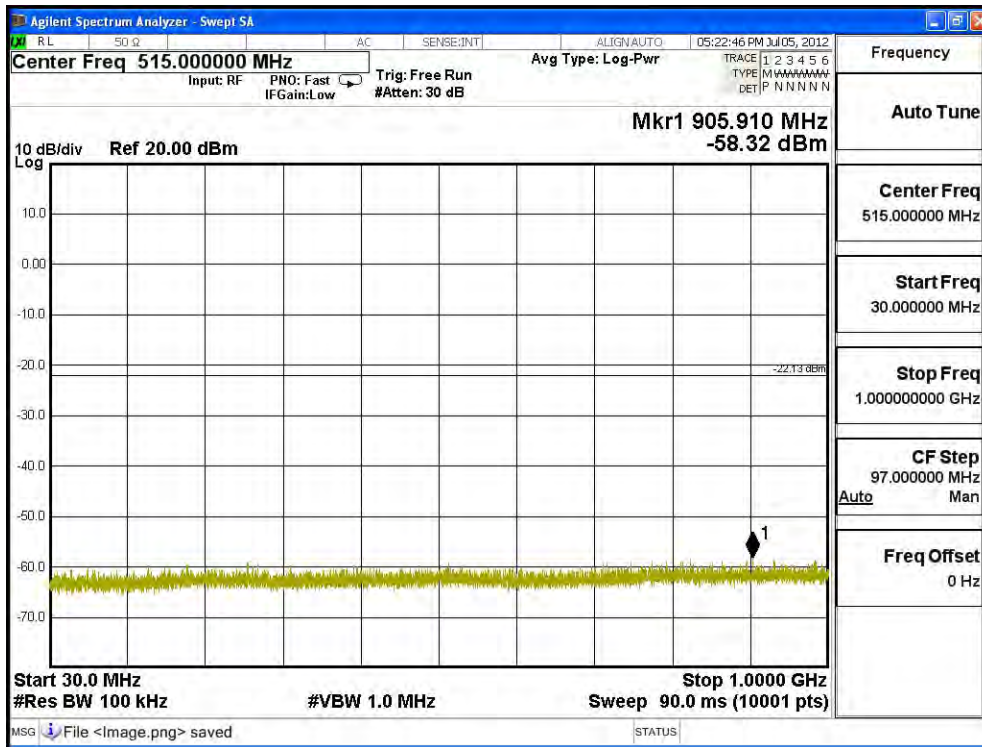

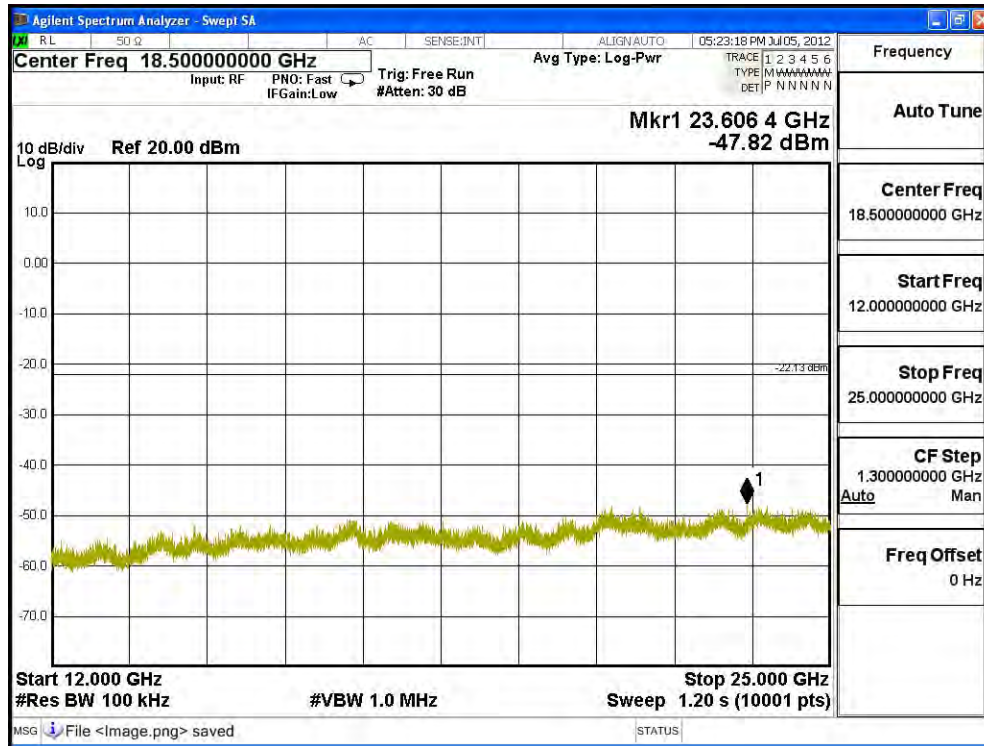

Channel 07 (2452MHz) 30MHz -25GHz

