

**FCC 47 CFR PART 15 SUBPART C &
INDUSTRY CANADA RSS-247**

TEST REPORT

For

ZigBee Module

Model: MZ0100S-0

Trade Name: LITE-ON

Issued to

Lite-On Technology Corp.

Bldg. C, 90, Chien 1 Road, Chung Ho, New Taipei City 23585, Taiwan, R.O.C

Issued by

Compliance Certification Services Inc.

**No.11, Wugong 6th Rd., Wugu Dist.,
New Taipei City 24891, Taiwan. (R.O.C.)**

<http://www.ccsrf.com>

service@ccsrf.com

Issued Date: September 3, 2015



Note: This report shall not be reproduced except in full, without the written approval of Compliance Certification Services Inc. This document may be altered or revised by Compliance Certification Services Inc. personnel only, and shall be noted in the revision section of the document.

Revision History

Rev.	Issue Date	Revisions	Effect Page	Revised By
00	September 3, 2015	Initial Issue	ALL	Becca Chen

TABLE OF CONTENTS

1. TEST RESULT CERTIFICATION.....	4
2. EUT DESCRIPTION.....	5
3. TEST METHODOLOGY.....	6
3.1 EUT CONFIGURATION.....	6
3.2 EUT EXERCISE.....	6
3.3 GENERAL TEST PROCEDURES.....	6
3.4 FCC PART 15.205 RESTRICTED BANDS OF OPERATIONS.....	7
3.5 DESCRIPTION OF TEST MODES.....	8
4 INSTRUMENT CALIBRATION.....	9
4.1 MEASURING INSTRUMENT CALIBRATION.....	9
4.2 MEASUREMENT EQUIPMENT USED.....	9
4.3 MEASUREMENT UNCERTAINTY.....	10
5 FACILITIES AND ACCREDITATIONS.....	11
5.1 FACILITIES.....	11
5.2 EQUIPMENT.....	11
5.3 TABLE OF ACCREDITATIONS AND LISTINGS.....	12
6 SETUP OF EQUIPMENT UNDER TEST.....	13
6.1 SETUP CONFIGURATION OF EUT.....	13
6.2 SUPPORT EQUIPMENT.....	13
7 FCC PART 15.247 REQUIREMENTS& RSS-247 REQUIREMENTS.....	14
7.1 99% BANDWIDTH.....	14
7.2 6DB BANDWIDTH.....	17
7.3 PEAK POWER.....	20
7.4 AVERAGE POWER.....	21
7.5 BAND EDGES MEASUREMENT.....	22
7.6 PEAK POWER SPECTRAL DENSITY.....	30
7.7 SPURIOUS EMISSIONS.....	33
7.8 RADIATED EMISSIONS.....	36
7.9 POWERLINE CONDUCTED EMISSIONS.....	51
APPENDIX I PHOTOGRAPHS OF TEST SETUP.....	52
APPENDIX 1 - PHOTOGRAPHS OF EUT	

1. TEST RESULT CERTIFICATION

Applicant: Lite-On Technology Corp.
 Bldg. C, 90, Chien 1 Road, Chung Ho, New Taipei City 23585,
 Taiwan, R.O.C

Manufacturer: Lite-On Network Communication (Dongguan) Limited
 30#Keji Rd., Yin Hu Industrial Area, Qingxi Town, DongGuan
 City, Guangdong, China

Equipment Under Test: ZigBee Module

Trade Name: LITE-ON

Model: MZ0100S-0

Date of Test: August 18, 2015

APPLICABLE STANDARDS	
STANDARD	TEST RESULT
FCC 47 CFR Part 15 Subpart C & Industry Canada RSS-247 Issue 1	No non-compliance noted
Deviation from Applicable Standard	
N/A	

We hereby certify that:

The above equipment was tested by Compliance Certification Services Inc. The test data, data evaluation, test procedures, and equipment configurations shown in this report were made in accordance with the procedures given in ANSI C63.10: 2013 and the energy emitted by the sample EUT tested as described in this report is in compliance with the requirements emission limits of FCC Rules Part 15.107, 15.109, 15.207, 15.209 and 15.249 and Industry Canada RSS-247.

The test results of this report relate only to the tested sample identified in this report.

Approved by:

Reviewed by:



Miller Lee
 Manager
 Compliance Certification Services Inc.

Angel Cheng
 Section Manager
 Compliance Certification Services Inc.

2. EUT DESCRIPTION

Product	ZigBee Module
Trade Name	LITE-ON
Model Number	MZ0100S-0
Model Discrepancy	N/A
Received Date	August 11, 2015
EUT Power Rating	Powered from host device
Frequency Range	Zigbee: 2405~2475MHz
Transmit Power	8.43 dBm
Modulation Technique	Zigbee: OPQSK (Offset Quadrature Phase Shift Keyed)
Number of Channels	14 Channels
Antenna Specification	Zigbee: Gain: 4.59 dBi
Antenna Designation	Zigbee: PCB Antenna

Remark:

1. *The sample selected for test was production product and was provided by manufacturer.*
2. *This submittal(s) (test report) is intended for **FCC ID: PPQ-MZ0100S-0** & **IC: 4491A-MZ0100S-0** filing to comply with Section 15.207, 15.209 and 15.247 of the FCC Part 15, Subpart C Rules.*

3. TEST METHODOLOGY

The tests documented in this report were performed in accordance with ANSI C63.10: 2013 and FCC CFR 47 Part 15.207, 15.209, 15.247.

The tests documented in this report were performed in accordance with IC RSS-247, IC RSS-Gen and ANSI C63.10:2013.

This submittal(s) (test report) is intended for IC Certification with Industry Canada RSS-247.

3.1 EUT CONFIGURATION

The EUT configuration for testing is installed on RF field strength measurement to meet the Commissions requirement and operating in a manner that intends to maximize its emission characteristics in a continuous normal application.

3.2 EUT EXERCISE

The EUT was operated in the engineering mode to fix the TX frequency that was for the purpose of the measurements.

According to its specifications, the EUT must comply with the requirements of the Section 15.207, 15.209 and 15.247 under the FCC Rules Part 15 Subpart C.

The tests documented in this report were performed in accordance with IC RSS-247, IC RSS-Gen, IC RSS-102, and ANSI C63.10: 2013.

3.3 GENERAL TEST PROCEDURES

Conducted Emissions

The EUT is placed on the turntable, which is 0.8 m above ground plane. According to the requirements in ANSI C63.10: 2013. Conducted emissions from the EUT measured in the frequency range between 0.15 MHz and 30MHz using CISPR Quasi-peak and average detector modes.

Radiated Emissions

The EUT is placed on a turn table, which is 1.5 m above ground plane. The turntable shall rotate 360 degrees to determine the position of maximum emission level. EUT is set 3m away from the receiving antenna, which varied from 1m to 4m to find out the highest emission. And also, each emission was to be maximized by changing the polarization of receiving antenna both horizontal and vertical. In order to find out the maximum emissions, exploratory radiated emission measurements were made according to the requirements in ANSI C63.10: 2013.

3.4 FCC PART 15.205 RESTRICTED BANDS OF OPERATIONS

(a) Except as shown in paragraph (d) of this section, only spurious emissions are permitted in any of the frequency bands listed below:

MHz	MHz	MHz	GHz
0.090 - 0.110	16.42 - 16.423	399.9 - 410	4.5 - 5.15
¹ 0.495 - 0.505	16.69475 - 16.69525	608 - 614	5.35 - 5.46
2.1735 - 2.1905	16.80425 - 16.80475	960 - 1240	7.25 - 7.75
4.125 - 4.128	25.5 - 25.67	1300 - 1427	8.025 - 8.5
4.17725 - 4.17775	37.5 - 38.25	1435 - 1626.5	9.0 - 9.2
4.20725 - 4.20775	73 - 74.6	1645.5 - 1646.5	9.3 - 9.5
6.215 - 6.218	74.8 - 75.2	1660 - 1710	10.6 - 12.7
6.26775 - 6.26825	108 - 121.94	1718.8 - 1722.2	13.25 - 13.4
6.31175 - 6.31225	123 - 138	2200 - 2300	14.47 - 14.5
8.291 - 8.294	149.9 - 150.05	2310 - 2390	15.35 - 16.2
8.362 - 8.366	156.52475 -	2483.5 - 2500	17.7 - 21.4
8.37625 - 8.38675	156.52525	2655 - 2900	22.01 - 23.12
8.41425 - 8.41475	156.7 - 156.9	3260 - 3267	23.6 - 24.0
12.29 - 12.293	162.0125 - 167.17	3332 - 3339	31.2 - 31.8
12.51975 - 12.52025	167.72 - 173.2	3345.8 - 3358	36.43 - 36.5
12.57675 - 12.57725	240 - 285	3600 - 4400	(²)
13.36 - 13.41	322 - 335.4		

¹ Until February 1, 1999, this restricted band shall be 0.490-0.510 MHz.

² Above 38.6

(b) Except as provided in paragraphs (d) and (e), the field strength of emissions appearing within these frequency bands shall not exceed the limits shown in Section 15.209. At frequencies equal to or less than 1000 MHz, compliance with the limits in Section 15.209 shall be demonstrated using measurement instrumentation employing a CISPR quasi-peak detector. Above 1000 MHz, compliance with the emission limits in Section 15.209 shall be demonstrated based on the average value of the measured emissions. The provisions in Section 15.35 apply to these measurements.

3.5 DESCRIPTION OF TEST MODES

The EUT (model: MZ0100S-0) had been tested under operating condition.

Software used to control the EUT for staying in continuous transmitting mode was programmed.

After verification, all tests were carried out with the worst case test modes as shown below except radiated spurious emission below 1GHz and power line conducted emissions below 30MHz, which worst case was in normal link mode only.

Zigbee:

Channel Low and Channel High were chosen for full testing.

4 INSTRUMENT CALIBRATION

4.1 MEASURING INSTRUMENT CALIBRATION

The measuring equipment, which was utilized in performing the tests documented herein, has been calibrated in accordance with the manufacturer's recommendations for utilizing calibration equipment, which is traceable to recognized national standards.

4.2 MEASUREMENT EQUIPMENT USED

Equipment Used for Emissions Measurement

Remark: Each piece of equipment is scheduled for calibration once a year.

Conducted Emissions Test Site				
Name of Equipment	Manufacturer	Model	Serial Number	Calibration Due
Spectrum Analyzer	Agilent	E4446A	US42510252	11/23/2015
Thermostatic/Humidity Chamber	TAICHY	MHG-150LF	930619	10/07/2015
AC Power Source	EXTECH	6205	1140845	N.C.R
DC Power Supply	ABM	8301HD	D011531	N.C.R
Power Meter	Anritsu	ML2495A	1012009	07/07/2016
Power Sensor	Anritsu	MA2411A	0917072	07/07/2016
Spectrum Analyzer	ROHDE&SCHWARZ	FSV40	101073	07/19/2016

Wugu 966 Chamber A				
Name of Equipment	Manufacturer	Model	Serial Number	Calibration Due
Spectrum Analyzer	Agilent	E4446A	US42510268	01/25/2016
EMI Test Receiver	R&S	ESCI	100064	06/03/2016
Bilog Antenna	Sunol Sciences	JB3	A030105	08/05/2016
Horn Antenna	EMCO	3117	00055165	01/26/2016
Horn Antenna	EMCO	3116	26370	12/25/2015
Turn Table	CCS	CC-T-1F	N/A	N.C.R
Antenna Tower	CCS	CC-A-1F	N/A	N.C.R
Controller	CCS	CC-C-1F	N/A	N.C.R
Pre-Amplifier	MITEQ	1652-3000	1490939	08/09/2016
Pre-Amplifier	EMC	EMC 012635	980151	06/04/2016
Pre-Amplifier	MITEQ	AMF-6F-260400-40-8P	985646	12/25/2015
Coaxial Cable	Huber+Suhner	102	29212/2	12/25/2015
Coaxial Cable	Huber+Suhner	102	29406/2	12/25/2015
Test S/W	EZ-EMC (CCS-3A1RE)			

4.3 MEASUREMENT UNCERTAINTY

PARAMETER	UNCERTAINTY
Powerline Conducted Emission	N/A
3M Semi Anechoic Chamber / <200M	+/- 4.0138
3M Semi Anechoic Chamber / 200M~1000M	+/- 3.9483
3M Semi Anechoic Chamber / 1G~8G	+/- 2.5975
3M Semi Anechoic Chamber / 8G~18G	+/- 2.6112
3M Semi Anechoic Chamber / 18G~26G	+/- 2.7389
3M Semi Anechoic Chamber / 26G~40G	+/- 2.9683

Remark: This uncertainty represents an expanded uncertainty expressed at approximately the 95% confidence level using a coverage factor of $k=2$.

5 FACILITIES AND ACCREDITATIONS

5.1 FACILITIES

All measurement facilities used to collect the measurement data are located at

- No.199, Chunghsen Road, Hsintien City, Taipei Hsien, Taiwan, R.O.C.
Tel: 886-2-2217-0894 / Fax: 886-2-2217-1029
- No.11, Wugong 6th Rd., Wugu Dist., New Taipei City 24891, Taiwan. (R.O.C.)
Tel: 886-2-2299-9720 / Fax: 886-2-2298-4045
- No.81-1, Lane 210, Bade 2nd Rd., Lujhu Township, Taoyuan County 33841, TAIWAN,
R.O.C.
Tel: 886-3-324-0332 / Fax: 886-3-324-5235

The sites are constructed in conformance with the requirements of ANSI C63.7, ANSI C63.10: 2013 and CISPR Publication 22.

5.2 EQUIPMENT



Radiated emissions are measured with one or more of the following types of linearly polarized antennas: tuned dipole, bucolical, log periodic, bi-log, ridged waveguide, horn and/or Loop. Spectrum analyzers with pre-selectors and quasi-peak detectors are used to perform radiated measurements.

Conducted emissions are measured with Line Impedance Stabilization Networks and EMI Test Receivers.

Calibrated wideband preamplifiers, coaxial cables, and coaxial attenuators are also used for making measurements.

All receiving equipment conforms to CISPR Publication 16-1, "Radio Interference Measuring Apparatus and Measurement Methods."

5.3 TABLE OF ACCREDITATIONS AND LISTINGS

Country	Agency	Scope of Accreditation	Logo
USA	FCC	3M Semi Anechoic Chamber (FCC MRA: TW1039) to perform FCC Part 15 measurements	 FCC MRA: TW1039
Taiwan	TAF	LP0002, RTTE01, FCC Method-47 CFR Part 15 Subpart C, D, E, RSS-247, RSS-310 IDA TS SRD, AS/NZS 4268, AS/NZS 4771, TS 12.1 & 12.2, ETSI EN 300 440-1, ETSI EN 300 440-2, ETSI EN 300 328, ETSI EN 300 220-1, ETSI EN 300 220-2, ETSI EN 301 893, ETSI EN 301 489-1/3/7/17 FCC OET Bulletin 65 + Supplement C, EN 50360, EN 50361, EN 50371, RSS 102, EN 50383, EN 50385, EN 50392, IEC 62209, CNS 14958-1, CNS 14959 FCC Method -47 CFR Part 15 Subpart B IEC / EN 61000-3-2, IEC / EN 61000-3-3, IEC / EN 61000-4-2/3/4/5/6/8/11	
Canada	Industry Canada	3M Semi Anechoic Chamber (IC 2324G-1 / IC 2324G-2) to perform	

** No part of this report may be used to claim or imply product endorsement by A2LA or any agency of the US Government.*

6 SETUP OF EQUIPMENT UNDER TEST

6.1 SETUP CONFIGURATION OF EUT

See test photographs attached in Appendix II for the actual connections between EUT and support equipment.

6.2 SUPPORT EQUIPMENT

No.	Device Type	Brand	Model	Series No.	FCC ID	Data Cable	Power Cord
1	Notebook PC	ASUS	M5200AE	5BN0AG019631	PD9WM3B2100	N/A	AC I/P: Unshielded, 1.8m with a core DC O/P: Unshielded, 1.8m

Remark:

1. All the equipment/cables were placed in the worst-case configuration to maximize the emission during the test.
2. Grounding was established in accordance with the manufacturer's requirements and conditions for the intended use.

7 FCC PART 15.247 REQUIREMENTS & RSS-247 REQUIREMENTS

7.1 99% BANDWIDTH

Test Configuration

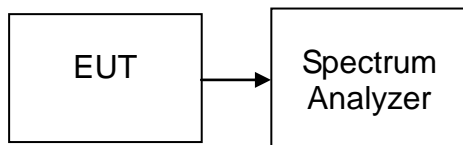

TEST PROCEDURE

The resolution bandwidth shall be set to as close to 1% of the selected span as is possible without being below 1%. The video bandwidth shall be set to 3 times the resolution bandwidth. Video averaging is not permitted. Where practical, a sampling detector shall be used since a peak or, peak hold.

TEST RESULTS

No non-compliance noted.

Test Data

Frequency (MHz)	99% Bandwidth (MHz)
2405	2.4767
2440	2.4631
2475	2.4873

Test Plot

CH Low

Agilent

R T

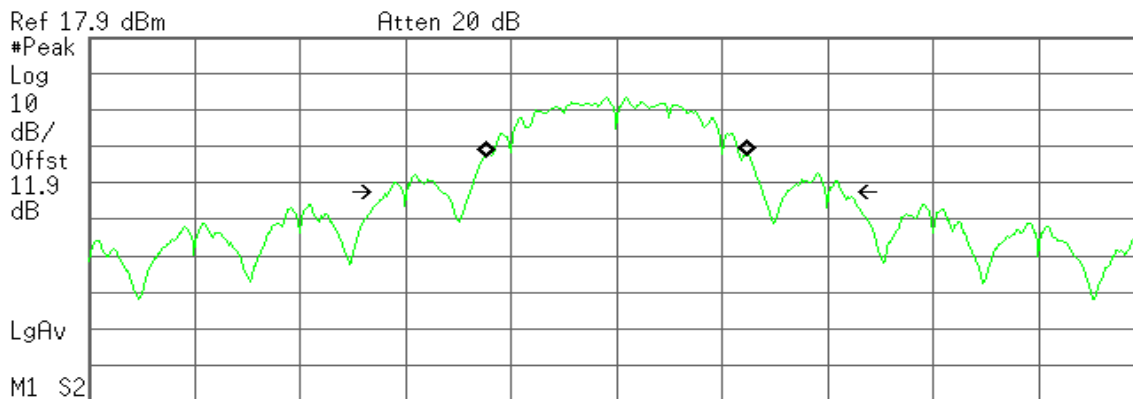

Occupied Bandwidth
2.4767 MHz

Occ BW % Pwr 99.00 %
x dB -26.00 dB

Transmit Freq Error -697.457 Hz
x dB Bandwidth 4.298 MHz

CH Mid

Agilent

R T

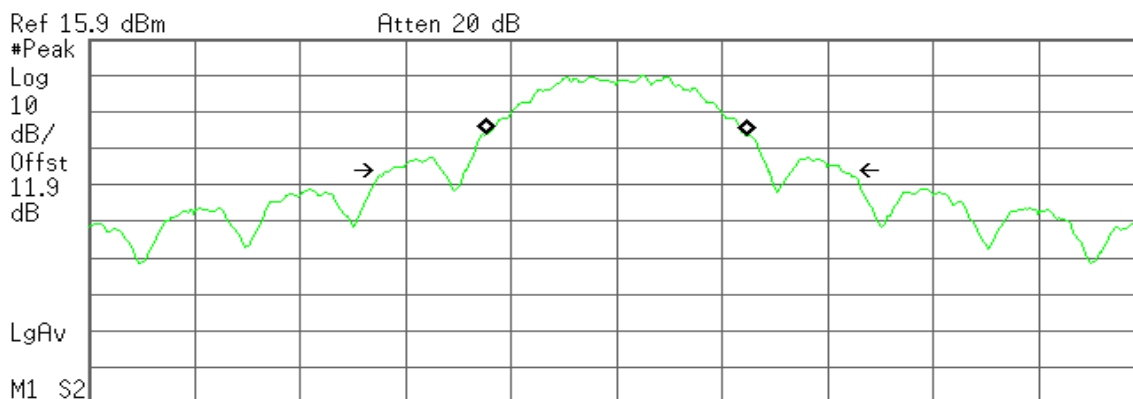

Occupied Bandwidth
2.4631 MHz

Occ BW % Pwr 99.00 %
x dB -26.00 dB

Transmit Freq Error 1.876 kHz
x dB Bandwidth 4.304 MHz

CH High

Agilent

R T

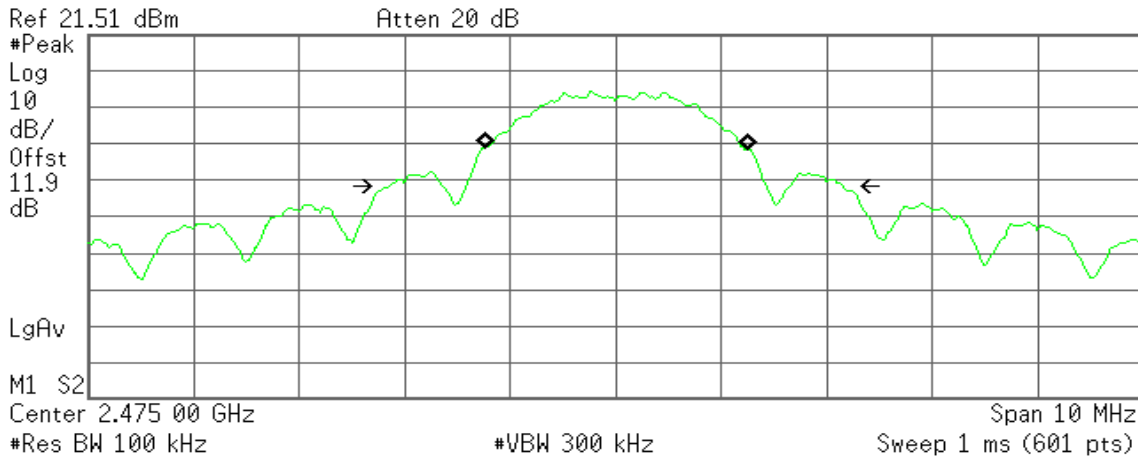

Occupied Bandwidth
2.4873 MHz

Occ BW % Pwr 99.00 %
x dB -26.00 dB

Transmit Freq Error 2.059 kHz
x dB Bandwidth 4.315 MHz

7.2 6DB BANDWIDTH

LIMIT

According to §15.247(a)(2) & RSS-247§, systems using digital modulation techniques may operate in the 902 - 928 MHz, 2400 - 2483.5 MHz, and 5725 - 5850 MHz bands. The minimum 6 dB bandwidth shall be at least 500 kHz.

Test Configuration

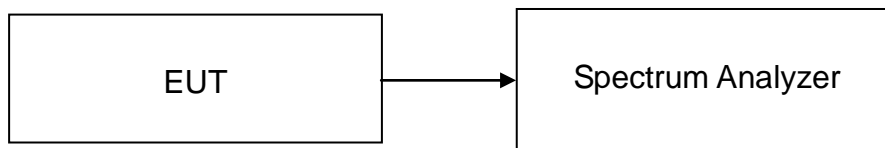

TEST PROCEDURE

The transmitter output is connected to the spectrum analyzer. Set the RBW=100kHz the emission bandwidth, VBW $\geq 3 \times$ RBW, Detector = Peak, Trace mode = max hold, Sweep = auto couple. Measure the maximum width of the emission that is constrained by the frequencies associated with the two amplitude points (upper and lower) that are attenuated by 6dB relative to the maximum level measured in the fundamental emission.

TEST RESULTS

No non-compliance noted

Test Data

Channel	Frequency (MHz)	6dB Bandwidth (MHz)	Limit (kHz)	Test Result
Low	2405	1.60	>500	PASS
Mid	2440	1.60		PASS
High	2475	1.63		PASS

Test Plot

6dB Bandwidth (CH Low)

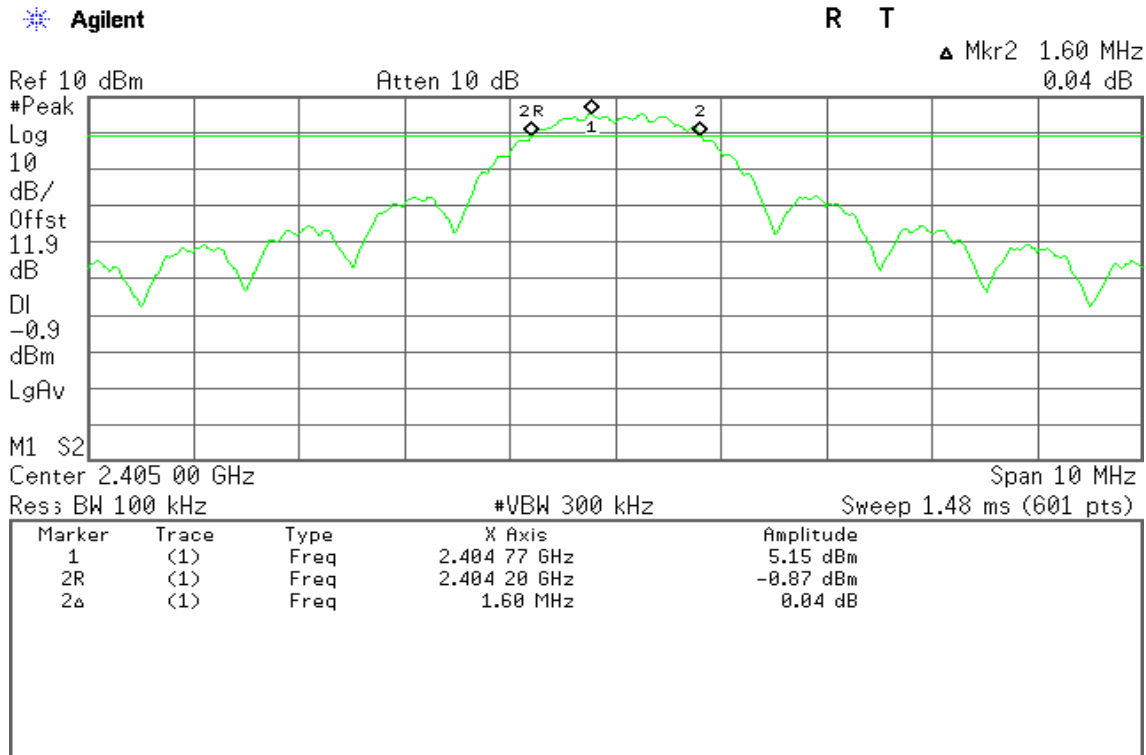

6dB Bandwidth (CH Mid)

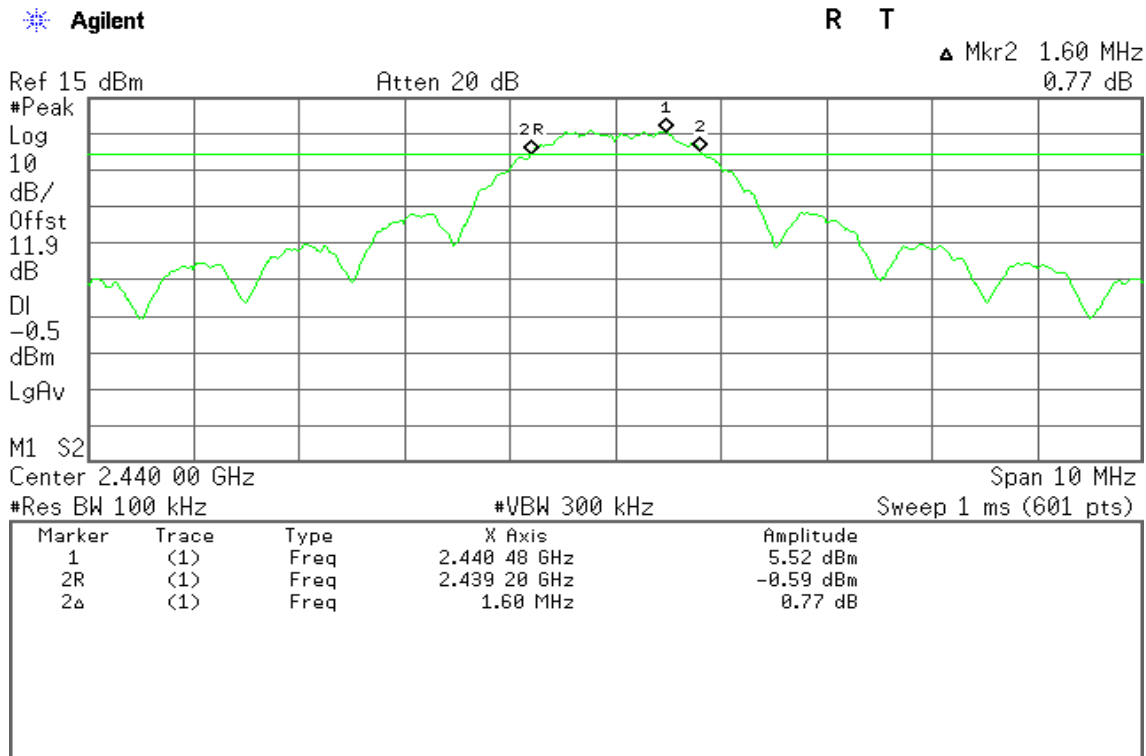

6dB Bandwidth (CH High)

Agilent

R T

▲ Mkr2 1.63 MHz
-0.10 dB

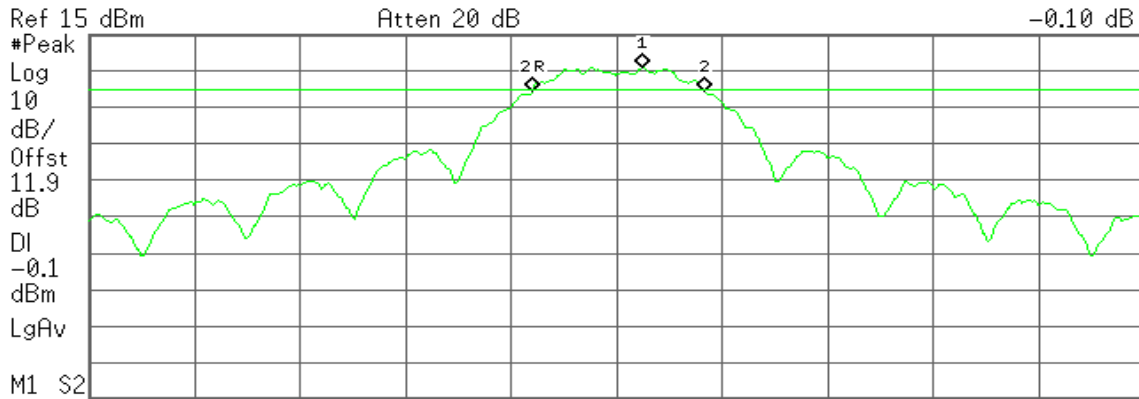

M1 S2
Center 2.475 00 GHz

Span 10 MHz

#Res BW 100 kHz

#VBW 300 kHz

Sweep 1 ms (601 pts)

Marker	Trace	Type	X Axis	Amplitude
1	(1)	Freq	2.475 25 GHz	5.92 dBm
2R	(1)	Freq	2.474 20 GHz	-0.51 dBm
2Δ	(1)	Freq	1.63 MHz	-0.10 dB

7.3 PEAK POWER

LIMIT

The maximum peak output power of the intentional radiator shall not exceed the following:

1. According to §15.247(b)(3), for systems using digital modulation in the bands of 902-928 MHz, 2400-2483.5 MHz, and 5725-5850 MHz: 1 Watt.
2. According to §15.247(b)(4), the conducted output power limit specified in paragraph (b) of this section is based on the use of antennas with directional gains that do not exceed 6 dBi. Except as shown in paragraph (c) of this section, if transmitting antennas of directional gain greater than 6 dBi are used, the conducted output power from the intentional radiator shall be reduced below the stated values in paragraphs (b)(1), (b)(2), and (b)(3) of this section, as appropriate, by the amount in dB that the directional gain of the antenna exceeds 6 dBi.
3. According to RSS-247, for systems employing digital modulation techniques operating in the bands 902-928 MHz, 2400-2483.5 MHz and 5725-5850 MHz, the maximum peak conducted output power shall not exceed 1 W.

Test Configuration

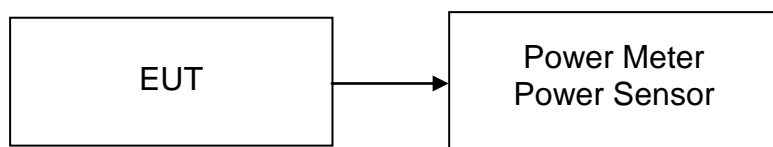

TEST PROCEDURE

The transmitter output is connected to the Power Meter. The Power Meter is set to the peak power detection.

TEST RESULTS

No non-compliance noted

Test Data

Channel	Frequency (MHz)	Output Power (dBm)	Output Power (W)	Limit (W)	Test Result
Low	2405	8.08	0.0064	1	PASS
Mid	2440	8.25	0.0067		PASS
High	2475	*8.43	0.0070		PASS

7.4 AVERAGE POWER

LIMIT

None; for reporting purposes only.

Test Configuration

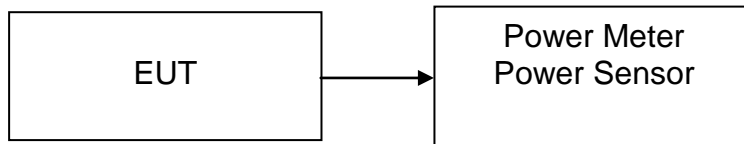

TEST PROCEDURE

The transmitter output is connected to the Power Meter. The Power Meter is set to the avg power detection.

TEST RESULTS

No non-compliance noted.

Test Data

Channel	Frequency (MHz)	Output Power (dBm)	Output Power (W)
Low	2405	7.98	0.0063
Mid	2440	*8.33	0.0068
High	2475	8.3	0.0068

7.5 BAND EDGES MEASUREMENT

LIMIT

According to §15.247(d) & RSS-247, in any 100 kHz bandwidth outside the frequency bands in which the spread spectrum intentional radiator is operating, the radio frequency power that is produced by the intentional radiator shall be at least 20 dB below that in the 100 kHz bandwidth within the band that contains the highest level of the desired power, based on either an RF conducted or a radiated measurement, provided the transmitter demonstrates compliance with the peak conducted power limits. In addition, radiated emissions which fall in the restricted bands, as defined in §15.205(a), must also comply with the radiated emission limits specified in 15.209(a) (see Section 15.205(c)).

Test Configuration

For Radiated

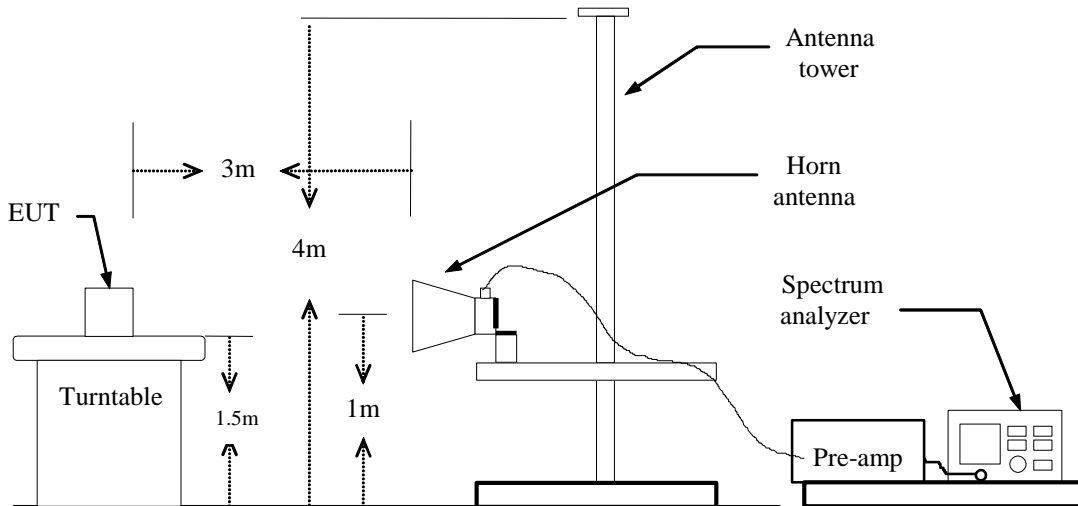

For Conducted

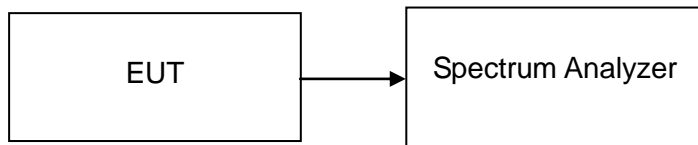

TEST PROCEDURE

For Radiated

1. The EUT is placed on a turntable, which is 1.5m above the ground plane.
2. The turntable shall be rotated for 360 degrees to determine the position of maximum emission level.
3. EUT is set 3m away from the receiving antenna, which is varied from 1m to 4m to find out the highest emission.
4. Set the spectrum analyzer in the following setting in order to capture the lower and upper band-edges of the emission:
 - (a) PEAK: RBW=1MHz / VBW=3MHz / Sweep=AUTO
 - (b) AVERAGE: RBW=1MHz,
if duty cycle $\geq 98\%$, VBW=10Hz.
if duty cycle $< 98\%$ VBW=1/T.
Zigbee: =99%, VBW=10Hz.
5. Repeat the procedures until all the PEAK and AVERAGE versus POLARIZATION are measured.

For Conducted

Conducted RF measurements of the transmitter output were made to confirm that the EUT antenna port conducted emissions meet the specified limit and to identify any spurious signals that require further investigation or measurements on the radiated emissions site.

The transmitter output is connected to the spectrum analyzer. The resolution bandwidth is set to 100 kHz. The video bandwidth is set to 100 kHz.

TEST RESULTS

Refer to attach spectrum analyzer data chart.

Band Edges (CH Low)

Polarity: Vertical

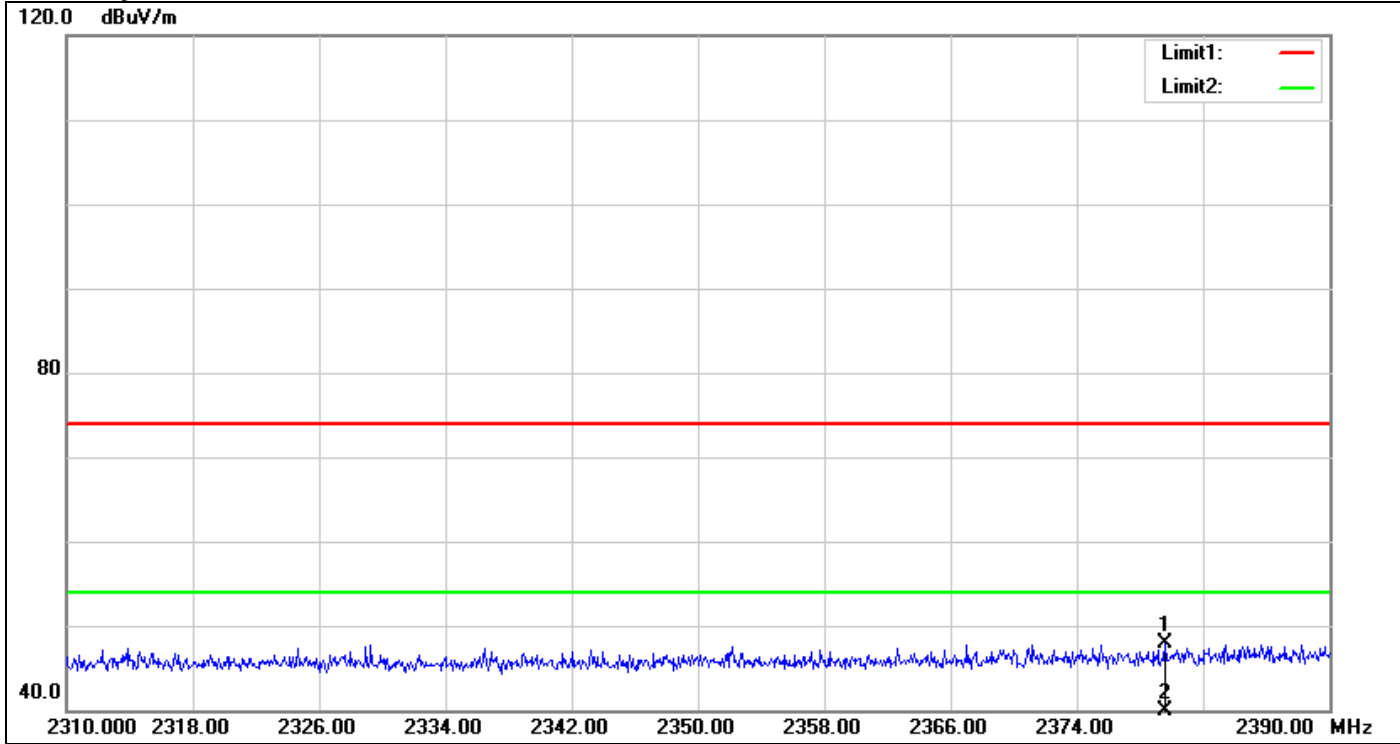

No.	Frequency (MHz)	Reading (dBuV)	Correct Factor(dB/m)	Result (dBuV/m)	Limit (dBuV/m)	Margin (dB)	Height (cm)	Degree (°)	Remark
1	2379.600	50.50	-2.58	47.92	74.00	-26.08	100	50	peak
2	2379.600	37.62	-2.58	35.04	54.00	-18.96	100	50	AVG

Polarity: Horizontal

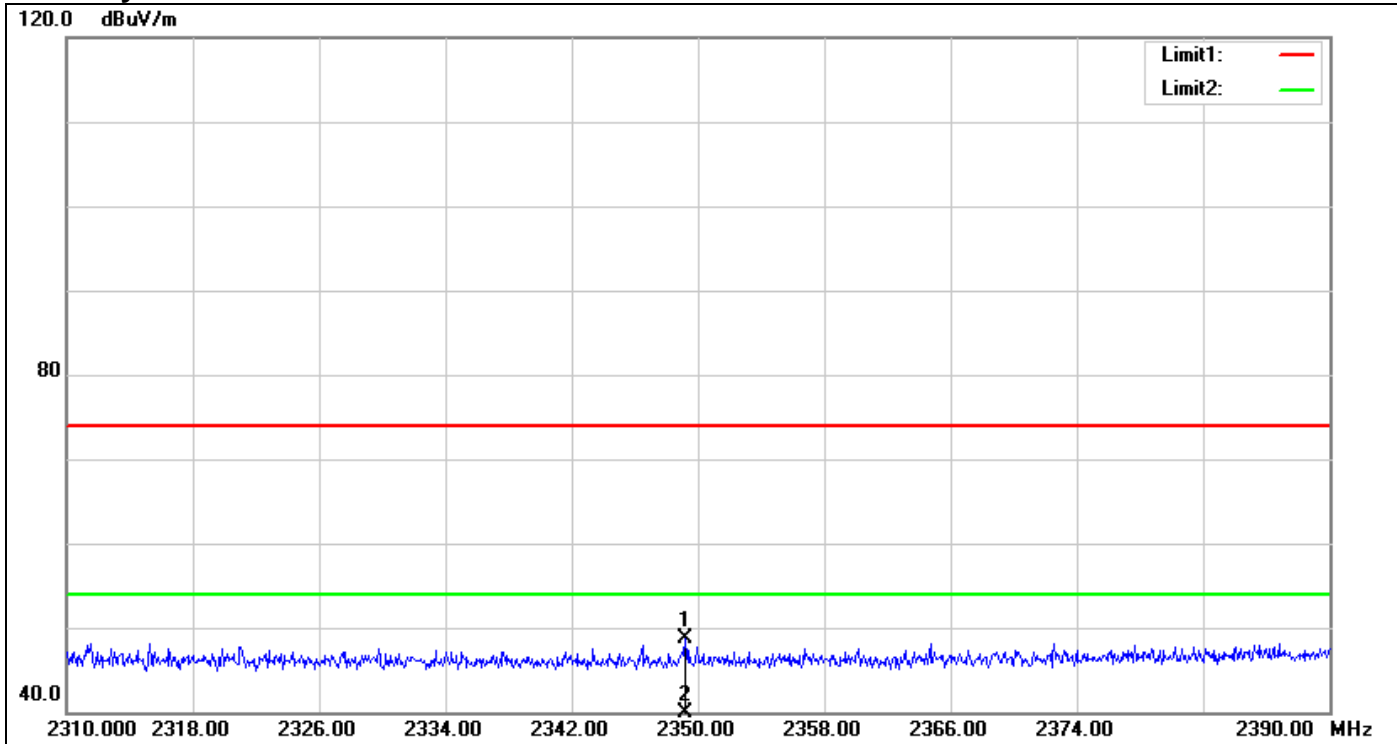

No.	Frequency (MHz)	Reading (dBuV)	Correct Factor(dB/m)	Result (dBuV/m)	Limit (dBuV/m)	Margin (dB)	Height (cm)	Degree (°)	Remark
1	2349.200	51.43	-2.81	48.62	74.00	-25.38	100	111	peak
2	2349.200	38.11	-2.81	35.30	54.00	-18.70	100	111	AVG

Band Edges (CH High)

Polarity: Vertical

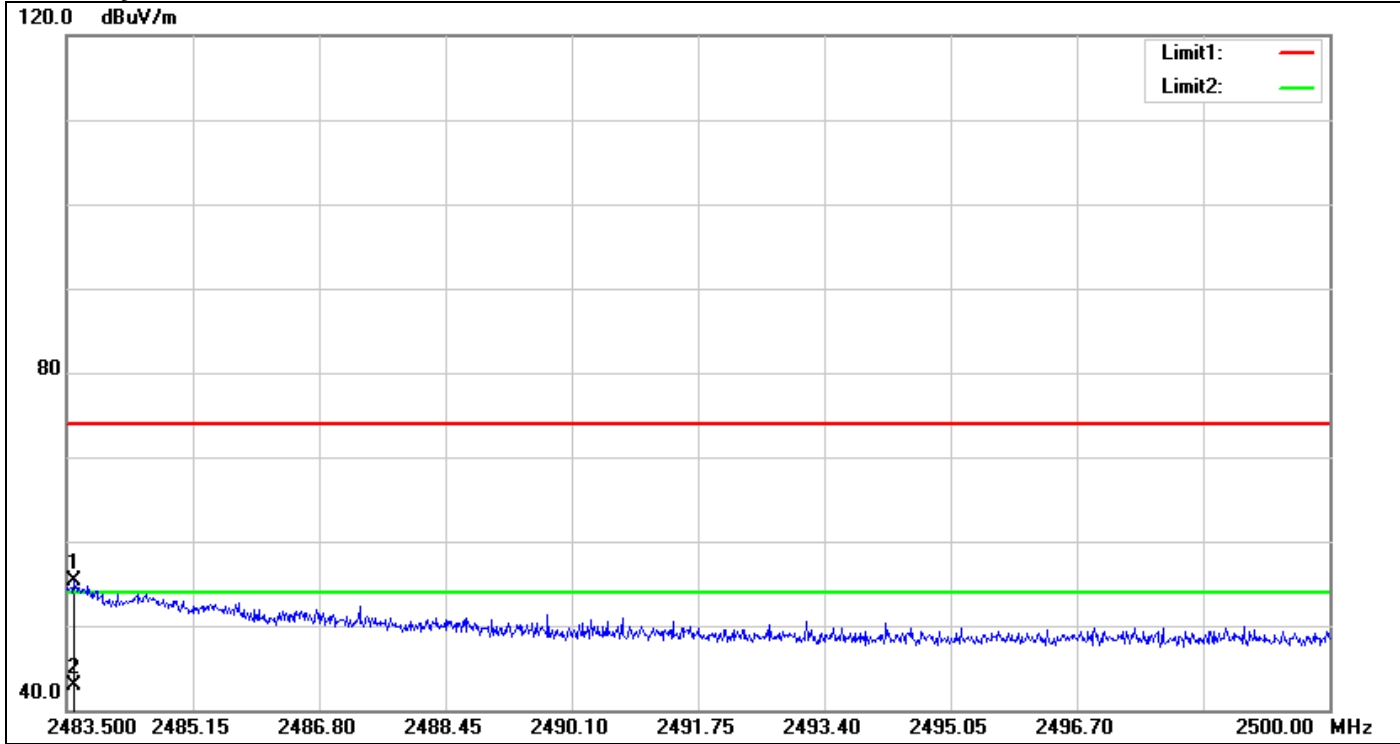

No.	Frequency (MHz)	Reading (dBuV)	Correct Factor(dB/m)	Result (dBuV/m)	Limit (dBuV/m)	Margin (dB)	Height (cm)	Degree (°)	Remark
1	2483.599	57.26	-1.99	55.27	74.00	-18.73	100	359	peak
2	2483.599	44.83	-1.99	42.84	54.00	-11.16	100	359	AVG

Polarity: Horizontal

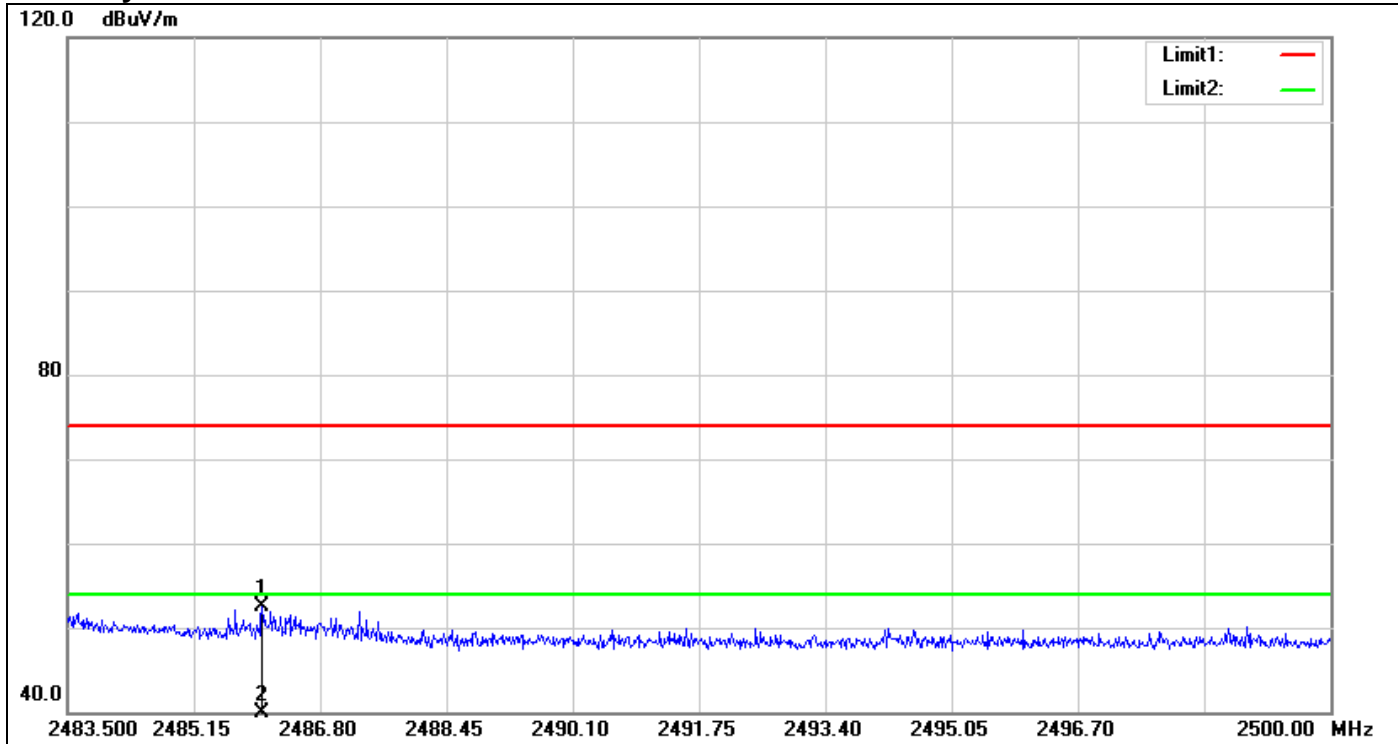

No.	Frequency (MHz)	Reading (dBuV)	Correct Factor(dB/m)	Result (dBuV/m)	Limit (dBuV/m)	Margin (dB)	Height (cm)	Degree (°)	Remark
1	2486.041	54.50	-1.97	52.53	74.00	-21.47	100	43	peak
2	2486.041	40.41	-1.97	38.44	54.00	-15.56	100	43	AVG

Conducted Band Edges

CH Low

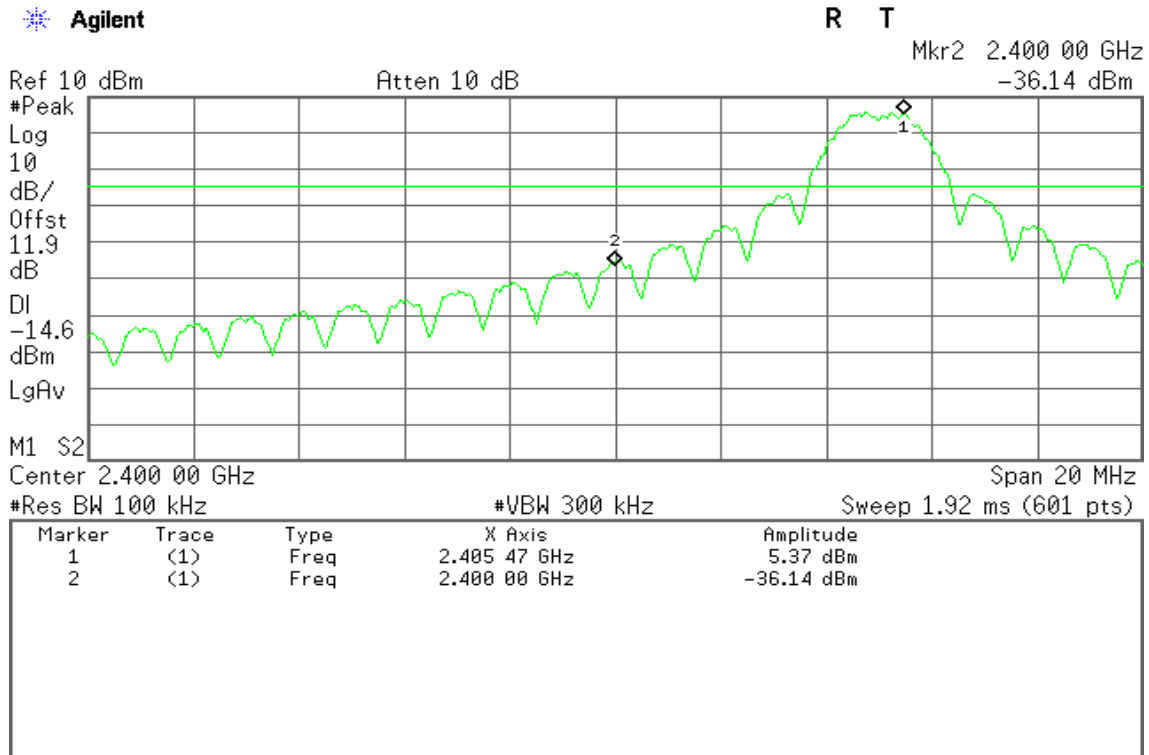

CH Mid

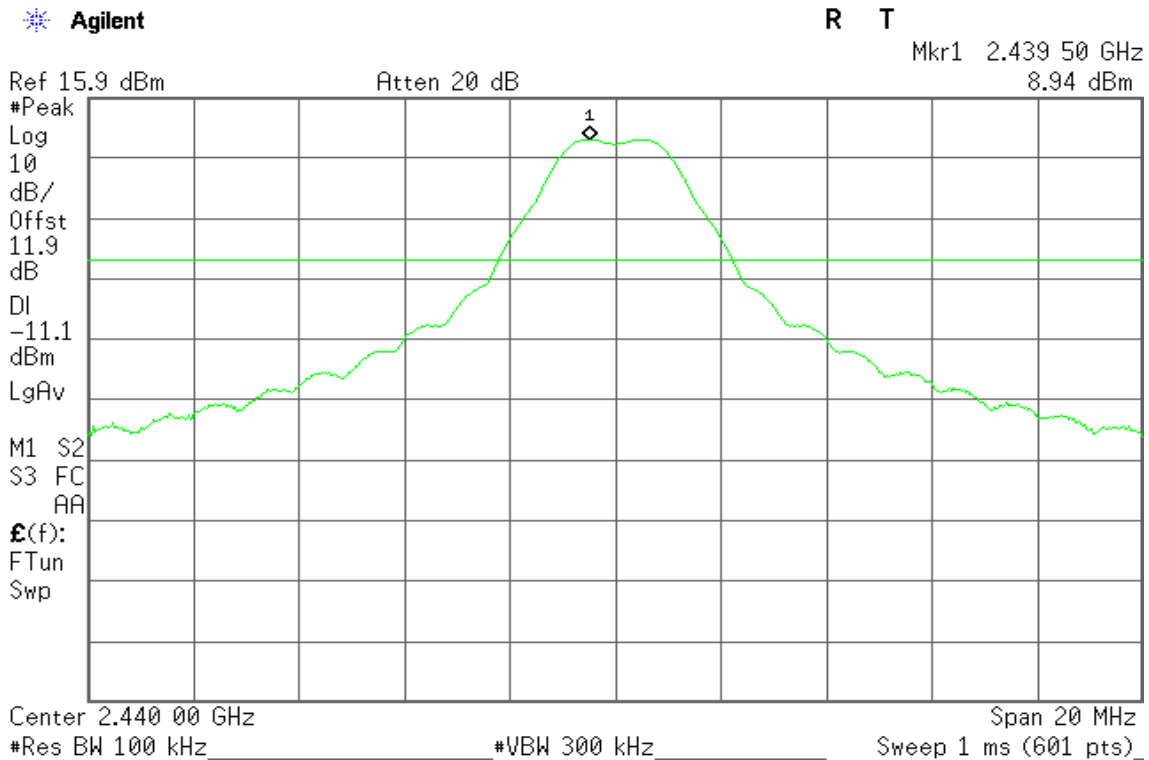

CH High

 **Agilent**

R T

Mkr2 2.483 90 GHz
-45.14 dBm

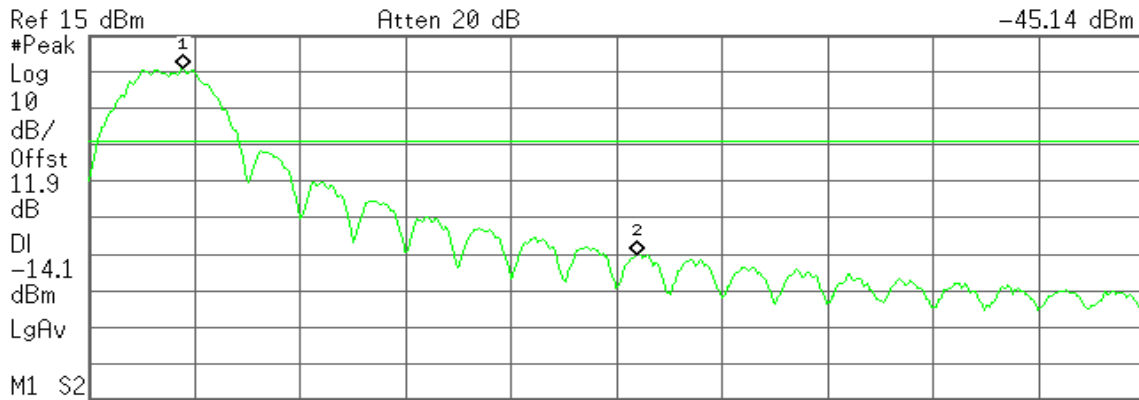

Center 2.483 50 GHz Span 20 MHz
#Res BW 100 kHz #VBW 300 kHz Sweep 1.92 ms (601 pts)

Marker	Trace	Type	X Axis	Amplitude
1	(1)	Freq	2.475 27 GHz	5.86 dBm
2	(1)	Freq	2.483 90 GHz	-45.14 dBm

7.6 PEAK POWER SPECTRAL DENSITY

LIMIT

1. According to §15.247(e) & RSS-247, for digitally modulated systems, the power spectral density conducted from the intentional radiator to the antenna shall not be greater than 8 dBm in any 3 kHz band during any time interval of continuous transmission.
2. According to §15.247(f) & RSS-247, the digital modulation operation of the hybrid system, with the frequency hopping turned off, shall comply with the power density requirements of paragraph (d) of this section.

Test Configuration

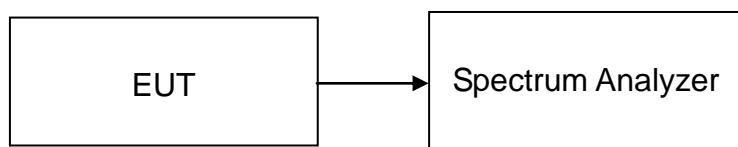

TEST PROCEDURE

The transmitter output is connected to a spectrum analyzer. Set the RBW = 100 kHz, VBW ≥ 300 kHz, span to 1.5 times the DTS bandwidth, Detector = peak, Trace mode = max hold, Sweep = auto couple. Use the peak marker function to determine the maximum amplitude level within the RBW. If measured value exceeds limit, reduce RBW (no less than 3 kHz).

TEST RESULTS

No non-compliance noted

Test Data

Channel	Frequency (MHz)	PPSD (dBm)	Limit (dBm)	Test Result
Low	2405	4.99	8.00	PASS
Mid	2440	-7.44		PASS
High	2475	-6.24		PASS

Test Plot

PPSD (CH Low)

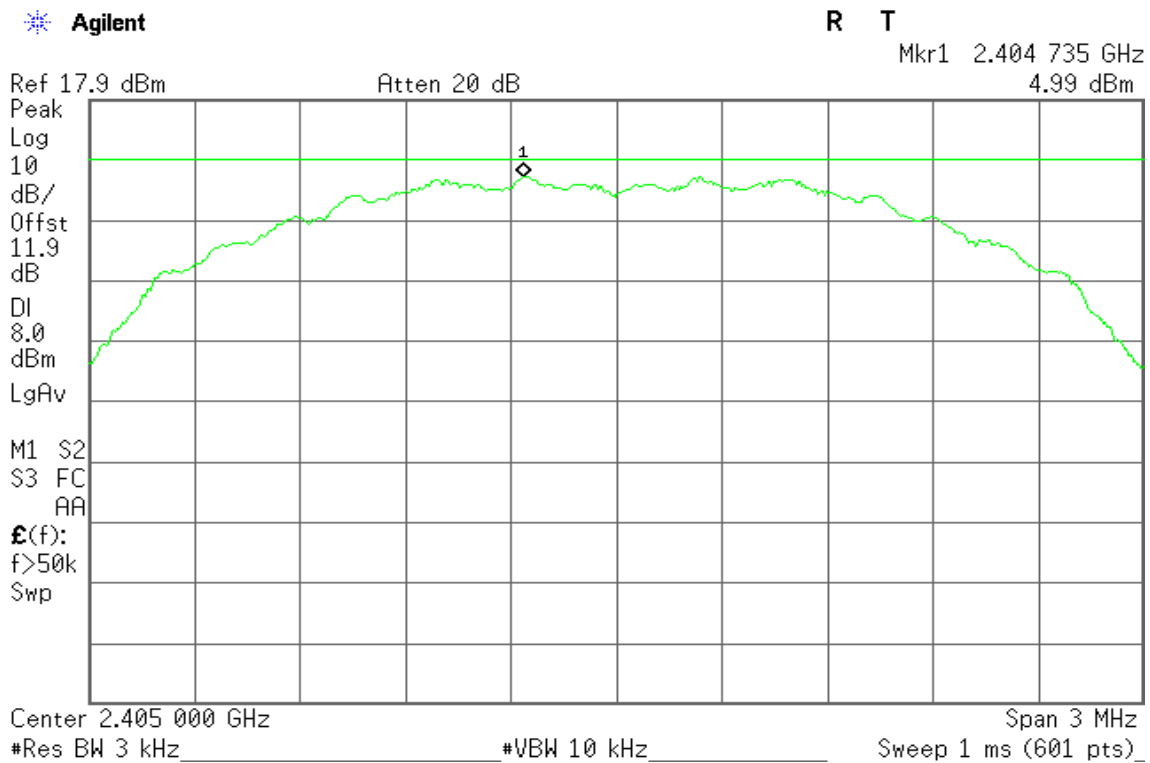

PPSD (CH Mid)

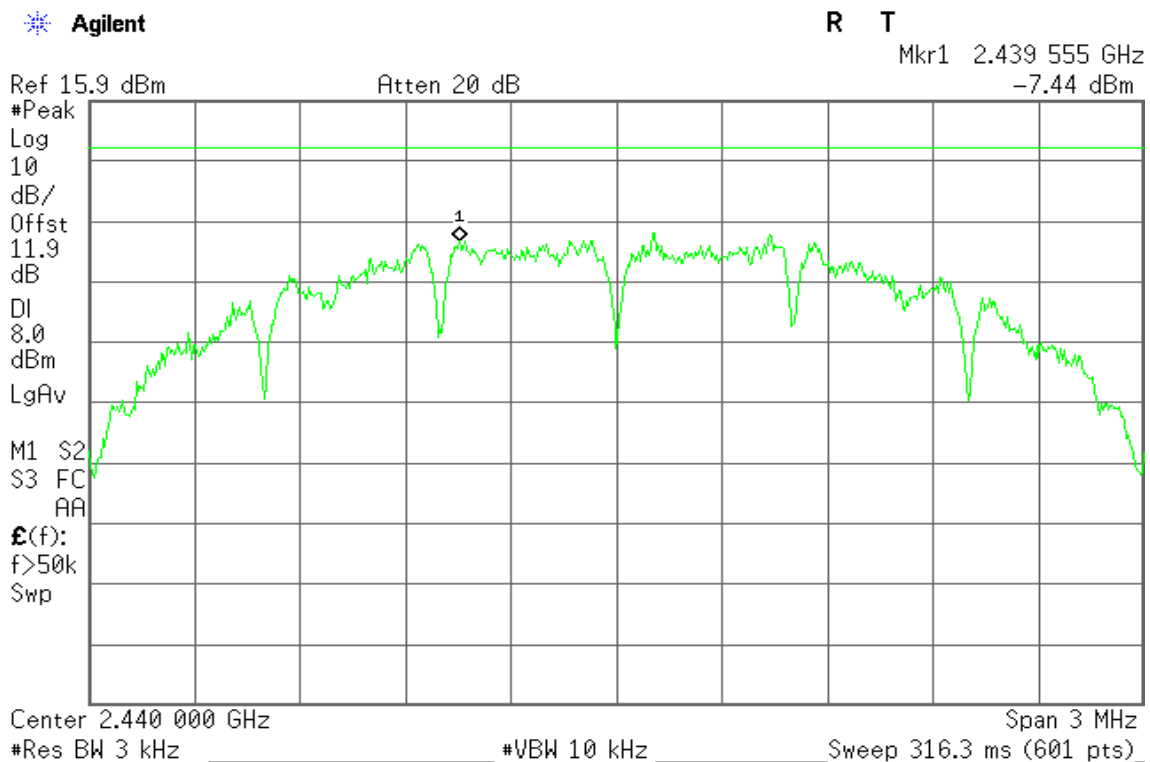

PPSD (CH High)

Agilent

R T

Mkr1 2.474 565 GHz
-6.24 dBm

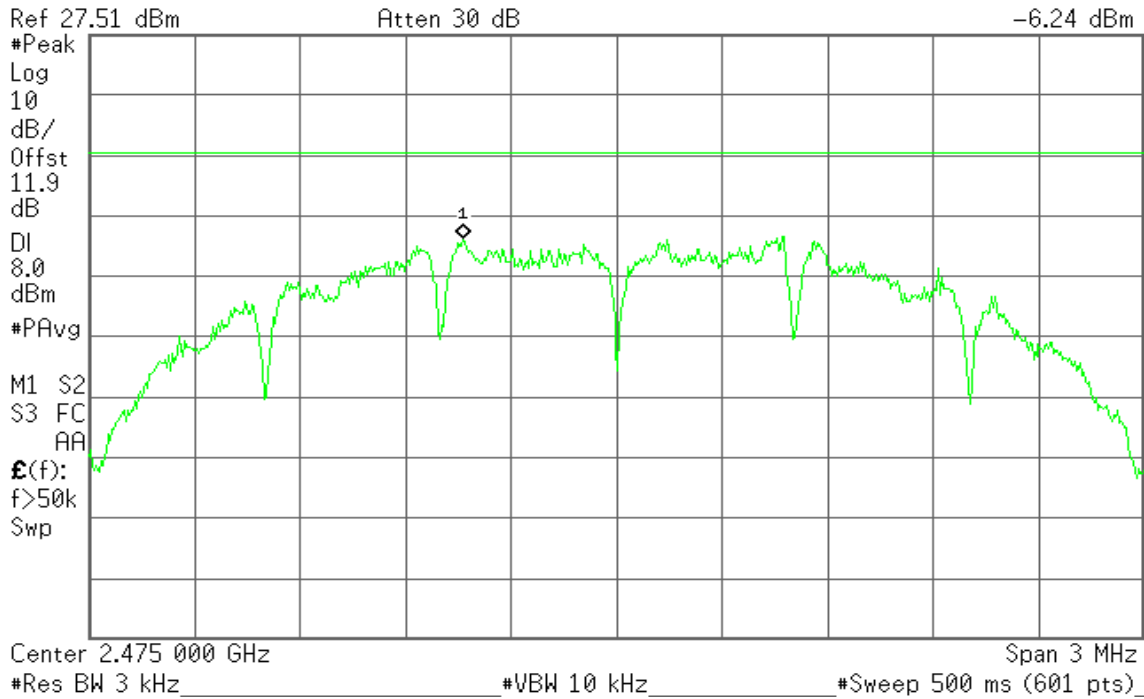

7.7 SPURIOUS EMISSIONS

7.7.1 Conducted Measurement

LIMIT

According to §15.247(d) & RSS-247, in any 100 kHz bandwidth outside the frequency bands in which the spread spectrum intentional radiator is operating, the radio frequency power that is produced by the intentional radiator shall be at least 20 dB below that in the 100 kHz bandwidth within the band that contains the highest level of the desired power, based on either an RF conducted or a radiated measurement, provided the transmitter demonstrates compliance with the peak conducted power limits. In addition, radiated emissions which fall in the restricted bands, as defined in §15.205(a), must also comply with the radiated emission limits specified in 15.209(a) (see Section 15.205(c)).

Test Configuration

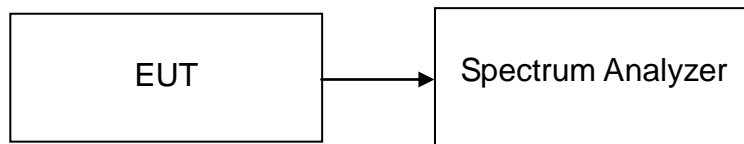

TEST PROCEDURE

Conducted RF measurements of the transmitter output were made to confirm that the EUT antenna port conducted emissions meet the specified limit and to identify any spurious signals that require further investigation or measurements on the radiated emissions site.

The transmitter output is connected to the spectrum analyzer. The resolution bandwidth is set to 100 kHz. The video bandwidth is set to 100 kHz.

Measurements are made over the 30MHz to 26GHz range with the transmitter set to the lowest, middle, and highest channels.

TEST RESULTS

No non-compliance noted

Test Plot

CH Low

Agilent

R T

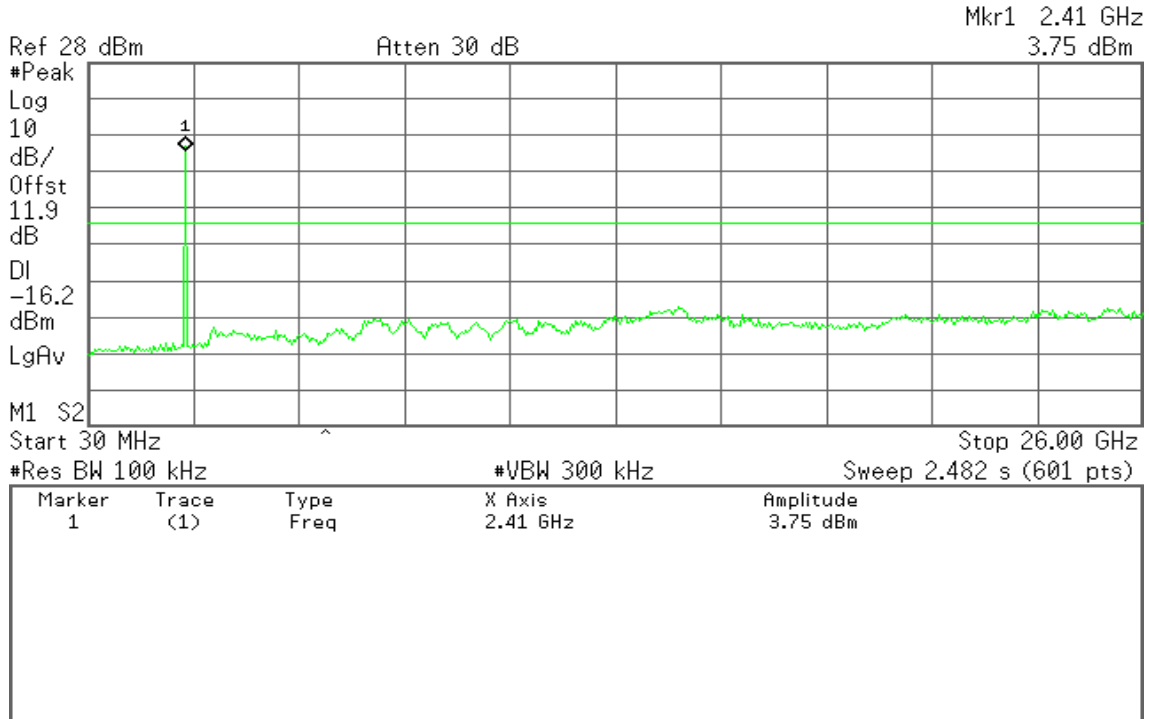

CH Mid

Agilent

R T

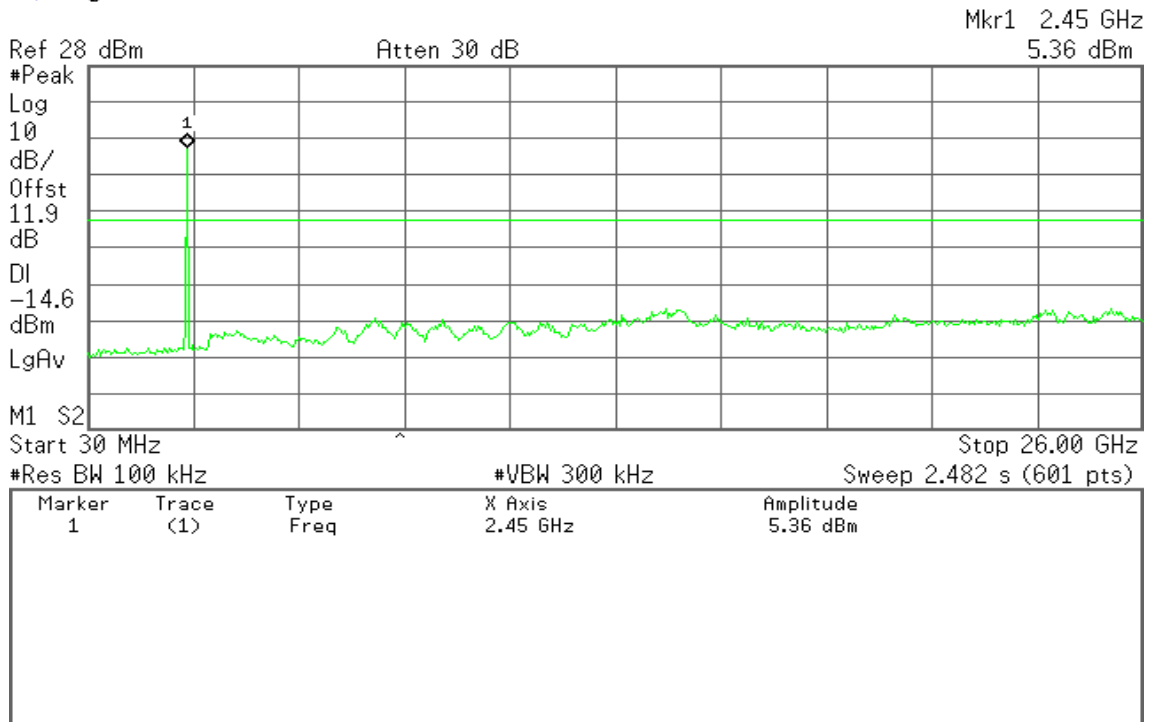

CH High

Agilent

R T

Mkr1 2.45 GHz
6.39 dBm

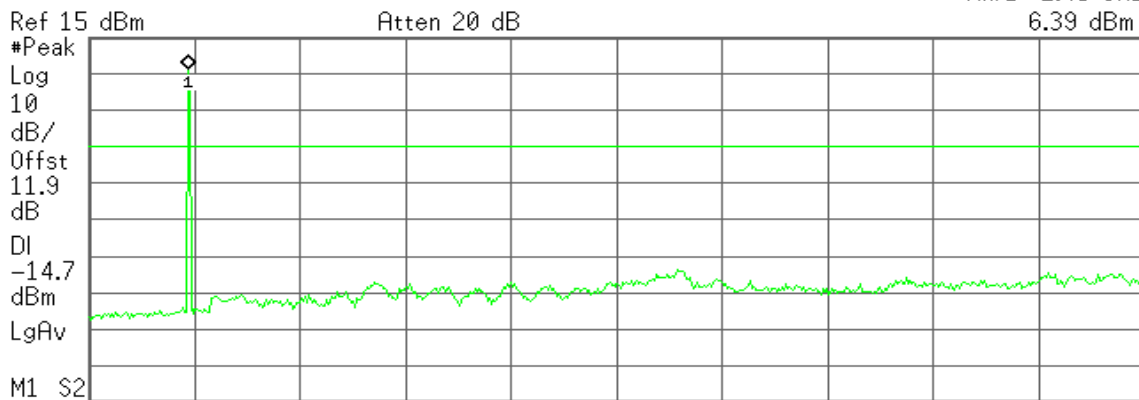

Marker	Trace	Type	X Axis	Amplitude
1	(1)	Freq	2.45 GHz	6.39 dBm

7.8 RADIATED EMISSIONS

LIMIT

All spurious emissions shall comply with the limits of §15.209(a) and RSS-Gen Table 2 & Table 5.

RSS-Gen Table 2 & Table 5: General Field Strength Limits for Transmitters and Receivers at Frequencies Above 30 MHz ^(Note)

Frequency (MHz)	Field Strength microvolts/m at 3 metres (watts, e.i.r.p.)	
	Transmitters	Receivers
30-88	100 (3 nW)	100 (3 nW)
88-216	150 (6.8 nW)	150 (6.8 nW)
216-960	200 (12 nW)	200 (12 nW)
Above 960	500 (75 nW)	500 (75 nW)

Note: *Measurements for compliance with limits in the above table may be performed at distances other than 3 meters, in accordance with Section 7.2.7.

Transmitting devices are not permitted in Table 1 bands or, unless stated otherwise, in TV bands (54-72 MHz, 76-88 MHz, 174-216 MHz, 470-608 MHz and 614-806 MHz).

RSS-Gen Table 6: General Field Strength Limits for Transmitters at Frequencies Below 30 MHz (Transmit)

Frequency	Field Strength (microvolts/m)	Magnetic H-Field (microamperes/m)	Measurement Distance (metres)
9-490 kHz	2,400/F (F in kHz)	2,400/377F (F in kHz)	3000
490-1,705 kHz	24,000/F (F in kHz)	24,000/377F (F in kHz)	30
1.705-30 MHz	30	N/A	30

Note: The emission limits for the bands 9-90 kHz and 110-490 kHz are based on measurements employing an average detector.

Test Configuration

9kHz ~ 30MHz

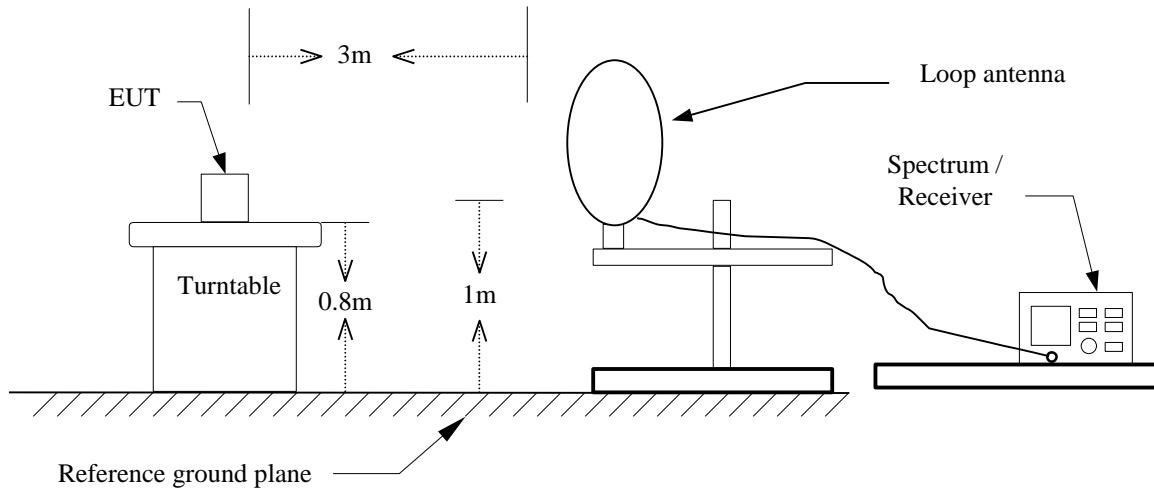

30MHz ~ 1GHz

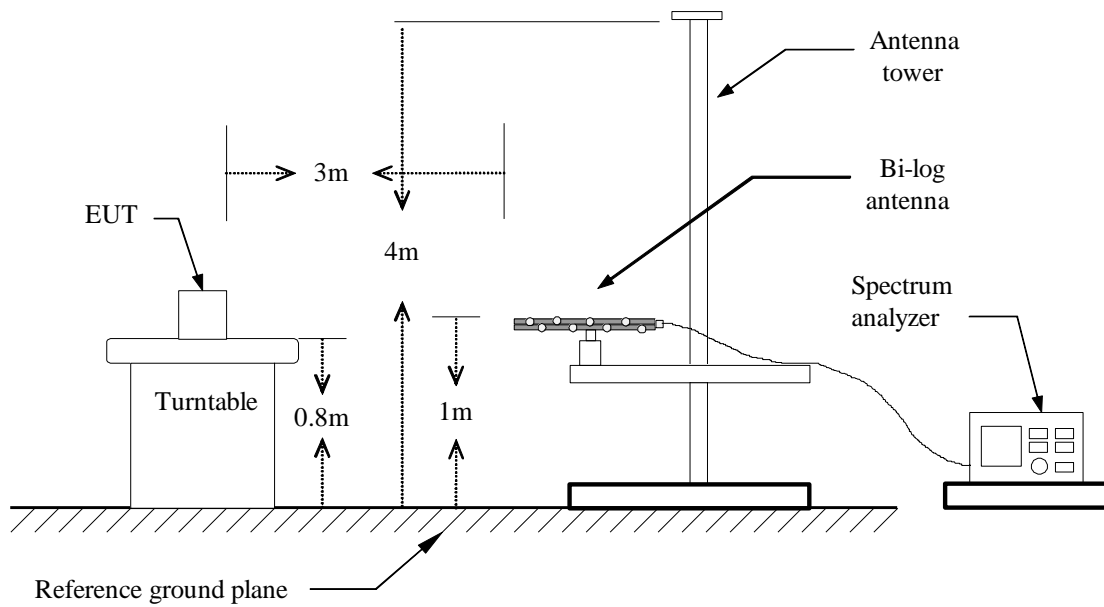

Above 1 GHz

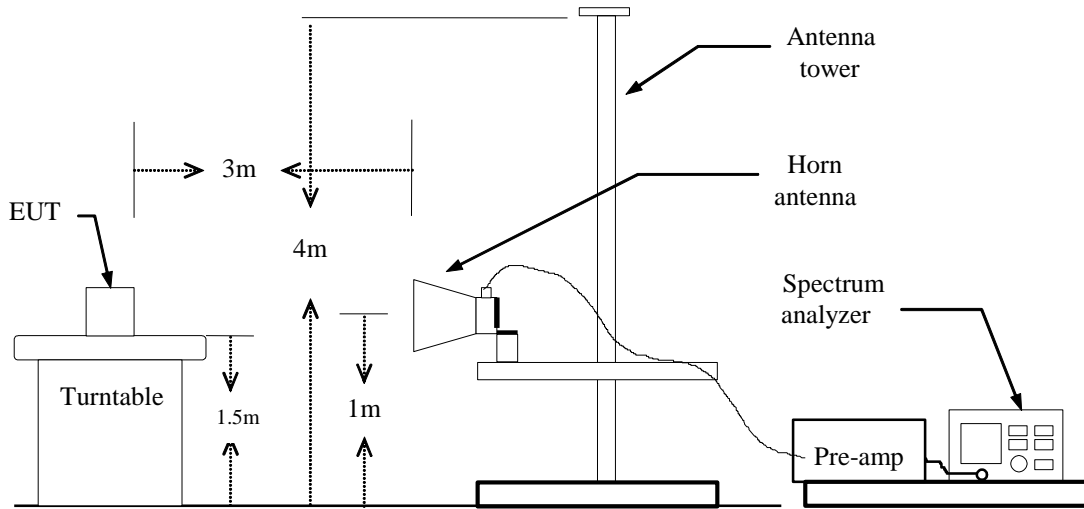

TEST PROCEDURE

1. The EUT is placed on a turntable, which is 1.5m above ground plane.
2. The turntable shall be rotated for 360 degrees to determine the position of maximum emission level.
3. EUT is set 3m away from the receiving antenna, which is varied from 1m to 4m to find out the highest emissions.
4. Maximum procedure was performed on the six highest emissions to ensure EUT compliance.
5. And also, each emission was to be maximized by changing the polarization of receiving antenna both horizontal and vertical.
6. Set the spectrum analyzer in the following setting as:
Below 1GHz:
RBW=100kHz / VBW=300kHz / Sweep=AUTO
Above 1GHz:
(a) PEAK: RBW=VBW=1MHz / Sweep=AUTO
(b) AVERAGE: RBW=1MHz,
if duty cycle \geq 98%, VBW=10Hz.
if duty cycle < 98% VBW=1/T.
Zigbee: =99%, VBW=10Hz.
7. Repeat above procedures until the measurements for all frequencies are complete.

Below 1 GHz

Operation Mode: Normal Link
Temperature: 27°C
Humidity: 53 % RH

Test Date: August 18, 2015
Tested by: Jason Lu
Polarity: Ver. / Hor.

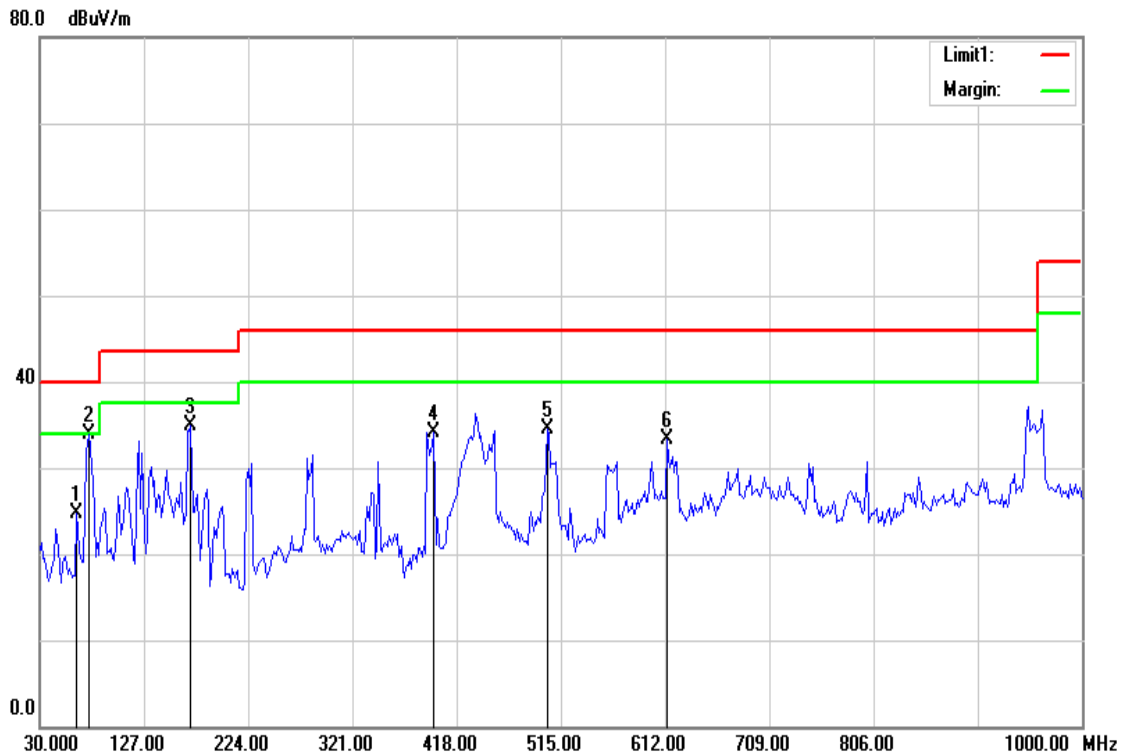

Frequency (MHz)	Reading (dBuV)	Correction Factor (dB/m)	Result (dBuV/m)	Limit (dBuV/m)	Margin (dB)	Remark	Ant.Pol. (H/V)
63.9500	48.19	-23.39	24.80	40.00	-15.20	Peak	V
75.2667	56.67	-22.83	33.84	40.00	-6.16	Peak	V
170.6500	53.75	-18.85	34.90	43.50	-8.60	Peak	V
396.9833	48.22	-14.09	34.13	46.00	-11.87	Peak	V
502.0667	46.28	-11.80	34.48	46.00	-11.52	Peak	V
613.6167	43.41	-10.18	33.23	46.00	-12.77	Peak	V

Remark:

1. No emission found between lowest internal used/generated frequency to 30MHz (9kHz~30MHz)
2. Radiated emissions measured in frequency range from 30 MHz to 1000MHz were made with an instrument using peak/quasi-peak detector mode.
3. Quasi-peak test would be performed if the peak result were greater than the quasi-peak limit or as required by the applicant.
4. Measurements above show only up to 6 maximum emissions noted, or would be lesser, with " N/A " remark, if no specific emissions from the EUT are recorded (ie: margin>20dB from the applicable limit) and considered that's already beyond the background noise floor.
5. Margin (dB) = Remark result (dBuV/m) – Quasi-peak limit (dBuV/m).

Operation Mode: Normal Link

Test Date: August 18, 2015

Temperature: 27°C

Tested by: Jason Lu

Humidity: 53 % RH

Polarity: Ver. / Hor.

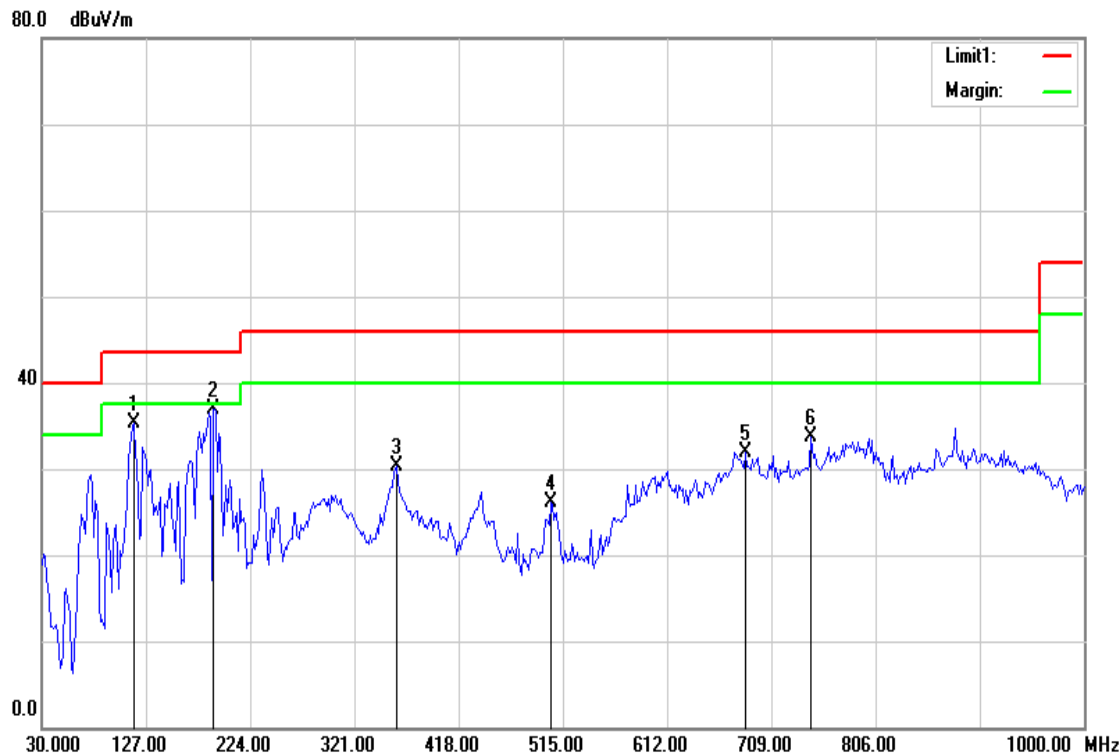

Frequency (MHz)	Reading (dBuV)	Correction Factor (dB/m)	Result (dBuV/m)	Limit (dBuV/m)	Margin (dB)	Remark	Ant.Pol. (H/V)
115.6833	53.54	-18.14	35.40	43.50	-8.10	Peak	H
190.0500	55.33	-18.44	36.89	43.50	-6.61	Peak	H
359.8000	45.18	-14.96	30.22	46.00	-15.78	Peak	H
503.6833	37.83	-11.77	26.06	46.00	-19.94	Peak	H
684.7500	40.79	-8.95	31.84	46.00	-14.16	Peak	H
746.1833	41.57	-7.95	33.62	46.00	-12.38	Peak	H

Remark:

1. No emission found between lowest internal used/generated frequency to 30MHz (9kHz~30MHz)
2. Radiated emissions measured in frequency range from 30 MHz to 1000MHz were made with an instrument using peak/quasi-peak detector mode.
3. Quasi-peak test would be performed if the peak result were greater than the quasi-peak limit or as required by the applicant.
4. Measurements above show only up to 6 maximum emissions noted, or would be lesser, with " N/A " remark, if no specific emissions from the EUT are recorded (ie: margin>20dB from the applicable limit) and considered that's already beyond the background noise floor.
5. Margin (dB) = Remark result (dBuV/m) – Quasi-peak limit (dBuV/m).

Above 1 GHz

Zigbee / TX / CH Low

Polarity: Vertical

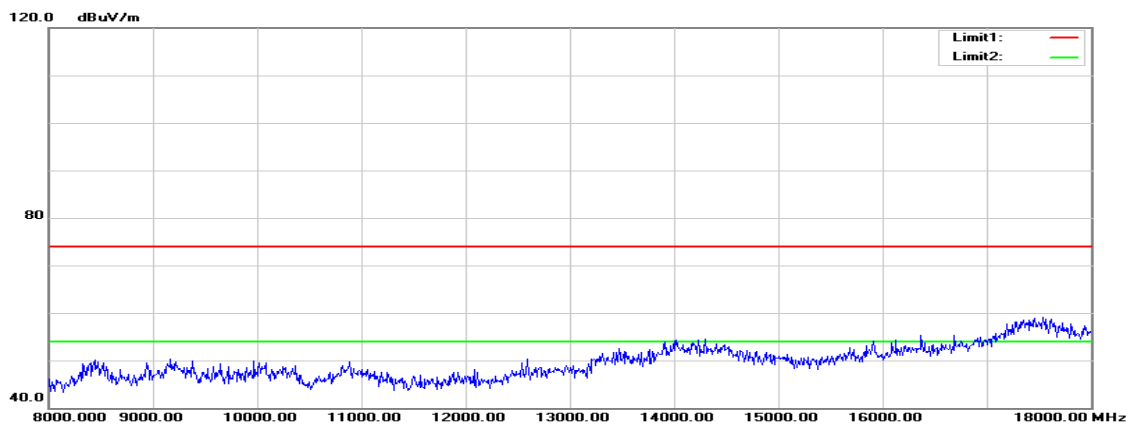
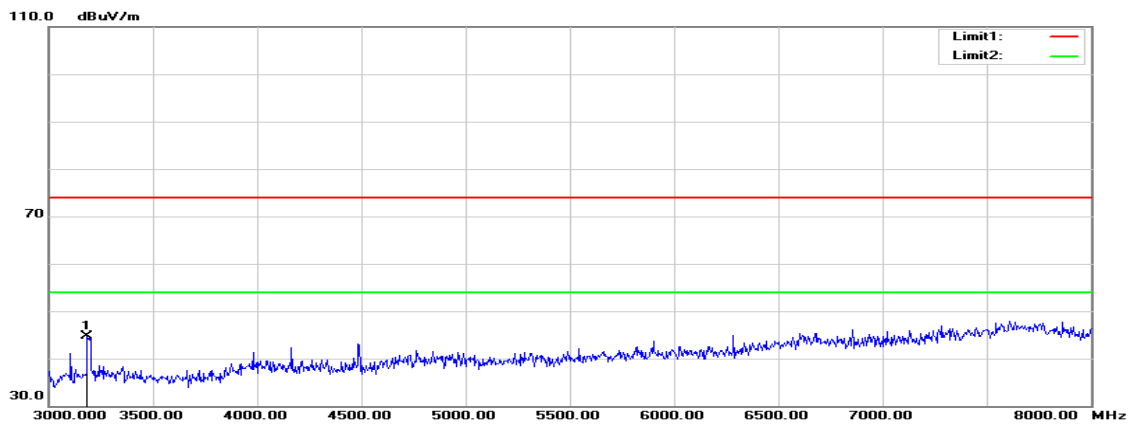
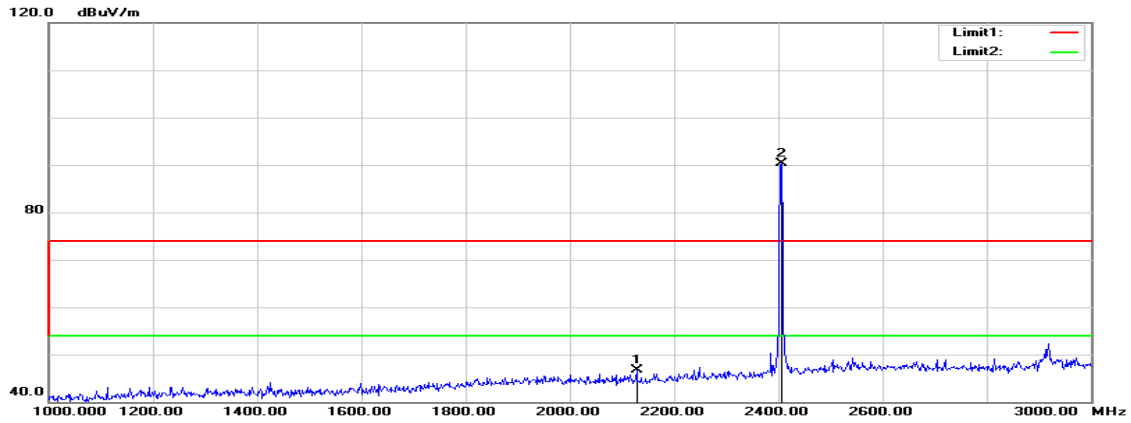

Polarity: Horizontal

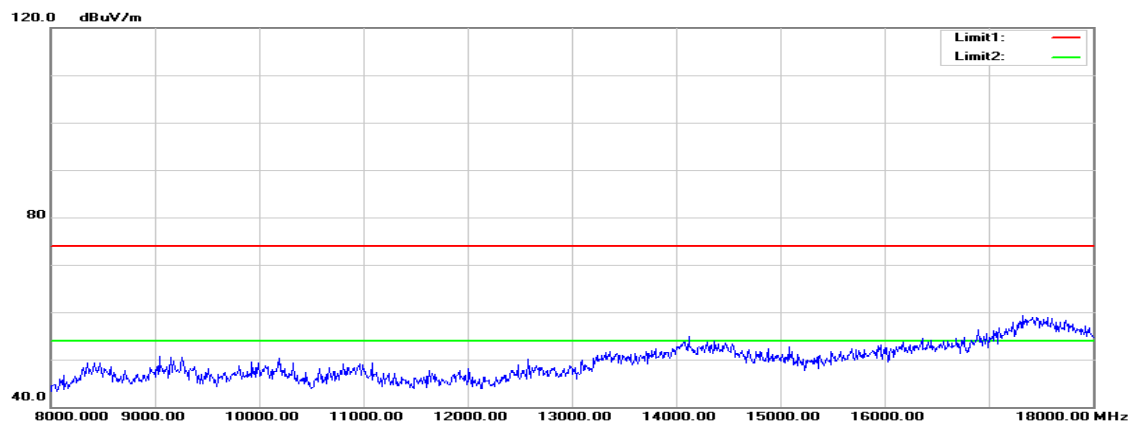
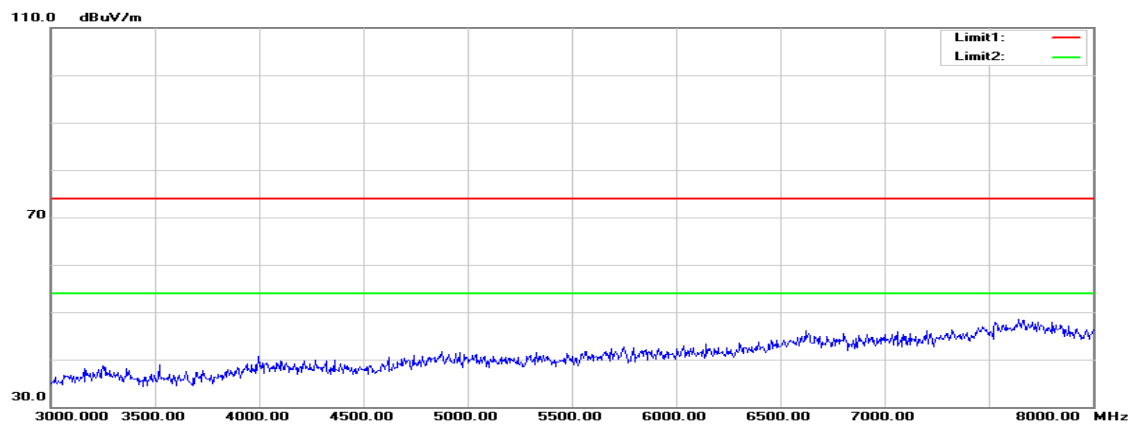
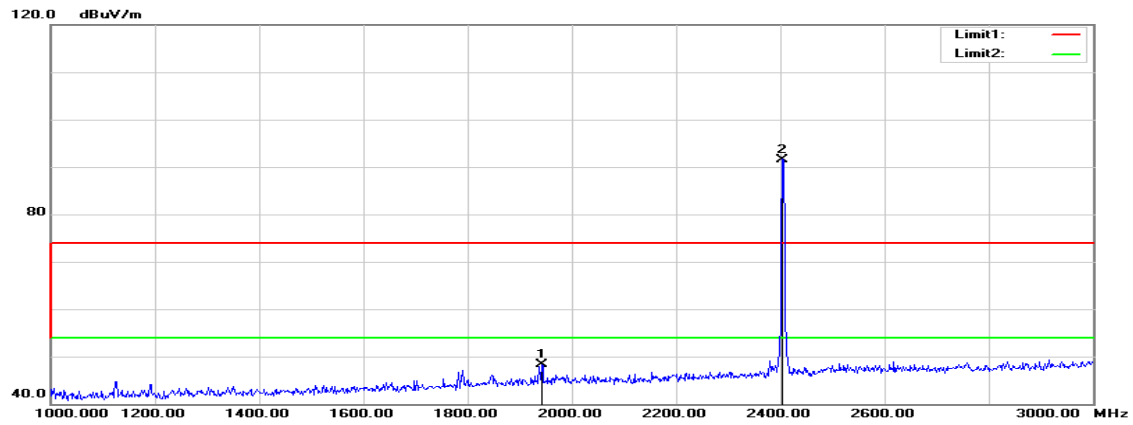

Operation Mode: Zigbee / TX / CH Low

Test Date: August 18, 2015

Temperature: 27°C

Tested by: Jason Lu

Humidity: 53 % RH

Polarity: Ver. / Hor.

Frequency (MHz)	Reading (dBuV)	Correction (dB/m)	Result (dBuV/m)	Limit (dBuV/m)	Margin (dB)	Remark	Ant.Pol. (H/V)
2128.000	50.16	-3.55	46.61	74.00	-27.39	peak	V
3185.000	44.78	-0.16	44.62	74.00	-29.38	peak	V
N/A							
1942.000	52.27	-3.90	48.37	74.00	-25.63	peak	H
N/A							

Remark:

1. *Measuring frequencies from 1 GHz to the 10th harmonic of highest fundamental frequency.*
2. *Radiated emissions measured in frequency above 1000MHz were made with an instrument using peak/average detector mode.*
3. *Average test would be performed if the peak result were greater than the average limit or as required by the applicant.*
4. *Data of measurement within this frequency range shown “ --- ” in the table above means the reading of emissions are attenuated more than 20dB below the permissible limits or the field strength is too small to be measured.*
5. *Measurements above show only up to 6 maximum emissions noted, or would be lesser, with “ N/A ” remark, if no specific emissions from the EUT are recorded (ie: margin>20dB from the applicable limit) and considered that's already beyond the background noise floor.*
6. *Margin (dB) = Remark result (dBuV/m) – Average limit (dBuV/m).*

Zigbee / TX / CH Mid

Polarity: Vertical

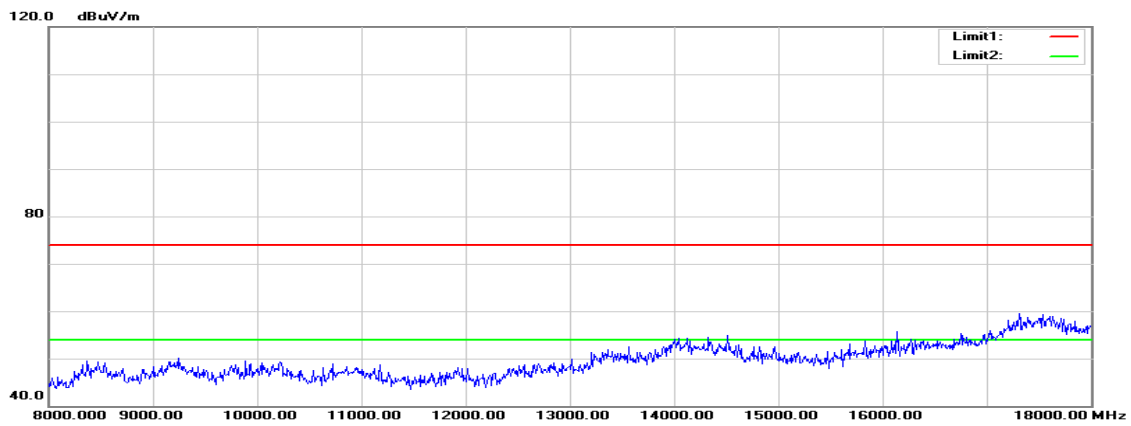
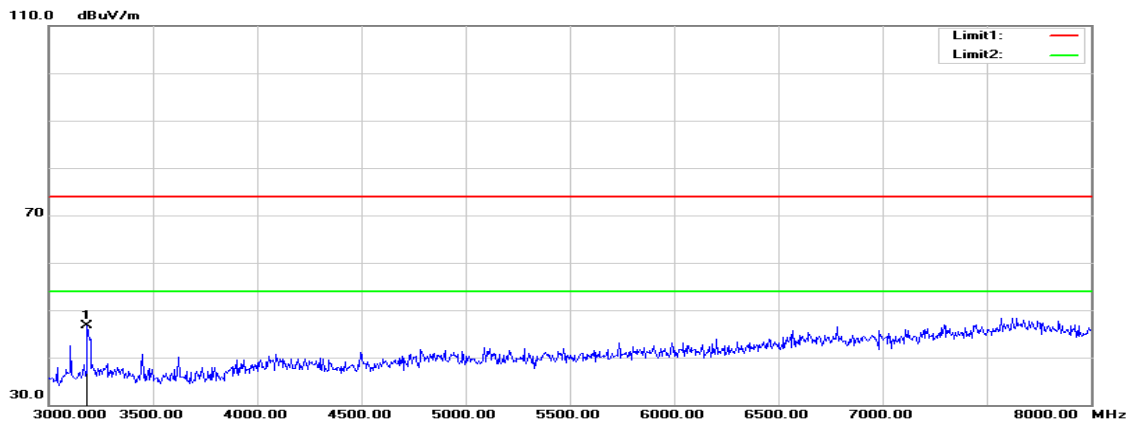
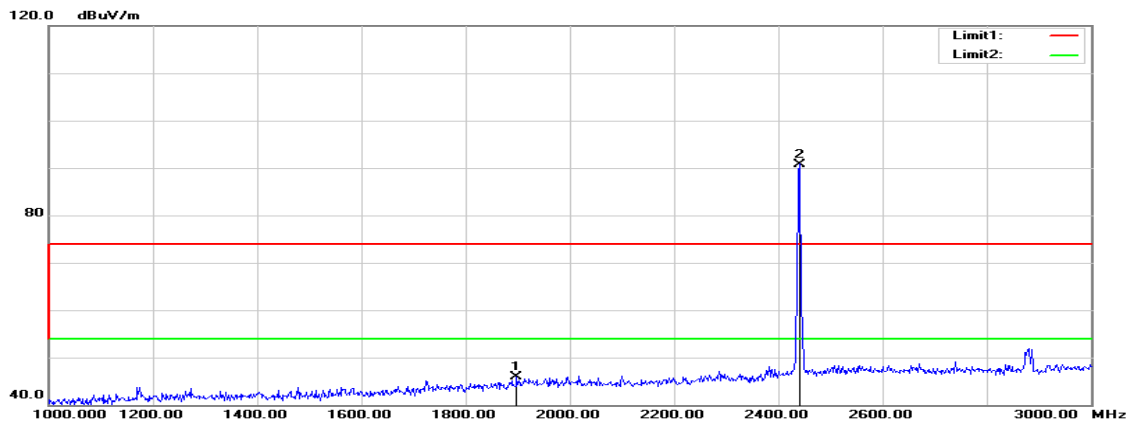

Polarity: Horizontal

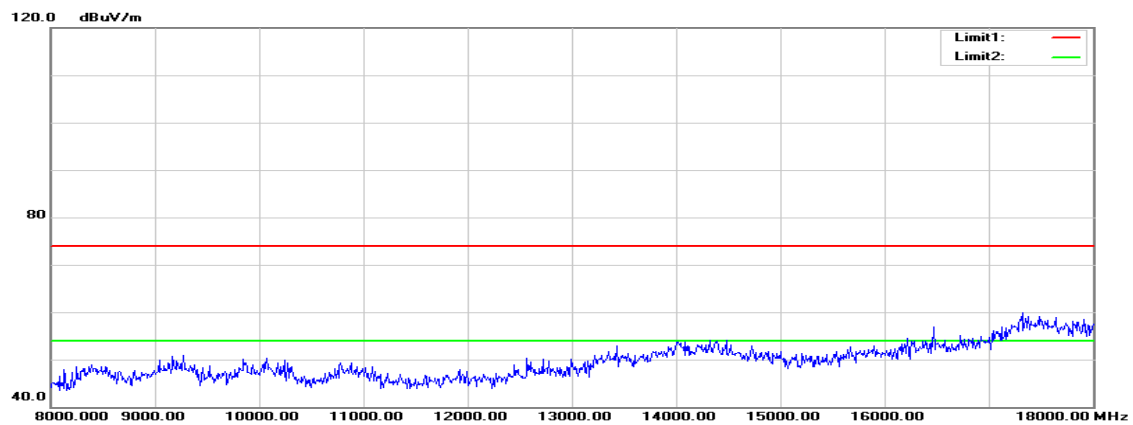
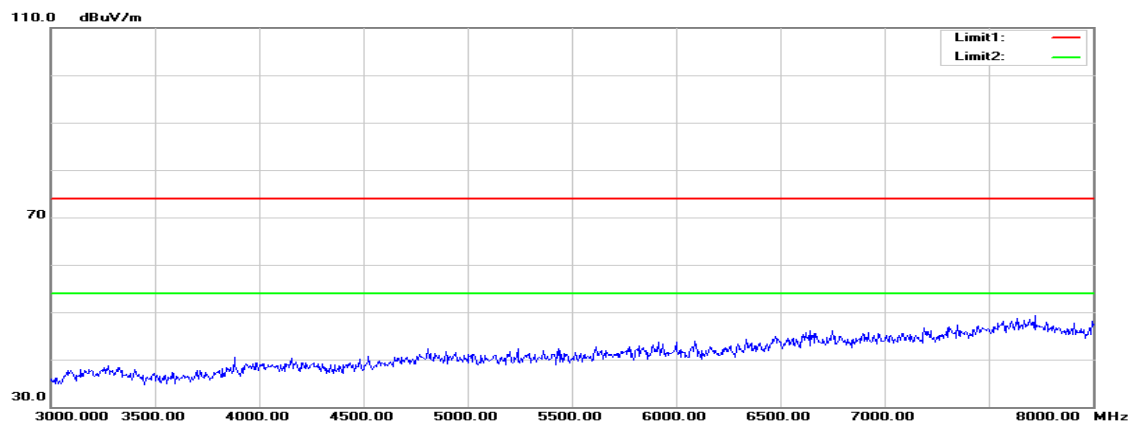
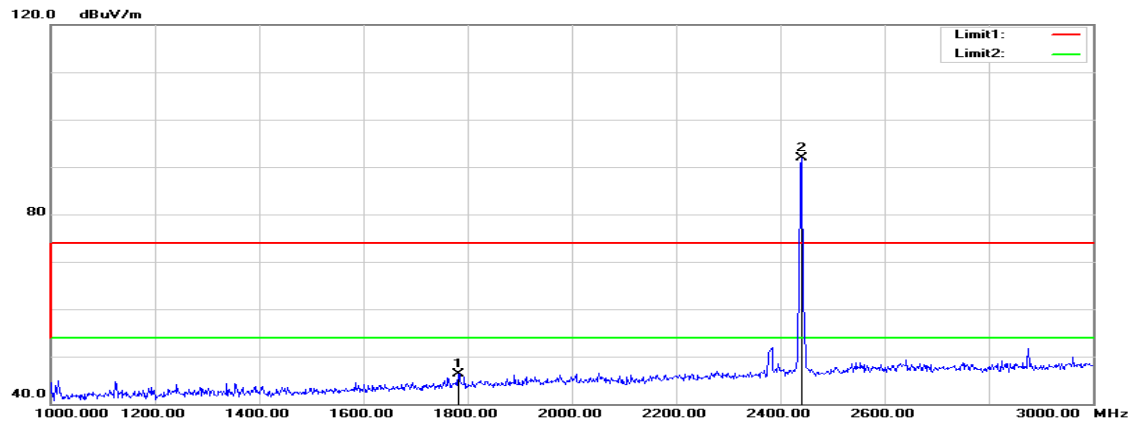

Operation Mode: Zigbee / TX / CH Mid

Test Date: August 18, 2015

Temperature: 27°C

Tested by: Jason Lu

Humidity: 53 % RH

Polarity: Ver. / Hor.

Frequency (MHz)	Reading (dBuV)	Correction (dB/m)	Result (dBuV/m)	Limit (dBuV/m)	Margin (dB)	Remark	Ant.Pol. (H/V)
1898.000	50.06	-4.13	45.93	74.00	-28.07	peak	V
3185.000	46.84	-0.16	46.68	74.00	-27.32	peak	V
N/A							
1782.000	51.01	-4.73	46.28	74.00	-27.72	peak	H
N/A							

Remark:

1. *Measuring frequencies from 1 GHz to the 10th harmonic of highest fundamental frequency.*
2. *Radiated emissions measured in frequency above 1000MHz were made with an instrument using peak/average detector mode.*
3. *Average test would be performed if the peak result were greater than the average limit or as required by the applicant.*
4. *Data of measurement within this frequency range shown “ --- ” in the table above means the reading of emissions are attenuated more than 20dB below the permissible limits or the field strength is too small to be measured.*
5. *Measurements above show only up to 6 maximum emissions noted, or would be lesser, with “ N/A ” remark, if no specific emissions from the EUT are recorded (ie: margin>20dB from the applicable limit) and considered that's already beyond the background noise floor.*
6. *Margin (dB) = Remark result (dBuV/m) – Average limit (dBuV/m).*

Zigbee / TX / CH High

Polarity: Vertical

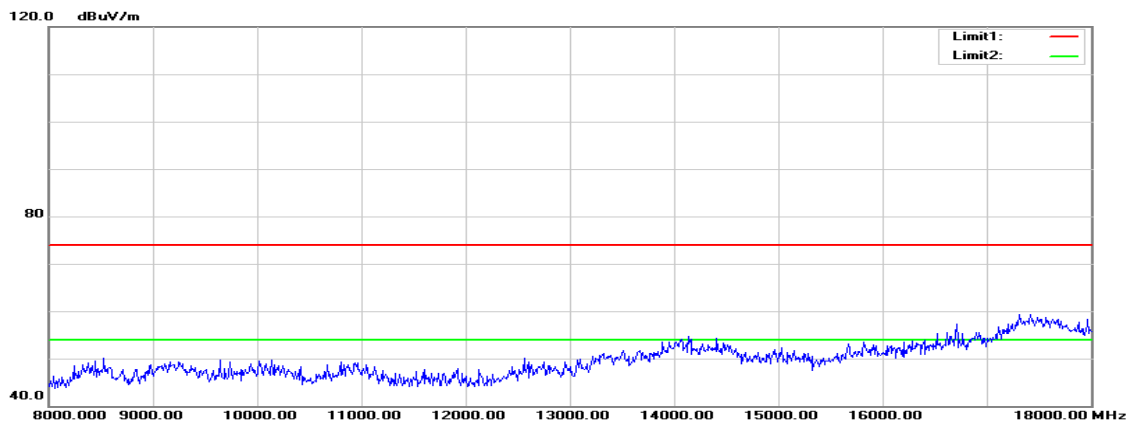
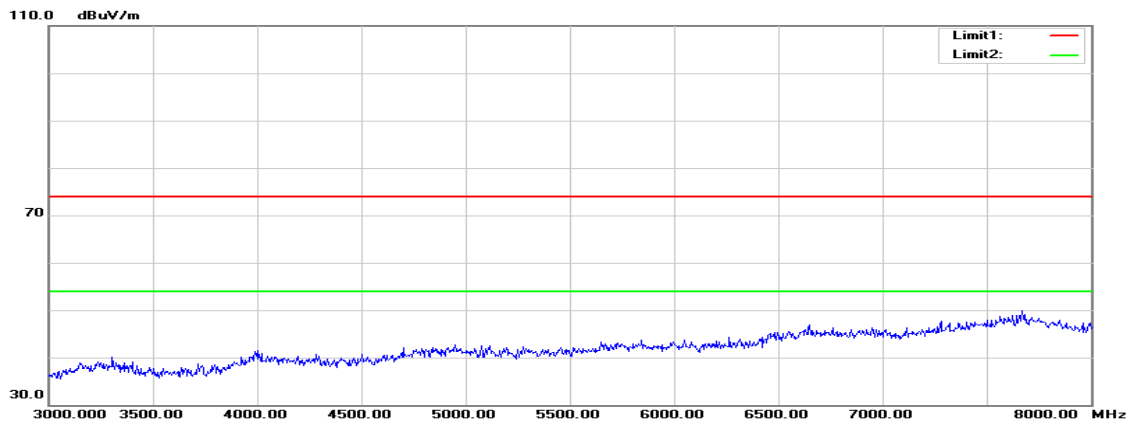
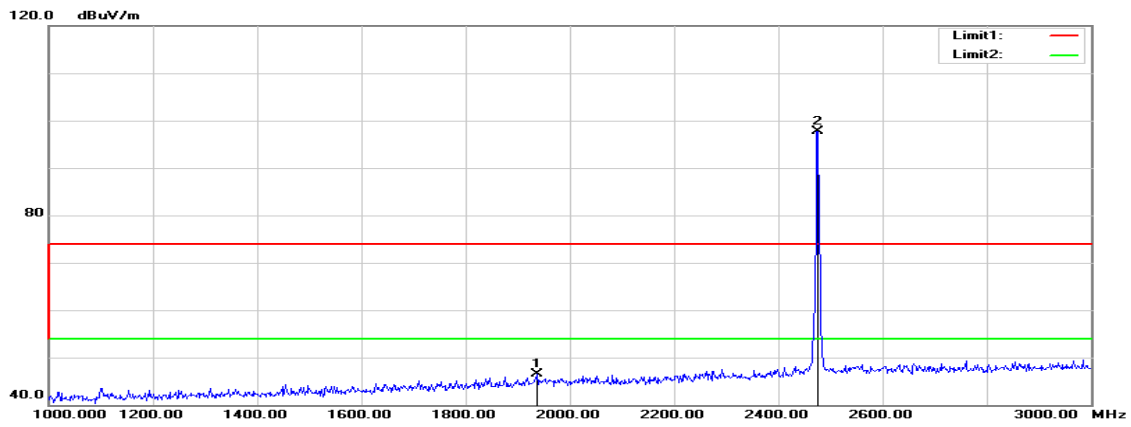

Polarity: Horizontal

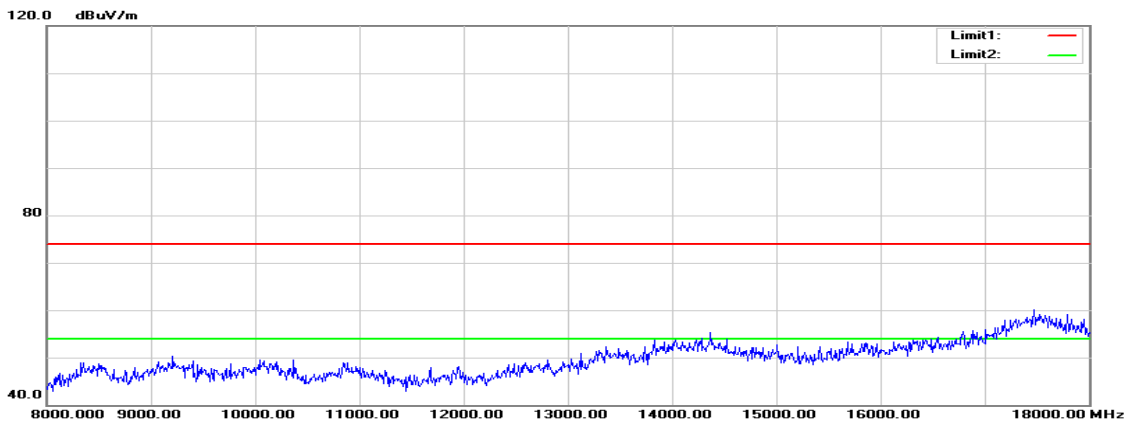
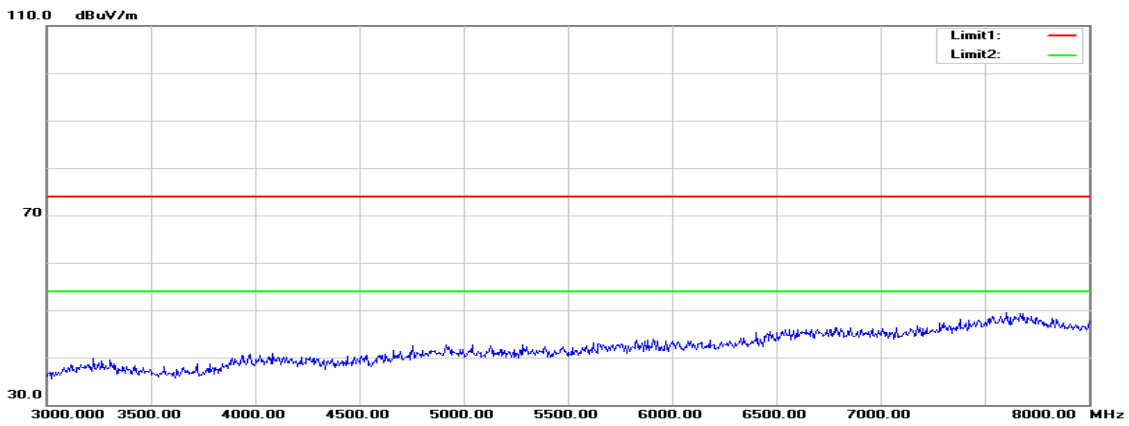
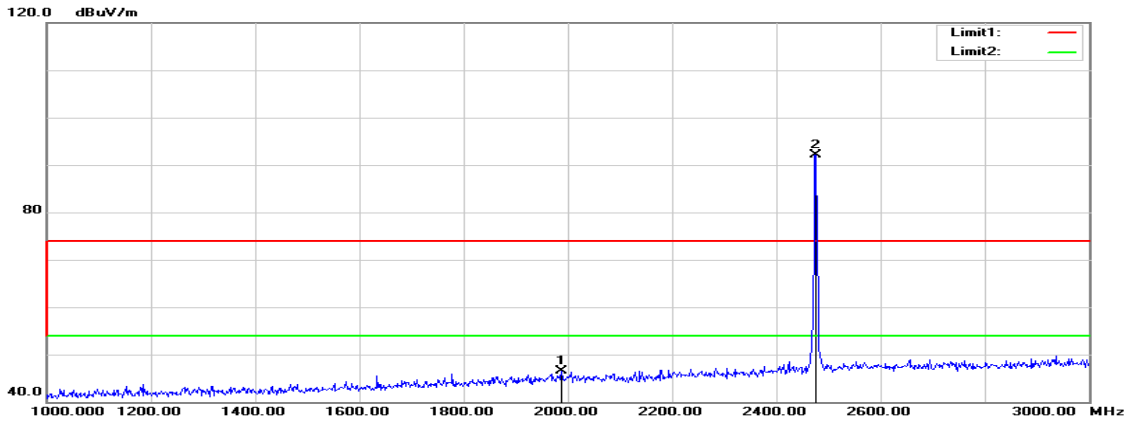

Operation Mode: Zigbee / TX / CH High

Test Date: August 18, 2015

Temperature: 27°C

Tested by: Jason Lu

Humidity: 53 % RH

Polarity: Ver. / Hor.

Frequency (MHz)	Reading (dBuV)	Correction (dB/m)	Result (dBuV/m)	Limit (dBuV/m)	Margin (dB)	Remark	Ant.Pol. (H/V)
1938.000	50.34	-3.92	46.42	74.00	-27.58	peak	V
N/A							
1988.000	50.23	-3.66	46.57	74.00	-27.43	peak	H
N/A							

Remark:

1. *Measuring frequencies from 1 GHz to the 10th harmonic of highest fundamental frequency.*
2. *Radiated emissions measured in frequency above 1000MHz were made with an instrument using peak/average detector mode.*
3. *Average test would be performed if the peak result were greater than the average limit or as required by the applicant.*
4. *Data of measurement within this frequency range shown “ --- ” in the table above means the reading of emissions are attenuated more than 20dB below the permissible limits or the field strength is too small to be measured.*
5. *Measurements above show only up to 6 maximum emissions noted, or would be lesser, with “ N/A ” remark, if no specific emissions from the EUT are recorded (ie: margin>20dB from the applicable limit) and considered that's already beyond the background noise floor.*
6. *Margin (dB) = Remark result (dBuV/m) – Average limit (dBuV/m).*

7.9 POWERLINE CONDUCTED EMISSIONS

LIMIT

According to §15.207(a) & RSS-Gen §7.2.4, except as shown in paragraphs (b) and (c) of this section, for an intentional radiator that is designed to be connected to the public utility (AC) power line, the radio frequency voltage that is conducted back onto the AC power line on any frequency or frequencies within the band 150 kHz to 30 MHz shall not exceed the limits in the following table, as measured using a 50 μ H/50 ohms line impedance stabilization network (LISN). Compliance with the provisions of this paragraph shall be based on the measurement of the radio frequency voltage between each power line and ground at the power terminal. The lower limit applies at the boundary between the frequency ranges.

Frequency Range (MHz)	Limits (dB μ V)	
	Quasi-peak	Average
0.15 to 0.50	66 to 56*	56 to 46*
0.50 to 5	56	46
5 to 30	60	50

Test Configuration

See test photographs attached in Appendix II for the actual connections between EUT and support equipment.

TEST PROCEDURE

1. The EUT was placed on a table, which is 0.8m above ground plane.
2. Maximum procedure was performed on the six highest emissions to ensure EUT compliance.
3. Repeat above procedures until all frequency measured were complete.

TEST RESULTS

The initial step in collecting conducted data is a spectrum analyzer peak scan of the measurement range. Significant peaks are then marked as shown on the following data page, and these signals are then quasi-peaked.

Test Data

Not applicable, because EUT not connect to AC Main Source direct.