

SAR Test Report

Product Name : 3M Pocket Projector

Model No. : MP180

Applicant : LITE-ON TECHNOLOGY CORP

Address : 22F, 392 RUEY KUANG RD NEIHU TAIPEI, 114 TAIWAN

Date of Receipt : 2010/09/20

Issued Date : 2010/12/30

Report No. : 109301R-HPUSP10V01

Report Version : V1.0

The test results relate only to the samples tested.

The test report shall not be reproduced except in full without the written approval of QuieTek Corporation.

Test Report Certification

Issued Date: 2010/12/30

Report No.:109301R-HPUSP10V01



Product Name : 3M Pocket Projector
 Applicant : LITE-ON TECHNOLOGY CORP
 Address : 22F, 392 RUEY KUANG RD NEIHU TAIPEI, 114 TAIWAN
 Manufacturer : 3M COMPANY PROJECTION SYSTEMS DEPT
 Model No. : MP180
 Trade Name : 3M
 FCC ID : PPQ-MP180
 Applicable Standard : FCC Oet65 Supplement C June 2001
 IEEE Std. 1528-2003 47CFR § 2.1093
 Test Result : Max. SAR Measurement (1g)
0.032 W/kg
 Application Type : Certification

The test results relate only to the samples tested.

The test report shall not be reproduced except in full without the written approval of Quietek Corporation.

Documented By : Anny Chou
 (Adm.Assistant / Anny Chou)

Tested By : Jung Chang
 (Engineer / Jung Chang)

Approved By : [Signature]
 (Manager / Vincent Lin)

TABLE OF CONTENTS

Description	Page
1. General Information	5
1.1 EUT Description	5
1.2 Antenna List	5
1.3 Test Environment	6
2. SAR Measurement System	7
2.1 DASY5 System Description	7
2.1.1 Applications	8
2.1.2 Area Scans.....	8
2.1.3 Zoom Scan (Cube Scan Averaging).....	8
2.1.4 Uncertainty of Inter-/Extrapolation and Averaging	8
2.2 DASY5 E-Field Probe	9
2.2.1 Isotropic E-Field Probe Specification	9
2.3 Boundary Detection Unit and Probe Mounting Device	10
2.4 DATA Acquisition Electronics (DAE) and Measurement Server	10
2.5 Robot.....	11
2.6 Light Beam Unit.....	11
2.7 Device Holder	12
2.8 SAM Twin Phantom	12
3. Tissue Simulating Liquid	13
3.1 The composition of the tissue simulating liquid	13
3.2 Tissue Calibration Result	13
3.3 Tissue Dielectric Parameters for Head and Body Phantoms	14
4. SAR Measurement Procedure	15
4.1 SAR System Validation.....	15
4.1.1 Validation Dipoles.....	15
4.1.2 Validation Result	15
4.2 SAR Measurement Procedure.....	16
5. SAR Exposure Limits	17
6. Test Equipment List	18
7. Measurement Uncertainty	19
8. Peak Conducted Power Measurement	20
9. Test Results	21
9.1 SAR Test Results Summary	21

Appendix

Appendix A. SAR System Validation Data

Appendix B. SAR measurement Data

Appendix C. Test Setup Photographs & EUT Photographs

Appendix D. Probe Calibration Data

Appendix E. Dipole Calibration Data

1. General Information

1.1 EUT Description

Product Name	3M Pocket Projector
Trade Name	3M
Model No.	MP180
FCC ID	PPQ-MP180
TX Frequency	2412MHz ~ 2462MHz
Number of Channel	11
Type of Modulation	DSSS/OFDM
WLAN Module	MFR: LITE-ON, M/N: WN4605R
Device Category	Portable
RF Exposure Environment	Uncontrolled
Max. Output Power (Conducted)	802.11b: 19.43 dBm 802.11g: 25.16 dBm 802.11n: 24.79 dBm

Note: Test Procedures are according to KDB 447498

1.2 Antenna List

No.	Manufacturer	Part No.	Type	Peak Gain
1	WIESON	GY196HT0220-012	PCB	3.10dBi for 2.4GHz

1.3 Test Environment

Ambient conditions in the laboratory:

Items	Required	Actual
Temperature (°C)	18-25	22.4 ±2
Humidity (%RH)	30-70	54

Site Description:

Accredited by TAF
 Accredited Number: 0914
 Effective through: December 12, 2011



Site Name: Quietek Corporation

Site Address: No. 5-22, Ruei-Shu Valley, Ruei-Ping Tsuen,
 Lin-Kou Shiang, Taipei,
 Taiwan, R.O.C.
 TEL : 886-2-8601-3788 / FAX : 886-2-8601-3789
 E-Mail : service@quietek.com

2. SAR Measurement System

2.1 DASY5 System Description

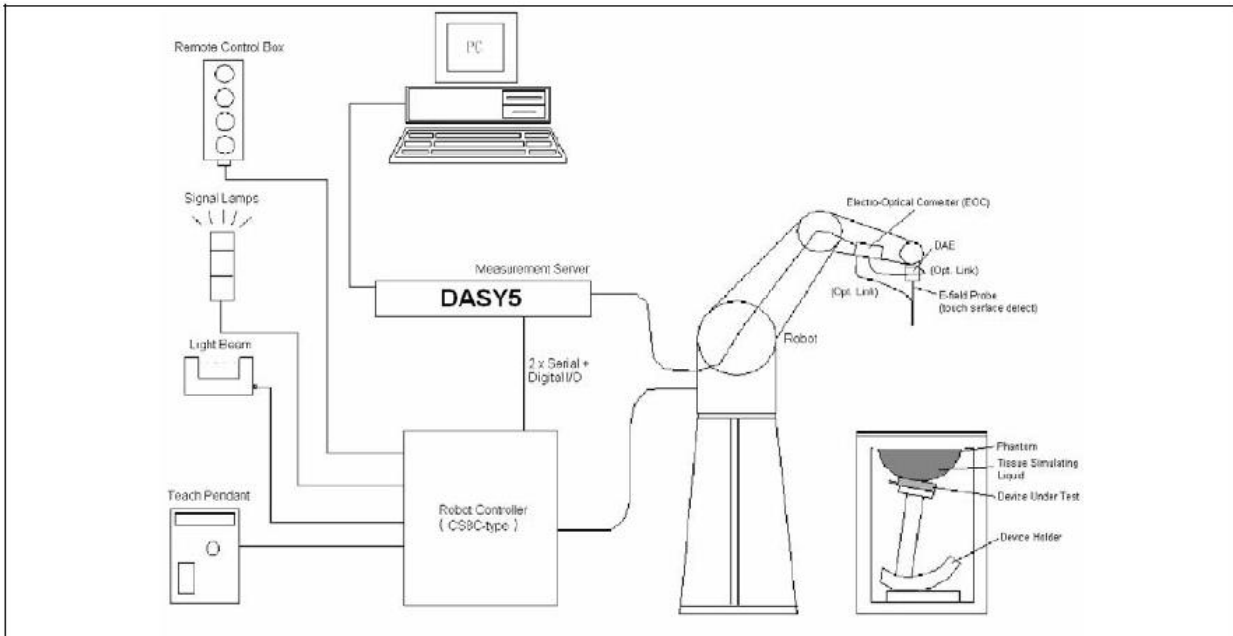

The DASY5 system for performing compliance tests consists of the following items:

- A standard high precision 6-axis robot with controller, teach pendant and software. An arm extension for accommodating the data acquisition electronics (DAE).
- A data acquisition electronics (DAE) which performs the signal amplification, signal multiplexing, AD-conversion, offset measurements, mechanical surface detection, collision detection, etc. The unit is battery powered with standard or rechargeable batteries. The signal is optically transmitted to the EOC.
- The Electro-optical converter (EOC) performs the conversion from optical to electrical signals for the digital communication to the DAE. To use optical surface detection, a special version of the EOC is required. The EOC signal is transmitted to the measurement server.
- The Light Beam used is for probe alignment. This improves the (absolute) accuracy of the probe positioning.
- A computer running WinXP and the DASY5 software.
- Remote control and teach pendant as well as additional circuitry for robot safety such as warning lamps, etc.
- The phantom, the device holder and other accessories according to the targeted measurement.

2.1.1 Applications

Predefined procedures and evaluations for automated compliance testing with all worldwide standards, e.g., IEEE 1528, OET 65, IEC 62209-1, IEC 62209-2, EN 50360, EN 50383 and others.

2.1.2 Area Scans

Area scans are defined prior to the measurement process being executed with a user defined variable spacing between each measurement point (integral) allowing low uncertainty measurements to be conducted. Scans defined for FCC applications utilize a 10mm² step integral, with 1mm interpolation used to locate the peak SAR area used for zoom scan assessments.

When an Area Scan has measured all reachable points, it computes the field maxima found in the scanned area, within a range of the global maximum. The range (in dB) is specified in the standards for compliance testing. For example, a 2 dB range is required in IEEE 1528-2003, EN 50361 and IEC 62209 standards, whereby 3 dB is a requirement when compliance is assessed in accordance with the ARIB standard (Japan).

2.1.3 Zoom Scan (Cube Scan Averaging)

Zoom Scans are used to assess the peak spatial SAR values within a cubic averaging volume containing 1 g and 10 g of simulated tissue. A density of 1000 kg/m³ is used to represent the head and body tissue density and not the phantom liquid density, in order to be consistent with the definition of the liquid dielectric properties, i.e. the side length of the 1 g cube is 10mm, with the side length of the 10 g cube 21,5mm.

The zoom scan integer steps can be user defined so as to reduce uncertainty, but normal practice for typical test applications (including FCC) utilize a physical step of 5x5x7 (8mmx8mmx5mm) providing a volume of 32mm in the X & Y axis, and 30mm in the Z axis.

2.1.4 Uncertainty of Inter-/Extrapolation and Averaging

In order to evaluate the uncertainty of the interpolation, extrapolation and averaged SAR calculation algorithms of the Postprocessor, DASY5 allows the generation of measurement grids which are artificially predefined by analytically based test functions. Therefore, the grids of area scans and zoom scans can be filled with uncertainty test data, according to the SAR benchmark functions of IEEE 1528. The three analytical functions shown in equations as below are used to describe the possible range of the expected SAR distributions for the tested handsets. The field gradients are covered by the spatially flat

distribution f1, the spatially steep distribution f3 and f2 accounts for H-field cancellation on the phantom/tissue surface.

$$f_1(x, y, z) = Ae^{-\frac{z}{2a}} \cos^2 \left(\frac{\pi \sqrt{x'^2 + y'^2}}{2 \cdot 5a} \right)$$

$$f_2(x, y, z) = Ae^{-\frac{z}{a}} \frac{a^2}{a^2 + x'^2} \left(3 - e^{-\frac{2z}{a}} \right) \cos^2 \left(\frac{\pi y'}{2 \cdot 3a} \right)$$

$$f_3(x, y, z) = A \frac{a^2}{\frac{a^2}{4} + x'^2 + y'^2} \left(e^{-\frac{2z}{a}} + \frac{a^2}{2(a + 2z)^2} \right)$$

2.2 DASY5 E-Field Probe

The SAR measurement is conducted with the dosimetric probe manufactured by SPEAG. The probe is specially designed and calibrated for use in liquid with high permittivity. The dosimetric probe has special calibration in liquid at different frequency. SPEAG conducts the probe calibration in compliance with international and national standards (e.g. IEEE 1528, EN 62209-1, IEC 62209, etc.) under ISO 17025. The calibration data are in Appendix D.

2.2.1 Isotropic E-Field Probe Specification

Model	Ex3DV4	
Construction	Symmetrical design with triangular core Built-in shielding against static charges PEEK enclosure material (resistant to organic solvents, e.g., DGBE)	
Frequency	10 MHz to 6 GHz Linearity: ± 0.2 dB (30 MHz to 6 GHz)	
Directivity	± 0.3 dB in HSL (rotation around probe axis) ± 0.5 dB in tissue material (rotation normal to probe axis)	
Dynamic Range	10 µW/g to 100 mW/g Linearity: ± 0.2 dB (noise: typically < 1 µW/g)	
Dimensions	Overall length: 330 mm (Tip: 20 mm) Tip diameter: 2.5 mm (Body: 12 mm) Typical distance from probe tip to dipole centers: 1 mm	
Application	High precision dosimetric measurements in any exposure scenario (e.g., very strong gradient fields). Only probe which enables compliance testing for frequencies up to 6 GHz with precision of better 30%.	

2.3 Boundary Detection Unit and Probe Mounting Device

The DASY probes use a precise connector and an additional holder for the probe, consisting of a plastic tube and a flexible silicon ring to center the probe. The connector at the DAE is flexibly mounted and held in the default position with magnets and springs. Two switching systems in the connector mount detect frontal and lateral probe collisions and trigger the necessary software response.



2.4 DATA Acquisition Electronics (DAE) and Measurement Server

The data acquisition electronics (DAE) consists of a highly sensitive electrometer-grade preamplifier with auto-zeroing, a channel and gain-switching multiplexer, a fast 16 bit AD-converter and a command decoder and control logic unit.

Transmission to the measurement server is accomplished through an optical downlink for data and status information as well as an optical uplink for commands and the clock.

The input impedance of the DAE4 is 200M Ohm; the inputs are symmetrical and floating. Common mode rejection is above 80dB.



The DASY5 measurement server is based on a PC/104 CPU board with a 400MHz intel ULV Celeron, 128MB chipdisk and 128MB RAM. The necessary circuits for communication with the DAE electronics box, as well as the 16 bit AD converter system for optical detection and digital I/O interface are contained on the DASY5 I/O board, which is directly connected to the PC/104 bus of the CPU board.



2.5 Robot

The DASY5 system uses the high precision robots TX90 XL type out of the newer series from Stäubli SA (France). For the 6-axis controller DASY5 system, the CS8C robot controller version from Stäubli is used.

The XL robot series have many features that are important for our application:

- High precision (repeatability 0.02 mm)
- High reliability (industrial design)
- Jerk-free straight movements
- Low ELF interference (the closed metallic construction shields against motor control fields)
- 6-axis controller



2.6 Light Beam Unit

The light beam switch allows automatic "tooling" of the probe. During the process, the actual position of the probe tip with respect to the robot arm is measured, as well as the probe length and the horizontal probe offset. The software then corrects all movements, such that the robot coordinates are valid for the probe tip.

The repeatability of this process is better than 0.1 mm. If a position has been taught with an aligned probe, the same position will be reached with another aligned probe within 0.1 mm, even if the other probe has different dimensions. During probe rotations, the probe tip will keep its actual position.



2.7 Device Holder

The DASY5 device holder is designed to cope with different positions given in the standard. It has two scales for the device rotation (with respect to the body axis) and the device inclination (with respect to the line between the ear reference points). The rotation center for both scales is the ear reference point (EPR).

Thus the device needs no repositioning when changing the angles.

The DASY5 device holder has been made out of low-loss POM material having the following dielectric parameters: relative permittivity $\epsilon_r = 3$ and loss tangent $\delta = 0.02$. The amount of dielectric material has been reduced in the closest vicinity of the device, since measurements have suggested that the influence of the clamp on the test results could thus be lowered.



2.8 SAM Twin Phantom

The SAM twin phantom is a fiberglass shell phantom with 2mm shell thickness (except the ear region where shell thickness increases to 6mm). It has three measurement areas:

- Left head
- Right head
- Flat phantom



The bottom plate contains three pair of bolts for locking the device holder. The device holder positions are adjusted to the standard measurement positions in the three sections. A white cover is provided to tap the phantom during off-periods to prevent water evaporation and changes in the liquid parameters. On the phantom top, three reference markers are provided to identify the phantom position with respect to the robot.

3. Tissue Simulating Liquid

3.1 The composition of the tissue simulating liquid

INGREDIENT (% Weight)	900MHz Head	1800MHz Head	2450MHz Head	2450MHz Body
Water	--	--	--	73.2
Salt	--	--	--	0.04
Sugar	--	--	--	0.00
HEC	--	--	--	0.00
Preventol	--	--	--	0.00
DGBE	--	--	--	26.7

3.2 Tissue Calibration Result

The dielectric parameters of the liquids were verified prior to the SAR evaluation using APREL Dielectric Probe Kit and Anritsu MS4623B Vector Network Analyzer.

Body Tissue Simulant Measurement				
Frequency [MHz]	Description	Dielectric Parameters		Tissue Temp. [°C]
		ϵ_r	σ [s/m]	
2450MHz	Reference result ± 5% window	52.7 50.065 to 55.335	1.95 1.8525 to 2.0475	N/A
	29-Dec-10	52.51	1.94	21.6
2412 MHz	Low channel	53.26	1.90	21.6
2437 MHz	Mid channel	52.73	1.93	21.6
2462 MHz	High channel	52.27	1.95	21.6

3.3 Tissue Dielectric Parameters for Head and Body Phantoms

The head tissue dielectric parameters recommended by the IEEE SCC-34/SC-2 in P1528 have been incorporated in the following table. These head parameters are derived from planar layer models simulating the highest expected SAR for the dielectric properties and tissue thickness variations in a human head. Other head and body tissue parameters that have not been specified in P1528 are derived from the tissue dielectric parameters computed from the 4-Cole-Cole equations described in Reference [12] and extrapolated according to the head parameters specified in P1528.

Target Frequency (MHz)	Head		Body	
	ϵ_r	σ (S/m)	ϵ_r	σ (S/m)
150	52.3	0.76	61.9	0.80
300	45.3	0.87	58.2	0.92
450	43.5	0.87	56.7	0.94
835	41.5	0.90	55.2	0.97
900	41.5	0.97	55.0	1.05
915	41.5	0.98	55.0	1.06
1450	40.5	1.20	54.0	1.30
1610	40.3	1.29	53.8	1.40
1800 – 2000	40.0	1.40	53.3	1.52
2450	39.2	1.80	52.7	1.95
3000	38.5	2.40	52.0	2.73
5800	35.3	5.27	48.2	6.00

(ϵ_r = relative permittivity, σ = conductivity and $\rho = 1000 \text{ kg/m}^3$)

4. SAR Measurement Procedure

4.1 SAR System Validation

4.1.1 Validation Dipoles

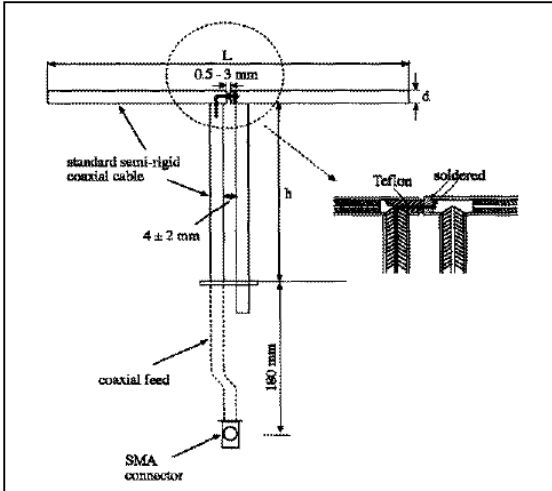

The dipoles used is based on the IEEE-1528 standard, and is complied with mechanical and electrical specifications in line with the requirements of both IEEE and FCC Supplement C. the table below provides details for the mechanical and electrical specifications for the dipoles.

Frequency	L (mm)	h (mm)	d (mm)
2450MHz	53.5	30.4	3.6

4.1.2 Validation Result

System Performance Check at 2450MHz				
Validation Kit: ASL-D-2450				
Frequency [MHz]	Description	SAR [w/kg] 1g	SAR [w/kg] 10g	Tissue Temp. [°C]
2450 MHz	Reference result ± 10% window	52 46.8 to 57.2	24.4 21.96 to 26.84	N/A
	29-Dec-10	55.2	25.6	21.6

Note: (1) All SAR values are normalized to 1W forward power.
 (2) The power level is used 250mW

4.2 SAR Measurement Procedure

(Test Procedures are according to KDB 447498)

The ALSAS-10U calculates SAR using the following equation,

$$SAR = \frac{\sigma |E|^2}{\rho}$$

σ : represents the simulated tissue conductivity

ρ : represents the tissue density

The EUT is set to transmit at the required power in line with product specification, at each frequency relating to the LOW, MID, and HIGH channel settings.

Pre-scans are made on the device to establish the location for the transmitting antenna, using a large area scan in either air or tissue simulation fluid.

The EUT is placed against the Universal Phantom where the maximum area scan dimensions are larger than the physical size of the resonating antenna. When the scan size is not large enough to cover the peak SAR distribution, it is modified by either extending the area scan size in both the X and Y directions, or the device is shifted within the predefined area.

The area scan is then run to establish the peak SAR location (interpolated resolution set at 1mm²)which is then used to orient the center of the zoom scan. The zoom scan is then executed and the 1g and 10g averages are derived from the zoom scan volume (interpolated resolution set at 1mm³).

5. SAR Exposure Limits

SAR assessments have been made in line with the requirements of IEEE-1528, FCC Supplement C, and comply with ANSI/IEEE C95.1-1992 “Uncontrolled Environments” limits. These limits apply to a location which is deemed as “Uncontrolled Environment” which can be described as a situation where the general public may be exposed to an RF source with no prior knowledge or control over their exposure.

Limits for General Population/Uncontrolled Exposure (W/kg)

Type Exposure	Uncontrolled Environment Limit
Spatial Peak SAR (1g cube tissue for brain or body)	1.60 W/kg
Spatial Average SAR (whole body)	0.08 W/kg
Spatial Peak SAR (10g for hands, feet, ankles and wrist)	4.00 W/kg

6. Test Equipment List

Instrument	Manufacturer	Model No.	Serial No.	Last Calibration	Next Calibration
Stäubli Robot TX60L	Stäubli	TX60L	F09/5BL1A1/A06	May. 2009	only once
Controller	Speag	CS8c	N/A	May. 2009	only once
Aprél Reference Dipole 2450Mhz	Aprél	ALS-D-2450	QTK-319	May. 2010	May. 2012
SAM Twin Phantom	Speag	QD000 P40 CA	Tp 1515	N/A	N/A
Device Holder	Speag	N/A	N/A	N/A	N/A
Data Acquisition Electronic	Speag	DAE4	1207	Apr. 2010	Apr. 2011
E-Field Probe	Speag	EX3DV4	3698	July. 2010	July. 2011
SAR Software	Speag	DASY52	V52.2 Build 0	N/A	N/A
Aprél Dipole Spaccer	Aprél	ALS-DS-U	QTK-295	N/A	N/A
Power Amplifier	Mini-Circuit	ZHL-42	D051404-20	N/A	N/A
Directional Coupler	Agilent	778D-012	50550	N/A	N/A
Universal RadioCommunication Tester	R&S	CMU 200	104846	May. 2010	May. 2011
Vector Network	Anritsu	MS4623B	992801	Aug. 2010	Aug. 2011
Signal Generator	Anritsu	MG3692A	042319	Jun. 2010	Jun. 2011
Power Meter	Anritsu	ML2487A	6K00001447	Apr. 2010	Apr. 2011
Wide Bandwidth Sensor	Anritsu	MA2491	030677	Apr. 2010	Apr. 2011

7. Measurement Uncertainty

Uncertainty								
Error Description	Uncertainty value	Prob. Dist.	Div.	(c _i) 1g	(c _i) 10g	Std. Unc. (1g)	Std. Unc. (10g)	(v _i) v _{eff}
Measurement System								
Probe Calibration	±5.9 %	N	1	1	1	±5.9 %	±5.9 %	∞
Axial Isotropy	±4.7 %	R	√3	0.7	0.7	±1.9 %	±1.9 %	∞
Hemispherical Isotropy	±9.6 %	R	√3	0.7	0.7	±3.9 %	±3.9 %	∞
Boundary Effects	±1.0 %	R	√3	1	1	±0.6 %	±0.6 %	∞
Linearity	±4.7 %	R	√3	1	1	±2.7 %	±2.7 %	∞
System Detection Limits	±1.0 %	R	√3	1	1	±0.6 %	±0.6 %	∞
Readout Electronics	±0.3 %	N	1	1	1	±0.3 %	±0.3 %	∞
Response Time	±0.8 %	R	√3	1	1	±0.5 %	±0.5 %	∞
Integration Time	±2.6 %	R	√3	1	1	±1.5 %	±1.5 %	∞
RF Ambient Noise	±3.0 %	R	√3	1	1	±1.7 %	±1.7 %	∞
RF Ambient Reflections	±3.0 %	R	√3	1	1	±1.7 %	±1.7 %	∞
Probe Positioner	±0.4 %	R	√3	1	1	±0.2 %	±0.2 %	∞
Probe Positioning	±2.9 %	R	√3	1	1	±1.7 %	±1.7 %	∞
Max. SAR Eval.	±1.0 %	R	√3	1	1	±0.6 %	±0.6 %	∞
Test Sample Related								
Device Positioning	±2.9 %	N	1	1	1	±2.9 %	±2.9 %	145
Device Holder	±3.6 %	N	1	1	1	±3.6 %	±3.6 %	5
Power Drift	±5.0 %	R	√3	1	1	±2.9 %	±2.9 %	∞
Phantom and Setup								
Phantom Uncertainty	±4.0 %	R	√3	1	1	±2.3 %	±2.3 %	∞
Liquid Conductivity (target)	±5.0 %	R	√3	0.64	0.43	±1.8 %	±1.2 %	∞
Liquid Conductivity (meas.)	±2.5 %	N	1	0.64	0.43	±1.6 %	±1.1 %	∞
Liquid Permittivity (target)	±5.0 %	R	√3	0.6	0.49	±1.7 %	±1.4 %	∞
Liquid Permittivity (meas.)	±2.5 %	N	1	0.6	0.49	±1.5 %	±1.2 %	∞
Combined Std. Uncertainty						±10.9 %	±10.7 %	387
Expanded STD Uncertainty						±21.9 %	±21.4 %	

8. Conducted Power Measurement

802.11 b

Channel	Frequency (MHz)	Average Output Power (dBm)	Peak Output Power (dB)
1	2412	16.98	19.26
6	2437	17.03	19.43
11	2462	16.90	19.12

802.11 g;

Channel	Frequency (MHz)	Average Output Power (dBm)	Peak Output Power (dB)
1	2412	16.02	25.14
6	2437	16.15	25.16
11	2462	16.05	24.86

802.11n-20M

Channel	Frequency (MHz)	Average Output Power (dBm)	Peak Output Power (dB)
1	2412	16.06	24.62
6	2437	16.15	23.71
11	2462	16.05	24.45

802.11n-40M

Channel	Frequency (MHz)	Average Output Power (dBm)	Peak Output Power (dB)
3	2422	16.16	24.48
6	2437	16.32	24.79
9	2452	16.29	24.68

9. Test Results

9.1 SAR Test Results Summary

SAR MEASUREMENT						
Ambient Temperature (°C) : 22.4 ±2				Relative Humidity (%) : 54		
Liquid Temperature (°C) : 21.6 ±2				Depth of Liquid (cm) : >15		
Product: 3M Pocket Projector						
Test Mode: 802.11g						
Test Position Body	Antenna Position	Frequency		Conducted Power (dBm)	SAR 1g (W/kg)	Limit (W/kg)
		Channel	MHz			
Front	Fixed	6	2437	16.15	0.022	1.6
Test Mode: 802.11b						
Front	Fixed	1	2412	16.98	0.023	1.6
Front	Fixed	6	2437	17.03	0.032	1.6
Front	Fixed	11	2462	16.90	0.015	1.6
Back	Fixed	6	2437	17.03	0.00193	1.6
L-Side	Fixed	6	2437	17.03	0.00861	1.6
R-Side	Fixed	6	2437	17.03	0.014	1.6
Bottom	Fixed	6	2437	17.03	0.027	1.6
Test Mode: 802.11n (20M)						
Front	Fixed	6	2437	16.15	0.013	1.6
Test Mode: 802.11n (40M)						
Front	Fixed	6	2437	16.32	0.015	1.6

Appendix**Appendix A. SAR System Validation Data****Appendix B. SAR measurement Data****Appendix C. Test Setup Photographs & EUT Photographs****Appendix D. Probe Calibration Data****Appendix E. Dipole Calibration Data**

Appendix A. SAR System Validation Data

Date/Time: 12/29/2010

Test Laboratory: QuieTek

System Performance Check_2450MHz-Body

DUT: Dipole 2450 MHz; Type: ALS-D-2450-S-2; Serial: QTK-319

Communication System: CW; Frequency: 2450 MHz; Communication System PAR: 0 dB

Medium parameters used: $f = 2450 \text{ MHz}$; $\sigma = 1.9 \text{ mho/m}$; $\epsilon_r = 52.5$; $\rho = 1000 \text{ kg/m}^3$

Phantom section: Flat Section

Ambient Temperature ($^{\circ}\text{C}$) : 22.4, Liquid Temperature ($^{\circ}\text{C}$) : 21.6

Measurement Standard: DASYS (IEEE/IEC/ANSI C63.19-2007)

DASY5 Configuration:

- Probe: EX3DV4 - SN3698; ConvF(7.01, 7.01, 7.01); Calibrated: 7/19/2010
- Sensor-Surface: 2mm (Mechanical Surface Detection)
- Electronics: DAE4 Sn1207; Calibrated: 4/26/2010
- Phantom: SAM with right table; Type: SAM
- Measurement SW: DASYS52, V52.2 Build 0; Postprocessing SW: SEMCAD X, V14.2 Build 2Version 14.2.2 (1674) (Deployment Build)

Configuration/2450MHz_Body/Area Scan (7x7x1): Measurement grid: $dx=15\text{mm}$, $dy=15\text{mm}$

Maximum value of SAR (measured) = 20.3 mW/g

Configuration/2450MHz_Body/Zoom Scan (7x7x7) (5x5x7)/Cube 0:

Measurement grid: $dx=8\text{mm}$, $dy=8\text{mm}$, $dz=5\text{mm}$

Reference Value = 107.7 V/m; Power Drift = -0.075 dB

Peak SAR (extrapolated) = 28.3 W/kg

SAR(1 g) = 13.8 mW/g; SAR(10 g) = 6.4 mW/g

Maximum value of SAR (measured) = 21.3 mW/g

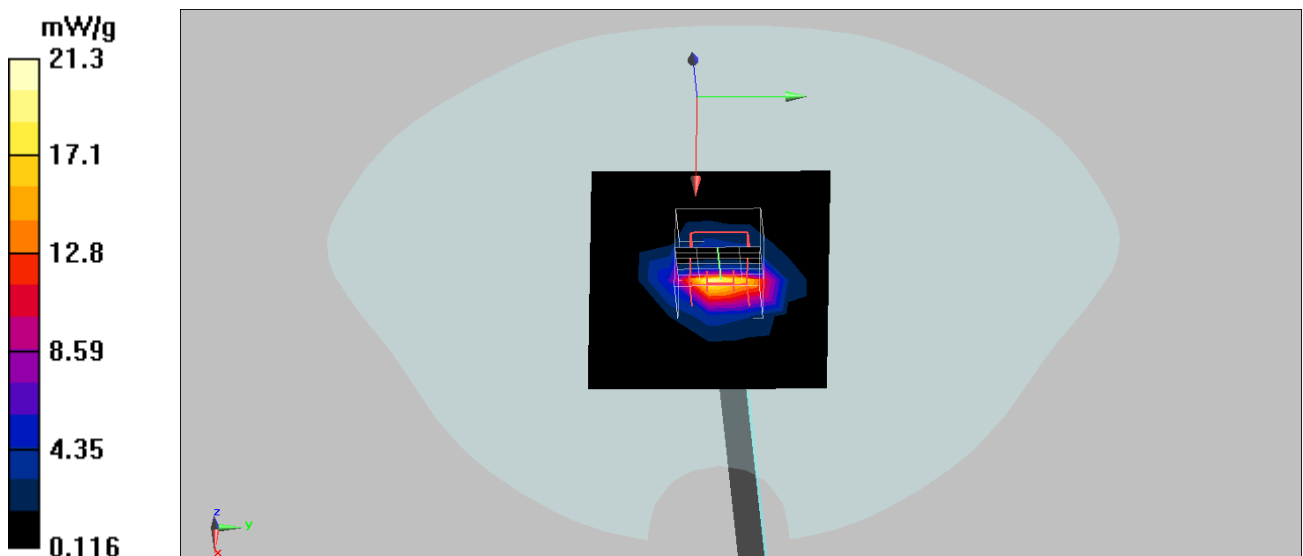

Appendix B. SAR measurement Data

Date/Time: 12/29/2010

Test Laboratory: QuieTek

802.11g_6 Front

DUT: 3M Pocket Projector; Type: MP180

Communication System: 802.11g; Frequency: 2437 MHz; Communication System PAR: 0 dB
 Medium parameters used: $f = 2437 \text{ MHz}$; $\sigma = 1.93 \text{ mho/m}$; $\epsilon_r = 52.7$; $\rho = 1000 \text{ kg/m}^3$
 Phantom section: Flat Section
 Measurement Standard: DASYS (IEEE/IEC/ANSI C63.19-2007)
 DASYS Configuration:

- Probe: EX3DV4 - SN3698; ConvF(7.01, 7.01, 7.01); Calibrated: 7/19/2010
- Sensor-Surface: 4mm (Mechanical Surface Detection)
- Electronics: DAE4 Sn1207; Calibrated: 4/26/2010
- Phantom: SAM with right table; Type: SAM;
- Measurement SW: DASYS2, V52.2 Build 0; Postprocessing SW: SEMCAD X, V14.2 Build 2 Version 14.2.2 (1674) (Deployment Build)

Configuration/Body/Area Scan (8x8x1): Measurement grid: $dx=13\text{mm}$, $dy=13\text{mm}$
 Maximum value of SAR (measured) = 0.025 mW/g

Configuration/Body/Zoom Scan (7x7x7) (7x7x7)/Cube 0: Measurement grid:
 $dx=5\text{mm}$, $dy=5\text{mm}$, $dz=5\text{mm}$
 Reference Value = 3.23 V/m; Power Drift = 0.171 dB
 Peak SAR (extrapolated) = 0.041 W/kg
SAR(1 g) = 0.022 mW/g; SAR(10 g) = 0.013 mW/g
 Maximum value of SAR (measured) = 0.024 mW/g

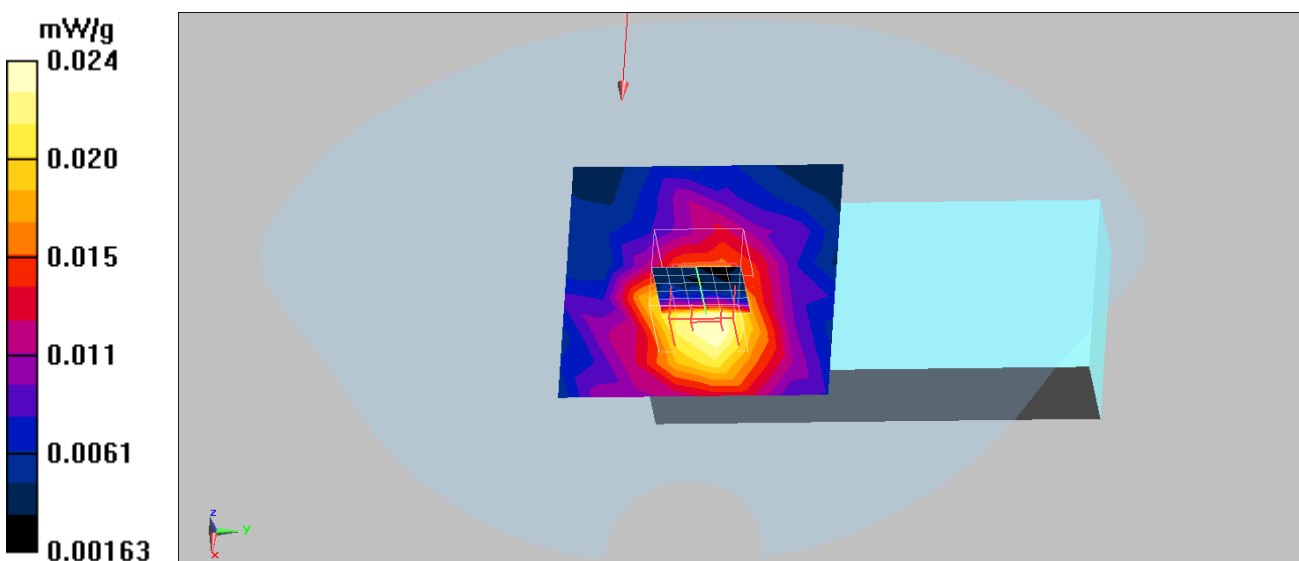

Date/Time: 12/29/2010

Test Laboratory: QuieTek

802.11b_1 Front

DUT: 3M Pocket Projector; Type: MP180

Communication System: 802.11b; Frequency: 2412 MHz; Communication System PAR: 0 dB
 Medium parameters used: $f = 2412 \text{ MHz}$; $\sigma = 1.9 \text{ mho/m}$; $\epsilon_r = 53.3$; $\rho = 1000 \text{ kg/m}^3$

Phantom section: Flat Section

Measurement Standard: DASYS (IEEE/IEC/ANSI C63.19-2007)

DASY5 Configuration:

- Probe: EX3DV4 - SN3698; ConvF(7.01, 7.01, 7.01); Calibrated: 7/19/2010
- Sensor-Surface: 4mm (Mechanical Surface Detection)
- Electronics: DAE4 Sn1207; Calibrated: 4/26/2010
- Phantom: SAM with right table; Type: SAM;
- Measurement SW: DASY52, V52.2 Build 0; Postprocessing SW: SEMCAD X, V14.2 Build 2Version 14.2.2 (1674) (Deployment Build)

Configuration/Body/Area Scan (8x8x1): Measurement grid: $dx=13\text{mm}$, $dy=13\text{mm}$
 Maximum value of SAR (measured) = 0.026 mW/g

Configuration/Body/Zoom Scan (7x7x7) (7x7x7)/Cube 0: Measurement grid:
 $dx=5\text{mm}$, $dy=5\text{mm}$, $dz=5\text{mm}$
 Reference Value = 3.67 V/m; Power Drift = -0.083 dB
 Peak SAR (extrapolated) = 0.039 W/kg
SAR(1 g) = 0.023 mW/g; SAR(10 g) = 0.014 mW/g

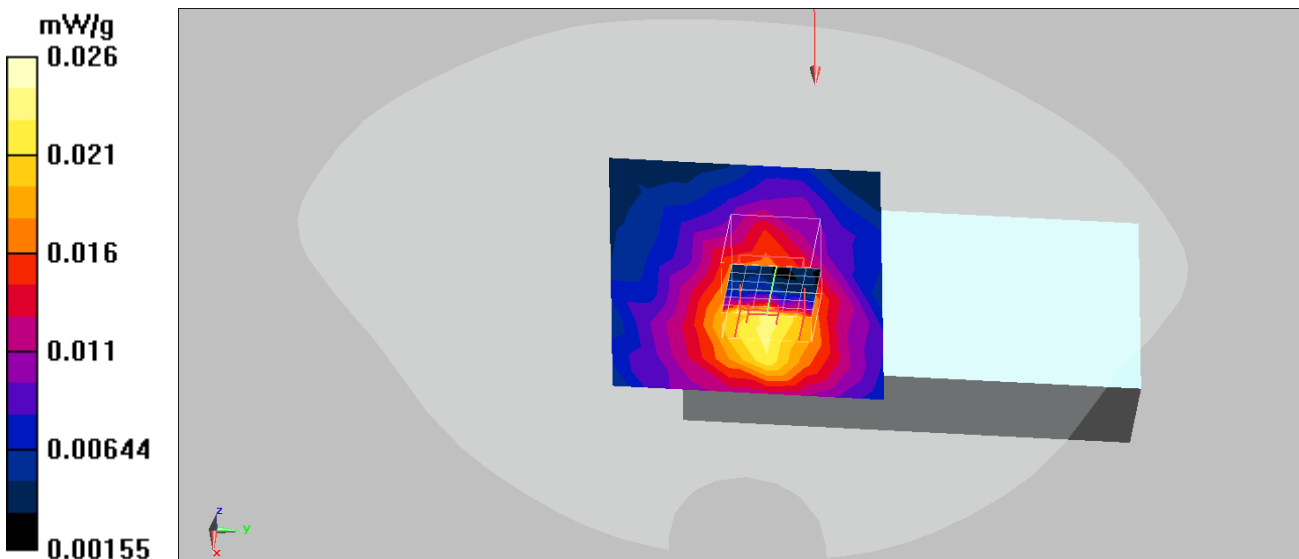

Date/Time: 12/29/2010

Test Laboratory: QuieTek

802.11b_6 Front

DUT: 3M Pocket Projector; Type: MP180

Communication System: 802.11b; Frequency: 2437 MHz; Communication System PAR: 0 dB
 Medium parameters used: $f = 2437$ MHz; $\sigma = 1.93$ mho/m; $\epsilon_r = 52.7$; $\rho = 1000$ kg/m³
 Phantom section: Flat Section
 Measurement Standard: DASYS (IEEE/IEC/ANSI C63.19-2007)

DASY5 Configuration:

- Probe: EX3DV4 - SN3698; ConvF(7.01, 7.01, 7.01); Calibrated: 7/19/2010
- Sensor-Surface: 4mm (Mechanical Surface Detection)
- Electronics: DAE4 Sn1207; Calibrated: 4/26/2010
- Phantom: SAM with right table; Type: SAM;
- Measurement SW: DASY52, V52.2 Build 0; Postprocessing SW: SEMCAD X, V14.2 Build 2Version 14.2.2 (1674) (Deployment Build)

Configuration/Body/Area Scan (8x8x1): Measurement grid: dx=13mm, dy=13mm
 Maximum value of SAR (measured) = 0.036 mW/g

Configuration/Body/Zoom Scan (7x7x7) (7x7x7)/Cube 0: Measurement grid: dx=5mm, dy=5mm, dz=5mm
 Reference Value = 3.95 V/m; Power Drift = 0.053 dB
 Peak SAR (extrapolated) = 0.067 W/kg
SAR(1 g) = 0.032 mW/g; SAR(10 g) = 0.017 mW/g
 Maximum value of SAR (measured) = 0.037 mW/g

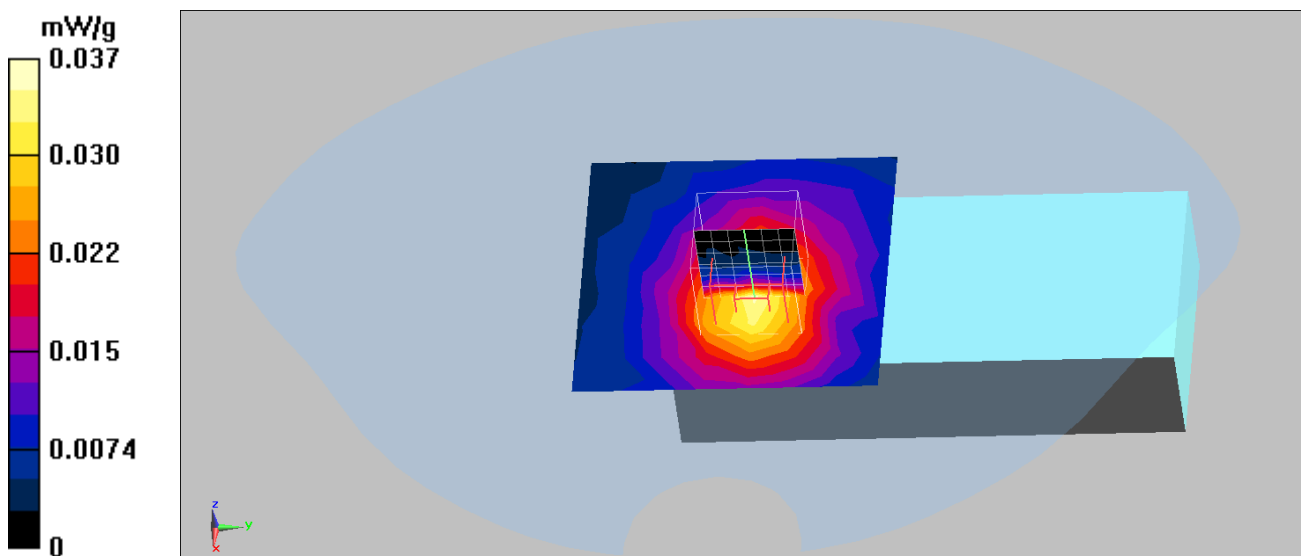

Date/Time: 12/29/2010

Test Laboratory: QuieTek

802.11b_11 Front

DUT: 3M Pocket Projector; Type: MP180

Communication System: 802.11b; Frequency: 2462 MHz; Communication System PAR: 0 dB
 Medium parameters used: $f = 2462$ MHz; $\sigma = 1.95$ mho/m; $\epsilon_r = 52.3$; $\rho = 1000$ kg/m³
 Phantom section: Flat Section
 Measurement Standard: DASYS5 (IEEE/IEC/ANSI C63.19-2007)

DASY5 Configuration:

- Probe: EX3DV4 - SN3698; ConvF(7.01, 7.01, 7.01); Calibrated: 7/19/2010
- Sensor-Surface: 4mm (Mechanical Surface Detection)
- Electronics: DAE4 Sn1207; Calibrated: 4/26/2010
- Phantom: SAM with right table; Type: SAM;
- Measurement SW: DASY52, V52.2 Build 0; Postprocessing SW: SEMCAD X, V14.2 Build 2Version 14.2.2 (1674) (Deployment Build)

Configuration/Body/Area Scan (8x8x1): Measurement grid: dx=13mm, dy=13mm
 Maximum value of SAR (measured) = 0.016 mW/g

Configuration/Body/Zoom Scan (7x7x7) (7x7x7)/Cube 0: Measurement grid:
 dx=5mm, dy=5mm, dz=5mm
 Reference Value = 2.57 V/m; Power Drift = 0.091 dB
 Peak SAR (extrapolated) = 0.028 W/kg
SAR(1 g) = 0.015 mW/g; SAR(10 g) = 0.00981 mW/g
 Maximum value of SAR (measured) = 0.017 mW/g

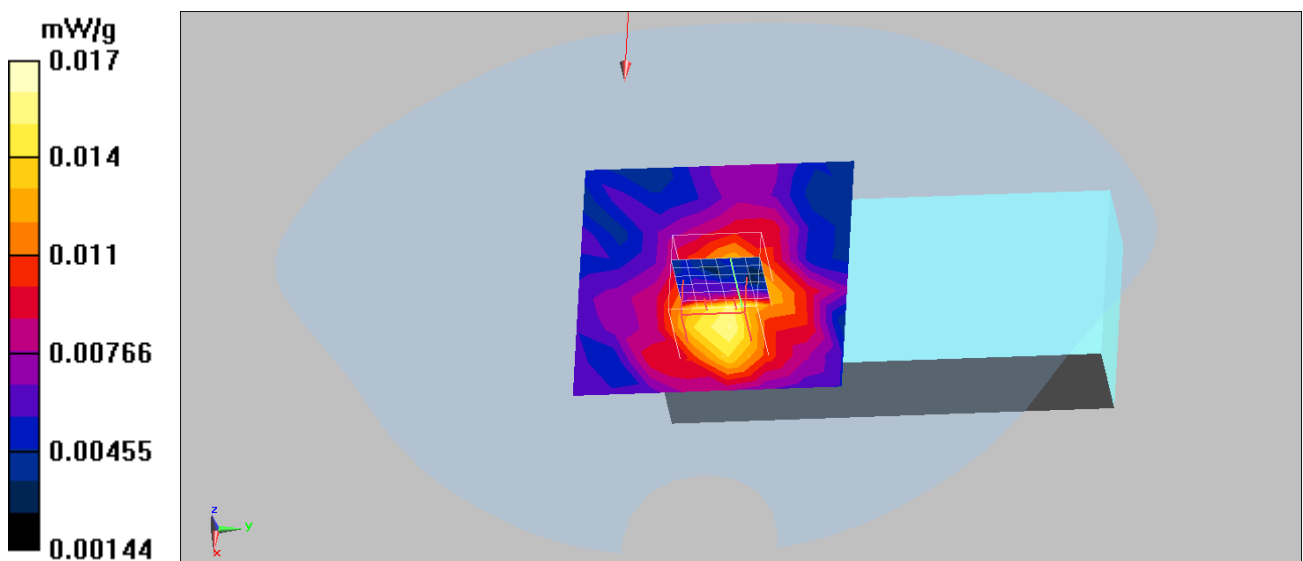

Date/Time: 12/29/2010

Test Laboratory: QuieTek

802.11b_6 Back

DUT: 3M Pocket Projector; Type: MP180

Communication System: 802.11b; Frequency: 2437 MHz; Communication System PAR: 0 dB
Medium parameters used: $f = 2437$ MHz; $\sigma = 1.93$ mho/m; $\epsilon_r = 52.7$; $\rho = 1000$ kg/m³
Phantom section: Flat Section
Measurement Standard: DASYS (IEEE/IEC/ANSI C63.19-2007)

DASY5 Configuration:

- Probe: EX3DV4 - SN3698; ConvF(7.01, 7.01, 7.01); Calibrated: 7/19/2010
- Sensor-Surface: 4mm (Mechanical Surface Detection)
- Electronics: DAE4 Sn1207; Calibrated: 4/26/2010
- Phantom: SAM with right table; Type: SAM;
- Measurement SW: DASY52, V52.2 Build 0; Postprocessing SW: SEMCAD X, V14.2 Build 2Version 14.2.2 (1674) (Deployment Build)

Configuration/Body/Area Scan (8x8x1): Measurement grid: dx=13mm, dy=13mm
Maximum value of SAR (measured) = 0.00533 mW/g

Configuration/Body/Zoom Scan (7x7x7) (7x7x7)/Cube 0: Measurement grid:
dx=5mm, dy=5mm, dz=5mm
Reference Value = 1.21 V/m; Power Drift = -0.149 dB
Peak SAR (extrapolated) = 0.00909 W/kg
SAR(1 g) = 0.00193 mW/g; SAR(10 g) = 0.000779 mW/g
Maximum value of SAR (measured) = 0.00393 mW/g

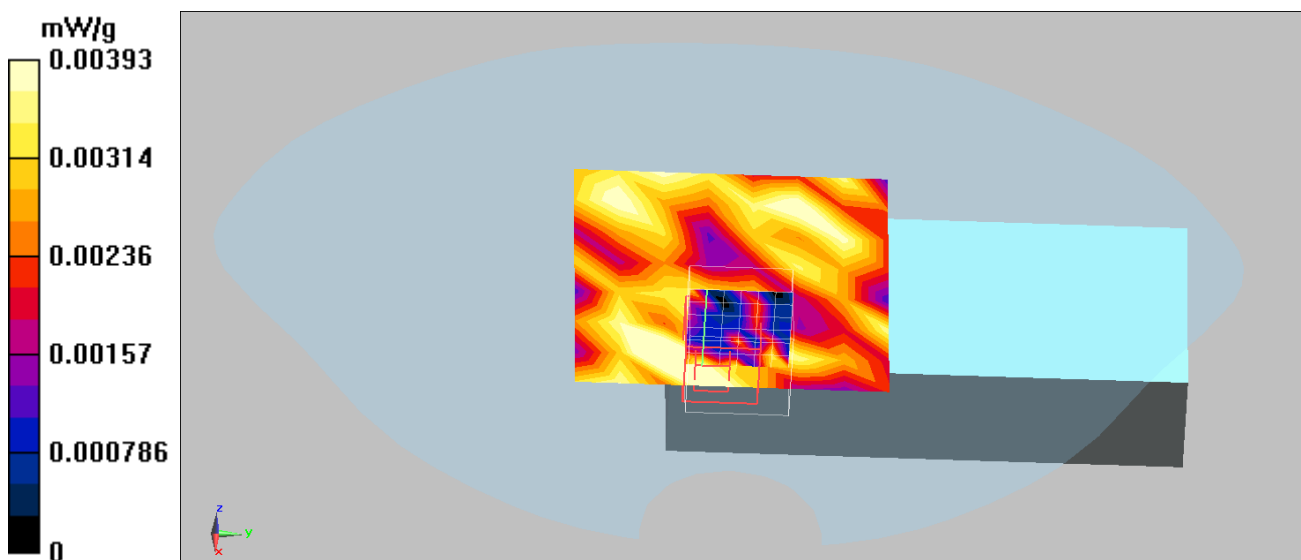

Date/Time: 12/29/2010

Test Laboratory: QuieTek

802.11b_6 L-Side

DUT: 3M Pocket Projector; Type: MP180

Communication System: 802.11b; Frequency: 2437 MHz; Communication System PAR: 0 dB
 Medium parameters used: $f = 2437$ MHz; $\sigma = 1.93$ mho/m; $\epsilon_r = 52.7$; $\rho = 1000$ kg/m³
 Phantom section: Flat Section
 Measurement Standard: DASYS (IEEE/IEC/ANSI C63.19-2007)

DASY5 Configuration:

- Probe: EX3DV4 - SN3698; ConvF(7.01, 7.01, 7.01); Calibrated: 7/19/2010
- Sensor-Surface: 4mm (Mechanical Surface Detection)
- Electronics: DAE4 Sn1207; Calibrated: 4/26/2010
- Phantom: SAM with right table; Type: SAM;
- Measurement SW: DASY52, V52.2 Build 0; Postprocessing SW: SEMCAD X, V14.2 Build 2Version 14.2.2 (1674) (Deployment Build)

Configuration/Body/Area Scan (6x8x1): Measurement grid: dx=13mm, dy=13mm
 Maximum value of SAR (measured) = 0.00947 mW/g

Configuration/Body/Zoom Scan (7x7x7) (7x7x7)/Cube 0: Measurement grid:
 dx=5mm, dy=5mm, dz=5mm
 Reference Value = 1.96 V/m; Power Drift = -0.101 dB
 Peak SAR (extrapolated) = 0.037 W/kg
SAR(1 g) = 0.00861 mW/g; SAR(10 g) = 0.0044 mW/g
 Maximum value of SAR (measured) = 0.00949 mW/g

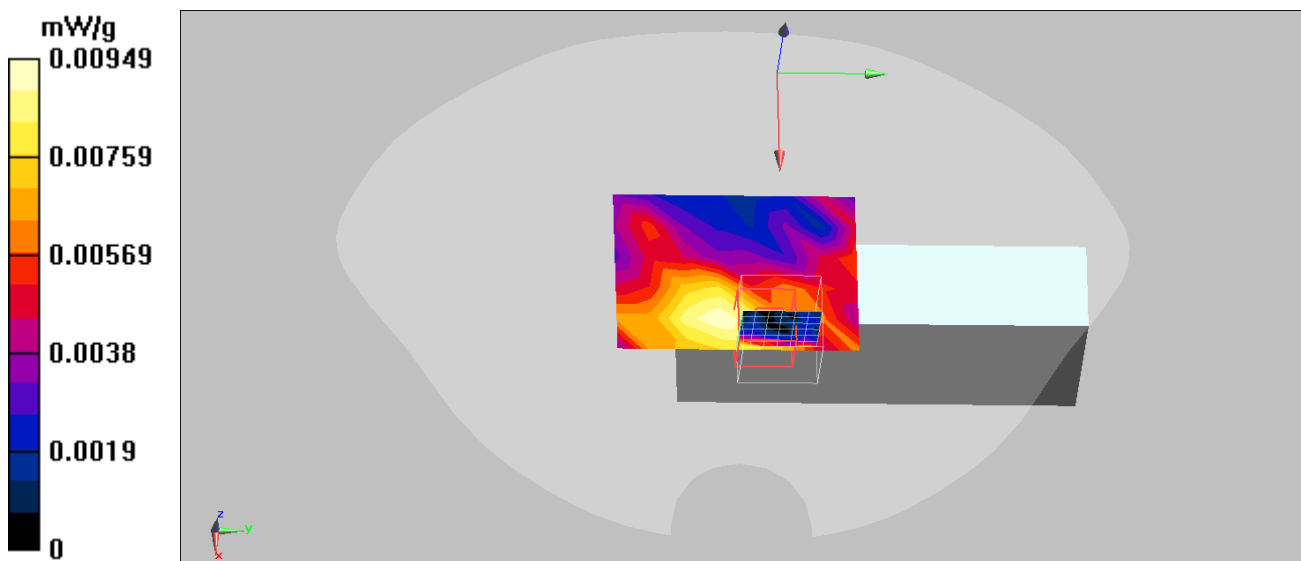

Date/Time: 12/29/2010

Test Laboratory: QuieTek

802.11b_6 R-Side

DUT: 3M Pocket Projector; Type: MP180

Communication System: 802.11b; Frequency: 2437 MHz; Communication System PAR: 0 dB
 Medium parameters used: $f = 2437 \text{ MHz}$; $\sigma = 1.93 \text{ mho/m}$; $\epsilon_r = 52.7$; $\rho = 1000 \text{ kg/m}^3$
 Phantom section: Flat Section
 Measurement Standard: DASYS5 (IEEE/IEC/ANSI C63.19-2007)

DASY5 Configuration:

- Probe: EX3DV4 - SN3698; ConvF(7.01, 7.01, 7.01); Calibrated: 7/19/2010
- Sensor-Surface: 4mm (Mechanical Surface Detection)
- Electronics: DAE4 Sn1207; Calibrated: 4/26/2010
- Phantom: SAM with right table; Type: SAM;
- Measurement SW: DASY52, V52.2 Build 0; Postprocessing SW: SEMCAD X, V14.2 Build 2Version 14.2.2 (1674) (Deployment Build)

Configuration/Body/Area Scan (7x8x1): Measurement grid: $dx=13\text{mm}$, $dy=13\text{mm}$
 Maximum value of SAR (measured) = 0.014 mW/g

Configuration/Body/Zoom Scan (7x7x7) (7x7x7)/Cube 0: Measurement grid:
 $dx=5\text{mm}$, $dy=5\text{mm}$, $dz=5\text{mm}$
 Reference Value = 1.97 V/m; Power Drift = 0.125 dB
 Peak SAR (extrapolated) = 0.056 W/kg
SAR(1 g) = 0.014 mW/g; SAR(10 g) = 0.00796 mW/g
 Maximum value of SAR (measured) = 0.016 mW/g

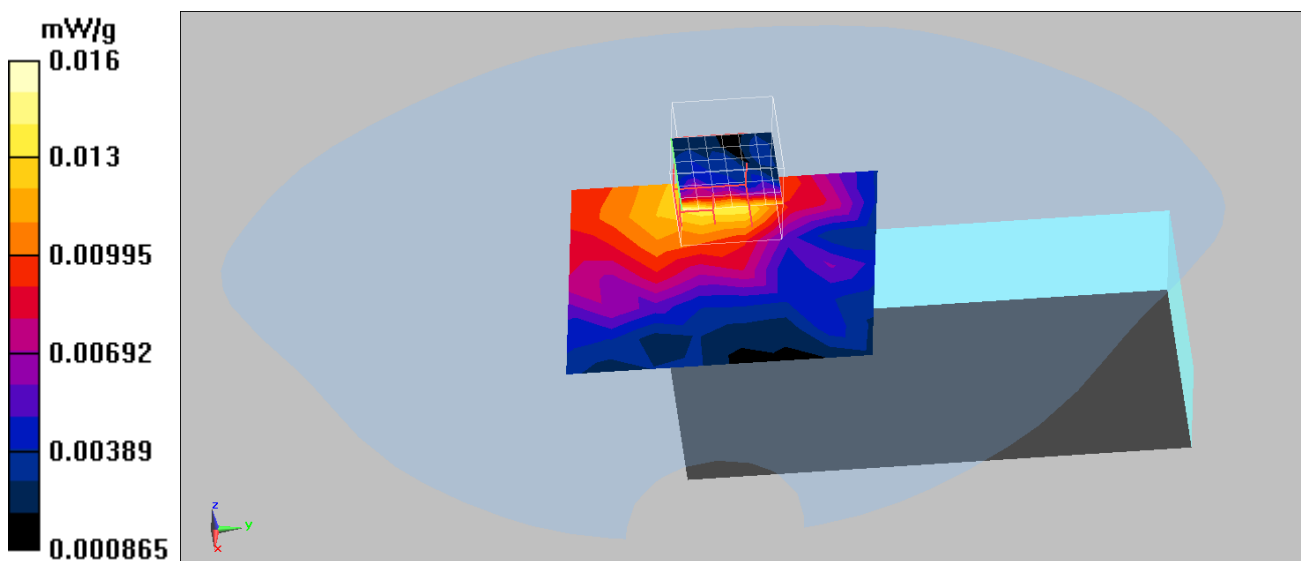

Date/Time: 12/29/2010

Test Laboratory: QuieTek

802.11n_6 Bottom

DUT: 3M Pocket Projector; Type: MP180

Communication System: 802.11n; Frequency: 2437 MHz; Communication System PAR: 0 dB
 Medium parameters used: $f = 2437 \text{ MHz}$; $\sigma = 1.93 \text{ mho/m}$; $\epsilon_r = 52.7$; $\rho = 1000 \text{ kg/m}^3$
 Phantom section: Flat Section
 Measurement Standard: DASYS (IEEE/IEC/ANSI C63.19-2007)
 DASYS Configuration:

- Probe: EX3DV4 - SN3698; ConvF(7.01, 7.01, 7.01); Calibrated: 7/19/2010
- Sensor-Surface: 4mm (Mechanical Surface Detection)
- Electronics: DAE4 Sn1207; Calibrated: 4/26/2010
- Phantom: SAM with right table; Type: SAM;
- Measurement SW: DASYS2, V52.2 Build 0; Postprocessing SW: SEMCAD X, V14.2 Build 2 Version 14.2.2 (1674) (Deployment Build)

Configuration/Body/Area Scan (7x8x1): Measurement grid: $dx=13\text{mm}$, $dy=13\text{mm}$
 Maximum value of SAR (measured) = 0.028 mW/g

Configuration/Body/Zoom Scan (7x7x7) (7x7x7)/Cube 0: Measurement grid:
 $dx=5\text{mm}$, $dy=5\text{mm}$, $dz=5\text{mm}$
 Reference Value = 3.32 V/m; Power Drift = 0.112 dB
 Peak SAR (extrapolated) = 0.125 W/kg
SAR(1 g) = 0.027 mW/g; SAR(10 g) = 0.014 mW/g
 Maximum value of SAR (measured) = 0.027 mW/g

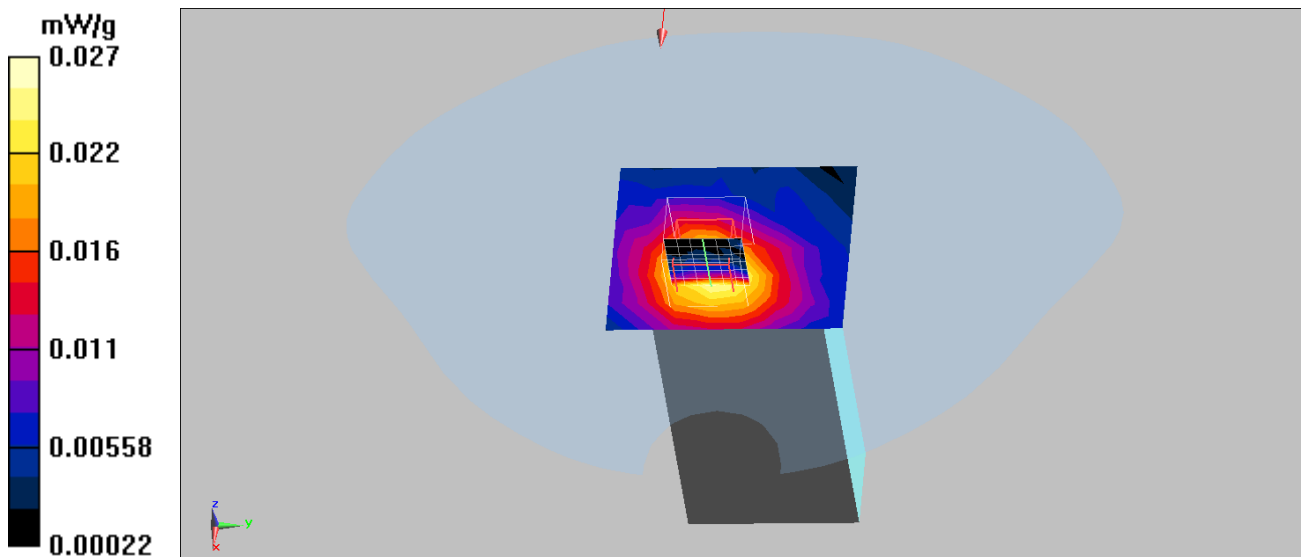

Date/Time: 12/29/2010

Test Laboratory: QuieTek

802.11n20_6 Front

DUT: 3M Pocket Projector; Type: MP180

Communication System: 802.11n; Frequency: 2437 MHz; Communication System PAR: 0 dB
 Medium parameters used: $f = 2437 \text{ MHz}$; $\sigma = 1.93 \text{ mho/m}$; $\epsilon_r = 52.7$; $\rho = 1000 \text{ kg/m}^3$
 Phantom section: Flat Section
 Measurement Standard: DASYS (IEEE/IEC/ANSI C63.19-2007)

DASY5 Configuration:

- Probe: EX3DV4 - SN3698; ConvF(7.01, 7.01, 7.01); Calibrated: 7/19/2010
- Sensor-Surface: 4mm (Mechanical Surface Detection)
- Electronics: DAE4 Sn1207; Calibrated: 4/26/2010
- Phantom: SAM with right table; Type: SAM;
- Measurement SW: DASY52, V52.2 Build 0; Postprocessing SW: SEMCAD X, V14.2 Build 2Version 14.2.2 (1674) (Deployment Build)

Configuration/Body/Area Scan (8x8x1): Measurement grid: dx=13mm, dy=13mm
 Maximum value of SAR (measured) = 0.015 mW/g

Configuration/Body/Zoom Scan (7x7x7) (7x7x7)/Cube 0: Measurement grid:
 dx=5mm, dy=5mm, dz=5mm
 Reference Value = 2.64 V/m; Power Drift = -0.055 dB
 Peak SAR (extrapolated) = 0.025 W/kg
SAR(1 g) = 0.013 mW/g; SAR(10 g) = 0.00868 mW/g
 Maximum value of SAR (measured) = 0.016 mW/g

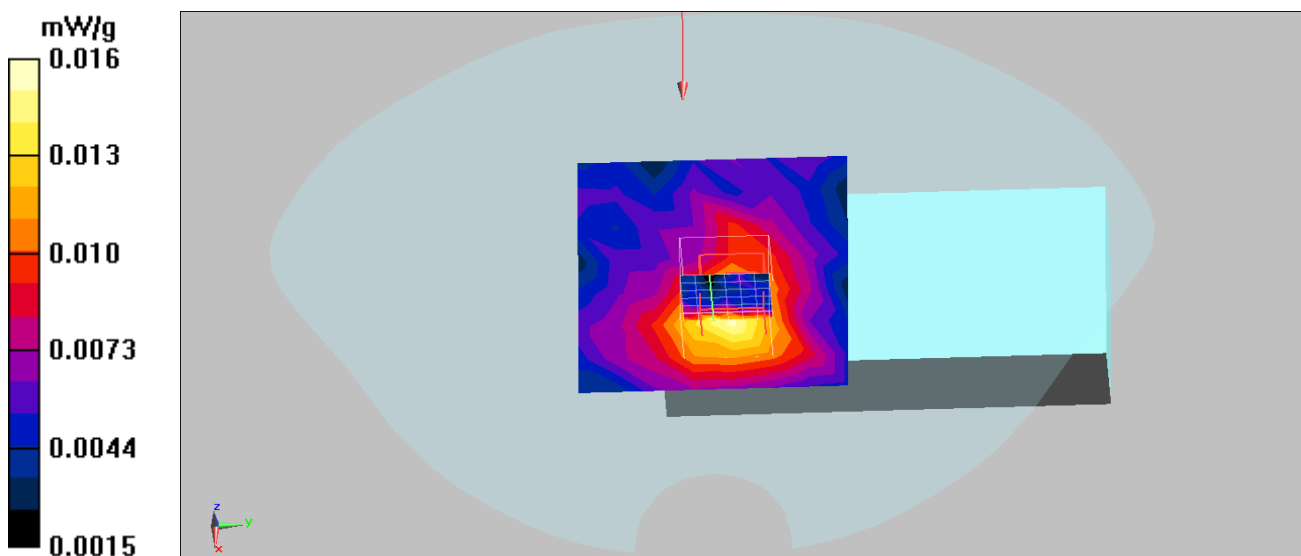

Date/Time: 12/29/2010

Test Laboratory: QuieTek

802.11n40_6 Front

DUT: 3M Pocket Projector; Type: MP180

Communication System: 802.11n; Frequency: 2437 MHz; Communication System PAR: 0 dB
 Medium parameters used: $f = 2437 \text{ MHz}$; $\sigma = 1.93 \text{ mho/m}$; $\epsilon_r = 52.7$; $\rho = 1000 \text{ kg/m}^3$
 Phantom section: Flat Section
 Measurement Standard: DASYS (IEEE/IEC/ANSI C63.19-2007)

DASY5 Configuration:

- Probe: EX3DV4 - SN3698; ConvF(7.01, 7.01, 7.01); Calibrated: 7/19/2010
- Sensor-Surface: 4mm (Mechanical Surface Detection)
- Electronics: DAE4 Sn1207; Calibrated: 4/26/2010
- Phantom: SAM with right table; Type: SAM;
- Measurement SW: DASY52, V52.2 Build 0; Postprocessing SW: SEMCAD X, V14.2 Build 2Version 14.2.2 (1674) (Deployment Build)

Configuration/Body/Area Scan (8x8x1): Measurement grid: dx=13mm, dy=13mm
 Maximum value of SAR (measured) = 0.015 mW/g

Configuration/Body/Zoom Scan (7x7x7) (7x7x7)/Cube 0: Measurement grid:
 dx=5mm, dy=5mm, dz=5mm
 Reference Value = 2.36 V/m; Power Drift = 0.842 dB
 Peak SAR (extrapolated) = 0.033 W/kg
SAR(1 g) = 0.015 mW/g; SAR(10 g) = 0.00918 mW/g
 Maximum value of SAR (measured) = 0.019 mW/g

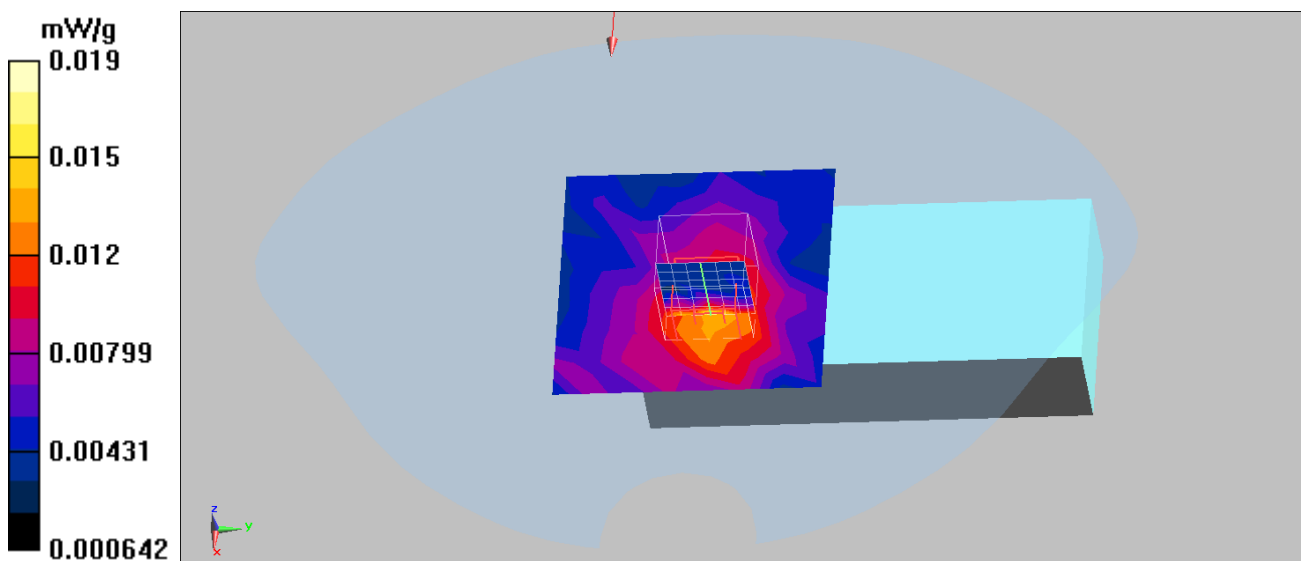

802.11b EUT Front Z-Axis plot

Channel: 6

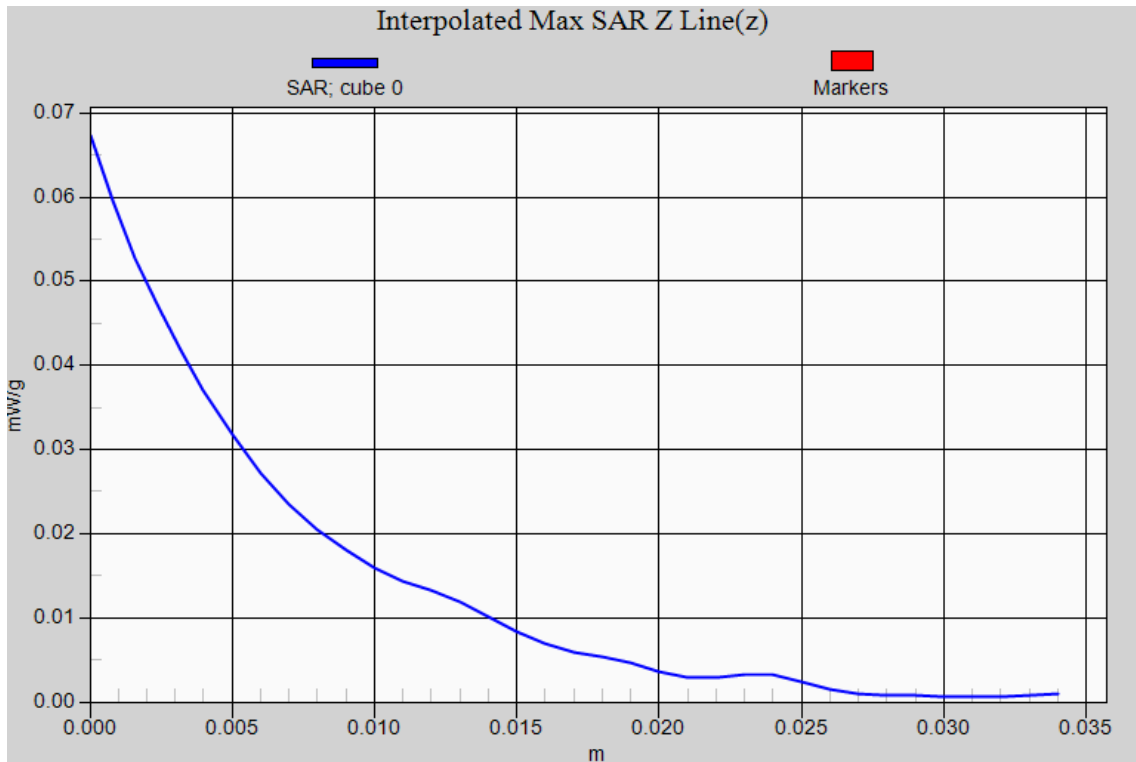



Appendix D. Probe Calibration Data

Object: EX3DV4- SN 3698

1155

**Calibration Laboratory of
Schmid & Partner
Engineering AG**
Zeughausstrasse 43, 8004 Zurich, Switzerland



S Schweizerischer Kalibrierdienst
C Service suisse d'étalonnage
S Servizio svizzero di taratura
S Swiss Calibration Service

Accredited by the Swiss Accreditation Service (SAS)
**The Swiss Accreditation Service is one of the signatories to the EA
Multilateral Agreement for the recognition of calibration certificates**

Accreditation No.: **SCS 108**

Client **Quietek (Auden)**

Certificate No: **EX3-3698_Jul10**

CALIBRATION CERTIFICATE

Object **EX3DV4 - SN.3698**

Calibration procedure(s) **QA CAL-01.v6, QA CAL-14.v3, QA CAL-23.v3 and QA CAL-25.v2
Calibration procedure for dosimetric E-field probes**

Calibration date: **July 19, 2010**

This calibration certificate documents the traceability to national standards, which realize the physical units of measurements (SI).
The measurements and the uncertainties with confidence probability are given on the following pages and are part of the certificate.

All calibrations have been conducted in the closed laboratory facility: environment temperature (22 ± 3)°C and humidity < 70%.

Calibration Equipment used (M&TE critical for calibration)

Primary Standards	ID #	Cal Date (Certificate No.)	Scheduled Calibration
Power meter E4419B	GB41293874	1-Apr-10 (No. 217-01136)	Apr-11
Power sensor E4412A	MY41495277	1-Apr-10 (No. 217-01136)	Apr-11
Power sensor E4412A	MY41498087	1-Apr-10 (No. 217-01136)	Apr-11
Reference 3 dB Attenuator	SN: S5054 (3c)	30-Mar-10 (No. 217-01159)	Mar-11
Reference 20 dB Attenuator	SN: S5086 (20b)	30-Mar-10 (No. 217-01161)	Mar-11
Reference 30 dB Attenuator	SN: S5129 (30b)	30-Mar-10 (No. 217-01160)	Mar-11
Reference Probe ES3DV2	SN: 3013	30-Dec-09 (No. ES3-3013_Dec09)	Dec-10
DAE4	SN: 660	20-Apr-10 (No. DAE4-660_Apr10)	Apr-11

Secondary Standards	ID #	Check Date (in house)	Scheduled Check
RF generator HP 8648C	US3642U01700	4-Aug-99 (in house check Oct-09)	In house check: Oct-11
Network Analyzer HP 8753E	US37390585	18-Oct-01 (in house check Oct-09)	In house check: Oct10

	Name	Function	Signature
Calibrated by:	Katja Pokovic	Technical Manager	
Approved by:	Niels Kuster	Quality Manager	

Issued: July 20, 2010

This calibration certificate shall not be reproduced except in full without written approval of the laboratory.



Accredited by the Swiss Accreditation Service (SAS)

The Swiss Accreditation Service is one of the signatories to the EA
Multilateral Agreement for the recognition of calibration certificates

Accreditation No.: **SCS 108**

Glossary:

TSL	tissue simulating liquid
NORM _{x,y,z}	sensitivity in free space
ConvF	sensitivity in TSL / NORM _{x,y,z}
DCP	diode compression point
CF	crest factor (1/duty_cycle) of the RF signal
A, B, C	modulation dependent linearization parameters
Polarization φ	φ rotation around probe axis
Polarization ϑ	ϑ rotation around an axis that is in the plane normal to probe axis (at measurement center), i.e., $\vartheta = 0$ is normal to probe axis

Calibration is Performed According to the Following Standards:

- IEEE Std 1528-2003, "IEEE Recommended Practice for Determining the Peak Spatial-Averaged Specific Absorption Rate (SAR) in the Human Head from Wireless Communications Devices: Measurement Techniques", December 2003
- IEC 62209-1, "Procedure to measure the Specific Absorption Rate (SAR) for hand-held devices used in close proximity to the ear (frequency range of 300 MHz to 3 GHz)", February 2005

Methods Applied and Interpretation of Parameters:

- NORM_{x,y,z}**: Assessed for E-field polarization $\vartheta = 0$ ($f \leq 900$ MHz in TEM-cell; $f > 1800$ MHz: R22 waveguide). NORM_{x,y,z} are only intermediate values, i.e., the uncertainties of NORM_{x,y,z} does not effect the E²-field uncertainty inside TSL (see below ConvF).
- NORM(f)_{x,y,z}** = NORM_{x,y,z} * frequency_response (see Frequency Response Chart). This linearization is implemented in DASY4 software versions later than 4.2. The uncertainty of the frequency response is included in the stated uncertainty of ConvF.
- DCP_{x,y,z}**: DCP are numerical linearization parameters assessed based on the data of power sweep with CW signal (no uncertainty required). DCP does not depend on frequency nor media.
- A_{x,y,z}; B_{x,y,z}; C_{x,y,z}; VR_{x,y,z}**: A, B, C are numerical linearization parameters assessed based on the data of power sweep for specific modulation signal. The parameters do not depend on frequency nor media. VR is the maximum calibration range expressed in RMS voltage across the diode.
- ConvF and Boundary Effect Parameters**: Assessed in flat phantom using E-field (or Temperature Transfer Standard for $f \leq 800$ MHz) and inside waveguide using analytical field distributions based on power measurements for $f > 800$ MHz. The same setups are used for assessment of the parameters applied for boundary compensation (alpha, depth) of which typical uncertainty values are given. These parameters are used in DASY4 software to improve probe accuracy close to the boundary. The sensitivity in TSL corresponds to NORM_{x,y,z} * ConvF whereby the uncertainty corresponds to that given for ConvF. A frequency dependent ConvF is used in DASY version 4.4 and higher which allows extending the validity from ± 50 MHz to ± 100 MHz.
- Spherical isotropy (3D deviation from isotropy)**: in a field of low gradients realized using a flat phantom exposed by a patch antenna.
- Sensor Offset**: The sensor offset corresponds to the offset of virtual measurement center from the probe tip (on probe axis). No tolerance required.

Probe EX3DV4

SN:3698

Manufactured:	April 22, 2009
Last calibrated:	October 30, 2009
Recalibrated:	July 19, 2010

Calibrated for DASY/EASY Systems

(Note: non-compatible with DASY2 system!)

DASY/EASY - Parameters of Probe: EX3DV4 SN:3698**Basic Calibration Parameters**

	Sensor X	Sensor Y	Sensor Z	Unc (k=2)
Norm ($\mu\text{V}/(\text{V}/\text{m})^2$) ^A	0.48	0.45	0.45	$\pm 10.1\%$
DCP (mV) ^B	94.4	86.2	90.3	

Modulation Calibration Parameters

UID	Communication System Name	PAR		A dB	B dBuV	C	VR mV	Unc ^E (k=2)
10000	CW	0.00	X	0.00	0.00	1.00	300	$\pm 1.5\%$
			Y	0.00	0.00	1.00	300	
			Z	0.00	0.00	1.00	300	

The reported uncertainty of measurement is stated as the standard uncertainty of measurement multiplied by the coverage factor k=2, which for a normal distribution corresponds to a coverage probability of approximately 95%.

^A The uncertainties of NormX,Y,Z do not affect the E²-field uncertainty inside TSL (see Pages 5 and 6).

^B Numerical linearization parameter: uncertainty not required.

^E Uncertainty is determined using the maximum deviation from linear response applying rectangular distribution and is expressed for the square of the field value.

DASY/EASY - Parameters of Probe: EX3DV4 SN:3698

Calibration Parameter Determined in Head Tissue Simulating Media

f [MHz]	Validity [MHz] ^c	Permittivity	Conductivity	ConvF X	ConvF Y	ConvF Z	Alpha	Depth Unc (k=2)
850	± 50 / ± 100	41.5 ± 5%	0.92 ± 5%	8.23	8.23	8.23	0.99	0.52 ± 11.0%
900	± 50 / ± 100	41.5 ± 5%	0.97 ± 5%	8.52	8.52	8.52	0.71	0.61 ± 11.0%
1810	± 50 / ± 100	40.0 ± 5%	1.40 ± 5%	7.34	7.34	7.34	0.59	0.69 ± 11.0%
1900	± 50 / ± 100	40.0 ± 5%	1.40 ± 5%	7.32	7.32	7.32	0.66	0.64 ± 11.0%
2450	± 50 / ± 100	39.2 ± 5%	1.80 ± 5%	6.77	6.77	6.77	0.39	0.80 ± 11.0%
2600	± 50 / ± 100	39.0 ± 5%	1.96 ± 5%	6.76	6.76	6.76	0.24	1.19 ± 11.0%
3500	± 50 / ± 100	37.9 ± 5%	2.91 ± 5%	6.51	6.51	6.51	0.20	1.85 ± 13.1%
5200	± 50 / ± 100	36.0 ± 5%	4.66 ± 5%	4.63	4.63	4.63	0.45	1.80 ± 13.1%
5300	± 50 / ± 100	35.9 ± 5%	4.76 ± 5%	4.44	4.44	4.44	0.45	1.80 ± 13.1%
5500	± 50 / ± 100	35.6 ± 5%	4.96 ± 5%	4.42	4.42	4.42	0.50	1.80 ± 13.1%
5600	± 50 / ± 100	35.5 ± 5%	5.07 ± 5%	4.14	4.14	4.14	0.50	1.80 ± 13.1%
5800	± 50 / ± 100	35.3 ± 5%	5.27 ± 5%	4.05	4.05	4.05	0.50	1.80 ± 13.1%

^c The validity of ± 100 MHz only applies for DASY v4.4 and higher (see Page 2). The uncertainty is the RSS of the ConvF uncertainty at calibration frequency and the uncertainty for the indicated frequency band.

DASY/EASY - Parameters of Probe: EX3DV4 SN:3698

Calibration Parameter Determined in Body Tissue Simulating Media

f [MHz]	Validity [MHz] ^c	Permittivity	Conductivity	ConvF X	ConvF Y	ConvF Z	Alpha	Depth Unc (k=2)
850	± 50 / ± 100	55.2 ± 5%	0.99 ± 5%	8.21	8.21	8.21	0.99	0.53 ± 11.0%
900	± 50 / ± 100	55.0 ± 5%	1.05 ± 5%	8.61	8.61	8.61	0.59	0.73 ± 11.0%
1810	± 50 / ± 100	53.3 ± 5%	1.52 ± 5%	7.22	7.22	7.22	0.71	0.62 ± 11.0%
1900	± 50 / ± 100	53.3 ± 5%	1.52 ± 5%	7.16	7.16	7.16	0.84	0.59 ± 11.0%
2450	± 50 / ± 100	52.7 ± 5%	1.95 ± 5%	7.01	7.01	7.01	0.44	0.81 ± 11.0%
2600	± 50 / ± 100	52.5 ± 5%	2.16 ± 5%	7.00	7.00	7.00	0.35	0.95 ± 11.0%
3500	± 50 / ± 100	51.3 ± 5%	3.31 ± 5%	5.93	5.93	5.93	0.25	1.60 ± 13.1%
5200	± 50 / ± 100	49.0 ± 5%	5.30 ± 5%	4.11	4.11	4.11	0.55	1.95 ± 13.1%
5300	± 50 / ± 100	48.5 ± 5%	5.42 ± 5%	3.89	3.89	3.89	0.55	1.95 ± 13.1%
5500	± 50 / ± 100	48.6 ± 5%	5.65 ± 5%	3.40	3.40	3.40	0.60	1.95 ± 13.1%
5600	± 50 / ± 100	48.5 ± 5%	5.77 ± 5%	3.20	3.20	3.20	0.65	1.95 ± 13.1%
5800	± 50 / ± 100	48.2 ± 5%	6.00 ± 5%	3.48	3.48	3.48	0.65	1.90 ± 13.1%

^c The validity of ± 100 MHz only applies for DASY v4.4 and higher (see Page 2). The uncertainty is the RSS of the ConvF uncertainty at calibration frequency and the uncertainty for the indicated frequency band.

Frequency Response of E-Field

(TEM-Cell: ifi110 EXX, Waveguide: R22)

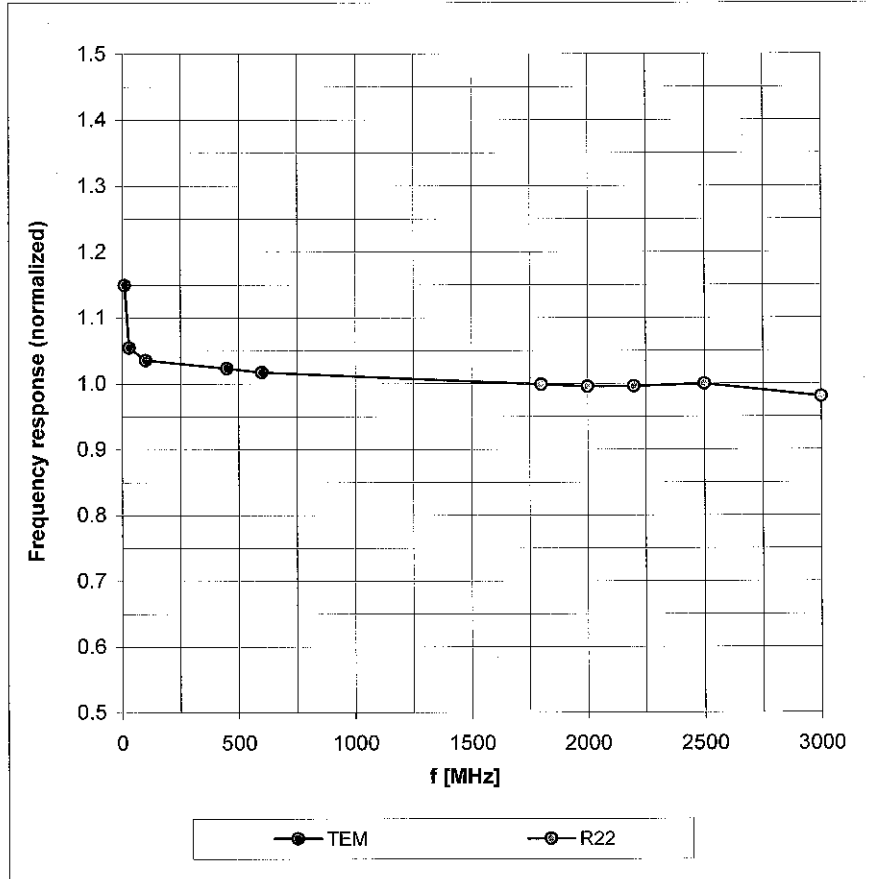

Uncertainty of Frequency Response of E-field: $\pm 6.3\%$ ($k=2$)

Receiving Pattern (ϕ), $\theta = 0^\circ$

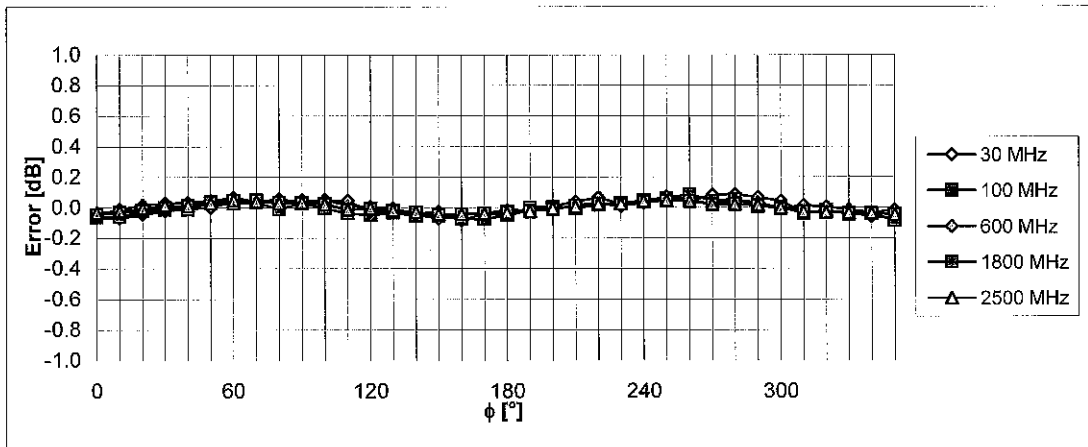
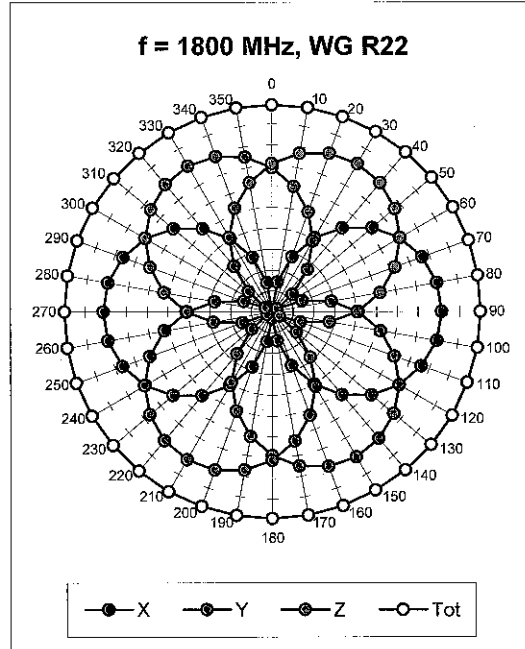
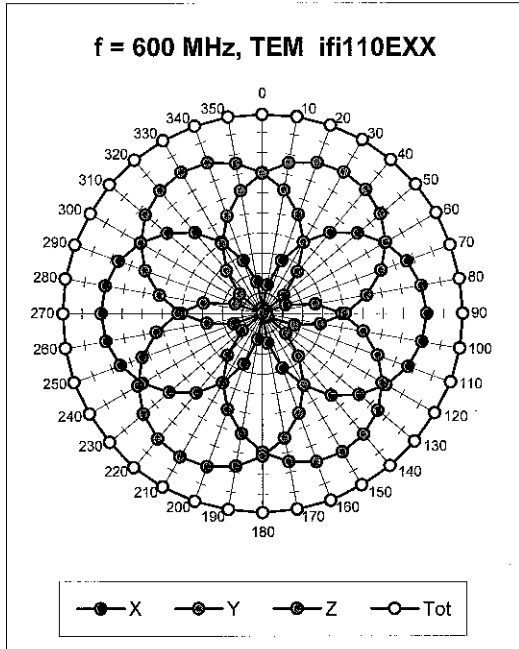

Uncertainty of Axial Isotropy Assessment: $\pm 0.5\%$ ($k=2$)

Dynamic Range f(SAR_{head}) (Waveguide R22, f = 1800 MHz)

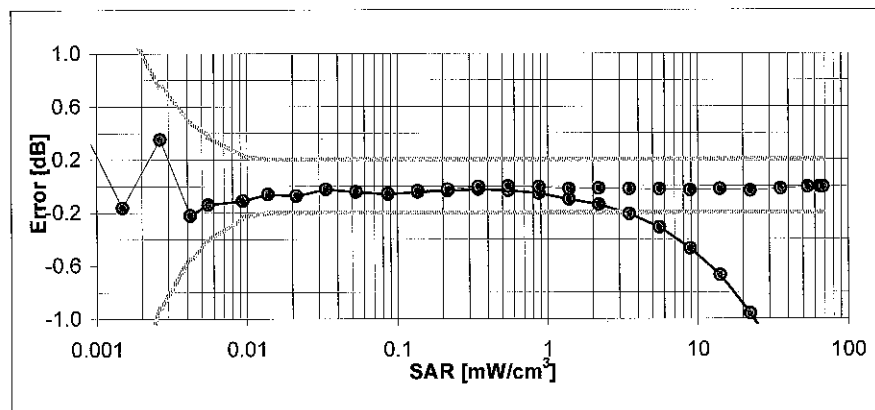
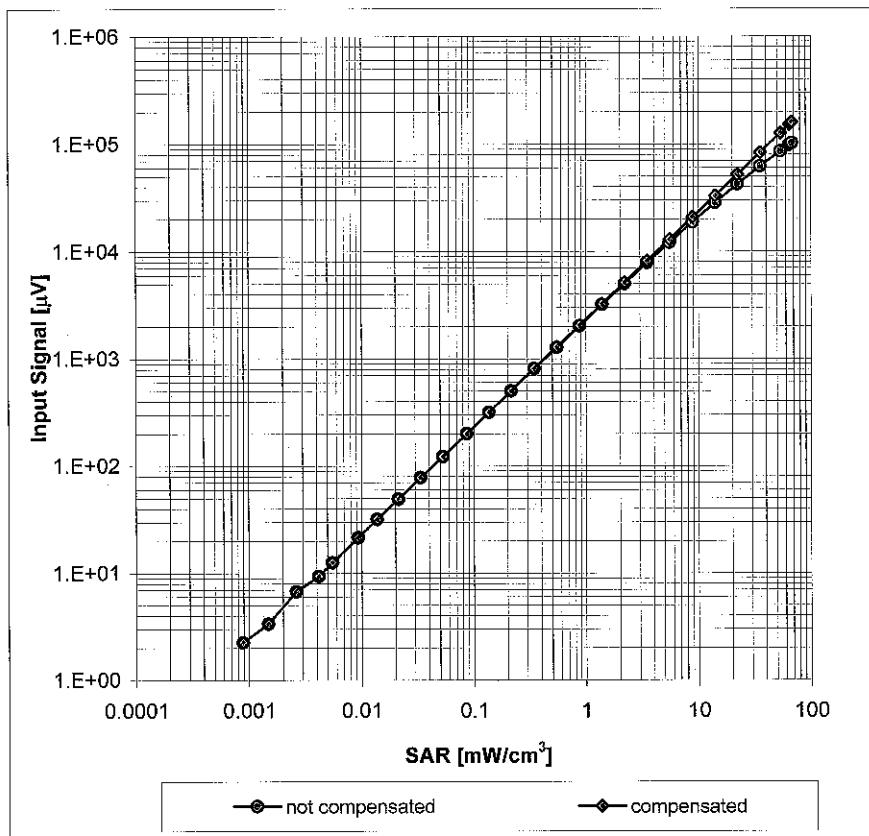

Uncertainty of Linearity Assessment: ± 0.6% (k=2)

Conversion Factor Assessment

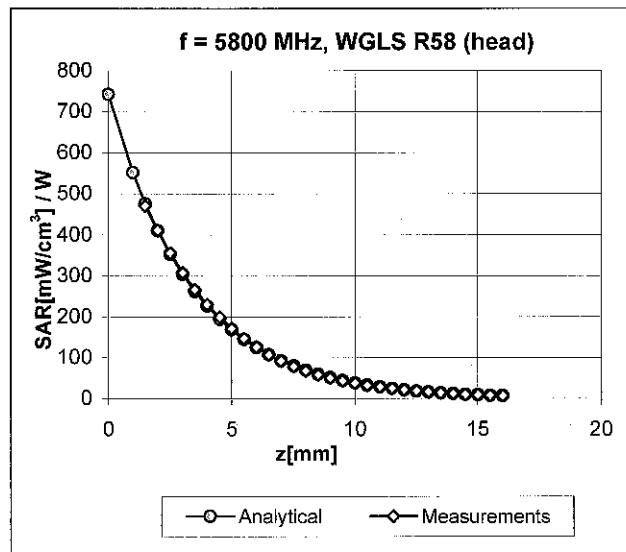
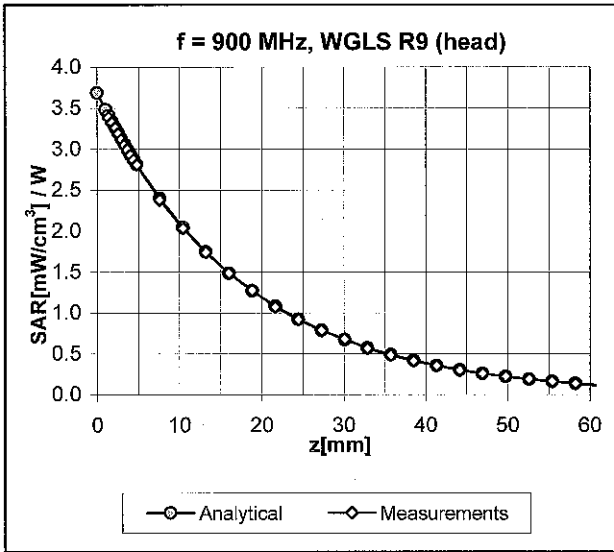

Deviation from Isotropy in HSL

Error (ϕ, ϑ), f = 900 MHz

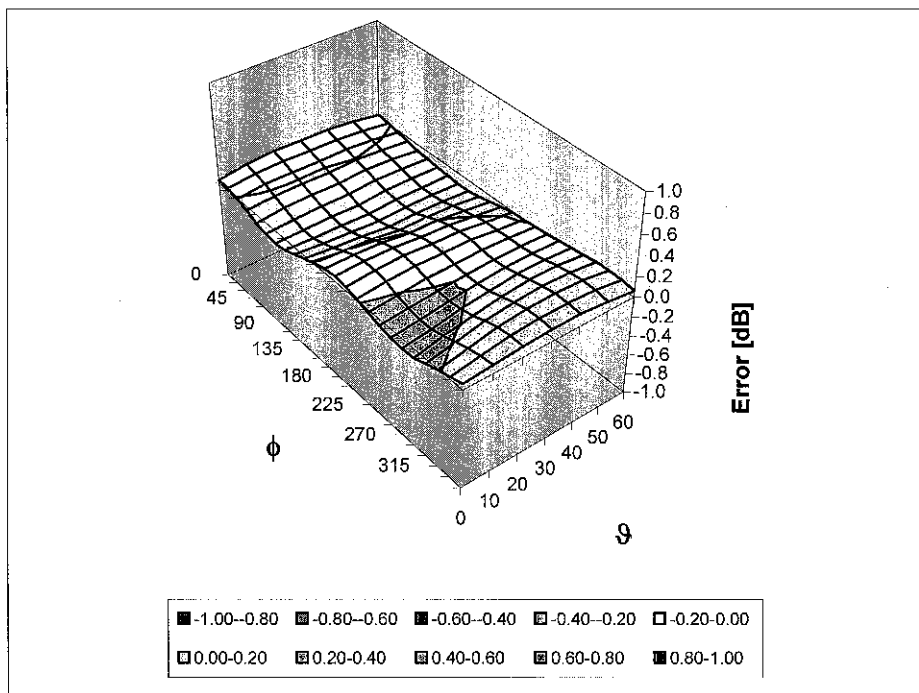

Uncertainty of Spherical Isotropy Assessment: $\pm 2.6\%$ (k=2)

Other Probe Parameters

Sensor Arrangement	Triangular
Connector Angle (°)	Not applicable
Mechanical Surface Detection Mode	enabled
Optical Surface Detection Mode	disabled
Probe Overall Length	337 mm
Probe Body Diameter	10 mm
Tip Length	9 mm
Tip Diameter	2.5 mm
Probe Tip to Sensor X Calibration Point	1 mm
Probe Tip to Sensor Y Calibration Point	1 mm
Probe Tip to Sensor Z Calibration Point	1 mm
Recommended Measurement Distance from Surface	2 mm



Appendix E. Dipole Calibration

Validation Dipole 2450 MHz

M/N: ALS-D-2450

S/N: QTK-319

55

**Calibration Laboratory of
Schmid & Partner
Engineering AG**
Zeughausstrasse 43, 8004 Zurich, Switzerland



S Schweizerischer Kalibrierdienst
S Service suisse d'étalonnage
C Servizio svizzero di taratura
S Swiss Calibration Service

Accredited by the Swiss Accreditation Service (SAS)
The Swiss Accreditation Service is one of the signatories to the EA
Multilateral Agreement for the recognition of calibration certificates

Accreditation No.: **SCS 108**

Client **Quietek (Auden)**

Certificate No: **ALS-2450-QTK-319_May10**

CALIBRATION CERTIFICATE

Object **ALS-D-2450-SN: QTK-319**

Calibration procedure(s) **QA CAL-05.v7
Calibration procedure for dipole validation kits**

Calibration date: **May 27, 2010**

This calibration certificate documents the traceability to national standards, which realize the physical units of measurements (SI).
The measurements and the uncertainties with confidence probability are given on the following pages and are part of the certificate.

All calibrations have been conducted in the closed laboratory facility: environment temperature (22 ± 3)°C and humidity < 70%.

Calibration Equipment used (M&TE critical for calibration)

Primary Standards	ID #	Cal Date (Certificate No.)	Scheduled Calibration
Power meter EPM-442A	GB37480704	06-Oct-09 (No. 217-01086)	Oct-10
Power sensor HP 8481A	US37292783	06-Oct-09 (No. 217-01086)	Oct-10
Reference 20 dB Attenuator	SN: 5086 (20g)	30-Mar-10 (No. 217-01158)	Mar-11
Type-N mismatch combination	SN: 5047.2 / 06327	30-Mar-10 (No. 217-01162)	Mar-11
Reference Probe ES3DV3	SN: 3205	30-Apr-10 (No. ES3-3205_Apr10)	Apr-11
DAE4	SN: 601	02-Mar-10 (No. DAE4-601_Mar10)	Mar-11

Secondary Standards	ID #	Check Date (in house)	Scheduled Check
Power sensor HP 8481A	MY41092317	18-Oct-02 (in house check Oct-09)	In house check: Oct-11
RF generator R&S SMT-06	100005	4-Aug-99 (in house check Oct-09)	In house check: Oct-11
Network Analyzer HP 8753E	US37390585 S4206	18-Oct-01 (in house check Oct-09)	In house check: Oct-10

	Name	Function	Signature
Calibrated by:	Dimce Iliev	Laboratory Technician	

	Name	Function	Signature
Approved by:	Katja Pokovic	Technical Manager	

Issued: May 27, 2010

This calibration certificate shall not be reproduced except in full without written approval of the laboratory.



Accredited by the Swiss Accreditation Service (SAS)
The Swiss Accreditation Service is one of the signatories to the EA
Multilateral Agreement for the recognition of calibration certificates

Accreditation No.: **SCS 108**

Glossary:

TSL	tissue simulating liquid
ConvF	sensitivity in TSL / NORM x,y,z
N/A	not applicable or not measured

Calibration is Performed According to the Following Standards:

- a) IEEE Std 1528-2003, "IEEE Recommended Practice for Determining the Peak Spatial-Averaged Specific Absorption Rate (SAR) in the Human Head from Wireless Communications Devices: Measurement Techniques", December 2003
- b) IEC 62209-1, "Procedure to measure the Specific Absorption Rate (SAR) for hand-held devices used in close proximity to the ear (frequency range of 300 MHz to 3 GHz)", February 2005
- c) Federal Communications Commission Office of Engineering & Technology (FCC OET), "Evaluating Compliance with FCC Guidelines for Human Exposure to Radiofrequency Electromagnetic Fields; Additional Information for Evaluating Compliance of Mobile and Portable Devices with FCC Limits for Human Exposure to Radiofrequency Emissions", Supplement C (Edition 01-01) to Bulletin 65

Additional Documentation:

- d) DAS4/5 System Handbook

Methods Applied and Interpretation of Parameters:

- *Measurement Conditions:* Further details are available from the Validation Report at the end of the certificate. All figures stated in the certificate are valid at the frequency indicated.
- *Antenna Parameters with TSL:* The dipole is mounted with the spacer to position its feed point exactly below the center marking of the flat phantom section, with the arms oriented parallel to the body axis.
- *Feed Point Impedance and Return Loss:* These parameters are measured with the dipole positioned under the liquid filled phantom. The impedance stated is transformed from the measurement at the SMA connector to the feed point. The Return Loss ensures low reflected power. No uncertainty required.
- *Electrical Delay:* One-way delay between the SMA connector and the antenna feed point. No uncertainty required.
- *SAR measured:* SAR measured at the stated antenna input power.
- *SAR normalized:* SAR as measured, normalized to an input power of 1 W at the antenna connector.
- *SAR for nominal TSL parameters:* The measured TSL parameters are used to calculate the nominal SAR result.

Measurement Conditions

DASY system configuration, as far as not given on page 1.

DASY Version	DASY5	V5.2
Extrapolation	Advanced Extrapolation	
Phantom	Modular Flat Phantom V4.9	
Distance Dipole Center - TSL	10 mm	with Spacer
Zoom Scan Resolution	dx, dy, dz = 5 mm	
Frequency	2450 MHz ± 1 MHz	

Head TSL parameters

The following parameters and calculations were applied.

	Temperature	Permittivity	Conductivity
Nominal Head TSL parameters	22.0 °C	39.2	1.80 mho/m
Measured Head TSL parameters	(22.0 ± 0.2) °C	39.0 ± 6 %	1.76 mho/m ± 6 %
Head TSL temperature during test	(21.5 ± 0.2) °C	----	----

SAR result with Head TSL

SAR averaged over 1 cm³ (1 g) of Head TSL	Condition	
SAR measured	250 mW input power	12.8 mW / g
SAR normalized	normalized to 1W	51.2 mW / g
SAR for nominal Head TSL parameters	normalized to 1W	51.7 mW /g ± 17.0 % (k=2)

SAR averaged over 10 cm³ (10 g) of Head TSL	condition	
SAR measured	250 mW input power	5.98 mW / g
SAR normalized	normalized to 1W	23.9 mW / g
SAR for nominal Head TSL parameters	normalized to 1W	24.0 mW /g ± 16.5 % (k=2)

Body TSL parameters

The following parameters and calculations were applied.

	Temperature	Permittivity	Conductivity
Nominal Body TSL parameters	22.0 °C	52.7	1.95 mho/m
Measured Body TSL parameters	(22.0 ± 0.2) °C	53.6 ± 6 %	1.97 mho/m ± 6 %
Body TSL temperature during test	(21.5 ± 0.2) °C	----	----

SAR result with Body TSL

SAR averaged over 1 cm³ (1 g) of Body TSL	Condition	
SAR measured	250 mW input power	13.0 mW / g
SAR normalized	normalized to 1W	52.0 mW / g
SAR for nominal Body TSL parameters	normalized to 1W	51.9 mW / g ± 17.0 % (k=2)

SAR averaged over 10 cm³ (10 g) of Body TSL	condition	
SAR measured	250 mW input power	6.10 mW / g
SAR normalized	normalized to 1W	24.4 mW / g
SAR for nominal Body TSL parameters	normalized to 1W	24.4 mW / g ± 16.5 % (k=2)

Appendix

Antenna Parameters with Head TSL

Impedance, transformed to feed point	$39.0 \Omega + 1.0 j\Omega$
Return Loss	- 18.1 dB

Antenna Parameters with Body TSL

Impedance, transformed to feed point	$41.7 \Omega - 6.3 j\Omega$
Return Loss	- 18.9 dB

General Antenna Parameters and Design

Electrical Delay (one direction)	1.183 ns
----------------------------------	----------

After long term use with 100W radiated power, only a slight warming of the dipole near the feedpoint can be measured.

The dipole is made of standard semirigid coaxial cable. The center conductor of the feeding line is directly connected to the second arm of the dipole. The antenna is therefore short-circuited for DC-signals.

No excessive force must be applied to the dipole arms, because they might bend or the soldered connections near the feedpoint may be damaged.

Additional EUT Data

Manufactured by	APREL
Manufactured on	Not available

DASY5 Validation Report for Head TSL

Date/Time: 25.05.2010 16:00:07

Test Laboratory: SPEAG, Zurich, Switzerland

DUT: Dipole 2450 MHz; Type: D2450V2; Serial: D2450V2 - SN:QTK-319

Communication System: CW; Frequency: 2450 MHz; Duty Cycle: 1:1

Medium: HSL U11 BB

Medium parameters used: $f = 2450$ MHz; $\sigma = 1.76$ mho/m; $\epsilon_r = 39$; $\rho = 1000$ kg/m³

Phantom section: Flat Section

Measurement Standard: DASY5 (IEEE/IEC/ANSI C63.19-2007)

DASY5 Configuration:

- Probe: ES3DV3 - SN3205; ConvF(4.53, 4.53, 4.53); Calibrated: 30.04.2010
- Sensor-Surface: 3mm (Mechanical Surface Detection)
- Electronics: DAE4 Sn601; Calibrated: 02.03.2010
- Phantom: Flat Phantom 5.0 (front); Type: QD000P50AA; Serial: 1001
- Measurement SW: DASY5, V5.2 Build 162; SEMCAD X Version 14.0 Build 61

Pin=250 mW /d=10mm, dist=3.0mm (ES-Probe)/Zoom Scan (7x7x7) /Cube 0: Measurement grid: dx=5mm, dy=5mm, dz=5mm

Reference Value = 101.0 V/m; Power Drift = 0.042 dB

Peak SAR (extrapolated) = 26.6 W/kg

SAR(1 g) = 12.8 mW/g; SAR(10 g) = 5.98 mW/g

Maximum value of SAR (measured) = 16.8 mW/g

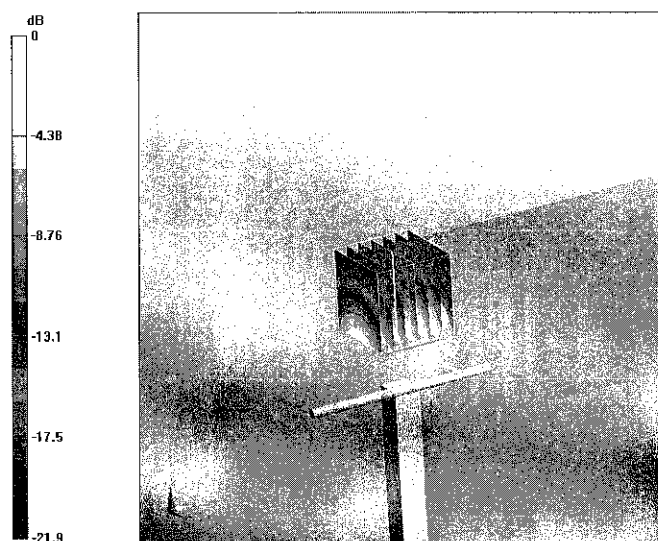

0 dB = 16.8mW/g

Impedance Measurement Plot for Head TSL

25 May 2010 10:25:46

CH1 S11 1 U FS 3: 39.027 Ω 1.0352 Ω 67.245 μH 2 450.000 005 MHz

*
Del
Cor

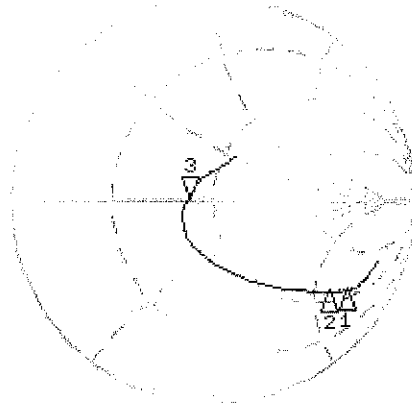

CH1 Markers
 1: 50.023 Ω
 -139.22 Ω
 1.00000 GHz
 2: 51.352 Ω
 -117.16 Ω
 1.90000 GHz

Avg
16
↑

CH2 S11 LOG 5 dB/REF -20 dB 3: -18.146 dB 2 450.000 005 MHz

Cor

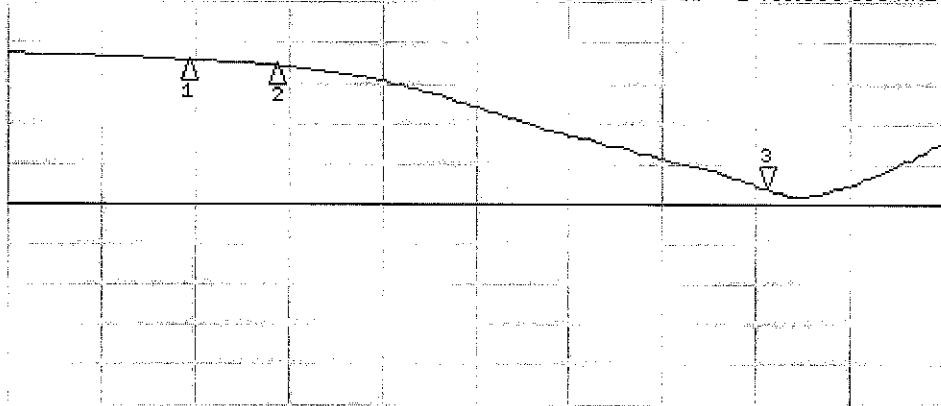

CH2 Markers
 1: -2.0848 dB
 1.00000 GHz
 2: -2.7551 dB
 1.90000 GHz

Avg
16
↑

START 1 600.000 000 MHz

STOP 2 650.000 000 MHz

DASY5 Validation Report for Body

Date/Time: 27.05.2010 11:36:56

Test Laboratory: SPEAG, Zurich, Switzerland

DUT: Dipole 2450 MHz; Type: D2450V2; Serial: D2450V2 - SN:QTK-319

Communication System: CW; Frequency: 2450 MHz; Duty Cycle: 1:1

Medium: MSL U11 BB

Medium parameters used: $f = 2450$ MHz; $\sigma = 1.98$ mho/m; $\epsilon_r = 53.7$; $\rho = 1000$ kg/m³

Phantom section: Flat Section

Measurement Standard: DASY5 (IEEE/IEC/ANSI C63.19-2007)

DASY5 Configuration:

- Probe: ES3DV3 - SN3205; ConvF(4.31, 4.31, 4.31); Calibrated: 30.04.2010
- Sensor-Surface: 3mm (Mechanical Surface Detection)
- Electronics: DAE4 Sn601; Calibrated: 02.03.2010
- Phantom: Flat Phantom 5.0 (back); Type: QD000P50AA; Serial: 1002
- Measurement SW: DASY5, V5.2 Build 162; SEMCAD X Version 14.0 Build 61

Pin=250 mW /d=10mm, dist=3.0mm (ES-Probe)/Zoom Scan (7x7x7) /Cube 0: Measurement grid: dx=5mm, dy=5mm, dz=5mm

Reference Value = 95.3 V/m; Power Drift = -0.029 dB

Peak SAR (extrapolated) = 26.6 W/kg

SAR(1 g) = 13 mW/g; SAR(10 g) = 6.1 mW/g

Maximum value of SAR (measured) = 17 mW/g

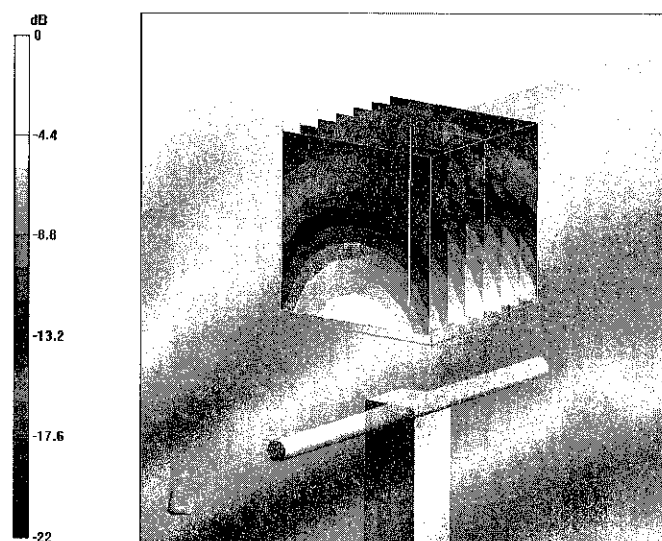

0 dB = 17mW/g

Impedance Measurement Plot for Body TSL

27 May 2010 08:43:24

CH1 S11 1 U FS 1: 41.660 Ω -6.3301 Ω 10.252 pF 2 450.000 000 MHz

*
De1
Cor

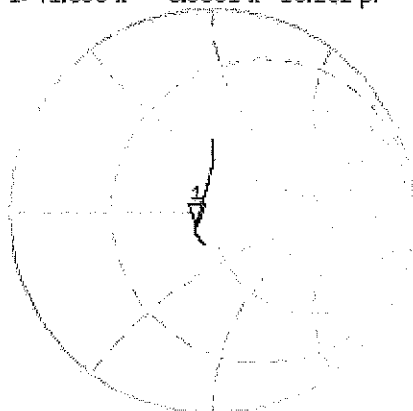

Avg
16
↑

CH2 S11 LOG 5 dB/REF -20 dB 1:-18.867 dB 2 450.000 000 MHz

Cor

Avg
16
↑

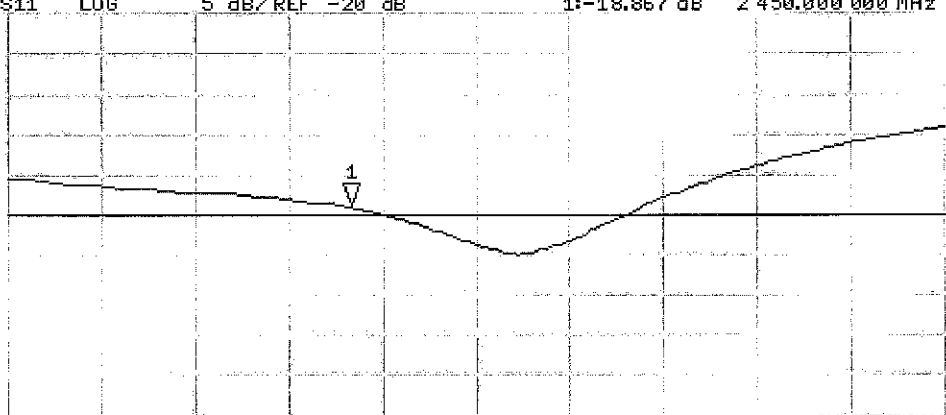

START 2 250.000 000 MHz

STOP 2 800.000 000 MHz