



JukeBlox Networked Media Module CX Series

Datasheet



- Complete audio networking system on a small module
- Integrated Ethernet + USB 2.0
- WiFi-certified 802.11b/g
- Built-in strip antenna
- Optional 2X Diversity Antenna
- Glueless audio, video and control ports
- FCC certified
- Ideal for enabling network and USB audio playback for iPod docks, audio systems, AV Receivers, active speaker systems, internet radios, network playback adaptors

Datasheet

Copyright © 2012 SMSC or its subsidiaries. All rights reserved.

Circuit diagrams and other information relating to SMSC products are included as a means of illustrating typical applications. Consequently, complete information sufficient for construction purposes is not necessarily given. Although the information has been checked and is believed to be accurate, no responsibility is assumed for inaccuracies. SMSC reserves the right to make changes to specifications and product descriptions at any time without notice. Contact your local SMSC sales office to obtain the latest specifications before placing your product order. The provision of this information does not convey to the purchaser of the described semiconductor devices any licenses under any patent rights or other intellectual property rights of SMSC or others. All sales are expressly conditional on your agreement to the terms and conditions of the most recently dated version of SMSC's standard Terms of Sale Agreement dated before the date of your order (the "Terms of Sale Agreement"). The product may contain design defects or errors known as anomalies which may cause the product's functions to deviate from published specifications. Anomaly sheets are available upon request. SMSC products are not designed, intended, authorized or warranted for use in any life support or other application where product failure could cause or contribute to personal injury or severe property damage. Any and all such uses without prior written approval of an Officer of SMSC and further testing and/or modification will be fully at the risk of the customer. Copies of this document or other SMSC literature, as well as the Terms of Sale Agreement, may be obtained by visiting SMSC's website at <http://www.smsc.com>. SMSC is a registered trademark of Standard Microsystems Corporation ("SMSC"). Product names and company names are the trademarks of their respective holders.

The Microchip name and logo, and the Microchip logo are registered trademarks of Microchip Technology Incorporated in the U.S.A. and other countries.

SMSC DISCLAIMS AND EXCLUDES ANY AND ALL WARRANTIES, INCLUDING WITHOUT LIMITATION ANY AND ALL IMPLIED WARRANTIES OF MERCHANTABILITY, FITNESS FOR A PARTICULAR PURPOSE, TITLE, AND AGAINST INFRINGEMENT AND THE LIKE, AND ANY AND ALL WARRANTIES ARISING FROM ANY COURSE OF DEALING OR USAGE OF TRADE. IN NO EVENT SHALL SMSC BE LIABLE FOR ANY DIRECT, INCIDENTAL, INDIRECT, SPECIAL, PUNITIVE, OR CONSEQUENTIAL DAMAGES; OR FOR LOST DATA, PROFITS, SAVINGS OR REVENUES OF ANY KIND; REGARDLESS OF THE FORM OF ACTION, WHETHER BASED ON CONTRACT; TORT; NEGLIGENCE OF SMSC OR OTHERS; STRICT LIABILITY; BREACH OF WARRANTY; OR OTHERWISE; WHETHER OR NOT ANY REMEDY OF BUYER IS HELD TO HAVE FAILED OF ITS ESSENTIAL PURPOSE, AND WHETHER OR NOT SMSC HAS BEEN ADVISED OF THE POSSIBILITY OF SUCH DAMAGES.

Table of Contents

1	INTRODUCTION.....	5
2	BLOCK DIAGRAM.....	5
3	BOARD PICTURES.....	6
3.1	TOP VIEW OF CX MODULE.....	6
3.2	BOTTOM VIEW OF CX MODULE.....	7
3.2.1	<i>CX Module Bottom View w/64-pin Low Density Connector.....</i>	<i>7</i>
3.2.2	<i>CX Module Bottom View w/120-pin Media Connector.....</i>	<i>7</i>
3.3	PRODUCTION MODULE WITH TOP AND RF SHIELDS IN PLACE – TOP VIEW.....	8
3.4	PRODUCTION MODULE WITH 64-PIN CONNECTOR OPTION – SIDE VIEW.....	8
3.5	EXAMPLE PRODUCTION MODULE SHOWING SOLDERED RF SHIELD.....	9
3.6	PRODUCTION MODULE WITH BOTTOM SHIELD (PART NUMBERS WITH A “B” AFTER THE CONFIGURATION LETTER) 10	
3.6.1	<i>Including J3 Low Density 64-pin connector – Bottom View.....</i>	<i>10</i>
3.6.2	<i>Including J2 High Density 120-pin connector – Bottom View.....</i>	<i>10</i>
3.7	CX870-3MB DESCRIPTION.....	11
	THIS MODULE ONLY SUPPORT THE ACTION OF THE MAIN ANTENNA (1T1R), THE AUX ANTENNA DOES NOT PERFORM ANY ACTION. ORDERING GUIDE.....	11
	ORDERING GUIDE.....	12
3.8	PART NUMBER SYNTAX.....	12
4	ELECTRICAL SPECIFICATIONS.....	13
4.1	ABSOLUTE MAXIMUM RATINGS.....	14
4.2	OPERATING CONDITIONS.....	14
4.3	WIFI SPECIFICATION (CX870 ONLY).....	15
5	REGULATORY COMPLIANCE AND QUALITY.....	16
6.0.1	<i>Antenna Considerations.....</i>	<i>17</i>
6.0.2	<i>CX Power Settings Used For Modular Approval.....</i>	<i>18</i>
5.1	RoHS.....	18
5.2	ENVIRONMENTAL TEST.....	18
5.3	ESD AND TRANSIENT TEST (APPLIES TO LAN AND USB EXTERNAL CONNECTIONS ONLY).....	18
5.4	MAGNETIC FIELD TEST.....	18
5.5	MTBF.....	19
5.6	MECHANICAL SPECIFICATIONS.....	19
5.7	MODULE QUALITY.....	19
6	BOARD DIMENSIONS AND WEIGHT.....	20
6.1	TOP & BOTTOM VIEW OF CX870 MODULE WITHOUT BOTTOM SHIELD.....	20
6.1.1	<i>Top & Bottom View of CX Module with Bottom Shield.....</i>	<i>20</i>
6.2	SIDE VIEW OF CX870 MODULE WITHOUT BOTTOM SHIELD.....	21

Datasheet

6.2.1	Side View of CX Module with Bottom Shield except CX870-3JB.....	21
6.2.2	Side View of CX870 Module with Bottom Shield part number CX870-3JB only.....	22
6.3	3D VIEW OF CX870 MODULE WITHOUT BOTTOM SHIELD	22
6.4	MODULE WEIGHT	23
7	CONNECTORS AND CONNECTIONS	23
7.1	WLAN UFL ANTENNA CONNECTOR (OPTIONAL)	23
7.2	MODULE CONNECTORS	23
7.2.1	Pin Descriptions.....	24
7.2.2	Connector PIN Assignments	29
7.2.3	GPIO Assignments	31
8	APPLICATION GUIDELINES	31
8.1	POWER SUPPLY SEQUENCING AND RESET TIMING	31
8.1.1	Power up, Reset and Power Down Timing	32
8.2	RF CONSIDERATIONS.....	32
9	REVISION CONTROL.....	33
10	APPENDIX 1: CERTIFICATION NOTICES.....	42

CONFIDENTIAL

1 Introduction

The CX-series module is a single-board networked media player module, based on SMSC's DM870A and DM875 media processors, and enables fast product developments with Ethernet, USB and optional WiFi connectivity. The module connects to standard legacy components in various audio, video/LCD and control formats.

2 Block Diagram

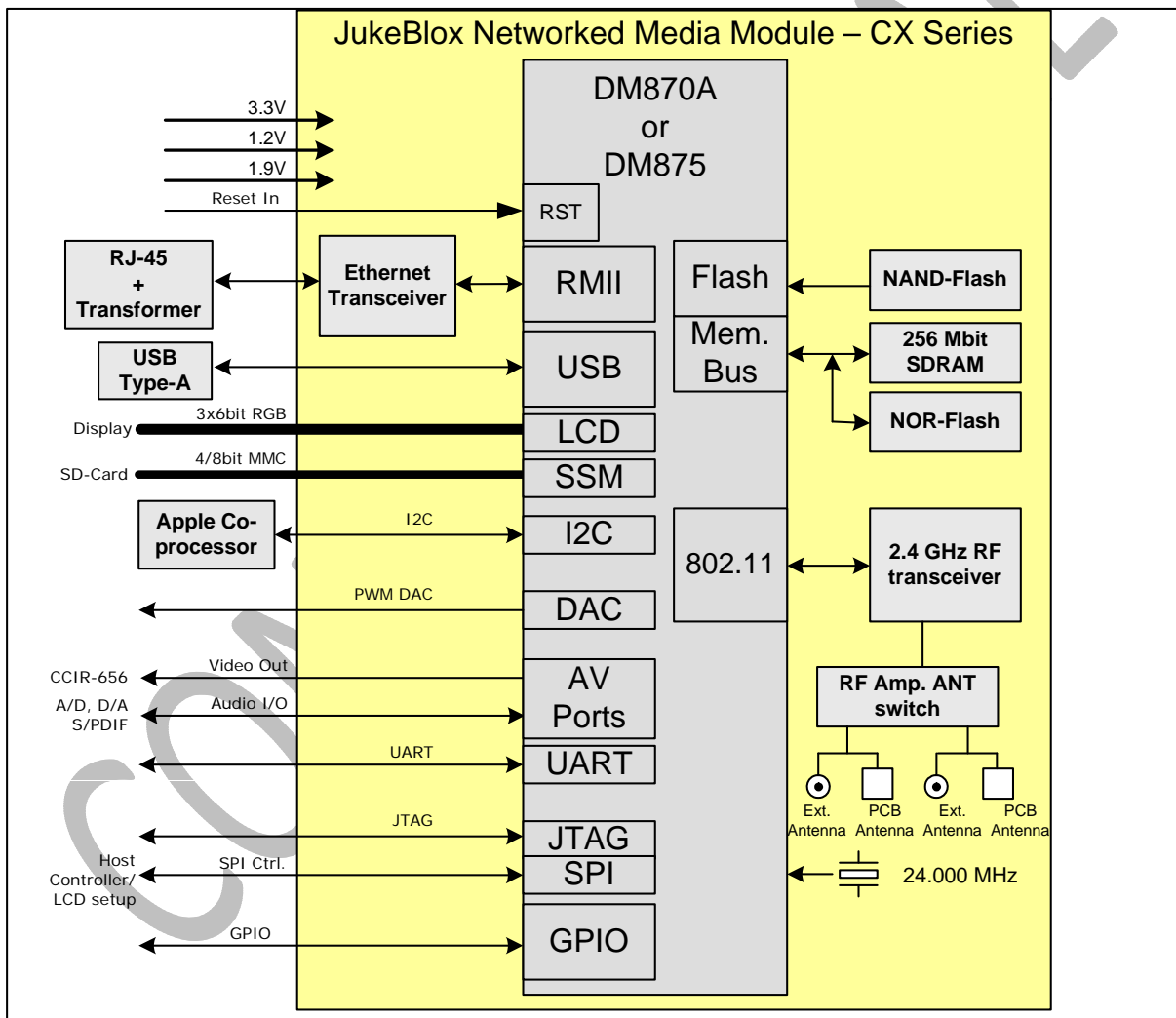

Note: Choice of antenna is a build option, see Ordering Guide.

3 Board Pictures

Please note that all production modules include the RF and top shield. The below top view has the shields temporarily removed to show the components. Also, please note that the 64-pin connector mounted on the module is the male gender.

3.1 Top View of CX Module

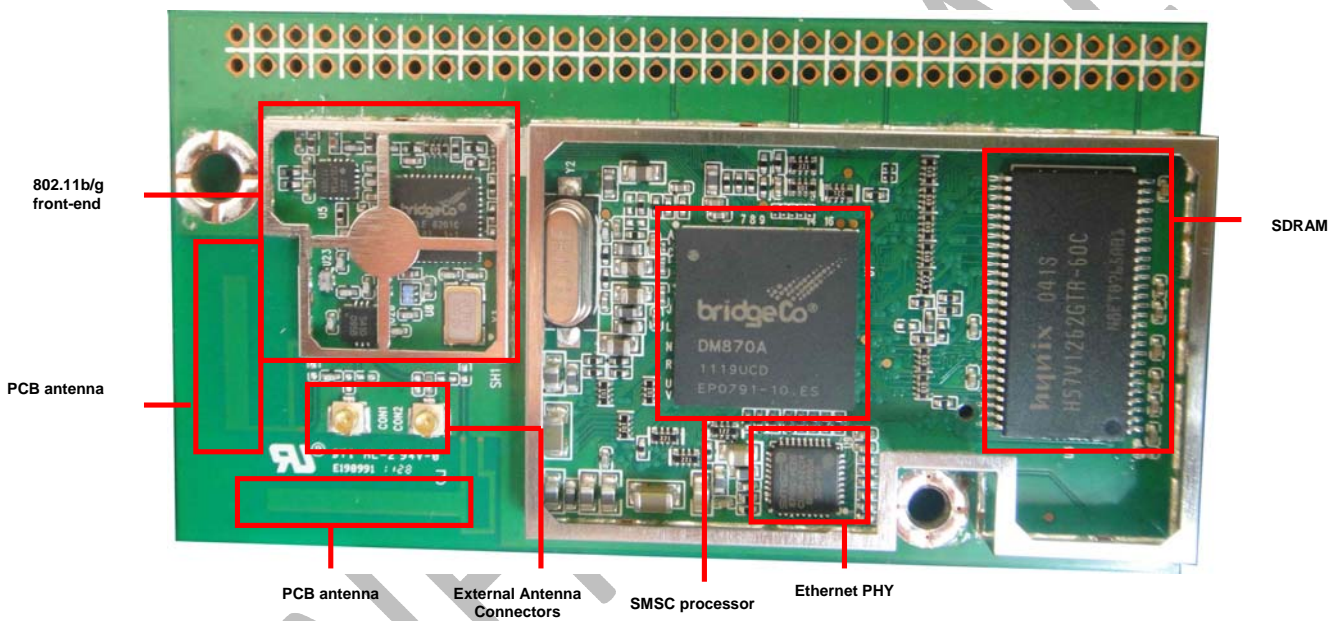

3.2 Bottom View of CX Module

3.2.1 CX Module Bottom View w/64-pin Low Density Connector

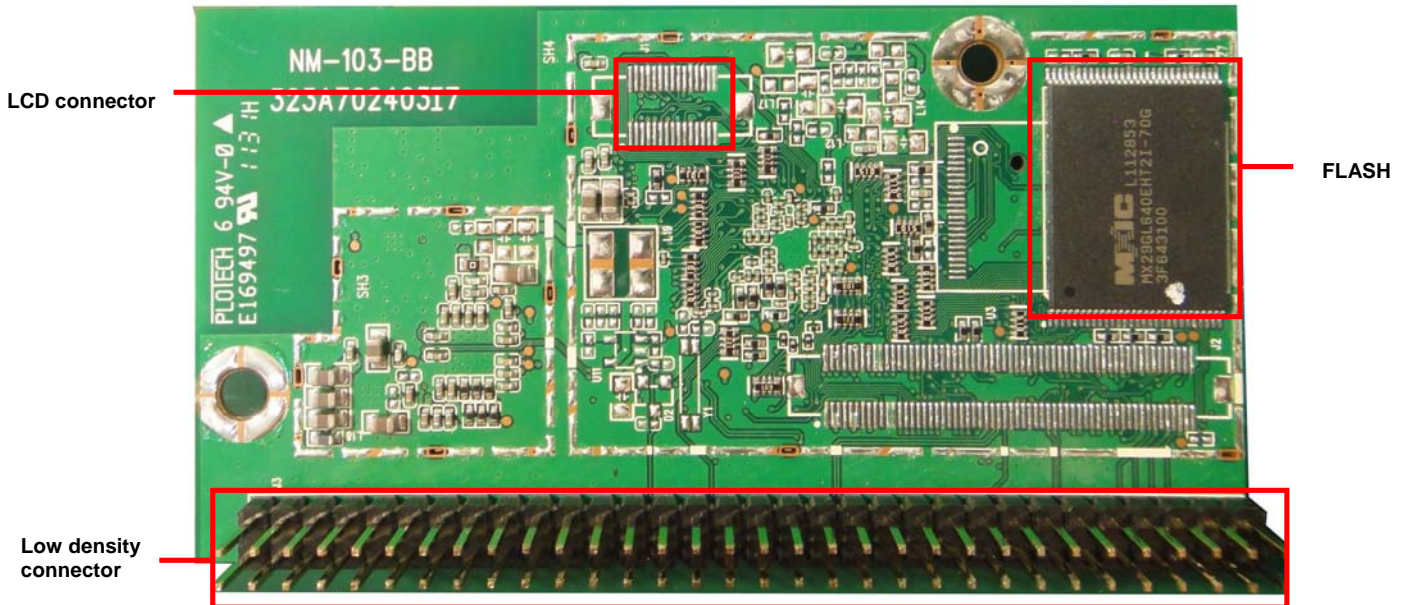

3.2.2 CX Module Bottom View w/120-pin Media Connector

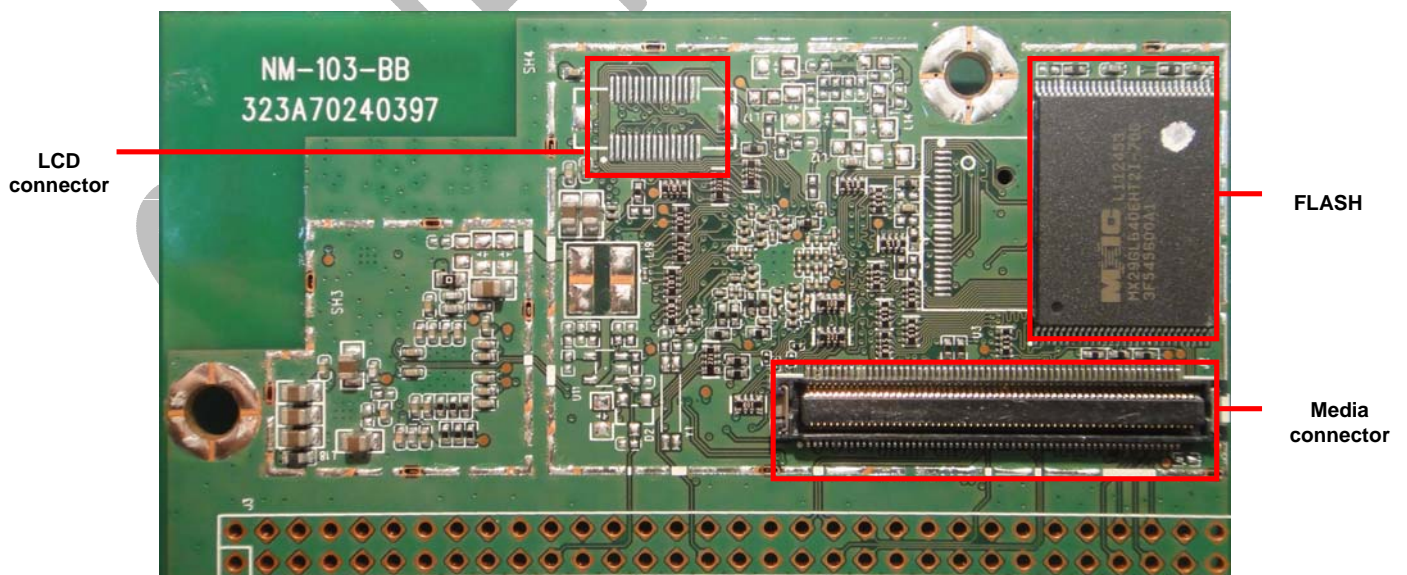

3.3 Production Module with Top and RF shields in place – Top View



3.4 Production Module with 64-pin Connector Option – Side View

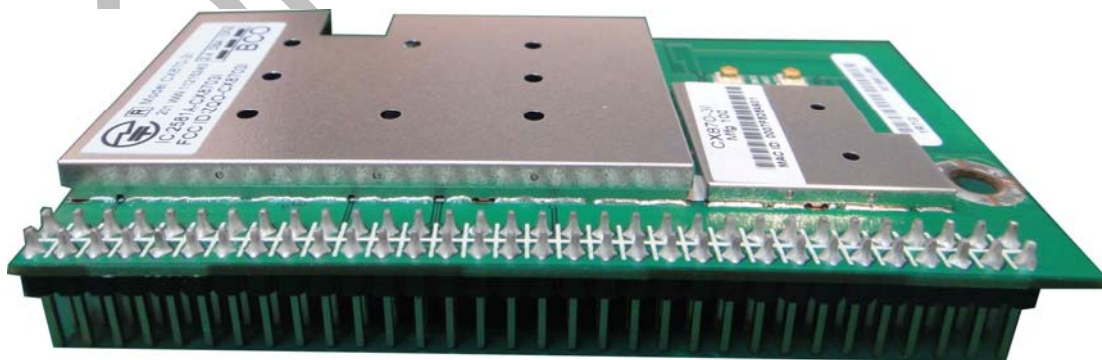

3.5 Example Production Module Showing Soldered RF Shield



3.6 Production Module with Bottom Shield (Part Numbers with a “B” after the configuration letter)

3.6.1 Including J3 Low Density 64-pin connector – Bottom View

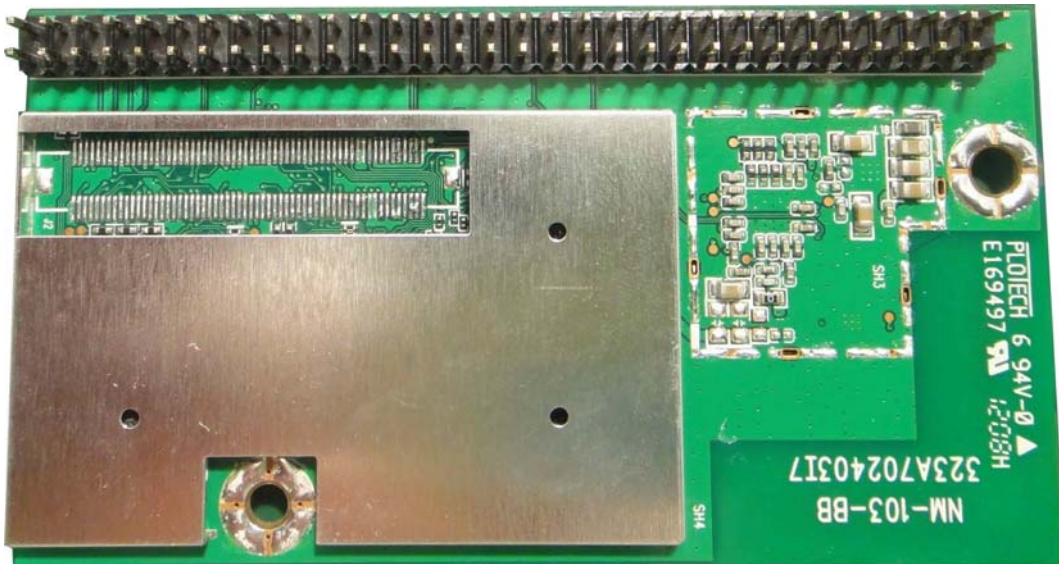

3.6.2 Including J2 High Density 120-pin connector – Bottom View



3.7 CX870-3MB Description

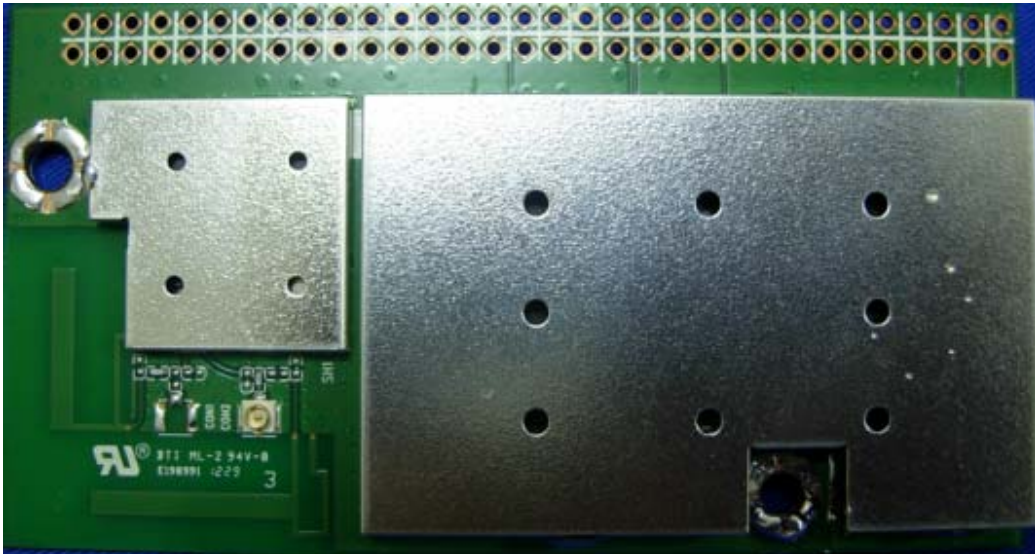

This module only support the action of the main antenna (1T1R), the aux antenna does not perform any action.

CONFIDENTIAL

Ordering Guide

Part Number	Status	SMSC ICs	Internal PCB Diversity Antennas	Ext. Diversity Antennas (UFL Conn.)*		Ethernet	USB Host	Low density 64-pin Conn.	Hi density 120-pin Conn.	Hi density LCD Conn.	32MB SDRAM	16MB SDRAM	8MB SDRAM	1Gb NAND	8MB NOR	Top Module Shield	Bottom Module Shield
				One Ant.	Two Ant.												
CX870-3A	CO	DM870A+T6201	X		(X)*	X	X		X	X	X			X		X	
CX870-3B	O	DM870A+T6201		X		X	X	X			X			X		X	
CX870-3D	CO	DM870A+T6201			X	X	X		X			X		X		X	
CX870-3DS	CO	% DM870A+T6201			X	X	X		X			X		X		X	
CX870-3F	O	DM870A+T6201	X			X	X	X				X			X	X	
CX870-3G	O	DM870A+T6201	X				X	X				X			X	X	
CX870-3H	O	DM870A+T6201			X	X	X	X				X			X	X	
CX870-3I	O	DM870A+T6201			X		X	X				X			X	X	
CX870-3J	O	DM870A+T6201			X		X		X			X			X	X	
CX870-3K	CO	DM870A+T6201	X	X			X	X				X			X	X	
CX870-3BB	SA	DM870A+T6201		X		X	X	X			X			X		X	X
CX870-3HB	SA	DM870A+T6201			X	X	X	X				X			X	X	X
CX870-3IB	SA	DM870A+T6201			X		X	X				X			X	X	X
CX870-3JB	SA	DM870A+T6201			X		X		X			X			X	X	X
CX870-3KB	CA	DM870A+T6201	X	X			X	X				X			X	X	X
CX780-3LB	CA	DM870A+T6201	X	X		X	X		X			X		X		X	X
CX870-3MB	CA	DM870A+T6201	X	X		X	X		X		X			X		X	X
CX875-3PB	SA	DM875+T6201			X		X	X					X		X	X	X

Note: Please note that the Apple Authentication Coprocessor will not be provided on the CX module. The Apple Authentication Coprocessor should be provided on the product motherboard, connected to the SDA, SCL signals from the CX module.

Note: Shaded rows indicate Custom or Obsolete configuration - NOT TO BE USED FOR NEW/STANDARD MP DESIGNS.

Status code: C - Custom | S - Standard | O - Obsolete | A - Available

* Connector on board, but requires board modification to enable the connector.

+ The position of the X in the One Ant. column indicates that there is one external antenna connector provided. The position of the X in the Two Ant. column indicates that there are two external antenna connectors provided. Do not use a module which has two external antenna connectors with only one external antenna connected. Leaving one antenna socket open will degrade WiFi performance. SMSC recommends always using modules with two external antennas for best performance.

% The CX870-3DS is the same as CX870-3D, except that the RF shield is soldered in place.

3.8 Part Number Syntax

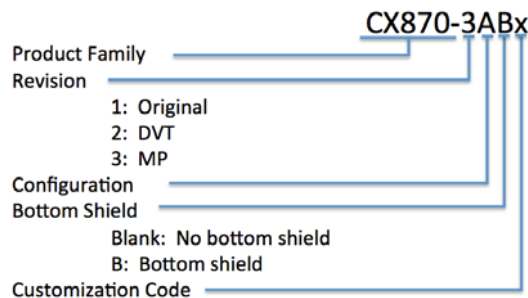

4 Electrical Specifications

Parameter	State	Model	Voltage	Symbol	min.	typ.	max.	Units
Power Supply Input Voltage				VIN	3.0	3.3	3.6	V
					1.08	1.2	1.32	V
					1.8	1.9	2.0	V
Logic Input high voltage				V _{IH}	1.7		5.5	V
Logic Input low voltage				V _{IL}	-0.3		0.7	V
Logic Input threshold voltage				V _{IT}	1.29	1.39	1.5	V
Schmitt-trigger input low to high threshold voltage				V _{IT+}	1.58	1.65	1.71	V
Schmitt-trigger input high to low threshold voltage				V _{IT-}	0.95	1.01	1.06	V
Logic Output high voltage				V _{OH}	2.4			V
Logic Output low voltage				V _{OL}			0.4	V
Logic Low-level output current (V _{OL} =0.4V)				I _{OL}	-9.6	-15.6	-19.3	mA
Logic High-level output current (V _{OH} =2.4V)				I _{OH}	11.1	22.5	35.3	mA
Current Consumption	Reset State	CX870	3.3	I3.3		60	78	mA
			1.2	I1.2		32	42	mA
			1.9	I1.9		18	23	mA
	Operating in idle state		3.3	I3.3		185	241	mA
			1.2	I1.2		337	438	mA
			1.9	I1.9		257	334	mA
	Playback over WiFi high mips & rate condition		3.3	I3.3		240	312	mA
			1.2	I1.2		347	451	mA
			1.9	I1.9		258	335	mA

Note: The maximum current values are 30% larger than the typical values. The maximum values are intended to be used for power supply sizing calculations.

4.1 Absolute Maximum Ratings

Parameter	Component	Min	Max	Units
3.3V Supply Voltage	Main	-0.5	4.6	V
1.2V Supply Voltage		-0.5	1.8	V
1.9V Supply Voltage		-0.5	2.2	V
Logic Input Voltage		-0.5	6	V
Logic Output Voltage		-0.5	4.6	V

4.2 Operating Conditions

Parameter	Min	Max	Units
Operating Temperature	0	+70	°C
Operating Humidity	10	90 (non condensing)	%RH
Storage Temperature	-10	+75	°C
Storage Humidity	10	95 (non condensing)	%RH
Storage Temperature Cycle Test 24 hrs	-10	+75	°C

4.3 WiFi Specification (CX870 only)

Feature	Description
WLAN Standards	IEEE 802.11b IEEE 802.11g
Frequency Band	2.412 – 2.472 GHz (2.4GHz ISM Band, 13 Channels) Channel 1 - Channel 13 North America FCC, Japan Telec, Europe ETSI **FCC only for 2.412-2.462 GHz; Channel 1 – Channel 11
Modulation	802.11b mode (DS-SS: IEEE 802.11b) 802.11g mode (OFDM: IEEE 802.11g)
Transmission Speed	802.11b mode 11Mbps, 5.5Mbps, 2Mbps, 1Mbps 802.11g mode 54Mbps, 48Mbps, 36Mbps, 24Mbps, 18Mbps, 12Mbps, 9Mbps, 6Mbps
Tx Power	802.11b mode: 16.5dBm, +/-1dB 802.11g mode: 15.0dBm, +/-1dB Using nominal production settings as follows: Channel RF11 Rate: 11B = '3' (11Mbps), 11G = '8' (54Mbps) MIB: 11B=9, 11G=1 (Reference for Tx Power Tuning) Room temperature The above TX Power specifications will apply to modules shipped from Liteon after 9 April 2012.
Power-on Ramp	< 2us
RF Carrier Suppression	< 15dBc
TX EVM	802.11b mode: <-22dB 802.11g mode: <-25dB
Rx Sensitivity (incl. CE2 Mother board)	802.11b mode: <=-82dBm @ 1Mbps, <=-81dBm @ 2Mbps, <=-81dBm @ 5.5Mbps, <=-78dBm @ 11Mbps 802.11g mode: <=-82dBm @ 9Mbps, <=-81dBm @ 18Mbps, <=-75dBm @ 36Mbps, <=-70dBm @ 54Mbps
Throughput Rate (measured for each module)	See factory test specification

Note: About Tx Power, different (higher/lower) RF output power settings may be used for specific regions, antennas and/or enclosures, in which case re-certification may be required.

5 Regulatory Compliance and Quality

Description	Country	Compliance	Module Versions Passed
Electromagnetic Compatibility (Prescan)	USA Europe	FCC CFR47 Part15B EN 55022 EN 55024 EN 61000-3-2 EN 61000-3-3 EN 61000-4-2 EN 61000-4-3 EN 61000-4-4 EN 61000-4-5 EN 61000-4-6 EN 61000-4-8 EN 61000-4-11	
Radio Regulations (CX870 only)	USA Japan Canada Europe New Zealand/Australia China Korea	FCC Part 15C Telec IC RSS-210 CE AZ/NZS:4268 SRRC KCC	B, D, F, H, I, J B B, D, F, H, I, J B

SMSC does not certify all module variants for all countries. Please see above table for those module versions for which certain certifications have already been done.

Please contact your SMSC sales office for the latest information about which modules are certified for which countries, and arranging for additional certification for your chosen module if needed. Any additional certifications will need to be paid for by the customer.

Product manufacturers are responsible for the end product certification.

SMSC can help manufacturers to prepare for the WiFi Alliance tests by providing an example test plan and the required commands to enable special test modes. Please contact your SMSC sales office about WiFi Alliance logo certification assistance.

The CX module has received Limited Module Approval (LMA) from FCC. This is because the CX module does not have a built-in +1.9V regulator circuit. SMSC recommends that customers follow the +1.9V supply voltage requirements given in this data sheet, and follow the +1.9V power supply design given in “CX Module Power Supply_V1.1.pdf” document or later version. If the power supply recommendations are followed, then customers will not need to go through formal certification of the product for WiFi related RF behavior for FCC. It is the product manufacturers responsibility to make sure that the power supply recommendations are followed, and that the RF behavior meets the certification requirements when the module is installed in the final product.

Please check the SMSC/BridgeCo Customer Portal at <https://portal.bridgeco.net/> for documents about WiFi certification and recommended interfacing and power supply schematics.

6.0.1 Antenna Considerations

Here are the antennas used for certification:

Cfg Code	Ant. Type	Ant. Gain (dBi)	Ant. Model Name
CX870-3F	Printed on PCB	3.56	Liteon N/A
CX870-3J	Dipole	2	MAG. LAYERS EDA-8709-2G4C1-A66
CX870-3K	PIFA	2.1	MAG. LAYERS MSA-3612-2G4C1-A1
CX870-3IB	Dipole	2	MAG. LAYERS EDA-8709-2G4C1-A66
CX870-3B-D60	PIFA	2 2 1.7 1.7 1.7 1.7 1.7 1.7	MSA-0354-2G4C1-A3, black 200mm (max) MSA-0345-2G4C1-A3, gray 200mm (max) MSA-5103-2G4C1-A1, black 200mm MSA-5403-2G4C1-A1, gray 200mm MSA-5103-2G4C1-A3, black 300mm MSA-5403-2G4C1-A3, gray 300mm MSA-5103-2G4C1-A2, black 400mm MSA-5403-2G4C1-A2, gray 400mm
CX870-3BB	Dipole	3.2	WINiZEN W1E-WO-08
CX870-3HB	Dipole	2	MAG. LAYERS EDA-8709-2G4C1-A66
CX870-3HB	PIFA	3 2.8	3010000243ID (DA-E670) 3010000218ID (DA-E750)
CX870-3MB	Dipole	2.28 1.35 2.29	WIESON Technologies (Y111JT008A-001-S) X-2588-794-1 (SONY) FX01H8B-SN-EF (FOXCONN)

Notes about antenna changes:

- 1) Equivalent antennas from other manufacturers may be substituted, and then marketed without a Class II permissive change
- 2) Equivalent antennas must be of the same type (e.g. dipole, PIFA, etc.), must be of equal or less gain than the antennas listed and previously authorized under the same FCC ID, and must have similar in band and out of band characteristics (consult specification sheet for cutoff frequencies).
- 3) In case of new antenna types, or higher gain antennas, a Class II permissive change is required and compliance with FCC section 15.203 must be met.

6.0.2 CX Power Settings Used For Modular Approval

3B/3I/3J/3H/3IB/3B-D/3B-D60/BB/HB				3K			
FCC				FCC			
11b	2412 (1)	2437 (6)	2462 (11)	11b	2412 (1)	2437 (6)	2462 (11)
	Power setting	Power setting	Power setting		Power setting	Power setting	Power setting
	8	8	9		10	10	10
11g	2412 (1)	2437 (6)	2462 (11)	11g	2412 (1)	2437 (6)	2462 (11)
	Power setting	Power setting	Power setting		Power setting	Power setting	Power setting
	1	0	2		2	2	2
3B/3I/3J/3H/3IB/3B-D/3B-D60/BB/HB				3K			
CE/JP				CE/JP			
11b	2412 (1)	2437 (6)	2472 (13)	11b	2412 (1)	2437 (6)	2472 (13)
	Power setting	Power setting	Power setting		Power setting	Power setting	Power setting
	10	10	10		10	10	10
11g	2412 (1)	2437 (6)	2472 (13)	11g	2412 (1)	2437 (6)	2472 (13)
	Power setting	Power setting	Power setting		Power setting	Power setting	Power setting
	2	2	2		1	1	1
3F				3F			
FCC				CE/JP			
11b	2412 (1)	2437 (6)	2462 (11)	11b	2412 (1)	2437 (6)	2472 (13)
	Power setting	Power setting	Power setting		Power setting	Power setting	Power setting
	8	8	8		10	10	10
11g	2412 (1)	2437 (6)	2462 (11)	11g	2412 (1)	2437 (6)	2472 (13)
	Power setting	Power setting	Power setting		Power setting	Power setting	Power setting
	0	0	1		2	2	2

Measurement conditions: 11b mode at 1Mbps, 11g mode at 6Mbps

3MB				3MB			
FCC				CE/JP			
11b	2412 (1)	2437 (6)	2462 (11)	11b	2412 (1)	2442 (7)	2472 (13)
	Power setting	Power setting	Power setting		Power setting	Power setting	Power setting
	9	8	8		9	9	9
11g	2412 (1)	2437 (6)	2462 (11)	11g	2412 (1)	2442 (7)	2472 (13)
	Power setting	Power setting	Power setting		Power setting	Power setting	Power setting
	1	1	1		1	1	1

5.1 RoHS

Uses only RoHS compliant components

5.2 Environmental Test

Withstands 4 hours at 70°C, 90% RH

5.3 ESD and Transient Test (Applies to LAN and USB external connections only)

ESD: +/- 2kV operation, +/- 4kV no destruction (part of CE test)

Fast electrical transients: +/- 500V operation, +/- 1000V no destruction (part of CE test)

5.4 Magnetic Field Test

Passes EN55022 and EN55024 (part of CE test)

5.5 MTBF

>10000 hours

5.6 Mechanical Specifications

Passes drop test according to I.E.C. 68-2-32, height 100 cm, 1 corner, 6 faces.

Passes vibration test with sine, vertical, 60 minutes, 600 to 18000 cpm, 1G

5.7 Module Quality

Defect Rate: < 1%

AQL CR=0, MA=0.4, MI=0.4

CONFIDENTIAL

6 Board Dimensions and Weight

6.1 Top & Bottom View of CX870 Module without Bottom Shield

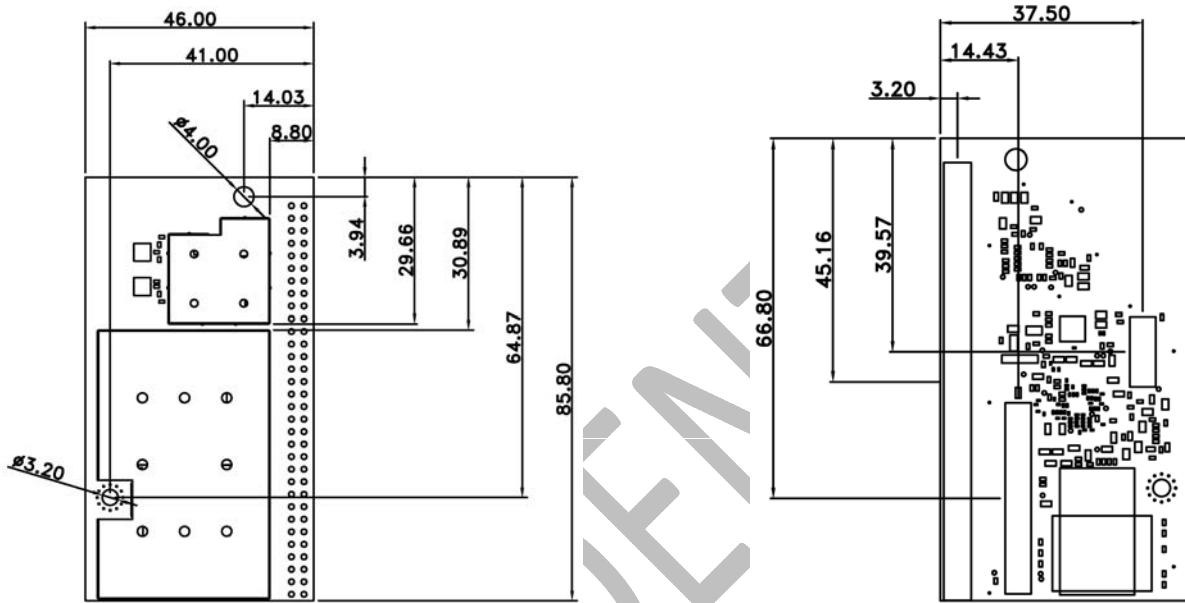

6.1.1 Top & Bottom View of CX Module with Bottom Shield

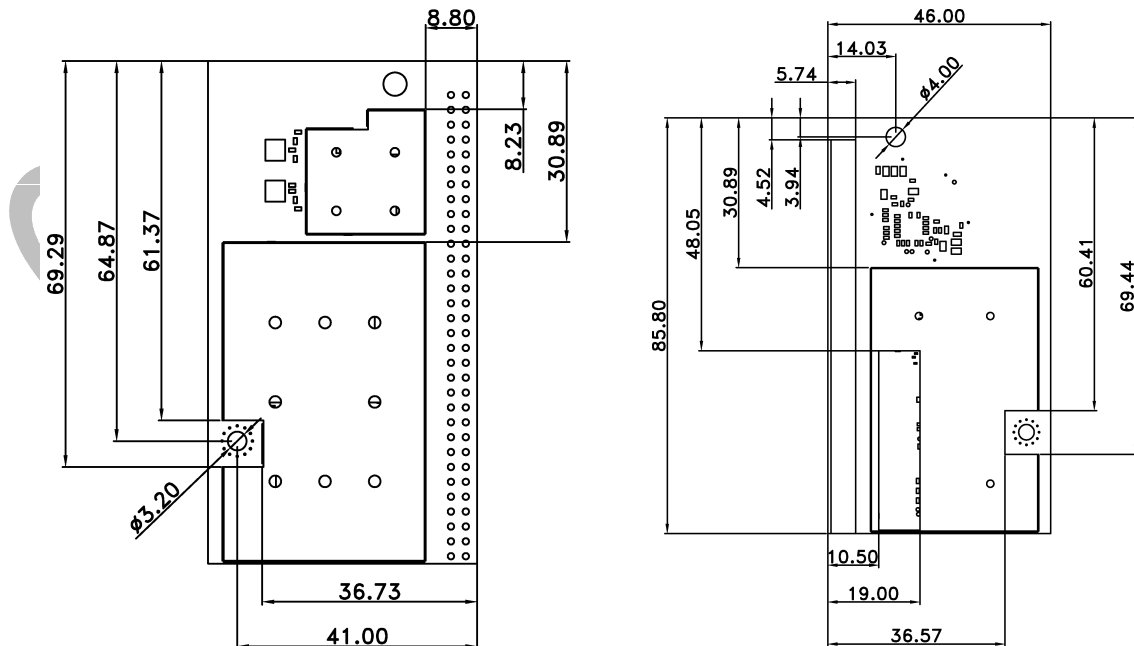

6.2 Side View of CX870 module without Bottom Shield

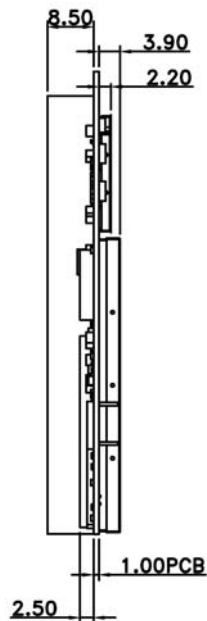

Note:

1. All dimensions are measured in **millimetres** (mm).
2. PCB's thickness: 1.00 +/- 0.10mm
3. Tolerance: +/-0.10mm
4. Outline Tolerance: +/-0.10mm
5. NPTH Hole: +/-0.05mm
6. PTH Hole: +/-0.075mm
7. Connector positions, board dimensions, mounting hole positions and sizes are the same for all module variants.
8. Connector position tolerance: +/- 0.38mm
9. The 64-pin connector mounted on the module along one edge is the male gender.
10. Not all module variants have all connectors. Please see the Ordering Guide table for details of connector options.

6.2.1 Side View of CX Module with Bottom Shield except CX870-3JB

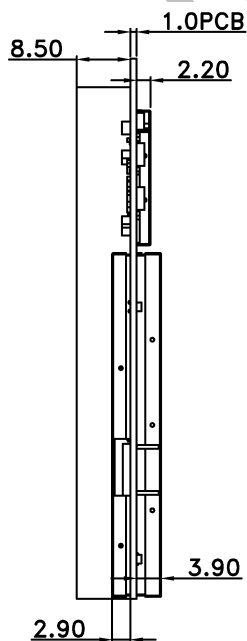

6.2.2 Side View of CX870 Module with Bottom Shield part number CX870-3JB only

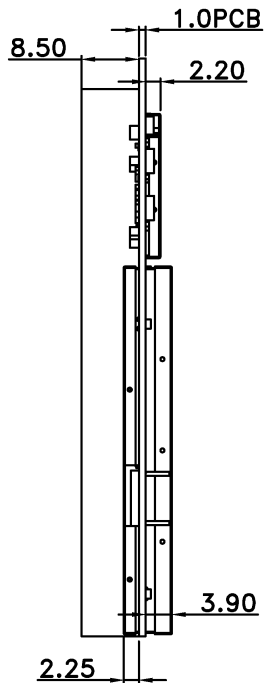

6.3 3D View of CX870 Module without Bottom Shield

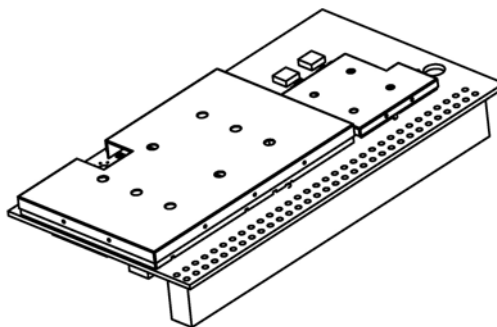

Note: A 3D file of the CX module in .stp format is available from the SMSC Customer Portal.

6.4 Module Weight

CX870: 20g

Note: Module weight applies to all versions of the module.

7 Connectors and Connections

7.1 WLAN UFL Antenna Connector (optional)

The module includes two PCB strip antennas operated in diversity mode. Alternatively, one or two coaxial antenna connectors are provided for connecting external (to the module) antennas. The choice between using the strip antenna or using the coaxial sockets is a build option, determined by the position of surface mount capacitors on the module PCB. If the PCB antennas are chosen, then diversity mode is always used. If external (to the module) antenna sockets are used, then two external antennas should be used to provide 2X diversity operation.

If external antenna is used, please choose the proper part number indicating two external antenna sockets. Do not use a module which has two external antenna sockets with only one external antenna connected; this will result in reduced WiFi performance.

Please see ordering guide for build option details.

The surface-mount antenna socket used in the CX module is:

U.F.L type Ultra Small Surface Mount Coaxial Connector

7.2 Module Connectors

The CX860/870 module uses 3 board-to-board connectors as interfaces to the product main board. The part numbers for the connectors needed on the product main board, which mate with the connectors on the CX module, are shown in the table below.

Connector Number	Connector Purpose	Connector Type	Number of Pins	Pin Configuration	Mating Connector Part Numbers
J1	LCD	B2B Connector	30	2 x 15 x 0.5mm	14-5046-030-145-829+ (Kyocera)
J2	Media		120	2 x 60 x 0.5mm	14-5046-120-145-829+ (Kyocera)
J3	Low Density		64	2 x 32 x 2.54mm	CSHA201-3202A001A1AB

The pinout and signal names are shown on the next page. The following table provides an overview for the most important control and interface signals.

7.2.1 Pin Descriptions

Signal(s)	Type	Description
-----------	------	-------------

POWER

VIN(+3.3V)	P	Power supply input ; +3.3V.
VIN (+1.2V)	P	Power supply input ; +1.2V.
VIN (+1.9V)	P	Power Supply input; +1.9V for powering RF section. Make sure this is a clean supply.
3V3RTC	P	The RTC function is no longer supported. This pin should be left open.
GND	P	Ground (GND) connection for power supply 0V, signal returns and shielding.

SPI

SPI_DOUT	O	SPI data from DM870A to host controller.
SPI_DIN	I	SPI data from host controller to DM870A.
SPI_CLK	I	SPI clock from host controller to DM870A. Maximum recommended frequency is 2MHz, typical frequency is 1MHz. See Note 2 below.
SPI_NCS0	I	SPI chip select from host controller to DM870A.
PDOUT1	O	This signal is used as SPI_REQ, SPI request signal, from DM870A to host controller for eDMP applications. Logic 1 indicates that there is an SPI message waiting to be read, the host controller should start the SPI clock and read any changed registers. Logic 0 indicates that all changed register messages have been read and the message buffer is empty. Also GPIO-06.
SPI_NCS1	I	Not used. Leave open.

UART

RXD1	I	UART1 input to the DM870A, used for shell access. SMSC recommends providing a connection to an external RS-232 transceiver and DB9 connector to connect to a PC COM port. Such a connection can be used for product development debugging, and for module programming control on the product manufacturing line and for module control during certification procedures.
TXD1	O	UART1 output from the DM870A, used for shell access. SMSC recommends providing a connection to an external RS-232 transceiver and DB9 connector to connect to a PC COM port. Such a connection can be used for product development debugging, and for module programming control on the product manufacturing line and for module control during certification procedures.
RXD0	I	UART0 input. Optionally used for controlling an iPod via UART.
TXD0	O	UART0 output. Optionally used for controlling an iPod via UART.

AUDIO

AV2DATA0	O	I2S or left justified audio data output. Typically connected to external D/A converter input or to external DSP for further audio processing. Used for main left and right channel audio output data. See Note 3.
AV2CTRL0	O	LRCK, audio data word clock at the audio sample rate (Fs). Maximum currently supported frequency is 192kHz.
AV2CTRL1	O	MCLK, audio master clock at 256Fs. This can be used to clock an external D/A converter or DSP.
AV2CLK	O	SCLK, audio data bit clock at 64Fs. Allows for up to 32 audio data bits per sample word.
AV4DATA1	O	SPDIF format output. Can support samples rates up to 192kHz, so the maximum instantaneous frequency on this pin is 24.576MHz.
AV4DATA0	I	SPDIF input. Not used at present. Leave open.
AV2DATA1	O	I2S or left justified audio data output. Not used at present. Leave open.
AOUTLP/AOUTLN, AOUTRP/AOUTRN	O	Differential stereo output from PWM-DAC, right and left channels. These signals require analog low pass filtering. SMSC is not recommending using the PWM-DAC outputs because of the potential for high out-of-band noise and uncharacterized audio quality. SMSC recommends using an external D/A converter connected to AV2DATA0.
AV2DATA2	I	I2S or left justified audio data input. Can be driven from an optional external A/D converter used to interface to iPod analog output or other analog audio sources. If not used, leave open.
AV2DATA3	I	I2S or left justified audio data input. Not used at present. Leave open.

CONTROL

NCS3	I	This signal is configured as GPIO-17 and is currently not used. DM870A-internal pull-up. Leave this pin open.
PDOUT0	I	Factory Reset. GPIO-04. Return the CnE to factory settings. High-active input, DM870A-internal pull-down. Pull to GND with a 10kohm resistor, unless return to factory settings from a hardware control is needed. Normally, return to factory settings is controlled from the host controller via SPI register. This pin is only monitored during the boot up process.
VCO0	I	Infrared sensor input. GPIO-05. This is a Schmitt-Trigger input and can handle inputs with slow slopes. Used for aDMP firmware builds for infrared remote control sensor output connection to DM870A. For applications with a host controller, pull this pin to +3.3V via a 10kohm resistor.
AV3CLK	O	ETH_NRESET Low-active reset for the on-board ethernet PHY. This output is driven by the DM870A. GPIO-12. Leave this pin open.
AV3CTRL0, AV3CTRL1	I/O	I2C_SCL, I2C_SDA bus created by GPIO-13 and GPIO-14. No internal pull-ups; Use 4.7kohm pull up resistor on each pin to +3.3V. Maximum frequency is 400kHz.
NRESET_MOD	I	Low-active input to reset the module. This signal must be driven by an external reset generator, or by a GPIO output from a host controller. See the application section of this data sheet for the timing requirements for NRESET_MOD. Includes internal 10K pull-up resistor to +3.3V.
NPD_RF	I	Active low input to shut down the power for the 802.11 RF section. Internal 10kohm pull-up resistor to +3.3V. Leave open if powering down the RF section is not required.

Datasheet

ETHERNET

ETH_RXN, ETH_RXP, ETH_TXN, ETH_TXP	M	Ethernet signals between the PHY on the module and the external magnetics (transformer). See Note 4. Maximum bit rate is 100Mbps.
ETH_LED_SPEED, ETH_LED_ACT	O	3.3V push-pull outputs (max. $\pm 12\text{mA}$) to drive the ethernet LEDs. 100Mbps speed mode and activity are indicated by the outputs being low. Connect to LEDs through 220ohm resistors.

USB

USB_DN, USB_DP	M	USB data signals, normally connected to type A connector, USB switch or iPod dock connector. Maximum bit rate is USB High Speed at 480Mbps.
USB_VBUS	M	Analog input for monitoring USB type A connector power. Connect to the +5V power which is driving the USB type A connector power pins. If this pin drops below 4.6V, then the DM870A will drive the USBVBUSDRV signal low to control an external power MOSFET to disconnect +5V power from the USB type A connector. See Note 5.
USBVBUSDRV	O	Logic output to control an external MOSFET that is in series with USB type A connector power. See USB_VBUS above and Note 5.

JTAG

TMS,TCK,TDI, TDO	I/O	JTAG port for DM870A. Leave open.
------------------	-----	-----------------------------------

SSM

SSMD4, SSMD5, SSMD6, SSMD7	I/O	Can be used to drive external shift registers to make extended GPIO signals (see Note 6), or as individual GPIO signals, or to make an SD card interface. SD card firmware is not supported at present in JB2. Can be mapped to GPIO #s 08,09,10,11. Leave open if not used.
SSMD0, SSMD1, SSMD2, SSMD3, SSMCLK, SSMCP, SSMCMD, SSMWP	I/O	Used to make an SD card interface. SD card firmware is not supported at present in JB2. Leave open.

VIDEO

AV0CLK, AV0CTRL0, AV0CTRL1, AV0CTRL2, AV0DATA0, AV0DATA1, AV0DATA2, AV0DATA3, AV1DATA0, AV1DATA1, AV1DATA2, AV1DATA3	O	ITU-R BT.656 digital video output signals. Optionally used to make a TVout menu display, or to display decoded album art. Can be connected to video D/A converter (see Note 7), or connected to a video DSP.
--	---	--

GPIO (not already mentioned elsewhere in this table)

A22	O	GPIO18 Reserved for NOR flash address A22. Leave open.
A23	O	GPIO-16 Reserved for NOR flash address A23. Leave open.
NWAIT	I/O	GPIO-15 Not currently assigned. Leave open.
NCS2	I	GPIO-19 Assigned to iPod dock connector iPod NDETECT. See Note 8.
VCO1	I/O	GPIO-07 Not currently assigned. Leave open.
MIICRS	I/O	GPIO-00 Not currently assigned. Leave open.
MIICOL	I/O	GPIO-01 Not currently assigned. Leave open.
MIITXER	I/O	GPIO-02 Not currently assigned. Leave open.
MIITXCLK	I/O	GPIO-03 iPod dock connector Accessory Power signal. See Note 8.

MII

MIITXD0, MIITXD1, MIIRXD0, MIIRXD1	I/O	Can be used, with GPIO signals above, to drive an external ethernet PHY. This is not supported by JB2 firmware. Leave open.
------------------------------------	-----	---

LCD

LCDD0, LCDD1, LCDD2, LCDD3, LCDD4, LCDD5, LCDD6, LCDD7, LCDD8, LCDD9, LCDD10, LCDD11, LCDD12, LCDD13, LCDD14, LCDD15, LCD16, LCD17, LCDCLK, LCDCTRL0, LCDCTRL1, LCDCTRL2, LCDCTRL3	O	Uses optional J1 LCD connector. Connect to local LCD display. See Note 9. Leave open if not used.
--	---	---

Datasheet

Notes:

1. Signal type codes:
 - I – 3.3V level Digital Logic Input into the DM870A
 - O – 3.3V level Digital Logic Output from the DM870A
 - IO – 3.3V level Digital Logic Input and Output (bi-directional) signal
 - M – Miscellaneous, see text for description
 - P – Power Supply
2. For SPI timing diagram for eDMP applications, please see:
BridgeCo_JB2x - DeviceControlProtocol_Registers_v_2_1.pdf, or later version.
For detailed setup and hold timing details, see DM870A IC data sheet:
DM870A DS rev. 1.3_12-15-11.pdf, or later version.
3. For audio port timing diagrams, and for detailed setup and hold timing, please see DM870A IC data sheet:
DM870A DS rev. 1.3_12-15-11.pdf, or later version.
4. For example ethernet external schematic, see:
CX Module Ethernet (RJ45 + Ext.Magnetics)_V1.2.pdf, or later version.
This schematic is typically compressed into a zip file, for example:
CX Module_Interface Schematics_one_page_V1.2_Jun_11.rar
5. For example USB schematics, see:
CX Module USB_V1.2.pdf, or later version.
This schematic is typically compressed into a zip file, for example:
CX Module_Interface Schematics_one_page_V1.2_Jun_11.rar
6. For example use of extended GPIO shift registers, see CE2 schematic:
A EVMCE2-4_schematic.pdf, or later version.
7. For example connection to a video D/A converter, see CE2 schematic:
A EVMCE2-4_schematic.pdf, or later version.
8. iPod dock connector pin and GPIO assignments are under discussion. Please contact SMSC for recommendations for iPod dock connections to CX870 module.
9. For example connection to an LCD display, see CE2 schematic:
A EVMCE2-4_schematic.pdf, or later version.
10. All the above signals are brought out to J2 pins. Not all the above signals are brought out to J3, the 64-pin low density connector. The J3 pin assignments table shows which signals are brought out to the J3 pins.
11. SMSC has a set of example motherboard schematics that shows example external circuitry that is typically connected to the module. Please check the SMSC/BridgeCo customer portal at <https://portal.bridgeco.net/> for a copy of these example schematics. These schematics are typically compressed into a zip file, for example:
CX Module_Interface Schematics_one_page_V1.2_Jun_11.rar
12. Please check the SMSC/BridgeCo Customer Portal *Download* area for the latest version of the SMSC documents. Go to <https://portal.bridgeco.net/>. If you do not have an account, please contact SMSC.

7.2.2 Connector PIN Assignments

J2 – Media Connector

Function	GPIO	IC PIN	Signal	PIN Number	Signal	IC PIN	GPIO	Function
			GND	1	2			
			VIN (+3.3V)	3	4			
			VIN (+3.3V)	5	6			
			GND	7	8			
			VIN (+1.2V)	9	10			
			VIN (+1.2V)	11	12			
			GND	13	14			
			VIN (+1.9V)	15	16			
			GND	17	18			
			3V3RTC	19	20			
			GND	21	22			
			GND	23	24			
SPI		D15	SPI_DOUT	25	26			JTAG
		D14	SPI_DIN	27	28			
		B16	SPI_CLK	29	30			
		C13	TXD0	31	32			SPI
		B14	RXD0	33	34			
Debug UART		A14	RXD1	35	36			Module reset input
		B13	TXD1	37	38			
			GND	39	40			
SPI_E_NCS	GPIO-11	D12	SSMD7	41	42			GPIO-10 GPIO-08
SPI_E_SDI	GPIO-09	B12	SSMD5	43	44			
		D11	SSMD3	45	46			
		A11	SSMD0	47	48			
		C10	SSMCLK	49	50			
		D10	SSMCP	51	52			
			GND	53	54			
USB		A1	USB_DN	55	56			USB
		B1	USB_DP	57	58			
		E3	USBVBUSDRV	59	60			
			GND	61	62			
		K4	AOUTLP	63	64			
		L2	AOUTLN	65	66			
			GND	67	68			
			A23	69	70			
	GPIO-16	H17	A22	71	72			
	GPIO-18	H16	A22	71	72			
I2C SDA	GPIO-14	T3	AV3CTRL1	73	74			
I2C SCL	GPIO-13	U2	AV3CTRL0	75	76			
Video Output		M3	AV0CTRL2	77	78			Video Output
		M2	AV0CTRL1	79	80			
		L1	AV0CLK	81	82			
		M4	AV0DATA3	83	84			
		N1	AV0DATA2	85	86			
		N2	AV0DATA1	87	88			
		N3	AV0DATA0	89	90			
			GND	91	92			
LRCK		T1	AV2CTRL0	93	94			MCLK
A/D data 1		P4	AV2DATA3	95	96			
A/D data 0		R3	AV2DATA2	97	98			SCLK
D/A data 1		T2	AV2DATA1	99	100			
D/A data 0		U1	AV2DATA0	101	102			
			GND	103	104			
Ethernet			ETH_RXN	105	106			Ethernet
			ETH_RXP	107	108			
				109	110			
			ETH_TXN	111	112			
			ETH_TXP	113	114			
				GND	115	116		
	GPIO-15	K18	NWAIT	117	118			
			NPD_RF	119	120			
			GND	119	120			

Note: The IC PIN column indicates the pin number on the DM860A or DM870A integrated circuit. This allows for easy cross-reference to the DM860A or DM870A data sheet information.

J1 – LCD Connector

Function	GPIO	IC PIN	Signal	PIN Number		Signal	IC PIN	GPIO	Function
			GND	1	2	GND			
LCD Interface		V8	LCDD0	3	4	LCDD1	U8	LCD Interface	
		T8	LCDD2	5	6	LCDD3	R8		
		V7	LCDD4	7	8	LCDD5	U7		
		T7	LCDD6	9	10	LCDD7	R7		
		V6	LCDD8	11	12	LCDD9	U6		
		T6	LCDD10	13	14	LCDD11	R6		
		V5	LCDD12	15	16	LCDD13	U5		
		T5	LCDD14	17	18	LCDD15	V4		
		U4	LCDD16	19	20	LCDD17	V3		
			GND	21	22	GND			
LCD Interface		T10	LCDCCLK	23	24	LCDCCTRL0	R9	LCD Interface	
		T9	LCDCCTRL1	25	26	LCDCCTRL2	U9		
		V9	LCDCCTRL3	27	28	GND			
			GND	29	30	GND			

Note: The IC PIN column indicates the pin number on the DM860A or DM870A integrated circuit. This allows for easy cross-reference to the DM860A or DM870A data sheet information.

J3 – Low Density Connector

Function	GPIO	IC PIN	Signal	PIN Number		Signal	IC PIN	GPIO	Function
			GND	1	2	GND			
			VIN (+3.3)	3	4	RXD0	B14		
			VIN (+3.3)	5	6	TXD0	C13		
			GND	7	8	GND			
			VIN (+1.9)	9	10	VIN (+1.2)			
			VIN (+1.9)	11	12	VIN (+1.2)			
			GND	13	14	GND			
Free	GPIO-15	K18	NWAIT	15	16	RXD1	A14	Debug UART	
iPod NDETECT	GPIO-19	J17	NCS2	17	18	TXD1	B13		
		D13	NRESET	19	20	GND			
			3V3RTC	21	22	AV2CTRL1	R2	MCLK LRCK SCLK A/D data 0 D/A data 0 SPDIF output SPDIF input	
			GND	23	24	AV2CTRL0	T1		
SPI		D14	SPI_DIN	25	26	AV2CLK	R1		
		D15	SPI_DOUT	27	28	AV2DATA2	R3		
		B16	SPI_CLK	29	30	AV2DATA0	U1		
		C15	SPI_NCS0	31	32	AV4DATA1	T2		
Free	GPIO-17	H18	NCS3	33	34	AV4DATA0	V2		
			GND	35	36	GND			
E-GPIO_NCS/TBA	GPIO-11	D12	SSMD7	37	38	USB_DN	A1	USB	
I2C SDA	GPIO-14	T3	AV3CTRL1	39	40	USB_DP	B1		
I2C SCL	GPIO-13	U2	AV3CTRL0	41	42	USBVBUSDRV	E3		
			GND	43	44	USB_VBUS	D2		
SPI_REQ	GPIO-06	J1	PDOUT1	45	46	GND			
Factory Reset	GPIO-04	K1	PDOUT0	47	48	SSMD5	B12	GPIO-09	E-GPIO_SDI/TBA
IR input	GPIO-05	K2	VCO0	49	50	SSMD4	A12	GPIO-08	E-GPIO_SDO/TBA
			GND	51	52	GND			
Ethernet			ETH_LED_SPEED	53	54	ETH_LED_ACT			Ethernet
iPod Access Power	GPIO-03	R12	MIITXCLK	55	56	SSMD6	C12	GPIO-10	E-GPIO_CLK/TBA
Ethernet			ETH_RXN	57	58	ETH_RXP			Ethernet
			ETH_TXN	59	60	ETH_TXP			Ethernet
			GND	61	62	MIICOL	T13	GPIO-01	Free
Free	GPIO-00	R14	MIICRS	61	62	GND			
			GND	63	64	GND			

Note: The IC PIN column indicates the pin number on the DM860A or DM870A integrated circuit. This allows for easy cross-reference to the DM860A or DM870A data sheet information.

7.2.3 GPIO Assignments

GPIO Assignments for J3 64-pin Low Density Connector

GPIO	PIN Name	PIN Number	Function
00	MIICRS	61	Free
01	MIICOL	62	Free
03	MIITXCLK	55	iPOD Access Power
04	PDOOUT0	47	Factory Reset
05	VCO0	49	IR Input
06	PDOOUT1	45	Host NIREQ
08	SSMD4	50	E_GPIO_SDO/TBA
09	SSMD5	48	E_GPIO_SDI/TBA
10	SSMD6	56	E_GPIO_CLK/TBA
11	SSMD7	37	E_GPIO_NCS/TBA
13	AV3CTRL0	41	I2C_SCL
14	AV3CTRL1	39	I2C_SDA
15	NWAIT	15	Free
17	NCS3	33	Free
19	NCS2	17	IPOD NDETECT

Note: Not all 20 GPIO signals are brought out to J3 64-pin low density connector. For the CX870-3K, GPIOs 00, 01 and 03 are not brought out to J3 64-pin low density connector. J3 pin numbers 61, 62 and 55 are not connected to any signal in the CX870-3K module.

8 Application Guidelines

8.1 Power Supply sequencing and Reset Timing

There are strict power sequencing and reset timing requirements.

- Power up the I/O voltage (3.3V) first and hold NRESET_MOD low.
- The core voltage (1.2V) must never be higher than (I/O voltage +0.5 V).
- The core voltage (1.2V) must be within the specified core voltage limits less than 300ms after the I/O voltage (3.3V) reaches the specified I/O voltage limits.
- Throughout the power down process, the 3.3V supply must maintain a higher voltage than the 1.2V supply, until both have reached ground potential.
- To assure a proper IC reset, the power supplies must be present for a minimum time of 2ms before NRESET_MOD is de-asserted.

Please see the power and reset timing figure in Section 9.1.1 below.

About 1.9V, the arrival of 1.9V supply should lag behind the arrival of the 3.3V. The delay between the 1.9V and the 3.3V is not critical. Typical delay is approximately 10ms, for example using 10kohm resistor and 0.1uF capacitor on the enable pin of a 1.9V dc-to-dc converter.

8.1.1 Power up, Reset and Power Down Timing

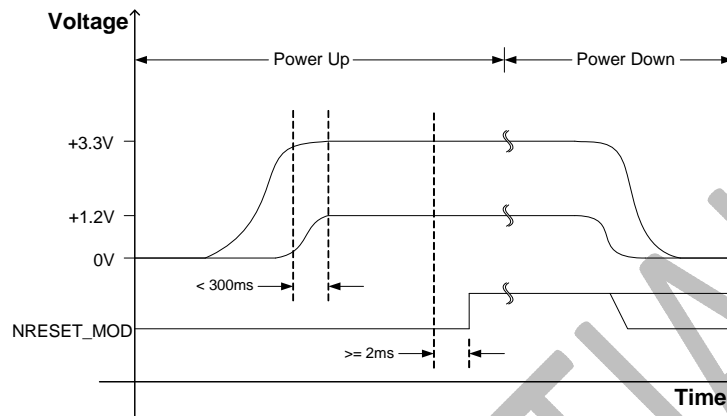

8.2 RF Considerations

Note that overall system, RF and WiFi performance is significantly affected by the product design, environment and the application. It is the responsibility of the product designer to ensure proper system level shielding (if required) and to verify performance and fitness for the given product features and applications.

The WiFi performance will be affected by the RF environment surrounding the CX module. Please ensure that the CX module is positioned in a “quiet” RF environment, as far away as possible from high frequency clock signals and any other sources of RF energy. Also, make sure the antenna is not shielded by any metal objects, for example loudspeakers or other metal parts. Please make sure that the power supplies, in particular the +1.9V supply, are quiet and free from noise.

SMSC recommends that systems implementing AirPlay should use a module configuration that includes on-module shielding, as well as paying particular attention to system configuration and shielding. In particular, SMSC is recommending the use of the Bottom Shield versions of the modules, which allows greater freedom in antenna positioning.

Also, please see the SMSC Application Note: [SMSCAppNote - CX870_Antenna_Placement_V1_4.pdf](#) regarding antenna positioning guidelines.

Please see below picture for the recommended keep out area and cable routing for the antennas.

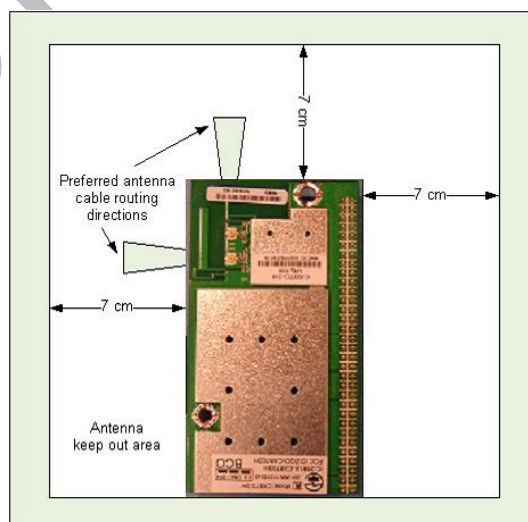

9 Revision Control

Revision	Date / Author	Details of Change	Reason for Change
V2.8 (093012)	Sept 30, 2012 / SHs	Updated Section 4 Ordering Guide with 2 new rows for CX870-3LB & CX870-3MB and moved the row for CX870-3KB to be with them.	New SKUs available.
V2.8 (092412)	Sept 24, 2012 / SHs	<p>Updated cover page with new Microchip logo; removed SMSC logo from header; removed SMSC logo & address from legal text (page 2); added info about Microchip to legal text; updated © to 2012.</p> <p>Updated filename to 'CX_Module_DS_Rev2-8_MM-DD-YY.pdf'.</p> <p>Removed CX860 from Section 7.4 Module Weight.</p> <p>Updated left side of footer to 'SMSC CX Module'.</p> <p>Updated title of Section 7.1.1 to 'Top & Bottom View of CX Module with Bottom Shield'.</p> <p>Updated title of Section 7.2.1 to 'Side View of CX Module with Bottom Shield except CX870-3JB'.</p> <p>In Sections 3.1, 3.2, 3.2.1 & 3.2.2, updated occurrences of 'CX870' to 'CX Module'.</p> <p>Updated Section 4 Ordering Guide to remove rows for CX870-3DB and CX870-3DBS, and add a row for CX870-3KB.</p> <p>Removed 'I2C' box, arrow & label in Section 2 Block Diagram.</p>	<p>Microchip purchased SMSC.</p> <p>Data covers all CX modules.</p> <p>No CX860 module available.</p> <p>Data sheet is for all CX modules.</p> <p>Drawings are for all CX modules.</p> <p>Drawings are for all CX modules.</p> <p>Pictures are for all CX modules.</p> <p>Updated to show actual status.</p> <p>Correction.</p>
V2.8 (090912)	Sept 9, 2012 / SHs	<p>Updated Section 2 Block Diagram to show obscured black lines leading out from LCD & SSM blocks.</p> <p>In Section 2 Block Diagram changed "DM860A or DM870A" to "DM870A or DM875"</p> <p>In Section 1 Introduction, changed "DM860A and DM870A" to "DM870A and DM875"</p> <p>In Section 4 Ordering Guide, added a 'Status' column and status code key.</p> <p>In Section 4 Ordering Guide, added row for CX875-3PB.</p> <p>In Section 4 Ordering Guide, changed "SMSC IC's" heading to "SMSC ICs".</p> <p>In Section 6.0.1 Antenna Considerations, replaced text list with a new table.</p> <p>Added a new section 6.0.2 CX Power Settings Used For Modular Approval.</p> <p>In Section 6 Regulatory Compliance and Quality, updated the Compliance entry for New Zealand / Australia for Radio Regulations from "CE" to "AZ/NZS:4268"</p> <p>In Section 9.2 RF Considerations, changed the application note file path from "App Note Antenna Placement recommendation CX870 modules rev1.1.pdf" to "SMSCAppNote - CX870_Antenna_Placement_V1_4.pdf"</p>	<p>Correction.</p> <p>CX module uses DM870A and DM875.</p> <p>CX module uses DM870A and DM875.</p> <p>To show current availability status of each module version.</p> <p>To give details of newly available module version.</p> <p>Correction.</p> <p>Updated information and in a clearer format.</p> <p>To provide more details about CX module power settings.</p> <p>Updated information.</p> <p>Provide most up to date Application Note file.</p>

Datasheet

Revision	Date / Author	Details of Change	Reason for Change
		In Section 9.2 RF Considerations, added note & picture regarding recommended keep out area and cable routing for antennas. In Notes of Section 8.2.1 Pin Descriptions, added text regarding schematics being compressed into zip files to Notes 4, 5 & 11.	Provide information about keep out areas and cable routing. Provide further information about schematic files.
V2.7 (061312)	June 13, 2012 / SHs	In Section 4 Ordering Guide, made rows for CX870-3B, 3H, 3I, 3J shaded.	All new designs should use modules with a bottom shield, so modules without a bottom shield are now marked as "NOT TO BE USED FOR NEW/STANDARD MP DESIGNS" by shading the rows in the Ordering Guide table for those modules with no bottom shield.
V2.6 (050812)	May 8, 2012 / SHs	Removed entries in '8MByte NOR' column for modules 3A, 3B, 3D, 3DS in Section 4 Ordering Guide	Correction.
V2.5 (042212)	April 22, 2012 / SHs	Updated title of Section 7.2.1 Side View of CX870 Module with Bottom Shield to include "...except CX870-3JB" Added Section 7.2.2 Side View of CX870 Module with Bottom Shield part number CX870-3JB only	Reflect addition of separate section (7.2.2) for the CX870-3JB module. CX870-3JB has thinner bottom shield than other modules.
V2.4 (032312)	March 23, 2012 / SHs	Added IC PIN entry for MIICRS in J3 Low Density Connector table in Section 8.2.2 Connector PIN Assignments. Changed "MMIICRS" to "MIICRS" in Section 8.2.3 GPIO Assignments. Changed "MMIICRS" to "MIICRS" in J3 Low Density Connector table in Section 8.2.2 Connector PIN Assignments. Changed "MMIICRS" to "MIICRS" in GPIO table in Section 8.2.1 Pin Descriptions. Added important note text to Tx Power row in Section 5.3 WiFi Specification. Removed the 'm' from "+/-1dBm" in the Tx Power row in Section 5.3 WiFi Specification.	CX module uses DM870A. Correction. Correction. Correction. To indicate which modules the Tx Power specifications relate to. Correction.
V2.4 (031712)	March 17, 2012 / SHs	In Section 5.3 WiFi Specifications, updated Transmission Speed entry In Section 4 Ordering Guide, changed all occurrences of DM870 to DM870A & DM860 to DM860A In Section 2 Block Diagram, changed all occurrences of DM870 to DM870A & DM860 to DM860A In Section 1 Introduction, changed all occurrences of DM870 to DM870A & DM860 to DM860A In Section 8.2.1 Pin Descriptions, changed all occurrences of DM870 to DM870A In the Notes for Section 8.2.1 Pin Descriptions, changed <i>dat_DM870_16_datasheet.pdf</i> to <i>DM870A DS rev. 1.3_12-15-11.pdf</i> Changed all occurrences of DM870 to DM870A throughout the datasheet. Updated J1, J2 & J3 tables in Section 8.2.2 Connector PIN Assignments, changing DM870 to DM870A.	Add missing 2Mbps speed. CX module uses DM870A. CX module uses DM870A. CX module uses DM870A. CX module uses DM870A. CX module uses DM870A. CX module uses DM870A. CX module uses DM870A. CX module uses DM870A.

Datasheet

Revision	Date / Author	Details of Change	Reason for Change
		<p>Changed "WiFi (on-module PCB diversity)" column heading to "Internal PCB Diversity Antennas" in Section 4 Ordering Guide</p> <p>Added 'FCC' to North America in Frequency Band entry in Section 5.3 WiFi Specification</p> <p>Updated TX EVM entry in Section 5.3 WiFi Specifications</p> <p>Updated Rx Sensitivity entry in Section 5.3 WiFi Specifications</p> <p>Updated Tx Power entry in Section 5.3 WiFi Specifications</p>	<p>Improve clarity of meaning.</p> <p>Specify North American WiFi regulatory certification body.</p> <p>Update values to better reflect actual performance.</p> <p>Update values to better reflect actual performance.</p> <p>Show test conditions.</p>
V2.4 (031212)	March 12, 2012 / SHs	<p>Added Section 3.6 Production Module with Bottom shield (Part Numbers with a "B" after the configuration letter)</p> <p>Added Section 3.6.1 Including J3 Low Density 64-pin connector - Bottom View</p> <p>Added Section 3.6.2 Including J2 High Density 120-pin connector - Bottom View</p>	<p>Show module versions with bottom shield.</p> <p>Show bottom shield.</p> <p>Show bottom shield.</p>
V2.4 (031012)	March 10, 2012 / SHs	<p>Updated Section 4 Ordering Guide & Section 4.1 Part Number Syntax drawing with bottom shield versions</p> <p>Added another note to Section 8.2.3 GPIO Assignments</p> <p>Updated TX Power row in Section 5.3 WiFi Specification (CX870 only)</p> <p>Added Section 7.1.1 Top & Bottom View of CX870 Module with Bottom Shield</p> <p>Added Section 7.2.1 Side View of CX870 Module with Bottom Shield</p> <p>Added a note to Section 7.3 3D View of CX870 Module</p> <p>Added additional text to Section 9.2 RF Considerations</p>	<p>Bottom shield versions added to table and Syntax drawing.</p> <p>Document missing GPIOs for CX870-3K.</p> <p>Show improved tolerances for TX power.</p> <p>Show drawings of module with Bottom Shield.</p> <p>Show drawings of module with Bottom Shield.</p> <p>To indicate availability of digital copy of 3D view of module.</p> <p>Providing further recommendations regarding the use of bottom shield versions and to indicate the availability of a pdf about antenna positioning guidelines.</p>
V2.3 (112011)	November 20, 2011 / SHs	<p>Added CX870-3DS option to Section 4 Ordering Guide</p>	<p>To indicate soldered shield version.</p>
V2.2 (110811)	November 8, 2011 / SHs	<p>Added CX870-3K option to Section 4 Ordering Guide.</p>	<p>Added -3K option.</p>
V2.1 (100711)	October 7, 2011 / SHs	<p>Updated title of Section 6.1 from "1 RoHS" to "RoHS".</p> <p>In Section 10 Revision Control table, updated an entry for V2.0 b in the Reason for Change column from "RTV" to "RTC"</p> <p>Removed "Preliminary Datasheet" from the footer.</p> <p>Removed the word "Preliminary" from the title page.</p>	<p>Correcting typo.</p> <p>Correcting typo.</p> <p>CX module is in production, so the datasheet is no longer preliminary.</p> <p>CX module is in production, so the datasheet is no longer preliminary.</p>
V2.0 (100211)	October 2, 2011 / SHs	<p>Updated Section 5.3 WiFi Specification "TX Power" entry for 802.11g</p> <p>Updated Section 6.0.1 Antenna Considerations with updated module numbering scheme</p> <p>Updated Section 6.7 Module Quality with new Defect Rate</p>	<p>Correspond to actual production test limits.</p> <p>Revert to original module numbering scheme.</p> <p>Data is now available.</p>

Datasheet

Revision	Date / Author	Details of Change	Reason for Change
		Updated Section 4.1 Part Number Syntax with removal of Antenna Configuration number and Note	Revert to original part numbering scheme.
		Updated Section 10 Revision Control with new Reason for Change column	Corporate standard.
V2.0 (092611)	Sept. 26, 2011 / SHs	Change from BridgeCo logos and disclaimer text to SMSC logos and disclaimer text	Corporate standard.
		Updated location of red boxes in Section 3.2.1 CX870 Bottom View with 64-pin Low density connector	Improve alignment of red box to photo.
		Updated location of red boxes in Section 3.2.2 CX870 Bottom View with 120-pin Media connector	Improve alignment of red box to photo.
		Moved Section 5.3 WiFi Specification on to one page	Improve readability.
		Updated Customer Portal information in Section 6 Regulatory Compliance and Quality	Easier to access URL directly.
		Reverted Antenna Considerations back to Section 6.0.1; subsequently all subsections in Section 6 reverted back to original numbering	Decided to keep original part numbering scheme to avoid unnecessary paper work and the need to redo certifications.
		Updated Notes 11 & 12 in Section 8.2.1 Pin Descriptions with updated Customer Portal information	Easier to access URL directly.
		Updated Table of Contents	Keep TOC aligned with actual content.
V2.0 c	Sept. 14, 2011 / SHs	Updated font styling of Table of Contents	Easier to read.
		Update Section 2 Block Diagram : moved RJ45+Transformer & USB Type A boxes inside the drawing boundary	Improve accuracy of drawing.
		Updated Section 5.3 WiFi Specification (CX870 only) TX Power Description entry	Align data with test limits.
		Updated Section 5.3 WiFi Specification (CX870 only) Rx Sensitivity Description entry	Align data with test limits.
		Updated Section 5.3 WiFi Specification (CX870 only) : add a Note underneath the table	Clarification of the possible effect of changing the TX Power setting.
		Updated Section 4 Ordering Guide : changed CX870-3D row Two Ant entry from (X)* to X	Change to match final CX870-3D configuration.
		Updated Section 4 Ordering Guide : removed the two blank rows	Improve readability.

Datasheet

Revision	Date / Author	Details of Change	Reason for Change
V2.0 b	Sept. 10, 2011 / SHs	<p>Updated the Description for pin NCS3 in Section 8.2.1 Pin Descriptions</p> <p>Updated Section 4 Ordering Guide : added gray background to CX870-3F & CX870-3G</p> <p>Updated Section 4 Ordering Guide : removed the 2 from A, H, I & J version Part Numbers</p> <p>Updated Section 4 Ordering Guide : split Ext. Diversity Antennas column into two, added two sub-columns "One Ant." & "Two Ant.", moved Xs to correspond with correct sub-column</p> <p>Updated Section 4 Ordering Guide : CX870-3D : removed X from WiFi column</p> <p>Updated Section 4 Ordering Guide : updated + Note text</p> <p>Updated Section 4 Ordering Guide : moved the + from Part Numbers column to Ext. Diversity Antennas column</p> <p>Updated Section 4 Ordering Guide : removed # Note completely</p> <p>Updated Section 4.1 Part Number Syntax : Updated graphic</p> <p>Updated Section 4.1 Part Number Syntax : Updated Note text</p> <p>Updated text in Section 8.1 WLAN UFL Antenna Connector</p> <p>Removed RTC elements from Section 2 Block Diagram</p> <p>Updated the Description for pin 3V3RTC in Section 8.2.1 Pin Descriptions</p>	<p>Update to align with actual use.</p> <p>Internal antenna versions are not available until performance issues are resolved.</p> <p>Decided to keep original part numbering scheme to avoid unnecessary paper work and the need to redo certifications.</p> <p>Show the number of external antenna connections.</p> <p>CX870-3D is not configured for internal antenna.</p> <p>Explained about one or two external antenna options.</p> <p>Proper link for "+" Note.</p> <p>Content now covered by "+" Note</p> <p>Explain antenna configuration field</p> <p>Explain about one or two antenna configuration.</p> <p>Remove references to part numbering scheme which includes the number of antennas, and repeat advice to use two external antennas.</p> <p>Support for RTC is removed.</p> <p>Support for RTC is removed.</p>
V2.0 a	August 22, 2011 / SHs	<p>Added Section 3.5 Example Production Module Showing Soldered RF Shield</p>	<p>Photo shows that RF shield is soldered, needed for Japan Telec certification.</p>
V2.0	August 12, 2011 / SHs	<p>Updated Note Section 4.1 Part number syntax</p> <p>Updated all Section 3 Board Pictures to new versions + inserted new Sections 3.2.1 & 3.2.2 which show two different bottom views</p>	<p>Highlighted that CX870-3D does not follow the new part numbering scheme. This Note was subsequently deleted, so this is not relevant any more.</p> <p>Improve accuracy of data sheet photos.</p>
V1.9 c	August 2, 2011 / SHs	<ul style="list-style-type: none"> • Updated Key Features on Title page: removed (optional) from "WiFi-certified 802.11b/g" entry • Updated Antenna Configuration entry in Section 4.1 Part number syntax 	
V1.9 b	July 28, 2011 / SHs	<ul style="list-style-type: none"> • Updated Section 4.1 Part number syntax <ul style="list-style-type: none"> ○ Updated graphic ○ Added a Note • Changed intro text in Section 3 Board Pictures • Updated Section 4 Ordering Guide <ul style="list-style-type: none"> ○ Changed CX870-3B1 to CX870-3B ○ Updated the text for + note ○ Added a note to CX870-3B Ext. Diversity Antenna column ○ Added a new # note 	

Datasheet

Revision	Date / Author	Details of Change	Reason for Change
		<ul style="list-style-type: none"> Added Section 6.0.1 Antenna Considerations 	
V1.9 a	July 25, 2011 / SHs	<ul style="list-style-type: none"> Inserted new photo for Section 3.1 Top View of CX870 Inserted new photo for Section 3.2 Bottom View of CX870 Added new Section 3.3 Production Module with Top & RF shields Added new Section 3.4 Production Module with 64-pin Connector Option Updated Section 4 Ordering Guide <ul style="list-style-type: none"> Added gray background to CX870-3D Changed CX870-3A to CX870-3A2 Changed CX870-3B to CX870-3B1 Changed CX870-3H to CX870-3H2 Changed CX870-3I to CX870-3I2 Changed CX870-3J to CX870-3J2 Added a Note to the Part Number title Updated Section 8.1 WLAN UFL Antenna Connector with new text Updated Section 5.3 WiFi Specification TX EVM entry to -9dB@6MHz Updated Section 6 Regulatory Compliance & Quality with Module Versions Passed for Radio Regulations entries Replaced the Note in Section 6 to be main body text and updated the text. Added new Section 4.1 Part number syntax Updated module weight to 20g 	
V1.8 a	July 10, 2011 / SHs	<ul style="list-style-type: none"> Update section 8.1 WLAN UFL Antenna Connector Deleted section 8.1.1 Coaxial antenna connector dimensions 	
V1.8	July 5, 2011 / SHs	<ul style="list-style-type: none"> Updated the acceptable surface-mount receptacle parts in Section 8.1 WLAN UFL Antenna Connector Added Appendix 1: Certification Notices 	
V1.7 c	May 13, 2011 / SHs	<ul style="list-style-type: none"> Updated "Module Quality" Defect Rate field entry Updated "Board Dimensions & Weight" drawings Updated the "Electrical Specifications" table Added another Note to the "Pin Descriptions" section 	
V1.7 b	May 11, 2011 / SHs	<ul style="list-style-type: none"> Updated Note 8 in "Pin Descriptions" table Re-imported "Board Dimensions & Weight" drawings Updated "Board Pictures" images Updated board photo on Cover page 	

Datasheet

Revision	Date / Author	Details of Change	Reason for Change
		<ul style="list-style-type: none"> Updated the Feature list on Cover page Updated J1, J2 & J3 "Connector PIN Assignments" tables: removed Power column & re-organised columns Changed "Application Notes" title to "Application Guidelines" Updated Copyright date to "2011" Updated Table of Contents font styling 	
V1.7 a	May 6, 2011 / SHs	<ul style="list-style-type: none"> Re-imported Block Diagram as a wmf file Updated "Power up, Reset & Power down Timing" figure Updated "Pin Descriptions" table Re-organised text in "Power Supply sequencing & Reset Timing" Re-imported J2 & J3 Connector PIN Assignment tables 	
V1.7	May 4, 2011 / SHs	<ul style="list-style-type: none"> Added note to Module Weight section Updated the Ordering Guide – Part Numbers & added new J version Added new text to the Board Pictures section Updated all Mechanical Drawings and added & removed Notes Updated the J3 Low Density Connector table Updated the GPIO Assignment table Added new Power Supply & Timing figure Updated the text in the "Power Supply sequencing and Reset Timing" section Updated the Key Connections table Updated "Key Connections" section title to "Pin Descriptions" Updated "Detailed Connector PIN Descriptions" section title to "Connector PIN Assignments" Updated J2 Media Connector table 	
V1.6 d	March 3, 2011 / SHs	<ul style="list-style-type: none"> Updated J3 Low Density Connector table Update GPIO Assignments section and table 	
V1.6 c	February 24, 2011 / SHs	<ul style="list-style-type: none"> Updated all mechanical drawings in "Board Dimensions and Weights" section Deleted warning note in "Board Dimensions and Weights" section 	
V1.6 b	February 23, 2011 / SHs	<ul style="list-style-type: none"> Updated "J3-Low density connector" pin description table Updated "GPIO Assignments" table 	
V1.6	February 11, 2011 / SHs	<ul style="list-style-type: none"> Entirely updated the "Ordering Guide" Added a Note to the "Ordering Guide" Updated the subsection titles for the "Board Pictures" section Updated the Block Diagram – changed 'WiFi Antenna' to 'Ext. Antenna' 	
V1.5 b	January 27, 2011 / SHs	<ul style="list-style-type: none"> Added Note to "Board Dimensions and Weight" section 	
V1.5 a	January 24, 2011 / SHs	<ul style="list-style-type: none"> Updated the "Ordering Guide" – removed Mfg column and consolidated into one table 	

Datasheet

Revision	Date / Author	Details of Change	Reason for Change
		<ul style="list-style-type: none"> Updated the Header to reflect Preliminary nature of datasheet 	
V1.5	January 22, 2011 / SHs	<ul style="list-style-type: none"> Updated the datasheet to be a Preliminary Datasheet Added new feature to Summary on Front Page Updated “J3 - Low Density Connector” table Updated “GPIO Assignments” table Added note to “Board Dimensions & Weight – Side Views of CX870 module” section Updated text in “Application Notes – Power Supply Sequencing & Reset Timing” section Updated “Block Diagram” Updated text in “Connectors & Connections – WLAN UFL Antenna Connector” section 	
V1.4 b	January 11, 2011 / SHs	<ul style="list-style-type: none"> Updated the Application Notes, RF Considerations section 	
V1.4	January 3, 2011 / SHs	<ul style="list-style-type: none"> Updated the module photo on the Title page Updated the Application Notes, RF Considerations section 	
V1.3	December 23, 2010 / SHs	<ul style="list-style-type: none"> Updated Ordering Guide Added Notes to Ordering Guide Updated Block Diagram Updated “J3 – Low Density Connector” table Updated “Electrical Specifications” table Added Power Consumption data to “Electrical Specifications” table Updated the Board Dimensions and Weight images Updated the “GPIO Assignments” table Added another Application Note Added titles to Application Notes 	
V1.2	December 19, 2010 / SHs	<ul style="list-style-type: none"> Inserted CX860 and CX870 Module Weights Updated module image on Front Page 	
V1.1	December 13, 2010 / SHs	<ul style="list-style-type: none"> Added the Ordering Guide. Updated the Block Diagram. Updated the “Electrical Specifications” table Updated the “Absolute Maximum Ratings” table Updated the Notes for “Regulatory Compliance and Quality” section Updated “Key Connections” table Updated “J2 – Media Connector” table Updated “J3 – Low Density Connector” table Updated “GPIO Assignments” table Added Board Pictures Replaced Mechanical Drawings in “Board Dimensions and Weight” section 	

JukeBlox Networked Media Modules – CX Series
Datasheet

Revision	Date / Author	Details of Change	Reason for Change
V1.0	October 18, 2010 / SHs	<ul style="list-style-type: none">Initial Version	

CONFIDENTIAL

10 Appendix 1: Certification Notices

Federal Communications Commission Interference Statement

This equipment has been tested and found to comply with the limits for a Class B digital device, pursuant to part 15 of the FCC Rules. These limits are designed to provide reasonable protection against harmful interference in a residential installation. This equipment generates, uses and can radiate radio frequency energy and, if not installed and used in accordance with the instructions, may cause harmful interference to radio communications. However, there is no guarantee that interference will not occur in a particular installation. If this equipment does cause harmful interference to radio or television reception, which can be determined by turning the equipment off and on, the user is encouraged to try to correct the interference by one or more of the following measures:

- Reorient or relocate the receiving antenna.
- Increase the separation between the equipment and receiver.
- Connect the equipment into an outlet on a circuit different from that to which the receiver is connected.
- Consult the dealer or an experienced radio/ TV technician for help.

CAUTION:

Any changes or modifications not expressly approved by the grantee of this device could void the user's authority to operate the equipment.

Labeling requirements

This device complies with Part 15 of the FCC Rules. Operation is subject to the following two conditions: (1) this device may not cause harmful interference, and (2) this device must accept any interference received, including interference that may cause undesired operation.

RF exposure warning

This equipment must be installed and operated in accordance with provided instructions and the antenna(s) used for this transmitter must be installed to provide a separation distance of at least 20 cm from all persons and must not be co-located or operating in conjunction with any other antenna or transmitter. End-users and installers must be provided with antenna installation instructions and transmitter operating conditions for satisfying RF exposure compliance.

Information for the OEMs and Integrators

The following statement must be included with all versions of this document supplied to an OEM or integrator, but should not be distributed to the end user.

This device is intended for OEM integrators only. Please see the full Grant of Equipment document for other restrictions. This device must be operated and used with a locally approved access point.

Information To Be Supplied to the End User by the OEM or Integrator

The following regulatory and safety notices must be published in documentation supplied to the end user of the product or system incorporating an adapter in compliance with local regulations.

Host system must be labeled with "Contains FCC ID: PPQ-CX8703"X"" & "Contain IC: 4491A-CX870"X"", FCC ID & IC ID displayed on the label. The label text should be updated according to the table shown in Ordering Guide section of this document. The proper letter shown in Ordering Guide Part Number column should be substituted for "X". For example, for the CX870-3MB module, the label text should be "Contains FCC ID: PPQ-CX8703MB" & "Contains IC: 4491A-CX8703MB".

Datasheet

Canada, Industry Canada (IC) Notices

This Class B digital apparatus complies with Canadian ICES-003 and RSS-210.

Operation is subject to the following two conditions: (1) this device may not cause interference, and (2) this device must accept any interference, including interference that may cause undesired operation of the device.

Radio Frequency (RF) Exposure Information

The radiated output power of the Wireless Device is below the Industry Canada (IC) radio frequency exposure limits. The Wireless Device should be used in such a manner such that the potential for human contact during normal operation is minimized.

This device has also been evaluated and shown compliant with the IC RF Exposure limits under mobile exposure conditions. (antennas are greater than 20cm from a person's body).

This device has been certified for use in Canada. Status of the listing in the Industry Canada's REL (Radio Equipment List) can be found at the following web address:

<http://www.ic.gc.ca/app/sitt/reitel/srch/nwRdSrch.do?lang=eng>

Additional Canadian information on RF exposure also can be found at the following web address:

<http://www.ic.gc.ca/eic/site/smt-gst.nsf/eng/sf08792.html>

Canada, avis d'Industry Canada (IC)

Cet appareil numérique de classe B est conforme aux normes canadiennes ICES-003 et RSS-210.

Son fonctionnement est soumis aux deux conditions suivantes : (1) cet appareil ne doit pas causer d'interférence et (2) cet appareil doit accepter toute interférence, notamment les interférences qui peuvent affecter son fonctionnement.

Informations concernant l'exposition aux fréquences radio (RF)

La puissance de sortie émise par l'appareil de sans fil Dell est inférieure à la limite d'exposition aux fréquences radio d'Industry Canada (IC). Utilisez l'appareil de sans fil Dell de façon à minimiser les contacts humains lors du fonctionnement normal.

Ce périphérique a également été évalué et démontré conforme aux limites d'exposition aux RF d'IC dans des conditions d'exposition à des appareils mobiles (les antennes se situent à moins de 20 cm du corps d'une personne).

Ce périphérique est homologué pour l'utilisation au Canada. Pour consulter l'entrée correspondant à l'appareil dans la liste d'équipement radio (REL - Radio Equipment List) d'Industry Canada rendez-vous sur:

<http://www.ic.gc.ca/app/sitt/reitel/srch/nwRdSrch.do?lang=eng>

Pour des informations supplémentaires concernant l'exposition aux RF au Canada rendez-vous sur:

<http://www.ic.gc.ca/eic/site/smt-gst.nsf/eng/sf08792.html>