

**GSM850 test report  
for  
RH-49**

## CONTENTS

1	LABORATORY INFORMATION .....	4
2	CUSTOMER INFORMATION .....	4
3	SUMMARY OF TEST RESULTS .....	5
4	EUT INFORMATION .....	6
4.1	EUT description .....	6
5	EUT TEST SETUPS .....	6
6	APPLICABLE STANDARDS .....	6
7	RADIATED RF OUTPUT POWER .....	7
7.1	Test setup .....	7
7.2	Test method .....	7
7.3	EUT operation mode .....	8
7.4	Limit .....	8
7.5	Results .....	8
7.6	EUT operation mode .....	9
7.7	Limit .....	9
7.8	Results .....	9
8	99% OCCUPIED BANDWIDTH .....	10
8.1	Test setup .....	10
8.2	EUT operation mode .....	11
8.3	Results .....	11
8.4	Screen shots .....	11
8.5	EUT operation mode .....	12
8.6	Results .....	12
8.7	Screen shots .....	12
9	BANDEDGE COMPLIANCE .....	13
9.1	Test setup .....	13
9.2	EUT operation mode .....	13
9.3	Limit .....	13
9.4	Results .....	14
9.5	Screen shots .....	14
9.6	EUT operation mode .....	15
9.7	Limit .....	15
9.8	Results .....	16
9.9	Screen shots .....	16
10	SPURIOUS RADIATED EMISSION .....	18
10.1	Test setup .....	18
10.2	Test method .....	18
10.3	EUT operation mode .....	19
10.4	Limit .....	19
10.5	Results .....	19
10.6	EUT operation mode .....	20
10.7	Limit .....	20
10.8	Results .....	20
11	FREQUENCY STABILITY, TEMPERATURE VARIATION .....	21
11.1	Test setup .....	21
11.2	EUT operation mode .....	21
11.3	Limit .....	21
11.4	Test method .....	21
11.5	Results .....	22
12	FREQUENCY STABILITY, VOLTAGE VARIATION .....	23
12.1	Test setup .....	23
12.2	EUT operation mode .....	23
12.3	Limit .....	23

---

12.4	Test method .....	23
12.5	Results .....	23
13	TEST EQUIPMENT .....	24
13.1	Conducted measurements .....	24
13.2	Radiated measurements .....	24
14	TEST SETUP PHOTOGRAPHS.....	26

## 1 LABORATORY INFORMATION

Test laboratory:	TCC Tampere Sinitaival 5 FIN-33720 TAMPERE
	Tel. +358 7180 46800 Fax. +358 7180 46880
FCC registration number:	94436 (June 14, 2002)
IC file number:	IC 3608 (March 5, 2003)

## 2 CUSTOMER INFORMATION

Client:	Nokia Corporation Nokia Technology Platform Lise-Meitner-Strasse 10 D-89081 Ulm / Germany
	Tel. +49 731 1754 6728 Fax. +49 731 1754 6806
Contact person:	Thomas Reitmayer
Receipt of EUT:	28.5.2004
Date of testing:	31.5.- 17.6.2004
Date of report:	20.6.2004

The tests listed in this report have been done to demonstrate compliance with the applicable requirements in FCC rules Part 22 and IC standard RSS-132.

Contents approved:

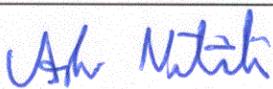
Name
Position

### 3 SUMMARY OF TEST RESULTS

Section in CFR 47	Section in RSS-132		Result
§2.1046 (a), 22.913 (a)	6.4	Conducted RF output power	-
§22.913 (a)	6.4	Radiated RF output power	PASS
§2.1049 (h)	4.2	99% occupied bandwidth	PASS
§22.917 (a)	4.5	Bandedge compliance	PASS
§22.917 (a), §2.1051	4.5	Spurious emissions at antenna terminals	-
§22.917 (a), §2.1053	4.5	Spurious radiated emissions	PASS
§2.1055 (a)(1)(b)	6.3	Frequency stability, temperature variation	PASS
§2.1055 (d)(1)(2)	6.3	Frequency stability, voltage variation	PASS

PASS      Pass  
 FAIL      Fail  
 X          Measured, but there is no applicable performance criteria  
 -          Not done

---

## 4 EUT INFORMATION

The EUT and accessories used in the tests are listed below. Later in this report only EUT numbers are used as reference.

	Device	Type	S/N	EUT number
<b>EUT</b>	GSM phone	RH-49	004400281793180	3405
	GSM phone	RH-49	004400281793131	3407
	GSM phone	RH-49	004400281793099	3413
<b>Accessories</b>	Battery	BL-5B	L103C20101819	3409
	Battery	BL-5B	L103C20100990	3411
	Battery	BL-5B	L103C20101775	3414
	Dummy battery	SF-17D	03618	3417

Notes: -

### 4.1 EUT description

The EUT is a dual band (850 MHz/1900 MHz) E-GPRS (Edge) GSM mobile phone.

The EUT was not modified during the tests.

## 5 EUT TEST SETUPS

For each test the EUT was exercised to find out the worst case of operation modes and device configuration.

The test setup photographs are in a separate document as referenced in section 14.

## 6 APPLICABLE STANDARDS

The tests were performed in guidance of CFR 47 part 22, part 2, ANSI/TIA/EIA-603-A and RSS-132. Deviations, modifications or clarifications (if any) to above mentioned documents are written in each section under "Test method" for each test case.

## 7 RADIATED RF OUTPUT POWER

EUT	3413		
Accessories	3414		
Temp, Humidity, Air Pressure	22 °C	45 RH%	998 mbar
Date of measurement	17.6.2004		
FCC rule part	§22.913 (a)		
RSS-132 section	6.4		
Measured by	Jari Jantunen		
Result	PASS		

### 7.1 Test setup

The EUT was set on a non-conductive turn table in a semi anechoic chamber. In the corner of the chamber there was a communication antenna, which was connected to the BS simulator located outside the chamber. The radiated power from the EUT was measured with an antenna fixed to a antenna tower. The tower and turn table were remotely controlled to turn the EUT and change the antenna polarization. The measured signal was routed from the measuring antenna to the spectrum analyzer. The BS simulator was used to set the TX channel and power level and modulate the TX signal with different bit patterns.

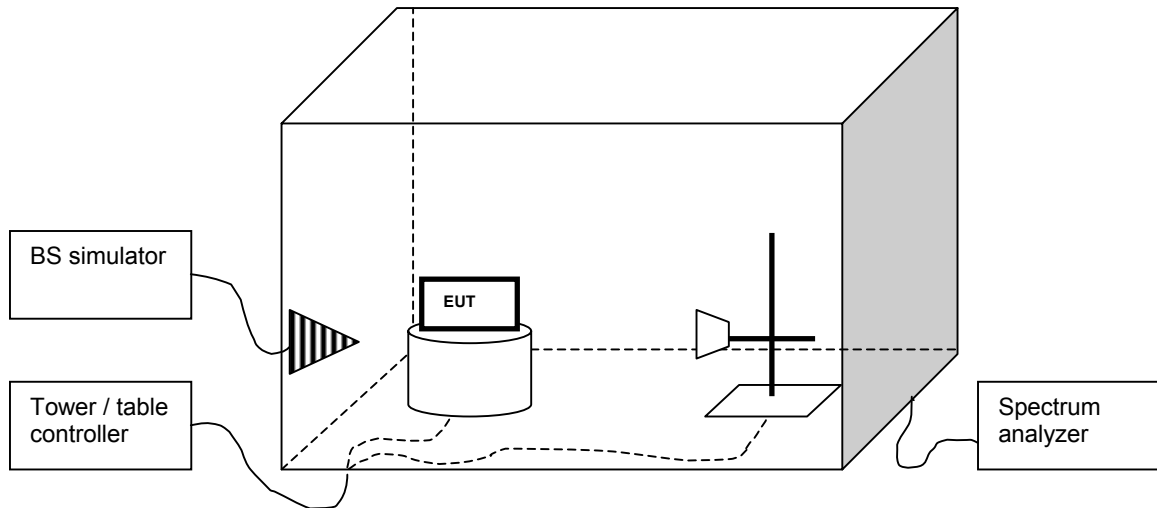

### 7.2 Test method

- a) The maximum power level was searched by moving the turn table and measuring antenna and manipulating the EUT. This level ( $P_{EUT}$ ) was recorded.
- b) The EUT was replaced with a substituting antenna.
- c) The substituting antenna was fed with the power ( $P_{Subst\_TX}$ ) giving a convenient reading on the spectrum analyzer. That reading ( $P_{Subst\_RX}$ ) on spectrum analyzer was recorded.

### 7.3 EUT operation mode

EUT operation mode	TX on, 1 time slot transmission, PRBS 2E9-1 audio modulation, GMSK modulation
EUT channel	128, 190, 251
EUT TX power level	4 (33dBm)

### 7.4 Limit

ERP [W]	
FCC	≤ 7
IC	≤ 6.3

### 7.5 Results

The formula below was used to calculate the ERP.

$$P_{ERP[W]} = \frac{10^{(P_{Subst\_TX[dBm]} + (P_{EUT[dBm]} - P_{Subst\_RX[dBm]}) + G_{Substitute\_antenna[dBd]} - L_{Cable[dB]}) / 10}}{1000}$$

where the variables are as follows:

- $P_{EUT [dBm]}$  Measured power level (from step a in 7.2) from the EUT
- $P_{Subst\_TX [dBm]}$  Power (from step c in 7.2) fed to the substituting antenna
- $P_{Subst\_RX [dBm]}$  Power (from step c in 7.2) received with the spectrum analyzer
- $G_{Substitute\_antenna [dBd]}$  Gain of the substitutive antenna over dipole (dBi – 2.15dB)
- $L_{Cable [dB]}$  Loss of the cable between signal generator and the substituting antenna

EUT Channel	$P_{EUT [dBm]}$	$P_{Subst\_TX [dBm]}$	$P_{Subst\_RX [dBm]}$	Cable loss [dB]	Antenna gain [dBd]	ERP [dBm]	ERP [W]
128	-4.50	+10	-26.86	3.84	-1.35	27.17	0.521
190	-3.31	+10	-26.45	3.94	-1.25	27.95	0.624
251	-2.15	+10	-25.95	4.00	-1.15	28.65	0.733



## 7.6 EUT operation mode

EUT operation mode	TX on, 1 time slot transmission, PRBS 2E9-1 audio modulation, 8PSK modulation
EUT channel	128, 190, 251
EUT TX power level	4 (33dBm)

## 7.7 Limit

ERP [W]	
FCC	≤ 7
IC	≤ 6.3

## 7.8 Results

The formula below was used to calculate the ERP.

$$P_{ERP[W]} = \frac{10^{(P_{Subst\_TX[dBm]} + (P_{EUT[dBm]} - P_{Subst\_RX[dBm]}) + G_{Substitute\_antenna[dBd]} - L_{Cable[dB]}) / 10}}{1000}$$

where the variables are as follows:

$P_{EUT}$ [dBm]	Measured power level (from step a in 7.2) from the EUT
$P_{Subst\_TX}$ [dBm]	Power (from step c in 7.2) fed to the substituting antenna
$P_{Subst\_RX}$ [dBm]	Power (from step c in 7.2) received with the spectrum analyzer
$G_{Substitute\_antenna}$ [dBd]	Gain of the substitutive antenna over dipole (dBi – 2.15dB)
$L_{Cable}$ [dB]	Loss of the cable between signal generator and the substituting antenna

EUT Channel	$P_{EUT}$ [dBm]	$P_{Subst\_TX}$ [dBm]	$P_{Subst\_RX}$ [dBm]	Cable loss [dB]	Antenna gain [dBd]	ERP [dBm]	ERP [W]
128	-7.98	+10	-26.86	3.84	-1.35	23.69	0.234
190	-6.86	+10	-26.45	3.94	-1.25	24.40	0.275
251	-5.51	+10	-25.95	4.00	-1.15	25.29	0.338

## 8 99% OCCUPIED BANDWIDTH

EUT	3407		
Accessories	3411		
Temp, Humidity, Air Pressure	21 °C	42 RH%	1011 mbar
Date of measurement	7.6.2004		
FCC rule part	§2.1049 (h)		
RSS-132 section	4.2		
Measured by	Jan-Erik Lilja		

### 8.1 Test setup

The BS simulator was used to set the TX channel and power level and modulate the TX signal with different bit patterns.

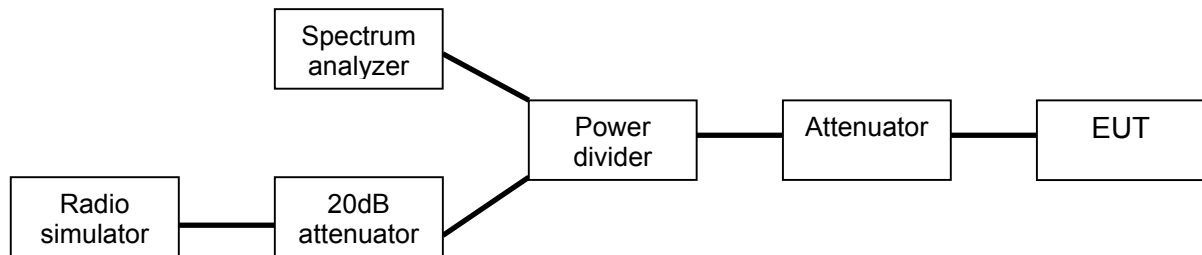

## 8.2 EUT operation mode

EUT operation mode	TX on, 1 time slot transmission, PRBS 2E9-1 audio modulation, GMSK modulation
EUT channel	190
EUT TX power level	4 (33dBm)

## 8.3 Results

The 99% occupied bandwidth was measured using the in-built function of the spectrum analyzer.

EUT Channel	99% occupied bandwidth [kHz]
190	241.987

## 8.4 Screen shots

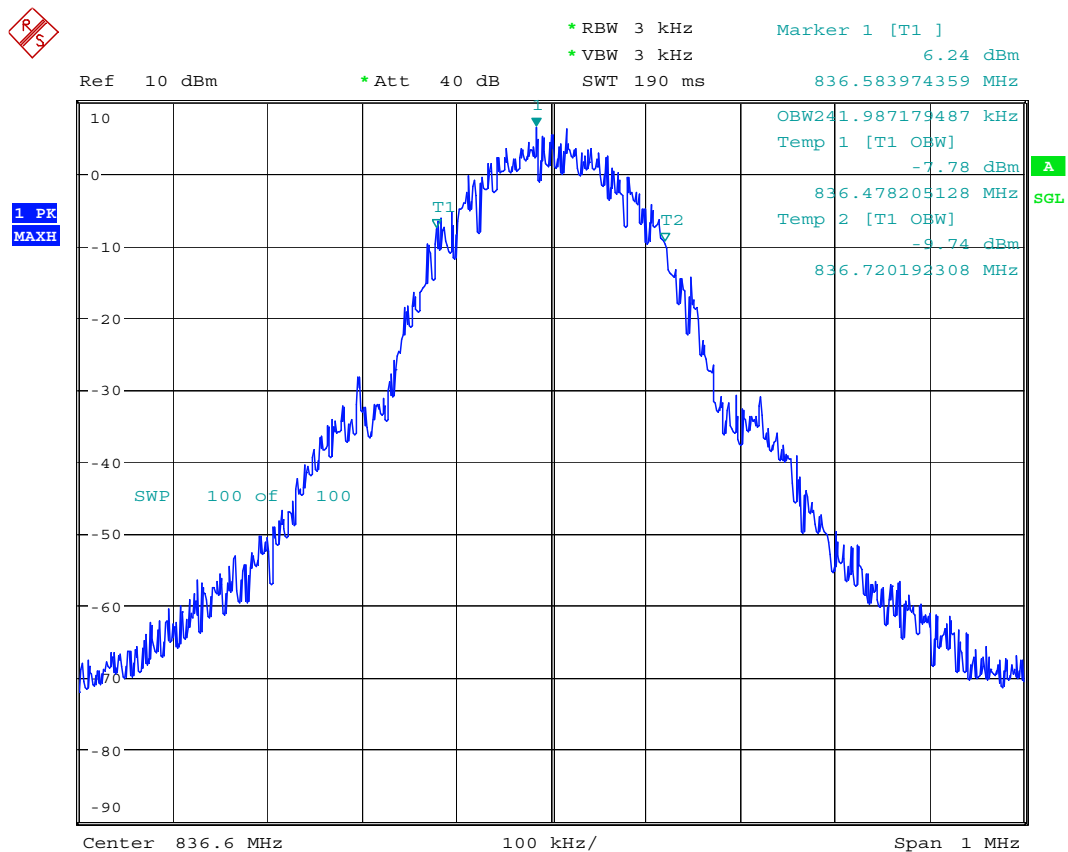

Date: 7.JUN.2004 15:53:21

Picture 4. 99% occupied bandwidth, channel 190

### 8.5 EUT operation mode

EUT operation mode	TX on, 1 time slot transmission, PRBS 2E9-1 audio modulation, 8PSK (EDGE)
EUT channel	190
EUT TX power level	4 (33dBm)

### 8.6 Results

The 99% occupied bandwidth was measured using the in-built function of the spectrum analyzer.

EUT Channel	99% occupied bandwidth [kHz]
190	245.192

### 8.7 Screen shots

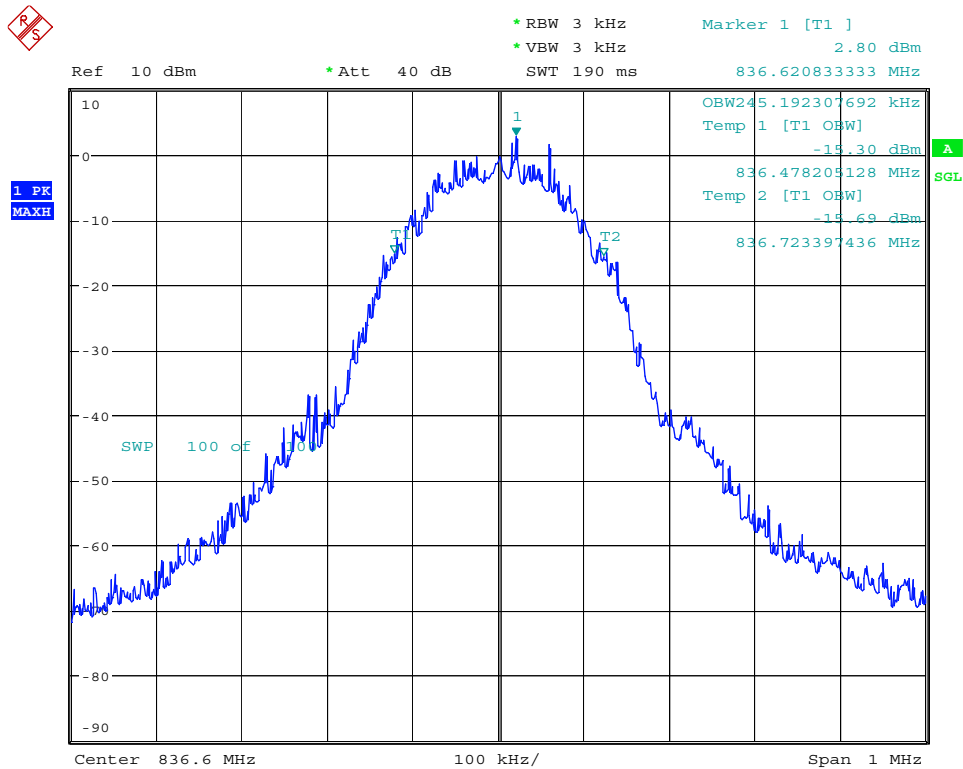

Date: 7.JUN.2004 15:57:13

Picture 4. 99% occupied bandwidth, channel 190

## 9 BANDEDGE COMPLIANCE

EUT	3405		
Accessories	3409		
Temp, Humidity, Air Pressure	20 °C	50 RH%	1018 mbar
Date of measurement	9.6.2004		
FCC rule part	§22.917 (a)		
RSS-132 section	4.5		
Measured by	Jan-Erik Lilja		
Result	PASS		

### 9.1 Test setup

The BS simulator was used to set the TX channel and power level and modulate the TX signal with different bit patterns.

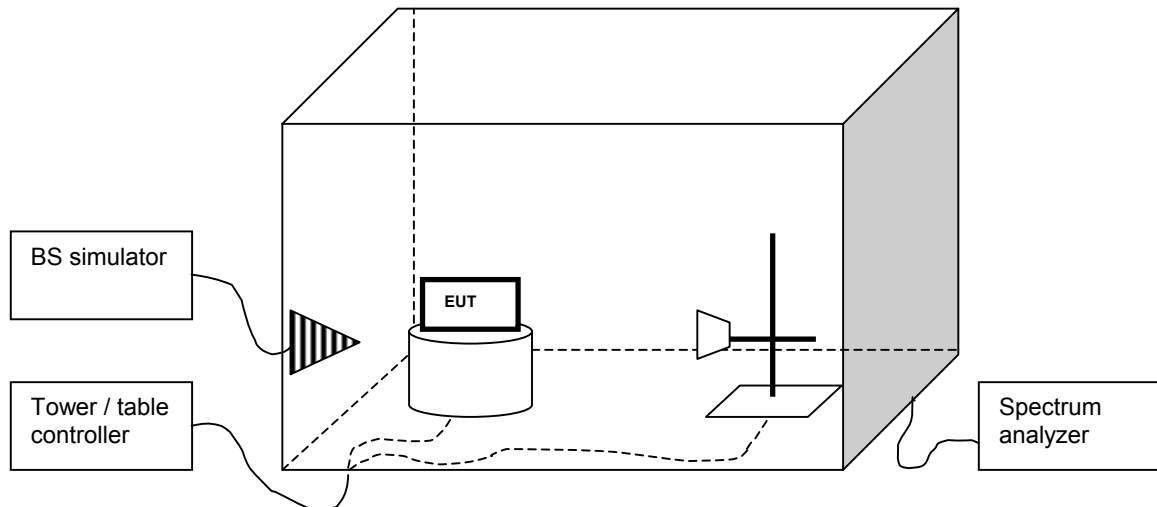

### 9.2 EUT operation mode

EUT operation mode	TX on, 1 time slot transmission, PRBS 2E9-1 audio modulation, GMSK modulation
EUT channel	See section 9.4
EUT TX power level	4 (+33dBm)

### 9.3 Limit

Frequency [MHz]	Level [dBm]
<824.0 or 849.0<	-13

## 9.4 Results

The line in the screen shots is the -13dBm limit line. The results were corrected with measurement path loss set as "offset" in the spectrum analyzer.

EUT Channel	Level [dBm]
128	-15.53
251	-16.45

## 9.5 Screen shots

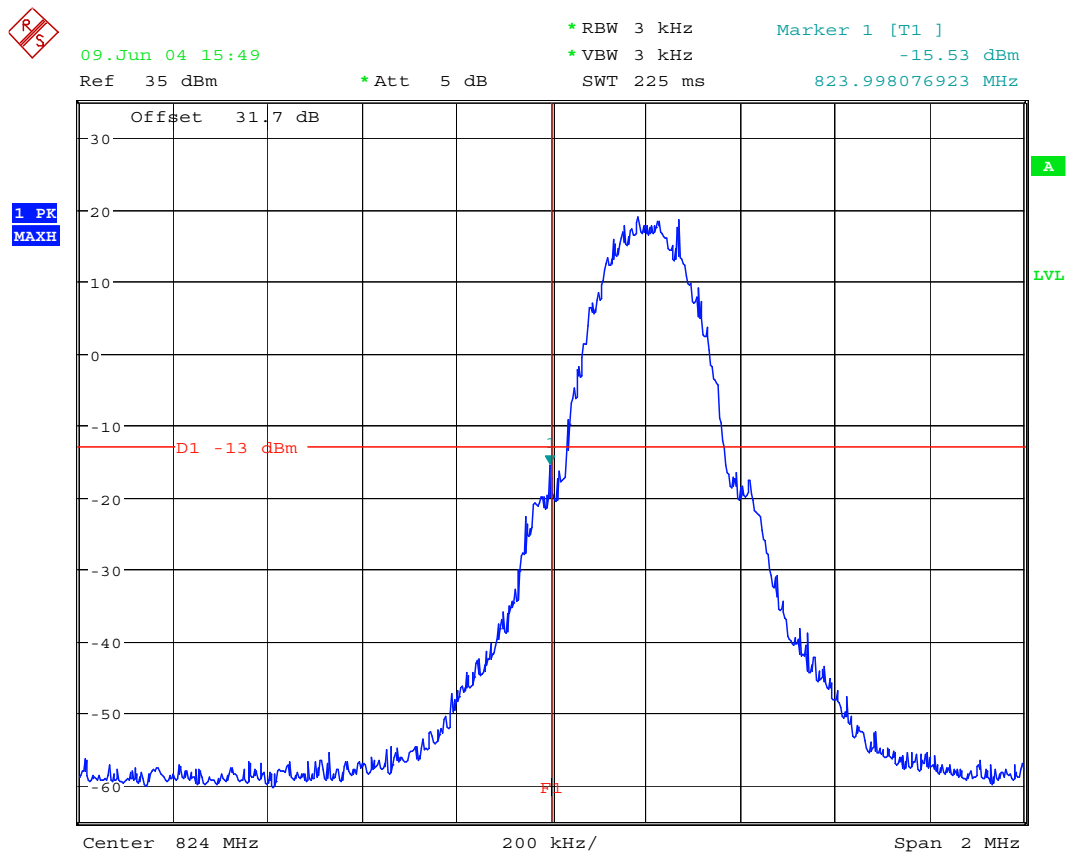

Date: 9.JUN.2004 15:49:50

Picture 5. Lower bandedge, channel 128

Tampere

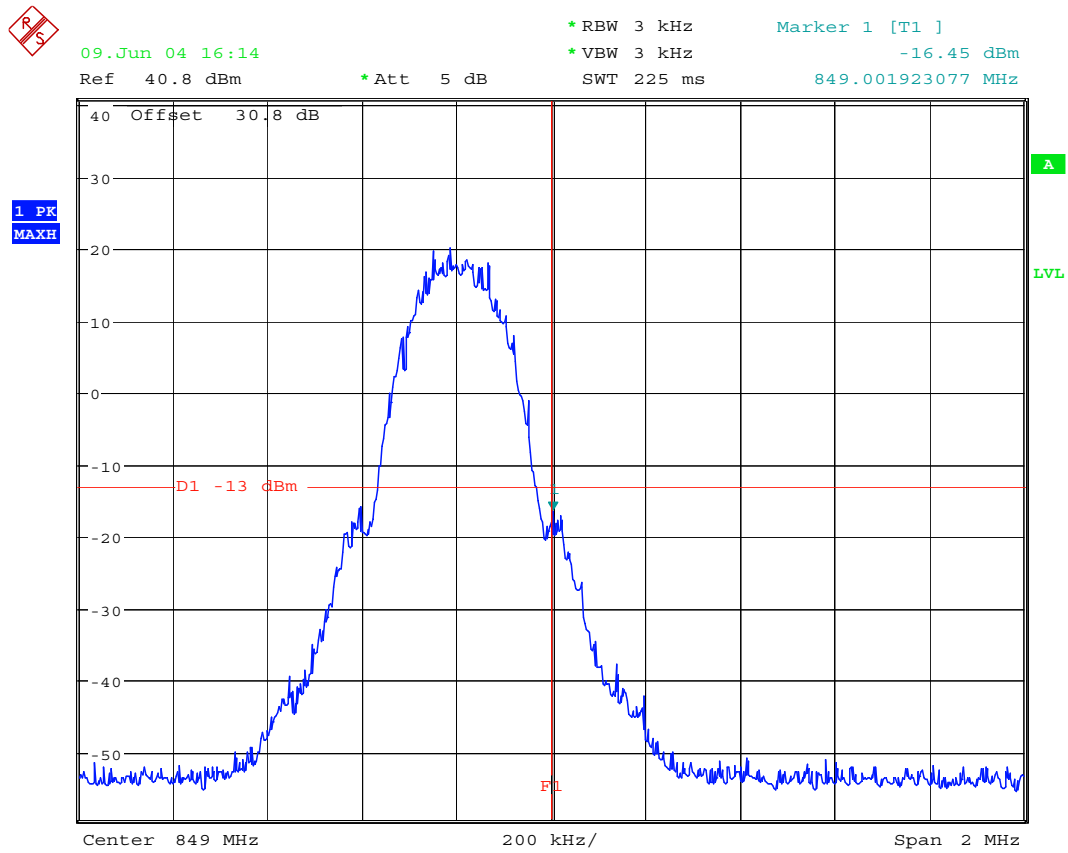

Date: 9.JUN.2004 16:14:54

Picture 6. Upper bandedge, channel 251

## 9.6 EUT operation mode

EUT operation mode	TX on, 1 time slot transmission, PRBS 2E9-1 audio modulation, 8PSK modulation
EUT channel	See section 9.4
EUT TX power level	4 (+33dBm)

## 9.7 Limit

Frequency [MHz]	Level [dBm]
<824.0 or 849.0<	-13

## 9.8 Results

The line in the screen shots is the -13dBm limit line. The results were corrected with measurement path loss set as "offset" in the spectrum analyzer.

EUT Channel	Level [dBm]
128	-21.03
251	-23.05

## 9.9 Screen shots

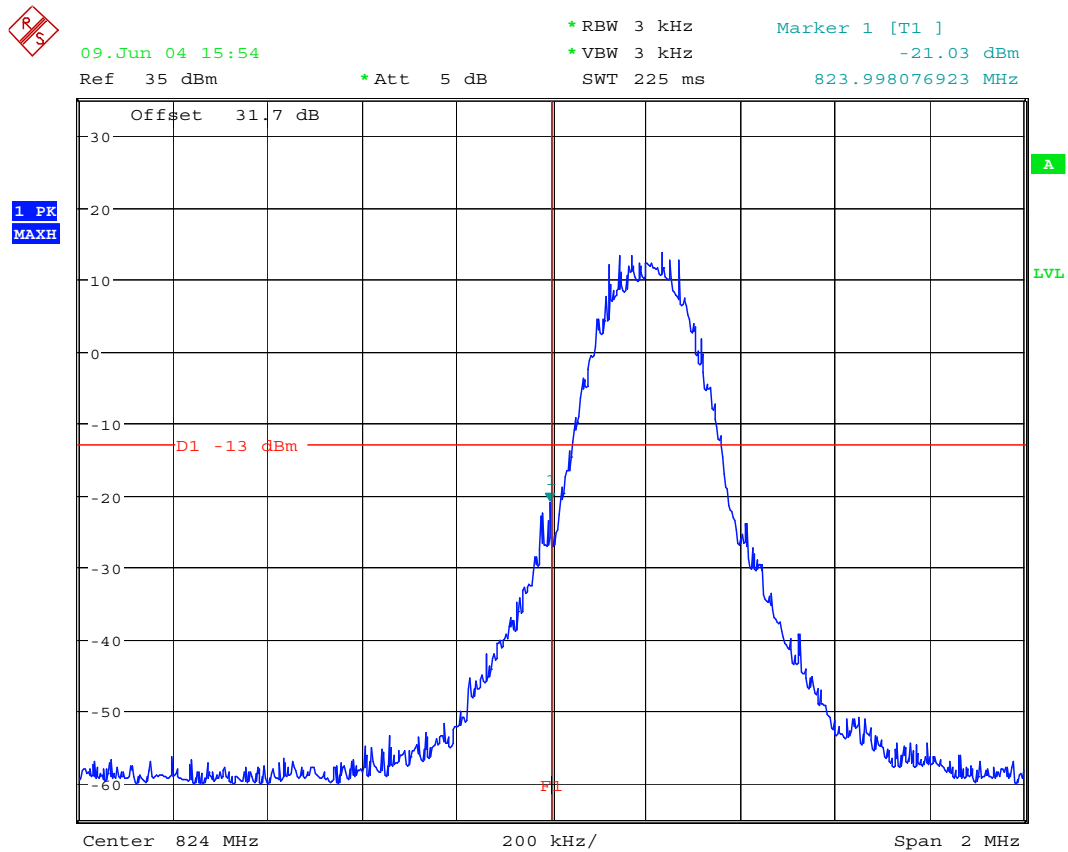

Date: 9.JUN.2004 15:54:01

Picture 5. Lower bandedge, channel 128



Tampere

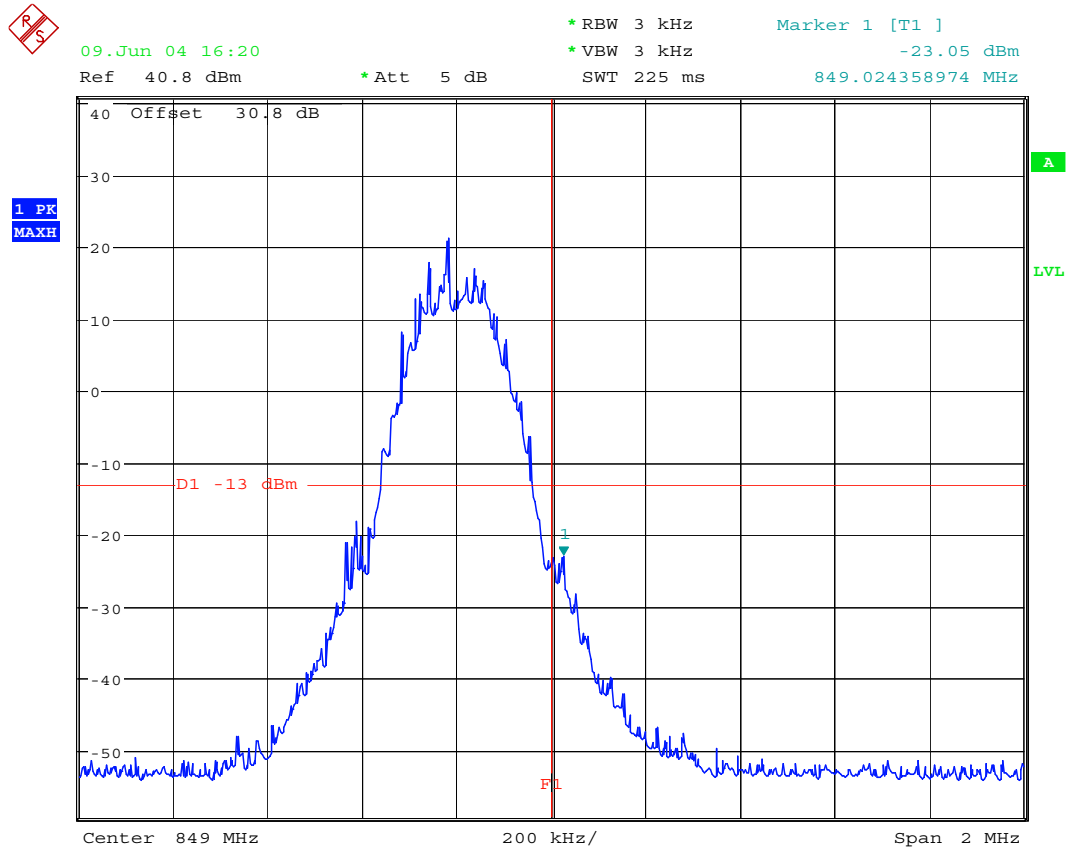

Date: 9.JUN.2004 16:20:47

Picture 6. Upper bandedge, channel 251

## 10 SPURIOUS RADIATED EMISSION

EUT	3405		
Accessories	3409		
Temp, Humidity, Air Pressure	21 °C	45 RH%	1021 mbar
Date of measurement	31.5.2004		
FCC rule part	§22.917 (a), §2.1053		
RSS-132 section	4.5		
Measured by	Jari Jantunen		
Result	PASS		

### 10.1 Test setup

A set of LP/HP/BS filters was used to prevent overloading the spectrum analyzer. The BS simulator was used to set the TX channel and power level and modulate the TX signal with different bit patterns. The test was done using an automated test system, where the measurement devices were controlled by a computer.

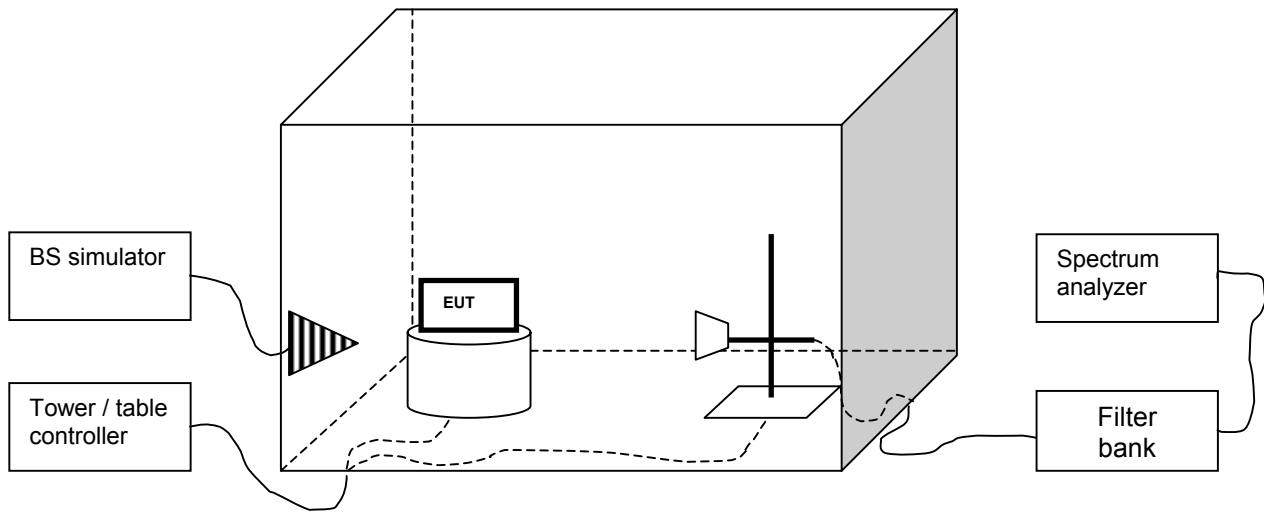

### 10.2 Test method

- a) The emissions were searched and maximized by moving the turn table and measuring antenna and manipulating the EUT.
- b) All suspicious frequencies with emission levels were recorded.
- c) The EUT was replaced with a substituting antenna.
- d) For each frequency recorded, the substituting antenna was fed with the power (from signal generator) giving the same reading as in (b). These power levels were reported.

### 10.3 EUT operation mode

EUT operation mode	TX on, 1 time slot transmission, PRBS 2E9-1 audio modulation, GMSK modulation
EUT channel	190
EUT TX power level	4 (33dBm)

### 10.4 Limit

Frequency [MHz]	Level [dBm]
30 – 8500	-13

### 10.5 Results

The formula below was used to calculate the EIRP of the spurious emissions. If there were no emissions closer than 20dB below the limit line, then the emission levels were measured at the transmitter's harmonics.

$$P_{Emission[dBm]} = P_{SubstTX[dBm]} - L_{Cable[dB]} + G_{Antenna[dBd]}$$

where the variables are as follows:

- $P_{Measured}$  [dBm]                      Measured emission level (from step b in 10.2)
- $P_{Subst\_TX}$  [dBm]                      Signal generator power (from step d in 10.2) fed to the substituting antenna
- $L_{Cable}$  [dB]                              Loss of the cable between antenna and signal generator (from step d in 10.2)
- $G_{Antenna}$  [dBd]                              Gain of the substitutive antenna over dipole (dBi – 2.15dB)

Table 1 Emission levels, channel 190

Frequency [MHz]	$P_{Measured}$ [dBm]	Correction factor [dB]	$P_{Emission}$ [dBm]
1673.20	-31.26	5.9	-37.16
2509.80	-51.55	-1.7	-49.85
3346.40	-55.43	-7.6	-47.83
4183.00	-49.68	-10.3	-39.38
5019.60	-59.38	-12.9	-46.48
5856.20	-63.42	-13.7	-49.72
6692.80	-59.21	-15.5	-43.71
7529.40	-65.87	-18.2	-47.67
8366.00	-66.48	-19.6	-46.88

## 10.6 EUT operation mode

EUT operation mode	TX on, 1 time slot transmission, PRBS 2E9-1 audio modulation, 8PSK modulation
EUT channel	190
EUT TX power level	4 (33dBm)

## 10.7 Limit

Frequency [MHz]	Level [dBm]
30 – 8500	-13

## 10.8 Results

The formula below was used to calculate the EIRP of the spurious emissions. If there were no emissions closer than 20dB below the limit line, then the emission levels were measured at the transmitter's harmonics.

$$P_{Emission[dBm]} = P_{SubstTX[dBm]} - L_{Cable[dB]} + G_{Antenna[dBd]}$$

where the variables are as follows:

$P_{Measured}$ [dBm]	Measured emission level (from step b in 10.2)
$P_{Subst\_TX}$ [dBm]	Signal generator power (from step d in 10.2) fed to the substituting antenna
$L_{Cable}$ [dB]	Loss of the cable between antenna and signal generator (from step d in 10.2)
$G_{Antenna}$ [dBd]	Gain of the substitutive antenna over dipole (dBi – 2.15dB)

**Table 2 Emission levels, channel 190**

Frequency [MHz]	$P_{Measured}$ [dBm]	Correction factor [dB]	$P_{Emission}$ [dBm]
1673.20	-36.85	5.9	-42.75
2509.80	-55.9	-1.7	-54.20
3346.40	-59.66	-7.6	-52.06
4183.00	-49.86	-10.3	-39.56
5019.60	-62.49	-12.9	-49.59
5856.20	-62.66	-13.7	-48.96
6692.80	-59.3	-15.5	-43.80
7529.40	-66.41	-18.2	-48.21
8366.00	-66.14	-19.6	-46.54

## 11 FREQUENCY STABILITY, TEMPERATURE VARIATION

EUT	3407		
Accessories	3411		
Temp, Humidity, Air Pressure	21 °C	43 RH%	1021-1022 mbar
Date of measurement	31.5.-1.6.2004		
FCC rule part	§2.1055 (a)(1)(b)		
RSS-132 section	6.3		
Measured by	Jan-Erik Lilja		
Result	PASS		

### 11.1 Test setup

The BS simulator was used to set the TX channel and power level and modulate the TX signal with different bit patterns.

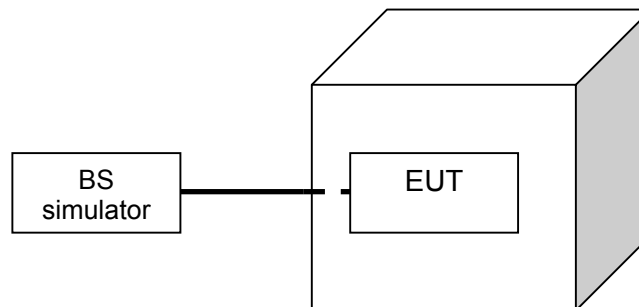

### 11.2 EUT operation mode

EUT operation mode	TX on, 1 time slot transmission, PRBS 2E9-1 modulation
EUT channel	190
EUT TX power level	4 (33dBm)

### 11.3 Limit

Frequency deviation [ppm]
± 2.5

### 11.4 Test method

a) The climate chamber temperature was set to the minimum value and the temperature was allowed to stabilize.

- b) The EUT was placed in the chamber
- c) The EUT was set in idle mode for 45 minutes.
- d) The EUT was set to transmit.
- e) The transmit frequency error was measured immediately
- f) The steps c - e were repeated for each temperature

## 11.5 Results

**Table 3 Frequency deviation, temperature variation**

Temperature [°C]	Deviation [Hz]	Deviation [ppm]
-30	26	0.031078
-20	-12	0.01434
-10	-23	0.02749
0	-19	0.02271
10	-19	0.02271
20	-20	0.02391
30	-18	0.02152
40	-12	0.01434
50	-15	0.01793

## 12 FREQUENCY STABILITY, VOLTAGE VARIATION

EUT	3407		
Accessories	3417		
Temp, Humidity, Air Pressure	21°C	42 RH%	1011 mbar
Date of measurement	7.6.2004		
FCC rule part	§2.1055 (d)(1)(2)		
RSS-132 section	6.3		
Measured by	Jan-Erik Lilja		
Result	PASS		

### 12.1 Test setup

The BS simulator was used to set the TX channel and power level and modulate the TX signal with different bit patterns.



### 12.2 EUT operation mode

EUT operation mode	TX on, 1 time slot transmission, PRBS 2E9-1 modulation
EUT channel	190
EUT TX power level	4 (33dBm)

### 12.3 Limit

Frequency deviation [ppm]
± 2.5

### 12.4 Test method

The EUT battery was replaced with an adjustable power supply. The frequency stability was measured at nominal voltage and at the battery cut-off point.

### 12.5 Results

**Table 4 Frequency deviation, voltage variation**

Level	Voltage [V]	Deviation [Hz]	Deviation [ppm]
Nominal	3.7	-18	0.02152
Battery cut-off point	3.4	-18	0.02152

## 13 TEST EQUIPMENT

Each test equipment is calibrated once a year.

### 13.1 Conducted measurements

Equipment	Manufacturer	Model
EMI receiver	Rohde & Schwarz	ESI 40
Radio communication tester	Rohde & Schwarz	CMU-200
Attenuator 10 dB	Huber+Suhner AG	6251.17.A
Step attenuator 110dB	Hewlett-Packard	8496A
Power splitter	Hewlett-Packard	11667A
High pass filter	Trilithic	WHK2010-10SS
Low pass filter	Trilithic	WLK1750-10SS
Tunable notch filter	Wainwright	WRCD1850/1910-0.2/40
Temperature chamber	Vötsch	VT4002
DC power supply	HP	6632A
Multimeter	Fluke	87

### 13.2 Radiated measurements

Equipment	Manufacturer	Model
3m semi-anechoic chamber	TDK	
EMI receiver	Rohde & Schwarz	ESI 40
Preamplifier	MITEQ	AMF-5D-020180-26-10P
Preamplifier	MITEQ	AMF-4D-10M-3G-25-20P
Dipole antenna	EMCO	3125-870
Dipole antenna	EMCO	3125-1880
Biconilog antenna	Rohde & Schwarz	HL562
Double ridged waveguide antenna	EMCO	3115
Double ridged waveguide antenna	EMCO	3115
Horn antenna	EMCO	3116
Reference dipole set	Schwarzbeck	UHAP/VHAP



---

Communication antenna	EMC Automation	LPA-8020
Radio communication tester	Rohde & Schwarz	CMU-200
Signal generator	Hewlett-Packard	83640L
Step attenuator 110dB	Hewlett-Packard	8496A
Power splitter	Hewlett-Packard	11667A
High pass filter	Trilithic	WHK2010-10SS
Low pass filter	Trilithic	WLK1750-10SS
Tunable notch filter	Wainwright	WRCD1850/1910-0.2/40
Turntable controller	Deisel	HD-100
Turntable	Deisel	DS412
Antenna mast controller	EMCO	2090
Antenna mast	EMCO	2075
Temperature chamber	Vötsch	VT4002
DC power supply	Hewlett-Packard	6632A
Multimeter	Fluke	87

---

## 14 TEST SETUP PHOTOGRAPHS

See " RH-49\_test\_setup\_photographs.DOC ".