

Test Report
for
FCC Part 15 Subpart B & C & E
Class II Permissive Change

of

Product Name & Model

AR5BXB6 802.11 a/b/g PCI Express Module

Applied by:

Atheros Communications, Inc.
5480 Great America Parkway
Santa Clara, CA 95054
USA

Test Performed by:

International Standards Laboratory

No. 120, Lane 180, San Ho Tsuen, Hsin Ho Rd.
Lung-Tan Hsiang, Tao Yuan County 325
Taiwan, R.O.C.
Tel:(03)407-1718 Fax:(03)407-1738

Report Number: ISL-06LR020FC

Issue Date: 2006/09/05

HC LAB: NVLAP:200234-0; VCCI: R-341, C-354; NEMKO: ELA 113A; BSMI: SL2-IN-E-0037; SL2-R1-E-0037; CNLA: 1178;
IC: IC4067

LT LAB: NVLAP:200234-0; VCCI: R-1435, C-1440; NEMKO: ELA 113B; BSMI: SL2-IN-E-0013; CNLA: 0997; IC: IC4164-1
ISL-T10-R2-3

Contents of Report

1.	General.....	1
1.1	Certification of Accuracy of Test Data.....	1
2.	Test Results Summary	2
3.	Description of Equipment Under Test (EUT)	3
4.	TEST RESULTS (802.11a).....	5
4.1	Maximum Peak Output Power [Section 15.407 (a)(1)(2)(3)].....	5
4.1.1	Test Procedure	5
4.1.2	Test Setup.....	5
4.1.3	Test Data: (Normal Mode).....	7
4.1.4	Test Data: (Turbo Mode).....	7
4.2	Peak Power Spectral Density [Section 15.407(a)(1)(2)(3)]	6
4.2.1	Test Procedure	6
4.2.2	Test Setup.....	6
4.2.3	Test Data: (Normal Mode).....	6
4.2.4	Test Data: (Turbo Mode).....	6
4.3	Peak Power Excursion Measurement [Section 15.407(a)(6)].....	7
4.3.1	Test Procedure	7
4.3.2	Test Setup.....	7
4.3.3	Test Data: (Normal Mode).....	5
4.3.4	Test Data: (Turbo Mode).....	5
4.4	Powerline Conducted Emissions [Section 15.207 & 15.407 (b)(5)]	8
4.4.1	EUT Configuration	8
4.4.2	Test Procedure	8
4.4.3	EMI Receiver/Spectrum Analyzer Configuration (for the frequencies tested).....	8
4.4.4	Test Data:.....	8
4.5	Radiated Emission Measurement [Section 15.209 & 15.407(b)(5)]	9
4.5.1	EUT Configuration	9
4.5.2	Test Procedure	9
4.5.3	EMI Receiver/Spectrum Analyzer Configuration	9
4.5.4	Test Data (30MHz – 1GHz)	10
4.5.5	Test Data (1GHz – 40 GHz, Transmitting)	11
4.6	Band Edge Measurement (Section 15.407 (b) (1) (2)).....	17
4.6.1	Test Procedure (Conducted).....	17
4.6.2	Test Setup (Conducted)	17
4.6.3	Test Data (conducted):.....	17
4.6.4	Bandedge Measurement Test Procedure (Radiated).....	18
4.6.5	Test Setup (Radiated).....	19
4.6.6	Test Data (Radiated):	20
4.7	RF Exposure Measurement [Section 15.407(f)(4) & 1.1307(b)].....	25
4.8	Frequency Stability [Section 15.407(g)]	26
4.8.1	Limits of Frequency Stability Measurement.....	26
4.8.2	Test Procedure	26
4.8.3	Test Setup.....	26
4.8.4	Test Data.....	26
5.	TEST RESULTS (802.11a(5725MHz~5850MHz)&802.11b).....	27
5.1	Powerline Conducted Emissions [Section 15.207]	27

5.1.1	EUT Configuration	27
5.1.2	Test Procedure	27
5.1.3	EMI Receiver/Spectrum Analyzer Configuration (for the frequencies tested).....	27
5.1.4	Test Data:.....	27
5.2	Bandwidth for DSSS [Section 15.247 (a)(2)].....	28
5.2.1	Test Procedure	28
5.2.2	Test Setup.....	28
5.2.3	Test Data:.....	28
5.3	DSSS Maximum Peak Output Power [Section 15.247 (b)(1)].....	29
5.3.1	Test Procedure	29
5.3.2	Test Setup.....	29
5.3.3	Test Data.....	29
5.4	Radiated Emission Measurement [Section [15.247(c)(4)]	30
5.4.1	EUT Configuration	30
5.4.2	Test Procedure	30
5.4.3	EMI Receiver/Spectrum Analyzer Configuration (for the frequencies tested).....	30
5.4.4	Test Data (30MHz – 1GHz):.....	31
5.4.5	Test Data (1GHz – 25 GHz)	32
5.5	Band Edge Measurement	40
5.5.1	Test Procedure (Conducted).....	40
5.5.2	Test Setup (Conducted).....	40
5.5.3	Test Data:.....	40
5.5.4	Test Procedure (Radiated).....	41
5.5.5	Test Setup (Radiated).....	41
5.5.6	Test Data.....	42
5.6	RF Exposure Measurement [Section 15.247(b)(4) & 1.1307(b)].....	48
5.7	DSSS Peak Power Spectral Density [Section 15.247(d)]	49
5.7.1	Test Procedure	49
5.7.2	Test Setup.....	49
5.7.3	Test Data.....	49
6.	TEST RESULTS (802.11g)	50
6.1	Powerline Conducted Emissions [Section 15.207]	50
6.1.1	EUT Configuration	50
6.1.2	Test Procedure	50
6.1.3	EMI Receiver/Spectrum Analyzer Configuration (for the frequencies tested).....	50
6.1.4	Test Data:.....	50
6.2	Bandwidth for DSSS [Section 15.247 (a)(2)].....	51
6.2.1	Test Procedure	51
6.2.2	Test Setup.....	51
6.2.3	Test Data:.....	51
6.3	DSSS Maximum Peak Output Power [Section 15.247 (b)(1)].....	52
6.3.1	Test Procedure	52
6.3.2	Test Setup.....	52
6.3.3	Test Data.....	52
6.4	Radiated Emission Measurement [Section [15.247(c)(4)]	53
6.4.1	EUT Configuration	53
6.4.2	Test Procedure	53
6.4.3	EMI Receiver/Spectrum Analyzer Configuration (for the frequencies tested).....	53
6.4.4	Test Data (30MHz – 1GHz):.....	54
6.4.5	Test Data (1GHz – 25 GHz)	55
6.5	Band Edge Measurement	59
6.5.1	Test Procedure (Conducted).....	59
6.5.2	Test Setup (Conducted).....	59

6.5.3	Test Data.....	59
6.5.4	Test Procedure (Radiated).....	60
6.5.5	Test Setup (Radiated).....	60
6.5.6	Test Data.....	61
6.6	RF Exposure Measurement [Section 15.247(b)(4) & 1.1307(b)].....	67
6.7	DSSS Peak Power Spectral Density [Section 15.247(d)].....	68
6.7.1	Test Procedure	68
6.7.2	Test Setup.....	68
6.7.3	Test Data.....	68
7.	Appendix.....	69
7.1	Appendix A: Measurement Procedure for Power line Conducted Emissions	69
7.2	Appendix B: Test Procedure for Radiated Emissions.....	70
7.3	Appendix C: Test Equipment.....	71
7.3.1	Test Equipment List.....	71
7.3.2	Software for Controlling Spectrum/Receiver and Calculating Test Data.....	71
7.4	Appendix D: Layout of EUT and Support Equipment.....	72
7.4.1	General Conducted Test Configuration	72
7.4.2	General Radiation Test Configuration.....	73
7.5	Appendix E: Description of Support Equipment	74
7.5.1	Description of Support Equipment	74
7.5.2	Software for Controlling Support Unit	75
7.5.3	I/O Cable Condition of EUT and Support Units	75
7.6	Appendix F: Accuracy of Measurement.....	76
7.7	Appendix G: Photographs of EUT Configuration Test Set Up	78
7.8	Appendix H: Antenna Spec.....	79

1. General

1.1 Certification of Accuracy of Test Data

Standards:	CFR 47 Part 15 Subpart B Class B CFR 47 Part 15 Subpart C (Section 15.247) CFR 47 Part 15 Subpart E (Section 15.407)
Test Procedure:	ANSI C63.4:2003
Product Name & Model:	AR5BXB6 802.11 a/b/g PCI Express Module
Built-In Tablet PC	Brand Name: Lenovo Model Name: 6363/ 6364/ 6365/ 6366/ 6367/ 6368 Project Name: ThinkPad X60 Tablet Series
Applied by:	Atheros Communications, Inc.
Sample received Date:	2006/08/23
Final test Date :	2006/09/05
Test Result	PASS
Test Site:	Chamber 02, Conduction 02
Temperature	Refer to each site test data
Humidity:	Refer to each site test data
Test Engineer:	Jerry Chiou 

All the tests in this report have been performed and recorded in accordance with the standards described above and performed by an independent electromagnetic compatibility consultant, International Standards Laboratory.

The test results contained in this report accurately represent the measurements of the characteristics and the energy generated by sample equipment under test at the time of the test. The sample equipment tested as described in this report is in compliance with the limits of above standards.

Approve & Signature



Eddy Hsiung/Director

Test results given in this report apply only to the specific sample(s) tested under stated test conditions. This report shall not be reproduced other than in full without the explicit written consent of ISL. This report totally contains 83 pages, including 1 cover page, 3 contents page, and 79 pages for the test description. This report must not be use to claim product endorsement by NVLAP or any agency of the U.S. Government.

This test data shown below is traceable to NIST or national or international standard. International Standards Laboratory certifies that no party to this application has been denied the FCC benefits pursuant to Section 5301 of the Anti-Drug Abuse Act of 1988, 21 U.S.C. 853(a).

2. Test Results Summary

The 802.11b functions of EUT has been tested according to the FCC regulations listed below:

Tested Standards: 47 CFR Part 15 Subpart C			
Standard Section	Test Type	Result	Remarks
15.207	AC Power Line Emissions	Pass	
15.247(a)(2)	Spectrum Bandwidth Of DSSS device	Pass	
15.247(b)	Max. Peak Output Power	Pass	
15.247(c)	Radiated Emissions 30MHz – 25 GHz	Pass	
15.247 (c)	Band Edge Measurement	Pass	
15.247(b)(4)	Radiation Exposure	Pass	SAR report attached
15.247 (d)	Power Spectral Density	Pass	

The 802.11g functions of EUT has been tested according to the FCC regulations listed below:

Tested Standards: 47 CFR Part 15 Subpart C			
Standard Section	Test Type	Result	Remarks
15.207	AC Power Line Emissions	Pass	
15.247(a)(2)	Spectrum Bandwidth Of DSSS device	Pass	
15.247(b)	Max. Peak Output Power	Pass	
15.247(c)	Radiated Emissions 30MHz – 25 GHz	Pass	
15.247 (c)	Band Edge Measurement	Pass	
15.247(b)(4)	Radiation Exposure	Pass	SAR report attached
15.247 (d)	Power Spectral Density	Pass	

The 802.11a functions of EUT has been tested to the FCC regulations listed below:

Tested Standards: 47 CFR Part 15 Subpart E			
Standard Section	Test Type	Result	Remarks
15.407 (a)(1)(2)(3)	Peak Transmit Power	Pass	
15.407 (a)(1)(2)(3)	Peak Power Spectral Density	Pass	
15.407 (a)(6)	Peak Power Excursion	Pass	
15.407 (b)(5)	AC Power Line Emissions	Pass	
15.407 (b)(5)	Radiated Emissions 30MHz – 40 GHz	Pass	
15.407(f)	Radiation exposure	Pass	SAR report attached
15.407 (g)	Frequency Stability	Pass	

3. Description of Equipment Under Test (EUT)

Product Name & Model No.:	AR5BXB6 802.11 a/b/g PCI Express Module
FCC ID:	PPD-AR5BXB6
Brand:	Atheros
Frequency Range 802.11a:	5150~5350 MHz, 5725~5850 MHz
Frequency Range 802.11b/g:	2400~2483.5 MHz
Support channel:	
802.11a Normal mode	13 Channels
802.11a Turbo mode	4 Channels
802.11b/g	11 Channels
802.11g Turbo mode	1 Channel
Modulation Skill:	
802.11a Normal mode	OFDM (6 Mbps – 54 Mbps)
802.11a Turbo mode	OFDM (12 Mbps – 108 MBps)
802.11b	DBPSK(1Mbps), DQPSK(2Mbps), CCK(5.5/11Mbps)
802.11g	OFDM (6M - 54Mbps)
802.11g Turbo mode	OFDM (6M - 54Mbps)
Antennas Type:	
Main antenna:	IFA (P/N: 25.90354.001) made by Wistron NeWeb Corp.
Aux antenna:	IFA (P/N: 25.90355.001) made by Wistron NeWeb Corp.
Antenna Connected:	Connected to RF connector on the PCB of the 802.11a/b/g WLAN Adapter .The user is not possible to change the antenna without disassembling the notebook computer.
Antenna peak Gain:	
Main antenna	0.9 dBi (11b,11g), 1.92 dBi (11a)
AUX antenna	1.52 dBi (11b,11g), 2.78 dBi (11a)
Power Type of wireless module:	3.3V DC from Notebook PC

The channel and the operation frequency of 802.11a Normal Mode is listed below:

Channel	Frequency(MHz)	Channel	Frequency(MHz)
36	5180	40	5200
44	5220	48	5240
52	5260	56	5280
60	5300	64	5320
149	5745	153	5765
157	5785	161	5805
165	5825		

The channel and the operation frequency of 802.11a Turbo Mode is listed below:

Channel	Frequency(MHz)	Channel	Frequency(MHz)
40	5200	58	5290
152	5760	161	5805

The channel and the operation frequency of 802.11b and 802.11g is listed below:

Channel	Frequency(MHz)	Channel	Frequency(MHz)
01	2412	07	2442
02	2417	08	2447
03	2422	09	2452
04	2427	10	2457
05	2432	11	2462
06	2437	Turbo g	2437

There is a difference from the original application: Add a new antenna

Antennas Type:

Main antenna: IFA (P/N: 25.90354.001) made by Wistron NeWeb Corp.

Aux antenna: IFA (P/N: 25.90355.001) made by Wistron NeWeb Corp.

Antenna peak Gain:

Main antenna: 0.9 dBi (11b,11g), 1.92 dBi (11a)

AUX antenna: 1.52 dBi (11b,11g), 2.78 dBi (11a)

4. TEST RESULTS (802.11a)

4.1 Maximum Peak Output Power [Section 15.407 (a)(1)(2)(3)]

4.1.1 Test Procedure

The transmitter output of EUT was connected to the peak power analyzer.

4.1.2 Test Setup



Frequency Band	Limit
5.15 – 5.25 GHz	The lesser of 50mW (17dBm) or 4dBm+10logB
5.25 – 5.35GHz	The lesser of 250mW (24dBm) or 11dBm+10logB
5.725-5.825GHz	The lesser of 1W (30dBm) or 17dBm+10logB

Note: B is the 26dB emission bandwidth in MHz

4.1.3 Test Data: (Normal Mode)

Temp. (deg. C): 25
 Test Engr: Jerry Chiou Humidity (%): 50

Channel	Frequency (Mhz)	Analyzer Reading (dBm)	Cable Loss (dB)	Peak Power Output (mW)	Peak Power Output (dBm)	Limit (dBm)	Pass/Fail
36	5180	14.52	1.4	39.08	15.92	30	Pass
48	5240	14.58	1.4	39.63	15.98	30	Pass
52	5260	14.56	1.4	39.45	15.96	30	Pass
64	5320	13.05	1.4	27.86	14.45	30	Pass

4.1.4 Test Data: (Turbo Mode)

Temp. (deg. C): 25
 Test Engr: Jerry Chiou Humidity (%): 50

Channel	Frequency (Mhz)	Analyzer Reading (dBm)	Cable Loss (dB)	Peak Power Output (mW)	Peak Power Output (dBm)	Limit (dBm)	Pass/Fail
40	5200	13.43	1.4	30.41	14.83	30	Pass
58	5290	14.67	1.4	40.46	16.07	30	Pass

4.2 Peak Power Spectral Density [Section 15.407(a)(1)(2)(3)]

4.2.1 Test Procedure

1. The Transmitter output of EUT was connected to the spectrum analyzer.
Equipment mode: Spectrum analyzer
Detector function: Peak mode
SPAN: 30MHz or 50MHz
RBW: 1MHz
VBW: 3MHz
Sweep time: 30 or 50 sec.
Center frequency: fundamental frequency tested
2. Peak search was read to the peak power after maximum hold function is completed.

4.2.2 Test Setup

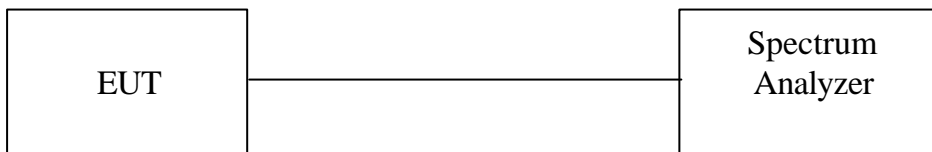

4.2.3 Test Data: (Normal Mode)

Please refer to Elliott Laboratories, Inc. Report Number: R60260
FCC ID: PPD-AR5BXB6

4.2.4 Test Data: (Turbo Mode)

Please refer to Elliott Laboratories, Inc. Report Number: R60260
FCC ID: PPD-AR5BXB6

4.3 Peak Power Excursion Measurement [Section 15.407(a)(6)]

4.3.1 Test Procedure

1. The Transmitter output of EUT was connected to the spectrum analyzer.
2. Frequency SPAN of Spectrum: 30MHz or 50MHz.
3. Trace 1 : RBW: 1MHz, VBW: 3MHz. Using positive detector and Max -hold
4. Trace 2 : RBW: 1MHz, VBW: 3MHz. Using Sample detector and Max-hold
5. Record the largest difference between Trace 1 and Trace 2.

4.3.2 Test Setup

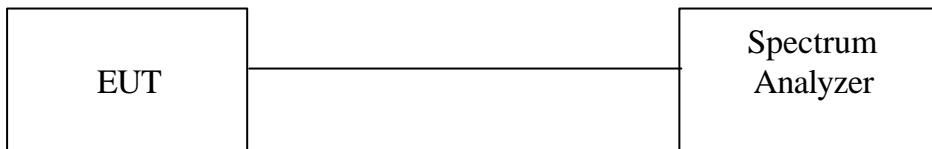

4.3.3 Test Data: (Normal Mode)

Please refer to Elliott Laboratories, Inc. Report Number: R60260
FCC ID: PPD-AR5BXB6

4.3.4 Test Data: (Turbo Mode)

Please refer to Elliott Laboratories, Inc. Report Number: R60260
FCC ID: PPD-AR5BXB6

4.4 Powerline Conducted Emissions [Section 15.207 & 15.407 (b)(5)]

4.4.1 EUT Configuration

The EUT was set up on the non-conductive table that is 1.0 by 1.5 meter, 80cm above ground. The wall of the shielded room was located 40cm to the rear of the EUT.

Power to the EUT was provided through the LISN. The impedance vs. frequency characteristic of the LISN is complied with the limit used.

Both lines (neutral and hot) were connected to the LISN in series at testing. A coaxial-type connector which provides one 50 ohms terminating impedance was provided for connecting the test instrument. The excess length of the power cord was folded back and forth at the center of the lead so as to form a bundle not exceeding 40cm in length.

Any changes made to the configuration, or modifications made to the EUT, during testing are noted in the following test record.

If the EUT is a Personal Computer or a peripheral of personal computer, and the personal computer has an auxiliary AC outlet which can be used for providing power to an external monitor, then all measurements will be made with the monitor power from first the computer-mounted AC outlet and then a floor-mounted AC outlet.

4.4.2 Test Procedure

The system was set up as described above, with the EMI diagnostic software running. The main power line conducted EMI tests were run on the hot and neutral conductors of the power cord and the results were recorded. The effect of varying the position of the interface cables has been investigated to find the configuration that produces maximum emission.

At the frequencies where the peak values of the emissions were higher than 6dB below the applicable limits, the emissions were also measured with the quasi-peak detectors. At the frequencies where the quasi-peak values of the emissions were higher than 6dB below the applicable average limits, the emissions were also measured with the average detectors.

The highest emissions were analyzed in details by operating the spectrum analyzer in fixed tuned mode to determine the nature of the emissions and to provide information which could be useful in reducing their amplitude.

4.4.3 EMI Receiver/Spectrum Analyzer Configuration (for the frequencies tested)

Frequency Range:	150 KHz--30MHz
Detector Function:	Quasi-Peak/Average
Bandwidth (RBW):	9KHz

4.4.4 Test Data:

Please refer to Elliott Laboratories, Inc. Report Number: R60260
FCC ID: PPD-AR5BXB6

4.5 Radiated Emission Measurement [Section 15.209 & 15.407(b)(5)]

4.5.1 EUT Configuration

The equipment under test was set up on the 10 meter chamber with measurement distance of 3 meters. The EUT was placed on a non-conductive table 80cm above ground.

Any changes made to the configuration, or modifications made to the EUT, during testing are noted in the following test record.

4.5.2 Test Procedure

The system was set up as described above, with the EMI diagnostic software running. We found the maximum readings by varying the height of antenna and then rotating the turntable. Both polarization of antenna, horizontal and vertical, are measured.

30M to 1GHz: The highest emissions between 30 MHz to 1000 MHz were also analyzed in details by operating the spectrum analyzer and/or EMI receiver in quasi-peak mode to determine the precise amplitude of the emissions. While doing so, the interconnecting cables and major parts of the system were moved around, the antenna height was varied between one and four meters, its polarization was varied between vertical and horizontal, and the turntable was slowly rotated, to maximize the emission.

1GHz – 40GHz: The highest emissions were also analyzed in details by operating the spectrum analyzer and/or EMI receiver in peak mode to determine the precise amplitude of the emission. While doing so, the interconnecting cables and major parts of the system were moved around, the antenna height was varied between one and four meters, its polarization was varied between vertical and horizontal, and the turntable was slowly rotated, to maximize the emission. During test the EMI receiver and spectrum was setup according to para. 6.5.3.

For the test of 2nd to 10th harmonics frequencies , the equipment setup was also refer to para.6.5.3. The frequencies were tested using Peak mode first, if the test data is higher than the emissions limit, an additional measurement using Average mode will be performed and the average reading will be compared to the limit and record in test report.

4.5.3 EMI Receiver/Spectrum Analyzer Configuration

Frequency Range Tested:	30MHz~1000MHz
Detector Function:	Quasi-Peak Mode
Resolution Bandwidth (RBW):	120KHz
Video Bandwidth (VBW)	1MHz
Frequency Range Tested:	1GHz – 40 GHz
Detector Function:	Peak Mode
Resolution Bandwidth (RBW):	1MHz
Video Bandwidth (VBW)	3MHz
Frequency Range Tested:	30MHz – 40 GHz
Detector Function:	Average Mode
Resolution Bandwidth (RBW):	1MHz
Video Bandwidth (VBW)	10 Hz

4.5.4 Test Data (30MHz – 1GHz) .

30M – 1GHz Open Field Radiated Emissions (Horizontal)

Operator: Jerry Chiou
 Temperature (C): 27
 Humidity (%): 63

Frequency	Rx Amp.	Ant Fact	CableLoss	PreAmpGain	Corrct. Emi.	Limit	Margin	Ant. Pos.	Table Pos.
MHz	(dBuV)	(dB/m)	(dB)	(dB)	(dBuV/m)	(dBuV/m)	(dB)	(cm)	(deg)
47.46	16.27	8.62	1.36	0.00	26.25	40.00	-13.75	102	165
106.63	14.62	11.10	2.06	0.00	27.78	43.50	-15.72	102	67
119.24	15.84	11.59	2.20	0.00	29.62	43.50	-13.88	102	116
151.25	22.48	9.40	2.54	0.00	34.42	43.50	-9.08	196	359
167.74	19.98	8.62	2.69	0.00	31.29	43.50	-12.21	196	359
215.27	20.71	8.40	3.08	0.00	32.19	43.50	-11.31	196	229
530.52	5.32	18.13	5.80	0.00	29.25	46.00	-16.75	102	150
580.96	14.71	18.66	6.28	0.00	39.65	46.00	-6.35	196	213
591.63	8.63	18.68	6.36	0.00	33.67	46.00	-12.33	196	19

30M – 1GHz Open Field Radiated Emissions (Vertical)

Operator: Jerry Chiou
 Temperature (C): 27
 Humidity (%): 63

Frequency	Rx Amp.	Ant Fact	CableLoss	PreAmpGain	Corrct. Emi.	Limit	Margin	Ant. Pos.	Table Pos.
MHz	(dBuV)	(dB/m)	(dB)	(dB)	(dBuV/m)	(dBuV/m)	(dB)	(cm)	(deg)
47.46	17.00	8.62	1.36	0.00	26.98	40.00	-13.02	102	165
119.24	14.06	11.59	2.20	0.00	27.85	43.50	-15.65	102	116
150.28	18.61	9.48	2.55	0.00	30.63	43.50	-12.87	196	359
223.03	20.47	8.58	3.15	0.00	32.20	46.00	-13.80	196	229
443.22	10.07	16.16	5.13	0.00	31.36	46.00	-14.64	102	343
534.4	7.37	18.23	5.83	0.00	31.42	46.00	-14.58	196	213
582.9	14.52	18.67	6.29	0.00	39.48	46.00	-6.52	196	51
589.69	9.41	18.68	6.34	0.00	34.43	46.00	-11.57	196	19
644.01	4.25	18.96	6.75	0.00	29.96	46.00	-16.04	196	327

* NOTE: During the pre-test, the EUT has been tested for Channel 36, 48, 52, 64 of Normal Mode, Channel 40, 58 of Turbo Mode and transmit from Main and Aux antenna respectively to get all the critical emission frequencies. In the final test all the critical emission frequencies has been tested and the test data are listed above.

Margin=Corrected Amplitude-Limit

Corrected Amplitude = Radiated Amplitude + Antenna Correction Factor + Cable Loss - Pre-Amplifier Gain

A margin of -8dB means that the emission is 8dB below the limit

All frequencies from 30MHz to 1GHz have been tested

4.5.5 Test Data (1GHz – 40 GHz, Transmitting) .

1GHz~ 40 GHz (Horizontal), Normal Mode, Channel 36: 5180 MHz

Operator: Jerry Chiou

RBW: 1MHz
Humidity (%): 36
Temperature (C): 24

Frequency	Rx_R.	Ant_F	Cab_L	PreAmpl	Emission	Limit	Margin	A.Towe r	T.Table
MHz	dBuV	dB/m	dB	dB	dBuV/m	dBuV/m	dB	cm	deg
10353.8	31.55pk	39.52	3.28	34.55	39.80pk	54.00av	-14.20	101	82

1GHz~ 40 GHz (Vertical), Normal Mode, Channel 36: 5180 MHz

Operator: Jerry Chiou

RBW: 1MHz
Humidity (%): 36
Temperature (C): 24

Frequency	Rx_R.	Ant_F	Cab_L	PreAmpl	Emission	Limit	Margin	A.Towe r	T.Table
MHz	dBuV	dB/m	dB	dB	dBuV/m	dBuV/m	dB	cm	deg
6588.81	46.83pk	36.88	3.35	37.60	49.46pk	54.00av	-4.54	101	182
6718.28	46.84pk	37.58	3.27	37.49	50.20pk	54.00av	-3.80	101	159
10353.8	26.55pk	39.52	3.28	34.55	44.80pk	54.00av	-9.20	101	82

Note: “ * ”: Fundamental Frequency

“ pk ”: peak reading

“ av ”: average reading

The Spectrum noise level+Correction Factor<Limit-6 dB

Margin = Corrected Amplitude – Limit

Corrected Amplitude=Radiated Amplitude+Antenna Correction Factor+Cable Loss-Pre-Amplifier Gain

A margin of -8dB means that the emission is 8dB below the limit.

All frequencies from 1GHz to 40 GHz have been tested.

1GHz~ 40 GHz (Horizontal), Normal Mode, Channel 48: 5240 MHz

Operator: Jerry Chiou

RBW: 1MHz

Humidity (%): 36

Temperature (C): 24

Frequency	Rx_R.	Ant_F.	Cab_L.	PreAmpl	Emission	Limit	Margin	A.Tower	T.Table
MHz	dBuV	dB/m	dB	dB	dBuV/m	dBuV/m	dB	cm	deg
7070.73	45.23pk	39.21	2.98	37.12	50.29pk	54.00av	-3.71	101	119
7466.33	45.56pk	39.85	2.28	36.42	51.27pk	54.00av	-2.73	101	177

1GHz~ 40 GHz (Vertical), Normal Mode, Channel 48: 5240 MHz

Operator: Jerry Chiou

RBW: 1MHz

Humidity (%): 36

Temperature (C): 24

Frequency	Rx_R.	Ant_F.	Cab_L.	PreAmpl	Emission	Limit	Margin	A.Tower	T.Table
MHz	dBuV	dB/m	dB	dB	dBuV/m	dBuV/m	dB	cm	deg
6567.23	46.59pk	36.76	3.36	37.61	49.10pk	54.00av	-4.90	101	186
6754.25	46.74pk	37.77	3.25	37.46	50.31pk	54.00av	-3.69	101	153
10461.5	34.96pk	39.43	3.24	34.58	43.05pk	54.00av	-10.95	101	108

Note: “*” : Fundamental Frequency

“pk”: peak reading

“av”: average reading

The Spectrum noise level+Correction Factor<Limit-6 dB

Margin = Corrected Amplitude – Limit

Corrected Amplitude=Radiated Amplitude+Antenna Correction Factor+Cable Loss-Pre-Amplifier Gain

A margin of -8dB means that the emission is 8dB below the limit.

All frequencies from 1GHz to 40 GHz have been tested.

1GHz~ 40 GHz (Horizontal), Normal Mode, Channel 52: 5260 MHz

Operator: Jerry Chiou

RBW: 1MHz

Humidity (%): 36

Temperature (C): 24

Frequency	Rx_R.	Ant_F.	Cab_L.	PreAmpl	Emission	Limit	Margin	A.Tower	T.Table
MHz	dBuV	dB/m	dB	dB	dBuV/m	dBuV/m	dB	cm	deg
7099.5	45.67pk	39.26	2.92	37.07	50.78pk	54.00av	-3.22	101	124
7466.33	45.09pk	39.85	2.28	36.42	50.80pk	54.00av	-3.20	101	177

1GHz~ 40 GHz (Vertical), Normal Mode, Channel 52: 5260 MHz

Operator: Jerry Chiou

RBW: 1MHz

Humidity (%): 36

Temperature (C): 24

Frequency	Rx_R.	Ant_F.	Cab_L.	PreAmpl	Emission	Limit	Margin	A.Tower	T.Table
MHz	dBuV	dB/m	dB	dB	dBuV/m	dBuV/m	dB	cm	deg
6739.86	47.00pk	37.70	3.26	37.47	50.48pk	54.00av	-3.52	101	155
7099.5	46.05pk	39.26	2.92	37.07	51.16pk	54.00av	-2.84	101	124
10520.3	33.25pk	39.40	3.23	34.59	41.29pk	54.00av	-12.71	102	121

Note: “ * ”: Fundamental Frequency

“ pk ”: peak reading

“ av ”: average reading

The Spectrum noise level+Correction Factor<Limit-6 dB

Margin = Corrected Amplitude – Limit

Corrected Amplitude=Radiated Amplitude+Antenna Correction Factor+Cable Loss-Pre-Amplifier Gain

A margin of -8dB means that the emission is 8dB below the limit.

All frequencies from 1GHz to 40 GHz have been tested.

1GHz~ 40 GHz (Horizontal), Normal Mode, Channel 64: 5320 MHz

Operator: Jerry Chiou

RBW: 1MHz

Humidity (%): 36

Temperature (C): 24

Frequency	Rx_R.	Ant_F.	Cab_L.	PreAmpl	Emission	Limit	Margin	A.Tower	T.Table
MHz	dBuV	dB/m	dB	dB	dBuV/m	dBuV/m	dB	cm	deg
6567.23	47.21pk	36.76	3.36	37.61	49.72pk	54.00av	-4.28	101	186
6718.28	46.90pk	37.58	3.27	37.49	50.26pk	54.00av	-3.74	101	159

1GHz~ 40 GHz (Vertical), Normal Mode, Channel 64: 5320 MHz

Operator: Jerry Chiou

RBW: 1MHz

Humidity (%): 36

Temperature (C): 24

Frequency	Rx_R.	Ant_F.	Cab_L.	PreAmpl	Emission	Limit	Margin	A.Tower	T.Table
MHz	dBuV	dB/m	dB	dB	dBuV/m	dBuV/m	dB	cm	deg
6560.04	48.52pk	36.72	3.36	37.62	50.99pk	54.00av	-3.01	101	187
6754.25	48.08pk	37.77	3.25	37.46	51.64pk	54.00av	-2.36	101	153

Note: “ * ”: Fundamental Frequency

“ pk ”: peak reading

“ av ”: average reading

The Spectrum noise level+Correction Factor<Limit-6 dB

Margin = Corrected Amplitude – Limit

Corrected Amplitude=Radiated Amplitude+Antenna Correction Factor+Cable Loss-Pre-Amplifier Gain

A margin of -8dB means that the emission is 8dB below the limit.

All frequencies from 1GHz to 40 GHz have been tested.

1GHz~ 40 GHz (Horizontal), Turbo Mode, Channel 40: 5200 MHz

Operator: Jerry Chiou

RBW: 1MHz

Humidity (%): 36

Temperature (C): 24

Frequency	Rx_R.	Ant_F.	Cab_L.	PreAmpl	Emission	Limit	Margin	A.Tower	T.Table
MHz	dBuV	dB/m	dB	dB	dBuV/m	dBuV/m	dB	cm	deg
6732.67	46.53pk	37.66	3.26	37.47	49.97pk	54.00av	-4.03	101	157
7099.5	45.84pk	39.26	2.92	37.07	50.95pk	54.00av	-3.05	101	124

1GHz~ 40 GHz (Vertical), Turbo Mode, Channel 40: 5200 MHz

Operator: Jerry Chiou

RBW: 1MHz

Humidity (%): 36

Temperature (C): 24

Frequency	Rx_R.	Ant_F.	Cab_L.	PreAmpl	Emission	Limit	Margin	A.Tower	T.Table
MHz	dBuV	dB/m	dB	dB	dBuV/m	dBuV/m	dB	cm	deg
6718.28	46.97pk	37.58	3.27	37.49	50.33pk	54.00av	-3.67	101	159
6955.64	46.70pk	38.86	3.13	37.29	51.40pk	54.00av	-2.60	101	117

Note: “ * ”: Fundamental Frequency

“ pk ”: peak reading

“ av ”: average reading

The Spectrum noise level+Correction Factor<Limit-6 dB

Margin = Corrected Amplitude – Limit

Corrected Amplitude=Radiated Amplitude+Antenna Correction Factor+Cable Loss-Pre-Amplifier Gain

A margin of -8dB means that the emission is 8dB below the limit.

All frequencies from 1GHz to 40 GHz have been tested.

1GHz~ 40 GHz (Horizontal), Turbo Mode, Channel 58: 5290 MHz

Operator: Jerry Chiou

RBW: 1MHz
 Humidity (%): 36
 Temperature (C): 24

Frequency	Rx_R.	Ant_F.	Cab_L.	PreAmpl	Emission	Limit	Margin	A.Tower	T.Table
MHz	dBuV	dB/m	dB	dB	dBuV/m	dBuV/m	dB	cm	deg
6941.26	45.82pk	38.78	3.14	37.30	50.44pk	54.00av	-3.56	101	119
7099.5	45.57pk	39.26	2.92	37.07	50.68pk	54.00av	-3.32	101	124

1GHz~ 40 GHz (Vertical), Turbo Mode, Channel 58: 5290 MHz

Operator: Jerry Chiou

RBW: 1MHz
 Humidity (%): 36
 Temperature (C): 24

Frequency	Rx_R.	Ant_F.	Cab_L.	PreAmpl	Emission	Limit	Margin	A.Tower	T.Table
MHz	dBuV	dB/m	dB	dB	dBuV/m	dBuV/m	dB	cm	deg
6739.86	47.60pk	37.70	3.26	37.47	51.08pk	54.00av	-2.92	101	155
6991.61	46.27pk	39.05	3.11	37.26	51.18pk	54.00av	-2.82	101	110

Note: “ * ”: Fundamental Frequency

“ pk ”: peak reading

“ av ”: average reading

The Spectrum noise level+Correction Factor<Limit-6 dB

Margin = Corrected Amplitude – Limit

Corrected Amplitude=Radiated Amplitude+Antenna Correction Factor+Cable Loss-Pre-Amplifier Gain

A margin of -8dB means that the emission is 8dB below the limit.

All frequencies from 1GHz to 40 GHz have been tested.

4.6 Band Edge Measurement (Section 15.407 (b) (1) (2))

4.6.1 Test Procedure (Conducted)

1. The Transmitter output of EUT was connected to the spectrum analyzer.
Equipment mode: Spectrum analyzer

Peak Mode:	
SPAN	100MHz
RBW	1MHz
VBW	1MHz
Sweep Time	200msec.

2. Using Peak Search to read the peak power of Carrier frequencies after Maximum Hold function is completed.
3. Find the next peak frequency outside the operation frequency band.

4.6.2 Test Setup (Conducted)

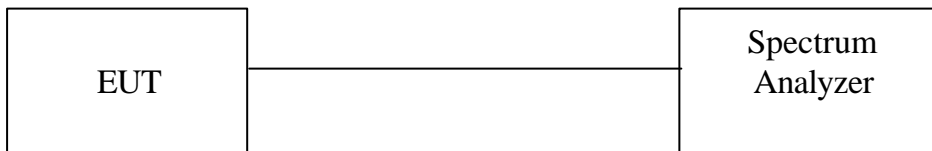

4.6.3 Test Data (conducted):

Please refer to Elliott Laboratories, Inc. Report Number: R60260
FCC ID: PPD-AR5BXB6

4.6.4 Bandedge Measurement Test Procedure (Radiated)

1. Antenna and Turntable test procedure same as Radiated Emissions measurement listed in Para. 6.5
 Equipment mode: Spectrum analyzer

Peak Mode:	
SPAN	100MHz
RBW	1MHz
VBW	3MHz
Sweep Time	200msec.
AVE Mode:	
SPAN	100MHz
RBW	1MHz
VBW	10Hz
Sweep Time	20 sec.

2. Using Peak Search to read the peak power of Carrier frequencies after Maximun Hold function is completed.
3. Find the next peak frequency outside the operation frequency band.
4. Get the spectrum reading after Maximun Hold function is completed.

4.6.5 Test Setup (Radiated)

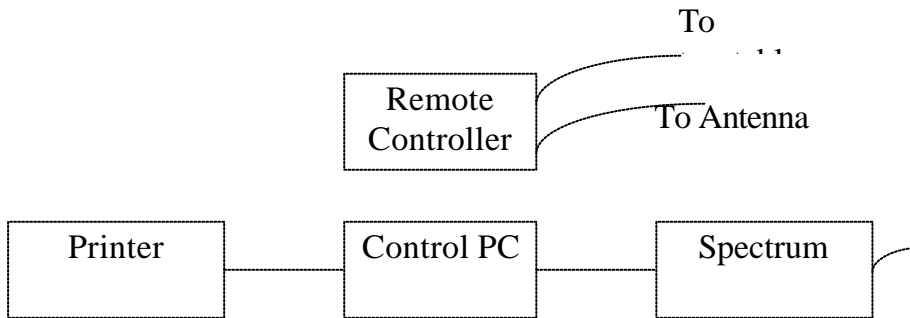
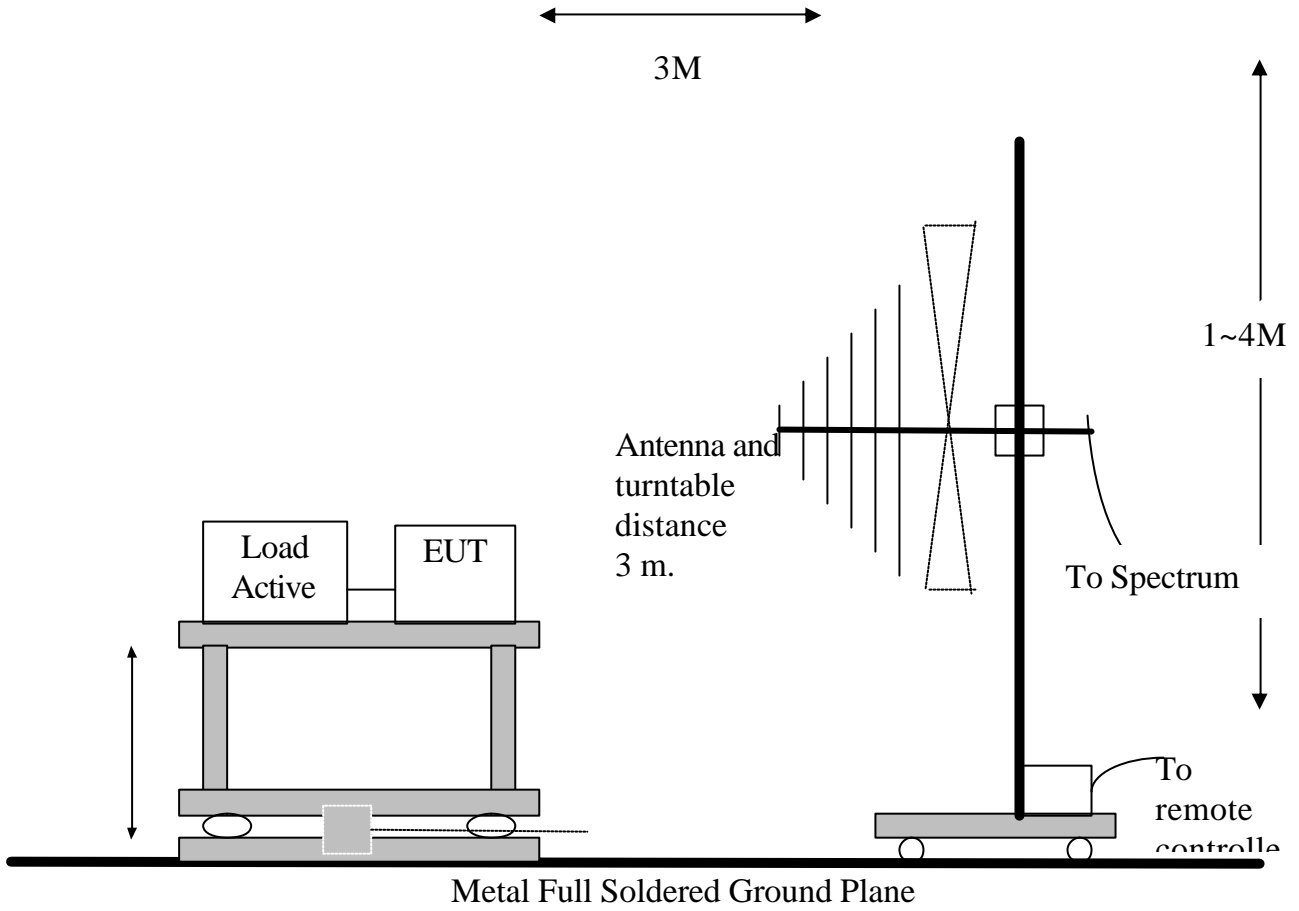

4.6.6 Test Data (Radiated):

Band Edge measurement (Radiated)

Test Engineer: Jerry Chiou Temperature (deg. C): 25
 Humidity (%): 50

Outside Channel (Normal)	Frequency (MHz)	Spectrum Reading (dBuV)	Correction Factor (dB/m)	Emission Level (dBuV/m)	Limit (dBuV/m)	Pass/Fail
36 (Peak)	5150	22.07	39.03	60.1	74	Pass
36 (Average)	5150	8.81	39.03	47.83	54	Pass
64 (Peak)	5350	21.13	39.34	63.35	74	Pass
64 (Average)	5350.1	8.95	39.34	48.45	54	Pass
Outside Channel (Turbo)	Frequency (MHz)	Spectrum Reading (dBuV)	Correction Factor (dB/m)	Emission Level (dBuV/m)	Limit (dBuV/m)	Pass/Fail
40 (Peak)	5150	21.07	39.03	60.1	74	Pass
40 (Average)	5150	8.8	39.03	47.83	54	Pass
58 (Peak)	5356.5	24.01	39.34	63.35	74	Pass
58 (Average)	5350	9.11	39.34	48.45	54	Pass

Note: "pk": peak reading
 "av": average reading
 Emission Level=Spectrum Reading+Correction Factor
 Correction Factor =Antenna Factor+cable loss
 Both Horizontal and Vertical polarization have been tested and the worst data is listed above.

Band Edge measurement for radiated emission in Restricted Band(Radiated) Normal Mode (Channel 36) Peak data

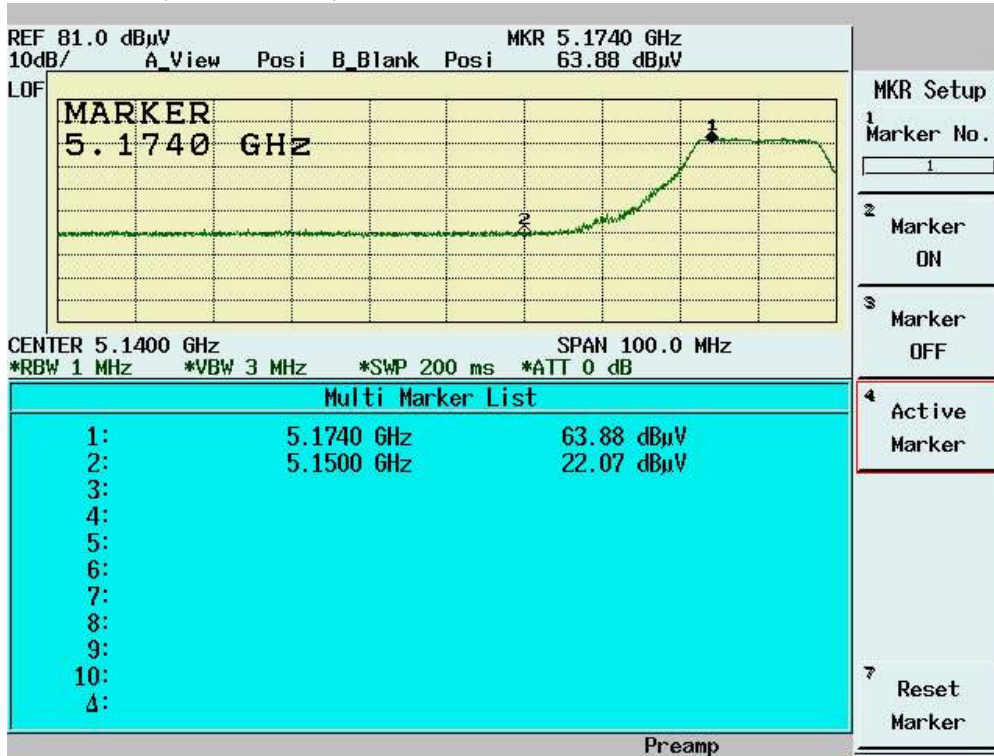

Normal Mode (Channel 36) Average Data

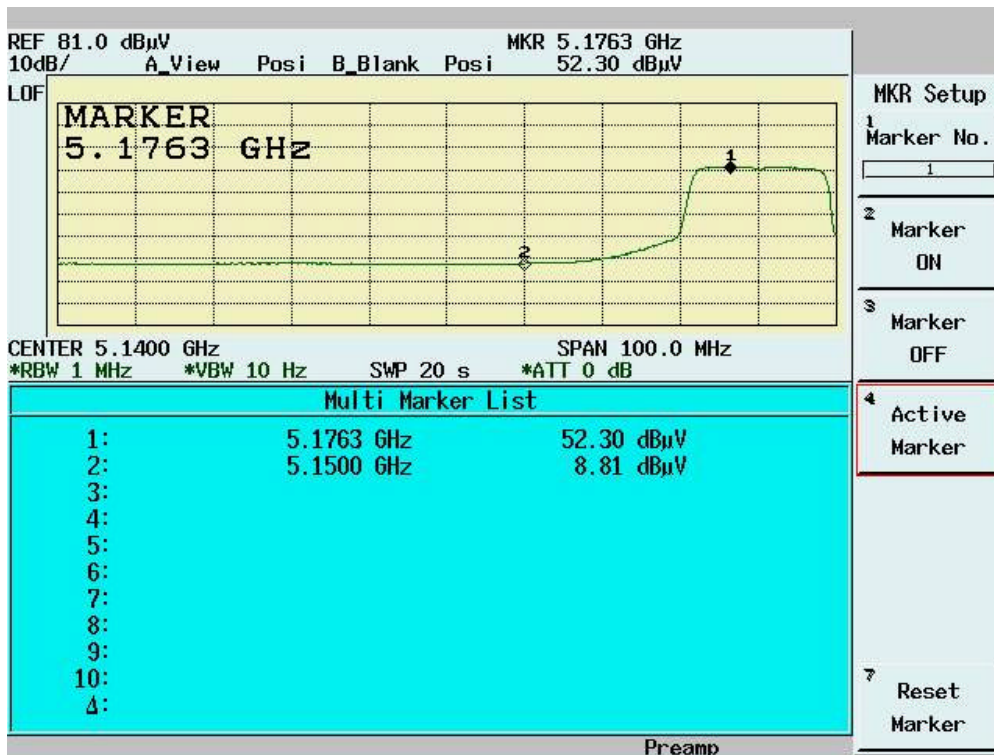

Normal Mode (Channel 64) Peak data

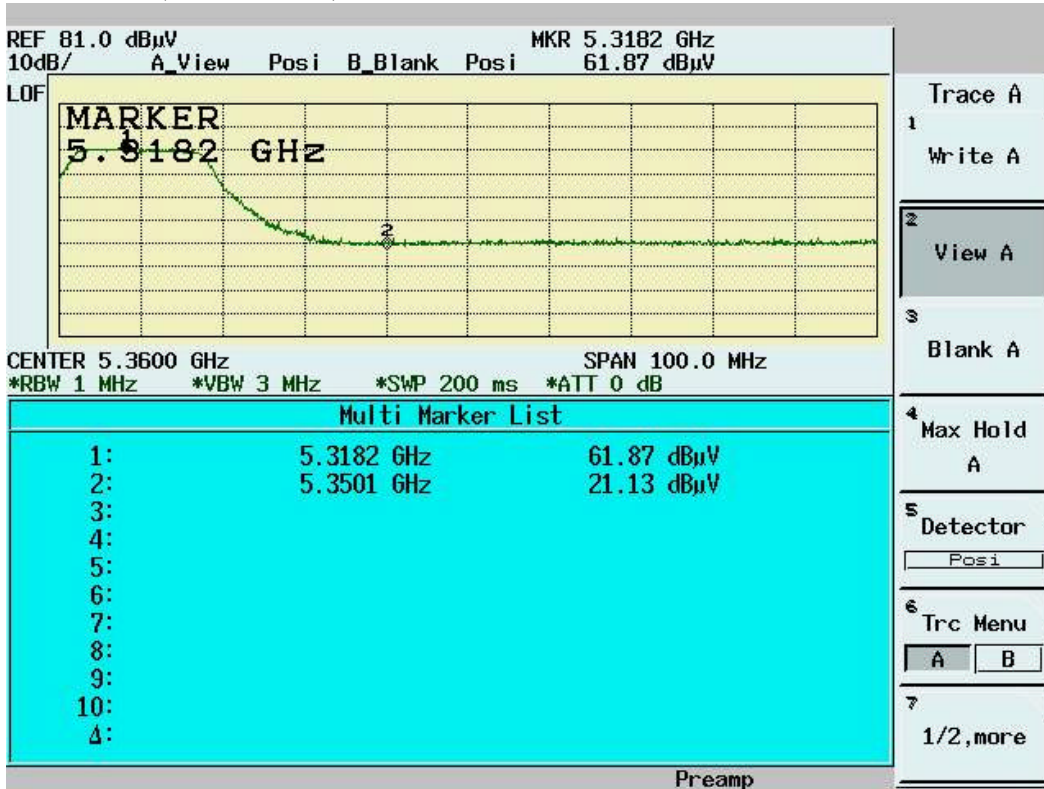

Normal Mode (Channel 64) Average data

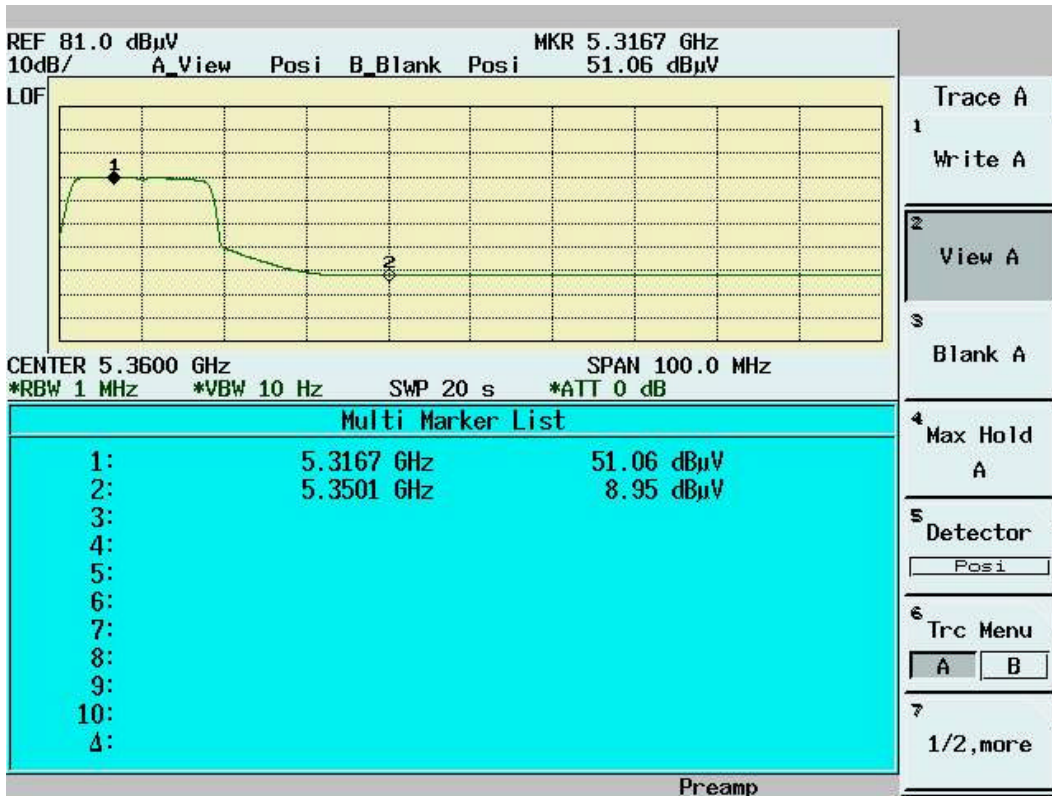

Band Edge measurement for radiated emission in Restricted Band(Radiated) Turbo Mode (Channel 40) Peak data

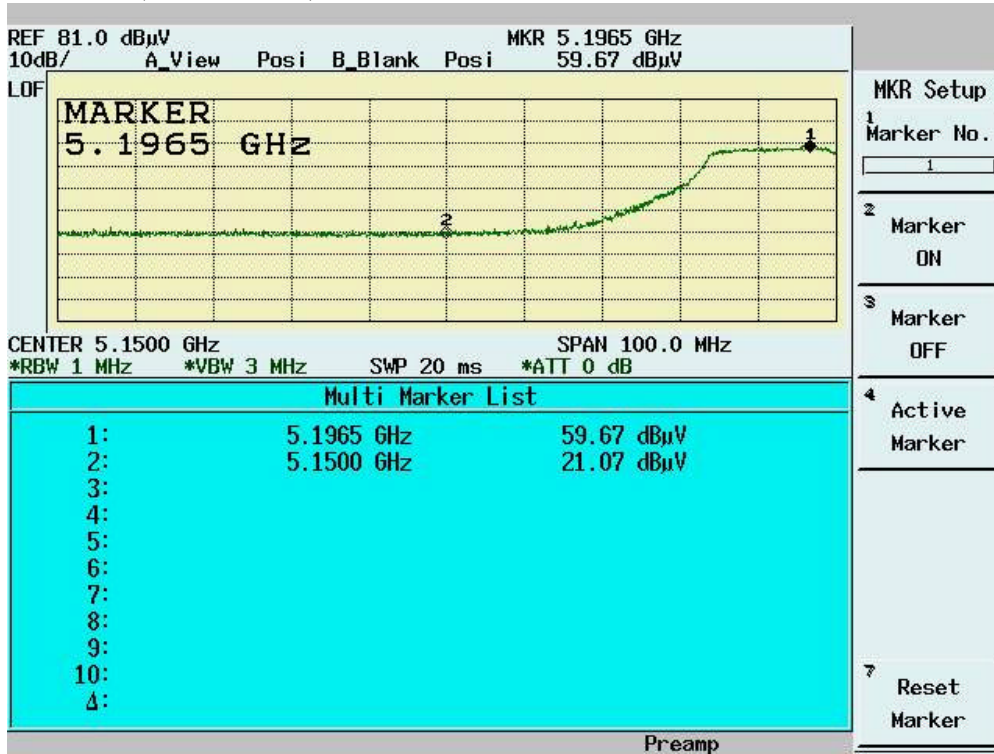

Turbo Mode (Channel 40) Average data

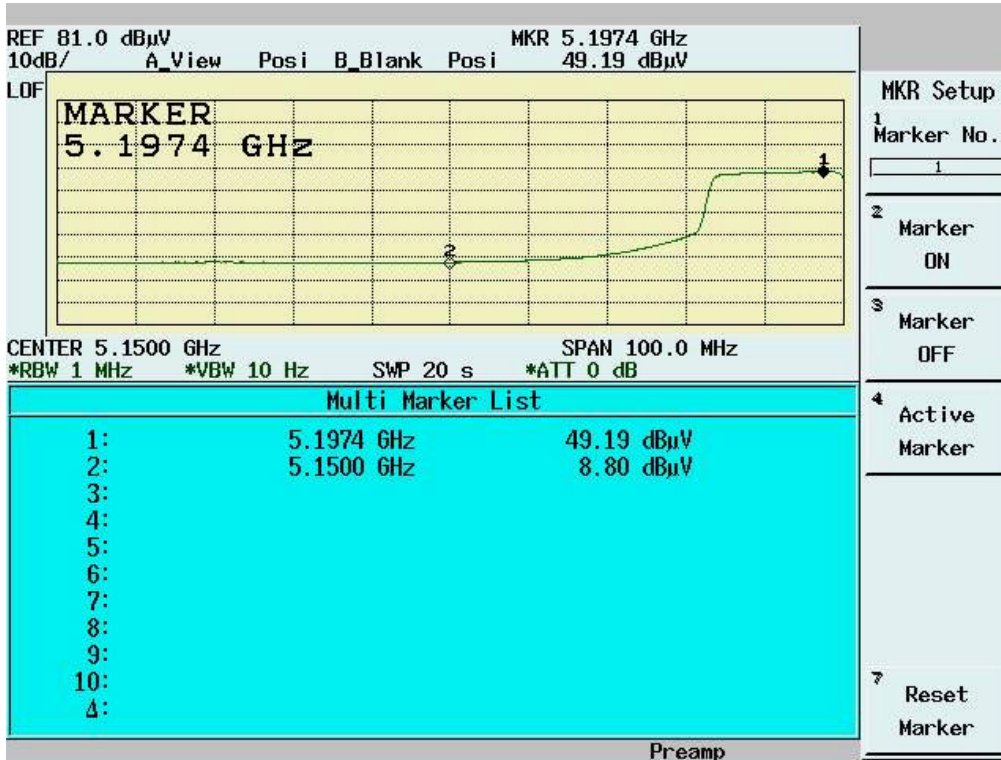

Turbo Mode (Channel 58) Peak data

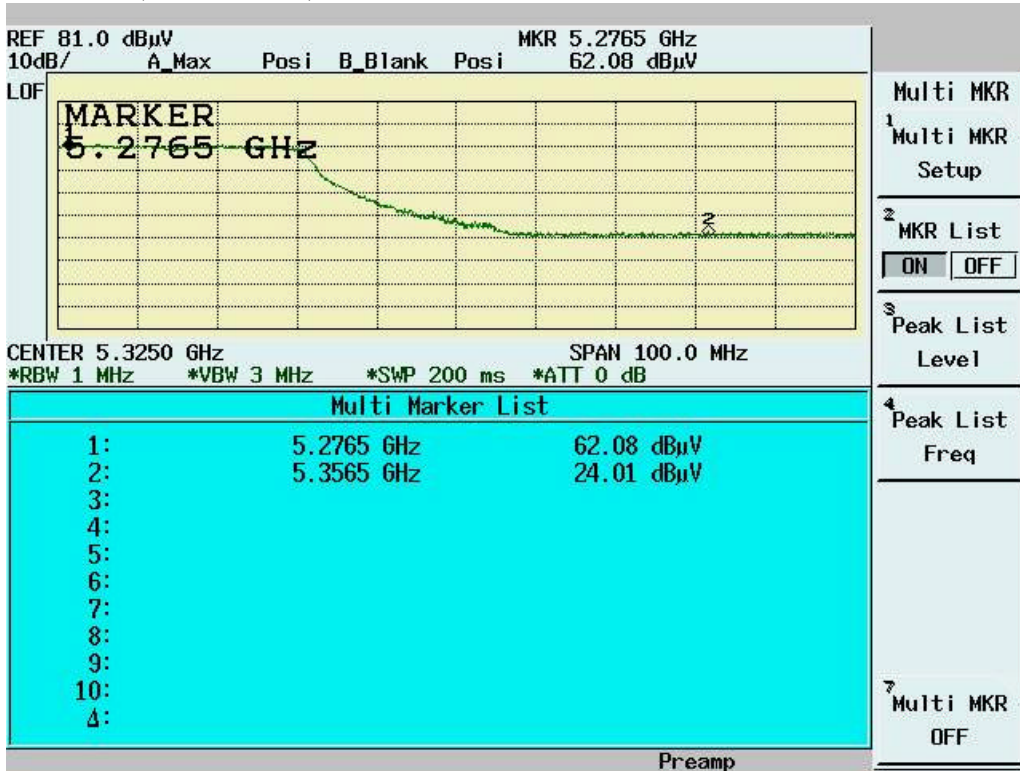

Turbo Mode (Channel 58) Average Data

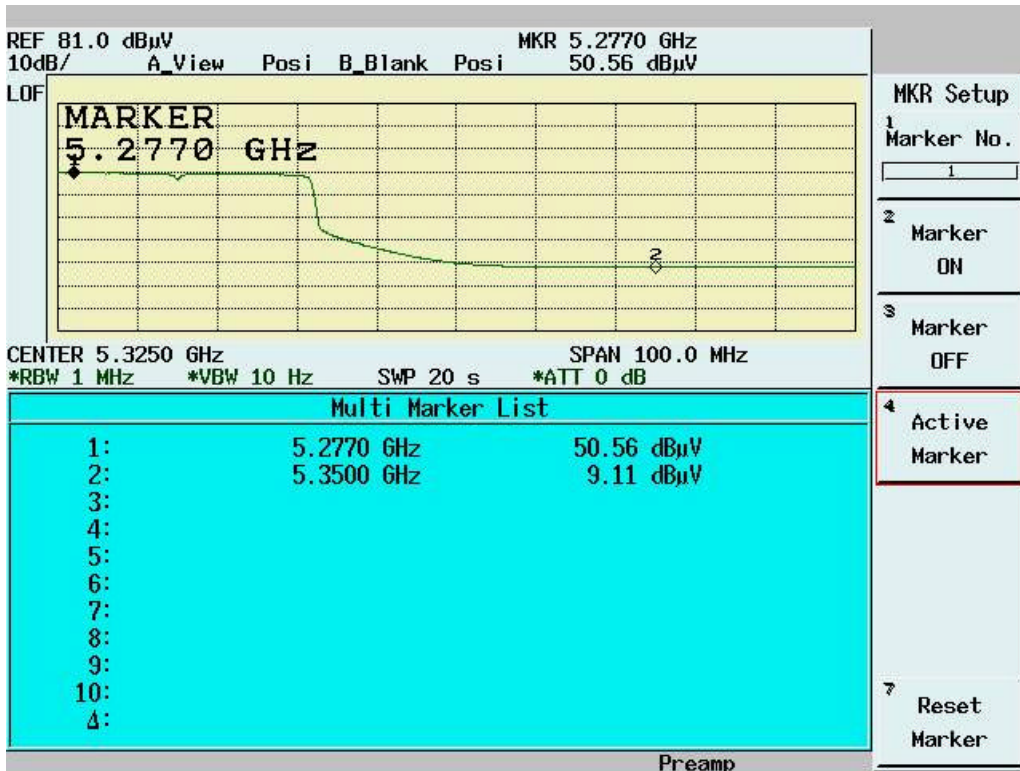

4.7 RF Exposure Measurement [Section 15.407(f)(4) & 1.1307(b)]

Refer to SAR Test Report

4.8 Frequency Stability [Section 15.407(g)]

4.8.1 Limits of Frequency Stability Measurement

The frequency tolerance of the carrier signal shall be maintained within $\pm 0.02\%$ of the operating frequency over the operation temperature range of EUT ($0^{\circ}\text{C}\sim 35^{\circ}\text{C}$), and variation in the primary supply voltage from 85% to 115% of the rated supply voltage (115V AC) at 20°C .

4.8.2 Test Procedure

1. The EUT was placed in the Temperature/Humidity Chamber and powered by a Voltage/Frequency Power converter.
2. Connect the RF output of EUT to Spectrum. Turn on the EUT.
3. Turn the EUT off and set the chamber to the highest temperature specified.
4. Allow sufficient time (approximately 30 min) for the chamber temperature to stabilize. Turn the EUT on and measure the operating frequency after 2, 5, 10 minutes.
5. Set the Voltage/Frequency Power Converter to 85% and 115% of supply voltage, then repeat step 2, 3, 4 respectively.
6. Repeat step 2, 3, 4, 5 with the temperature of chamber set to the lowest temperature.
7. Repeat step 2, 3, 4, 5 with the temperature of chamber set to 20°C .

4.8.3 Test Setup

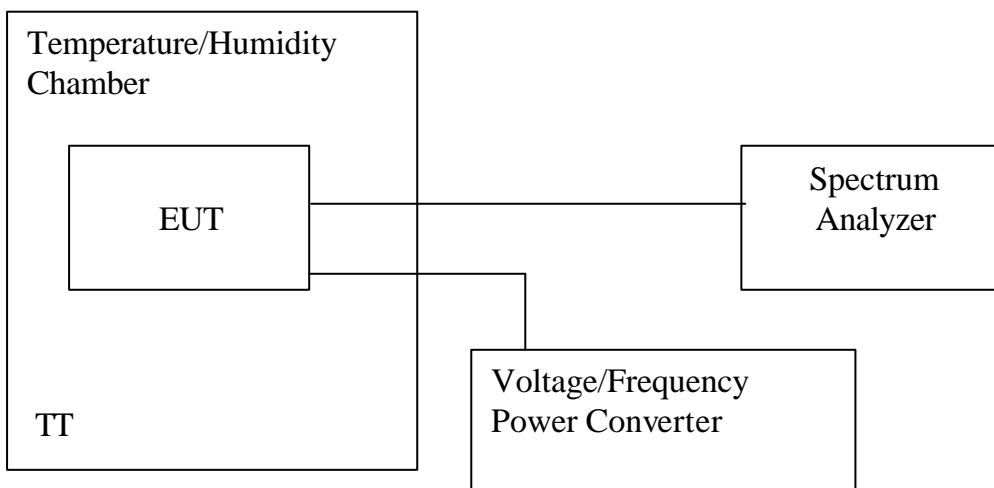

4.8.4 Test Data

Please refer to Elliott Laboratories, Inc. Report Number: R60260
FCC ID: PPD-AR5BXB6

5. TEST RESULTS (802.11a(5725MHz~5850MHz)&802.11b)

5.1 Powerline Conducted Emissions [Section 15.207]

5.1.1 EUT Configuration

The EUT was set up on the non-conductive table that is 1.0 by 1.5 meter, 80cm above ground. The wall of the shielded room was located 40cm to the rear of the EUT.

Power to the EUT was provided through the LISN. The impedance vs. frequency characteristic of the LISN is complied with the limit used.

Both lines (neutral and hot) were connected to the LISN in series at testing. A coaxial-type connector which provides one 50 ohms terminating impedance was provided for connecting the test instrument. The excess length of the power cord was folded back and forth at the center of the lead so as to form a bundle not exceeding 40cm in length.

Any changes made to the configuration, or modifications made to the EUT, during testing are noted in the following test record.

If the EUT is a Personal Computer or a peripheral of personal computer, and the personal computer has an auxiliary AC outlet which can be used for providing power to an external monitor, then all measurements will be made with the monitor power from first the computer-mounted AC outlet and then a floor-mounted AC outlet.

5.1.2 Test Procedure

The system was set up as described above, with the EMI diagnostic software running. The main power line conducted EMI tests were run on the hot and neutral conductors of the power cord and the results were recorded. The effect of varying the position of the interface cables has been investigated to find the configuration that produces maximum emission.

At the frequencies where the peak values of the emissions were higher than 6dB below the applicable limits, the emissions were also measured with the quasi-peak detectors. At the frequencies where the quasi-peak values of the emissions were higher than 6dB below the applicable average limits, the emissions were also measured with the average detectors.

The highest emissions were analyzed in details by operating the spectrum analyzer in fixed tuned mode to determine the nature of the emissions and to provide information which could be useful in reducing their amplitude.

5.1.3 EMI Receiver/Spectrum Analyzer Configuration (for the frequencies tested)

Frequency Range	150 KHz--30MHz
Detector Function	Quasi-Peak/Average
Bandwidth (RBW)	9KHz

5.1.4 Test Data:

Please refer to Elliott Laboratories, Inc. Report Number: R60260
FCC ID: PPD-AR5BXB6

5.2 Bandwidth for DSSS [Section 15.247 (a)(2)]

5.2.1 Test Procedure

The Transmitter output of EUT was connected to the spectrum analyzer. The 6 dB bandwidth of the fundamental frequency was measured. The setting of spectrum analyzer is as follows

Equipment mode	Spectrum analyzer
Detector function	Peak mode
RBW	100KHz
VBW	100KHz

5.2.2 Test Setup

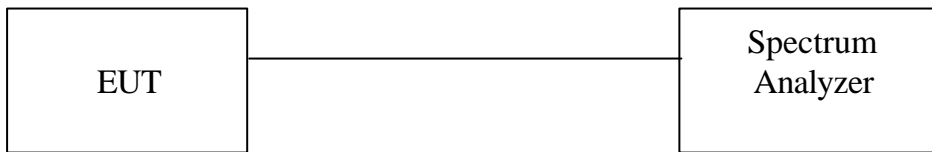

5.2.3 Test Data:

Please refer to Elliott Laboratories, Inc. Report Number: R60260
FCC ID: PPD-AR5BXB6

5.3 DSSS Maximum Peak Output Power [Section 15.247 (b)(1)]

5.3.1 Test Procedure

The Transmitter output of EUT was connected to the peak power analyzer.

5.3.2 Test Setup

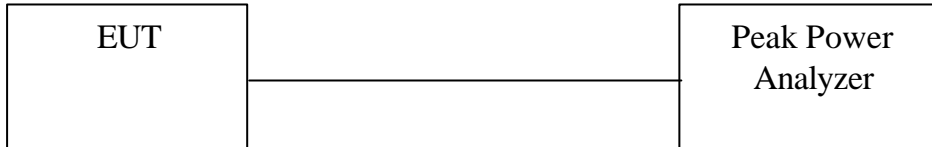

5.3.3 Test Data

Maximum Peak Output Power

802.11a Temp. (deg. C): 25
 Test Engr: Jerry Chiou Humidity (%): 50

Channel	Frequency (Mhz)	Analyzer Reading (dBm)	Cable Loss (dB)	Peak Power Output (mW)	Peak Power Output (dBm)	Limit (dBm)	Pass/Fail
149	5745	20	1.3	134.90	21.3	30	Pass
157	5785	20.1	1.3	138.04	21.4	30	Pass
165	5825	20	1.3	134.90	21.3	30	Pass
152	5760	19.9	1.3	131.83	21.2	30	Pass
161	5805	19.9	1.3	131.83	21.2	30	Pass

802.11b Temp. (deg. C): 25
 Test Engr: Jerry Chiou Humidity (%): 50

Channel	Frequency (Mhz)	Analyzer Reading (dBm)	Cable Loss (dB)	Peak Power Output (mW)	Peak Power Output (dBm)	Limit (dBm)	Pass/Fail
1	2412	18.9	1.1	100.00	20	30	Pass
6	2437	18.4	1.1	89.13	19.5	30	Pass
11	2462	18.5	1.1	91.20	19.6	30	Pass

Note: Two RF output(MAIN & AUX) have been test,the worse data shown above.

5.4 Radiated Emission Measurement [Section [15.247(c)(4)]

5.4.1 EUT Configuration

The equipment under test was set up on the 10 meter chamber with measurement distance of 3 meters. The EUT was placed on a non-conductive table 80cm above ground.

Any changes made to the configuration, or modifications made to the EUT, during testing are noted in the following test record.

5.4.2 Test Procedure

The system was set up as described above, with the EMI diagnostic software running. We found the maximum readings by varying the height of antenna and then rotating the turntable. Both polarization of antenna, horizontal and vertical, are measured.

30M to 1GHz: The highest emissions between 30 MHz to 1000 MHz were also analyzed in details by operating the spectrum analyzer and/or EMI receiver in quasi-peak mode to determine the precise amplitude of the emissions. While doing so, the interconnecting cables and major parts of the system were moved around, the antenna height was varied between one and four meters, its polarization was varied between vertical and horizontal, and the turntable was slowly rotated, to maximize the emission.

1GHz – 25GHz: The highest emissions were also analyzed in details by operating the spectrum analyzer and/or EMI receiver in peak mode to determine the precise amplitude of the emission. While doing so, the interconnecting cables and major parts of the system were moved around, the antenna height was varied between one and four meters, its polarization was varied between vertical and horizontal, and the turntable was slowly rotated, to maximize the emission. During test the EMI receiver and spectrum was setup according to *EMI Receiver/Spectrum Analyzer Configuration*.

For the test of 2nd to 10th harmonics frequencies, the equipment setup was also refer to *EMI Receiver/Spectrum Analyzer Configuration*. The frequencies were tested using Peak mode first, if the test data is higher than the emissions limit, an additional measurement using Average mode will be performed and the average reading will be compared to the limit and record in test report.

5.4.3 EMI Receiver/Spectrum Analyzer Configuration (for the frequencies tested)

Frequency Range Tested:	30MHz~1000MHz
Detector Function:	Quasi-Peak Mode
Resolution Bandwidth (RBW):	120KHz
Video Bandwidth (VBW)	1MHz

Frequency Range Tested:	1GHz – 25 GHz
Detector Function:	Peak Mode
Resolution Bandwidth (RBW):	1MHz
Video Bandwidth (VBW)	3MHz

Frequency Range Tested:	1GHz – 25 GHz
Detector Function:	Average Mode
Resolution Bandwidth (RBW):	1MHz
Video Bandwidth (VBW)	10 Hz

5.4.4 Test Data (30MHz – 1GHz):

30M – 1GHz Open Field Radiated Emissions (Horizontal)

Operator: Jerry Chiou
 Temperature (C): 27
 Humidity (%): 63

Frequency	Rx Amp.	Ant Fact	CableLoss	PreAmpGain	Corrct. Emi.	Limit	Margin	Ant. Pos.	Table Pos.
MHz	(dBuV)	(dB/m)	(dB)	(dB)	(dBuV/m)	(dBuV/m)	(dB)	(cm)	(deg)
47.46	13.12	8.62	1.36	0.00	23.09	40.00	-16.91	102	278
106.63	13.52	11.10	2.06	0.00	26.67	43.50	-16.83	102	67
150.28	19.98	9.48	2.55	0.00	32.01	43.50	-11.49	102	133
167.74	19.00	8.62	2.69	0.00	30.31	43.50	-13.19	102	230
224	18.34	8.64	3.16	0.00	30.15	46.00	-15.85	102	18
230.79	17.98	9.09	3.23	0.00	30.31	46.00	-15.69	102	278
582.9	10.40	18.67	6.29	0.00	35.35	46.00	-10.65	102	165
644.01	4.21	18.96	6.75	0.00	29.92	46.00	-16.08	102	18

30M – 1GHz Open Field Radiated Emissions (Vertical)

Operator: Jerry Chiou
 Temperature (C): 27
 Humidity (%): 63

Frequency	Rx Amp.	Ant Fact	CableLoss	PreAmpGain	Corrct. Emi.	Limit	Margin	Ant. Pos.	Table Pos.
MHz	(dBuV)	(dB/m)	(dB)	(dB)	(dBuV/m)	(dBuV/m)	(dB)	(cm)	(deg)
54.25	20.30	6.61	1.50	0.00	28.41	40.00	-11.59	102	263
119.24	13.45	11.59	2.20	0.00	27.24	43.50	-16.26	102	117
150.28	19.73	9.48	2.55	0.00	31.76	43.50	-11.74	102	133
335.55	9.15	16.11	4.23	0.00	29.49	46.00	-16.51	102	2
452.92	10.95	16.27	5.23	0.00	32.45	46.00	-13.55	102	181
579.99	10.30	18.66	6.27	0.00	35.22	46.00	-10.78	102	295
592.6	6.26	18.69	6.36	0.00	31.31	46.00	-14.69	102	117
915.61	0.61	20.82	8.83	0.00	30.26	46.00	-15.74	102	133

NOTE:

- Margin = Corrected Amplitude – Limit
- Corrected Amplitude = Radiated Amplitude + Antenna Correction Factor + Cable Loss - Pre-Amplifier Gain
- A margin of -8dB means that the emission is 8dB below the limit

All frequencies from 30MHz to 1GHz have been tested

5.4.5 Test Data (1GHz – 25 GHz) .

802.11a

1GHz~ 40 GHz (Horizontal), Normal Mode Channel 149: 5745 MHz

Operator: Jerry Chiou

RBW: 1MHz

Humidity (%): 36

Temperature (C): 24

Frequency	Rx_R.	Ant_F.	Cab_L.	PreAmpl	Emission	Limit	Margin	A.Tower	T.Table
MHz	dBuV	dB/m	dB	dB	dBuV/m	dBuV/m	dB	cm	deg
6552.85	46.44pk	36.69	3.37	37.63	48.87pk	54.00av	-5.13	101	189
6739.86	46.59pk	37.70	3.26	37.47	50.08pk	54.00av	-3.92	101	155

1GHz~ 40 GHz (Vertical) Normal Mode, Channel 149: 5745 MHz

Operator: Jerry Chiou

RBW: 1MHz

Humidity (%): 36

Temperature (C): 24

Frequency	Rx_R.	Ant_F.	Cab_L.	PreAmpl	Emission	Limit	Margin	A.Tower	T.Table
MHz	dBuV	dB/m	dB	dB	dBuV/m	dBuV/m	dB	cm	deg
6732.67	46.83pk	37.66	3.26	37.47	50.27pk	54.00av	-3.73	101	157
6934.07	46.63pk	38.74	3.14	37.31	51.20pk	54.00av	-2.80	101	121
11489.5	36.92pk	40.67	3.08	34.87	45.81pk	54.00av	-8.19	101	161

Note: “ * ”: Fundamental Frequency

“ pk” : peak reading

“ av” : average reading

The Spectrum noise level+Correction Factor<Limit-6 dB

Margin = Corrected Amplitude – Limit

Corrected Amplitude=Radiated Amplitude+Antenna Correction Factor+Cable Loss-Pre-Amplifier Gain

A margin of -8dB means that the emission is 8dB below the limit.

All frequencies from 1GHz to 40 GHz have been tested.

1GHz~ 40 GHz (Horizontal), Normal Mode Channel 157: 5785 MHz

Operator: Jerry Chiou

RBW: 1MHz

Humidity (%): 36

Temperature (C): 24

Frequency	Rx_R.	Ant_F.	Cab_L.	PreAmpl	Emission	Limit	Margin	A.Tower	T.Table
MHz	dBuV	dB/m	dB	dB	dBuV/m	dBuV/m	dB	cm	deg
6955.64	45.83pk	38.86	3.13	37.29	50.53pk	54.00av	-3.47	101	117
7085.11	45.65pk	39.24	2.95	37.10	50.74pk	54.00av	-3.26	101	121

1GHz~ 40 GHz (Vertical) Normal Mode, Channel 157: 5785 MHz

Operator: Jerry Chiou

RBW: 1MHz

Humidity (%): 36

Temperature (C): 24

Frequency	Rx_R.	Ant_F.	Cab_L.	PreAmpl	Emission	Limit	Margin	A.Tower	T.Table
MHz	dBuV	dB/m	dB	dB	dBuV/m	dBuV/m	dB	cm	deg
6739.86	46.45pk	37.70	3.26	37.47	49.94pk	54.00av	-4.06	101	155
6998.8	45.55pk	39.09	3.10	37.25	50.50pk	54.00av	-3.50	101	109
11558	39.62pk	40.89	3.14	34.92	48.72pk	54.00av	-5.28	101	150

Note: “*” : Fundamental Frequency

“pk”: peak reading

“av”: average reading

The Spectrum noise level+Correction Factor<Limit-6 dB

Margin = Corrected Amplitude – Limit

Corrected Amplitude=Radiated Amplitude+Antenna Correction Factor+Cable Loss-Pre-Amplifier Gain

A margin of -8dB means that the emission is 8dB below the limit.

All frequencies from 1GHz to 40 GHz have been tested.

1GHz~ 40 GHz (Horizontal), Normal Mode, Channel 165: 5825 MHz

Operator: Jerry Chiou

RBW: 1MHz
Humidity (%): 36
Temperature (C): 24

Frequency	Rx_R.	Ant_F.	Cab_L.	PreAmpl	Emission	Limit	Margin	A.Tower	T.Table
MHz	dBuV	dB/m	dB	dB	dBuV/m	dBuV/m	dB	cm	deg
6567.23	46.97pk	36.76	3.36	37.61	49.48pk	54.00av	-4.52	101	186
6768.63	46.00pk	37.85	3.24	37.44	49.65pk	54.00av	-4.35	101	150
11646.2	36.70pk	41.17	3.24	35.00	46.10pk	54.00av	-7.90	101	137

1GHz~ 40 GHz (Vertical), Normal Mode, Channel 165: 5825 MHz

Operator: Jerry Chiou

RBW: 1MHz
Humidity (%): 36
Temperature (C): 24

Frequency	Rx_R.	Ant_F.	Cab_L.	PreAmpl	Emission	Limit	Margin	A.Tower	T.Table
MHz	dBuV	dB/m	dB	dB	dBuV/m	dBuV/m	dB	cm	deg
6977.22	45.88pk	38.98	3.11	37.27	50.70pk	54.00av	-3.30	101	113
7092.31	45.30pk	39.25	2.94	37.09	50.40pk	54.00av	-3.60	101	122
11646.2	43.21pk	41.17	3.24	35.00	52.62pk	54.00av	-1.38	101	137

Note: “ * ”: Fundamental Frequency

“ pk ”: peak reading

“ av ”: average reading

The Spectrum noise level+Correction Factor<Limit-6 dB

Margin = Corrected Amplitude – Limit

Corrected Amplitude=Radiated Amplitude+Antenna Correction Factor+Cable Loss-Pre-Amplifier Gain

A margin of -8dB means that the emission is 8dB below the limit.

All frequencies from 1GHz to 40 GHz have been tested.

1GHz~ 40 GHz (Horizontal), Turbo Mode, Channel 152 : 5760 MHz

Operator: Jerry Chiou

RBW: 1MHz

Humidity (%): 36

Temperature (C): 24

Frequency	Rx_R.	Ant_F.	Cab_L.	PreAmpl	Emission	Limit	Margin	A.Tower	T.Table
MHz	dBuV	dB/m	dB	dB	dBuV/m	dBuV/m	dB	cm	deg
6941.26	46.20pk	38.78	3.14	37.30	50.82pk	54.00av	-3.18	101	119
7372.83	45.52pk	39.70	2.44	36.59	51.07pk	54.00av	-2.93	101	163

1GHz~ 40 GHz (Vertical), Turbo Mode, Channel 152: 5760 MHz

Operator: Jerry Chiou

RBW: 1MHz

Humidity (%): 36

Temperature (C): 24

Frequency	Rx_R.	Ant_F.	Cab_L.	PreAmpl	Emission	Limit	Margin	A.Tower	T.Table
MHz	dBuV	dB/m	dB	dB	dBuV/m	dBuV/m	dB	cm	deg
7092.31	47.39pk	39.25	2.94	37.09	52.49pk	54.00av	-1.51	101	122
7567.03	45.82pk	39.99	2.26	36.19	51.89pk	54.00av	-2.11	100	192

Note: “*” : Fundamental Frequency

“pk”: peak reading

“av”: average reading

The Spectrum noise level+Correction Factor<Limit-6 dB

Margin = Corrected Amplitude – Limit

Corrected Amplitude=Radiated Amplitude+Antenna Correction Factor+Cable Loss-Pre-Amplifier Gain

A margin of -8dB means that the emission is 8dB below the limit.

All frequencies from 1GHz to 40 GHz have been tested.

1GHz~ 40 GHz (Horizontal) , Turbo Mode, Channel 161 : 5805 MHZ

Operator: Jerry Chiou

RBW: 1MHz
Humidity (%): 36
Temperature (C): 24

Frequency	Rx_R.	Ant_F.	Cab_L.	PreAmpl	Emission	Limit	Margin	A.Tower	T.Table
MHz	dBuV	dB/m	dB	dB	dBuV/m	dBuV/m	dB	cm	deg
6754.25	46.45pk	37.77	3.25	37.46	50.01pk	54.00av	-3.99	101	153
6948.45	45.91pk	38.82	3.13	37.29	50.57pk	54.00av	-3.43	101	118

1GHz~ 40 GHz (Vertical), Turbo Mode, Channel 161 : 5805 MHZ

Operator: Jerry Chiou

RBW: 1MHz
Humidity (%): 36
Temperature (C): 24

Frequency	Rx_R.	Ant_F.	Cab_L.	PreAmpl	Emission	Limit	Margin	A.Tower	T.Table
MHz	dBuV	dB/m	dB	dB	dBuV/m	dBuV/m	dB	cm	deg
6732.67	46.72pk	37.66	3.26	37.47	50.16pk	54.00av	-3.84	101	157
6962.84	46.51pk	38.90	3.12	37.28	51.25pk	54.00av	-2.75	101	116

Note: “ * ”: Fundamental Frequency

“ pk ”: peak reading

“ av ”: average reading

The Spectrum noise level+Correction Factor<Limit-6 dB

Margin = Corrected Amplitude – Limit

Corrected Amplitude=Radiated Amplitude+Antenna Correction Factor+Cable Loss-Pre-Amplifier Gain

A margin of -8dB means that the emission is 8dB below the limit.

All frequencies from 1GHz to 40 GHz have been tested.

802.11b

1GHz~ 25 GHz (Horizontal), Channel 1: 2412 MHz

Operator: Jerry Chiou

RBW: 1MHz
Humidity (%): 36
Temperature (C): 24

Frequency MHz	Rx_R. dBuV	Ant_F. dB/m	Cab_L. dB	PreAmpl dB	Emission dBuV/m	Limit dBuV/m	Margin dB	A.Tower cm	T.Table deg
1659.34	41.82	28.14	2.35	23.75	48.56	54.00	-5.44	101	67
7222.78	34.37	38.09	3.85	26.60	49.71	54.00	-4.29	101	142

1GHz~ 25 GHz (Vertical), Channel 1: 2412 MHz

Operator: Jerry Chiou

RBW: 1MHz
Humidity (%): 36
Temperature (C): 24

Frequency MHz	Rx_R. dBuV	Ant_F. dB/m	Cab_L. dB	PreAmpl dB	Emission dBuV/m	Limit dBuV/m	Margin dB	A.Tower cm	T.Table deg
1664.34	42.88	28.18	2.35	23.75	49.66	54.00	-4.34	101	66
2326.17	40.65	30.93	1.60	24.45	48.73	54.00	-5.27	101	145
2493.51	42.59	30.90	1.40	24.82	50.07	54.00	-3.93	101	198
7222.78	34.47	38.09	3.85	26.60	49.81	54.00	-4.19	101	142

Note:

- According to the standards used, Where limits are specified by agencies for both average and peak (or quasi-peak) detection , if the peak (or quasi-peak) measured value complies with the average limit , it is unnecessary to perform an average measurement.
- “ * ”: Fundamental Frequency
- “***”: Not in the restricted band, Limit level=Fundamental Emission-20dB
- “ pk”: peak mode
- “av”: average mode
- “---“: No meter reading data due to the emission level is smaller than spectrum noise level.
- The Spectrum noise level+Correction Factor < Limit - 6 dB
- Margin=Corrected Amplitude – Limit
- Corrected Amplitude=Radiated Amplitude+Antenna Correction Factor+Cable Loss-Pre-Amplifier Gain
- A margin of -8dB means that the emission is 8dB below the limit.

All frequencies from 1GHz to 25 GHz have been tested.

1GHz~ 25 GHz (Horizontal) , Channel 6 : 2437 MHz

Operator: Jerry Chiou

RBW: 1MHz
 Humidity (%): 36
 Temperature (C): 24

Frequency MHz	Rx_R. dBuV	Ant_F. dB/m	Cab_L. dB	PreAmpl dB	Emission dBuV/m	Limit dBuV/m	Margin dB	A.Tower cm	T.Table deg
1661.84	45.05	28.16	2.35	23.75	51.81	54.00	-2.19	101	66
7295.2	33.66	38.38	3.88	26.57	49.35	54.00	-4.65	101	152

1GHz~ 25 GHz (Vertical), Channel 6 : 2437 MHz

Operator: Jerry Chiou

RBW: 1MHz
 Humidity (%): 36
 Temperature (C): 24

Frequency MHz	Rx_R. dBuV	Ant_F. dB/m	Cab_L. dB	PreAmpl dB	Emission dBuV/m	Limit dBuV/m	Margin dB	A.Tower cm	T.Table deg
1329.67	47.54	26.02	2.21	23.88	51.89	54.00	-2.11	101	89
1659.34	42.09	28.14	2.35	23.75	48.82	54.00	-5.18	101	67
2486.01	41.86	30.90	1.44	24.80	49.40	54.00	-4.60	101	196
7295.2	36.15	38.38	3.88	26.57	51.84	54.00	-2.16	101	152

Note:

- According to the standards used, Where limits are specified by agencies for both average and peak (or quasi-peak) detection , if the peak (or quasi-peak) measured value complies with the average limit , it is unnecessary to perform an average measurement.
- “ * ”: Fundamental Frequency
- “***”: Not in the restricted band, Limit level=Fundamental Emission-20dB
- “ pk”: peak mode
- “av”: average mode
- “---“: No meter reading data due to the emission level is smaller than spectrum noise level.
- The Spectrum noise level+Correction Factor < Limit - 6 dB
- Margin=Corrected Amplitude – Limit
- Corrected Amplitude=Radiated Amplitude+Antenna Correction Factor+Cable Loss-Pre-Amplifier Gain
- A margin of -8dB means that the emission is 8dB below the limit.

All frequencies from 1GHz to 25 GHz have been tested.

1GHz~ 25 GHz (Horizontal), Channel 11: 2462 MHz

Operator: Jerry Chiou

RBW: 1MHz

Humidity (%): 36

Temperature (C): 24

Frequency MHz	Rx_R. dBuV	Ant_F. dB/m	Cab_L. dB	PreAmpl dB	Emission dBuV/m	Limit dBuV/m	Margin dB	A.Tower cm	T.Table deg
1659.34	41.81	28.14	2.35	23.75	48.55	54.00	-5.45	101	67
7367.63	35.14	38.67	3.92	26.54	51.19	54.00	-2.81	101	163

1GHz~ 25 GHz (Vertical), Channel 11 : 2462 MHz

Operator: Jerry Chiou

RBW: 1MHz

Humidity (%): 36

Temperature (C): 24

Frequency MHz	Rx_R. dBuV	Ant_F. dB/m	Cab_L. dB	PreAmpl dB	Emission dBuV/m	Limit dBuV/m	Margin dB	A.Tower cm	T.Table deg
1664.34	44.91	28.18	2.35	23.75	51.70	54.00	-2.30	101	661
4919.58	35.88	34.49	5.13	27.35	48.15	54.00	-5.85	100	8
7382.12	37.72	38.73	3.93	26.53	53.85	54.00	-0.15	101	165

Note:

- According to the standards used, Where limits are specified by agencies for both average and peak (or quasi-peak) detection , if the peak (or quasi-peak) measured value complies with the average limit , it is unnecessary to perform an average measurement.
- “ * ”: Fundamental Frequency
- “***”: Not in the restricted band, Limit level=Fundamental Emission-20dB
- “ pk”: peak mode
- “av”: average mode
- “---“: No meter reading data due to the emission level is smaller than spectrum noise level.
- The Spectrum noise level+Correction Factor < Limit - 6 dB
- Margin=Corrected Amplitude - Limit
- Corrected Amplitude=Radiated Amplitude+Antenna Correction Factor+Cable Loss-Pre-Amplifier Gain
- A margin of -8dB means that the emission is 8dB below the limit.

All frequencies from 1GHz to 25 GHz have been tested.

5.5 Band Edge Measurement

5.5.1 Test Procedure (Conducted)

1. The transmitter output of EUT was connected to the spectrum analyzer.
Equipment mode: Spectrum analyzer
Detector function: Peak mode
SPAN: 100MHz
RBW: 100KHz
VBW: 100KHz
Center frequency: 2.4GHz, 2.4835GHz.
2. Using Peak Search to read the peak power of Carrier frequencies after Maximum Hold function is completed
3. Find the next peak frequency outside the operation frequency band

5.5.2 Test Setup (Conducted)



5.5.3 Test Data:

Please refer to Elliott Laboratories, Inc. Report Number: R60260
FCC ID: PPD-AR5BXB6

5.5.4 Test Procedure (Radiated)

1. Antenna and Turntable test procedure same as Radiated Emission Measurement.
Equipment mode: Spectrum analyzer
Detector function: Peak mode
SPAN: 100MHz
RBW: 1MHz
VBW: 3MHz
Center frequency: 2.395GHz, 2.48GHz.
2. Using Peak Search to read the peak power of Carrier frequencies after Maximum Hold function is completed.
3. Find the next peak frequency outside the operation frequency band
4. For peak frequency emission level measurement in Restricted Band
Change RBW: 1MHz
VBW: 10Hz
Span: 100MHz.
5. Get the spectrum reading after Maximum Hold function is completed.

5.5.5 Test Setup (Radiated)

Same as *Radiated Emission Measurement*

5.5.6 Test Data

Table Band Edge measurement (Radiated)

802.11a

Temp. (deg. C): 25

Test Engr: Jerry Chiou

Humidity (%): 50

Description	Frequency (MHz)	Spectrum Reading (dBuV)	Correction Factor (dB/m)	Emission Level (dBuV/m)	dBc (Limit: > 20dBc)	Limit (dBuV/m)	Equip. Setup VBW	Pass or Fail
Channel_149 (peak mode)	5738.6	66.93	39.41	106.34	---	---	3MHz	---
Outside band (peak mode)	5724.8	36.23	39.41	75.64	30.7	---	3MHz	Pass
Channel_165 (peak mode)	5818.8	69.77	39.42	109.19	---	---	3MHz	---
Outside band (peak mode)	5850.2	35.21	39.45	74.66	34.53	---	3MHz	Pass
Turbo Channel_152 (peak mode)	5770.2	63.23	39.41	102.64	---	---	3MHz	---
Outside band (peak mode)	5725	32.1	39.41	71.51	31.13	---	3MHz	Pass
Turbo Channel_161 (peak mode)	5808.8	62.05	39.42	101.47	---	---	3MHz	---
Outside band (peak mode)	5850	31.76	39.45	71.21	30.26	---	3MHz	Pass

Normal Mode (Channel 149) Peak data

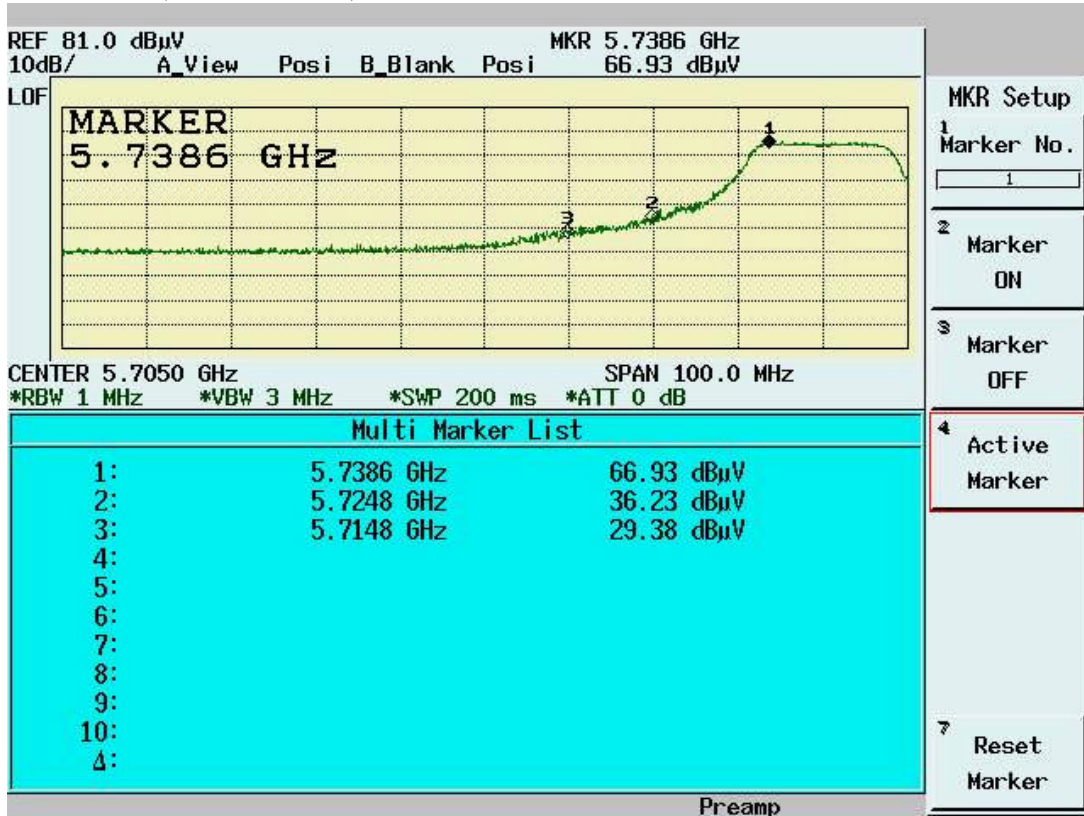

Normal Mode (Channel 165) Peak data

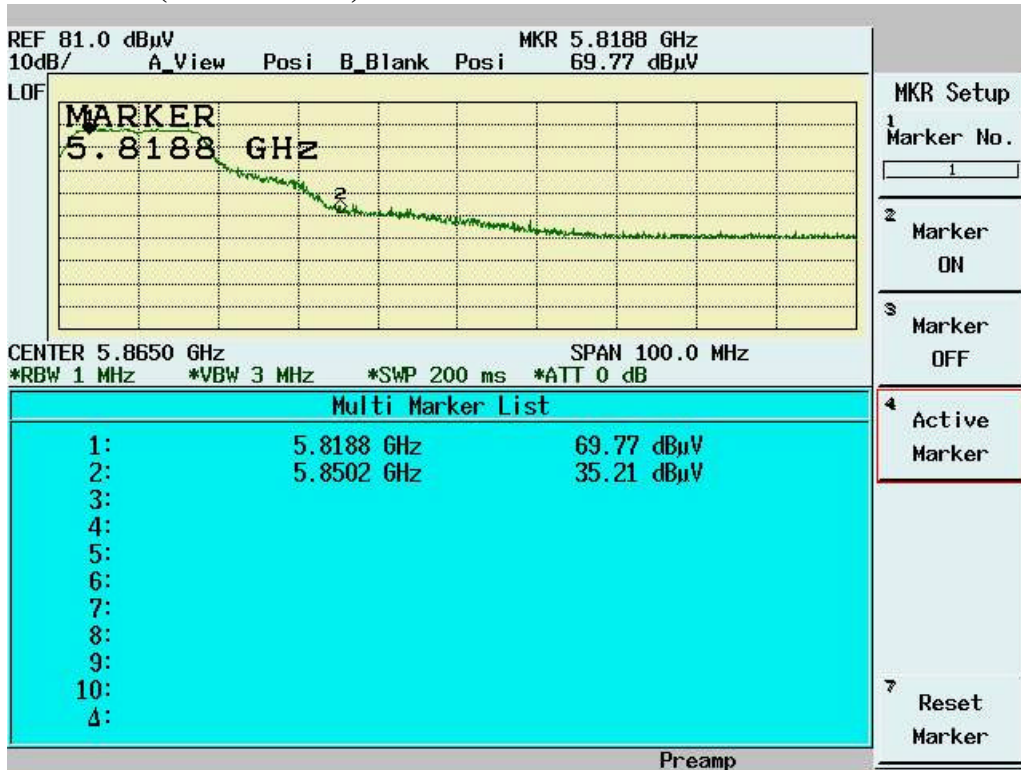

Turbo Mode (Channel 152) Peak data

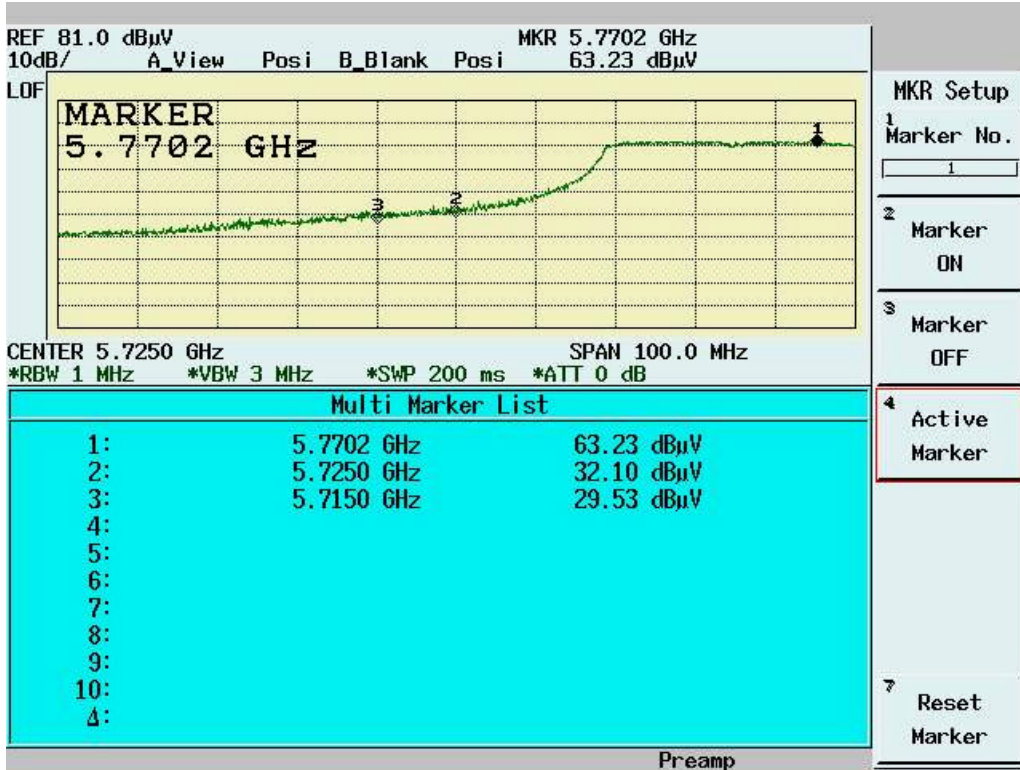

Turbo Mode (Channel 161) Peak data

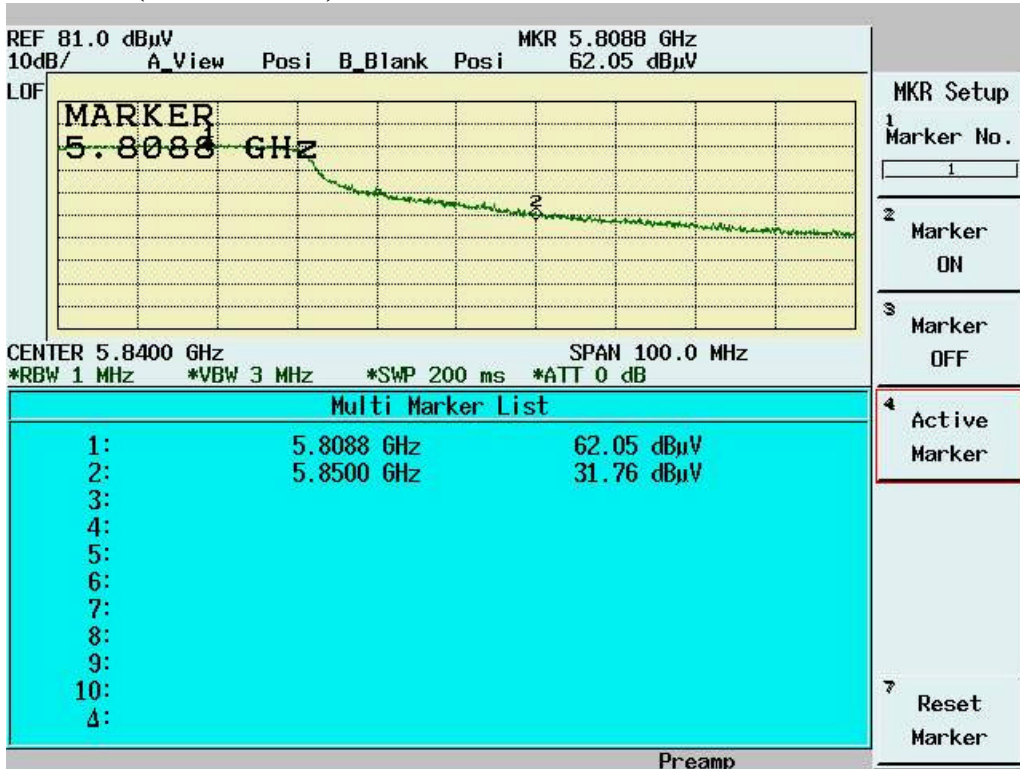

Table Band Edge measurement (Radiated)

802.11b

Temp. (deg. C):

25

Test Engr: Jerry Chiou Humidity (%):

50

Description	Frequency (MHz)	Spectrum Reading (dBuV)	Correction Factor (dB/m)	Emission Level (dBuV/m)	dBc (Limit: > 20dBc)	Limit (dBuV/m)	Equip. Setup VBW	Pass or Fail
Channel_1 (average mode)	2413.7	61.97	35.48	97.45	---	---	10Hz	---
Channel_1 (peak mode)	2412.8	66.22	35.48	101.7	---	---	3MHz	---
Outside band (peak mode)	2397.2	30.78	35.48	66.26	35.44	---	3MHz	Pass
Channel_11 (average mode)	2463.1	64.05	35.5	99.55	---	---	10Hz	---
Channel_11 (peak mode)	2462.8	68.52	35.5	104.02	---	---	3MHz	---
Outside band (peak mode)	2483.8	17.62	35.51	53.13	50.89	---	3MHz	Pass
Channel_1 Restricted band (peak mode)	2389.6	17.72	35.47	53.19	---	74	3MHz	Pass
Restricted band (average mode)	2389.7	7.03	35.47	42.5	---	54	10Hz	Pass
Channel_11 Restricted band (peak mode)	2483.8	17.62	35.51	53.13	---	74	3MHz	Pass
Restricted band (average mode)	2488.1	8.59	35.51	44.1	---	54	10Hz	Pass

Note:

- The Spectrum plot of emission level measurement in Restricted band is attached.
- Emission Level=Spectrum Reading+Correction Factor
- Correction Factor=Antenna Factor+cable loss–amplifier gain
- Both Horizontal and Vertical polarizaion have been tested and the worst data is listed above.

Band Edge measurement for radiated emission in Restricted Band(Radiated) Peak Mode (Channel 1)

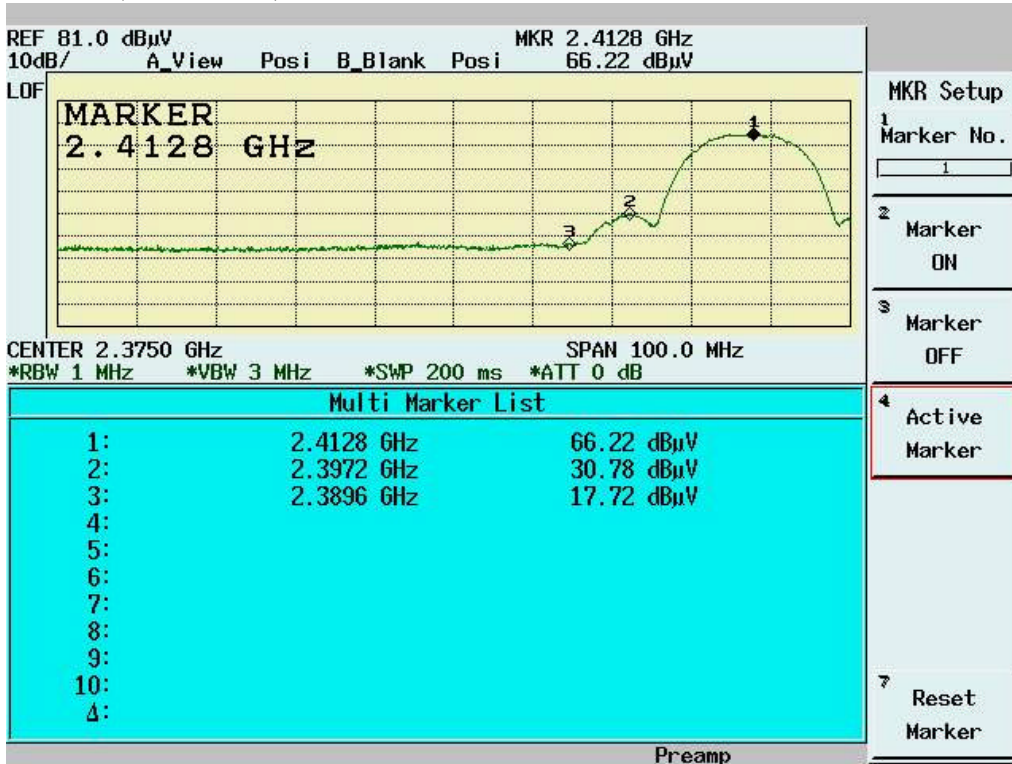

Band Edge measurement for radiated emission in Restricted Band(Radiated) Average Mode (Channel 1)

