



SAR Report

Applicant : ASUSTeK COMPUTER INC.
Applicant Address : 1F., No. 15, Lide Rd., Beitou Dist., Taipei City 112, Taiwan
Product Type : 2x2 802.11A/B/G/N/AC WiFi + Bluetooth Module
Trade Name : Qualcomm Atheros
Model Number : QCNFA324
Applicable Standard : 47 CFR Part §2.1093
Received Date : Dec. 14, 2020
Test Period : Dec. 24, 2020 ~ Feb. 04, 2021
Issued Date : Mar. 02, 2021

Issued by

Approved By : Kris Pan
(Kris Pan)

A Test Lab Techno Corp.
No. 140-1, Changan Street, Bade District,
Taoyuan City 33465, Taiwan (R.O.C.)
Tel : +886-3-2710188 / Fax : +886-3-2710190



Taiwan Accreditation Foundation accreditation number: 1330
Test Firm MRA designation number: TW0010

Note:

- 1.The test results are valid only for samples provided by customers and under the test conditions described in this report.
- 2.This report shall not be reproduced except in full, without the written approval of A Test Lab Technology Corporation.
- 3.The relevant information is provided by customers in this test report. According to the correctness, appropriateness or completeness of the information provided by the customer, if there is any doubt or error in the information which affects the validity of the test results, the laboratory does not take the responsibility.



Revision History

Rev.	Issued Date	Revisions	Revised By
00	Jan. 11, 2021	Initial Issue	Nicole Chu
01	Jan. 29, 2021	Revisde 7.3 chapter (P25) Revisde 7.4 chapter (P26) Revisde 7.6.2 chapter (P30~31)	Snow Wang
02	Mar. 02, 2021	Revisde 2 chapter (P5) Revisde 6.2 chapter (P15) Revisde 7.3 chapter (P22~P26) Revisde 7.4 chapter (P27) Revisde 7.5 chapter (P28) Revisde 7.6.1 chapter (P29) Revisde 7.6.2 chapter (P30) Revisde 8.2 chapter (P32) Revisde 12.1 chapter (P40~P45) Revisde 12.2 chapter (P46) Revisde Appendix A(P49~P54) Revisde Appendix B(P55~P63)	Snow Wang



Contents

1. General Information	4
1.1 Reference Applicable Standard	4
1.2 Test Site Environment	4
2. Summary of Maximum Reported SAR Value	5
3. Description of Equipment under Test (EUT)	6
4. Introduction.....	9
4.1 SAR Definition	9
5. SAR Measurement Setup	10
5.1 DASY E-Field Probe System.....	11
5.1.1 E-Field Probe Specification	11
5.2 Data Acquisition Electronic (DAE) System.....	12
5.3 Robot.....	12
5.4 Device Holder.....	13
5.5 Oval Flat Phantom - ELI.....	13
6. Tissue Simulating Liquids.....	14
6.1 The composition of the tissue simulating liquid.....	15
6.2 Liquid Parameters	15
6.3 Liquid Depth	19
7. SAR Testing with RF Transmitters	20
7.1 Positioning of the DUT in relation to the phantom.....	20
7.2 SAR Testing with WLAN.....	21
7.3 Conducted Power Measurements.....	22
7.4 Antenna location.....	28
7.5 Standalone SAR Test Exclusion Calculation	29
7.6 Simultaneous Transmitting Evaluate.....	30
7.6.1 Sum of 1-g SAR of all simultaneously transmitting	30
7.6.2 SAR to peak location separation ratio (SPLSR).....	31
8. System Verification and Validation	32
8.1 Symmetric Dipoles for System Verification	32
8.2 Verification Summary	33
9. Test Equipment List.....	34
10. Measurement Uncertainty	35
11. Measurement Procedure.....	37
11.1 Spatial Peak SAR Evaluation	37
11.2 Area & Zoom Scan Procedures	38
11.3 Volume Scan Procedures.....	39
11.4 Power Drift Monitoring.....	39
12. SAR Test Results Summary	40
12.1 Body SAR Measurement.....	41
12.2 SAR Variability Measurement.....	47
12.3 SAR Exposure Limit	48
13. References	49
Appendix A - System Performance Check	50
Appendix B - SAR Measurement Data	56
Appendix C - Calibration.....	65



1. General Information

1.1 Reference Applicable Standard

Standard	Description	Version
IEEE 1528	IEEE Recommended Practice for Determining the Peak Spatial-Average Specific Absorption Rate (SAR) in the Human Head From Wireless Communications Devices: Measurement Techniques.	2013
ANSI/IEEE C95.1	American National Standard safety levels with respect to human exposure to radio frequency electromagnetic fields, 300 KHz to 100 GHz, New York.	1992
47 CFR Part §2.1093	Radiofrequency radiation exposure evaluation: portable devices.	---
KDB 248227 D01	SAR guidance for IEEE 802.11 (Wi-Fi) transmitters	v02r02
KDB 447498 D01	RF exposure procedures and equipment authorization policies for mobile and portable devices	v06
KDB 616217 D04	SAR evaluation considerations for laptop, notebook and tablet computers.	v01r02
KDB 865664 D01	SAR measurement requirement for 100 MHz to 6 GHz.	v01r04
KDB 865664 D02	RF exposure compliance reporting and documentation considerations.	v01r02

1.2 Test Site Environment

Items	Required (IEEE 1528-2013)	Actual
Temperature (°C)	18-25	21-23



2. Summary of Maximum Reported SAR Value

Equipment Class	Mode	Highest Reported 1g SAR (W/kg)	
		Body standalone SAR _{1g} (W/kg)	Body standalone SAR _{1g} (W/kg)
		Tablet/SKU 1	Notebook/SKU 2
DTS	WLAN2.4GHz Ant Main	0.87	0.87
	WLAN2.4GHz Ant Aux	0.70	0.70
U-NII	WLAN5GHz Ant Main	0.99	0.99
	WLAN5GHz Ant Aux	1.11	1.11
DSS	Bluetooth Ant Aux	0.26	0.26
Highest Simultaneous Transmission 1g SAR (W/kg)		1.25	1.25

Note:

1. The SAR limit (Head & Body: SAR_{1g} 1.6 W/kg) for general population / uncontrolled exposure is specified in FCC 47 CFR part 2 (2.1093) and ANSI/IEEE C95.1-1992.
2. The test procedures, as described in American National Standards, Institute ANSI/IEEE C95.1 ANSI/IEEE C95.3 (For IC) were employed and they specify the maximum exposure limit (SAR_{1g} 1.6 W/kg for Head & Body, SAR_{10g} 4.0 W/kg for Extremity) of tissue for portable devices being used within 20 cm between user and EUT in the uncontrolled environment. A description of the product and operating configuration, detailed summary of the test results, methodology and procedures used in the equipment used are included within this test report.
3. This device has two kinds of SKU, SKU 1 is 360 convertible laptop computer,SKU 2 is laptop only. All circuit designs, circuit board and other related designs are electrically identical.



3. Description of Equipment under Test (EUT)

Applicant	ASUSTeK COMPUTER INC. 1F., No. 15, Lide Rd., Beitou Dist., Taipei City 112, Taiwan	
Manufacturer	ASUSTeK COMPUTER INC. 1F., No. 15, Lide Rd., Beitou Dist., Taipei City 112, Taiwan	
Product Type	2x2 802.11A/B/G/N/AC WiFi + Bluetooth Module	
Trade Name	Qualcomm Atheros	
Model Number	QCNFA324	
FCC ID	PPD-QCNFA324	
Class II Permissive Change	<p>(1) This is to request a Class II permissive change for FCC ID: PPD-QCNFA324 , originally granted on 2014/11/21</p> <p>Modification:</p> <p>-Change #1: Additional chassis added, ASUSTeK, model number: CZ1100FV, CZ1100CV Models differences: All models are electrically identical, different model names are for marketing purpose and the flip angle of panel, as below. CZ1100FV is for 360 degree ; CZ1100CV is for 180 degree</p> <p>-Change #2: Reduces WIFI output power through BIOS that cannot be changed by end user and SAR were evaluated accordingly.</p> <p>-Change #3: Adds new antennas that meet FCC Part 15 equivalent-type</p>	
Host Information	<p>Product Type: Chromebook Trade Name: ASUS Model Name: CZ1100FV, CZ1100CV All models are electrically identical, different model names are for marketing purpose and the flip angle of panel, as below. CZ1100FV is for 360 degree ; CZ1100CV is for 180 degree</p>	
Frequency Range	Operate Modes	Operate Frequency (MHz)
	IEEE 802.11b / 802.11g	2412 - 2472
	IEEE 802.11n 2.4 GHz 20 MHz	2412 - 2472
	IEEE 802.11n 2.4 GHz 40 MHz	2422 - 2462
	IEEE 802.11a U-NII Band I	5180 - 5240
	IEEE 802.11a U-NII Band II-A	5260 - 5320
	IEEE 802.11a U-NII Band II-C	5500 - 5720
	IEEE 802.11a U-NII Band III	5745 - 5825



Frequency Range	IEEE 802.11n / IEEE 802.11ac 5 GHz 20 MHz U-NII Band I	5180 - 5240
	IEEE 802.11n / IEEE 802.11ac 5 GHz 20 MHz U-NII Band II-A	5260 - 5320
	IEEE 802.11n / IEEE 802.11ac 5 GHz 20 MHz U-NII Band II-C	5500 - 5720
	IEEE 802.11n / IEEE 802.11ac 5 GHz 20 MHz U-NII Band III	5745 - 5825
	IEEE 802.11n / IEEE 802.11ac 5 GHz 40 MHz U-NII Band I	5190 - 5230
	IEEE 802.11n / IEEE 802.11ac 5 GHz 40 MHz U-NII Band II-A	5270 - 5310
	IEEE 802.11n / IEEE 802.11ac 5 GHz 40 MHz U-NII Band II-C	5510 - 5710
	IEEE 802.11n / IEEE 802.11ac 5 GHz 40 MHz U-NII Band III	5755 - 5795
	IEEE 802.11ac 80 MHz U-NII Band I	5210
	IEEE 802.11ac 80 MHz U-NII Band II-A	5290
	IEEE 802.11ac 80 MHz U-NII Band II-C	5530 - 5690
	IEEE 802.11ac 80 MHz U-NII Band III	5775
	Bluetooth BR/EDR	2402 - 2480
	Bluetooth LE	2402 - 2480
	*The 5600 – 5650 MHz cannot be used in Canada.	
Modulations	802.11b : CCK, DQPSK, DBPSK for DSSS 802.11a/g/n/ac : 64QAM, 16QAM, QPSK, BPSK for OFDM Bluetooth : GFSK, T/4-DQPSK, 8-DPSK for FHSS	
Device Category	Portable Device	
Application Type	Certification	

Note:

1. The above EUT's information was declared by manufacturer. Please refer to the specifications or user's manual for more detailed description.



Antenna list :

Antenna Source	ANT	Manufacturer	Part No. (Vendor)	Type	Max. Gain (dBi)	
					Frequency	NB/ PAD
1	Chain A	South-star	N12-7252-ROA	PIFA Antenna	2402 - 2480	-1.36
					5150 - 5250	-1.47
					5250 - 5350	-2.52
					5470 - 5725	-2.18
					5725 - 5850	-2.13
	Chain B	South-star	N12-7251-ROA	PIFA Antenna	2402 - 2480	-0.13
					5150 - 5250	-1.74
					5250 - 5350	-0.90
					5470 - 5725	-0.29
					5725 - 5850	-0.05
2	Chain A	AWAN	AYF6Y-100041	PIFA Antenna	2402 - 2480	-3.06
					5150 - 5250	-1.66
					5250 - 5350	-2.53
					5470 - 5725	-3.19
					5725 - 5850	-2.33
	Chain B	AWAN	AYF6Y-100040	PIFA Antenna	2402 - 2480	-3.68
					5150 - 5250	-1.92
					5250 - 5350	-1.53
					5470 - 5725	-1.37
					5725 - 5850	-1.38

Note :

1. Antenna Source 1 (South-star) gain is worst case. We tested and recorded it in this report.
2. Antenna Source 1 (South-star) and Antenna Source 2 (AWAN) are the same type of antenna, only different in manufacturer.
3. The Chain A is connected to AUX port / Chain B is connected to Main port of module.

4. Introduction

The A Test Lab Techno Corp. has performed measurements of the maximum potential exposure to the user. The test procedures, as described in American National Standards, Institute C95.1-1999 [1] were employed and they specify the maximum exposure limit of 1.6 W/kg as averaged over any 1 gram of tissue for portable devices being used within 20 cm between user and EUT in the uncontrolled environment. A description of the product and operating configuration, detailed summary of the test results, methodology and procedures used in the equipment used are included within this test report.

4.1 SAR Definition

Specific Absorption Rate (SAR) is defined as the time derivative (rate) of the incremental energy (dw) absorbed by (dissipated in) an incremental mass (dm) contained in a volume element (dv) of a given density (ρ). The equation description is as below :

$$\text{SAR} = \frac{d}{dt} \left(\frac{dw}{dm} \right) = \frac{d}{dt} \left(\frac{dw}{\rho dv} \right)$$

SAR is expressed in units of Watts per kilogram (W/kg)

SAR measurement can be related to the electrical field in the tissue by

$$\text{SAR} = \frac{\sigma |E|^2}{\rho}$$

Where :

σ = conductivity of the tissue (S/m)

ρ = mass density of the tissue (kg/m³)

E = RMS electric field strength (V/m)

5. SAR Measurement Setup

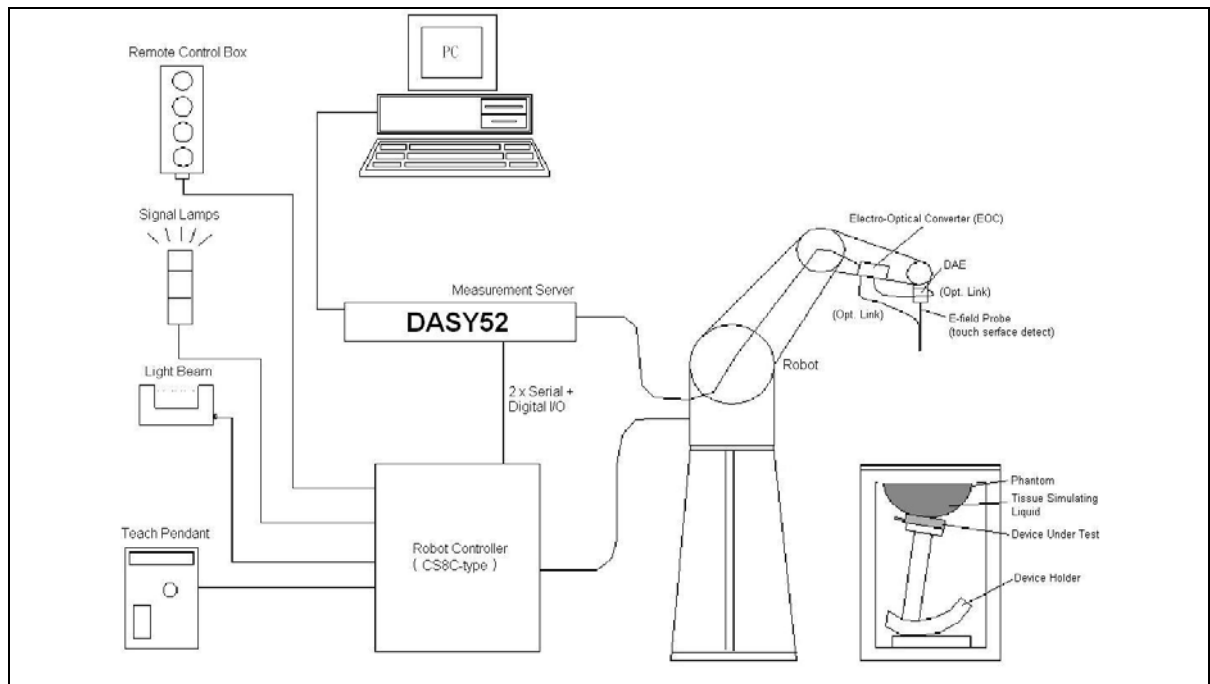



The DASY52 system for performing compliance tests consists of the following items:

1. A standard high precision 6-axis robot (Stäubli TX family) with controller, teach pendant and software. An arm extension for accommodating the data acquisition electronics (DAE).
2. An isotropic field probe optimized and calibrated for the targeted measurements.
3. A data acquisition electronics (DAE) which performs the signal amplification, signal multiplexing, AD-conversion, offset measurements, mechanical surface detection, collision detection, etc. The unit is battery powered with standard or rechargeable batteries. The signal is optically transmitted to the EOC.
4. The Electro-optical converter (EOC) performs the conversion from optical to electrical signals for the digital communication to the DAE. To use optical surface detection, a special version of the EOC is required. The EOC signal is transmitted to the measurement server.
5. The function of the measurement server is to perform the time critical tasks such as signal filtering, control of the robot operation and fast movement interrupts.
6. The Light Beam used is for probe alignment. This improves the (absolute) accuracy of the probe positioning.
7. A computer running Win7/Win8 professional operating system and the cDASY6 and DASY5 V5.2 software.
8. Remote controls with teach pendant and additional circuitry for robot safety such as warning lamps, etc.
9. The phantom, the device holder and other accessories according to the targeted measurement.
10. Tissue simulating liquid mixed according to the given recipes.
11. The validation dipole has been calibrated within and the system performance check has been successful.

5.1 DASY E-Field Probe System

The SAR measurements were conducted with the dosimetric probe (manufactured by SPEAG), designed in the classical triangular configuration [3] and optimized for dosimetric evaluation. The probe is constructed using the thick film technique; with printed resistive lines on ceramic substrates. The probe is equipped with an optical multi-fiber line ending at the front of the probe tip. It is connected to the EOC box on the robot arm and provides an automatic detection of the phantom surface. Half of the fibers are connected to a pulsed infrared transmitter, the other half to a synchronized receiver. As the probe approaches the surface, the reflection from the surface produces a coupling from the transmitting to the receiving fibers. This reflection increases first during the approach, reaches maximum and then decreases. If the probe is flatly touching the surface, the coupling is zero. The distance of the coupling maximum to the surface is independent of the surface reflectivity and largely independent of the surface to probe angle. The DASY software reads the reflection during a software approach and looks for the maximum using a 2nd order fitting. The approach is stopped when reaching the maximum.

5.1.1 E-Field Probe Specification

Construction	Symmetrical design with triangular core Built-in shielding against static charges PEEK enclosure material (resistant to organic solvents, e.g., DGBE)
Frequency	10 MHz to > 6 GHz Linearity: ± 0.2 dB (30 MHz to 6 GHz)
Directivity	± 0.3 dB in brain tissue (rotation around probe axis) ± 0.5 dB in brain tissue (rotation normal probe axis)
Dimensions	Overall length: 337 mm (Tip: 20 mm) Tip diameter: 2.5 mm (Body: 12 mm) Typical distance from probe tip to dipole centers: 1 mm
Calibration	ISO/IEC 17025 calibration service available
<div style="display: flex; justify-content: space-around;"> <div style="text-align: center;">  <p>EX3DV4 E-Field Probe</p> </div> <div style="text-align: center;">  <p>Probe setup on robot</p> </div> </div>	

5.2 Data Acquisition Electronic (DAE) System

Model	DAE4	
Construction	Signal amplifier, multiplexer, A/D converter and control logic. Serial optical link for communication with DASY embedded system (fully remote controlled). Two step probe touch detector for mechanical surface detection and emergency robot stop.	
Measurement Range	-100 to +300 mV (16 bit resolution and two range settings: 4 mV, 400 mV)	
Input Offset Voltage	< 5 μ V (with auto zero)	
Input Bias Current	< 50 fA	
Dimensions	60 x 60 x 68 mm	

5.3 Robot

Positioner	Stäubli Unimation Corp.	
Robot Model	TX90XL	
Number of Axes	6	
Norminal Load	5 kg	
Reach	1450 mm	
Repeatability	\pm 0.035 mm	

5.4 Device Holder

The DASY device holder is constructed of low-loss POM material having the following dielectric parameters: relative permittivity $\epsilon=3$ and loss tangent $\delta=0.02$. The amount of dielectric material has been reduced in the closest vicinity of the device, since measurements have suggested that the influence of the clamp on the test results could thus be lowered.

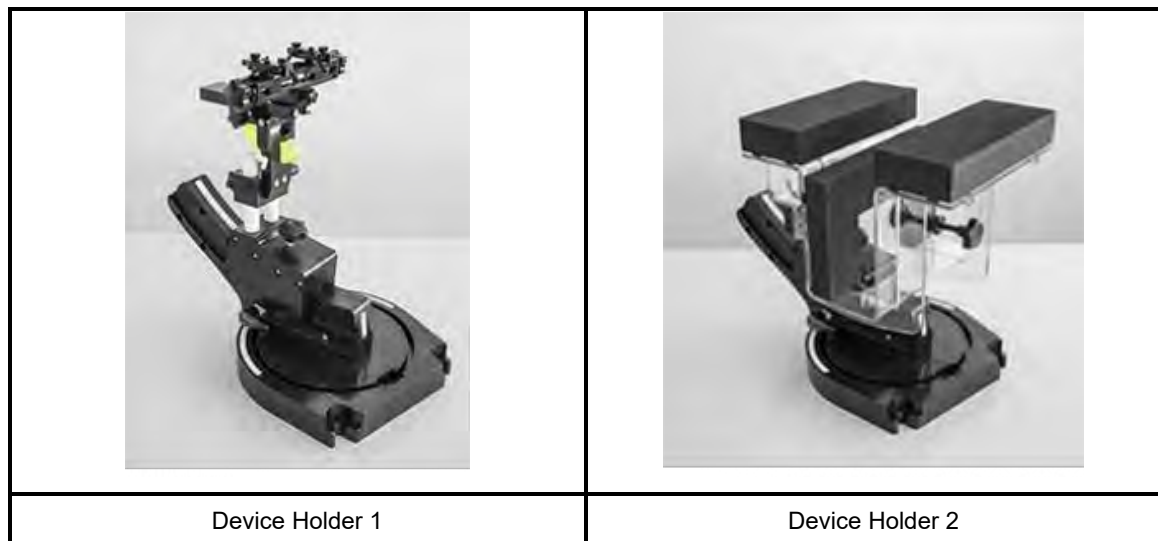

5.5 Oval Flat Phantom - ELI

The shell corresponds to the specifications of the Specific Anthropomorphic Mannequin (Oval Flat) phantom defined in IEEE 1528-2013, CENELEC 50361 and IEC 62209-2. It enables the dosimetric evaluation of wireless portable device usage as well as body mounted usage at the flat phantom region. A cover prevents evaporation of the liquid. Reference markings on the phantom allow the complete setup of all predefined phantom positions and measurement grids by manually teaching three points with the robot.

Shell Thickness	2 ±0.2 mm
Filling Volume	Approx. 30 liters
Dimensions	190×600×400 mm (H×L×W)
Table 1. Specification of ELI	



6. Tissue Simulating Liquids

IEEE SCC-34/SC-2 in 1528 recommended Tissue Dielectric Parameters

The head tissue dielectric parameters recommended by the IEEE SCC-34/SC-2 in 1528 have been incorporated in the following table. These head parameters are derived from planar layer models simulating the highest expected SAR for the dielectric properties and tissue thickness variations in human head. Other head and body tissue parameters that have not been specified in 1528 are derived from the tissue dielectric parameters computed from the 4-Cole-Cole equation and extrapolated according to the head parameter specified in 1528.

Target Frequency (MHz)	Head		Body	
	ϵ_r	σ (S/m)	ϵ_r	σ (S/m)
150	52.3	0.76	61.9	0.80
300	45.3	0.87	58.2	0.92
450	43.5	0.87	56.7	0.94
835	41.5	0.90	55.2	0.97
900	41.5	0.97	55.0	1.05
915	41.5	0.98	55.0	1.06
1450	40.5	1.20	54.0	1.30
1610	40.3	1.29	53.8	1.40
1800 - 2000	40.0	1.40	53.3	1.52
2450	39.2	1.80	52.7	1.95
3000	38.5	2.40	52.0	2.73
5800	35.3	5.27	48.2	6.00
(ϵ_r = relative permittivity, σ = conductivity and $\rho = 1000 \text{ kg/m}^3$)				

Table 2. Tissue dielectric parameters for head and body phantoms



6.1 The composition of the tissue simulating liquid

Ingredients (% by weight)	Frequency (MHz)												Frequency (GHz)	
	750		835		1750		1900		2450		2600		5 GHz	
Tissue Type	Head	Body	Head	Body	Head	Body	Head	Body	Head	Body	Head	Body	Head	Body
Water	39.28	51.30	41.45	52.40	54.50	40.20	54.90	40.40	62.70	73.20	60.30	71.40	65.5	78.6
Salt (NaCl)	1.47	1.42	1.45	1.50	0.17	0.49	0.18	0.50	0.50	0.10	0.60	0.20	0.00	0.00
Sugar	58.15	46.18	56.00	45.00	0.00	0.00	0.00	0.00	0.00	0.00	0.00	0.00	0.00	0.00
HEC	1.00	1.00	1.00	1.00	0.00	0.00	0.00	0.00	0.00	0.00	0.00	0.00	0.00	0.00
Bactericide	0.10	0.10	0.10	0.10	0.00	0.00	0.00	0.00	0.00	0.00	0.00	0.00	0.00	0.00
Triton X-100	0.00	0.00	0.00	0.00	0.00	0.00	0.00	0.00	0.00	0.00	0.00	0.00	17.2	10.7
DGBE	0.00	0.00	0.00	0.00	45.33	59.31	44.92	59.10	36.80	26.70	39.10	28.40	0.00	0.00
Diethylene Glycol Mono-hexlether	0.00	0.00	0.00	0.00	0.00	0.00	0.00	0.00	0.00	0.00	0.00	0.00	17.3	10.7
Dielectric Constant	41.88	54.60	42.54	56.10	40.10	53.60	39.90	54.00	39.80	52.50	39.80	52.50	35.1~ 36.2	47.9~ 49.3
Conductivity (S/m)	0.90	0.97	0.91	0.95	1.39	1.49	1.42	1.45	1.88	1.78	1.88	1.78	4.45~ 5.48	5.07~ 6.23

6.2 Liquid Parameters

- The dielectric parameters of the liquids were verified prior to the SAR evaluation using an DAKS 3.5 Probe Kit.
- The SAR testing with IEC tissue parameters as an alternative option to Head and body parameters. We used head TSL for body SAR tests. There are some limitations though:
 - The mixing and matching of head TSL and body TSL for body SAR testing in a single application are not permitted. For example, we cannot start testing body SAR with head TSL and then switch to testing Body SAR with Body TSL.
 - The TSL used for body SAR testing can be changed via a Permissive Change. However, if the body SAR increases and the original Body SAR was > 1.2 W/kg, additional SAR measurements may be required.

Tissue Temp (°C)	Head / Body	Frequency	Cond.	Perm.	target Cond.	target Perm.	σ (Delta)(%)	ϵ_r (Delta)(%)	Limit (%)	Date
			σ	ϵ_r	σ	ϵ_r				
22.2	Head	2412 MHz	1.77	39.857	1.77	39.27	0.43	1.49	±5	Dec. 24, 2020
22.2	Head	2422 MHz	1.79	39.820	1.78	39.25	0.59	1.45	±5	Dec. 24, 2020
22.2	Head	2437 MHz	1.80	39.782	1.79	39.22	0.84	1.43	±5	Dec. 24, 2020



Tissue Temp (°C)	Head / Body	Frequency	Cond.	Perm.	target Cond.	target Perm.	σ (Delta)(%)	ϵ_r (Delta)(%)	Limit (%)	Date
			σ	ϵ_r	σ	ϵ_r				
22.2	Head	2452 MHz	1.82	39.747	1.80	39.20	1.06	1.40	±5	Dec. 24, 2020
22.2	Head	2462 MHz	1.83	39.718	1.81	39.18	1.13	1.37	±5	Dec. 24, 2020
22.2	Head	2467 MHz	1.84	39.703	1.82	39.18	1.21	1.33	±5	Dec. 24, 2020
22.2	Head	2472 MHz	1.85	39.690	1.82	39.17	1.25	1.33	±5	Dec. 24, 2020
22.3	Head	5500 MHz	5.00	36.253	4.97	35.65	0.64	1.69	±5	Dec. 25, 2020
22.3	Head	5510 MHz	5.00	36.239	4.98	35.64	0.57	1.68	±5	Dec. 25, 2020
22.3	Head	5530 MHz	5.02	36.193	5.00	35.61	0.43	1.64	±5	Dec. 25, 2020
22.3	Head	5550 MHz	5.04	36.132	5.02	35.58	0.42	1.55	±5	Dec. 25, 2020
22.3	Head	5570 MHz	5.07	36.086	5.04	35.55	0.53	1.51	±5	Dec. 25, 2020
22.3	Head	5580 MHz	5.08	36.076	5.05	35.53	0.58	1.54	±5	Dec. 25, 2020
22.3	Head	5610 MHz	5.11	36.042	5.08	35.49	0.56	1.55	±5	Dec. 25, 2020
22.3	Head	5620 MHz	5.12	36.028	5.09	35.48	0.51	1.54	±5	Dec. 25, 2020
22.3	Head	5630 MHz	5.12	36.006	5.10	35.47	0.46	1.51	±5	Dec. 25, 2020
22.3	Head	5660 MHz	5.15	35.928	5.13	35.44	0.47	1.38	±5	Dec. 25, 2020
22.3	Head	5670 MHz	5.17	35.906	5.14	35.43	0.51	1.34	±5	Dec. 25, 2020
22.3	Head	5690 MHz	5.19	35.870	5.16	35.41	0.56	1.30	±5	Dec. 25, 2020
22.3	Head	5700 MHz	5.20	35.853	5.17	35.40	0.55	1.28	±5	Dec. 25, 2020
22.3	Head	5710 MHz	5.21	35.836	5.18	35.39	0.53	1.26	±5	Dec. 25, 2020
22.3	Head	5720 MHz	5.22	35.818	5.19	35.38	0.50	1.24	±5	Dec. 25, 2020
22.5	Head	5500 MHz	5.00	36.123	4.97	35.65	0.63	1.33	±5	Dec. 26, 2020



Tissue Temp (°C)	Head / Body	Frequency	Cond.	Perm.	target Cond.	target Perm.	σ (Delta)(%)	ϵ_r (Delta)(%)	Limit (%)	Date
			σ	ϵ_r	σ	ϵ_r				
22.5	Head	5510 MHz	5.00	36.110	4.98	35.64	0.56	1.32	±5	Dec. 26, 2020
22.5	Head	5530 MHz	5.02	36.063	5.00	35.61	0.42	1.27	±5	Dec. 26, 2020
22.5	Head	5550 MHz	5.04	36.003	5.02	35.58	0.41	1.19	±5	Dec. 26, 2020
22.5	Head	5570 MHz	5.07	35.956	5.04	35.55	0.52	1.14	±5	Dec. 26, 2020
22.5	Head	5580 MHz	5.08	35.946	5.05	35.53	0.57	1.17	±5	Dec. 26, 2020
22.5	Head	5610 MHz	5.11	35.912	5.08	35.49	0.55	1.19	±5	Dec. 26, 2020
22.5	Head	5620 MHz	5.12	35.898	5.09	35.48	0.50	1.18	±5	Dec. 26, 2020
22.5	Head	5630 MHz	5.12	35.876	5.10	35.47	0.45	1.14	±5	Dec. 26, 2020
22.5	Head	5660 MHz	5.15	35.798	5.13	35.44	0.46	1.01	±5	Dec. 26, 2020
22.5	Head	5670 MHz	5.17	35.776	5.14	35.43	0.50	0.98	±5	Dec. 26, 2020
22.5	Head	5690 MHz	5.19	35.740	5.16	35.41	0.55	0.93	±5	Dec. 26, 2020
22.5	Head	5700 MHz	5.20	35.723	5.17	35.40	0.53	0.91	±5	Dec. 26, 2020
22.5	Head	5710 MHz	5.21	35.706	5.18	35.39	0.52	0.89	±5	Dec. 26, 2020
22.5	Head	5720 MHz	5.22	35.688	5.19	35.38	0.49	0.87	±5	Dec. 26, 2020
22.6	Head	2402 MHz	1.72	40.051	1.76	39.28	-1.98	1.96	±5	Feb. 02, 2021
22.6	Head	2441 MHz	1.79	39.749	1.79	39.22	-0.30	1.35	±5	Feb. 02, 2021
22.6	Head	2480 MHz	1.84	39.428	1.83	39.16	0.55	0.68	±5	Feb. 02, 2021
22.4	Head	5260 MHz	4.75	36.840	4.72	35.94	0.67	2.50	±5	Feb. 04, 2021
22.4	Head	5270 MHz	4.76	36.825	4.73	35.93	0.70	2.49	±5	Feb. 04, 2021
22.4	Head	5280 MHz	4.77	36.812	4.74	35.92	0.71	2.48	±5	Feb. 04, 2021



Tissue Temp (°C)	Head / Body	Frequency	Cond.	Perm.	target Cond.	target Perm.	σ (Delta)(%)	ϵ_r (Delta)(%)	Limit (%)	Date
			σ	ϵ_r	σ	ϵ_r				
22.4	Head	5290 MHz	4.78	36.798	4.75	35.91	0.68	2.47	±5	Feb. 04, 2021
22.4	Head	5300 MHz	4.79	36.779	4.76	35.90	0.63	2.45	±5	Feb. 04, 2021
22.4	Head	5310 MHz	4.80	36.757	4.77	35.89	0.57	2.42	±5	Feb. 04, 2021
22.4	Head	5320 MHz	4.81	36.732	4.78	35.88	0.54	2.37	±5	Feb. 04, 2021
22.4	Head	5745 MHz	5.24	35.908	5.22	35.36	0.46	1.55	±5	Feb. 04, 2021
22.4	Head	5755 MHz	5.25	35.885	5.23	35.35	0.44	1.51	±5	Feb. 04, 2021
22.4	Head	5775 MHz	5.27	35.844	5.25	35.33	0.47	1.45	±5	Feb. 04, 2021
22.4	Head	5785 MHz	5.28	35.829	5.26	35.32	0.50	1.44	±5	Feb. 04, 2021
22.4	Head	5795 MHz	5.29	35.815	5.27	35.31	0.52	1.43	±5	Feb. 04, 2021
22.4	Head	5825 MHz	5.32	35.779	5.30	35.28	0.44	1.41	±5	Feb. 04, 2021

6.3 Liquid Depth

According to KDB865664, the depth of tissue-equivalent liquid in a phantom must be ≥ 15.0 cm. Which is shown in Figure 7 & 8.

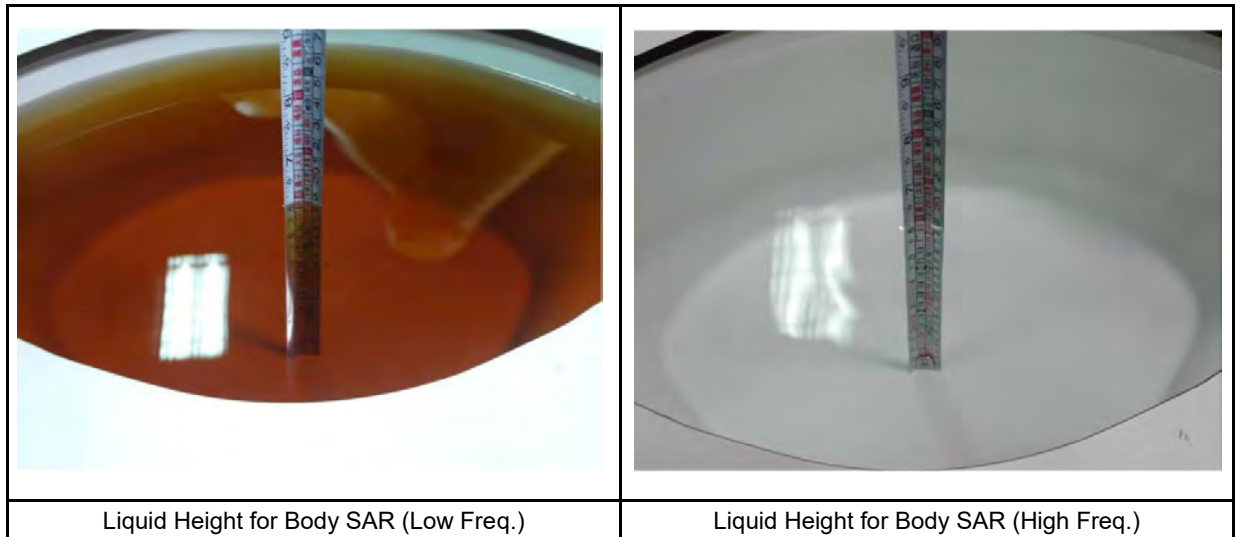

7. SAR Testing with RF Transmitters

7.1 Positioning of the DUT in relation to the phantom

The following measurement procedure shall be according to RSS-102 Supplementary procedures (SPR-001):
Unless the side(s)/edge(s) of the laptop type computer (laptop mode/tablet mode) containing the built-in antenna(s) was already tested against the flat phantom.

Industry Canada requires SAR measurements to be performed with the side(s)/edge(s) of the display screen containing the built-in antenna(s) pointing towards the flat phantom.

i) If the integrated antenna(s) are located in the back side of the display screen, the back side shall be facing towards the flat phantom at a distance not exceeding 25 mm.

ii) If the integrated antenna(s) are installed along the edge(s) of the display screen, the edge(s) shall be facing towards the flat phantom at a distance not exceeding 25 mm.

According to KDB616217 D04

iii) When antennas are incorporated in the keyboard section of a laptop computer, SAR is required for the bottom surface of the keyboard. Provided tablet use conditions are not supported by the laptop computer, SAR tests for bystander exposure from the edges of the keyboard.

iv) Some 2-in-1 tablets may operate with the display folded on top of the keyboard. Most recent tablets are designed with an interactive display that may not require a physical keyboard. Both configurations are used in similar manners and require SAR evaluation for the back surface and edges of the tablet. For keyboards that can be unfolded like a laptop, the procedures for laptop platform should also be applied.



7.2 SAR Testing with WLAN

SAR test reduction for 802.11 Wi-Fi transmission mode configurations are considered separately for DSSS and OFDM. An initial test position is determined to reduce the number of tests required for certain exposure configurations with multiple test positions. An initial test configuration is determined for each frequency band and aggregated band according to maximum output power, channel bandwidth, wireless mode configurations and other operating parameters to streamline the measurement requirements. For 2.4 GHz DSSS, either the initial test position or DSSS procedure is applied to reduce the number of SAR tests; these are mutually exclusive. For OFDM, an initial test position is only applicable to next to the ear, UMPC mini-tablet and hotspot mode configurations, which is tested using the initial test configuration to facilitate test reduction. For other exposure conditions with a fixed test position, SAR test reduction is determined using only the initial test configuration.

The multiple test positions require SAR measurements in head, hotspot mode or UMPC mini-tablet configurations may be reduced according to the highest reported SAR determined using the initial test position(s) by applying the DSSS or OFDM SAR measurement procedures in the required wireless mode test configuration(s). The initial test position(s) is measured using the highest measured maximum output power channel in the required wireless mode test configuration(s). When the reported SAR for the initial test position is:

- ≤ 0.4 W/kg, further SAR measurement is not required for the other test positions in that exposure configuration and wireless mode combination within the frequency band or aggregated band. DSSS and OFDM configurations are considered separately according to the required SAR procedures.
- > 0.4 W/kg, SAR is repeated using the same wireless mode test configuration tested in the initial test position to measure the subsequent next closet/smallest test separation distance and maximum coupling test position, on the highest maximum output power channel, until the reported SAR is ≤ 0.8 W/kg or all required test positions are tested.
 - For subsequent test positions with equivalent test separation distance or when exposure is dominated by coupling conditions, the position for maximum coupling condition should be tested.
 - When it is unclear, all equivalent conditions must be tested.
- For all positions/configurations tested using the initial test position and subsequent test positions, when the reported SAR is > 0.8 W/kg, measure the SAR for these positions/configurations on the subsequent next highest measured output power channel(s) until the reported SAR is ≤ 1.2 W/kg or all required test channels are considered.
 - The additional power measurements required for this step should be limited to those necessary for identifying subsequent highest output power channels to apply the test reduction.
- When the specified maximum output power is the same for both UNII 1 and UNII 2A, begin SAR measurements in UNII 2A with the channel with the highest measured output power. If the reported SAR for UNII 2A is ≤ 1.2 W/kg, SAR is not required for UNII 1; otherwise treat the remaining bands separately and test them independently for SAR.
- When the specified maximum output power is different between UNII 1 and UNII 2A, begin SAR with the band that has the higher specified maximum output. If the highest reported SAR for the band with the highest specified power is ≤ 1.2 W/kg, testing for the band with the lower specified output power is not required; otherwise test the remaining bands independently for SAR.

To determine the initial test position, Area Scans were performed to determine the position with the Maximum Value of SAR (measured). The position that produced the highest Maximum Value of SAR is considered the worst case position; thus used as the initial test position.

7.3 Conducted Power Measurements

Maximum Conducted Output Power Measurement:

The testing follows the Measurement Procedure of ANSI C63.10:2013 section 11.9.2.3.2 Method AVGPM.

The tests below are run with the EUT's transmitter set at high power in TX mode. The EUT is needed to force selection of output power level and channel number. While testing, EUT was set to transmit continuously. Remove the Subjective device's antenna and connect the RF output port to power sensor.

11.9.2.3.2 Method AVGPM-G

Method AVGPM-G is a measurement using a gated RF average power meter. Alternatively, measurements may be performed using a wideband gated RF power meter provided that the gate parameters are adjusted such that the power is measured only when the EUT is transmitting at its maximum power control level. Because the measurement is made only during the ON time of the transmitter, no duty cycle correction factor is required.

11.9.1.3 PKPM1 Peak power meter method

The maximum peak conducted output power may be measured using a broadband peak RF power meter. The power meter shall have a video bandwidth that is greater than or equal to the DTS bandwidth and shall use a fast-responding diode detector.

Test Setup:

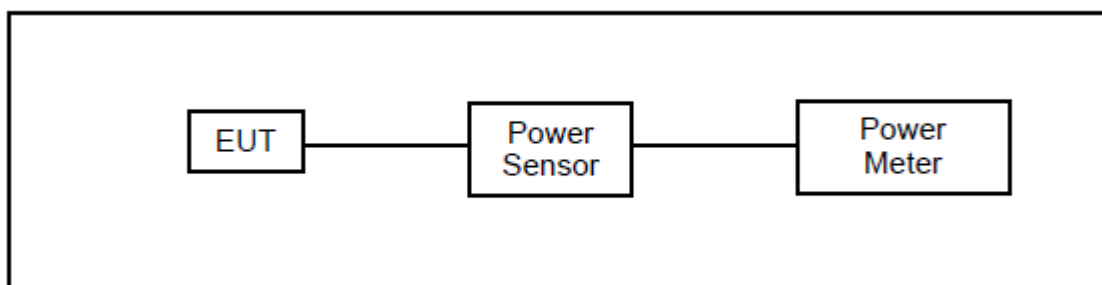



§15.247 (2.4 GHz)								
Mode	Channel	Frequency (MHz)	Main			Aux		
			Peak power (dBm)	Average power (dBm)	Tune-Up Limit	Peak power (dBm)	Average power (dBm)	Tune-Up Limit
802.11b 1Mbps	1	2412	15.34	12.77	13.00	15.39	12.82	13.00
	6	2437	15.46	12.83	13.00	15.49	12.91	13.00
	11	2462	15.31	12.84	13.00	15.12	12.50	13.00
802.11g 6Mbps	1	2412	19.28	12.69	13.00	19.08	12.61	13.00
	6	2437	19.33	12.86	13.00	19.12	12.54	13.00
	11	2462	19.38	12.87	13.00	19.19	12.67	13.00
802.11n-20 HTO	1	2412	19.59	12.86	13.00	19.16	12.46	13.00
	6	2437	19.48	12.85	13.00	19.26	12.72	13.00
	11	2462	19.32	12.55	13.00	19.37	12.80	13.00
802.11n-40 HTO	3	2422	19.38	12.03	12.50	19.12	12.19	12.50
	6	2437	19.98	12.87	13.00	19.81	12.80	13.00
	9	2452	17.56	9.86	10.00	17.66	9.81	10.00

1. As per FCC OET KDB 248227 D01, conducted output power and SAR testing are not required for 802.11g/n20/n40/ax channels when the highest reported SAR for DSSS is adjusted by the ratio of OFDM to DSSS specified maximum output power and the adjusted SAR is $\leq 1.2\text{W/kg}$.
2. When the reported SAR of the initial test configuration is $> 0.8\text{ W/kg}$, SAR measurement is required for subsequent next highest measured output power channel(s) in the initial test configuration until reported SAR is $\leq 1.2\text{ W/kg}$ or all required channels are tested.



U-NII-1						
Mode	Channel	Frequency (MHz)	Main		Aux	
			Average power (dBm)	Tune-Up Limit	Average power (dBm)	Tune-Up Limit
802.11a 6Mbps	36	5180	11.74	12.00	11.78	12.00
	40	5200	11.81	12.00	11.75	12.00
	44	5220	11.45	12.00	11.70	12.00
	48	5240	11.77	12.00	11.77	12.00
802.11n-20 HTO	36	5180	11.75	12.00	11.70	12.00
	40	5200	11.82	12.00	11.77	12.00
	44	5220	11.37	12.00	11.70	12.00
	48	5240	11.55	12.00	11.79	12.00
802.11n-40 HTO	38	5190	11.44	12.00	11.45	12.00
	46	5230	11.82	12.00	11.80	12.00
802.11ac-20 VHTO	36	5180	11.81	12.00	11.67	12.00
	40	5200	11.75	12.00	11.72	12.00
	44	5220	11.10	12.00	11.72	12.00
	48	5240	11.12	12.00	11.75	12.00
802.11ac-40 VHTO	38	5190	11.44	12.00	11.52	12.00
	46	5230	11.61	12.00	11.44	12.00
802.11ac-80 VHTO	42	5210	11.83	12.00	11.85	12.00

U-NII-2A						
Mode	Channel	Frequency (MHz)	Main		Aux	
			Average power (dBm)	Tune-Up Limit	Average power (dBm)	Tune-Up Limit
802.11a 6Mbps	52	5260	11.70	12.00	11.79	12.00
	56	5280	11.68	12.00	11.72	12.00
	60	5300	11.64	12.00	11.75	12.00
	64	5320	11.62	12.00	11.84	12.00
802.11n-20 HTO	52	5260	11.83	12.00	11.75	12.00
	56	5280	11.75	12.00	11.83	12.00
	60	5300	11.32	12.00	11.66	12.00
	64	5320	11.29	12.00	11.71	12.00
802.11n-40 HTO	54	5270	11.43	12.00	11.71	12.00
	62	5310	11.83	12.00	11.85	12.00
802.11ac-20 VHTO	52	5260	11.73	12.00	11.84	12.00
	56	5280	11.82	12.00	11.75	12.00
	60	5300	11.30	12.00	11.67	12.00
	64	5320	11.74	12.00	11.71	12.00
802.11ac-40 VHTO	54	5270	11.64	12.00	11.60	12.00
	62	5310	11.63	12.00	11.72	12.00
802.11ac-80 VHTO	58	5290	11.15	11.50	11.23	11.50



U-NII-2C						
Mode	Channel	Frequency (MHz)	Main		Aux	
			Average power (dBm)	Tune-Up Limit	Average power (dBm)	Tune-Up Limit
802.11a 6Mbps	100	5500	11.32	11.50	11.34	11.50
	116	5580	11.05	11.50	11.35	11.50
	124	5620	11.20	11.50	11.10	11.50
	132	5660	11.32	11.50	11.30	11.50
	140	5700	11.10	11.50	11.32	11.50
	144	5720	11.01	11.50	11.25	11.50
802.11n-20 HTO	100	5500	11.30	11.50	11.22	11.50
	116	5580	11.03	11.50	11.24	11.50
	124	5620	11.11	11.50	11.35	11.50
	132	5660	11.01	11.50	11.10	11.50
	140	5700	11.33	11.50	11.00	11.50
	144	5720	11.21	11.50	11.23	11.50
802.11n-40 HTO	102	5510	11.01	11.50	11.03	11.50
	110	5550	11.03	11.50	11.10	11.50
	126	5630	11.31	11.50	11.12	11.50
	134	5670	11.29	11.50	11.25	11.50
	142	5710	11.04	11.50	11.10	11.50
802.11ac-20 VHTO	100	5500	11.30	11.50	11.22	11.50
	116	5580	11.05	11.50	11.23	11.50
	124	5620	11.1	11.50	11.32	11.50
	132	5660	11.08	11.50	11.04	11.50
	140	5700	11.01	11.50	11.21	11.50
	144	5720	11.25	11.50	11.18	11.50
802.11ac-40 VHTO	102	5510	11.26	11.50	11.31	11.50
	110	5550	11.04	11.50	11.20	11.50
	126	5630	11.27	11.50	11.05	11.50
	134	5670	11.20	11.50	11.14	11.50
	142	5710	11.01	11.50	11.10	11.50
802.11ac-80 VHTO	106	5530	11.36	11.50	11.35	11.50
	122	5610	11.35	11.50	11.23	11.50
	138	5690	11.44	11.50	11.37	11.50



U-NII-3/§15.247 (5.8 GHz)						
Mode	Channel	Frequency (MHz)	Main		Aux	
			Average power (dBm)	Tune-Up Limit	Average power (dBm)	Tune-Up Limit
802.11a MCS0	149	5745	11.33	11.50	11.30	11.50
	157	5785	11.37	11.50	11.27	11.50
	165	5825	11.03	11.50	10.99	11.50
802.11n-20 HTO	149	5745	11.16	11.50	11.11	11.50
	157	5785	11.18	11.50	11.08	11.50
	165	5825	11.36	11.50	11.33	11.50
802.11n-40 HTO	151	5755	11.37	11.50	11.36	11.50
	159	5795	11.15	11.50	11.09	11.50
802.11ac-20 VHTO	149	5745	11.16	11.50	11.06	11.50
	157	5785	11.30	11.50	11.24	11.50
	165	5825	11.32	11.50	11.28	11.50
802.11ac-40 VHTO	151	5755	11.16	11.50	11.09	11.50
	159	5795	11.15	11.50	11.09	11.50
802.11ac-80 VHTO	155	5775	11.12	11.50	11.04	11.50

Additional conducted power measurement is required when reported SAR is > 1.2W/kg. In case the subsequent test configuration and the channel bandwidth is smaller than the initial test configuration, all channels that overlap with the larger channel bandwidth in the initial configuration should be tested.

1. The initial test configuration for 2.4 GHz and 5 GHz OFDM transmission modes is determined by the 802.11 configuration with the highest maximum output power specified for production units, including tune-up tolerance, in each standalone and aggregated frequency band. SAR for the initial test configuration is measured using the highest maximum output power channel determined by the default power measurement procedures. When multiple transmission modes (802.11a/g/n/ac/ax) have the same specified maximum output power, largest channel bandwidth, lowest order modulation and lowest data rate, lowest order 802.11 mode is selected (i.e. a, g, n, ac then ax)
2. When the highest reported SAR for the initial test configuration (when applicable, include subsequent highest output channels), according to the initial test position or fixed exposure requirements, is adjusted by the ratio of the subsequent test configuration to the initial test configuration specified maximum output power and the adjusted SAR is ≤ 1.2 W/Kg, SAR is not required for that subsequent test configuration.



Band	CH	Frequency (MHz)	Peak Power (dBm)	Average Power (dBm)	
			AUX (Chain A)	AUX (Chain A)	Tune-Up Limit
Bluetooth BR GFSK	0	2402.0	9.18	6.09	7
	39	2441.0	9.92	6.72	7
	78	2480.0	9.53	6.26	7
Bluetooth EDR $\pi/4$ -DQPSK	0	2402.0	9.02	5.81	7
	39	2441.0	9.56	6.34	7
	78	2480.0	9.62	6.26	7
Bluetooth EDR 8DPSK	0	2402.0	9.42	6.02	7
	39	2441.0	9.38	6.16	7
	78	2480.0	9.49	6.22	7

Band	CH	Frequency (MHz)	Peak Power (dBm)	Average Power (dBm)	
			AUX (Chain A)	AUX (Chain A)	Tune-Up Limit
Bluetooth LE	0	2402.0	5.89	2.51	4.5
	19	2440.0	6.03	2.68	4.5
	39	2480.0	6.72	3.26	4.5



The SAR evaluation of this device selected 1M with the highest average power and the duty cycle is 77.3.

7.4 Antenna location

Antenna	Bottom of Laptop (mm)	Bottom Face (mm)	Side 1 (mm)	Side 2 (mm)	Side 3 (mm)	Side 4 (mm)
WLAN Main	<5mm	<5mm	27mm	<5mm	137mm	250mm
WLAN /BT Aux	<5mm	<5mm	27mm	250mm	137mm	<5mm

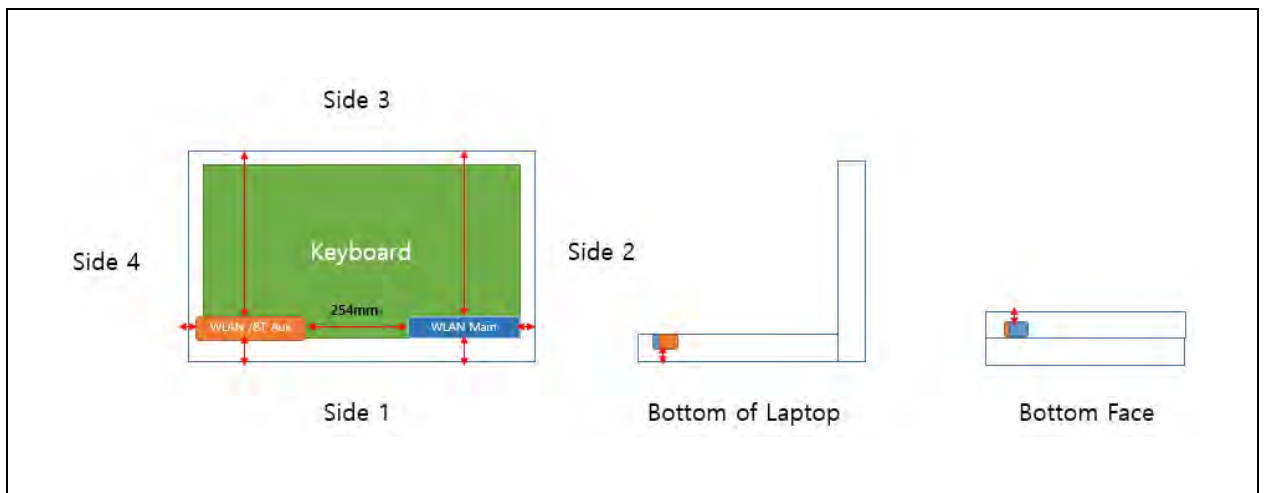



7.5 Standalone SAR Test Exclusion Calculation

Body SAR test reduction															
Ant. Used	Band	Frequency	Tune-Power		Distance of Ant. To User (mm)					Calculated value and evaluated result					exclusion threshold
		(GHz)	(dBm)	(mW)	Bottom Face	Side1	Side2	Side3	Side4	Bottom Face	Side1	Side2	Side3	Side4	
Bluetooth Antenna	BT	2.480	7	5	5	27	250	137	5	1.6	0.3	2095.0	965.0	1.6	3
										EXEMPT	EXEMPT	EXEMPT	EXEMPT	EXEMPT	
WLAN Antenna	2.4GHz WLAN Ant-Main	2.462	13	20	5	27	5	137	250	6.3	1.2	6.3	966.0	2096.0	3
										MEASURE	EXEMPT	MEASURE	EXEMPT	EXEMPT	
	2.4GHz WLAN Ant-Aux	2.462	13	20	5	27	250	137	5	6.3	1.2	2096.0	966.0	6.3	3
										MEASURE	EXEMPT	EXEMPT	EXEMPT	MEASURE	
	5GHz WLAN Ant-Main	5.825	12	16	5	27	5	137	250	7.7	1.4	7.7	932.0	2062.0	3
										MEASURE	EXEMPT	MEASURE	EXEMPT	EXEMPT	
	5GHz WLAN Ant-Aux	5.825	12	16	5	27	250	137	5	7.7	1.4	2062.0	932.0	7.7	3
										MEASURE	EXEMPT	EXEMPT	EXEMPT	MEASURE	

Note:

1. The test reduction for distance less than 50mm and more than 50mm. Use the max power to make sure minimum distance by evaluated for SAR testing.
2. For 100 MHz to 6 GHz and test separation distances > 50 mm, According to KDB 447498, if the calculated Power threshold is less than the output power then SAR testing is required.
3. For 100 MHz to 6 GHz and test separation distances ≤ 50 mm, the 1-g and 10-g SAR test exclusion thresholds are determined by the following: According to KDB 447498, if the calculated threshold value are >3 then Body SAR and >7.5 then Limbs SAR testing are required. Calculated Value only include number format, that is mean through compare output power with threshold, if the Calculated value more than 3, the SAR test should be perform. Otherwise, the SAR test could be exempt. (<50mm)
4. When an antenna qualifies for the standalone SAR test exclusion of KDB 447498 section 4.3.1 and also transmits simultaneously with other antennas, the standalone SAR value must be estimated according to KDB 447498 section "4.3.2. Simultaneous transmission SAR test exclusion considerations b)"
5. We used the highest frequency and power, and evaluated the results in the worst case.
6. Power and distance are rounded to the nearest mW and mm before calculation.
7. The result is rounded to one decimal place for comparison.
8. The Devices has actually tested the exemption from SAR.



7.6 Simultaneous Transmitting Evaluate

Simultaneous transmission configurations as below:

Condition	Band				
	2.4 GHz WLAN Ant Main	2.4 GHz WLAN Ant Aux	5 GHz WLAN Ant Main	5 GHz WLAN Ant Aux	Bluetooth Ant Aux
1	√	√	-	-	-
2	√	-	-	-	√
3	-	-	√	√	-
4	-	-	√	-	√
5	-	-	√	√	√

7.6.1 Sum of 1-g SAR of all simultaneously transmitting

When the sum of 1-g SAR of all simultaneously transmitting antennas in an operating mode and exposure condition combination is within the SAR limit, SAR test exclusion applies to that simultaneous transmission configuration.

Sum of 1-g SAR of summary as below:

Exposure Position	1	2	3	4	5	1+2 Summed 1g SAR (W/kg)	1+5 Summed 1g SAR (W/kg)	3+4 Summed 1g SAR (W/kg)	3+5 Summed 1g SAR (W/kg)	3+4+5 Summed 1g SAR (W/kg)
	WLAN2.4GHz Ant Main	WLAN2.4GHz Ant Aux	WLAN5GHz Ant Main	WLAN5GHz Ant Aux	Bluetooth Ant Aux					
Bottom Face at 0mm -	0.53	0.49	0.39	0.31	0.14	1.02	0.66	0.69	0.52	0.83
Bottom of laptop at 0mm -	0.87	0.70	0.99	1.11	0.26	1.57	1.13	2.10	1.25	2.37
side 1 at 0mm -	0.04	0.04	0.06	0.06	0.02	0.08	0.06	0.12	0.08	0.14
side 2 at 0mm -	0.17	0.01	0.28	0.01	0.02	0.18	0.19	0.29	0.29	0.31
side 3 at 0mm -	0.01	0.03	0.01	0.01	0.01	0.04	0.02	0.02	0.02	0.03
side 4 at 0mm -	0.01	0.10	0.01	0.44	0.03	0.11	0.04	0.45	0.04	0.48

7.6.2 SAR to peak location separation ratio (SPLSR)

When the sum of SAR is larger than the limit, SAR test exclusion is determined by the SAR to peak location separation ratio. The ratio is determined by $(SAR_1 + SAR_2)^{1.5}/R_i$, rounded to two decimal digits, and must be ≤ 0.04 for all antenna pairs in the configuration to qualify for 1-g SAR test exclusion..

5GHz Main + 5GHz Aux

<input type="checkbox"/> Maxima and position w.r.t. Grid Reference Point associated 1g averages	
<input type="checkbox"/> Zoom Scan (C:\Users\dasy\Desktop\57_IEEE 802.11ac 80 CH 138_VHT0_Bottom of laptop_0mm_Ant Main.da53:0/Flat)	Max. 1 at (-61.00, 140.00, 2.77) mm
	0.99 W/kg (Power Scale Factor: 1.071704335)
<input type="checkbox"/> Zoom Scan (C:\Users\dasy\Desktop\69_IEEE 802.11ac 80 CH 138_VHT0_Bottom of laptop_0mm_Ant Aux.da53:0/Flat)	Max. 2 at (-61.00, -132.60, 2.93) mm
	1.11 W/kg (Power Scale Factor: 1.08812)
<input type="checkbox"/> Distances and Separation Ratios	
Max. 1 - Max. 2	
Distance [mm]: 272.60 / Separation ratio [W/kg/mm]: 0.01	

Antenna	Index	Frequency (GHz)	Reported SAR1g (W/Kg)	Σ Reported SAR1g (W/Kg)	Antenna pair (mm)	Peak location separation ratio
5GHz Main	57	5.69	0.99	2.100	272.6	0.01
5GHz Aux	69	5.795	1.11			



8. System Verification and Validation

8.1 Symmetric Dipoles for System Verification

Construction	Symmetrical dipole with 1/4 balun enables measurement of feed point impedance with NWA matched for use near flat phantoms filled with head simulating solutions Includes distance holder and tripod adaptor Calibration Calibrated SAR value for specified position and input power at the flat phantom in head simulating solutions.
Return Loss	> 20 dB at specified verification position
Options	Dipoles for other frequencies or solutions and other calibration conditions are available upon request

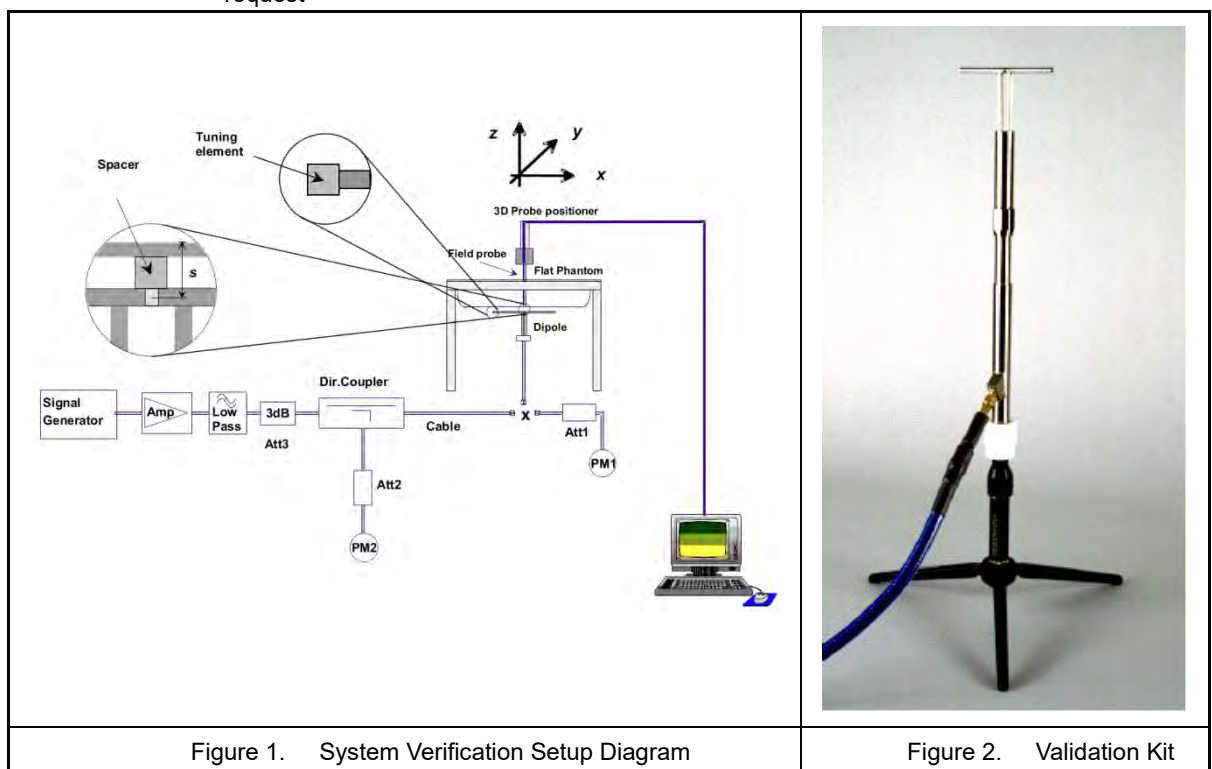



8.2 Verification Summary

Prior to the assessment, the system validation kit was used to test whether the system was operating within its specifications of $\pm 10\%$. The measured SAR will be normalized to 1 W input power. The verification was performed at 2450, 5250, 5600 and 5750 MHz.

Mixture Type	Frequency (MHz)	Power	Probe	Dipole	SAR _{1g} (W/Kg)	Normalize to 1 Watt 1g (W/Kg)	1 W Target SAR _{1g} (W/Kg)	SAR _{10g} (W/Kg)	Normalize to 1 Watt 10g (W/Kg)	1 W Target SAR _{10g} (W/Kg)	Difference percentage 1g	Difference percentage 10g	Date
			Model / Serial No.	Model / Serial No.									
Head	2450	250 mW	EX3DV4-SN3847	D2450V2 - SN712	12.6	50.4	51.20	5.85	23.4	23.60	-1.6%	-0.8%	Dec. 24, 2020
Head	2450	250 mW	EX3DV4-SN3847	D2450V2 - SN712	12.7	50.8	51.20	5.94	23.76	23.60	-0.8%	0.7%	Feb. 02, 2021
Head	5250	100 mW	EX3DV4-SN3847	D5250V2 - SN1021	7.79	77.9	75.50	2.11	21.1	21.40	3.2%	-1.4%	Feb. 04, 2021
Head	5600	100 mW	EX3DV4-SN3847	D5600V2 - SN1021	8.59	85.9	79.60	2.36	23.6	22.40	7.9%	5.4%	Dec. 25, 2020
Head	5600	100 mW	EX3DV4-SN3847	D5600V2 - SN1021	8.15	81.5	79.60	2.26	22.6	22.40	2.4%	0.9%	Dec. 26, 2020
Head	5750	100 mW	EX3DV4-SN3847	D5750V2 - SN1021	8.17	81.7	76.00	2.31	23.1	21.30	7.5%	8.5%	Feb. 04, 2021



9. Test Equipment List

Testing Engineer: Jason Tsao

Manufacturer	Name of Equipment	Type/Model	Serial Number	Calibration	
				Cal. Date	Cal.Period
SPEAG	2450MHz System Validation Kit	D2450V2	712	2020/04/26	1 year
SPEAG	5GHz System Validation Kit	D5GHzV2	1021	2020/04/23	1 year
SPEAG	Dosimetric E-Field Probe	EX3DV4	3847	2020/05/20	1 year
SPEAG	Data Acquisition Electronics	DAE4	541	2020/03/18	1 year
SPEAG	Measurement Server	SE UMS 011 AA	1025	NCR	
SPEAG	Device Holder	N/A	N/A	NCR	
SPEAG	Phantom	ELI V4.0	1036	NCR	
SPEAG	Robot	Staubli TX90XL	F16/54FTA1/A/01	NCR	
SPEAG	Software	DASY52 V52.10 (3)	N/A	NCR	
SPEAG	Software	SEMCAD X V14.6.10(7331)	N/A	NCR	
R&S	Bluetooth Tester	CBT	100350	2019/03/27	2 year
SPEAG	Network Analyzer	DAKS_VNA R140	0010318	2020/05/26	1 year
SPEAG	Dielectric Probe Kit	DAKS-3.5	1101	2020/05/26	1 year
HILA	Digital Thermometer	TM-906A	1500033	2020/10/28	1 year
Agilent	Power Sensor	8481H	3318A20779	2020/06/09	1 year
Agilent	Power Meter	EDM Series E4418B	GB40206143	2020/06/09	1 year
Agilent	Signal Generator	E8257D	MY44320425	2020/03/04	1 year
Agilent	Dual Directional Coupler	778D	50334	NCR	
Woken	Dual Directional Coupler	0100AZ20200801O	11012409517	NCR	
Mini-Circuits	Power Amplifier	EMC014225P	980292	NCR	
Mini-Circuits	Power Amplifier	EMC2830P	980293	NCR	
Aisi	Attenuator	IEAT 3dB	N/A	NCR	
Agilent	Dual Directional Coupler	778D	50334	NCR	

Table 1. Test Equipment List



10. Measurement Uncertainty

Decision Rule

- Uncertainty is not included.
- Uncertainty is included.

The measured SAR was <1.5 W/kg for 1g for all frequency bands. Therefore, per KDB Publication 865664 D01v01r04, the extended measurement uncertainty analysis per IEEE 1528-2013 was not required.

IEC 62209-2								
Measurement uncertainty evaluation template for handset SAR test (300 MHz~3 GHz)								
Uncertainty component	Tol.	Prob. Dist.	Div.	C _i - 1g	C _i - 10g	u _i - 1g (± %)	u _i - 10g (± %)	v _i
Measurement system								
Probe calibration	6.1	N	1	1	1	6.1	6.1	∞
Axial isotropy	4.7	R	1.732	0.7	0.7	1.9	1.9	∞
Hemispherical isotropy	9.6	R	1.732	0.7	0.7	3.9	3.9	∞
Boundary effect	1.0	R	1.732	1	1	0.6	0.6	∞
Linearity	4.7	R	1.732	1	1	2.7	2.7	∞
System detection limits	0.25	R	1.732	1	1	0.1	0.1	∞
Readout electronics	0.3	N	1	1	1	0.3	0.3	∞
Response time	0.0	R	1.732	1	1	0.0	0.0	∞
Integration time	2.6	R	1.732	1	1	1.5	1.5	∞
RF Ambient Noise	3.0	R	1.732	1	1	1.7	1.7	∞
RF Ambient Reflections	3.0	R	1.732	1	1	1.7	1.7	∞
Probe Positioner	0.02	R	1.732	1	1	0.01	0.01	∞
Probe Positioning	0.4	R	1.732	1	1	0.2	0.2	∞
Max. SAR evaluation	2.0	R	1.732	1	1	1.2	1.2	∞
Test sample related								
Test sample positioning	2.9	N	1	1	1	2.9	2.9	145
Device holder uncertainty	3.6	N	1	1	1	3.6	3.6	7
SAR drift measurement	5.0	R	1.732	1	1	2.9	2.9	∞
Phantom and tissue parameters								
Phantom shell uncertainty	7.2	R	1.732	1	1	4.2	4.2	∞
Liquid Conductivity (target)	5.0	R	1.732	0.78	0.71	2.3	2.0	∞
Liquid Conductivity (measurement)	4.8	R	1.732	0.78	0.71	2.2	2.0	∞
Liquid Permittivity (target)	5.0	R	1.732	0.23	0.26	0.7	0.8	∞
Liquid Permittivity (measurement)	4.8	R	1.732	0.23	0.26	0.6	0.7	∞
Combined standard uncertainty								
-	-	RSS	-	-	-	11.4	11.4	693
Expanded uncertainty (95% confidence interval)								
-	-	k =2	-	-	-	22.9	22.7	-

Uncertainty Budget for frequency range 300 MHz to 3 GHz



IEC 62209-2 Measurement uncertainty evaluation template for handset SAR test (3 GHz~6 GHz)								
Uncertainty component	Tol.	Prob. Dist.	Div.	C _i - 1g	C _i - 10g	u _i - 1g (± %)	u _i - 10g (± %)	v _i
Measurement system								
Probe calibration	6.1	N	1	1	1	6.1	6.1	∞
Axial isotropy	4.7	R	1.732	0.7	0.7	1.9	1.9	∞
Hemispherical isotropy	9.6	R	1.732	0.7	0.7	3.9	3.9	∞
Boundary effect	1.0	R	1.732	1	1	0.6	0.6	∞
Linearity	4.7	R	1.732	1	1	2.7	2.7	∞
System detection limits	0.25	R	1.732	1	1	0.1	0.1	∞
Readout electronics	0.3	N	1	1	1	0.3	0.3	∞
Response time	0.0	R	1.732	1	1	0.0	0.0	∞
Integration time	2.6	R	1.732	1	1	1.5	1.5	∞
RF Ambient Noise	3.0	R	1.732	1	1	1.7	1.7	∞
RF Ambient Reflections	3.0	R	1.732	1	1	1.7	1.7	∞
Probe Positioner	0.02	R	1.732	1	1	0.01	0.01	∞
Probe Positioning	0.4	R	1.732	1	1	0.2	0.2	∞
Max. SAR evaluation	2.0	R	1.732	1	1	1.2	1.2	∞
Test sample related								
Test sample positioning	2.9	N	1	1	1	2.9	2.9	145
Device holder uncertainty	3.6	N	1	1	1	3.6	3.6	7
SAR drift measurement	5.0	R	1.732	1	1	2.9	2.9	∞
Phantom and tissue parameters								
Phantom shell uncertainty	7.6	R	1.732	1	1	4.4	4.4	∞
Liquid Conductivity (target)	5.0	R	1.732	0.78	0.71	2.3	2.0	∞
Liquid Conductivity (measurement)	4.8	R	1.732	0.78	0.71	2.2	2.0	∞
Liquid Permittivity (target)	5.0	R	1.732	0.23	0.26	0.7	0.8	∞
Liquid Permittivity (measurement)	4.8	R	1.732	0.23	0.26	0.6	0.7	∞
Combined standard uncertainty								
-	-	RSS	-	-	-	12.1	12.0	859
Expanded uncertainty (95% confidence interval)								
-	-	k =2	-	-	-	24.1	24.0	-

Uncertainty Budget for frequency range 3 GHz to 6 GHz

11. Measurement Procedure

The measurement procedures are as follows:

1. For WLAN function, engineering testing software installed on DUTs can provide continuous transmitting signal.
2. Measure output power through RF cable and power meter
3. Set scan area, grid size and other setting on the DASY software
4. Find out the largest SAR result on these testing positions of each band
5. Measure SAR results for other channels in worst SAR testing position if the SAR of highest power channel is larger than 0.8 W/kg

According to the test standard, the recommended procedure for assessing the peak spatial-average SAR value consists of the following steps:

1. Power reference measurement
2. Area scan
3. Zoom scan
4. Power drift measurement

11.1 Spatial Peak SAR Evaluation

The procedure for spatial peak SAR evaluation has been implemented according to the test standard. It can be conducted for 1 g and 10 g, as well as for user-specific masses. The DASY software includes all numerical procedures necessary to evaluate the spatial peak SAR value.

The base for the evaluation is a "cube" measurement. The measured volume must include the 1 g and 10 g cubes with the highest averaged SAR values. For that purpose, the center of the measured volume is aligned to the interpolated peak SAR value of a previously performed area scan.

The entire evaluation of the spatial peak values is performed within the post-processing engine (SEMCAD). The system always gives the maximum values for the 1 g and 10 g cubes. The algorithm to find the cube with highest averaged SAR is divided into the following stages

1. Extraction of the measured data (grid and values) from the Zoom Scan
2. Calculation of the SAR value at every measurement point based on all stored data (A/D values and measurement parameters)
3. Generation of a high-resolution mesh within the measured volume
4. Interpolation of all measured values from the measurement grid to the high-resolution grid
5. Extrapolation of the entire 3-D field distribution to the phantom surface over the distance from sensor to surface
6. Calculation of the averaged SAR within masses of 1 g and 10 g

11.2 Area & Zoom Scan Procedures

First Area Scan is used to locate the approximate location(s) of the local peak SAR value(s). The measurement grid within an Area Scan is defined by the grid extent, grid step size and grid offset. Next, in order to determine the EM field distribution in a three-dimensional spatial extension, Zoom Scan is required. The Zoom Scan measures points and step size follow as below. The Zoom Scan is performed around the highest E-field value to determine the averaged SAR-distribution over 10 g.

		≤ 3 GHz	> 3 GHz
Maximum distance from closest measurement point (geometric center of probe sensors) to phantom surface		5 mm \pm 1 mm	$\frac{1}{2} \cdot \delta \cdot \ln(2)$ mm \pm 0.5 mm
Maximum probe angle from probe axis to phantom surface normal at the measurement location		30° \pm 1°	20° \pm 1°
Maximum area scan spatial resolution: Δx_{Area} , Δy_{Area}		≤ 2 GHz: ≤ 15 mm 2 – 3 GHz: ≤ 12 mm	3 – 4 GHz: ≤ 12 mm 4 – 6 GHz: ≤ 10 mm
		When the x or y dimension of the test device, in the measurement plane orientation, is smaller than the above, the measurement resolution must be \leq the corresponding x or y dimension of the test device with at least one measurement point on the test device.	
Maximum zoom scan spatial resolution: Δx_{Zoom} , Δy_{Zoom}		≤ 2 GHz: ≤ 8 mm 2 – 3 GHz: ≤ 5 mm*	3 – 4 GHz: ≤ 5 mm* 4 – 6 GHz: ≤ 4 mm*
Maximum zoom scan spatial resolution, normal to phantom surface	uniform grid: $\Delta z_{Zoom}(n)$	≤ 5 mm	3 – 4 GHz: ≤ 4 mm 4 – 5 GHz: ≤ 3 mm 5 – 6 GHz: ≤ 2 mm
	graded grid	$\Delta z_{Zoom}(1)$: between 1 st two points closest to phantom surface	≤ 4 mm
		$\Delta z_{Zoom}(n>1)$: between subsequent points	$\leq 1.5 \cdot \Delta z_{Zoom}(n-1)$ mm
Minimum zoom scan volume	x, y, z	≥ 30 mm	3 – 4 GHz: ≥ 28 mm 4 – 5 GHz: ≥ 25 mm 5 – 6 GHz: ≥ 22 mm
Note: δ is the penetration depth of a plane-wave at normal incidence to the tissue medium; see IEEE Std 1528-2013 for details. * When zoom scan is required and the <i>reported</i> SAR from the <i>area scan based 1-g SAR estimation</i> procedures of KDB Publication 447498 is ≤ 1.4 W/kg, ≤ 8 mm, ≤ 7 mm and ≤ 5 mm zoom scan resolution may be applied, respectively, for 2 GHz to 3 GHz, 3 GHz to 4 GHz and 4 GHz to 6 GHz.			

(Our measure settings are refer KDB Publication 865664 D01v01r04)



11.3 Volume Scan Procedures

The volume scan is used for assess overlapping SAR distributions for antennas transmitting in different frequency bands. It is equivalent to an oversized zoom scan used in standalone measurements. The measurement volume will be used to enclose all the simultaneous transmitting antennas. For antennas transmitting simultaneously in different frequency bands, the volume scan is measured separately in each frequency band. In order to sum correctly to compute the 1 g aggregate SAR, the DUT remain in the same test position for all measurements and all volume scan use the same spatial resolution and grid spacing. When all volume scan were completed, the software, SEMCAD postprocessor can combine and subsequently superpose these measurement data to calculating the multiband SAR.

11.4 Power Drift Monitoring

All SAR testing is under the DUT install full charged battery and transmit maximum output power. In DASYS measurement software, the power reference measurement and power drift measurement procedures are used for monitoring the power drift of DUT during SAR test. Both these procedures measure the field at a specified reference position before and after the SAR testing. The software will calculate the field difference in dB. If the power drifts more than 5 %, the SAR will be retested.



12. SAR Test Results Summary

Note:

1. According to KDB 248227 D01 Section 5.2.1, SAR is measured for 2.4 GHz 802.11b DSSS using either a fixed test position or, when applicable, the initial test position procedure. SAR test reduction is determined according to the following:
 - a. When the reported SAR of the highest measured maximum output power channel for the exposure configuration is ≤ 0.8 W/kg, no further SAR testing is required for 802.11b DSSS in that exposure configuration.
 - b. When the reported SAR is > 0.8 W/kg, SAR is required for that exposure configuration using the next highest measured output power channel. When any reported SAR is > 1.2 W/kg, SAR is required for the third channel; i.e., all channels require testing.
2. According to KDB 248227 D01 Section 5.2.2, when SAR measurement is required for 2.4 GHz 802.11g/n OFDM configurations, the measurement and test reduction procedures for OFDM are applied. SAR is not required for the following 2.4 GHz OFDM conditions.
 - a. When KDB Publication 447498 D01 SAR test exclusion applies to the OFDM configuration.
 - b. When the highest reported SAR for DSSS is adjusted by the ratio of OFDM to DSSS specified maximum output power and the adjusted SAR is ≤ 1.2 W/kg.
3. According to KDB 248227 D01 Section 5.3.2, the initial test configuration for 2.4 GHz and 5 GHz OFDM transmission modes is determined by the 802.11 configuration with the highest maximum output power specified for production units, including tune-up tolerance, in each standalone and aggregated frequency band. SAR for the initial test configuration is measured using the highest maximum output power channel determined by the default power measurement procedures.
 - a. When multiple channel bandwidth configurations in a frequency band have the same specified maximum output power, the initial test configuration is determined by applying the following steps sequentially.
 - 1) The largest channel bandwidth configuration is selected among the multiple configurations in a frequency band with the same specified maximum output power.
 - 2) If multiple configurations have the same specified maximum output power and largest channel bandwidth, the lowest order modulation among the largest channel bandwidth configurations is selected.
 - 3) If multiple configurations have the same specified maximum output power, largest channel bandwidth and lowest order modulation, the lowest data rate configuration among these configurations is selected.
 - 4) When multiple transmission modes (802.11a/g/n/ac /ax) have the same specified maximum output power, largest channel bandwidth, lowest order modulation and lowest data rate, lowest order 802.11 mode is selected; (i.e. a/g/n/ac/ax).
 - b. After an initial test configuration is determined, if multiple test channels have the same measured maximum output power, the channel chosen for SAR measurement is determined according to the following. These channel selection procedures apply to both the initial test configuration and subsequent test configuration(s) selection.
 - 1) The channel closest to mid-band frequency is selected for SAR measurement.
 - 2) For channels with equal separation from mid-band frequency; for example, high and low channels or two mid-band channels, the higher frequency (number) channel is selected for SAR measurement.



12.1 Body SAR Measurement

Measurement Results													
Index.	Band	Mode	Frequency		Data Rate	Test Position	SAR _{1g} (W/Kg)	Burst Avg Power (dBm)	Max tune-up (dBm)	Duty Cycle (%)	Reported SAR _{1g}	Note	Antenna
			Ch.	MHz									
	WLAN2.4GHz	802.11b	11	2462	1 Mbps	Bottom of laptop	0.691	12.84	13	99.35	0.722	Ant Main	South Star
#5	WLAN2.4GHz	802.11b	1	2412	1 Mbps	Bottom of laptop	0.819	12.77	13	99.35	0.870	Ant Main	South Star
	WLAN2.4GHz	802.11b	6	2437	1 Mbps	Bottom of laptop	0.766	12.83	13	99.35	0.802	Ant Main	South Star
	WLAN2.4GHz	802.11b	11	2462	1 Mbps	Bottom Face	0.505	12.84	13	99.35	0.528	Ant Main	South Star
	WLAN2.4GHz	802.11b	1	2412	1 Mbps	Bottom Face	0.481	12.77	13	99.35	0.511	Ant Main	South Star
	WLAN2.4GHz	802.11b	6	2437	1 Mbps	Bottom Face	0.493	12.83	13	99.35	0.516	Ant Main	South Star
	WLAN2.4GHz	802.11b	11	2462	1 Mbps	Side 1	0.042	12.84	13	99.35	0.044	Ant Main	South Star
	WLAN2.4GHz	802.11b	11	2462	1 Mbps	Side 2	0.165	12.84	13	99.35	0.172	Ant Main	South Star
	WLAN2.4GHz	802.11b	11	2462	1 Mbps	Side 3	0.013	12.84	13	99.35	0.014	Ant Main	South Star
	WLAN2.4GHz	802.11b	11	2462	1 Mbps	Side 4	0.01	12.84	13	99.35	0.010	Ant Main	South Star
	WLAN2.4GHz	802.11b	11	2462	1 Mbps	Bottom of laptop	0.482	12.84	13	99.35	0.504	Ant Main	AWAN
	WLAN2.4GHz	802.11b	1	2412	1 Mbps	Bottom of laptop	0.572	12.77	13	99.35	0.607	Ant Main	AWAN
	WLAN2.4GHz	802.11b	6	2437	1 Mbps	Bottom of laptop	0.534	12.83	13	99.35	0.559	Ant Main	AWAN
	WLAN2.4GHz	802.11b	11	2462	1 Mbps	Bottom Face	0.356	12.84	13	99.35	0.372	Ant Main	AWAN
	WLAN2.4GHz	802.11b	1	2412	1 Mbps	Bottom Face	0.336	12.77	13	99.35	0.357	Ant Main	AWAN
	WLAN2.4GHz	802.11b	6	2437	1 Mbps	Bottom Face	0.346	12.83	13	99.35	0.362	Ant Main	AWAN
	WLAN2.4GHz	802.11b	11	2462	1 Mbps	Side 1	0.029	12.84	13	99.35	0.030	Ant Main	AWAN
	WLAN2.4GHz	802.11b	11	2462	1 Mbps	Side 2	0.118	12.84	13	99.35	0.123	Ant Main	AWAN
	WLAN2.4GHz	802.11b	11	2462	1 Mbps	Side 3	0.009	12.84	13	99.35	0.009	Ant Main	AWAN
	WLAN2.4GHz	802.11b	11	2462	1 Mbps	Side 4	0.01	12.84	13	99.35	0.010	Ant Main	AWAN
#1	WLAN2.4GHz	802.11b	6	2437	1 Mbps	Bottom of laptop	0.681	12.91	13	99.29	0.700	Ant Aux	South Star
	WLAN2.4GHz	802.11b	1	2412	1 Mbps	Bottom of laptop	0.609	12.82	13	99.29	0.639	Ant Aux	South Star
	WLAN2.4GHz	802.11b	11	2462	1 Mbps	Bottom of laptop	0.588	12.5	13	99.29	0.664	Ant Aux	South Star
	WLAN2.4GHz	802.11b	6	2437	1 Mbps	Bottom Face	0.304	12.91	13	99.29	0.313	Ant Aux	South Star
	WLAN2.4GHz	802.11b	1	2412	1 Mbps	Bottom Face	0.409	12.82	13	99.29	0.429	Ant Aux	South Star
	WLAN2.4GHz	802.11b	11	2462	1 Mbps	Bottom Face	0.434	12.5	13	99.29	0.490	Ant Aux	South Star
	WLAN2.4GHz	802.11b	6	2437	1 Mbps	Side 1	0.035	12.91	13	99.29	0.036	Ant Aux	South Star
	WLAN2.4GHz	802.11b	6	2437	1 Mbps	Side 2	0.01	12.91	13	99.29	0.010	Ant Aux	South Star
	WLAN2.4GHz	802.11b	6	2437	1 Mbps	Side 3	0.024	12.91	13	99.29	0.025	Ant Aux	South Star
	WLAN2.4GHz	802.11b	6	2437	1 Mbps	Side 4	0.096	12.91	13	99.29	0.099	Ant Aux	South Star



Measurement Results													
Index.	Band	Mode	Frequency		Data Rate	Test Position	SAR _{1g} (W/Kg)	Burst Avg Power (dBm)	Max tune-up (dBm)	Duty Cycle (%)	Reported SAR 1 g	Note	Antenna
			Ch.	MHz									
	WLAN2.4GHz	802.11b	6	2437	1 Mbps	Bottom of laptop	0.666	12.91	13	99.29	0.685	Ant Aux	AWAN
	WLAN2.4GHz	802.11b	1	2412	1 Mbps	Bottom of laptop	0.594	12.82	13	99.29	0.623	Ant Aux	AWAN
	WLAN2.4GHz	802.11b	11	2462	1 Mbps	Bottom of laptop	0.572	12.5	13	99.29	0.646	Ant Aux	AWAN
	WLAN2.4GHz	802.11b	6	2437	1 Mbps	Bottom Face	0.298	12.91	13	99.29	0.306	Ant Aux	AWAN
	WLAN2.4GHz	802.11b	1	2412	1 Mbps	Bottom Face	0.394	12.82	13	99.29	0.414	Ant Aux	AWAN
	WLAN2.4GHz	802.11b	11	2462	1 Mbps	Bottom Face	0.426	12.5	13	99.29	0.481	Ant Aux	AWAN
	WLAN2.4GHz	802.11b	6	2437	1 Mbps	Side 1	0.031	12.91	13	99.29	0.032	Ant Aux	AWAN
	WLAN2.4GHz	802.11b	6	2437	1 Mbps	Side 2	0.01	12.91	13	99.29	0.010	Ant Aux	AWAN
	WLAN2.4GHz	802.11b	6	2437	1 Mbps	Side 3	0.022	12.91	13	99.29	0.023	Ant Aux	AWAN
	WLAN2.4GHz	802.11b	6	2437	1 Mbps	Side 4	0.089	12.91	13	99.29	0.091	Ant Aux	AWAN
	Bluetooth		39	2441	1 Mbps	Bottom of laptop	0.134	6.72	7	77.30	0.185	Ant Aux	South Star
	Bluetooth		0	2402	1 Mbps	Bottom of laptop	0.156	6.09	7	77.30	0.249	Ant Aux	South Star
#23	Bluetooth		78	2480	1 Mbps	Bottom of laptop	0.169	6.18	7	77.30	0.264	Ant Aux	South Star
	Bluetooth		39	2441	1 Mbps	Bottom Face	0.057	6.72	7	77.30	0.079	Ant Aux	South Star
	Bluetooth		0	2402	1 Mbps	Bottom Face	0.085	6.09	7	77.30	0.136	Ant Aux	South Star
	Bluetooth		78	2480	1 Mbps	Bottom Face	0.082	6.18	7	77.30	0.128	Ant Aux	South Star
	Bluetooth		39	2441	1 Mbps	Side 1	0.01	6.72	7	77.30	0.014	Ant Aux	South Star
	Bluetooth		39	2441	1 Mbps	Side 2	0.01	6.72	7	77.30	0.014	Ant Aux	South Star
	Bluetooth		39	2441	1 Mbps	Side 3	0.005	6.72	7	77.30	0.007	Ant Aux	South Star
	Bluetooth		39	2441	1 Mbps	Side 4	0.018	6.72	7	77.30	0.025	Ant Aux	South Star
	Bluetooth		39	2441	1 Mbps	Bottom of laptop	0.128	6.72	7	77.30	0.177	Ant Aux	AWAN
	Bluetooth		0	2402	1 Mbps	Bottom of laptop	0.149	6.09	7	77.30	0.238	Ant Aux	AWAN
	Bluetooth		78	2480	1 Mbps	Bottom of laptop	0.165	6.18	7	77.30	0.258	Ant Aux	AWAN
	Bluetooth		39	2441	1 Mbps	Bottom Face	0.054	6.72	7	77.30	0.075	Ant Aux	AWAN
	Bluetooth		0	2402	1 Mbps	Bottom Face	0.082	6.09	7	77.30	0.131	Ant Aux	AWAN
	Bluetooth		78	2480	1 Mbps	Bottom Face	0.077	6.18	7	77.30	0.120	Ant Aux	AWAN
	Bluetooth		39	2441	1 Mbps	Side 1	0.008	6.72	7	77.30	0.011	Ant Aux	AWAN
	Bluetooth		39	2441	1 Mbps	Side 2	0.004	6.72	7	77.30	0.006	Ant Aux	AWAN
	Bluetooth		39	2441	1 Mbps	Side 3	0.005	6.72	7	77.30	0.007	Ant Aux	AWAN
	Bluetooth		39	2441	1 Mbps	Side 4	0.001	6.72	7	77.30	0.001	Ant Aux	AWAN



Measurement Results													
Index.	Band	Mode	Frequency		Data Rate	Test Position	SAR _{1g} (W/Kg)	Burst Avg Power (dBm)	Max tune-up (dBm)	Duty Cycle (%)	Reported SAR _{1g}	Note	Antenna
			Ch.	MHz									
	WLAN5GHz	802.11n 40 MHz	54	5270	HT0	Bottom of laptop	0.521	11.43	12	98.16	0.605	Ant Main	South Star
	WLAN5GHz	802.11n 40 MHz	62	5310	HT0	Bottom of laptop	0.566	11.83	12	98.16	0.600	Ant Main	South Star
	WLAN5GHz	802.11n 40 MHz	54	5270	HT0	Bottom Face	0.248	11.43	12	98.16	0.288	Ant Main	South Star
	WLAN5GHz	802.11n 40 MHz	62	5310	HT0	Bottom Face	0.233	11.83	12	98.16	0.247	Ant Main	South Star
	WLAN5GHz	802.11n 40 MHz	62	5310	HT0	Side 1	0.035	11.83	12	98.16	0.037	Ant Main	South Star
	WLAN5GHz	802.11n 40 MHz	62	5310	HT0	Side 2	0.181	11.83	12	98.16	0.192	Ant Main	South Star
	WLAN5GHz	802.11n 40 MHz	62	5310	HT0	Side 3	0.01	11.83	12	98.16	0.011	Ant Main	South Star
	WLAN5GHz	802.11n 40 MHz	62	5310	HT0	Side 4	0.01	11.83	12	98.16	0.011	Ant Main	South Star
	WLAN5GHz	802.11n 40 MHz	54	5270	HT0	Bottom of laptop	0.762	11.43	12	98.16	0.885	Ant Main	AWAN
#120	WLAN5GHz	802.11n 40 MHz	62	5310	HT0	Bottom of laptop	0.864	11.83	12	98.16	0.916	Ant Main	AWAN
	WLAN5GHz	802.11n 40 MHz	54	5270	HT0	Bottom Face	0.332	11.43	12	98.16	0.386	Ant Main	AWAN
	WLAN5GHz	802.11n 40 MHz	62	5310	HT0	Bottom Face	0.351	11.83	12	98.16	0.372	Ant Main	AWAN
	WLAN5GHz	802.11n 40 MHz	62	5310	HT0	Side 1	0.059	11.83	12	98.16	0.063	Ant Main	AWAN
	WLAN5GHz	802.11n 40 MHz	62	5310	HT0	Side 2	0.261	11.83	12	98.16	0.277	Ant Main	AWAN
	WLAN5GHz	802.11n 40 MHz	62	5310	HT0	Side 3	0.01	11.83	12	98.16	0.011	Ant Main	AWAN
	WLAN5GHz	802.11n 40 MHz	62	5310	HT0	Side 4	0.01	11.83	12	98.16	0.011	Ant Main	AWAN
	WLAN5GHz	802.11n 40 MHz	54	5270	HT0	Bottom of laptop	0.913	11.71	12	98.11	0.995	Ant Aux	South Star
#45	WLAN5GHz	802.11n 40 MHz	62	5310	HT0	Bottom of laptop	0.953	11.85	12	98.11	1.005	Ant Aux	South Star
	WLAN5GHz	802.11n 40 MHz	62	5310	HT0	Bottom Face	0.269	11.85	12	98.11	0.284	Ant Aux	South Star
	WLAN5GHz	802.11n 40 MHz	62	5310	HT0	Side 1	0.033	11.85	12	98.11	0.035	Ant Aux	South Star
	WLAN5GHz	802.11n 40 MHz	62	5310	HT0	Side 2	0.01	11.85	12	98.11	0.011	Ant Aux	South Star
	WLAN5GHz	802.11n 40 MHz	62	5310	HT0	Side 3	0.01	11.85	12	98.11	0.011	Ant Aux	South Star
	WLAN5GHz	802.11n 40 MHz	54	5270	HT0	Side 4	0.326	11.71	12	98.11	0.355	Ant Aux	South Star
	WLAN5GHz	802.11n 40 MHz	62	5310	HT0	Side 4	0.333	11.85	12	98.11	0.351	Ant Aux	South Star



Measurement Results													
Index.	Band	Mode	Frequency		Data Rate	Test Position	SAR _{1g} (W/Kg)	Burst Avg Power (dBm)	Max tune-up (dBm)	Duty Cycle (%)	Reported SAR _{1g}	Note	Antenna
			Ch.	MHz									
	WLAN5GHz	802.11n 40 MHz	54	5270	HT0	Bottom of laptop	0.653	11.71	12	98.11	0.711	Ant Aux	AWAN
	WLAN5GHz	802.11n 40 MHz	62	5310	HT0	Bottom of laptop	0.642	11.85	12	98.11	0.677	Ant Aux	AWAN
	WLAN5GHz	802.11n 40 MHz	62	5310	HT0	Bottom Face	0.201	11.71	12	98.11	0.219	Ant Aux	AWAN
	WLAN5GHz	802.11n 40 MHz	62	5310	HT0	Side 1	0.026	11.85	12	98.11	0.027	Ant Aux	AWAN
	WLAN5GHz	802.11n 40 MHz	62	5310	HT0	Side 2	0.01	11.85	12	98.11	0.011	Ant Aux	AWAN
	WLAN5GHz	802.11n 40 MHz	62	5310	HT0	Side 3	0.01	11.85	12	98.11	0.011	Ant Aux	AWAN
	WLAN5GHz	802.11n 40 MHz	54	5270	HT0	Side 4	0.243	11.85	12	98.11	0.256	Ant Aux	AWAN
	WLAN5GHz	802.11n 40 MHz	62	5310	HT0	Side 4	0.231	11.85	12	98.11	0.244	Ant Aux	AWAN
#57	WLAN5GHz	802.11ac 80 MHz	138	5690	VHT0	Bottom of laptop	0.924	11.44	11.5	94.63	0.990	Ant Main	South Star
	WLAN5GHz	802.11ac 80 MHz	106	5530	VHT0	Bottom of laptop	0.818	11.36	11.5	94.63	0.893	Ant Main	South Star
	WLAN5GHz	802.11ac 80 MHz	122	5610	VHT0	Bottom of laptop	0.722	11.35	11.5	94.63	0.790	Ant Main	South Star
	WLAN5GHz	802.11ac 80 MHz	138	5690	VHT0	Bottom Face	0.233	11.44	11.5	94.63	0.250	Ant Main	South Star
	WLAN5GHz	802.11ac 80 MHz	106	5530	VHT0	Bottom Face	0.332	11.36	11.5	94.63	0.362	Ant Main	South Star
	WLAN5GHz	802.11ac 80 MHz	122	5610	VHT0	Bottom Face	0.224	11.35	11.5	94.63	0.245	Ant Main	South Star
	WLAN5GHz	802.11ac 80 MHz	138	5690	VHT0	Side 1	0.034	11.44	11.5	94.63	0.036	Ant Main	South Star
	WLAN5GHz	802.11ac 80 MHz	138	5690	VHT0	Side 2	0.192	11.44	11.5	94.63	0.206	Ant Main	South Star
	WLAN5GHz	802.11ac 80 MHz	138	5690	VHT0	Side 3	0.01	11.44	11.5	94.63	0.011	Ant Main	South Star
	WLAN5GHz	802.11ac 80 MHz	138	5690	VHT0	Side 4	0.01	11.44	11.5	94.63	0.011	Ant Main	South Star
	WLAN5GHz	802.11ac 80 MHz	138	5690	VHT0	Bottom of laptop	0.792	11.44	11.5	94.63	0.849	Ant Main	AWAN
	WLAN5GHz	802.11ac 80 MHz	106	5530	VHT0	Bottom of laptop	0.701	11.36	11.5	94.63	0.765	Ant Main	AWAN
	WLAN5GHz	802.11ac 80 MHz	122	5610	VHT0	Bottom of laptop	0.618	11.35	11.5	94.63	0.676	Ant Main	AWAN
	WLAN5GHz	802.11ac 80 MHz	138	5690	VHT0	Bottom Face	0.199	11.44	11.5	94.63	0.213	Ant Main	AWAN
	WLAN5GHz	802.11ac 80 MHz	106	5530	VHT0	Bottom Face	0.284	11.36	11.5	94.63	0.310	Ant Main	AWAN
	WLAN5GHz	802.11ac 80 MHz	122	5610	VHT0	Bottom Face	0.192	11.35	11.5	94.63	0.210	Ant Main	AWAN
	WLAN5GHz	802.11ac 80 MHz	138	5690	VHT0	Side 1	0.029	11.44	11.5	94.63	0.031	Ant Main	AWAN
	WLAN5GHz	802.11ac 80 MHz	138	5690	VHT0	Side 2	0.164	11.44	11.5	94.63	0.176	Ant Main	AWAN
	WLAN5GHz	802.11ac 80 MHz	138	5690	VHT0	Side 3	0.01	11.44	11.5	94.63	0.011	Ant Main	AWAN
	WLAN5GHz	802.11ac 80 MHz	138	5690	VHT0	Side 4	0.01	11.44	11.5	94.63	0.011	Ant Main	AWAN



Measurement Results													
Index.	Band	Mode	Frequency		Data Rate	Test Position	SAR _{1g} (W/Kg)	Burst Avg Power (dBm)	Max tune-up (dBm)	Duty Cycle (%)	Reported SAR _{1g}	Note	Antenna
			Ch.	MHz									
#69	WLAN5GHz	802.11ac 80 MHz	138	5690	VHT0	Bottom of laptop	1.02	11.37	11.5	94.57	1.111	Ant Aux	South Star
	WLAN5GHz	802.11ac 80 MHz	106	5530	VHT0	Bottom of laptop	0.623	11.35	11.5	94.57	0.682	Ant Aux	South Star
	WLAN5GHz	802.11ac 80 MHz	122	5610	VHT0	Bottom of laptop	0.762	11.23	11.5	94.57	0.857	Ant Aux	South Star
	WLAN5GHz	802.11ac 80 MHz	138	5690	VHT0	Bottom Face	0.265	11.37	11.5	94.57	0.289	Ant Aux	South Star
	WLAN5GHz	802.11ac 80 MHz	138	5690	VHT0	Side 1	0.052	11.37	11.5	94.57	0.057	Ant Aux	South Star
	WLAN5GHz	802.11ac 80 MHz	138	5690	VHT0	Side 2	0.01	11.37	11.5	94.57	0.011	Ant Aux	South Star
	WLAN5GHz	802.11ac 80 MHz	138	5690	VHT0	Side 3	0.01	11.37	11.5	94.57	0.011	Ant Aux	South Star
	WLAN5GHz	802.11ac 80 MHz	138	5690	VHT0	Side 4	0.33	11.37	11.5	94.57	0.359	Ant Aux	South Star
	WLAN5GHz	802.11ac 80 MHz	106	5530	VHT0	Side 4	0.289	11.35	11.5	94.57	0.316	Ant Aux	South Star
	WLAN5GHz	802.11ac 80 MHz	122	5610	VHT0	Side 4	0.317	11.23	11.5	94.57	0.357	Ant Aux	South Star
	WLAN5GHz	802.11ac 80 MHz	138	5690	VHT0	Bottom of laptop	0.651	11.37	11.5	94.57	0.709	Ant Aux	AWAN
	WLAN5GHz	802.11ac 80 MHz	106	5530	VHT0	Bottom of laptop	0.554	11.35	11.5	94.57	0.606	Ant Aux	AWAN
	WLAN5GHz	802.11ac 80 MHz	122	5610	VHT0	Bottom of laptop	0.612	11.23	11.5	94.57	0.688	Ant Aux	AWAN
	WLAN5GHz	802.11ac 80 MHz	138	5690	VHT0	Bottom Face	0.235	11.37	11.5	94.57	0.256	Ant Aux	AWAN
	WLAN5GHz	802.11ac 80 MHz	138	5690	VHT0	Side 1	0.046	11.37	11.5	94.57	0.050	Ant Aux	AWAN
	WLAN5GHz	802.11ac 80 MHz	138	5690	VHT0	Side 2	0.01	11.37	11.5	94.57	0.011	Ant Aux	AWAN
	WLAN5GHz	802.11ac 80 MHz	138	5690	VHT0	Side 3	0.01	11.37	11.5	94.57	0.011	Ant Aux	AWAN
	WLAN5GHz	802.11ac 80 MHz	138	5690	VHT0	Side 4	0.331	11.37	11.5	94.57	0.360	Ant Aux	AWAN
	WLAN5GHz	802.11ac 80 MHz	106	5530	VHT0	Side 4	0.257	11.35	11.5	94.57	0.281	Ant Aux	AWAN
	WLAN5GHz	802.11ac 80 MHz	122	5610	VHT0	Side 4	0.282	11.23	11.5	94.57	0.317	Ant Aux	AWAN
	WLAN5GHz	802.11ac 80 MHz	155	5775	VHT0	Bottom of laptop	0.643	11.12	11.5	94.63	0.742	Ant Main	South Star
#80	WLAN5GHz	802.11n 40 MHz	159	5795	HT0	Bottom of laptop	0.733	11.15	11.5	98.16	0.810	Ant Main	South Star
	WLAN5GHz	802.11ac 80 MHz	155	5775	VHT0	Bottom Face	0.229	11.12	11.5	94.63	0.264	Ant Main	South Star
	WLAN5GHz	802.11n 40 MHz	159	5795	HT0	Bottom Face	0.291	11.15	11.5	98.16	0.321	Ant Main	South Star
	WLAN5GHz	802.11ac 80 MHz	155	5775	VHT0	Side 1	0.043	11.12	11.5	94.63	0.050	Ant Main	South Star
	WLAN5GHz	802.11ac 80 MHz	155	5775	VHT0	Side 2	0.201	11.12	11.5	94.63	0.232	Ant Main	South Star
	WLAN5GHz	802.11ac 80 MHz	155	5775	VHT0	Side 3	0.01	11.12	11.5	94.63	0.012	Ant Main	South Star
	WLAN5GHz	802.11ac 80 MHz	155	5775	VHT0	Side 4	0.01	11.12	11.5	94.63	0.012	Ant Main	South Star



Measurement Results													
Index.	Band	Mode	Frequency		Data Rate	Test Position	SAR _{1g} (W/Kg)	Burst Avg Power (dBm)	Max tune-up (dBm)	Duty Cycle (%)	Reported SAR _{1g}	Note	Antenna
			Ch.	MHz									
	WLAN5GHz	802.11ac 80 MHz	155	5775	VHT0	Bottom of laptop	0.592	11.12	11.5	94.63	0.683	Ant Main	AWAN
	WLAN5GHz	802.11n 40 MHz	159	5795	HT0	Bottom of laptop	0.618	11.15	11.5	98.16	0.683	Ant Main	AWAN
	WLAN5GHz	802.11ac 80 MHz	155	5775	VHT0	Bottom Face	0.189	11.12	11.5	94.63	0.218	Ant Main	AWAN
	WLAN5GHz	802.11n 40 MHz	159	5795	HT0	Bottom Face	0.243	11.15	11.5	98.16	0.268	Ant Main	AWAN
	WLAN5GHz	802.11ac 80 MHz	155	5775	VHT0	Side 1	0.035	11.12	11.5	94.63	0.040	Ant Main	AWAN
	WLAN5GHz	802.11ac 80 MHz	155	5775	VHT0	Side 2	0.181	11.12	11.5	94.63	0.209	Ant Main	AWAN
	WLAN5GHz	802.11ac 80 MHz	155	5775	VHT0	Side 3	0.01	11.12	11.5	94.63	0.012	Ant Main	AWAN
	WLAN5GHz	802.11ac 80 MHz	155	5775	VHT0	Side 4	0.01	11.12	11.5	94.63	0.012	Ant Main	AWAN
	WLAN5GHz	802.11ac 80 MHz	155	5775	VHT0	Bottom of laptop	0.841	11.04	11.5	94.57	0.988	Ant Aux	South Star
#90	WLAN5GHz	802.11n 40 MHz	159	5795	HT0	Bottom of laptop	0.915	11.09	11.5	98.11	1.025	Ant Aux	South Star
	WLAN5GHz	802.11ac 80 MHz	155	5775	VHT0	Bottom Face	0.261	11.04	11.5	94.57	0.307	Ant Aux	South Star
	WLAN5GHz	802.11ac 80 MHz	155	5775	VHT0	Side 1	0.045	11.04	11.5	94.57	0.053	Ant Aux	South Star
	WLAN5GHz	802.11ac 80 MHz	155	5775	VHT0	Side 2	0.01	11.04	11.5	94.57	0.012	Ant Aux	South Star
	WLAN5GHz	802.11ac 80 MHz	155	5775	VHT0	Side 3	0.01	11.04	11.5	94.57	0.012	Ant Aux	South Star
	WLAN5GHz	802.11ac 80 MHz	155	5775	VHT0	Side 4	0.363	11.09	11.5	94.57	0.422	Ant Aux	South Star
	WLAN5GHz	802.11n 40 MHz	159	5795	HT0	Side 4	0.392	11.09	11.5	98.11	0.439	Ant Aux	South Star
	WLAN5GHz	802.11ac 80 MHz	155	5775	VHT0	Bottom of laptop	0.521	11.04	11.5	94.57	0.612	Ant Aux	AWAN
	WLAN5GHz	802.11n 40 MHz	159	5795	HT0	Bottom of laptop	0.597	11.09	11.5	98.11	0.669	Ant Aux	AWAN
	WLAN5GHz	802.11ac 80 MHz	155	5775	VHT0	Bottom Face	0.172	11.04	11.5	94.57	0.202	Ant Aux	AWAN
	WLAN5GHz	802.11ac 80 MHz	155	5775	VHT0	Side 1	0.032	11.04	11.5	94.57	0.038	Ant Aux	AWAN
	WLAN5GHz	802.11ac 80 MHz	155	5775	VHT0	Side 2	0.01	11.04	11.5	94.57	0.012	Ant Aux	AWAN
	WLAN5GHz	802.11ac 80 MHz	155	5775	VHT0	Side 3	0.01	11.04	11.5	94.57	0.012	Ant Aux	AWAN
	WLAN5GHz	802.11ac 80 MHz	155	5775	VHT0	Side 4	0.219	11.09	11.5	94.57	0.254	Ant Aux	AWAN
	WLAN5GHz	802.11n 40 MHz	159	5795	HT0	Side 4	0.235	11.09	11.5	98.11	0.263	Ant Aux	AWAN



12.2 SAR Variability Measurement

Index.	Band	Mode	Frequency		Data Rate	Test Position	Spacing (mm)	EUT & Accessory	Note	Original SAR _{1g}	First SAR _{1g}
			Ch.	MHz						(W/kg)	(W/kg)
#31	WLAN 2.4GHz	802.11b	1	2412	1 Mbps	Bottom of laptop	0	-	original #5_once	0.819	0.816
#110	WLAN 5GHz	802.11ac 80 MHz	58	5290	VHT0	Bottom of laptop	0	-	original #45_once	0.953	0.932
#111	WLAN 5GHz	802.11ac 80 MHz	138	5690	VHT0	Bottom of laptop	0	-	original #69_once	1.02	0.934
#112	WLAN 5GHz	802.11n 40 MHz	159	5795	HT0	Bottom of laptop	0	-	original #90_once	0.915	0.899

Detailed evaluations please refer KDB 865664 on "SAR test reduction according to KDB" section.

SAR measurement variability must be assessed for each frequency band, which is determined by the SAR probe calibration point and tissue-equivalent medium used for the device measurements. When both head and body tissue-equivalent media are required for SAR measurements in a frequency band, the variability measurement procedures should be applied to the tissue medium with the highest measured SAR, using the highest measured SAR configuration for that tissue-equivalent medium.

The following procedures are applied to determine if repeated measurements are required.

1. The original highest measured Reported SAR_{1g} is ≥ 0.80 W/kg, repeat that measurement once.
2. Perform a second repeated measurement the ratio of largest to smallest SAR for the original and first repeated measurements is < 1.2 , the original or repeated measurement is ≥ 1.45 W/kg (~ 10 % from the 1-g SAR limit).



12.3 SAR Exposure Limit

Human Exposure	Population Uncontrolled Exposure (W/kg)	Occupational Controlled Exposure (W/kg)
Spatial Peak SAR* (head or Body)	1.60	8.00
Spatial Peak SAR** (Whole Body)	0.08	0.40
Spatial Peak SAR*** (Hands / Feet / Ankle / Wrist)	4.00	20.00

Table 2. Safety Limits for Controlled / Uncontrolled Environment Exposure

Notes :

- * The Spatial Peak value of the SAR averaged over any 1 gram of tissue.
(defined as a tissue volume in the shape of a cube) and over the appropriate averaging time.
- ** The Spatial Average value of the SAR averaged over the whole – body.
- *** The Spatial Peak value of the SAR averaged over any 10 grams of tissue.
(defined as a tissue volume in the shape of a cube) and over the appropriate averaging time.

Population / Uncontrolled Environments : are defined as locations where there is the exposure of individuals who have no knowledge or control of their exposure.

Occupational / Controlled Environments : are defined as locations where there is exposure that may be incurred by persons who are aware of the potential for exposure, (i.e. as a result of employment or occupation).

13. References

- [1] Std. C95.1-1999, "American National Standard safety levels with respect to human exposure to radio frequency electromagnetic fields, 300KHz to 100GHz", New York.
- [2] NCRP, National Council on Radiation Protection and Measurements, "Biological Effects and Exposure Criteria for Radio frequency Electromagnetic Fields", NCRP report NO. 86, 1986.
- [3] T. Schmid, O. Egger, and N. Kuster, "Automatic E-field scanning system for dosimetric assessments", IEEE Transactions on Microwave Theory and Techniques, vol. 44, pp, 105-113, Jan. 1996.
- [4] K. Pokovi^c, T. Schmid, and N. Kuster, "Robust setup for precise calibration of E-field probes in tissue simulating liquids at mobile communications frequency", in ICECOM'97, Dubrovnik, October 15-17, 1997, pp.120-124.
- [5] K. Pokovi^c, T. Schmid, and N. Kuster, "E-field probe with improved isotropy in brain simulating liquids", in Proceedings of the ELMAR, Zadar, Croatia, 23-25 June, 1996, pp.172-175.
- [6] N. Kuster, and Q. Balzano, "Energy absorption mechanism by biological bodies in the near field of dipole antennas above 300MHz", IEEE Transaction on Vehicular Technology, vol. 41, no. 1, Feb. 1992, pp. 17-23.
- [7] Robert J. Renka, "Multivariate Interpolation Of Large Sets Of Scattered Data", University of North Texas ACM Transactions on Mathematical Software, vol. 14, no. 2, June 1988 , pp. 139-148.
- [8] N. Kuster, R. Kastle, T. Schmid, Dosimetric evaluation of mobile communications equipment with known precision, IEEE Transaction on Communications, vol. E80-B, no. 5, May 1997, pp. 645-652.
- [9] Std. C95.3-1991, "IEEE Recommended Practice for the Measurement of Potentially Hazardous Electromagnetic Fields – RF and Microwave, New York: IEEE, Aug. 1992.
- [10] CENELEC CLC/SC111B, European Prestandard (prENV 50166-2), Human Exposure to Electromagnetic Fields High-frequency: 10KHz-300GHz, Jan. 1995.
- [11] IEEE Std 1528™-2013 - IEEE Recommended Practice for Determining the Peak Spatial-Average Specific Absorption Rate (SAR) in the Human Head From Wireless Communications Devices: Measurement Techniques

Appendix A - System Performance Check

Test Laboratory: A Test Lab Techno Corp.

Date: 2020/12/24

System Performance Check at 2450MHz_Head

DUT: Dipole 2450 MHz; Type: D2450V2; Serial: D2450V2 - SN:712

Communication System: UID 0, CW (0); Frequency: 2450 MHz; Duty Cycle: 1:1

Medium parameters used: $f = 2450$ MHz; $\sigma = 1.819$ S/m; $\epsilon_r = 39.753$; $\rho = 1000$ kg/m³

Phantom section: Flat Section

Measurement Standard: DASYS (IEEE/IEC/ANSI C63.19-2007)

DASY5.2 Configuration:

- Area Scan setting - Find Secondary Maximum Within: 2.0dB and with a peak SAR value greater than 0.5 W/Kg
- Probe: EX3DV4 - SN3847; ConvF(7.38, 7.38, 7.38) @ 2450 MHz; Calibrated: 2020/5/20
- Sensor-Surface: 1.4mm (Mechanical Surface Detection)
- Electronics: DAE4 Sn541; Calibrated: 2020/3/18
- Phantom: ELI V4.0 (20deg probe tilt); Type: QD OVA 001 BB; Serial: 1036
- Measurement SW: DASYS2, Version 52.10 (3); SEMCAD X Version 14.6.10 (7331)

System Performance Check at 2450MHz/Area Scan (81x81x1): Interpolated grid: dx=1.200 mm, dy=1.200 mm

Maximum value of SAR (interpolated) = 21.0 W/kg

System Performance Check at 2450MHz/Zoom Scan (7x7x7)/Cube 0: Measurement grid: dx=5mm, dy=5mm, dz=5mm

Reference Value = 108.5 V/m; Power Drift = 0.02 dB

Peak SAR (extrapolated) = 26.1 W/kg

SAR(1 g) = 12.6 W/kg; SAR(10 g) = 5.85 W/kg

Smallest distance from peaks to all points 3 dB below = 9 mm

Ratio of SAR at M2 to SAR at M1 = 48.4%

Maximum value of SAR (measured) = 21.0 W/kg

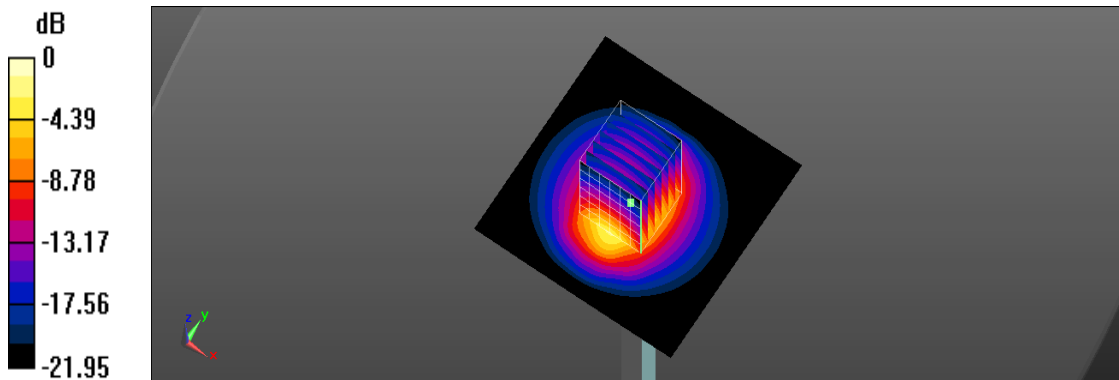

0 dB = 21.0 W/kg = 13.22 dBW/kg

Test Laboratory: A Test Lab Techno Corp.

Date: 2021/2/2

System Performance Check at 2450MHz_Head

DUT: Dipole 2450 MHz; Type: D2450V2; Serial: D2450V2 - SN:712

Communication System: UID 0, CW (0); Frequency: 2450 MHz; Duty Cycle: 1:1

Medium parameters used: $f = 2450$ MHz; $\sigma = 1.809$ S/m; $\epsilon_r = 39.332$; $\rho = 1000$ kg/m³

Phantom section: Flat Section

Measurement Standard: DASYS5 (IEEE/IEC/ANSI C63.19-2007)

DASY5.2 Configuration:

- Area Scan setting - Find Secondary Maximum Within: 2.0dB and with a peak SAR value greater than 0.5 W/Kg
- Probe: EX3DV4 - SN3847; ConvF(7.38, 7.38, 7.38) @ 2450 MHz; Calibrated: 2020/5/20
- Sensor-Surface: 1.4mm (Mechanical Surface Detection)
- Electronics: DAE4 Sn541; Calibrated: 2020/3/18
- Phantom: ELI V4.0 (20deg probe tilt); Type: QD OVA 001 BB; Serial: 1036
- Measurement SW: DASYS52, Version 52.10 (3); SEMCAD X Version 14.6.10 (7331)

System Performance Check at 2450MHz/Area Scan (81x81x1): Interpolated grid: dx=1.200 mm, dy=1.200 mm

Maximum value of SAR (interpolated) = 20.9 W/kg

System Performance Check at 2450MHz/Zoom Scan (7x7x7)/Cube 0: Measurement grid: dx=5mm, dy=5mm, dz=5mm

Reference Value = 108.5 V/m; Power Drift = 0.13 dB

Peak SAR (extrapolated) = 25.9 W/kg

SAR(1 g) = 12.7 W/kg; SAR(10 g) = 5.94 W/kg

Smallest distance from peaks to all points 3 dB below = 9 mm

Ratio of SAR at M2 to SAR at M1 = 48.4%

Maximum value of SAR (measured) = 20.9 W/kg

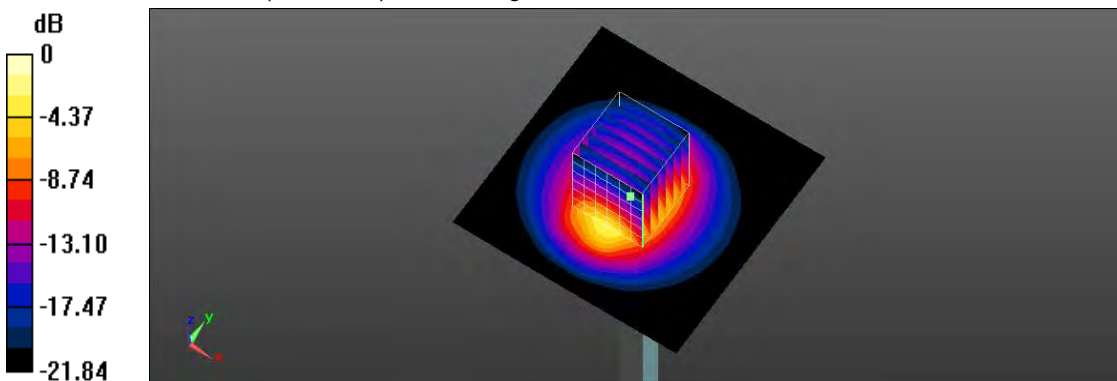

0 dB = 20.9 W/kg = 13.20 dBW/kg

Test Laboratory: A Test Lab Techno Corp.

Date: 2021/2/4

System Performance Check at 5250MHz_Head

DUT: Dipole D5GHzV2; Type: D5GHzV2; Serial: D5GHzV2 - SN:1021

Communication System: UID 0, CW (0); Frequency: 5250 MHz; Duty Cycle: 1:1

Medium parameters used: $f = 5250$ MHz; $\sigma = 4.739$ S/m; $\epsilon_r = 36.858$; $\rho = 1000$ kg/m³

Phantom section: Flat Section

Measurement Standard: DASYS (IEEE/IEC/ANSI C63.19-2007)

DASY5.2 Configuration:

- Area Scan setting - Find Secondary Maximum Within: 2.0dB and with a peak SAR value greater than 0.5 W/Kg
- Probe: EX3DV4 - SN3847; ConvF(5.19, 5.19, 5.19) @ 5250 MHz; Calibrated: 2020/5/20
- Sensor-Surface: 1.4mm (Mechanical Surface Detection)
- Electronics: DAE4 Sn541; Calibrated: 2020/3/18
- Phantom: ELI V4.0 (20deg probe tilt); Type: QD OVA 001 BB; Serial: 1036
- Measurement SW: DASYS2, Version 52.10 (3); SEMCAD X Version 14.6.10 (7331)

System Performance Check at 5250MHz/Area Scan (91x91x1): Interpolated grid: dx=1.000 mm, dy=1.000 mm
Maximum value of SAR (interpolated) = 19.0 W/kg

System Performance Check at 5250MHz/Zoom Scan (7x7x7)/Cube 0: Measurement grid: dx=4mm, dy=4mm, dz=1.4mm

Reference Value = 70.86 V/m; Power Drift = 0.02 dB

Peak SAR (extrapolated) = 32.8 W/kg

SAR(1 g) = 7.79 W/kg; SAR(10 g) = 2.11 W/kg

Smallest distance from peaks to all points 3 dB below = 7.2 mm

Ratio of SAR at M2 to SAR at M1 = 65.3%

Maximum value of SAR (measured) = 20.1 W/kg

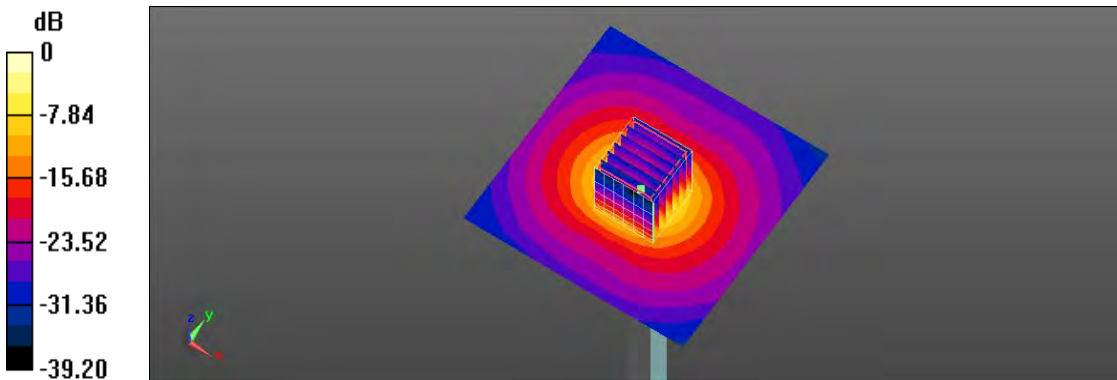

0 dB = 20.1 W/kg = 13.03 dBW/kg

Test Laboratory: A Test Lab Techno Corp.

Date: 2020/12/25

System Performance Check at 5600MHz_Head

DUT: Dipole D5GHzV2; Type: D5GHzV2; Serial: D5GHzV2 - SN:1021

Communication System: UID 0, CW (0); Frequency: 5600 MHz; Duty Cycle: 1:1

Medium parameters used: $f = 5600$ MHz; $\sigma = 5.1$ S/m; $\epsilon_r = 36.051$; $\rho = 1000$ kg/m³

Phantom section: Flat Section

Measurement Standard: DASYS (IEEE/IEC/ANSI C63.19-2007)

DASY5.2 Configuration:

- Area Scan setting - Find Secondary Maximum Within: 2.0dB and with a peak SAR value greater than 0.5 W/Kg
- Probe: EX3DV4 - SN3847; ConvF(4.71, 4.71, 4.71) @ 5600 MHz; Calibrated: 2020/5/20
- Sensor-Surface: 1.4mm (Mechanical Surface Detection)
- Electronics: DAE4 Sn541; Calibrated: 2020/3/18
- Phantom: ELI V4.0 (20deg probe tilt); Type: QD OVA 001 BB; Serial: 1036
- Measurement SW: DASYS2, Version 52.10 (3); SEMCAD X Version 14.6.10 (7331)

System Performance Check at 5600MHz/Area Scan (91x91x1): Interpolated grid: dx=1.000 mm, dy=1.000 mm
Maximum value of SAR (interpolated) = 21.2 W/kg

System Performance Check at 5600MHz/Zoom Scan (7x7x7)/Cube 0: Measurement grid: dx=4mm, dy=4mm, dz=1.4mm

Reference Value = 72.07 V/m; Power Drift = 0.04 dB

Peak SAR (extrapolated) = 36.6 W/kg

SAR(1 g) = 8.59 W/kg; SAR(10 g) = 2.36 W/kg

Smallest distance from peaks to all points 3 dB below = 7.4 mm

Ratio of SAR at M2 to SAR at M1 = 63.4%

Maximum value of SAR (measured) = 21.8 W/kg

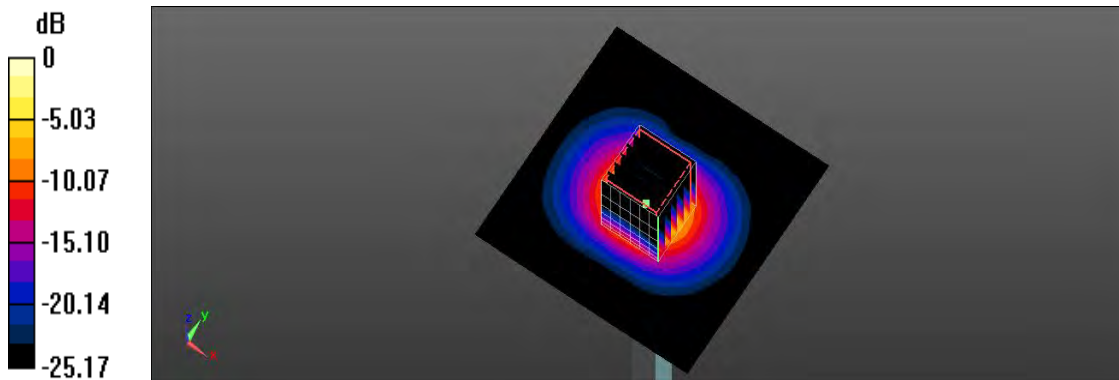

0 dB = 21.8 W/kg = 13.38 dBW/kg

Test Laboratory: A Test Lab Techno Corp.
Date: 2020/12/26
System Performance Check at 5600MHz_Head
DUT: Dipole 5GHzV2; Type: D5GHz; Serial: 1021

Communication System: UID 0, CW (0); Frequency: 5600 MHz; Duty Cycle: 1:1
Medium parameters used: $f = 5600$ MHz; $\sigma = 5.099$ S/m; $\epsilon_r = 35.922$; $\rho = 1000$ kg/m³
Phantom section: Flat Section
Measurement Standard: DASYS (IEEE/IEC/ANSI C63.19-2007)
DASY5.2 Configuration:

- Area Scan setting - Find Secondary Maximum Within: 2.0dB and with a peak SAR value greater than 0.5 W/Kg
- Probe: EX3DV4 - SN3847; ConvF(4.71, 4.71, 4.71) @ 5600 MHz; Calibrated: 2020/5/20
- Sensor-Surface: 1.4mm (Mechanical Surface Detection)
- Electronics: DAE4 Sn541; Calibrated: 2020/3/18
- Phantom: ELI V4.0 (20deg probe tilt); Type: QD OVA 001 BB; Serial: 1036
- Measurement SW: DASYS2, Version 52.10 (3); SEMCAD X Version 14.6.10 (7331)

System Performance Check at 5600MHz/Area Scan (91x91x1): Interpolated grid: dx=1.000 mm, dy=1.000 mm
Maximum value of SAR (interpolated) = 19.2 W/kg

System Performance Check at 5600MHz/Zoom Scan (7x7x7)/Cube 0: Measurement grid: dx=4mm, dy=4mm, dz=1.4mm

Reference Value = 66.31 V/m; Power Drift = 0.07 dB

Peak SAR (extrapolated) = 34.0 W/kg

SAR(1 g) = 8.15 W/kg; SAR(10 g) = 2.26 W/kg

Smallest distance from peaks to all points 3 dB below = 7.4 mm

Ratio of SAR at M2 to SAR at M1 = 63.5%

Maximum value of SAR (measured) = 20.4 W/kg

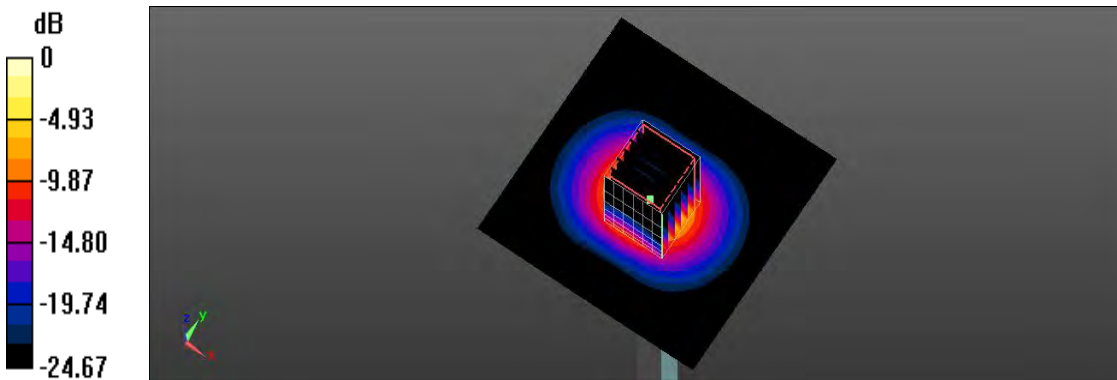

0 dB = 20.4 W/kg = 13.10 dBW/kg

Test Laboratory: A Test Lab Techno Corp.

Date: 2021/2/4

System Performance Check at 5750MHz_Head

DUT: Dipole D5GHzV2; Type: D5GHzV2; Serial: D5GHzV2 - SN:1021

Communication System: UID 0, CW (0); Frequency: 5750 MHz; Duty Cycle: 1:1

Medium parameters used: $f = 5750$ MHz; $\sigma = 5.243$ S/m; $\epsilon_r = 35.897$; $\rho = 1000$ kg/m³

Phantom section: Flat Section

Measurement Standard: DASYS (IEEE/IEC/ANSI C63.19-2007)

DASY5.2 Configuration:

- Area Scan setting - Find Secondary Maximum Within: 2.0dB and with a peak SAR value greater than 0.5 W/Kg
- Probe: EX3DV4 - SN3847; ConvF(4.65, 4.65, 4.65) @ 5750 MHz; Calibrated: 2020/5/20
- Sensor-Surface: 1.4mm (Mechanical Surface Detection)
- Electronics: DAE4 Sn541; Calibrated: 2020/3/18
- Phantom: ELI V4.0 (20deg probe tilt); Type: QD OVA 001 BB; Serial: 1036
- Measurement SW: DASYS2, Version 52.10 (3); SEMCAD X Version 14.6.10 (7331)

System Performance Check at 5750MHz/Area Scan (91x91x1): Interpolated grid: dx=1.000 mm, dy=1.000 mm
Maximum value of SAR (interpolated) = 20.0 W/kg

System Performance Check at 5750MHz/Zoom Scan (7x7x7)/Cube 0: Measurement grid: dx=4mm, dy=4mm, dz=1.4mm

Reference Value = 70.04 V/m; Power Drift = 0.09 dB

Peak SAR (extrapolated) = 35.4 W/kg

SAR(1 g) = 8.17 W/kg; SAR(10 g) = 2.31 W/kg

Smallest distance from peaks to all points 3 dB below = 7.5 mm

Ratio of SAR at M2 to SAR at M1 = 62.4%

Maximum value of SAR (measured) = 20.4 W/kg

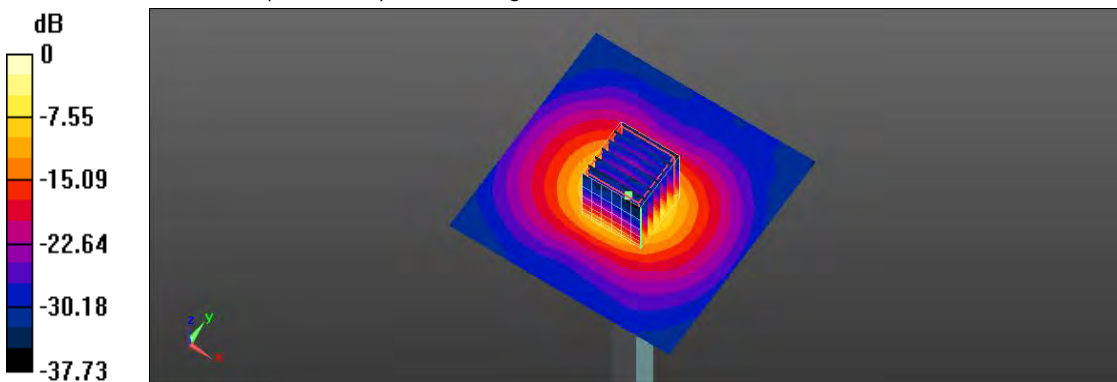

0 dB = 20.4 W/kg = 13.10 dBW/kg

Appendix B - SAR Measurement Data

Test Laboratory: A Test Lab Techno Corp.

Date: 2020/12/24

5_ IEEE 802.11b CH 1_1M_Bottom of laptop_0mm_Ant Main

DUT: QCNFA324; Type: 2x2 802.11A/B/G/N/AC WiFi + Bluetooth Module

Communication System: UID 0, IEEE 802.11b (0); Frequency: 2412 MHz; Duty Cycle: 1:1.007

Medium parameters used: $f = 2412$ MHz; $\sigma = 1.774$ S/m; $\epsilon_r = 39.856$; $\rho = 1000$ kg/m³

Phantom section: Flat Section

Measurement Standard: DASYS (IEEE/IEC/ANSI C63.19-2007)

DASY5.2 Configuration:

- Area Scan setting - Find Secondary Maximum Within: 2.0dB and with a peak SAR value greater than 0.5 W/Kg
- Probe: EX3DV4 - SN3847; ConvF(7.38, 7.38, 7.38) @ 2412 MHz; Calibrated: 2020/5/20
- Sensor-Surface: 1.4mm (Mechanical Surface Detection)
- Electronics: DAE4 Sn541; Calibrated: 2020/3/18
- Phantom: ELI V4.0 (20deg probe tilt); Type: QD OVA 001 BB; Serial: 1036
- Measurement SW: DASY52, Version 52.10 (3); SEMCAD X Version 14.6.10 (7331)

Area Scan (61x61x1): Interpolated grid: dx=1.200 mm, dy=1.200 mm

Maximum value of SAR (interpolated) = 1.44 W/kg

Zoom Scan (7x7x7)/Cube 0: Measurement grid: dx=5mm, dy=5mm, dz=5mm

Reference Value = 23.40 V/m; Power Drift = -0.08 dB

Peak SAR (extrapolated) = 1.92 W/kg

SAR(1 g) = 0.819 W/kg; SAR(10 g) = 0.348 W/kg

Smallest distance from peaks to all points 3 dB below = 8.5 mm

Ratio of SAR at M2 to SAR at M1 = 44.1%

Maximum value of SAR (measured) = 1.49 W/kg

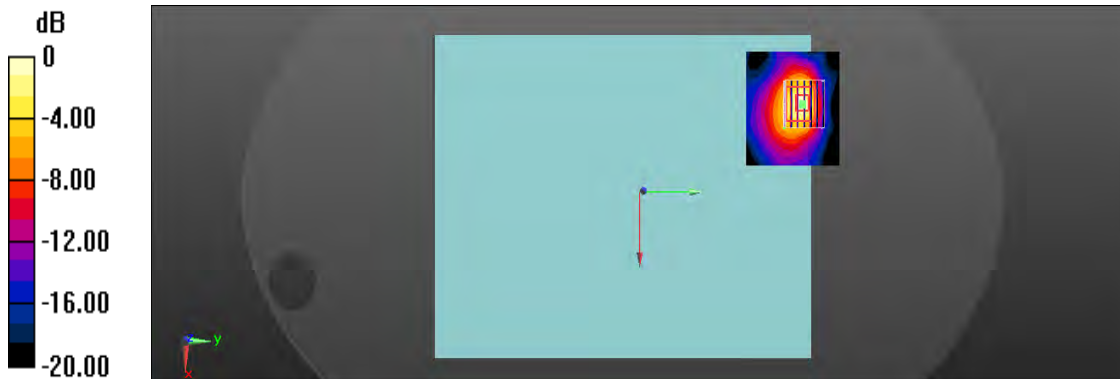

0 dB = 1.49 W/kg = 1.73 dBW/kg

Test Laboratory: A Test Lab Techno Corp.

Date: 2020/12/24

1_ IEEE 802.11b CH 6_ 1M_ Bottom of laptop_ 0mm_ Ant Aux

DUT: QCNFA324; Type: 2x2 802.11A/B/G/N/AC WiFi + Bluetooth Module

Communication System: UID 0, IEEE 802.11b (0); Frequency: 2437 MHz; Duty Cycle: 1:1.007

Medium parameters used (interpolated): $f = 2437$ MHz; $\sigma = 1.803$ S/m; $\epsilon_r = 39.782$; $\rho = 1000$ kg/m³

Phantom section: Flat Section

Measurement Standard: DASYS (IEEE/IEC/ANSI C63.19-2007)

DASY5.2 Configuration:

- Area Scan setting - Find Secondary Maximum Within: 2.0dB and with a peak SAR value greater than 0.5 W/Kg
- Probe: EX3DV4 - SN3847; ConvF(7.38, 7.38, 7.38) @ 2437 MHz; Calibrated: 2020/5/20
- Sensor-Surface: 1.4mm (Mechanical Surface Detection)
- Electronics: DAE4 Sn541; Calibrated: 2020/3/18
- Phantom: ELI V4.0 (20deg probe tilt); Type: QD OVA 001 BB; Serial: 1036
- Measurement SW: DASYS2, Version 52.10 (3); SEMCAD X Version 14.6.10 (7331)

Area Scan (61x61x1): Interpolated grid: dx=1.200 mm, dy=1.200 mm

Maximum value of SAR (interpolated) = 1.24 W/kg

Zoom Scan (7x7x7)/Cube 0: Measurement grid: dx=5mm, dy=5mm, dz=5mm

Reference Value = 23.19 V/m; Power Drift = 0.12 dB

Peak SAR (extrapolated) = 1.65 W/kg

SAR(1 g) = 0.681 W/kg; SAR(10 g) = 0.281 W/kg

Smallest distance from peaks to all points 3 dB below = 8 mm

Ratio of SAR at M2 to SAR at M1 = 44%

Maximum value of SAR (measured) = 1.23 W/kg

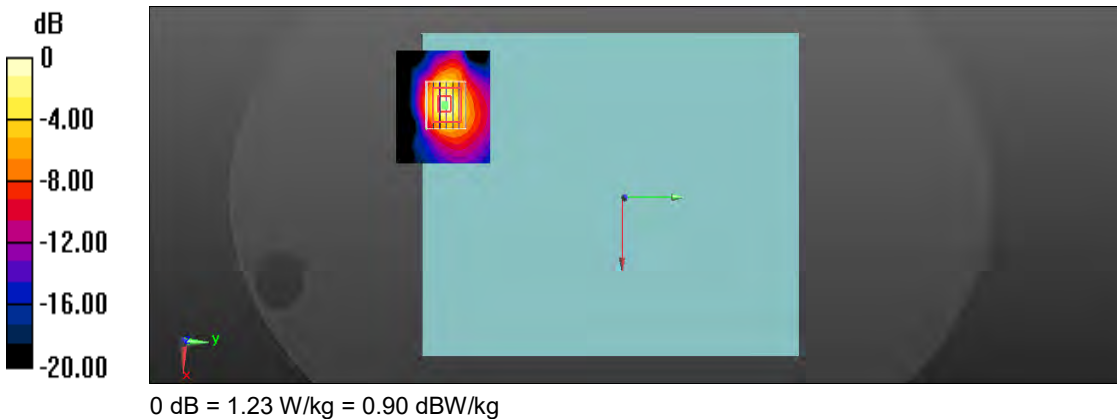

Test Laboratory: A Test Lab Techno Corp.

Date: 2021/2/2

23_Bluetooth CH 78_1M_Bottom of laptop_0mm_Ant Aux

DUT: QCNFA324; Type: 2x2 802.11A/B/G/N/AC WiFi + Bluetooth Module

Communication System: UID 0, Bluetooth (0); Frequency: 2480 MHz; Duty Cycle: 1:1.294

Medium parameters used: $f = 2480$ MHz; $\sigma = 1.841$ S/m; $\epsilon_r = 39.215$; $\rho = 1000$ kg/m³

Phantom section: Flat Section

Measurement Standard: DASYS5 (IEEE/IEC/ANSI C63.19-2007)

DASY5.2 Configuration:

- Area Scan setting - Find Secondary Maximum Within: 2.0dB and with a peak SAR value greater than 0.5 W/Kg
- Probe: EX3DV4 - SN3847; ConvF(7.38, 7.38, 7.38) @ 2480 MHz; Calibrated: 2020/5/20
- Sensor-Surface: 1.4mm (Mechanical Surface Detection)
- Electronics: DAE4 Sn541; Calibrated: 2020/3/18
- Phantom: ELI V4.0 (20deg probe tilt); Type: QD OVA 001 BB; Serial: 1036
- Measurement SW: DASYS52, Version 52.10 (3); SEMCAD X Version 14.6.10 (7331)

Area Scan (61x71x1): Interpolated grid: dx=1.200 mm, dy=1.200 mm

Maximum value of SAR (interpolated) = 0.319 W/kg

Zoom Scan (7x7x7)/Cube 0: Measurement grid: dx=5mm, dy=5mm, dz=5mm

Reference Value = 12.43 V/m; Power Drift = -0.06 dB

Peak SAR (extrapolated) = 0.425 W/kg

SAR(1 g) = 0.169 W/kg; SAR(10 g) = 0.070 W/kg

Smallest distance from peaks to all points 3 dB below = 8.6 mm

Ratio of SAR at M2 to SAR at M1 = 40.7%

Maximum value of SAR (measured) = 0.316 W/kg

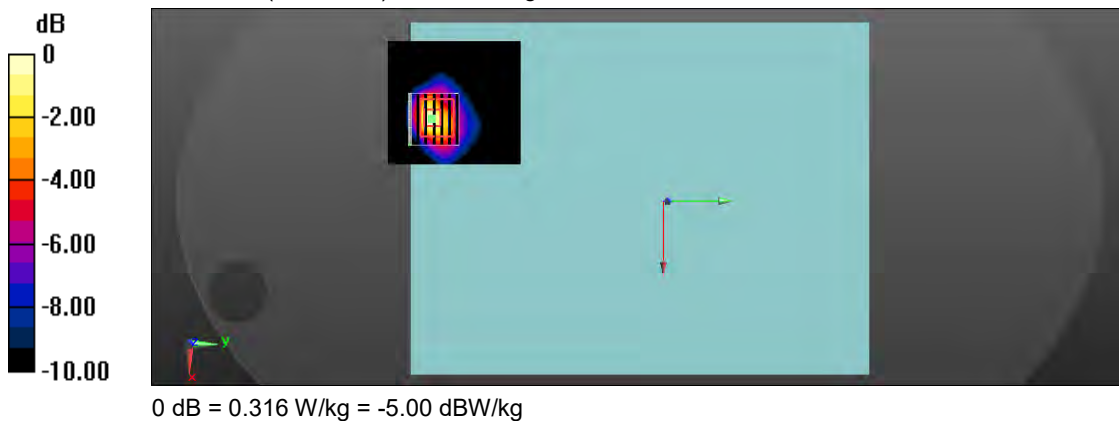

Test Laboratory: A Test Lab Techno Corp.

Date: 2021/2/4

120_IEEE 802.11n 40 CH 62_HT0_Bottom of laptop_0mm_Ant Main

DUT: QCNFA324; Type: 2x2 802.11A/B/G/N/AC WiFi + Bluetooth Module

Communication System: UID 0, IEEE 802.11n(5GHz)HT40 (0); Frequency: 5310 MHz;Duty Cycle: 1:1.019

Medium parameters used: $f = 5310$ MHz; $\sigma = 4.797$ S/m; $\epsilon_r = 36.757$; $\rho = 1000$ kg/m³

Phantom section: Flat Section

Measurement Standard: DASYS5 (IEEE/IEC/ANSI C63.19-2007)

DASY5.2 Configuration:

- Area Scan setting - Find Secondary Maximum Within:2.0dB and with a peak SAR value greater than 0.5 W/Kg
- Probe: EX3DV4 - SN3847; ConvF(5.19, 5.19, 5.19) @ 5310 MHz; Calibrated: 2020/5/20
- Sensor-Surface: 1.4mm (Mechanical Surface Detection)
- Electronics: DAE4 Sn541; Calibrated: 2020/3/18
- Phantom: ELI V4.0 (20deg probe tilt); Type: QD OVA 001 BB; Serial: 1036
- Measurement SW: DASYS2, Version 52.10 (3); SEMCAD X Version 14.6.10 (7331)

Area Scan (71x71x1): Interpolated grid: dx=1.000 mm, dy=1.000 mm

Maximum value of SAR (interpolated) = 2.38 W/kg

Zoom Scan (7x7x7)/Cube 0: Measurement grid: dx=4mm, dy=4mm, dz=1.4mm

Reference Value = 15.94 V/m; Power Drift = -0.05 dB

Peak SAR (extrapolated) = 4.63 W/kg

SAR(1 g) = 0.864 W/kg; SAR(10 g) = 0.223 W/kg

Smallest distance from peaks to all points 3 dB below = 5.7 mm

Ratio of SAR at M2 to SAR at M1 = 59.8%

Maximum value of SAR (measured) = 2.61 W/kg



Test Laboratory: A Test Lab Techno Corp.

Date: 2021/2/4

45_ IEEE 802.11n 40 CH 62_HT0_Bottom of laptop_0mm_Ant Aux

DUT: QCNFA324; Type: 2x2 802.11A/B/G/N/AC WiFi + Bluetooth Module

Communication System: UID 0, IEEE 802.11n(5GHz)HT40 (0); Frequency: 5310 MHz;Duty Cycle: 1:1.019

Medium parameters used: $f = 5310 \text{ MHz}$; $\sigma = 4.797 \text{ S/m}$; $\epsilon_r = 36.757$; $\rho = 1000 \text{ kg/m}^3$

Phantom section: Flat Section

Measurement Standard: DASY5 (IEEE/IEC/ANSI C63.19-2007)

DASY5.2 Configuration:

- Area Scan setting - Find Secondary Maximum Within:2.0dB and with a peak SAR value greater than 0.5 W/Kg
- Probe: EX3DV4 - SN3847; ConvF(5.19, 5.19, 5.19) @ 5310 MHz; Calibrated: 2020/5/20
- Sensor-Surface: 1.4mm (Mechanical Surface Detection)
- Electronics: DAE4 Sn541; Calibrated: 2020/3/18
- Phantom: ELI V4.0 (20deg probe tilt); Type: QD OVA 001 BB; Serial: 1036
- Measurement SW: DASY52, Version 52.10 (3); SEMCAD X Version 14.6.10 (7331)

Area Scan (71x71x1): Interpolated grid: $dx=1.000 \text{ mm}$, $dy=1.000 \text{ mm}$

Maximum value of SAR (interpolated) = 2.42 W/kg

Zoom Scan (7x7x7)/Cube 0: Measurement grid: $dx=4\text{mm}$, $dy=4\text{mm}$, $dz=1.4\text{mm}$

Reference Value = 18.24 V/m; Power Drift = -0.14 dB

Peak SAR (extrapolated) = 4.33 W/kg

SAR(1 g) = 0.953 W/kg; SAR(10 g) = 0.263 W/kg

Smallest distance from peaks to all points 3 dB below = 6.8 mm

Ratio of SAR at M2 to SAR at M1 = 60.1%

Maximum value of SAR (measured) = 2.48 W/kg

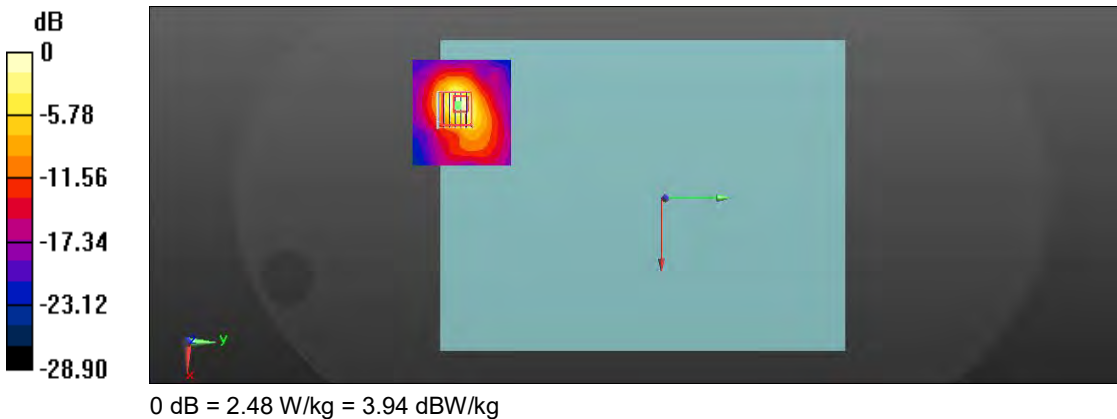

Test Laboratory: A Test Lab Techno Corp.

Date: 2020/12/25

57_ IEEE 802.11ac 80 CH 138_VHT0_Bottom of laptop_0mm_Ant Main

DUT: QCNFA324; Type: 2x2 802.11A/B/G/N/AC WiFi + Bluetooth Module

Communication System: UID 0, IEEE 802.11ac(5GHz)VHT80 (0); Frequency: 5690 MHz;Duty Cycle: 1:1.057

Medium parameters used: $f = 5690$ MHz; $\sigma = 5.189$ S/m; $\epsilon_r = 35.87$; $\rho = 1000$ kg/m³

Phantom section: Flat Section

Measurement Standard: DASYS5 (IEEE/IEC/ANSI C63.19-2007)

DASY5.2 Configuration:

- Area Scan setting - Find Secondary Maximum Within:2.0dB and with a peak SAR value greater than 0.5 W/Kg
- Probe: EX3DV4 - SN3847; ConvF(4.71, 4.71, 4.71) @ 5690 MHz; Calibrated: 2020/5/20
- Sensor-Surface: 1.4mm (Mechanical Surface Detection)
- Electronics: DAE4 Sn541; Calibrated: 2020/3/18
- Phantom: ELI V4.0 (20deg probe tilt); Type: QD OVA 001 BB; Serial: 1036
- Measurement SW: DASYS2, Version 52.10 (3); SEMCAD X Version 14.6.10 (7331)

Area Scan (71x71x1): Interpolated grid: dx=1.000 mm, dy=1.000 mm

Maximum value of SAR (interpolated) = 2.17 W/kg

Zoom Scan (7x7x7)/Cube 0: Measurement grid: dx=4mm, dy=4mm, dz=1.4mm

Reference Value = 12.86 V/m; Power Drift = 0.02 dB

Peak SAR (extrapolated) = 5.13 W/kg

SAR(1 g) = 0.924 W/kg; SAR(10 g) = 0.247 W/kg

Smallest distance from peaks to all points 3 dB below = 6.2 mm

Ratio of SAR at M2 to SAR at M1 = 55.9%

Maximum value of SAR (measured) = 2.66 W/kg

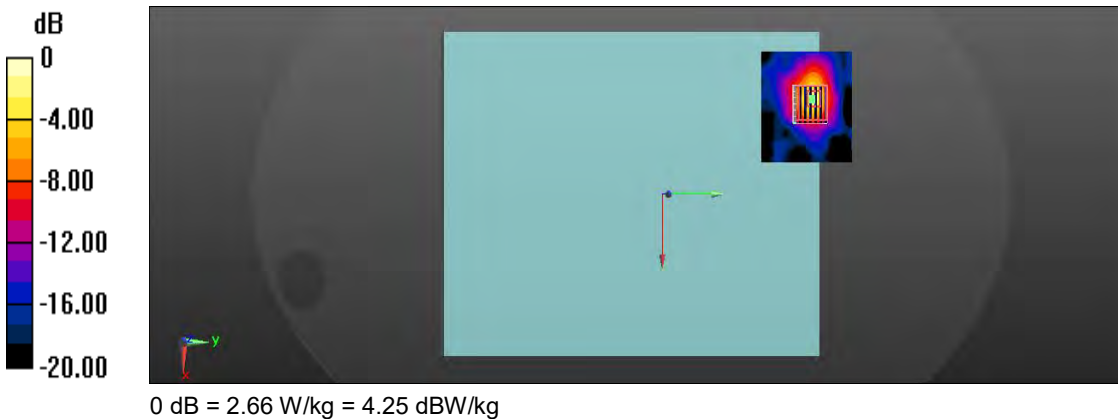

Test Laboratory: A Test Lab Techno Corp.

Date: 2020/12/25

69_ IEEE 802.11ac 80 CH 138_VHT0_Bottom of laptop_0mm_Ant Aux

DUT: QCNFA324; Type: 2x2 802.11A/B/G/N/AC WiFi + Bluetooth Module

Communication System: UID 0, IEEE 802.11ac(5GHz)VHT80 (0); Frequency: 5690 MHz;Duty Cycle: 1:1.057

Medium parameters used: $f = 5690$ MHz; $\sigma = 5.189$ S/m; $\epsilon_r = 35.87$; $\rho = 1000$ kg/m³

Phantom section: Flat Section

Measurement Standard: DASY5 (IEEE/IEC/ANSI C63.19-2007)

DASY5.2 Configuration:

- Area Scan setting - Find Secondary Maximum Within:2.0dB and with a peak SAR value greater than 0.5 W/Kg
- Probe: EX3DV4 - SN3847; ConvF(4.71, 4.71, 4.71) @ 5690 MHz; Calibrated: 2020/5/20
- Sensor-Surface: 1.4mm (Mechanical Surface Detection)
- Electronics: DAE4 Sn541; Calibrated: 2020/3/18
- Phantom: ELI V4.0 (20deg probe tilt); Type: QD OVA 001 BB; Serial: 1036
- Measurement SW: DASY52, Version 52.10 (3); SEMCAD X Version 14.6.10 (7331)

Area Scan (71x71x1): Interpolated grid: dx=1.000 mm, dy=1.000 mm

Maximum value of SAR (interpolated) = 2.63 W/kg

Zoom Scan (7x7x7)/Cube 0: Measurement grid: dx=4mm, dy=4mm, dz=1.4mm

Reference Value = 18.06 V/m; Power Drift = -0.13 dB

Peak SAR (extrapolated) = 5.10 W/kg

SAR(1 g) = 1.02 W/kg; SAR(10 g) = 0.280 W/kg

Smallest distance from peaks to all points 3 dB below = 6.4 mm

Ratio of SAR at M2 to SAR at M1 = 57.8%

Maximum value of SAR (measured) = 2.72 W/kg

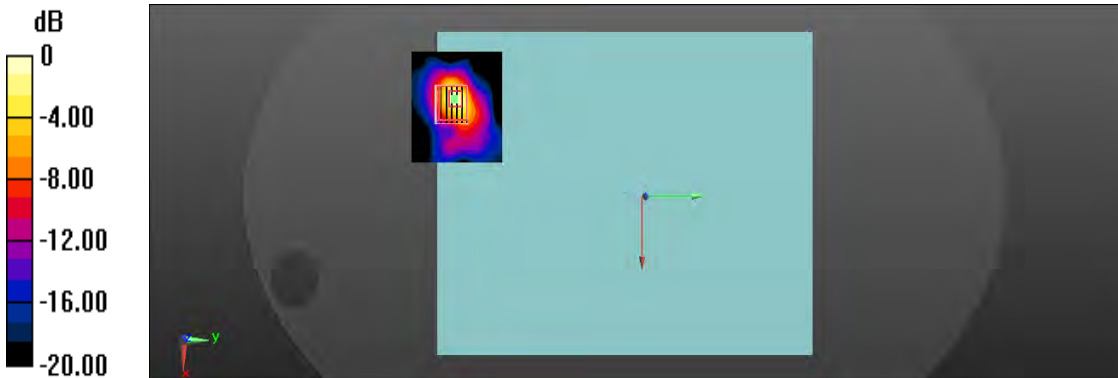

0 dB = 2.72 W/kg = 4.35 dBW/kg

Test Laboratory: A Test Lab Techno Corp.

Date: 2021/2/4

80_ IEEE 802.11n 40 CH 159_HT0_Bottom of laptop_0mm_Ant Main

DUT: QCNFA324; Type: 2x2 802.11A/B/G/N/AC WiFi + Bluetooth Module

Communication System: UID 0, IEEE 802.11n(5GHz)HT40 (0); Frequency: 5795 MHz;Duty Cycle: 1:1.019

Medium parameters used: $f = 5795 \text{ MHz}$; $\sigma = 5.292 \text{ S/m}$; $\epsilon_r = 35.815$; $\rho = 1000 \text{ kg/m}^3$

Phantom section: Flat Section

Measurement Standard: DASYS (IEEE/IEC/ANSI C63.19-2007)

DASY5.2 Configuration:

- Area Scan setting - Find Secondary Maximum Within:2.0dB and with a peak SAR value greater than 0.5 W/Kg
- Probe: EX3DV4 - SN3847; ConvF(4.65, 4.65, 4.65) @ 5795 MHz; Calibrated: 2020/5/20
- Sensor-Surface: 1.4mm (Mechanical Surface Detection)
- Electronics: DAE4 Sn541; Calibrated: 2020/3/18
- Phantom: ELI V4.0 (20deg probe tilt); Type: QD OVA 001 BB; Serial: 1036
- Measurement SW: DASYS2, Version 52.10 (3); SEMCAD X Version 14.6.10 (7331)

Area Scan (71x71x1): Interpolated grid: $dx=1.000 \text{ mm}$, $dy=1.000 \text{ mm}$

Maximum value of SAR (interpolated) = 2.06 W/kg

Zoom Scan (7x7x7)/Cube 0: Measurement grid: $dx=4\text{mm}$, $dy=4\text{mm}$, $dz=1.4\text{mm}$

Reference Value = 14.46 V/m; Power Drift = -0.03 dB

Peak SAR (extrapolated) = 4.18 W/kg

SAR(1 g) = 0.733 W/kg; SAR(10 g) = 0.204 W/kg

Smallest distance from peaks to all points 3 dB below = 6.1 mm

Ratio of SAR at M2 to SAR at M1 = 55.1%

Maximum value of SAR (measured) = 2.10 W/kg

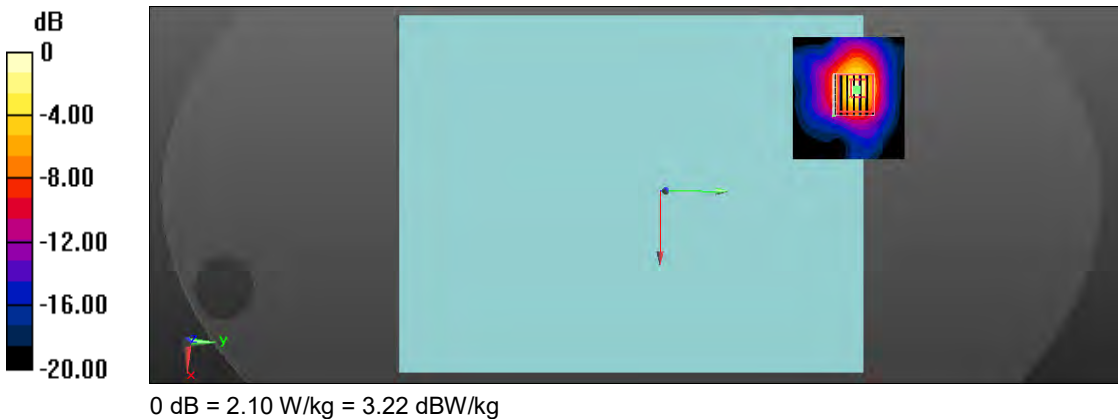

Test Laboratory: A Test Lab Techno Corp.

Date: 2021/2/4

90_ IEEE 802.11n 40 CH 159_HT0_Bottom of laptop_0mm_Ant Aux

DUT: QCNFA324; Type: 2x2 802.11A/B/G/N/AC WiFi + Bluetooth Module

Communication System: UID 0, IEEE 802.11n(5GHz)HT40 (0); Frequency: 5795 MHz;Duty Cycle: 1:1.019

Medium parameters used: $f = 5795 \text{ MHz}$; $\sigma = 5.292 \text{ S/m}$; $\epsilon_r = 35.815$; $\rho = 1000 \text{ kg/m}^3$

Phantom section: Flat Section

Measurement Standard: DASYS (IEEE/IEC/ANSI C63.19-2007)

DASY5.2 Configuration:

- Area Scan setting - Find Secondary Maximum Within:2.0dB and with a peak SAR value greater than 0.5 W/Kg
- Probe: EX3DV4 - SN3847; ConvF(4.65, 4.65, 4.65) @ 5795 MHz; Calibrated: 2020/5/20
- Sensor-Surface: 1.4mm (Mechanical Surface Detection)
- Electronics: DAE4 Sn541; Calibrated: 2020/3/18
- Phantom: ELI V4.0 (20deg probe tilt); Type: QD OVA 001 BB; Serial: 1036
- Measurement SW: DASYS2, Version 52.10 (3); SEMCAD X Version 14.6.10 (7331)

Area Scan (71x71x1): Interpolated grid: $dx=1.000 \text{ mm}$, $dy=1.000 \text{ mm}$

Maximum value of SAR (interpolated) = 2.30 W/kg

Zoom Scan (7x7x7)/Cube 0: Measurement grid: $dx=4\text{mm}$, $dy=4\text{mm}$, $dz=1.4\text{mm}$

Reference Value = 15.37 V/m; Power Drift = -0.16 dB

Peak SAR (extrapolated) = 4.59 W/kg

SAR(1 g) = 0.915 W/kg; SAR(10 g) = 0.260 W/kg

Smallest distance from peaks to all points 3 dB below = 6.2 mm

Ratio of SAR at M2 to SAR at M1 = 58.3%

Maximum value of SAR (measured) = 2.34 W/kg

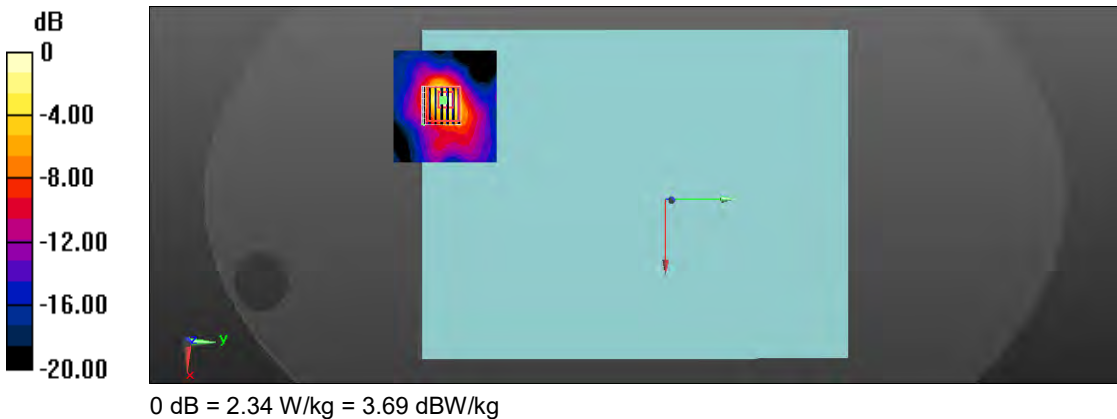



Appendix C - Calibration

All of the instruments Calibration information are listed below.

- Dipole _ D2450V2 SN: 712
- Dipole _ D5GHzV2 SN: 1021
- Probe _ EX3DV4 SN: 3847
- DAE _ DAE4 SN: 541



ST-002_20-072



In Collaboration with
s p e a g
CALIBRATION LABORATORY



中国认可
国际互认
校准
CALIBRATION
CNAS L0570

Add: No.51 Xueyuan Road, Haidian District, Beijing, 100191, China
Tel: +86-10-62304633-2079 Fax: +86-10-62304633-2504
E-mail: cttl@chinattl.com http://www.chinattl.cn

Client **ATL** Certificate No: **Z20-60163**

CALIBRATION CERTIFICATE

Object: **D2450V2 - SN: 712**

Calibration Procedure(s): **FF-Z11-003-01**
Calibration Procedures for dipole validation kits

Calibration date: **April 26, 2020**

This calibration Certificate documents the traceability to national standards, which realize the physical units of measurements(SI). The measurements and the uncertainties with confidence probability are given on the following pages and are part of the certificate.

All calibrations have been conducted in the closed laboratory facility: environment temperature(22±3)°C and humidity<70%.

Calibration Equipment used (M&TE critical for calibration)

Primary Standards	ID #	Cal Date(Calibrated by, Certificate No.)	Scheduled Calibration
Power Meter NRP2	106277	04-Sep-19 (CTTL, No.J19X07825)	Sep-20
Power sensor NRP8S	104291	04-Sep-19 (CTTL, No.J19X07825)	Sep-20
ReferenceProbe EX3DV4	SN 7307	24-May-19(SPEAG,No.EX3-7307_May19)	May-20
DAE4	SN 1555	22-Aug-19(CTTL-SPEAG,No.Z19-60295)	Aug-20
Secondary Standards	ID #	Cal Date(Calibrated by, Certificate No.)	Scheduled Calibration
Signal Generator E4438C	MY49071430	25-Feb-20 (CTTL, No.J20X00516)	Feb-21
NetworkAnalyzer E5071C	MY46110673	10-Feb-20 (CTTL, No.J20X00515)	Feb-21

	Name	Function	Signature
Calibrated by:	Zhao Jing	SAR Test Engineer	
Reviewed by:	Lin Hao	SAR Test Engineer	
Approved by:	Qi Dianyuan	SAR Project Leader	

Issued: April 30, 2020

This calibration certificate shall not be reproduced except in full without written approval of the laboratory.



In Collaboration with
s p e a g
CALIBRATION LABORATORY

Add: No.51 Xueyuan Road, Haidian District, Beijing, 100191, China
Tel: +86-10-62304633-2079 Fax: +86-10-62304633-2504
E-mail: cttl@chinattl.com http://www.chinattl.cn

Glossary:

TSL	tissue simulating liquid
ConvF	sensitivity in TSL / NORM _{x,y,z}
N/A	not applicable or not measured

Calibration is Performed According to the Following Standards:

- IEEE Std 1528-2013, "IEEE Recommended Practice for Determining the Peak Spatial-Averaged Specific Absorption Rate (SAR) in the Human Head from Wireless Communications Devices: Measurement Techniques", June 2013
- IEC 62209-1, "Measurement procedure for assessment of specific absorption rate of human exposure to radio frequency fields from hand-held and body-mounted wireless communication devices- Part 1: Device used next to the ear (Frequency range of 300MHz to 6GHz)", July 2016
- IEC 62209-2, "Procedure to measure the Specific Absorption Rate (SAR) For wireless communication devices used in close proximity to the human body (frequency range of 30MHz to 6GHz)", March 2010
- KDB865664, SAR Measurement Requirements for 100 MHz to 6 GHz

Additional Documentation:

- DASY4/5 System Handbook

Methods Applied and Interpretation of Parameters:

- Measurement Conditions:* Further details are available from the Validation Report at the end of the certificate. All figures stated in the certificate are valid at the frequency indicated.
- Antenna Parameters with TSL:* The dipole is mounted with the spacer to position its feed point exactly below the center marking of the flat phantom section, with the arms oriented parallel to the body axis.
- Feed Point Impedance and Return Loss:* These parameters are measured with the dipole positioned under the liquid filled phantom. The impedance stated is transformed from the measurement at the SMA connector to the feed point. The Return Loss ensures low reflected power. No uncertainty required.
- Electrical Delay:* One-way delay between the SMA connector and the antenna feed point. No uncertainty required.
- SAR measured:* SAR measured at the stated antenna input power.
- SAR normalized:* SAR as measured, normalized to an input power of 1 W at the antenna connector.
- SAR for nominal TSL parameters:* The measured TSL parameters are used to calculate the nominal SAR result.

The reported uncertainty of measurement is stated as the standard uncertainty of Measurement multiplied by the coverage factor $k=2$, which for a normal distribution Corresponds to a coverage probability of approximately 95%.



In Collaboration with
s p e a g
CALIBRATION LABORATORY

Add: No.51 Xueyuan Road, Haidian District, Beijing, 100191, China
Tel: +86-10-62304633-2079 Fax: +86-10-62304633-2504
E-mail: cttl@chinattl.com http://www.chinattl.cn

Measurement Conditions

DASY system configuration, as far as not given on page 1.

DASY Version	DASY52	V52.10.4
Extrapolation	Advanced Extrapolation	
Phantom	Triple Flat Phantom 5.1C	
Distance Dipole Center - TSL	10 mm	with Spacer
Zoom Scan Resolution	dx, dy, dz = 5 mm	
Frequency	2450 MHz ± 1 MHz	

Head TSL parameters

The following parameters and calculations were applied.

	Temperature	Permittivity	Conductivity
Nominal Head TSL parameters	22.0 °C	39.2	1.80 mho/m
Measured Head TSL parameters	(22.0 ± 0.2) °C	39.1 ± 6 %	1.80 mho/m ± 6 %
Head TSL temperature change during test	<1.0 °C	----	----

SAR result with Head TSL

SAR averaged over 1 cm ³ (1 g) of Head TSL	Condition	
SAR measured	250 mW input power	12.8 W/kg
SAR for nominal Head TSL parameters	normalized to 1W	51.2 W/kg ± 18.8 % (k=2)
SAR averaged over 10 cm ³ (10 g) of Head TSL	Condition	
SAR measured	250 mW input power	5.89 W/kg
SAR for nominal Head TSL parameters	normalized to 1W	23.6 W/kg ± 18.7 % (k=2)



In Collaboration with
s p e a g
CALIBRATION LABORATORY

Add: No.51 Xueyuan Road, Haidian District, Beijing, 100191, China
Tel: +86-10-62304633-2079 Fax: +86-10-62304633-2504
E-mail: cttl@chinattl.com http://www.chinattl.cn

Appendix (Additional assessments outside the scope of CNAS L0570)

Antenna Parameters with Head TSL

Impedance, transformed to feed point	52.4Ω+ 3.22 jΩ
Return Loss	- 28.1dB

General Antenna Parameters and Design

Electrical Delay (one direction)	1.024 ns
----------------------------------	----------

After long term use with 100W radiated power, only a slight warming of the dipole near the feedpoint can be measured.

The dipole is made of standard semirigid coaxial cable. The center conductor of the feeding line is directly connected to the second arm of the dipole. The antenna is therefore short-circuited for DC-signals. On some of the dipoles, small end caps are added to the dipole arms in order to improve matching when loaded according to the position as explained in the "Measurement Conditions" paragraph. The SAR data are not affected by this change. The overall dipole length is still according to the Standard. No excessive force must be applied to the dipole arms, because they might bend or the soldered connections near the feedpoint may be damaged.

Additional EUT Data

Manufactured by	SPEAG
-----------------	-------



In Collaboration with
s p e a g
CALIBRATION LABORATORY

Add: No.51 Xueyuan Road, Haidian District, Beijing, 100191, China
Tel: +86-10-62304633-2079 Fax: +86-10-62304633-2504
E-mail: cttl@chinattl.com http://www.chinattl.cn

DASY5 Validation Report for Head TSL

Date: 04.26.2020

Test Laboratory: CTTL, Beijing, China

DUT: Dipole 2450 MHz; Type: D2450V2; Serial: D2450V2 - SN: 712

Communication System: UID 0, CW; Frequency: 2450 MHz; Duty Cycle: 1:1

Medium parameters used: $f = 2450$ MHz; $\sigma = 1.796$ S/m; $\epsilon_r = 39.05$; $\rho = 1000$ kg/m³

Phantom section: Right Section

DASY5 Configuration:

- Probe: EX3DV4 - SN7307; ConvF(7.83, 7.83, 7.83) @ 2450 MHz; Calibrated: 2019-05-24
- Sensor-Surface: 1.4mm (Mechanical Surface Detection)
- Electronics: DAE4 Sn1555; Calibrated: 2019-08-22
- Phantom: MFP_V5.1C (20deg probe tilt); Type: QD 000 P51 Cx; Serial: 1062
- Measurement SW: DASY52, Version 52.10 (4); SEMCAD X Version 14.6.14 (7483)

Dipole Calibration/Zoom Scan (7x7x7) (7x7x7)/Cube 0: Measurement grid: dx=5mm, dy=5mm, dz=5mm

Reference Value = 106.6 V/m; Power Drift = -0.03 dB

Peak SAR (extrapolated) = 27.2 W/kg

SAR(1 g) = 12.8 W/kg; SAR(10 g) = 5.89 W/kg

Smallest distance from peaks to all points 3 dB below = 9 mm

Ratio of SAR at M2 to SAR at M1 = 47.1%

Maximum value of SAR (measured) = 21.8 W/kg

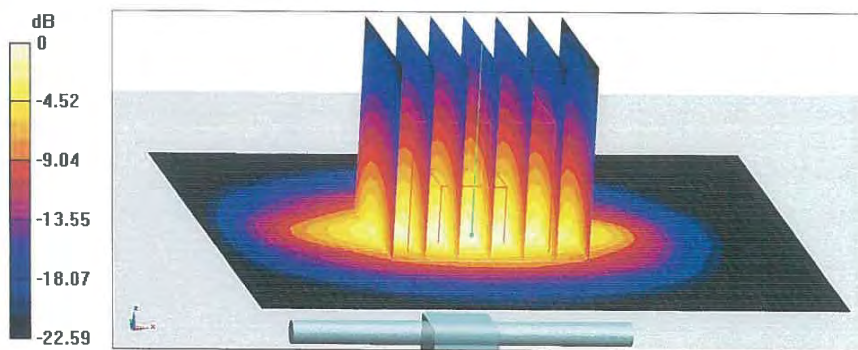

0 dB = 21.8 W/kg = 13.38 dBW/kg



In Collaboration with
s p e a g
CALIBRATION LABORATORY

Add: No.51 Xueyuan Road, Haidian District, Beijing, 100191, China
Tel: +86-10-62304633-2079 Fax: +86-10-62304633-2504
E-mail: cttl@chinattl.com http://www.chinattl.cn

Impedance Measurement Plot for Head TSL

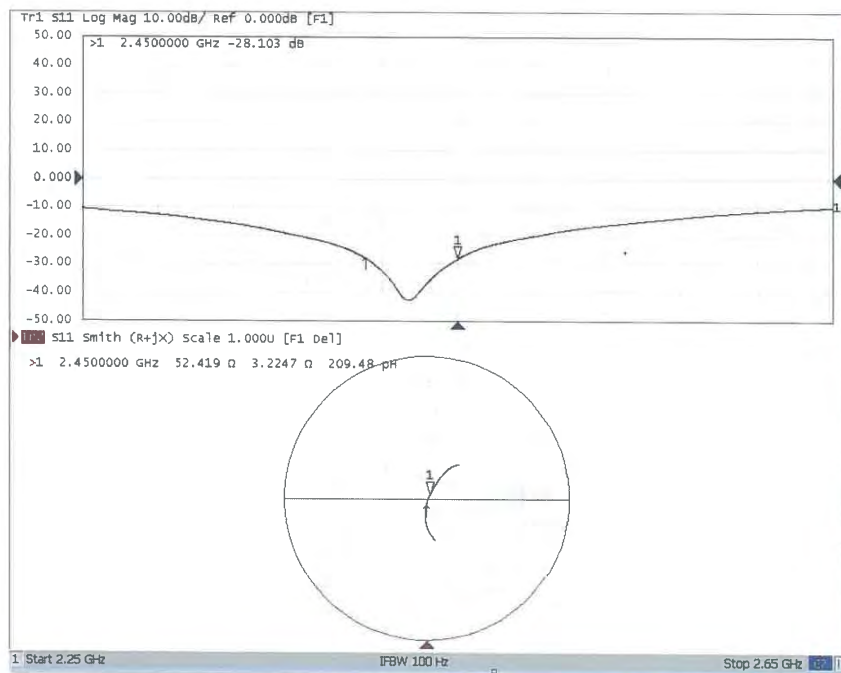



ST-009_20-071

In Collaboration with
TTL **s p e a g**
CALIBRATION LABORATORY

Add: No.51 Xueyuan Road, Haidian District, Beijing, 100191, China
Tel: +86-10-62304633-2512 Fax: +86-10-62304633-2504
E-mail: cttl@chinattl.com http://www.chinattl.cn

CNAS 中国认可
国际互认
校准
CALIBRATION
CNAS L0570

Client **ATL** Certificate No: **Z20-60164**

CALIBRATION CERTIFICATE			
Object	D5GHzV2 - SN: 1021		
Calibration Procedure(s)	FF-Z11-003-01 Calibration Procedures for dipole validation kits		
Calibration date:	April 23, 2020		
<p>This calibration Certificate documents the traceability to national standards, which realize the physical units of measurements(SI). The measurements and the uncertainties with confidence probability are given on the following pages and are part of the certificate.</p> <p>All calibrations have been conducted in the closed laboratory facility: environment temperature(22±3)°C and humidity<70%.</p> <p>Calibration Equipment used (M&TE critical for calibration)</p>			
Primary Standards	ID #	Cal Date(Calibrated by, Certificate No.)	Scheduled Calibration
Power Meter NRP2	106277	04-Sep-19 (CTTL, No.J19X07825)	Sep-20
Power sensor NRP8S	104291	04-Sep-19 (CTTL, No.J19X07825)	Sep-20
ReferenceProbe EX3DV4	SN 7307	24-May-19(SPEAG,No.EX3-7307_May19)	May-20
DAE4	SN 1555	22-Aug-19(CTTL-SPEAG,No.Z19-60295)	Aug-20
Secondary Standards	ID #	Cal Date(Calibrated by, Certificate No.)	Scheduled Calibration
Signal Generator E4438C	MY49071430	25-Feb-20 (CTTL, No.J20X00516)	Feb-21
NetworkAnalyzerE5071C	MY46110673	10-Feb-20 (CTTL, No.J20X00515)	Feb-21
Calibrated by:	Name Zhao Jing	Function SAR Test Engineer	Signature
Reviewed by:	Name Lin Hao	Function SAR Test Engineer	Signature
Approved by:	Name Qi Dianyuan	Function SAR Project Leader	Signature
Issued: April 30, 2020			
This calibration certificate shall not be reproduced except in full without written approval of the laboratory.			



Add: No.51 Xueyuan Road, Haidian District, Beijing, 100191, China
Tel: +86-10-62304633-2512 Fax: +86-10-62304633-2504
E-mail: cttl@chinattl.com http://www.chinattl.cn

Glossary:

TSL	tissue simulating liquid
ConvF	sensitivity in TSL / NORM _{x,y,z}
N/A	not applicable or not measured

Calibration is Performed According to the Following Standards:

- a) IEEE Std 1528-2013, "IEEE Recommended Practice for Determining the Peak Spatial-Averaged Specific Absorption Rate (SAR) in the Human Head from Wireless Communications Devices: Measurement Techniques", June 2013
- b) IEC 62209-1, "Measurement procedure for assessment of specific absorption rate of human exposure to radio frequency fields from hand-held and body-mounted wireless communication devices- Part 1: Device used next to the ear (Frequency range of 300MHz to 6GHz)", July 2016
- c) IEC 62209-2, "Procedure to measure the Specific Absorption Rate (SAR) For wireless communication devices used in close proximity to the human body (frequency range of 30MHz to 6GHz)", March 2010
- d) KDB865664, SAR Measurement Requirements for 100 MHz to 6 GHz

Additional Documentation:

- e) DASy4/5 System Handbook

Methods Applied and Interpretation of Parameters:

- *Measurement Conditions:* Further details are available from the Validation Report at the end of the certificate. All figures stated in the certificate are valid at the frequency indicated.
- *Antenna Parameters with TSL:* The dipole is mounted with the spacer to position its feed point exactly below the center marking of the flat phantom section, with the arms oriented parallel to the body axis.
- *Feed Point Impedance and Return Loss:* These parameters are measured with the dipole positioned under the liquid filled phantom. The impedance stated is transformed from the measurement at the SMA connector to the feed point. The Return Loss ensures low reflected power. No uncertainty required.
- *Electrical Delay:* One-way delay between the SMA connector and the antenna feed point. No uncertainty required.
- *SAR measured:* SAR measured at the stated antenna input power.
- *SAR normalized:* SAR as measured, normalized to an input power of 1 W at the antenna connector.
- *SAR for nominal TSL parameters:* The measured TSL parameters are used to calculate the nominal SAR result.

The reported uncertainty of measurement is stated as the standard uncertainty of Measurement multiplied by the coverage factor $k=2$, which for a normal distribution Corresponds to a coverage probability of approximately 95%.



Add: No.51 Xueyuan Road, Haidian District, Beijing, 100191, China
Tel: +86-10-62304633-2512 Fax: +86-10-62304633-2504
E-mail: cttl@chinattl.com http://www.chinattl.cn

Measurement Conditions

DASY system configuration, as far as not given on page 1.

DASY Version	DASY52	V52.10.4
Extrapolation	Advanced Extrapolation	
Phantom	Triple Flat Phantom 5.1C	
Distance Dipole Center - TSL	10 mm	with Spacer
Zoom Scan Resolution	dx, dy = 4 mm, dz = 1.4 mm	Graded Ratio = 1.4 (Z direction)
Frequency	5250 MHz ± 1 MHz 5600 MHz ± 1 MHz 5750 MHz ± 1 MHz	

Head TSL parameters at 5250 MHz

The following parameters and calculations were applied.

	Temperature	Permittivity	Conductivity
Nominal Head TSL parameters	22.0 °C	35.9	4.71 mho/m
Measured Head TSL parameters	(22.0 ± 0.2) °C	35.9 ± 6 %	4.67 mho/m ± 6 %
Head TSL temperature change during test	<1.0 °C	----	----

SAR result with Head TSL at 5250 MHz

SAR averaged over 1 cm³ (1 g) of Head TSL	Condition	
SAR measured	100 mW input power	7.55 W/kg
SAR for nominal Head TSL parameters	normalized to 1W	75.5 W/kg ± 24.4 % (k=2)
SAR averaged over 10 cm³ (10 g) of Head TSL	Condition	
SAR measured	100 mW input power	2.14 W/kg
SAR for nominal Head TSL parameters	normalized to 1W	21.4 W/kg ± 24.2 % (k=2)



Add: No.51 Xueyuan Road, Haidian District, Beijing, 100191, China
Tel: +86-10-62304633-2512 Fax: +86-10-62304633-2504
E-mail: cttl@chinattl.com http://www.chinattl.cn

Head TSL parameters at 5600 MHz

The following parameters and calculations were applied.

	Temperature	Permittivity	Conductivity
Nominal Head TSL parameters	22.0 °C	35.5	5.07 mho/m
Measured Head TSL parameters	(22.0 ± 0.2) °C	35.3 ± 6 %	5.05 mho/m ± 6 %
Head TSL temperature change during test	<1.0 °C	----	----

SAR result with Head TSL at 5600 MHz

SAR averaged over 1 cm ³ (1 g) of Head TSL	Condition	
SAR measured	100 mW input power	7.97 W/kg
SAR for nominal Head TSL parameters	normalized to 1W	79.6 W/kg ± 24.4 % (k=2)
SAR averaged over 10 cm ³ (10 g) of Head TSL	Condition	
SAR measured	100 mW input power	2.24 W/kg
SAR for nominal Head TSL parameters	normalized to 1W	22.4 W/kg ± 24.2 % (k=2)

Head TSL parameters at 5750 MHz

The following parameters and calculations were applied.

	Temperature	Permittivity	Conductivity
Nominal Head TSL parameters	22.0 °C	35.4	5.22 mho/m
Measured Head TSL parameters	(22.0 ± 0.2) °C	35.1 ± 6 %	5.21 mho/m ± 6 %
Head TSL temperature change during test	<1.0 °C	----	----

SAR result with Head TSL at 5750 MHz

SAR averaged over 1 cm ³ (1 g) of Head TSL	Condition	
SAR measured	100 mW input power	7.62 W/kg
SAR for nominal Head TSL parameters	normalized to 1W	76.0 W/kg ± 24.4 % (k=2)
SAR averaged over 10 cm ³ (10 g) of Head TSL	Condition	
SAR measured	100 mW input power	2.14 W/kg
SAR for nominal Head TSL parameters	normalized to 1W	21.3 W/kg ± 24.2 % (k=2)



Add: No.51 Xueyuan Road, Haidian District, Beijing, 100191, China
Tel: +86-10-62304633-2512 Fax: +86-10-62304633-2504
E-mail: cttl@chinattl.com http://www.chinattl.cn

Appendix (Additional assessments outside the scope of CNAS L0570)

Antenna Parameters with Head TSL at 5250 MHz

Impedance, transformed to feed point	52.9Ω - 3.93jΩ
Return Loss	- 26.5dB

Antenna Parameters with Head TSL at 5600 MHz

Impedance, transformed to feed point	56.8Ω + 0.21jΩ
Return Loss	- 23.9dB

Antenna Parameters with Head TSL at 5750 MHz

Impedance, transformed to feed point	55.6Ω + 2.86jΩ
Return Loss	- 24.5dB

General Antenna Parameters and Design

Electrical Delay (one direction)	1.067 ns
----------------------------------	----------

After long term use with 100W radiated power, only a slight warming of the dipole near the feedpoint can be measured.

The dipole is made of standard semirigid coaxial cable. The center conductor of the feeding line is directly connected to the second arm of the dipole. The antenna is therefore short-circuited for DC-signals. On some of the dipoles, small end caps are added to the dipole arms in order to improve matching when loaded according to the position as explained in the "Measurement Conditions" paragraph. The SAR data are not affected by this change. The overall dipole length is still according to the Standard. No excessive force must be applied to the dipole arms, because they might bend or the soldered connections near the feedpoint may be damaged.

Additional EUT Data

Manufactured by	SPEAG
-----------------	-------



Add: No.51 Xueyuan Road, Haidian District, Beijing, 100191, China
Tel: +86-10-62304633-2512 Fax: +86-10-62304633-2504
E-mail: cttl@chinattl.com http://www.chinattl.cn

DASY5 Validation Report for Head TSL

Date: 04.23.2020

Test Laboratory: CTTL, Beijing, China

DUT: Dipole 5GHz; Type: D5GHzV2; Serial: D5GHzV2 - SN: 1021

Communication System: CW; Frequency: 5250 MHz, Frequency: 5600 MHz,
Frequency: 5750 MHz,

Medium parameters used: $f = 5250$ MHz; $\sigma = 4.671$ S/m; $\epsilon_r = 35.88$; $\rho = 1000$ kg/m³,
Medium parameters used: $f = 5600$ MHz; $\sigma = 5.048$ S/m; $\epsilon_r = 35.28$; $\rho = 1000$ kg/m³,
Medium parameters used: $f = 5750$ MHz; $\sigma = 5.211$ S/m; $\epsilon_r = 35.06$; $\rho = 1000$ kg/m³,

Phantom section: Center Section

DASY5 Configuration:

- Probe: EX3DV4 - SN7307; ConvF(5.61, 5.61, 5.61) @ 5250 MHz; ConvF(5.12, 5.12, 5.12) @ 5600 MHz; ConvF(5.15, 5.15, 5.15) @ 5750 MHz; Calibrated: 2019-05-24
- Sensor-Surface: 1.4mm (Mechanical Surface Detection)
- Electronics: DAE4 Sn1555; Calibrated: 2019-08-22
- Phantom: MFP_V5.1C (20deg probe tilt); Type: QD 000 P51 Cx; Serial: 1062
- Measurement SW: DASY52, Version 52.10 (4); SEMCAD X Version 14.6.14 (7483)

Dipole Calibration /Pin=100mW, d=10mm, f=5250 MHz/Zoom Scan, dist=1.4mm (8x8x7)/Cube 0: Measurement grid: dx=4mm, dy=4mm, dz=1.4mm
Reference Value = 70.74 V/m; Power Drift = -0.03 dB
Peak SAR (extrapolated) = 32.5 W/kg
SAR(1 g) = 7.55 W/kg; SAR(10 g) = 2.14 W/kg
Smallest distance from peaks to all points 3 dB below = 7.4 mm
Ratio of SAR at M2 to SAR at M1 = 63.5%
Maximum value of SAR (measured) = 18.6 W/kg

Dipole Calibration /Pin=100mW, d=10mm, f=5600 MHz/Zoom Scan, dist=1.4mm (8x8x7)/Cube 0: Measurement grid: dx=4mm, dy=4mm, dz=1.4mm
Reference Value = 70.28 V/m; Power Drift = -0.02 dB
Peak SAR (extrapolated) = 37.3 W/kg
SAR(1 g) = 7.97 W/kg; SAR(10 g) = 2.24 W/kg
Smallest distance from peaks to all points 3 dB below = 7.4 mm
Ratio of SAR at M2 to SAR at M1 = 60.6%
Maximum value of SAR (measured) = 20.2 W/kg



Add: No.51 Xueyuan Road, Haidian District, Beijing, 100191, China
Tel: +86-10-62304633-2512 Fax: +86-10-62304633-2504
E-mail: cttl@chinattl.com http://www.chinattl.cn

Dipole Calibration /Pin=100mW, d=10mm, f=5750 MHz/Zoom Scan,
dist=1.4mm (8x8x7)/Cube 0: Measurement grid: dx=4mm, dy=4mm, dz=1.4mm
Reference Value = 68.29 V/m; Power Drift = 0.01 dB
Peak SAR (extrapolated) = 36.8 W/kg
SAR(1 g) = 7.62 W/kg; SAR(10 g) = 2.14 W/kg
Smallest distance from peaks to all points 3 dB below = 7.4 mm
Ratio of SAR at M2 to SAR at M1 = 59.5%
Maximum value of SAR (measured) = 19.2 W/kg

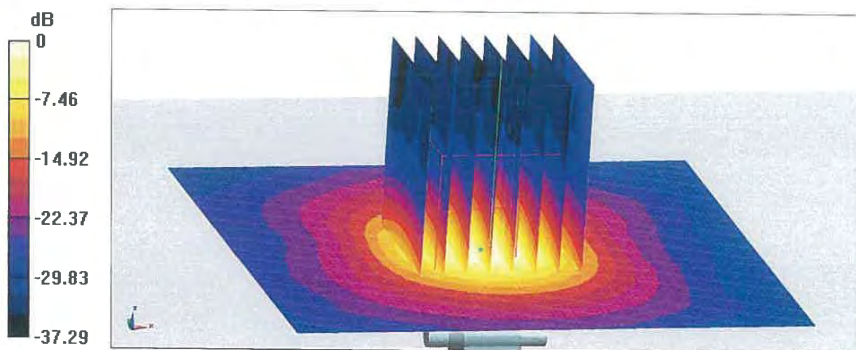

0 dB = 19.2 W/kg = 12.83 dBW/kg



Add: No.51 Xueyuan Road, Haidian District, Beijing, 100191, China
Tel: +86-10-62304633-2512 Fax: +86-10-62304633-2504
E-mail: cttl@chinattl.com http://www.chinattl.cn

Impedance Measurement Plot for Head TSL

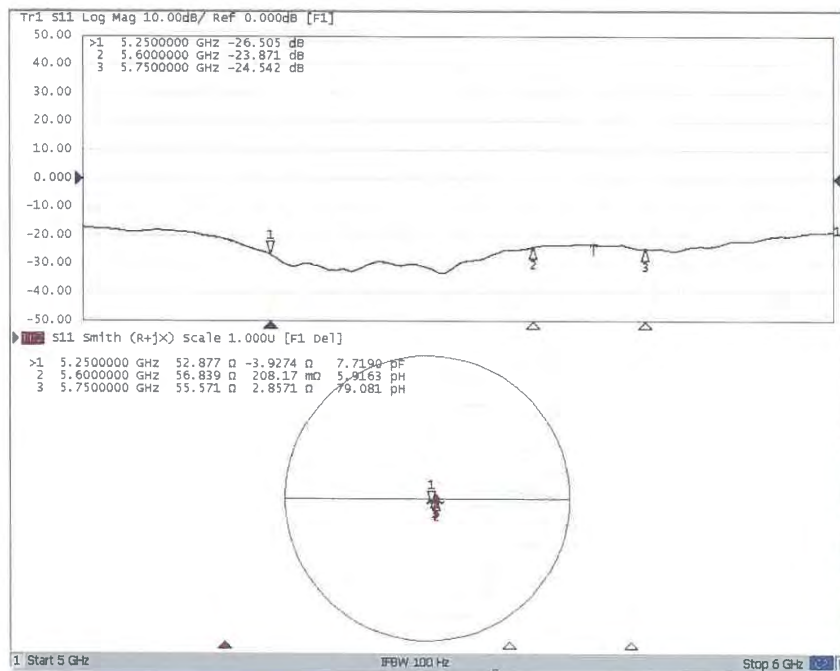



Add: No.51 Xueyuan Road, Haidian District, Beijing, 100191, China
Tel: +86-10-62304633-2512 Fax: +86-10-62304633-2504
E-mail: cttl@chinattl.com Http://www.chinattl.cn



中国认可
国际互认
校准
CALIBRATION
CNAS L0570

EX-042-20-107

Client **ATL**

Certificate No: **Z20-60165**

CALIBRATION CERTIFICATE

Object **EX3DV4 - SN : 3847**

Calibration Procedure(s) **FF-Z11-004-01
Calibration Procedures for Dosimetric E-field Probes**

Calibration date: **May 20, 2020**

This calibration Certificate documents the traceability to national standards, which realize the physical units of measurements(SI). The measurements and the uncertainties with confidence probability are given on the following pages and are part of the certificate.

All calibrations have been conducted in the closed laboratory facility: environment temperature(22±3)°C and humidity<70%.

Calibration Equipment used (M&TE critical for calibration)

Primary Standards	ID #	Cal Date(Calibrated by, Certificate No.)	Scheduled Calibration
Power Meter NRP2	101919	18-Jun-19(CTTL, No.J19X05125)	Jun-20
Power sensor NRP-Z91	101547	18-Jun-19(CTTL, No.J19X05125)	Jun-20
Power sensor NRP-Z91	101548	18-Jun-19(CTTL, No.J19X05125)	Jun-20
Reference 10dBAttenuator	18N50W-10dB	10-Feb-20(CTTL, No.J20X00525)	Feb-22
Reference 20dBAttenuator	18N50W-20dB	10-Feb-20(CTTL, No.J20X00526)	Feb-22
Reference Probe EX3DV4	SN 3617	30-Jan-20(SPEAG, No.EX3-3617_Jan20/2)	Jan-21
DAE4	SN 1556	4-Feb-20(SPEAG, No.DAE4-1556_Feb20)	Feb-21
Secondary Standards	ID #	Cal Date(Calibrated by, Certificate No.)	Scheduled Calibration
SignalGenerator MG3700A	6201052605	18-Jun-19(CTTL, No.J19X05127)	Jun-20
Network Analyzer E5071C	MY46110673	10-Feb-20(CTTL, No.J20X00515)	Feb-21

	Name	Function	Signature
Calibrated by:	Yu Zongying	SAR Test Engineer	
Reviewed by:	Lin Hao	SAR Test Engineer	
Approved by:	Qi Dianyuan	SAR Project Leader	

Issued: May 22, 2020

This calibration certificate shall not be reproduced except in full without written approval of the laboratory.



Add: No.51 Xueyuan Road, Haidian District, Beijing, 100191, China
Tel: +86-10-62304633-2512 Fax: +86-10-62304633-2504
E-mail: cttl@chinattl.com [Http://www.chinattl.cn](http://www.chinattl.cn)

Glossary:

TSL	tissue simulating liquid
NORM _{x,y,z}	sensitivity in free space
ConvF	sensitivity in TSL / NORM _{x,y,z}
DCP	diode compression point
CF	crest factor (1/duty_cycle) of the RF signal
A,B,C,D	modulation dependent linearization parameters
Polarization Φ	Φ rotation around probe axis
Polarization θ	θ rotation around an axis that is in the plane normal to probe axis (at measurement center), $\theta=0$ is normal to probe axis

Connector Angle information used in DASY system to align probe sensor X to the robot coordinate system

Calibration is Performed According to the Following Standards:

- IEEE Std 1528-2013, "IEEE Recommended Practice for Determining the Peak Spatial-Averaged Specific Absorption Rate (SAR) in the Human Head from Wireless Communications Devices: Measurement Techniques", June 2013
- IEC 62209-1, "Measurement procedure for the assessment of Specific Absorption Rate (SAR) from hand-held and body-mounted devices used next to the ear (frequency range of 300 MHz to 6 GHz)", July 2016
- IEC 62209-2, "Procedure to determine the Specific Absorption Rate (SAR) for wireless communication devices used in close proximity to the human body (frequency range of 30 MHz to 6 GHz)", March 2010
- KDB 865664, "SAR Measurement Requirements for 100 MHz to 6 GHz"

Methods Applied and Interpretation of Parameters:

- NORM_{x,y,z}*: Assessed for E-field polarization $\theta=0$ ($f \leq 900$ MHz in TEM-cell; $f > 1800$ MHz: waveguide). *NORM_{x,y,z}* are only intermediate values, i.e., the uncertainties of *NORM_{x,y,z}* does not effect the E^2 -field uncertainty inside TSL (see below ConvF).
- NORM(f)_{x,y,z}* = *NORM_{x,y,z}* * *frequency_response* (see Frequency Response Chart). This linearization is implemented in DASY4 software versions later than 4.2. The uncertainty of the frequency response is included in the stated uncertainty of ConvF.
- DCP_{x,y,z}*: DCP are numerical linearization parameters assessed based on the data of power sweep (no uncertainty required). DCP does not depend on frequency nor media.
- PAR: PAR is the Peak to Average Ratio that is not calibrated but determined based on the signal characteristics.
- A_{x,y,z}*; *B_{x,y,z}*; *C_{x,y,z}*; *VR_{x,y,z}*; *A,B,C* are numerical linearization parameters assessed based on the data of power sweep for specific modulation signal. The parameters do not depend on frequency nor media. VR is the maximum calibration range expressed in RMS voltage across the diode.
- ConvF* and *Boundary Effect Parameters*: Assessed in flat phantom using E-field (or Temperature Transfer Standard for $f \leq 800$ MHz) and inside waveguide using analytical field distributions based on power measurements for $f > 800$ MHz. The same setups are used for assessment of the parameters applied for boundary compensation (alpha, depth) of which typical uncertainty valued are given. These parameters are used in DASY4 software to improve probe accuracy close to the boundary. The sensitivity in TSL corresponds to *NORM_{x,y,z}* * ConvF whereby the uncertainty corresponds to that given for ConvF. A frequency dependent ConvF is used in DASY version 4.4 and higher which allows extending the validity from ± 50 MHz to ± 100 MHz.
- Spherical isotropy (3D deviation from isotropy)*: in a field of low gradients realized using a flat phantom exposed by a patch antenna.
- Sensor Offset*: The sensor offset corresponds to the offset of virtual measurement center from the probe tip (on probe axis). No tolerance required.
- Connector Angle*: The angle is assessed using the information gained by determining the *NORM_x* (no uncertainty required).



Add: No.51 Xueyuan Road, Haidian District, Beijing, 100191, China
Tel: +86-10-62304633-2512 Fax: +86-10-62304633-2504
E-mail: cttl@chinattl.com [Http://www.chinattl.cn](http://www.chinattl.cn)

DASY/EASY – Parameters of Probe: EX3DV4 – SN:3847

Basic Calibration Parameters

	Sensor X	Sensor Y	Sensor Z	Unc (k=2)
Norm($\mu\text{V}/(\text{V}/\text{m})^2$) ^A	0.56	0.50	0.44	±10.0%
DCP(mV) ^B	98.7	99.2	102.8	

Modulation Calibration Parameters

UID	Communication System Name		A dB	B dB μV	C	D dB	VR mV	Unc ^E (k=2)
0	CW	X	0.0	0.0	1.0	0.00	172.6	±2.1%
		Y	0.0	0.0	1.0		166.4	
		Z	0.0	0.0	1.0		151.0	

The reported uncertainty of measurement is stated as the standard uncertainty of Measurement multiplied by the coverage factor $k=2$, which for a normal distribution Corresponds to a coverage probability of approximately 95%.

^A The uncertainties of Norm X, Y, Z do not affect the E^2 -field uncertainty inside TSL (see Page 4).

^B Numerical linearization parameter: uncertainty not required.

^E Uncertainly is determined using the max. deviation from linear response applying rectangular distribution and is expressed for the square of the field value.



Add: No.51 Xueyuan Road, Haidian District, Beijing, 100191, China
Tel: +86-10-62304633-2512 Fax: +86-10-62304633-2504
E-mail: cttl@chinattl.com [Http://www.chinattl.cn](http://www.chinattl.cn)

DASY/EASY – Parameters of Probe: EX3DV4 – SN:3847

Calibration Parameter Determined in Head Tissue Simulating Media

f [MHz] ^C	Relative Permittivity ^F	Conductivity (S/m) ^F	ConvF X	ConvF Y	ConvF Z	Alpha ^G	Depth ^G (mm)	Unct. (k=2)
750	41.9	0.89	9.54	9.54	9.54	0.40	0.80	±12.1%
835	41.5	0.90	9.26	9.26	9.26	0.13	1.41	±12.1%
900	41.5	0.97	9.30	9.30	9.30	0.27	0.94	±12.1%
1450	40.5	1.20	8.35	8.35	8.35	0.30	0.83	±12.1%
1750	40.1	1.37	8.14	8.14	8.14	0.22	1.11	±12.1%
1810	40.0	1.40	7.96	7.96	7.96	0.22	1.07	±12.1%
1900	40.0	1.40	7.78	7.78	7.78	0.22	1.17	±12.1%
2000	40.0	1.40	7.86	7.86	7.86	0.19	1.23	±12.1%
2300	39.5	1.67	7.57	7.57	7.57	0.51	0.71	±12.1%
2450	39.2	1.80	7.38	7.38	7.38	0.55	0.72	±12.1%
2600	39.0	1.96	7.20	7.20	7.20	0.63	0.69	±12.1%
3300	38.2	2.71	6.79	6.79	6.79	0.43	0.96	±13.3%
3500	37.9	2.91	6.74	6.74	6.74	0.48	0.90	±13.3%
3700	37.7	3.12	6.52	6.52	6.52	0.46	0.93	±13.3%
3900	37.5	3.32	6.43	6.43	6.43	0.40	1.15	±13.3%
4100	37.2	3.53	6.29	6.29	6.29	0.40	1.20	±13.3%
4200	37.1	3.63	6.20	6.20	6.20	0.40	1.20	±13.3%
4400	36.9	3.84	6.06	6.06	6.06	0.40	1.20	±13.3%
4600	36.7	4.04	6.00	6.00	6.00	0.55	1.01	±13.3%
4800	36.4	4.25	5.95	5.95	5.95	0.55	1.11	±13.3%
4950	36.3	4.40	5.80	5.80	5.80	0.55	1.11	±13.3%
5250	35.9	4.71	5.19	5.19	5.19	0.50	1.20	±13.3%
5600	35.5	5.07	4.71	4.71	4.71	0.55	1.23	±13.3%
5750	35.4	5.22	4.65	4.65	4.65	0.60	1.20	±13.3%

^C Frequency validity above 300 MHz of ±100MHz only applies for DASY v4.4 and higher (Page 2), else it is restricted to ±50MHz. The uncertainty is the RSS of ConvF uncertainty at calibration frequency and the uncertainty for the indicated frequency band. Frequency validity below 300 MHz is ± 10, 25, 40, 50 and 70 MHz for ConvF assessments at 30, 64, 128, 150 and 220 MHz respectively. Above 5 GHz frequency validity can be extended to ± 110 MHz.

^F At frequency below 3 GHz, the validity of tissue parameters (ϵ and σ) can be relaxed to ±10% if liquid compensation formula is applied to measured SAR values. At frequencies above 3 GHz, the validity of tissue parameters (ϵ and σ) is restricted to ±5%. The uncertainty is the RSS of the ConvF uncertainty for indicated target tissue parameters.

^G Alpha/Depth are determined during calibration. SPEAG warrants that the remaining deviation due to the boundary effect after compensation is always less than ± 1% for frequencies below 3 GHz and below ± 2% for the frequencies between 3-6 GHz at any distance larger than half the probe tip diameter from the boundary.



Add: No.51 Xueyuan Road, Haidian District, Beijing, 100191, China
Tel: +86-10-62304633-2512 Fax: +86-10-62304633-2504
E-mail: cttl@chinattl.com [Http://www.chinattl.cn](http://www.chinattl.cn)

Frequency Response of E-Field (TEM-Cell: ifi110 EXX, Waveguide: R22)

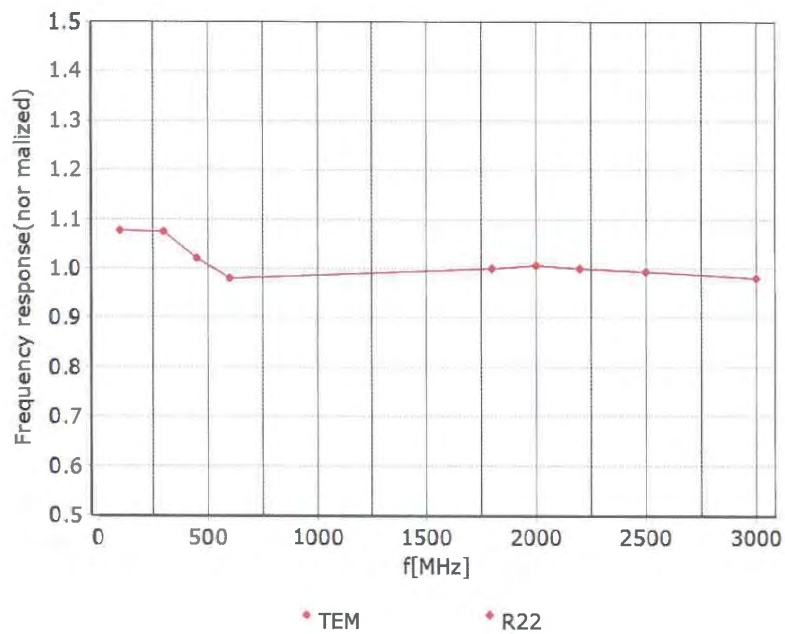

Uncertainty of Frequency Response of E-field: $\pm 7.4\%$ ($k=2$)



Add: No.51 Xueyuan Road, Haidian District, Beijing, 100191, China
Tel: +86-10-62304633-2512 Fax: +86-10-62304633-2504
E-mail: cttl@chinattl.com [Http://www.chinattl.cn](http://www.chinattl.cn)

Receiving Pattern (Φ), $\theta=0^\circ$

f=600 MHz, TEM

f=1800 MHz, R22

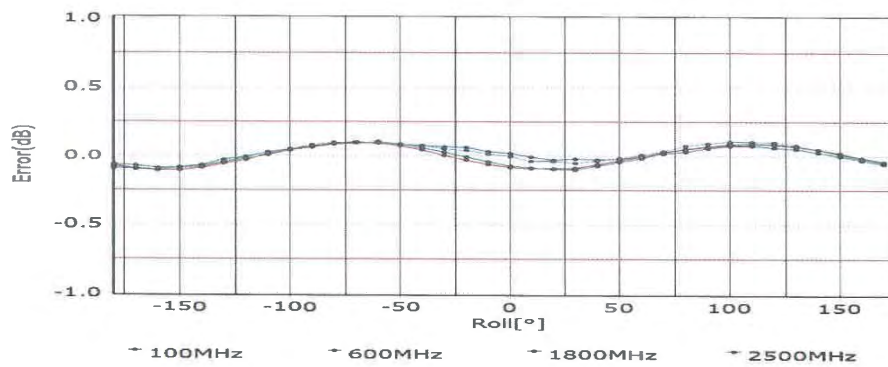
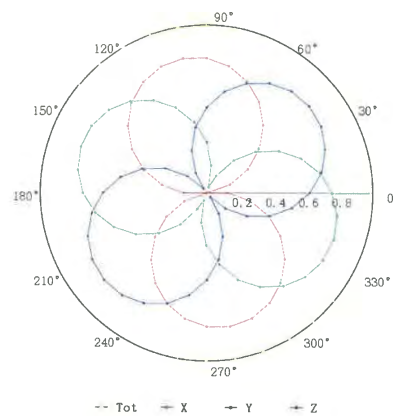
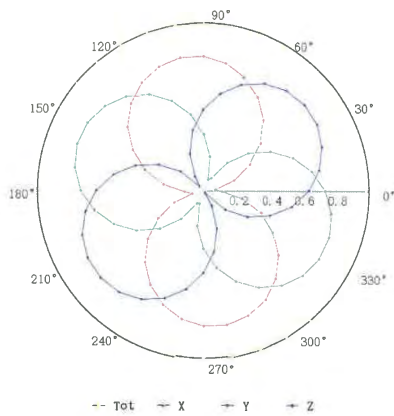

Uncertainty of Axial Isotropy Assessment: $\pm 1.2\%$ ($k=2$)



Add: No.51 Xueyuan Road, Haidian District, Beijing, 100191, China
Tel: +86-10-62304633-2512 Fax: +86-10-62304633-2504
E-mail: ettl@chinattl.com [Http://www.chinattl.cn](http://www.chinattl.cn)

Dynamic Range f(SAR_{head}) (TEM cell, f = 900 MHz)

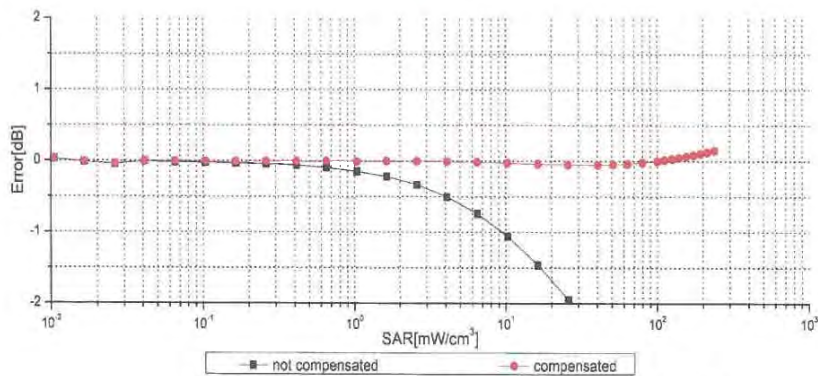
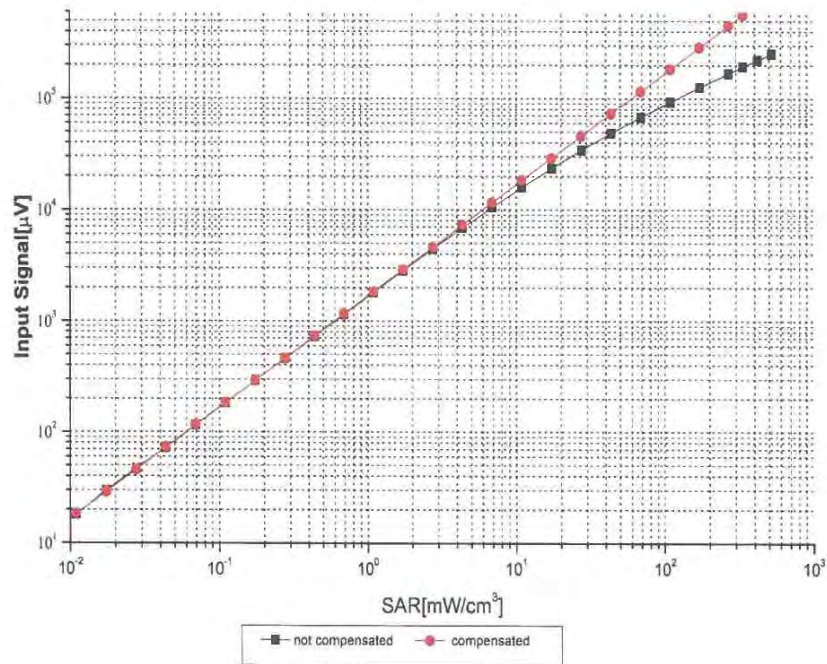

Uncertainty of Linearity Assessment: ±0.9% (k=2)



Add: No.51 Xueyuan Road, Haidian District, Beijing, 100191, China
Tel: +86-10-62304633-2512 Fax: +86-10-62304633-2504
E-mail: cttl@chinattl.com [Http://www.chinattl.cn](http://www.chinattl.cn)

Conversion Factor Assessment

f=750 MHz,WGLS R9(H_convF)

f=1750 MHz,WGLS R22(H_convF)

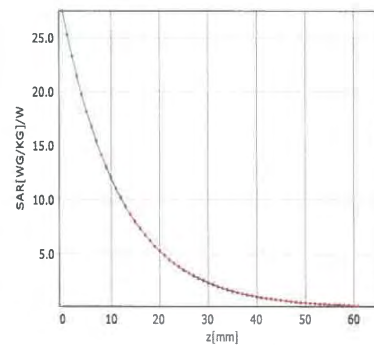
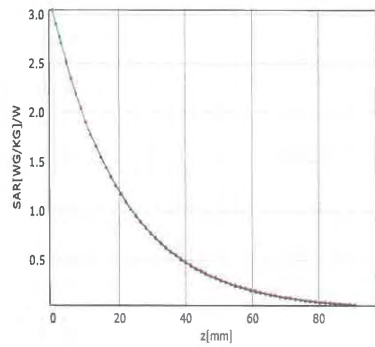

Deviation from Isotropy in Liquid

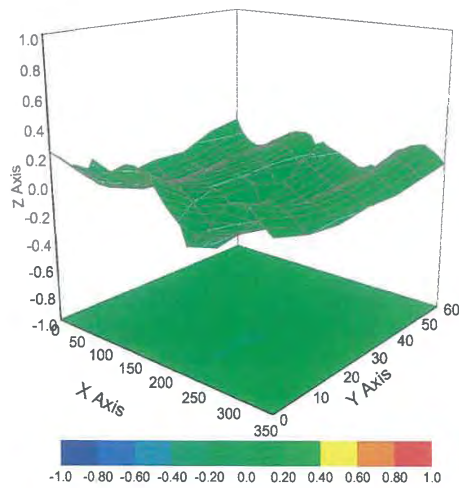

Uncertainty of Spherical Isotropy Assessment: $\pm 3.2\%$ ($k=2$)



Add: No.51 Xueyuan Road, Haidian District, Beijing, 100191, China
Tel: +86-10-62304633-2512 Fax: +86-10-62304633-2504
E-mail: ctl@chinatl.com [Http://www.chinatl.cn](http://www.chinatl.cn)

DASY/EASY – Parameters of Probe: EX3DV4 – SN:3847

Other Probe Parameters

Sensor Arrangement	Triangular
Connector Angle (°)	100.7
Mechanical Surface Detection Mode	enabled
Optical Surface Detection Mode	disable
Probe Overall Length	337mm
Probe Body Diameter	10mm
Tip Length	10mm
Tip Diameter	2.5mm
Probe Tip to Sensor X Calibration Point	1mm
Probe Tip to Sensor Y Calibration Point	1mm
Probe Tip to Sensor Z Calibration Point	1mm
Recommended Measurement Distance from Surface	1.4mm



MR-008_20-041



In Collaboration with
s p e a g
CALIBRATION LABORATORY



中国认可
国际互认
校准
CALIBRATION
CNAS L0570

Add: No.51 Xueyuan Road, Haidian District, Beijing, 100191, China
Tel: +86-10-62304633-2512 Fax: +86-10-62304633-2504
E-mail: cttl@chinatl.com Http://www.chinatl.cn

Client : **ATL**

Certificate No: **Z20-60115**

CALIBRATION CERTIFICATE			
Object	DAE4 - SN: 541		
Calibration Procedure(s)	FF-Z11-002-01 Calibration Procedure for the Data Acquisition Electronics (DAEx)		
Calibration date:	March 18, 2020		
This calibration Certificate documents the traceability to national standards, which realize the physical units of measurements(SI). The measurements and the uncertainties with confidence probability are given on the following pages and are part of the certificate.			
All calibrations have been conducted in the closed laboratory facility: environment temperature(22±3)°C and humidity<70%.			
Calibration Equipment used (M&TE critical for calibration)			
Primary Standards	ID #	Cal Date(Calibrated by, Certificate No.)	Scheduled Calibration
Process Calibrator 753	1971018	24-Jun-19 (CTTL, No.J19X05126)	Jun-20
Calibrated by:	Name	Function	Signature
	Yu Zongying	SAR Test Engineer	
Reviewed by:	Lin Hao	SAR Test Engineer	
Approved by:	Qi Dianyuan	SAR Project Leader	
			Issued: March 20, 2020
This calibration certificate shall not be reproduced except in full without written approval of the laboratory.			



Add: No.51 Xueyuan Road, Haidian District, Beijing, 100191, China
Tel: +86-10-62304633-2512 Fax: +86-10-62304633-2504
E-mail: cttl@chinattl.com Http://www.chinattl.cn

Glossary:

DAE data acquisition electronics
Connector angle information used in DASY system to align probe sensor X to the robot coordinate system.

Methods Applied and Interpretation of Parameters:

- *DC Voltage Measurement:* Calibration Factor assessed for use in DASY system by comparison with a calibrated instrument traceable to national standards. The figure given corresponds to the full scale range of the voltmeter in the respective range.
- *Connector angle:* The angle of the connector is assessed measuring the angle mechanically by a tool inserted. Uncertainty is not required.
- The report provide only calibration results for DAE, it does not contain other performance test results.



Add: No.51 Xueyuan Road, Haidian District, Beijing, 100191, China
Tel: +86-10-62304633-2512 Fax: +86-10-62304633-2504
E-mail: cttl@chinattl.com Http://www.chinattl.cn

DC Voltage Measurement

A/D - Converter Resolution nominal

High Range: 1LSB = 6.1μV, full range = -100...+300 mV

Low Range: 1LSB = 61nV, full range = -1.....+3mV

DASY measurement parameters: Auto Zero Time: 3 sec; Measuring time: 3 sec

Calibration Factors	X	Y	Z
High Range	404.553 ± 0.15% (k=2)	404.412 ± 0.15% (k=2)	404.179 ± 0.15% (k=2)
Low Range	3.96888 ± 0.7% (k=2)	3.93481 ± 0.7% (k=2)	3.97551 ± 0.7% (k=2)

Connector Angle

Connector Angle to be used in DASY system	288° ± 1°
---	-----------