

FCC Test Report (WLAN)

Report No.: RF150720E06-1

FCC ID: PPD-QCASP242

Test Model: QCASP242

Received Date: July 21, 2015

Test Date: Nov. 10 to 25, 2015

Issued Date: Jan. 08, 2016

Applicant: Qualcomm Atheros, Inc.

Address: 1700 Technology Drive, San Jose, CA 95110

Issued By: Bureau Veritas Consumer Products Services (H.K.) Ltd., Taoyuan Branch
Hsin Chu Laboratory

Lab Address: E-2, No.1, Li Hsin 1st Road, Hsinchu Science Park, Hsinchu City 300,
Taiwan R.O.C.

Test Location (1): No. 81-1, Lu Liao Keng, 9th Ling, Wu Lung Tsuen, Chiung Lin Hsiang, Hsin
Chu Hsien 307, Taiwan R.O.C.

Test Location (2): No. 49, Ln. 206, Wende Rd., Shangshan Tsuen, Chiung Lin Hsiang, Hsin
Chu Hsien 307, Taiwan R.O.C.

Test Location (3): E-2, No.1, Li Hsin 1st Road, Hsinchu Science Park, Hsinchu City 300,
Taiwan R.O.C.



This report is for your exclusive use. Any copying or replication of this report to or for any other person or entity, or use of our name or trademark, is permitted only with our prior written permission. This report sets forth our findings solely with respect to the test samples identified herein. The results set forth in this report are not indicative or representative of the quality or characteristics of the lot from which a test sample was taken or any similar or identical product unless specifically and expressly noted. Our report includes all of the tests requested by you and the results thereof based upon the information that you provided to us. You have 60 days from date of issuance of this report to notify us of any material error or omission caused by our negligence, provided, however, that such notice shall be in writing and shall specifically address the issue you wish to raise. A failure to raise such issue within the prescribed time shall constitute your unqualified acceptance of the completeness of this report, the tests conducted and the correctness of the report contents. Unless specific mention, the uncertainty of measurement has been explicitly taken into account to declare the compliance or non-compliance to the specification. The report must not be used by the client to claim product certification, approval, or endorsement by TAF or any government agencies.

Table of Contents

Release Control Record	4
1 Certificate of Conformity	5
2 Summary of Test Results	6
2.1 Measurement Uncertainty.....	6
2.2 Modification Record.....	6
3 General Information	7
3.1 General Description of EUT (WLAN).....	7
3.2 Description of Antenna.....	9
3.3 Description of Test Modes.....	10
3.3.1 Test Mode Applicability and Tested Channel Detail.....	12
3.4 Duty Cycle of Test Signal.....	14
3.5 Description of Support Units.....	15
3.5.1 Configuration of System under Test.....	15
3.6 General Description of Applied Standards.....	16
4 Test Types and Results	17
4.1 Transmit Power Measurement.....	17
4.1.1 Limits of Transmit Power Measurement.....	17
4.1.2 Test Setup.....	17
4.1.3 Test Instruments.....	18
4.1.4 Test Procedures.....	19
4.1.5 Deviation from Test Standard.....	19
4.1.6 EUT Operating Conditions.....	19
4.1.7 Test Results.....	20
4.2 Peak Power Spectral Density Measurement.....	34
4.2.1 Limits of Peak Power Spectral Density Measurement.....	34
4.2.2 Test Setup.....	34
4.2.3 Test Instruments.....	34
4.2.4 Test Procedures.....	35
4.2.5 Deviation from Test Standard.....	35
4.2.6 EUT Operating Conditions.....	35
4.2.7 Test Results.....	36
4.3 6dB Bandwidth Measurement.....	47
4.3.1 Limits of 6dB Bandwidth Measurement.....	47
4.3.2 Test Setup.....	47
4.3.3 Test Instruments.....	47
4.3.4 Test Procedures.....	47
4.3.5 Deviation from Test Standard.....	47
4.3.6 EUT Operating Conditions.....	47
4.3.7 Test Results.....	48
4.4 Unwanted Emission Measurement (Radiated Versus Conducted).....	51
4.4.1 Limits of Unwanted Emission Measurement.....	51
4.4.2 Test Instruments.....	52
4.4.3 Test Procedures.....	54
4.4.4 Deviation from Test Standard.....	55
4.4.5 Test Setup.....	55
4.4.6 EUT Operating Conditions.....	56
4.4.7 Test Results (Radiated Measurement).....	56
4.4.8 Test Results (Conducted Measurement).....	131
4.5 Frequency Stability Measurement.....	241
4.5.1 Limits of Frequency Stability Measurement.....	241
4.5.2 Test Setup.....	241
4.5.3 Test Instruments.....	241
4.5.4 Test Procedures.....	241



4.5.5	Deviation from Test Standard	242
4.5.6	EUT Operating Conditions.....	242
4.5.7	Test Results	243
4.6	Conducted Emission Measurement	244
4.6.1	Limits of Conducted Emission Measurement.....	244
4.6.2	Test Instruments	244
4.6.3	Test Procedures.....	245
4.6.4	Deviation from Test Standard	245
4.6.5	Test Setup.....	245
4.6.6	EUT Operating Conditions.....	245
4.6.7	Test Results	246
5	Pictures of Test Arrangements.....	248
6	Appendix B – Information on the Testing Laboratories.....	249



Release Control Record

Issue No.	Description	Date Issued
RF150720E06-1	Original release.	Jan. 08, 2016

1 Certificate of Conformity

Product: Low-Energy WiFi Dual-Band 802.11a/b/g/n

Brand: Qualcomm Atheros

Test Model: QCASP242

Sample Status: R&D SAMPLE

Applicant: Qualcomm Atheros, Inc.

Test Date: Nov. 10 to 25, 2015

Standards: 47 CFR FCC Part 15, Subpart E (Section 15.407)
ANSI C63.10: 2013

The above equipment has been tested by **Bureau Veritas Consumer Products Services (H.K.) Ltd., Taoyuan Branch**, and found compliance with the requirement of the above standards. The test record, data evaluation & Equipment Under Test (EUT) configurations represented herein are true and accurate accounts of the measurements of the sample's EMC characteristics under the conditions specified in this report.

Prepared by :  _____ , **Date:** _____ Jan. 08, 2016
Elsie Hsu / Specialist

Approved by :  _____ , **Date:** _____ Jan. 08, 2016
May Chen / Manager

2 Summary of Test Results

47 CFR FCC Part 15, Subpart E (SECTION 15.407 Under New Rule)			
FCC Clause	Test Item	Result	Remarks
15.407(b)(6)	AC Power Conducted Emissions	PASS	Meet the requirement of limit. Minimum passing margin is -9.25dB at 0.18944MHz.
15.407(b)(1/2/3/4/6)	Radiated Emissions & Band Edge Measurement	PASS	Meet the requirement of limit. Minimum passing margin is -5.2dB at 17355.00MHz & 15540.00MHz.
15.407(a)(1/2/3)	Max Average Transmit Power	PASS	Meet the requirement of limit.
15.407(a)(1/2/3)	Peak Power Spectral Density	PASS	Meet the requirement of limit.
15.407(e)	6dB bandwidth	PASS	Meet the requirement of limit. (U-NII-3 Band only)
15.407(g)	Frequency Stability	PASS	Meet the requirement of limit.
15.203	Antenna Requirement	PASS	Antenna connector is IPEX not a standard connector.

NOTE: 1. For WLAN: The EUT was operating in 2400 ~ 2483.5MHz, 5.15~5.35GHz, 5.47~5.725GHz and 5.725~5.850GHz frequencies band. This report was recorded the RF parameters including 5.15~5.35GHz, 5.47~5.725GHz and 5.725~5.850GHz. For the 2400 ~ 2483.5MHz RF parameters was recorded in another test report.

2. The DFS report was recorded in another test report.

2.1 Measurement Uncertainty

Where relevant, the following measurement uncertainty levels have been estimated for tests performed on the EUT as specified in CISPR 16-4-2:

Measurement	Frequency	Expanded Uncertainty (k=2) (±)
Conducted Emissions at mains ports	150kHz ~ 30MHz	2.86 dB
Radiated Emissions up to 1 GHz	30MHz ~ 1GHz	5.19 dB
Radiated Emissions above 1 GHz	1GHz ~ 6GHz-	3.43 dB
	6GHz ~ 18GHz	3.49 dB
	18GHz ~ 40GHz	4.11 dB

2.2 Modification Record

There were no modifications required for compliance.

3 General Information

3.1 General Description of EUT (WLAN)

Product	Low-Energy WiFi Dual-Band 802.11a/b/g/n
Brand	Qualcomm Atheros
Test Model	QCASP242
Status of EUT	R&D SAMPLE
Power Supply Rating	3.3Vdc from host equipment
Modulation Type	CCK, DQPSK, DBPSK for DSSS 64QAM, 16QAM, QPSK, BPSK for OFDM
Modulation Technology	DSSS, OFDM
Transfer Rate	802.11b: up to 11Mbps 802.11a/g: up to 54Mbps 802.11n: up to 150Mbps
Operating Frequency	For 15.407 5.18 ~ 5.24GHz, 5.26 ~ 5.32GHz, 5.50 ~ 5.72GHz, 5.745 ~ 5.825GHz For 15.247 2.412 ~ 2.472GHz
Number of Channel	For 15.407 25 for 802.11a, 802.11n (HT20) 12 for 802.11n (HT40) For 15.247 13 for 802.11b/g, 802.11n (HT20) 9 for 802.11n (HT40)
Output Power	For 15.407 802.11a: 14.454 mW 802.11n (HT20): 14.06mW 802.11n (HT40): 11.749mW For 15.247 802.11b: 102.094mW 802.11g: 191.867mW 802.11n (HT20): 188.799mW 802.11n (HT40): 113.501mW
Antenna Type	See item 3.2
Antenna Connector	See item 3.2
Accessory Device	NA
Data Cable Supplied	NA

Note:

1. 2.4GHz & 5GHz technology can't transmit at same time.
2. The modular has two variant designs as following table:

Variant No.	Difference	TX & RX Configuration
SKU #1	External antenna version	1TX/1RX
SKU #2	On board PCB antenna version	1TX/1RX

3. The EUT incorporates a 1T1R function.

2.4GHz Band			
MODULATION MODE	DATA RATE (MCS)	TX & RX CONFIGURATION	
802.11b	1 ~ 11Mbps	1TX	1RX (diversity)
802.11g	6 ~ 54Mbps	1TX	1RX (diversity)
802.11n (HT20)	MCS 0~7	1TX	1RX (diversity)
802.11n (HT40)	MCS 0~7	1TX	1RX (diversity)
5GHz Band			
MODULATION MODE	DATA RATE (MCS)	TX & RX CONFIGURATION	
802.11a	6 ~ 54Mbps	1TX	1RX (diversity)
802.11n (HT20)	MCS 0~7	1TX	1RX (diversity)
802.11n (HT40)	MCS 0~7	1TX	1RX (diversity)

4. The EUT was pre-tested under the following modes:

Test Mode	Data rate
Mode A	400ns GI
Mode B	800ns GI

From the above modes, the worst case was found in **Mode B**. Therefore only the test data of the mode was recorded in this report.

5. The above EUT information is declared by manufacturer and for more detailed features description, please refer to the manufacturer's specifications or user's manual.

3.2 Description of Antenna

The antenna gain was declared by client; please refer to the following table:

Ant. No.	Transmitter Circuit	Brand	Model	Ant. Type	2.4GHz Gain with cable loss (dBi)	5GHz Gain with cable loss (dBi)	2.4GHz Cable Loss (dB)	5GHz Cable Loss (dB)	Connector Type	Cable Length (mm)
1	Chain (0)	WNC	81.EBJ15.005	PIFA	3.00	5.15~5.35GHz: 2.56	1.15	5.15~5.35GHz: 1.70	IPEX	300
						5.47~5.725GHz: 4.76		5.47~5.725GHz: 1.74		
						5.725~5.85GHz: 4.76		5.725~5.85GHz: 1.79		
	Chain (1)	WNC	81.EBJ15.005	PIFA	3.62	5.15~5.35GHz: 3.08	1.15	5.15~5.35GHz: 1.70	IPEX	300
						5.47~5.725GHz: 3.31		5.47~5.725GHz: 1.74		
						5.725~5.85GHz: 2.42		5.725~5.85GHz: 1.79		
Ant. No.	Transmitter Circuit	Brand	Model	Ant. Type	2.4GHz Gain (dBi)	5GHz Gain (dBi)	Connector Type			
2	Chain (0)	QCA	QCASP242-Ant	PCB	1.72	1.91	IPEX			

Note: 1. Above antenna gains of antenna are Total (H+V).

Following antenna combination(s) was (were) selected as representative mode for test or evaluate in this report as listed.

Transmitter Circuit	Brand	Model	Ant. Type	2.4GHz Gain with cable loss (dBi)	5GHz Gain with cable loss (dBi)	2.4GHz Cable Loss (dB)	5GHz Cable Loss (dB)	Connector Type	Cable Length (mm)
Chain (0)+(1)	WNC	81.EBJ15.005	PIFA	3.62	5.15~5.35GHz: 2.56	1.15	5.15~5.35GHz: 1.70	IPEX	300
					5.47~5.725GHz: 4.76		5.47~5.725GHz: 1.74		
					5.725~5.85GHz: 4.76		5.725~5.85GHz: 1.79		

3.3 Description of Test Modes

FOR 5180 ~ 5240MHz

4 channels are provided for 802.11a, 802.11n (HT20):

Channel	Frequency	Channel	Frequency
36	5180 MHz	44	5220 MHz
40	5200 MHz	48	5240 MHz

2 channels are provided for 802.11n (HT40):

Channel	Frequency	Channel	Frequency
38	5190 MHz	46	5230 MHz

FOR 5260 ~ 5320MHz

4 channels are provided for 802.11a, 802.11n (HT20):

Channel	Frequency	Channel	Frequency
52	5260 MHz	60	5300 MHz
56	5280 MHz	64	5320 MHz

2 channels are provided for 802.11n (HT40):

Channel	Frequency	Channel	Frequency
54	5270 MHz	62	5310 MHz

FOR 5500 ~ 5720MHz

12 channels are provided for 802.11a, 802.11n (HT20):

Channel	Frequency	Channel	Frequency
100	5500 MHz	124	5620 MHz
104	5520 MHz	128	5640 MHz
108	5540 MHz	132	5660 MHz
112	5560 MHz	136	5680 MHz
116	5580 MHz	140	5700 MHz
120	5600 MHz	144	5720 MHz

6 channels are provided for 802.11n (HT40):

Channel	Frequency	Channel	Frequency
102	5510 MHz	126	5630 MHz
110	5550 MHz	134	5670 MHz
118	5590 MHz	142	5710 MHz

Note : The listed channels in the DFS band (5250~5350MHz and 5470~5725MHz) are passive scan only.

FOR 5745 ~ 5825MHz:

5 channels are provided for 802.11a, 802.11n (HT20):

Channel	Frequency	Channel	Frequency
149	5745MHz	161	5805MHz
153	5765MHz	165	5825MHz
157	5785MHz		

2 channels are provided for 802.11n (HT40):

Channel	Frequency	Channel	Frequency
151	5755MHz	159	5795MHz

3.3.1 Test Mode Applicability and Tested Channel Detail

EUT CONFIGURE MODE	APPLICABLE TO				DESCRIPTION
	UE≥1G	UE<1G	PLC	APCM	
-	√	√	√	√	-

Where **UE≥1G**: Unwanted Emission above 1GHz **UE<1G**: Unwanted Emission below 1GHz
PLC: Power Line Conducted Emission **APCM**: Antenna Port Conducted Measurement

Unwanted Emission Test (Above 1GHz):

- Pre-Scan has been conducted to determine the worst-case mode from all possible combinations between available modulations, data rates and antenna ports (if EUT with antenna diversity architecture).
- Following channel(s) was (were) selected for the final test as listed below.

MODE	FREQ. BAND (MHz)	AVAILABLE CHANNEL	TESTED CHANNEL	MODULATION TECHNOLOGY	DATA RATE (Mbps)
802.11a	5180-5240	36 to 48	36, 40, 48	OFDM	6
802.11n (HT20)		36 to 48	36, 40, 48	OFDM	6.5
802.11n (HT40)		38 to 46	38, 46	OFDM	13.5
802.11a	5260-5320	52 to 64	52, 60, 64	OFDM	6
802.11n (HT20)		52 to 64	52, 60, 64	OFDM	6.5
802.11n (HT40)		54 to 62	54, 62	OFDM	13.5
802.11a	5500-5720	100 to 144	100, 120, 140, 144	OFDM	6
802.11n (HT20)		100 to 144	100, 120, 140, 144	OFDM	6.5
802.11n (HT40)		102 to 142	102, 118, 134, 142	OFDM	13.5
802.11a	5745-5825	149 to 165	149, 157, 165	OFDM	6
802.11n (HT20)		149 to 165	149, 157, 165	OFDM	6.5
802.11n (HT40)		151 to 159	151, 159	OFDM	13.5

Unwanted Emission Test (Below 1GHz):

- Pre-Scan has been conducted to determine the worst-case mode from all possible combinations between available modulations, data rates and antenna ports (if EUT with antenna diversity architecture).
- Following channel(s) was (were) selected for the final test as listed below.

MODE	FREQ. BAND (MHz)	AVAILABLE CHANNEL	TESTED CHANNEL	MODULATION TECHNOLOGY	DATA RATE (Mbps)
802.11a	5180-5320, 5500-5720, 5745-5825	36 to 64, 100 to 144, 149 to 165	52	OFDM	6

Power Line Conducted Emission Test:

- Pre-Scan has been conducted to determine the worst-case mode from all possible combinations between available modulations, data rates and antenna ports (if EUT with antenna diversity architecture).
- Following channel(s) was (were) selected for the final test as listed below.

MODE	FREQ. BAND (MHz)	AVAILABLE CHANNEL	TESTED CHANNEL	MODULATION TECHNOLOGY	DATA RATE (Mbps)
802.11a	5180-5320, 5500-5720, 5745-5825	36 to 64, 100 to 144, 149 to 165	52	OFDM	6

Antenna Port Conducted Measurement:

- This item includes all test value of each mode, but only includes spectrum plot of worst value of each mode.
- Pre-Scan has been conducted to determine the worst-case mode from all possible combinations between available modulations, data rates and antenna ports (if EUT with antenna diversity architecture).
- Following channel(s) was (were) selected for the final test as listed below.

MODE	FREQ. BAND (MHz)	AVAILABLE CHANNEL	TESTED CHANNEL	MODULATION TECHNOLOGY	DATA RATE (Mbps)
802.11a	5180-5240	36 to 48	36, 40, 48	OFDM	6
802.11n (HT20)		36 to 48	36, 40, 48	OFDM	6.5
802.11n (HT40)		38 to 46	38, 46	OFDM	13.5
802.11a	5260-5320	52 to 64	52, 60, 64	OFDM	6
802.11n (HT20)		52 to 64	52, 60, 64	OFDM	6.5
802.11n (HT40)		54 to 62	54, 62	OFDM	13.5
802.11a	5500-5720	100 to 144	100, 120, 140, 144	OFDM	6
802.11n (HT20)		100 to 144	100, 120, 140, 144	OFDM	6.5
802.11n (HT40)		102 to 142	102, 118, 134, 142	OFDM	13.5
802.11a	5745-5825	149 to 165	149, 157, 165	OFDM	6
802.11n (HT20)		149 to 165	149, 157, 165	OFDM	6.5
802.11n (HT40)		151 to 159	151, 159	OFDM	13.5

Test Condition:

APPLICABLE TO	ENVIRONMENTAL CONDITIONS	INPUT POWER (SYSTEM)	TESTED BY
UE≥1G	26deg. C, 71%RH	120Vac, 60Hz	Gary Cheng
UE<1G	19deg. C, 65%RH	120Vac, 60Hz	Gary Cheng
PLC	25deg. C, 67%RH	120Vac, 60Hz	Andy Ho
APCM	25deg. C, 60%RH	120Vac, 60Hz	Anderson Chen

3.4 Duty Cycle of Test Signal

Duty cycle of test signal is 100 %, duty factor is not required.

802.11a

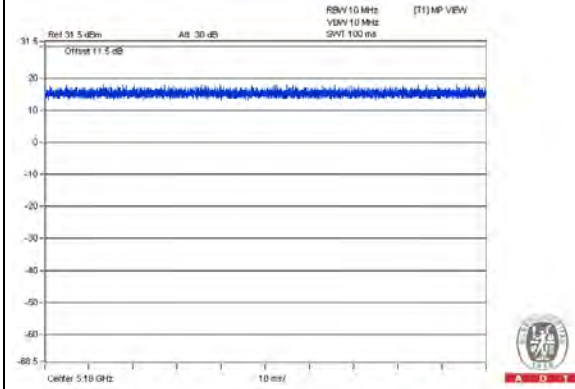

802.11n (HT20)

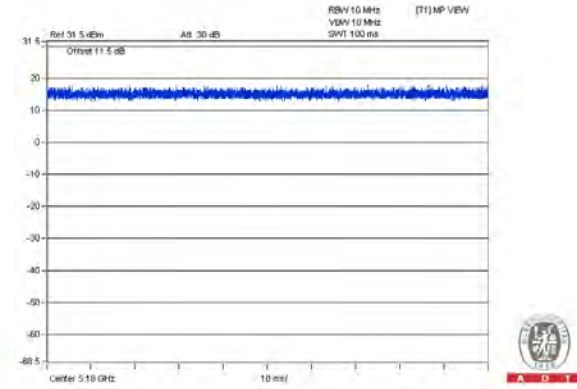

802.11n (HT40)

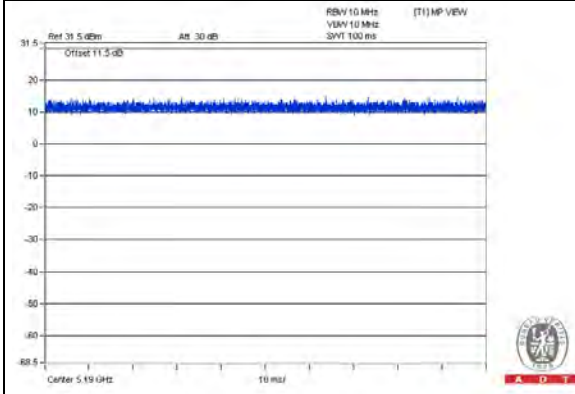

3.5 Description of Support Units

The EUT has been tested as an independent unit together with other necessary accessories or support units. The following support units or accessories were used to form a representative test configuration during the tests.

No.	Product	Brand	Model No.	Serial No.	FCC ID	Remark
A	NOTEBOOK COMPUTER	Lenovo	0769	NA	NA	Provided by Lab
B	Test tool	NA	9583H3D0100	NA	NA	Supplied by Client

NOTE: All power cords of the above support units are non-shielded (1.8 m).

ID	Descriptions	Qty.	Length (m)	Shielding (Yes/No)	Cores (Qty.)	Remarks
1.	USB	1	0.5	Yes	0	Provided by Lab

3.5.1 Configuration of System under Test

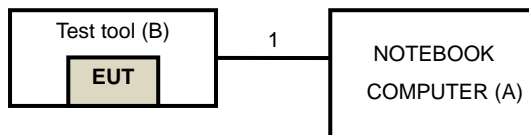

3.6 General Description of Applied Standards

The EUT is a RF Product. According to the specifications of the manufacturer, it must comply with the requirements of the following standards:

FCC Part 15, Subpart E (15.407)

KDB 789033 D02 General UNII Test Procedures New Rules v01r01

KDB 644545 D03 Guidance for IEEE 802.11ac v01

ANSI C63.10-2013

All test items have been performed and recorded as per the above standards.

4 Test Types and Results

4.1 Transmit Power Measurement

4.1.1 Limits of Transmit Power Measurement

Operation Band	EUT Category		LIMIT
U-NII-1		Outdoor Access Point	1 Watt (30 dBm) (Max. e.i.r.p \leq 125mW(21 dBm) at any elevation angle above 30 degrees as measured from the horizon)
		Fixed point-to-point Access Point	1 Watt (30 dBm)
		Indoor Access Point	1 Watt (30 dBm)
	√	Mobile and Portable client device	250mW (24 dBm)
U-NII-2A		√	250mW (24 dBm) or 11 dBm+10 log B*
U-NII-2C		√	250mW (24 dBm) or 11 dBm+10 log B*
U-NII-3		√	1 Watt (30 dBm)

Note: *B is the 26 dB emission bandwidth in megahertz

4.1.2 Test Setup

FOR POWER OUTPUT MEASUREMENT

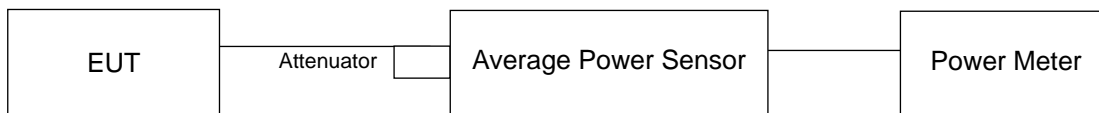

FOR 26dB OCCUPIED BANDWIDTH

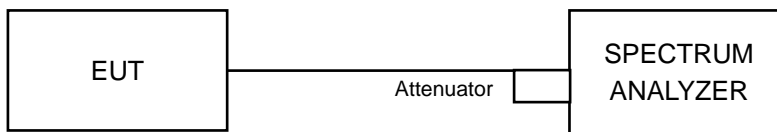

4.1.3 Test Instruments

FOR POWER OUTPUT MEASUREMENT

DESCRIPTION & MANUFACTURER	MODEL NO.	SERIAL NO.	CALIBRATED DATE	CALIBRATED UNTIL
Power meter Anritsu	ML2495A	1014008	Apr. 28, 2015	Apr. 27, 2016
Power sensor Anritsu	MA2411B	0917122	Apr. 28, 2015	Apr. 27, 2016

- NOTE:**
1. The test was performed in Oven room 2.
 2. The calibration interval of the above test instruments is 12 months and the calibrations are traceable to NML/ROC and NIST/USA.
 3. Tested Date: Nov. 16, 2015

FOR 26dB OCCUPIED BANDWIDTH

DESCRIPTION & MANUFACTURER	MODEL NO.	SERIAL NO.	CALIBRATED DATE	CALIBRATED UNTIL
SPECTRUM ANALYZER R&S	FSP 40	100060	May 08, 2015	May 07, 2016

- NOTE:**
1. The test was performed in Oven room 2.
 2. The calibration interval of the above test instruments is 12 months and the calibrations are traceable to NML/ROC and NIST/USA.
 3. Tested Date: Nov. 16, 2015

4.1.4 Test Procedures

FOR AVERAGE POWER MEASUREMENT

Method PM is used to perform output power measurement, trigger and gating function of wide band power meter is enabled to measure max output power of TX on burst. Duty factor is not added to measured value.

FOR 26dB OCCUPIED BANDWIDTH

1. Set RBW = approximately 1% of the emission bandwidth.
2. Set the VBW > RBW.
3. Detector = Peak.
4. Trace mode = max hold.
5. Measure the maximum width of the emission that is 26 dB down from the peak of the emission. Compare this with the RBW setting of the analyzer. Readjust RBW and repeat measurement as needed until the RBW/EBW ratio is approximately 1%.

4.1.5 Deviation from Test Standard

No deviation.

4.1.6 EUT Operating Conditions

The software (artgui.exe V2.3) provided by client to enable the EUT under transmission condition continuously at lowest, middle and highest channel frequencies individually.

4.1.7 Test Results

802.11a

POWER OUTPUT

Chan.	Chan. Freq. (MHz)	Average Power (mW)	Average Power (dBm)	Limit (dBm)	Pass / Fail
36	5180	13.646	11.35	24	Pass
40	5200	13.335	11.25	24	Pass
48	5240	14.028	11.47	24	Pass
52	5260	14.454	11.60	24	Pass
60	5300	14.421	11.59	24	Pass
64	5320	13.932	11.44	24	Pass
100	5500	13.397	11.27	24	Pass
120	5600	13.243	11.22	24	Pass
140	5700	13.335	11.25	24	Pass
*144 (UNII-2c Band)	5720	7.762	8.90	24	Pass
*144 (UNII-3 Band)	5720	1.75	2.43	30	Pass
149	5745	13.335	11.25	30	Pass
157	5785	13.274	11.23	30	Pass
165	5825	13.397	11.27	30	Pass

Note: * Test was performed in accordance with Measurement follow FCC KDB 789033 UNII test procedure Method SA-1 and use spectrum analyzer test.

The Total Power for the straddle channel:

Chan.	Chan. Freq. (MHz)	Average Power (mW)	Average Power (dBm)
*144	5720	9.512	9.78

Note: The total power was calculated through formula and record the value for reference only.

26dB OCCUPIED BANDWIDTH

Channel	Frequency (MHz)	26dBc Bandwidth (MHz)
36	5180	20.89
40	5200	20.55
48	5240	20.72
52	5260	20.56
60	5300	20.77
64	5320	20.23
100	5500	20.32
120	5600	20.53
140	5700	20.88
144 (UNII-2c Band)	5720	15.69

Note: For U-NII-2A, U-NII-2C Band output power limitation is determined based on 26dBc bandwidth

Power Limit = 11dBm + 10logB < U-NII-2A, U-NII-2C >			
Channel Number	Freq.(MHz)	Min. B(MHz)	Determined Conducted Limit (dBm)
52	5260	20.56	24.13 > 24
60	5300	20.77	24.17 > 24
64	5320	20.23	24.05 > 24
100	5500	20.32	24.07 > 24
120	5600	20.53	24.12 > 24
140	5700	20.88	24.19 > 24
144 (UNII-2c Band)	5720	15.69	22.95 < 24

CH36

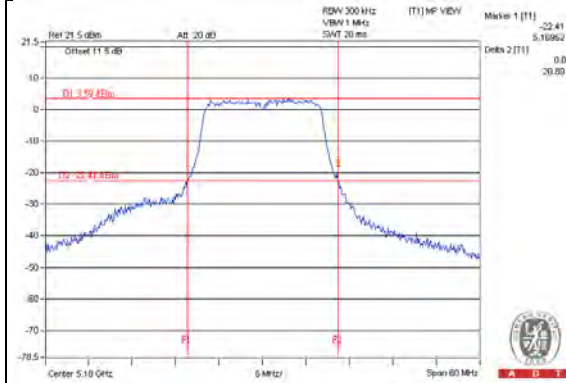

CH40

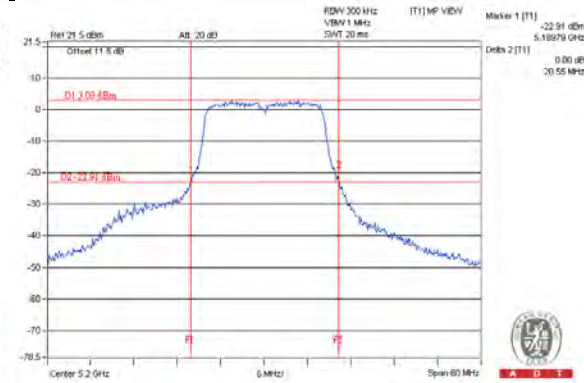

CH48

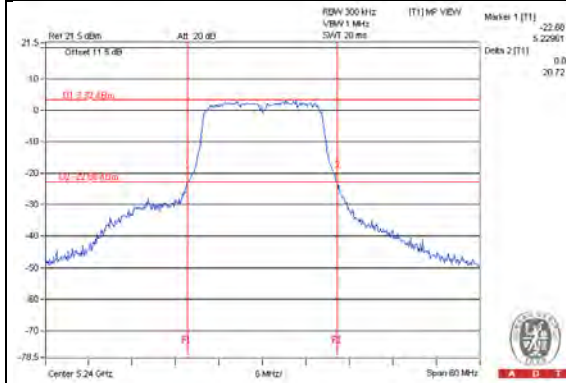

CH52

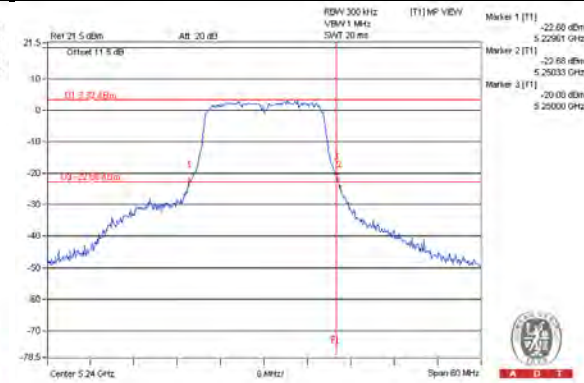

CH60

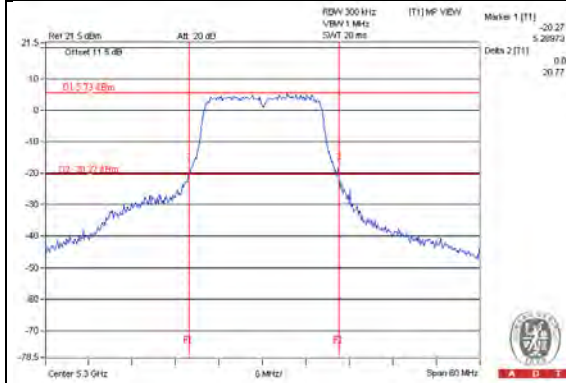

CH64

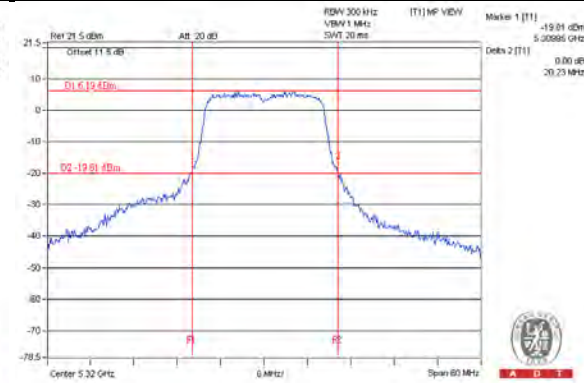

CH100

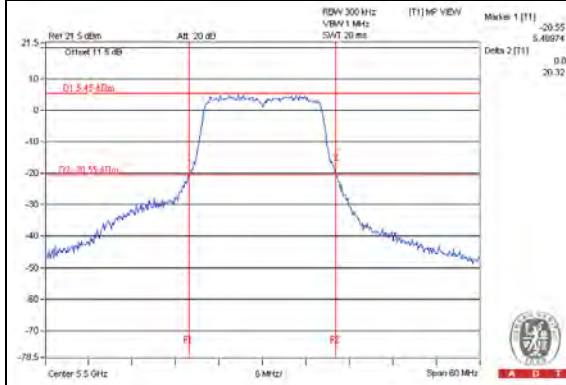

CH120

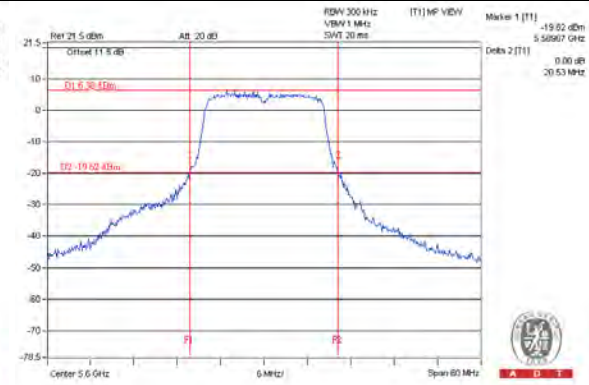

CH140

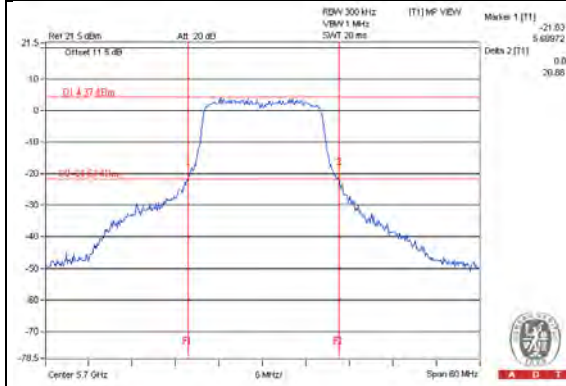

CH144 (UNII-2c Band) / CH144 (UNII-3 Band)

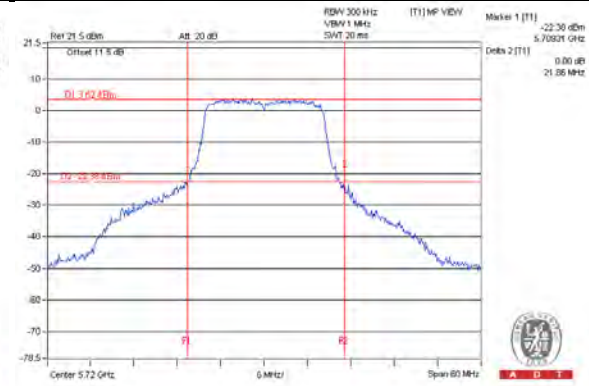

NOTE:

For CH144 (UNII-2c Band) = 5725MHz - Marker 1

For Reference only – Power meter value

The power value was measured by power meter with average sensor.

Chan.	Chan. Freq. (MHz)	Average Power (mW)	Average Power (dBm)
144	5720	13.428	11.28

Note: The total power was calculated through formula and record the value for reference only.

802.11n (HT20)
POWER OUTPUT

Chan.	Chan. Freq. (MHz)	Average Power (mW)	Average Power (dBm)	Limit (dBm)	Pass / Fail
36	5180	13.183	11.20	24	Pass
40	5200	12.823	11.08	24	Pass
48	5240	13.397	11.27	24	Pass
52	5260	13.677	11.36	24	Pass
60	5300	14.06	11.48	24	Pass
64	5320	13.677	11.36	24	Pass
100	5500	13.366	11.26	24	Pass
120	5600	13.772	11.39	24	Pass
140	5700	13.152	11.19	24	Pass
*144 (UNII-2c Band)	5720	6.546	8.16	23.89	Pass
*144 (UNII-3 Band)	5720	1.626	2.11	30	Pass
149	5745	13.996	11.46	30	Pass
157	5785	13.092	11.17	30	Pass
165	5825	14.028	11.47	30	Pass

Note: * Test was performed in accordance with Measurement follow FCC KDB 789033 UNII test procedure Method SA-1 and use spectrum analyzer test.

The Total Power for the straddle channel:

Chan.	Chan. Freq. (MHz)	Average Power (mW)	Average Power (dBm)
*144	5720	8.172	9.12

Note: The total power was calculated through formula and record the value for reference only.

26dB OCCUPIED BANDWIDTH

Channel	Frequency (MHz)	26dBc Bandwidth (MHz)
36	5180	21.40
40	5200	21.31
48	5240	21.61
52	5260	21.36
60	5300	21.03
64	5320	21.47
100	5500	21.24
120	5600	21.47
140	5700	21.46
144 (UNII-2c Band)	5720	16.22

Note: For U-NII-2A, U-NII-2C Band output power limitation is determined based on 26dBc bandwidth

Power Limit = 11dBm + 10logB < U-NII-2A, U-NII-2C >			
Channel Number	Freq.(MHz)	Min. B(MHz)	Determined Conducted Limit (dBm)
52	5260	21.36	24.29 > 24
60	5300	21.03	24.22 > 24
64	5320	21.47	24.31 > 24
100	5500	21.24	24.27 > 24
120	5600	21.47	24.31 > 24
140	5700	21.46	24.31 > 24
144 (UNII-2c Band)	5720	16.22	23.1 < 24

CH36

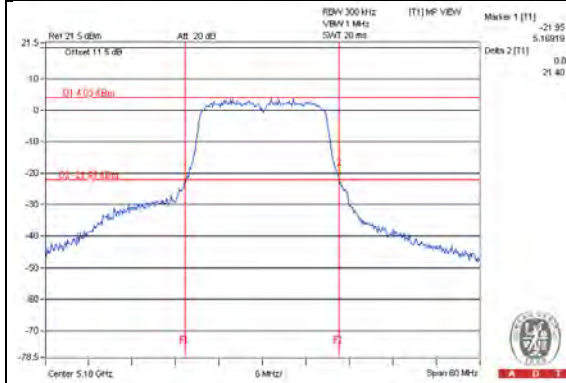

CH40

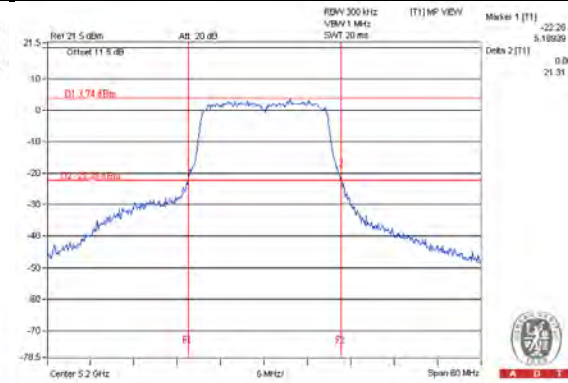

CH48

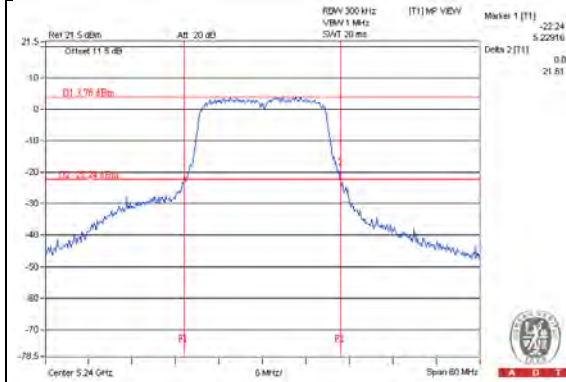

CH52

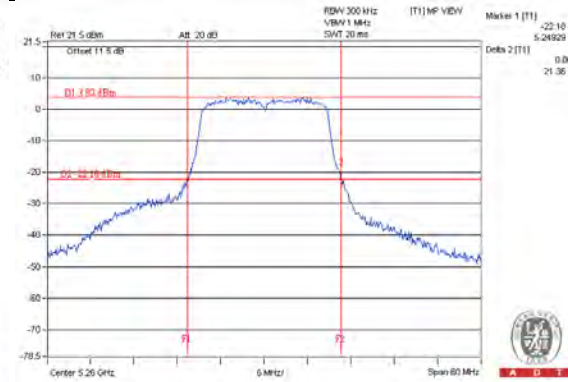

CH60

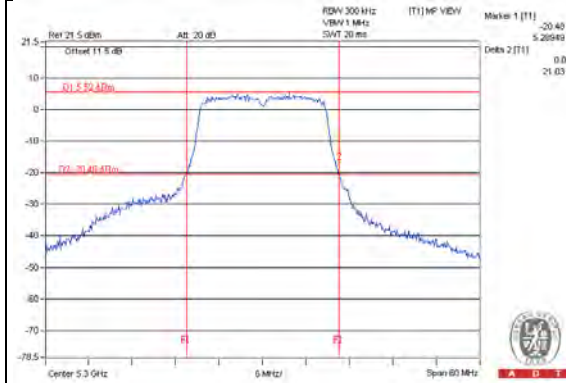

CH64

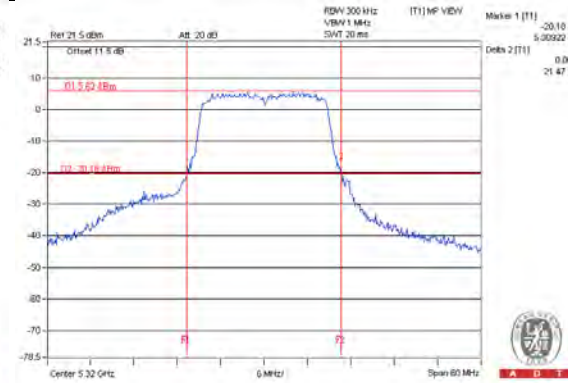

CH100

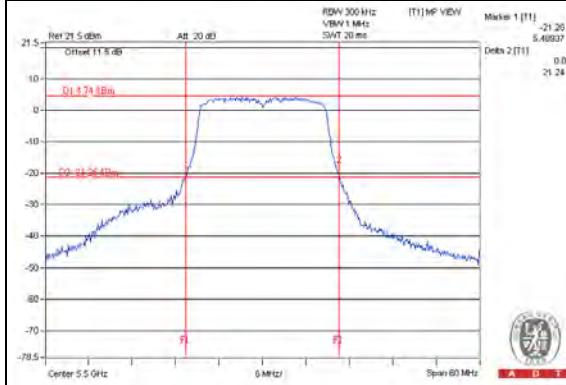

CH120

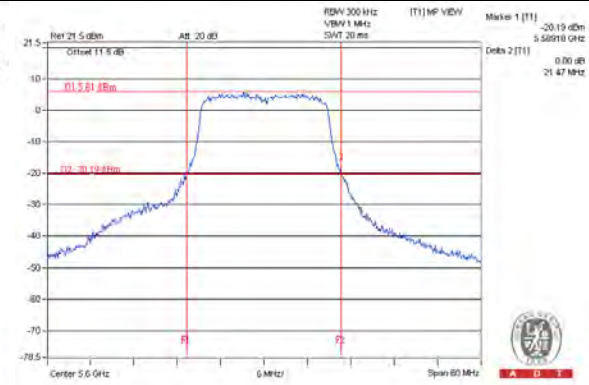

CH140

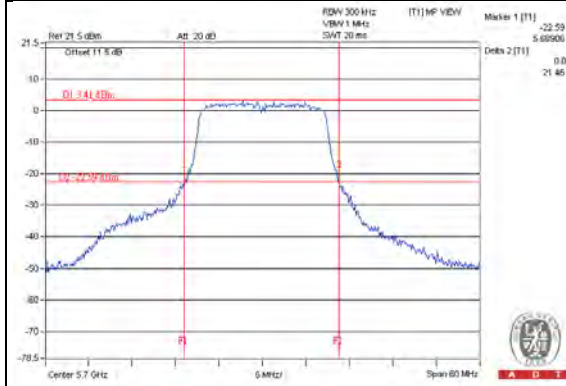

CH144 (UNII-2c Band) / CH144 (UNII-3 Band)

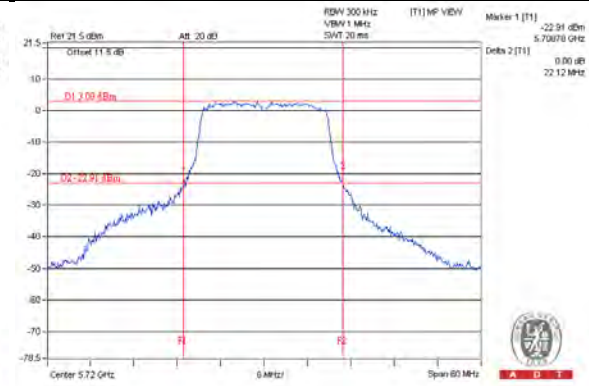

NOTE:

For CH144 (UNII-2c Band) = 5725MHz - Marker 1

For Reference only – Power meter value

The power value was measured by power meter with average sensor.

Chan.	Chan. Freq. (MHz)	Average Power (mW)	Average Power (dBm)
144	5720	13.428	11.28

Note: The total power was calculated through formula and record the value for reference only.

802.11n (HT40)
POWER OUTPUT

Chan.	Chan. Freq. (MHz)	Average Power (mW)	Average Power (dBm)	Limit (dBm)	Pass / Fail
38	5190	10.864	10.36	24	Pass
46	5230	10.765	10.32	24	Pass
54	5270	11.749	10.70	24	Pass
62	5310	11.722	10.69	24	Pass
102	5510	10.568	10.24	24	Pass
118	5590	10.399	10.17	24	Pass
134	5670	10.495	10.21	24	Pass
*142 (UNII-2c Band)	5710	6.516	8.14	24	Pass
*142 (UNII-3 Band)	5710	0.2679	-5.72	30	Pass
151	5755	10.423	10.18	30	Pass
159	5795	10.889	10.37	30	Pass

Note: * Test was performed in accordance with Measurement follow FCC KDB 789033 UNII test procedure Method SA-1 and use spectrum analyzer test.

The Total Power for the straddle channel:

Chan.	Chan. Freq. (MHz)	Average Power (mW)	Average Power (dBm)
*142	5710	6.7839	8.31

Note: The total power was calculated through formula and record the value for reference only.

26dB OCCUPIED BANDWIDTH

Channel	Frequency (MHz)	26dBc Bandwidth (MHz)
38	5190	42.80
46	5230	43.34
54	5270	43.03
62	5310	42.95
102	5510	42.50
118	5590	42.89
134	5670	42.75
142 (UNII-2c Band)	5710	36.65

Note: For U-NII-2A, U-NII-2C Band output power limitation is determined based on 26dBc bandwidth

Power Limit = 11dBm + 10logB < U-NII-2A, U-NII-2C >			
Channel Number	Freq.(MHz)	Min. B(MHz)	Determined Conducted Limit (dBm)
54	5270	43.03	27.33 > 24
62	5310	42.95	27.32 > 24
102	5510	42.50	27.28 > 24
110	5550	42.89	27.32 > 24
134	5670	42.75	27.3 > 24
142 (UNII-2c Band)	5710	36.65	26.64 > 24

CH38

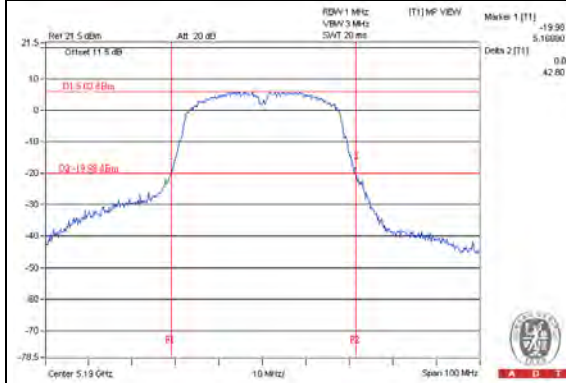

CH46

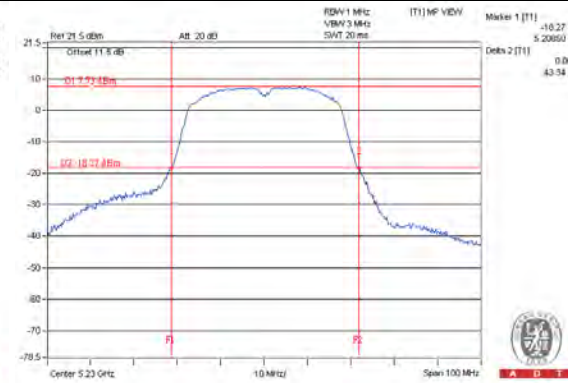

CH54

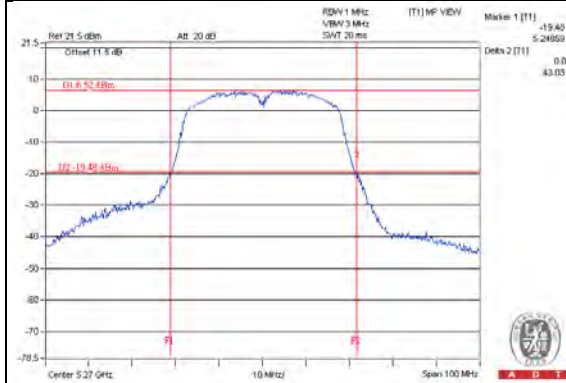

CH62

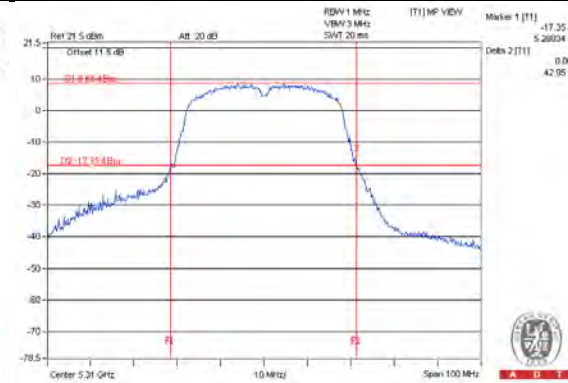

CH102

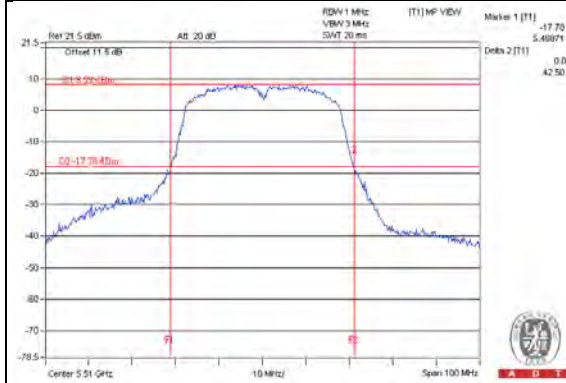

CH118

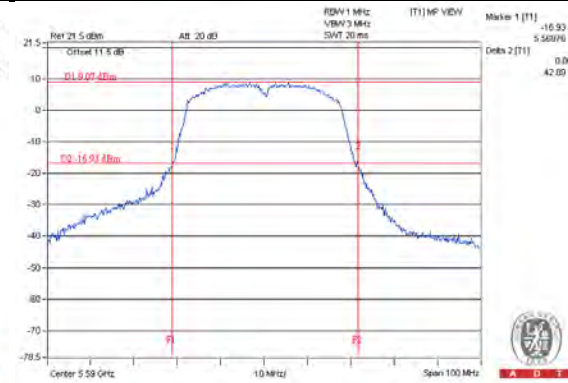

CH134

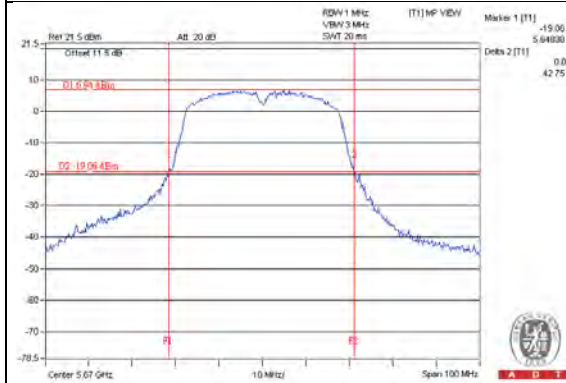

CH142 (UNII-2c Band) / CH142 (UNII-3 Band)

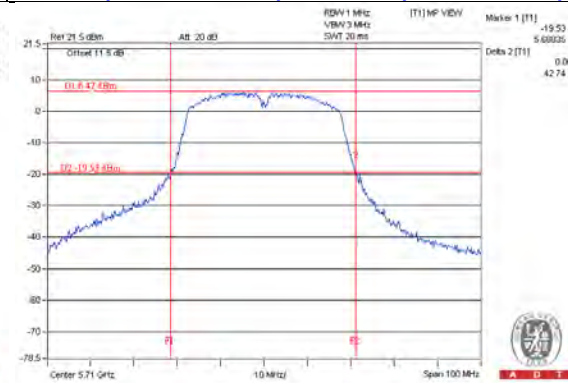

NOTE:

For CH142 (UNII-2c Band) = 5725 - Marker 1

For Reference only – Power meter value

The power value was measured by power meter with average sensor.

Chan.	Chan. Freq. (MHz)	Average Power (mW)	Average Power (dBm)
142	5710	10.965	10.40

Note: The total power was calculated through formula and record the value for reference only.

4.2 Peak Power Spectral Density Measurement

4.2.1 Limits of Peak Power Spectral Density Measurement

Operation Band	EUT Category		LIMIT
U-NII-1		Outdoor Access Point	17dBm/ MHz
		Fixed point-to-point Access Point	
		Indoor Access Point	
	√	Mobile and Portable client device	11dBm/ MHz
U-NII-2A		√	11dBm/ MHz
U-NII-2C		√	11dBm/ MHz
U-NII-3		√	30dBm/ MHz

4.2.2 Test Setup

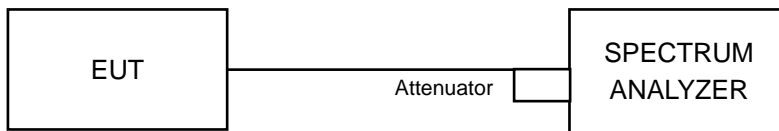

4.2.3 Test Instruments

DESCRIPTION & MANUFACTURER	MODEL NO.	SERIAL NO.	CALIBRATED DATE	CALIBRATED UNTIL
Spectrum Analyzer R&S	FSP40	100060	May 08, 2015	May 07, 2016

- NOTE:**
1. The test was performed in Oven room 2.
 2. The calibration interval of the above test instruments is 12 months and the calibrations are traceable to NML/ROC and NIST/USA.
 3. Tested Date: Nov. 16, 2015

4.2.4 Test Procedures

For U-NII-1, U-NII-2A & U-NII-2C

Using method SA-1

- a. Set span to encompass the entire emission bandwidth (EBW) of the signal.
- b. Set RBW = 1 MHz, Set VBW \geq 3 MHz, Detector = RMS
- c. Sweep time = auto, trigger set to "free run".
- d. Trace average at least 100 traces in power averaging mode.
- e. Record the max value

For U-NII-3:

- a. Set span to encompass the entire emission bandwidth (EBW) of the signal.
- b. Set RBW = 300 kHz, Set VBW \geq 1 MHz, Detector = RMS
- c. Use the peak marker function to determine the maximum power level in any 300 kHz band segment within the fundamental EBW.
- d. Scale the observed power level to an equivalent value in 500 kHz by adjusting (reducing) the measured power by a bandwidth correction factor (BWCF) where $BWCF = 10\log(500 \text{ kHz}/300\text{kHz})$
- e. Sweep time = auto, trigger set to "free run".
- f. Trace average at least 100 traces in power averaging mode.
- g. Record the max value

4.2.5 Deviation from Test Standard

No deviation.

4.2.6 EUT Operating Conditions

The software provided by client to enable the EUT under transmission condition continuously at lowest, middle and highest channel frequencies individually.

4.2.7 Test Results

For U-NII-1, U-NII-2A & U-NII-2C:

802.11a

Chan.	Chan. Freq. (MHz)	Power Density (dBm)	MAX. Limit (dBm)	Pass / Fail
36	5180	-1.47	11	Pass
40	5200	-2.15	11	Pass
48	5240	-1.89	11	Pass
52	5260	-0.56	11	Pass
60	5300	0.04	11	Pass
64	5320	0.65	11	Pass
100	5500	-0.26	11	Pass
120	5600	0.72	11	Pass
140	5700	-1.26	11	Pass
144 (UNII-2c Band)	5720	-1.10	11	Pass

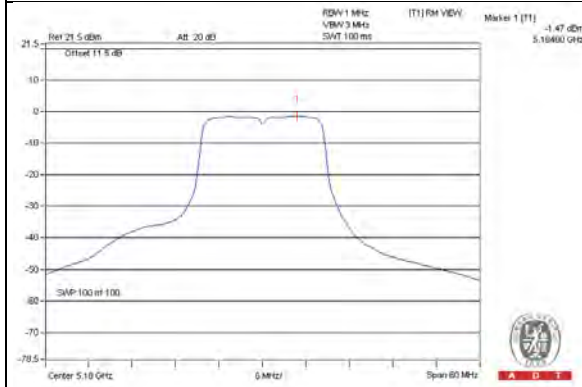
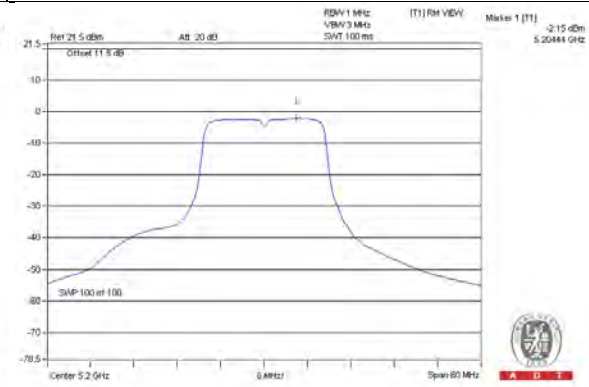
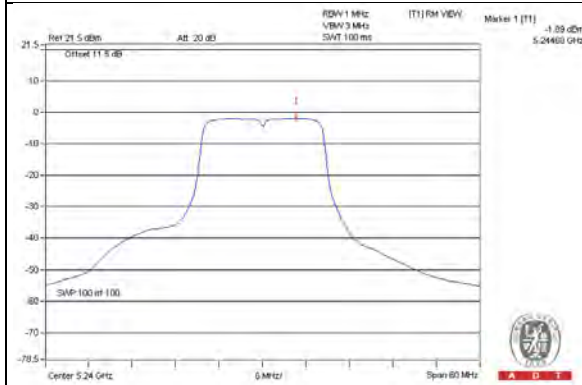
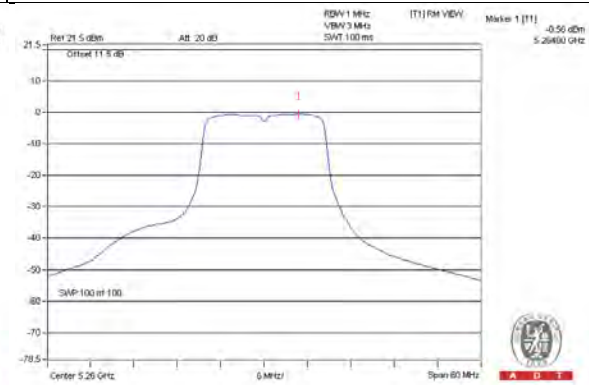
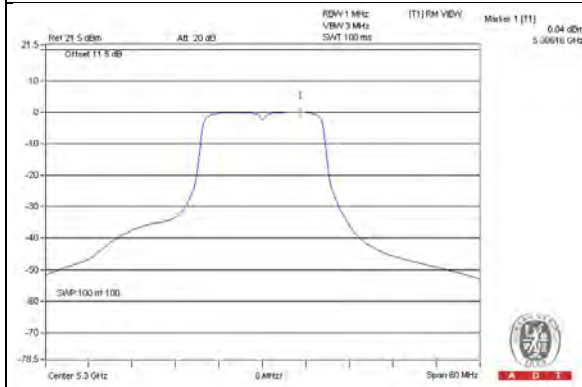
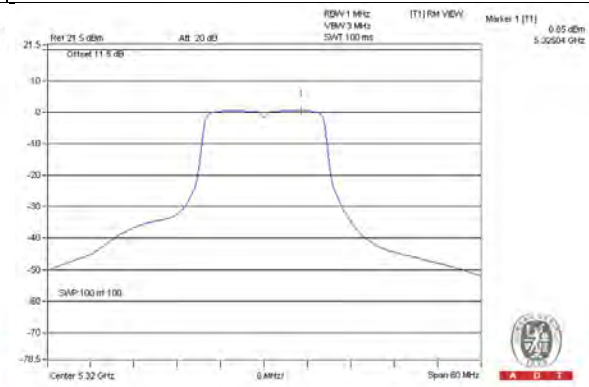
CH36**CH40****CH48****CH52****CH60****CH64**

CH100

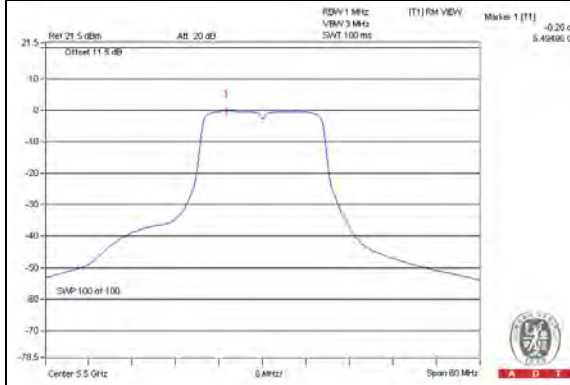

CH120

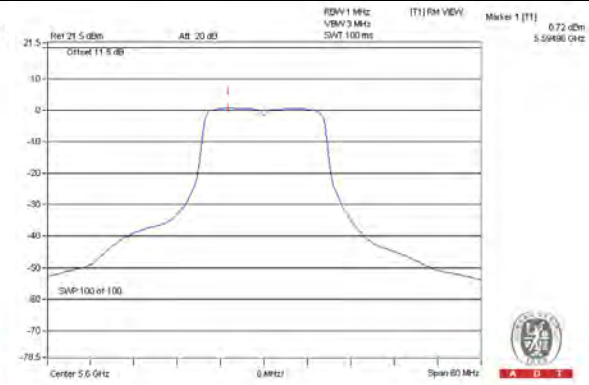

CH140

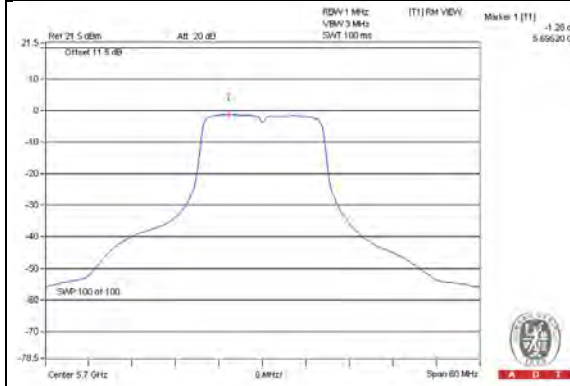

CH144 (UNII-2c Band)

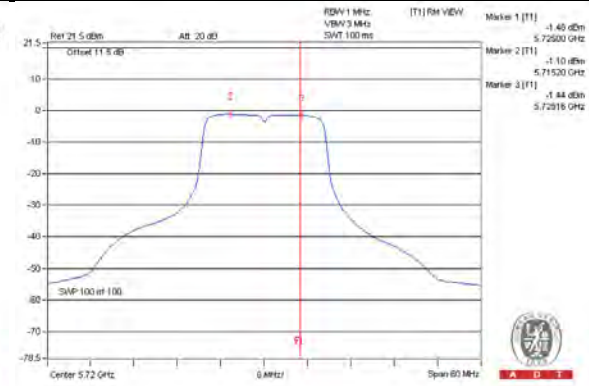

802.11n (HT20)

Chan.	Chan. Freq. (MHz)	Power Density (dBm)	MAX. Limit (dBm)	Pass / Fail
36	5180	-1.82	11	Pass
40	5200	-1.82	11	Pass
48	5240	-1.13	11	Pass
52	5260	-1.37	11	Pass
60	5300	-0.28	11	Pass
64	5320	0.33	11	Pass
100	5500	-0.51	11	Pass
120	5600	0.37	11	Pass
140	5700	-2.07	11	Pass
144 (UNII-2c Band)	5720	-1.96	11	Pass

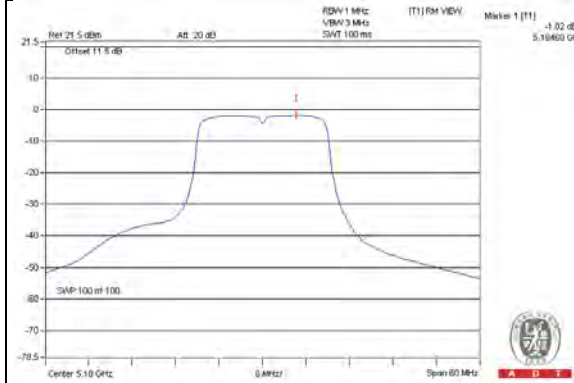
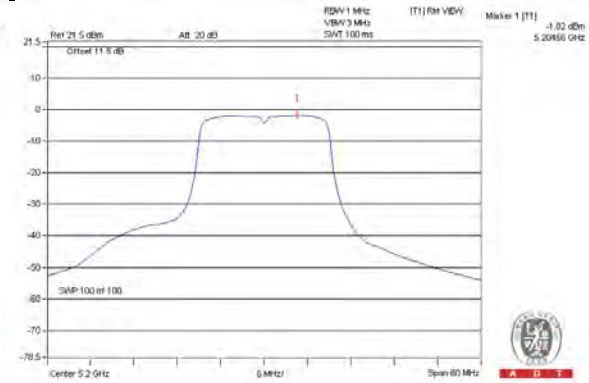
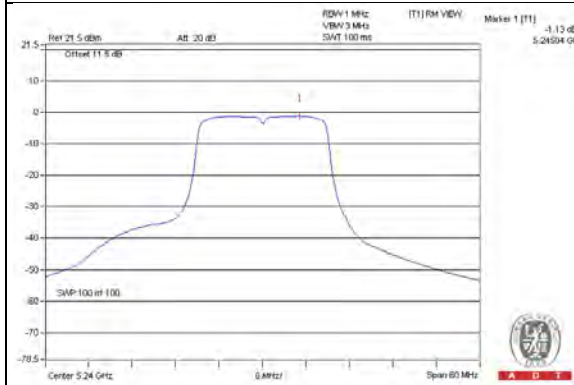
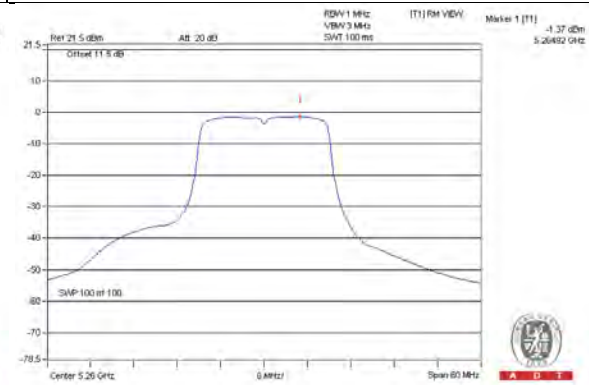
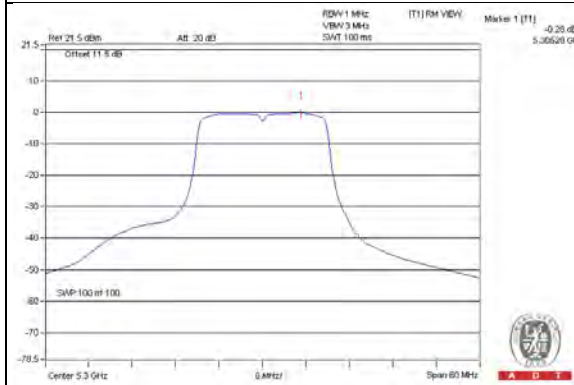
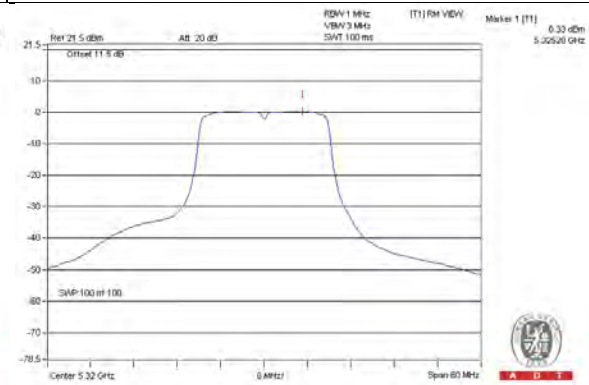
CH36**CH40****CH48****CH52****CH60****CH64**

CH100

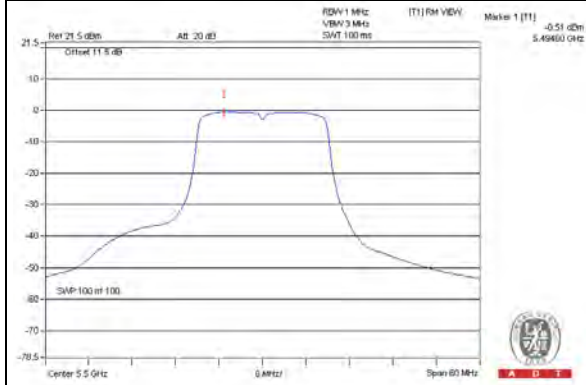

CH120

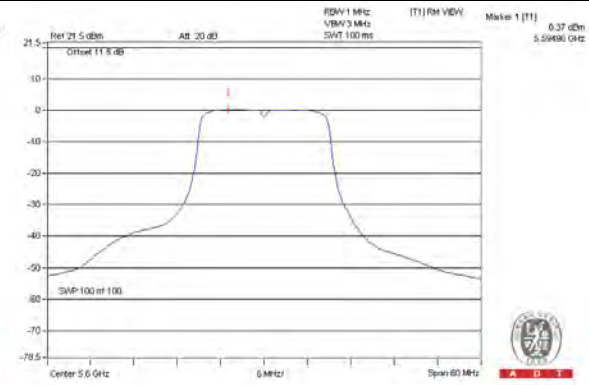

CH140

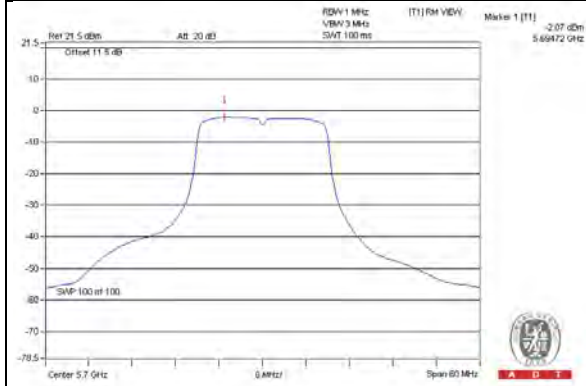

CH144 (UNII-2c Band)

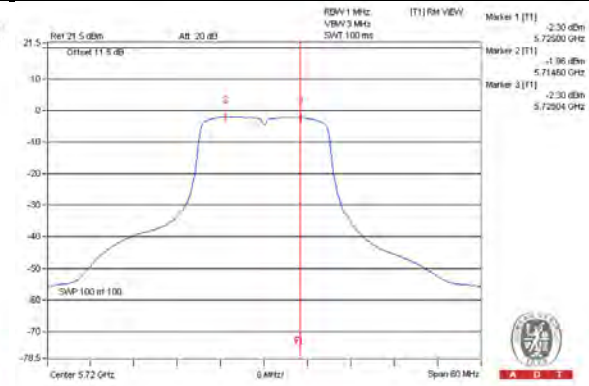

802.11n (HT40)

Chan.	Chan. Freq. (MHz)	Power Density (dBm)	MAX. Limit (dBm)	Pass / Fail
38	5190	-5.27	11	Pass
46	5230	-4.49	11	Pass
54	5270	-4.96	11	Pass
62	5310	-2.96	11	Pass
102	5510	-3.08	11	Pass
118	5590	-2.52	11	Pass
134	5670	-4.61	11	Pass
142 (UNII-2c Band)	5710	-5.17	11	Pass

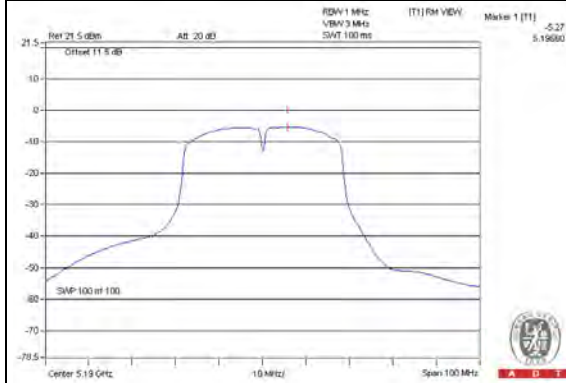
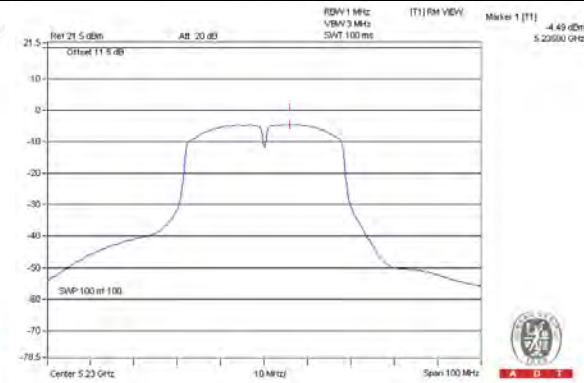
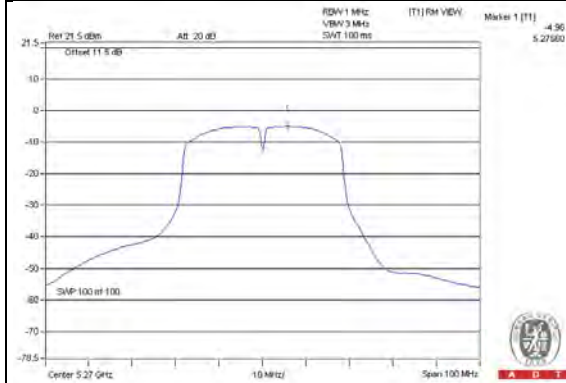
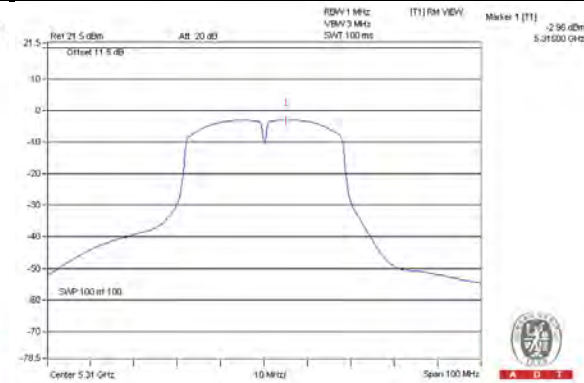
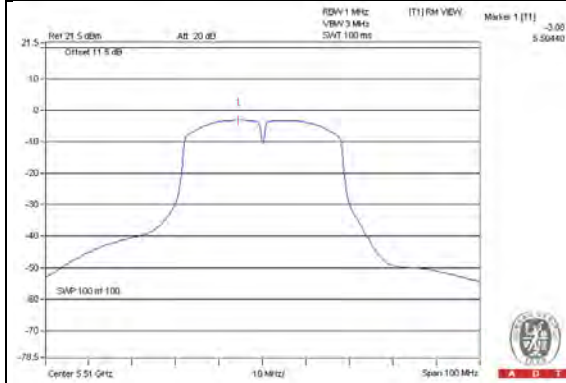
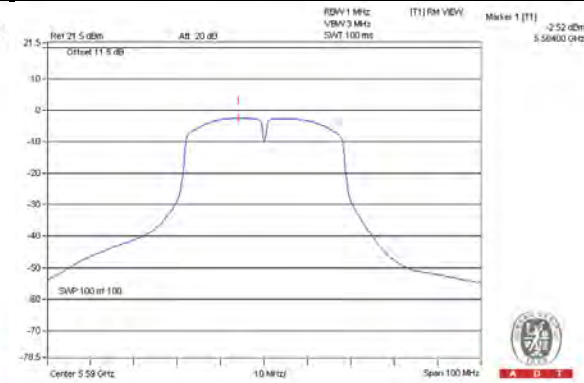
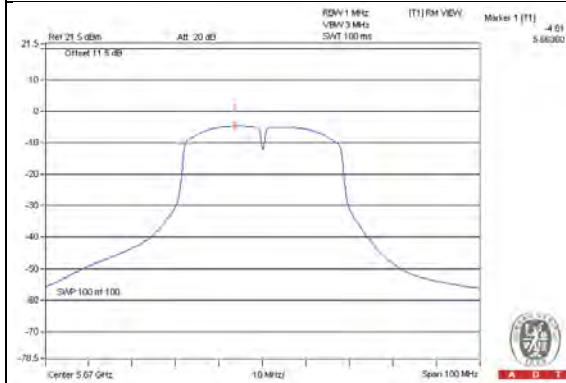
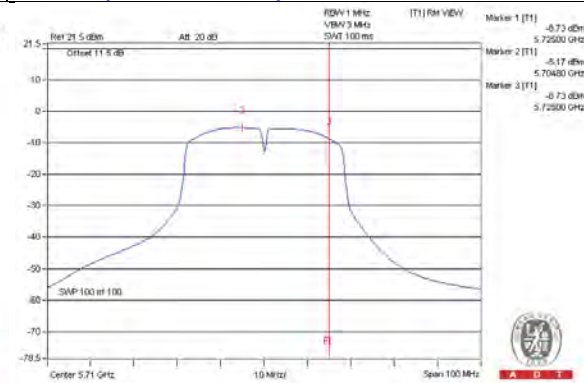
CH38**CH46****CH54****CH62****CH102****CH118****CH134****CH142 (UNII-2c Band)**

For U-NII-3:
802.11a

Chan.	Chan. Freq. (MHz)	PSD (dBm/300kHz)	PSD (dBm/500kHz)	Limit (dBm/500kHz)	Pass /Fail
144 (UNII-3 Band)	5720	-9.45	-7.23	30	Pass
149	5745	-8.91	-6.69	30	Pass
157	5785	-9.27	-7.05	30	Pass
165	5825	-10.04	-7.82	30	Pass

CH144 (UNII-3 Band)

CH149

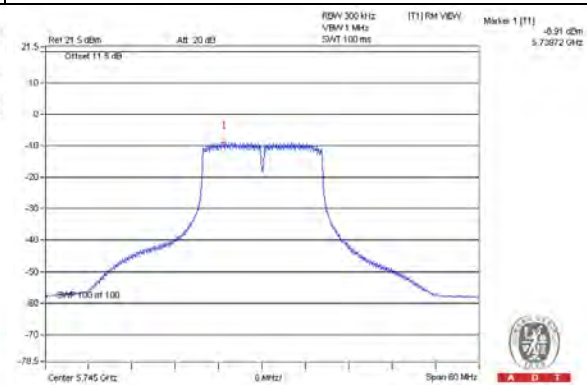
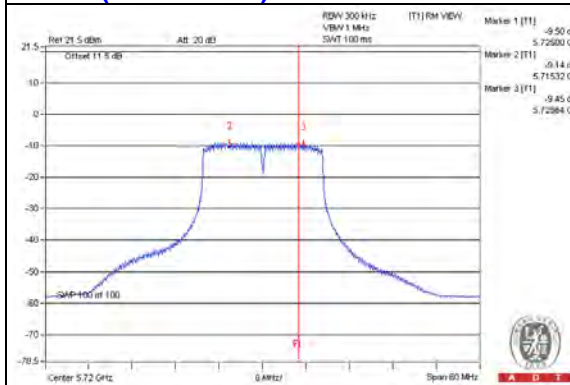

CH157

CH165

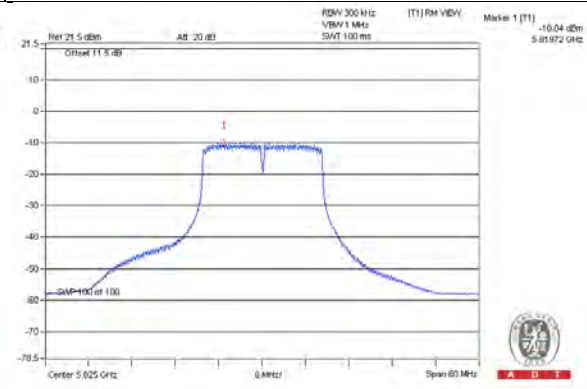
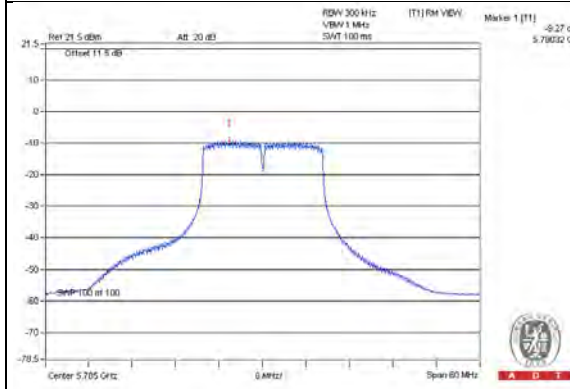

802.11n (HT20)

Chan.	Chan. Freq. (MHz)	PSD (dBm/300kHz)	PSD (dBm/500kHz)	Limit (dBm/500kHz)	Pass /Fail
144 (UNII-3 Band)	5720	-10.31	-8.09	30	Pass
149	5745	-9.38	-7.16	30	Pass
157	5785	-10.03	-7.81	30	Pass
165	5825	-10.26	-8.04	30	Pass

CH144 (UNII-3 Band)

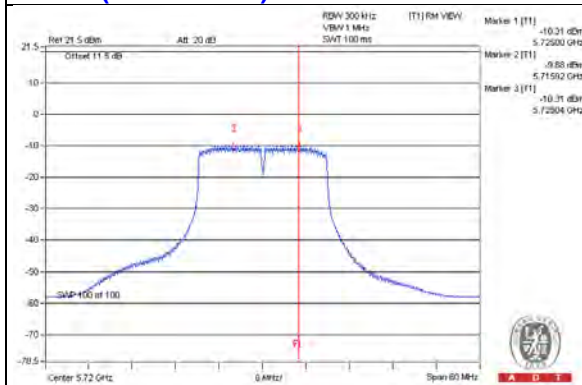

CH149

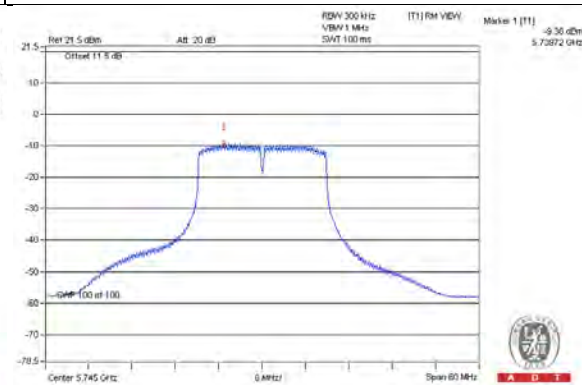

CH157

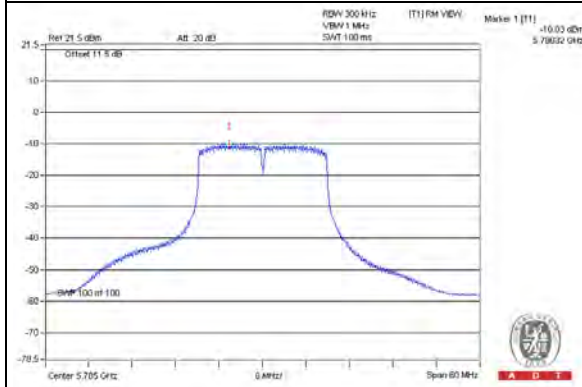

CH165

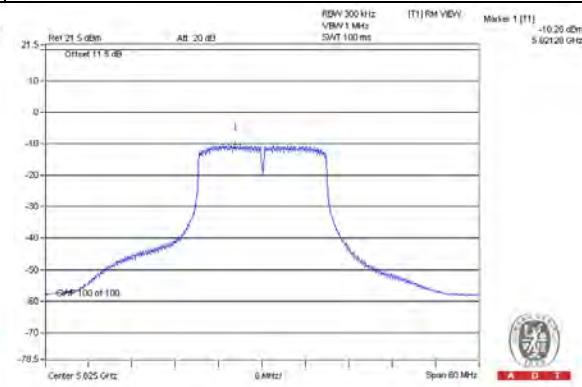

802.11n (HT40)

Chan.	Chan. Freq. (MHz)	PSD (dBm/300kHz)	PSD (dBm/500kHz)	Limit (dBm/500kHz)	Pass /Fail
142 (UNII-3 Band)	5710	-17.03	-14.81	30	Pass
151	5755	-13.53	-11.31	30	Pass
159	5795	-13.63	-11.41	30	Pass

CH142 (UNII-3 Band)

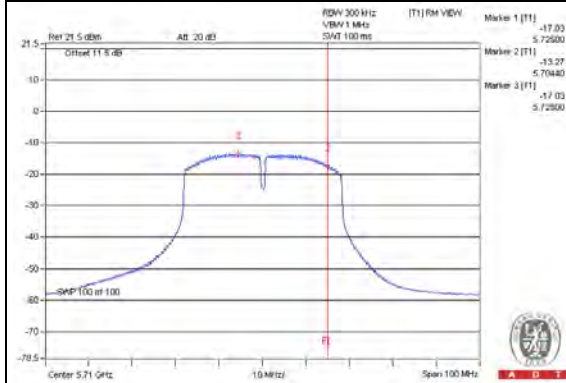

CH151

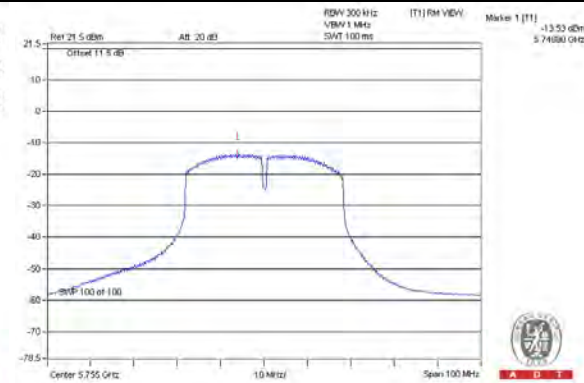

CH159

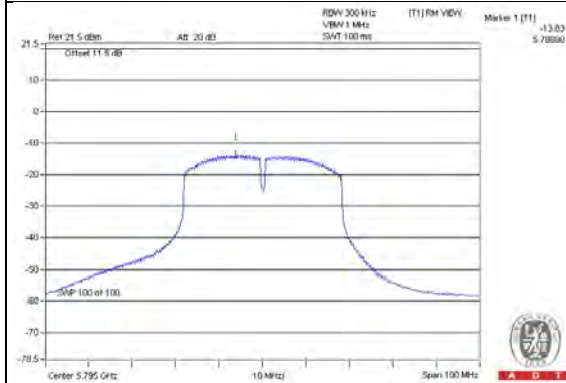

4.3 6dB Bandwidth Measurement

4.3.1 Limits of 6dB Bandwidth Measurement

The minimum of 6dB Bandwidth Measurement is 0.5MHz.

4.3.2 Test Setup

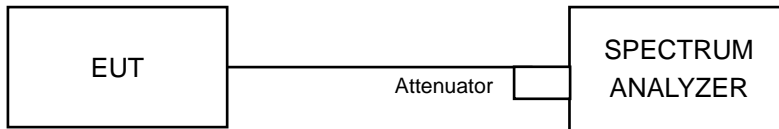

4.3.3 Test Instruments

DESCRIPTION & MANUFACTURER	MODEL NO.	SERIAL NO.	CALIBRATED DATE	CALIBRATED UNTIL
Spectrum Analyzer R&S	FSP40	100060	May 08, 2015	May 07, 2016

- NOTE:**
1. The test was performed in Oven room 2.
 2. The calibration interval of the above test instruments is 12 months and the calibrations are traceable to NML/ROC and NIST/USA.
 3. Tested Date: Nov. 16, 2015

4.3.4 Test Procedures

MEASUREMENT PROCEDURE REF

- a. Set resolution bandwidth (RBW) = 100kHz
- b. Set the video bandwidth (VBW) $\geq 3 \times$ RBW, Detector = Peak.
- c. Trace mode = max hold.
- d. Sweep = auto couple.
- e. Measure the maximum width of the emission that is constrained by the frequencies associated with the two amplitude points (upper and lower) that are attenuated by 6 dB relative to the maximum level measured in the fundamental emission

4.3.5 Deviation from Test Standard

No deviation.

4.3.6 EUT Operating Conditions

The software provided by client to enable the EUT under transmission condition continuously at lowest, middle and highest channel frequencies individually.

4.3.7 Test Results

802.11a

Channel	Frequency (MHz)	6dB Bandwidth (MHz)	Minimum Limit (MHz)	Pass / Fail
144 (UNII-3 Band)	5720	3.23	0.5	Pass
149	5745	16.51	0.5	Pass
157	5785	16.54	0.5	Pass
165	5825	16.45	0.5	Pass

Note: 1. The 6dB bandwidth above 5725MHz = Marker 1 + Delta 2 - 5725MHz

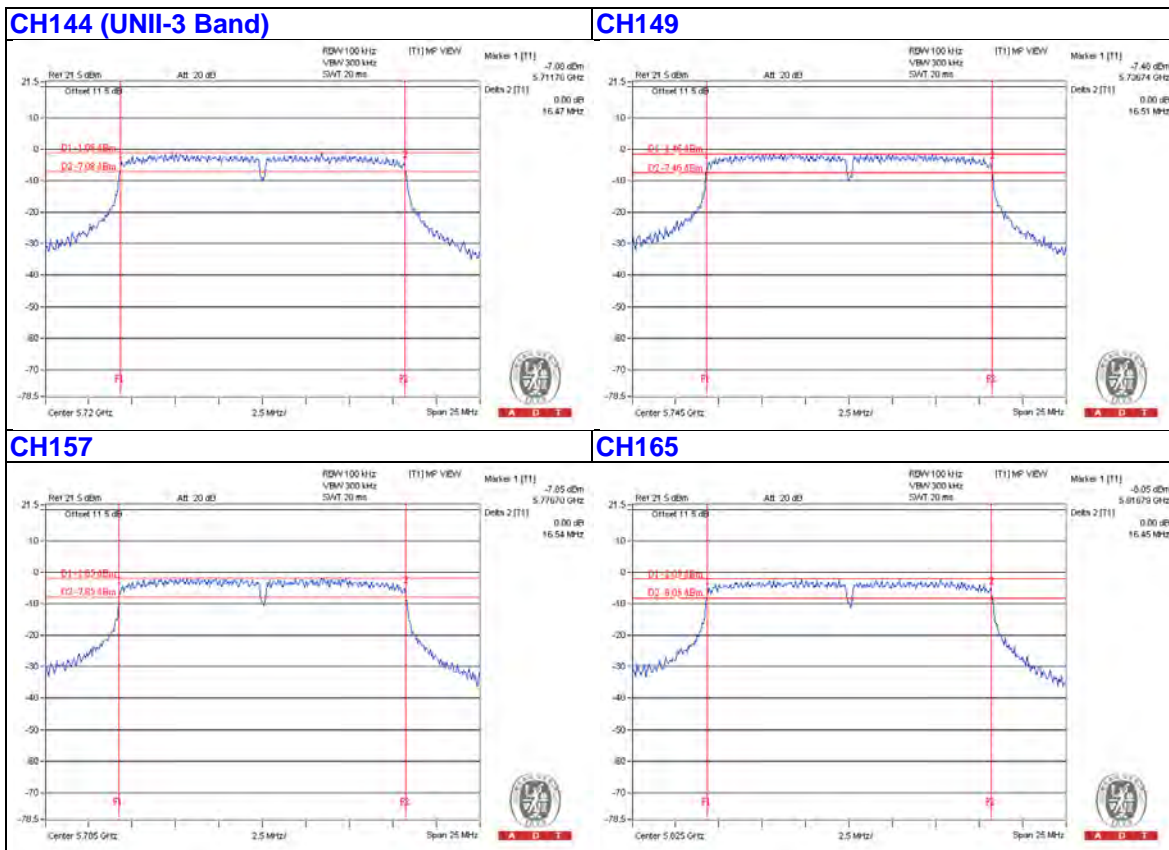

802.11n (HT20)

Channel	Frequency (MHz)	6dB Bandwidth (MHz)	Minimum Limit (MHz)	Pass / Fail
144 (UNII-3 Band)	5720	3.86	0.5	Pass
149	5745	17.69	0.5	Pass
157	5785	17.70	0.5	Pass
165	5825	17.71	0.5	Pass

Note: 1. The 6dB bandwidth above 5725MHz = Marker 1 + Delta 2 - 5725MHz

CH144 (UNII-3 Band)

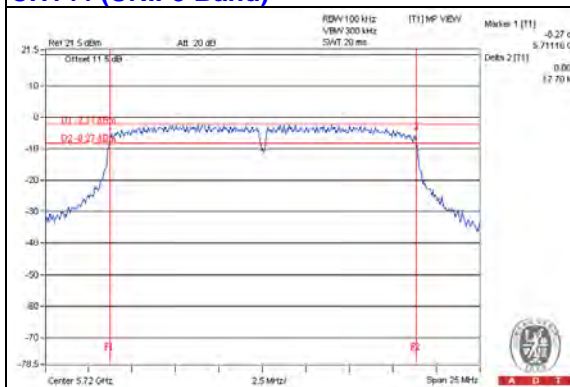

CH149

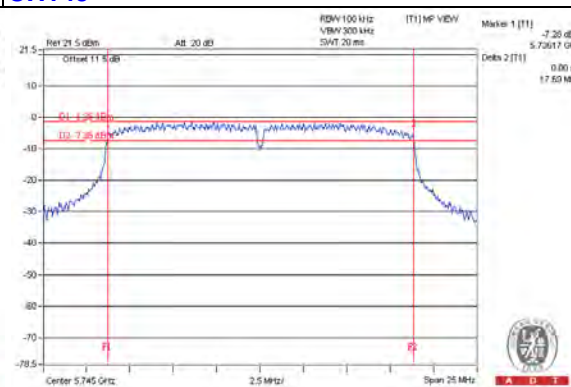

CH157

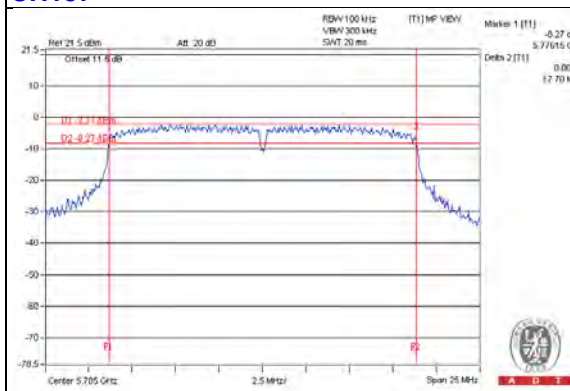

CH165

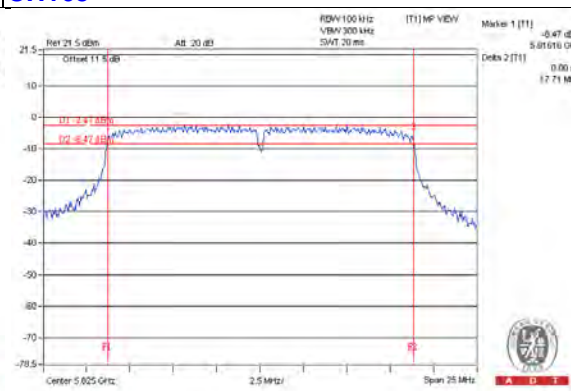

802.11n (HT40)

Channel	Frequency (MHz)	6dB Bandwidth (MHz)	Minimum Limit (MHz)	Pass / Fail
142 (UNII-3 Band)	5710	1.91	0.5	Pass
151	5755	33.16	0.5	Pass
159	5795	34.93	0.5	Pass

Note: 1. The 6dB bandwidth above 5725MHz = Marker 1 + Delta 2 - 5725MHz

CH142 (UNII-3 Band)

CH151

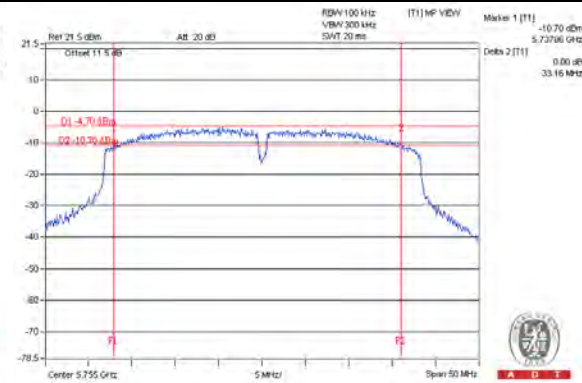
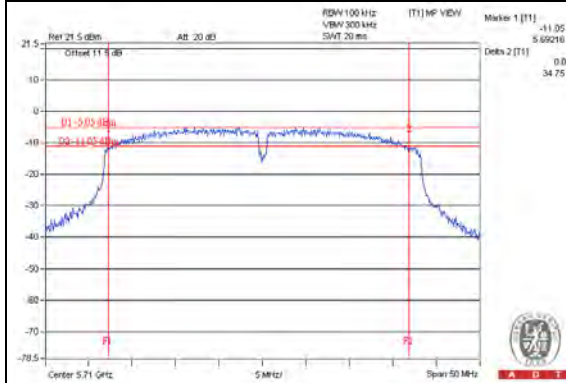

CH159

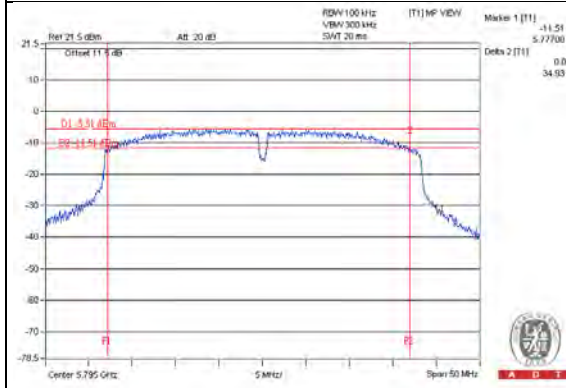

4.4 Unwanted Emission Measurement (Radiated Versus Conducted)

4.4.1 Limits of Unwanted Emission Measurement

Radiated emissions which fall in the restricted bands must comply with the radiated emission limits specified as below table.

Frequencies (MHz)	Field Strength (microvolts/meter)	Measurement Distance (meters)
0.009 ~ 0.490	2400/F(kHz)	300
0.490 ~ 1.705	24000/F(kHz)	30
1.705 ~ 30.0	30	30
30 ~ 88	100	3
88 ~ 216	150	3
216 ~ 960	200	3
Above 960	500	3

NOTE:

1. The lower limit shall apply at the transition frequencies.
2. Emission level (dBuV/m) = 20 log Emission level (uV/m).
3. For frequencies above 1000MHz, the field strength limits are based on average detector, however, the peak field strength of any emission shall not exceed the maximum permitted average limits, specified above by more than 20dB under any condition of modulation.

Limits of Unwanted Emission out of the Restricted Bands

APPLICABLE TO	LIMIT	
789033 D02 General UNII Test Procedure New Rules v01	FIELD STRENGTH AT 3m	
	PK:74 (dBµV/m)	AV:54 (dBµV/m)
APPLICABLE TO	EIRP LIMIT	EQUIVALENT FIELD STRENGTH AT 3m
15.407(b)(1)	PK:-27 (dBm/MHz)	PK:68.2 (dBµV/m)
15.407(b)(2)		
15.407(b)(3)		
15.407(b)(4)	PK:-27 (dBm/MHz) ^{*1} PK:-17 (dBm/MHz) ^{*2}	PK:68.2 (dBµV/m) ^{*1} PK:78.2 (dBµV/m) ^{*2}

NOTE: ^{*1} beyond 10MHz of the band edge ^{*2} within 10 MHz of band edge

The following formula is used to convert the equipment isotropic radiated power (eirp) to field strength:

$$E = \frac{1000000 \sqrt{30P}}{3} \mu\text{V/m, where P is the eirp (Watts).$$

4.4.2 Test Instruments

For below 1GHz

DESCRIPTION & MANUFACTURER	MODEL NO.	SERIAL NO.	CALIBRATED DATE	CALIBRATED UNTIL
Test Receiver Agilent	N9038A	MY54450088	July 24, 2015	July 23, 2016
Pre-Amplifier Mini-Circuits	ZFL-1000VH2 B	AMP-ZFL-06	Nov. 12, 2014	Nov. 11, 2015
Trilog Broadband Antenna SCHWARZBECK	VULB 9168	9168-406	Feb. 03, 2015	Feb. 02, 2016
RF Cable	8D	966-4-1 966-4-2 966-4-3	Apr. 03, 2015	Apr. 02, 2016
Software	ADT_Radiated _V8.7.07	NA	NA	NA
Antenna Tower & Turn Table CT	NA	NA	NA	NA

Note:

1. The calibration interval of the above test instruments is 12 months and the calibrations are traceable to NML/ROC and NIST/USA.
2. The horn antenna, preamplifier (model: 8449B) are used only for the measurement of emission frequency above 1GHz if tested.
3. The test was performed in 966 Chamber No. 4.
4. The FCC Site Registration No. is 292998
5. The CANADA Site Registration No. is 20331-2
6. Tested Date: Nov. 10, 2015

For above 1GHz

DESCRIPTION & MANUFACTURER	MODEL NO.	SERIAL NO.	CALIBRATED DATE	CALIBRATED UNTIL
Test Receiver Agilent	N9038A	MY54450088	July 24, 2015	July 23, 2016
Horn_Antenna SCHWARZBECK	BBHA 9120D	9120D-783	Feb. 06, 2015	Feb. 05, 2016
Pre-Amplifier Agilent	8449B	3008A01922	Sep. 19, 2015	Sep. 18, 2016
RF Cable	EMC104-SM-SM-2000 EMC104-SM-SM-5000 EMC104-SM-SM-5000	150318 150323 150324	Mar. 31, 2015	Mar. 30, 2016
Pre-Amplifier EMCI	EMC184045	980143	Jan. 16, 2015	Jan. 15, 2016
Horn_Antenna SCHWARZBECK	BBHA 9170	BBHA9170608	Feb. 05, 2015	Feb. 04, 2016
RF Cable	SUCOFLEX 104	329751/4 RF104-204	Dec. 11, 2014	Dec. 10, 2015
Software	ADT_Radiated _V8.7.07	NA	NA	NA
Antenna Tower & Turn Table CT	NA	NA	NA	NA

Note:

1. The calibration interval of the above test instruments is 12 months and the calibrations are traceable to NML/ROC and NIST/USA.
2. The horn antenna, preamplifier (model: 8449B) are used only for the measurement of emission frequency above 1GHz if tested.
3. The test was performed in 966 Chamber No. 4.
4. The FCC Site Registration No. is 292998
5. The CANADA Site Registration No. is 20331-2
6. Tested Date: Nov. 25, 2015

4.4.3 Test Procedures

Following FCC KDB 789033 D02 General UNII Test Procedures:
Radiated versus Conducted Measurements.

The unwanted emission limits in both the restricted and non-restricted bands are based on antenna-port conducted measurements in conjunction with cabinet emissions tests are permitted to demonstrate compliance.

The following steps was performed:

- a. Cabinet emissions measurements. Radiated measurement was performed to ensure that cabinet emissions are below the emission limits. For the cabinet-emission measurements the antenna was replaced by a termination matching the nominal impedance of the antenna.
- b. Conducted tests was performed using equipment that matches the nominal impedance of the antenna assembly used with the EUT
- c. EIRP calculation. A value representative of an upper bound on out-of-band antenna gain (in dBi) shall be added to the measured antenna-port conducted emission power to compute EIRP within the specified measurement bandwidth. (For emissions in the restricted bands, additional calculations are required to convert EIRP to field strength at the specified distance.) The upper bound on antenna gain for a device with a single RF output shall be selected as the maximum in-band gain of the antenna across all operating bands or 2 dBi, whichever is greater
- d. For all of Radiation emission test
 - d-1. The EUT was placed on the top of a rotating table 0.8 meters (for below 1GHz) / 1.5 meters (for above 1GHz) above the ground at a 3 meters chamber room. The table was rotated 360 degrees to determine the position of the highest radiation.
 - d-2. The EUT was set 3 meters away from the interference-receiving antenna, which was mounted on the top of a variable-height antenna tower.
 - d-3. The height of antenna is varied from one meter to four meters above the ground to determine the maximum value of the field strength. Both horizontal and vertical polarizations of the antenna are set to make the measurement.
 - d-4. For each suspected emission, the EUT was arranged to its worst case and then the antenna was tuned to heights from 1 meter to 4 meters and the rotatable table was turned from 0 degrees to 360 degrees to find the maximum reading.
 - d-5. The test-receiver system was set to Peak Detect Function and Specified Bandwidth with Maximum Hold Mode.
 - d-6. If the emission level of the EUT in peak mode was 10dB lower than the limit specified, then testing could be stopped and the peak values of the EUT would be reported. Otherwise the emissions that did not have 10dB margin would be re-tested one by one using peak, quasi-peak or average method as specified and then reported in a data sheet.

NOTE:

1. The resolution bandwidth and video bandwidth of test receiver/spectrum analyzer is 120kHz for Quasi-peak detection (QP) at frequency below 1GHz.
2. The resolution bandwidth of test receiver/spectrum analyzer is 1 MHz and the video bandwidth is 3 MHz for Peak detection (PK) at frequency above 1GHz.
3. The resolution bandwidth of test receiver/spectrum analyzer is 1MHz and the video bandwidth is $\geq 1/T$ (Duty cycle $< 98\%$) or 10Hz (Duty cycle $\geq 98\%$) for Average detection (AV) at frequency above 1GHz.
4. All modes of operation were investigated and the worst-case emissions are reported.

4.4.4 Deviation from Test Standard

No deviation.

4.4.5 Test Setup

For radiated configuration:

<Frequency Range below 1GHz>

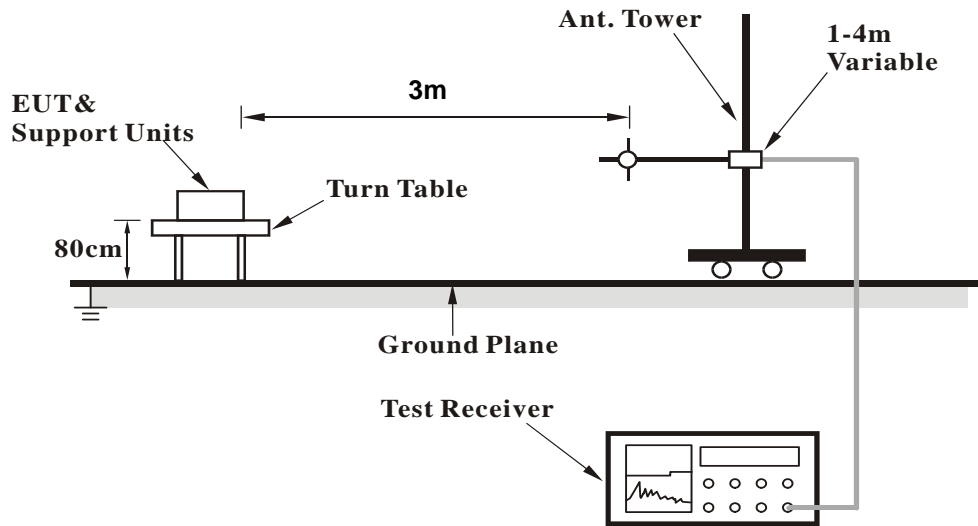

<Frequency Range above 1GHz>

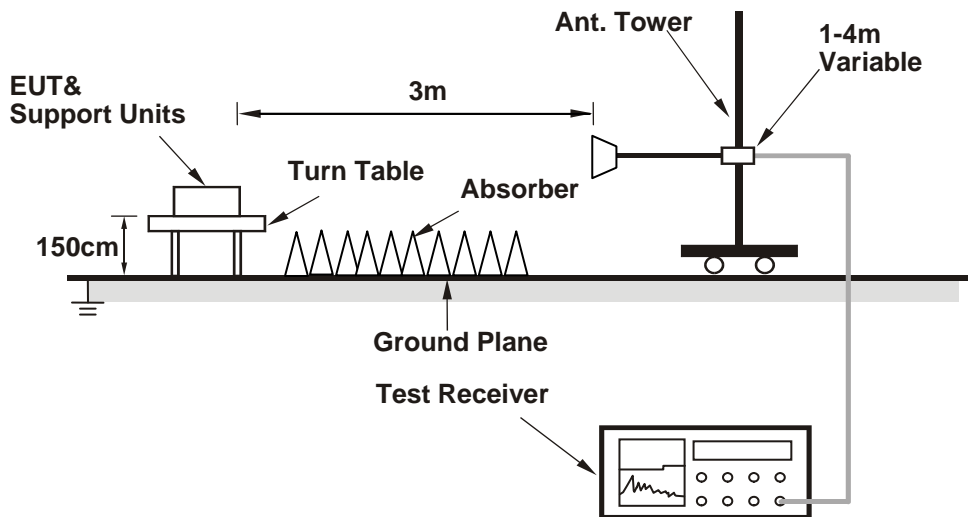

For conducted configuration:

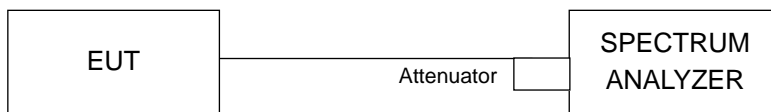

For the actual test configuration, please refer to the attached file (Test Setup Photo).

4.4.6 EUT Operating Conditions

1. Connect the EUT with the support unit A (Notebook Computer) which is placed on a testing table.
2. The communication partner run test program "artgui.exe V2.3" to enable EUT under transmission/receiving condition continuously at specific channel frequency.

4.4.7 Test Results (Radiated Measurement)

Radiated versus Conducted Measurement	
<input type="checkbox"/> Conducted measurement	<input checked="" type="checkbox"/> Radiated measurement
<u>For Radiated measurement:</u> The level of unwanted emissions was measured when radiated by the cabinet or structure of the equipment with the antenna connector(s) terminated by a specified load (cabinet radiation)	
<u>For Conducted measurement:</u> The level of unwanted emissions was measured as their power in a specified load (conducted spurious emissions).	

Radiated test was done with 50ohm terminator on antenna port

Above 1GHz Data

802.11a

CHANNEL	TX Channel 36	DETECTOR FUNCTION	Peak (PK) Average (AV)
FREQUENCY RANGE	1GHz ~ 40GHz		

ANTENNA POLARITY & TEST DISTANCE: HORIZONTAL AT 3 M								
NO.	FREQ. (MHz)	EMISSION LEVEL (dBuV/m)	LIMIT (dBuV/m)	MARGIN (dB)	ANTENNA HEIGHT (m)	TABLE ANGLE (Degree)	RAW VALUE (dBuV)	CORRECTION FACTOR (dB/m)
1	#10360.00	50.4 PK	74.0	-23.6	3.41 H	172	37.10	13.30
2	#10360.00	38.8 AV	54.0	-15.2	3.41 H	172	25.50	13.30
3	15540.00	57.6 PK	74.0	-16.4	3.32 H	335	42.03	15.57
4	15540.00	46.5 AV	54.0	-7.5	3.32 H	335	30.93	15.57

REMARKS:

1. Emission Level(dBuV/m) = Raw Value(dBuV) + Correction Factor(dB/m)
2. Correction Factor(dB/m) = Antenna Factor(dB/m) + Cable Factor(dB) – Pre-Amplifier Factor(dB)
3. The other emission levels were very low against the limit.
4. Margin value = Emission Level – Limit value
5. " # ": The radiated frequency is out of the restricted band.

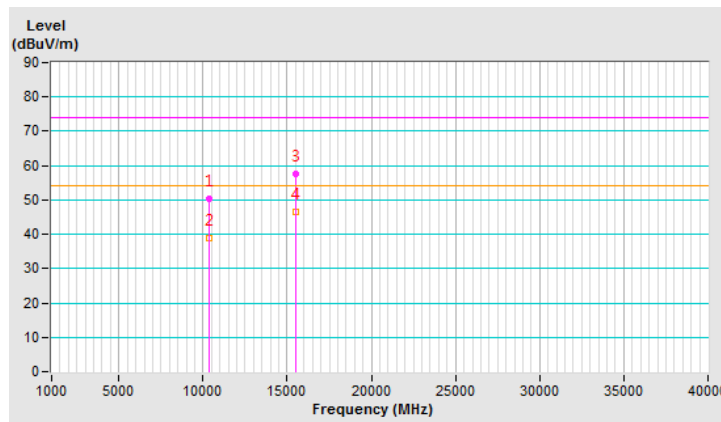

CHANNEL	TX Channel 36	DETECTOR FUNCTION	Peak (PK)
FREQUENCY RANGE	1GHz ~ 40GHz		Average (AV)

ANTENNA POLARITY & TEST DISTANCE: VERTICAL AT 3 M								
NO.	FREQ. (MHz)	EMISSION LEVEL (dBuV/m)	LIMIT (dBuV/m)	MARGIN (dB)	ANTENNA HEIGHT (m)	TABLE ANGLE (Degree)	RAW VALUE (dBuV)	CORRECTION FACTOR (dB/m)
1	#10360.00	56.1 PK	74.0	-17.9	3.37 V	302	42.80	13.30
2	#10360.00	44.4 AV	54.0	-9.6	3.37 V	302	31.10	13.30
3	15540.00	61.5 PK	74.0	-12.5	3.37 V	289	45.93	15.57
4	15540.00	48.8 AV	54.0	-5.2	3.37 V	289	33.23	15.57

REMARKS:

1. Emission Level(dBuV/m) = Raw Value(dBuV) + Correction Factor(dB/m)
2. Correction Factor(dB/m) = Antenna Factor(dB/m) + Cable Factor(dB) – Pre-Amplifier Factor(dB)
3. The other emission levels were very low against the limit.
4. Margin value = Emission Level – Limit value
5. " # ": The radiated frequency is out of the restricted band.

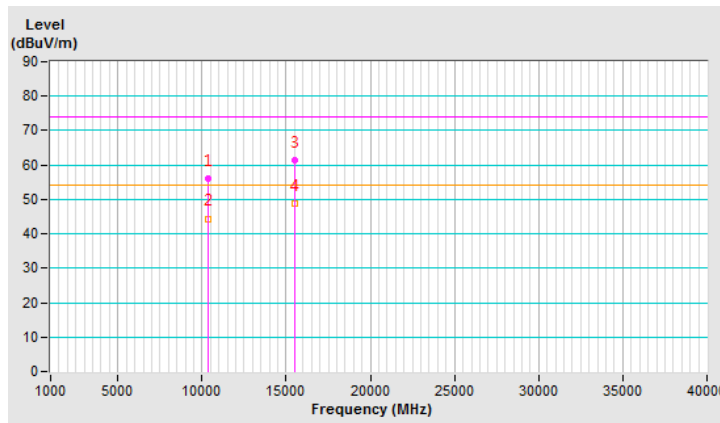

CHANNEL	TX Channel 40	DETECTOR FUNCTION	Peak (PK)
FREQUENCY RANGE	1GHz ~ 40GHz		Average (AV)

ANTENNA POLARITY & TEST DISTANCE: HORIZONTAL AT 3 M								
NO.	FREQ. (MHz)	EMISSION LEVEL (dBuV/m)	LIMIT (dBuV/m)	MARGIN (dB)	ANTENNA HEIGHT (m)	TABLE ANGLE (Degree)	RAW VALUE (dBuV)	CORRECTION FACTOR (dB/m)
1	#10400.00	50.0 PK	74.0	-24.0	3.34 H	167	36.36	13.64
2	#10400.00	38.0 AV	54.0	-16.0	3.34 H	167	24.36	13.64
3	15600.00	56.4 PK	74.0	-17.6	3.24 H	320	40.75	15.65
4	15600.00	45.2 AV	54.0	-8.8	3.24 H	320	29.55	15.65

REMARKS:

1. Emission Level(dBuV/m) = Raw Value(dBuV) + Correction Factor(dB/m)
2. Correction Factor(dB/m) = Antenna Factor(dB/m) + Cable Factor(dB) – Pre-Amplifier Factor(dB)
3. The other emission levels were very low against the limit.
4. Margin value = Emission Level – Limit value
5. " # ": The radiated frequency is out of the restricted band.

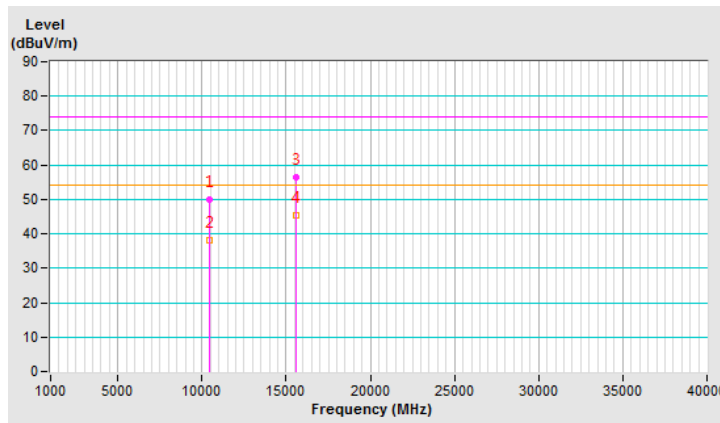

CHANNEL	TX Channel 40	DETECTOR FUNCTION	Peak (PK)
FREQUENCY RANGE	1GHz ~ 40GHz		Average (AV)

ANTENNA POLARITY & TEST DISTANCE: VERTICAL AT 3 M								
NO.	FREQ. (MHz)	EMISSION LEVEL (dBuV/m)	LIMIT (dBuV/m)	MARGIN (dB)	ANTENNA HEIGHT (m)	TABLE ANGLE (Degree)	RAW VALUE (dBuV)	CORRECTION FACTOR (dB/m)
1	#10400.00	55.4 PK	74.0	-18.6	2.84 V	185	41.76	13.64
2	#10400.00	43.0 AV	54.0	-11.0	2.84 V	185	29.36	13.64
3	15600.00	60.2 PK	74.0	-13.8	2.64 V	163	44.55	15.65
4	15600.00	47.6 AV	54.0	-6.4	2.64 V	163	31.95	15.65

REMARKS:

1. Emission Level(dBuV/m) = Raw Value(dBuV) + Correction Factor(dB/m)
2. Correction Factor(dB/m) = Antenna Factor(dB/m) + Cable Factor(dB) – Pre-Amplifier Factor(dB)
3. The other emission levels were very low against the limit.
4. Margin value = Emission Level – Limit value
5. " # ": The radiated frequency is out of the restricted band.

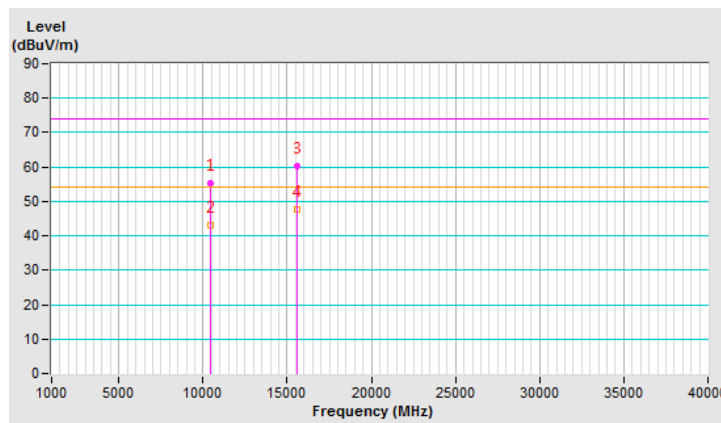

CHANNEL	TX Channel 48	DETECTOR FUNCTION	Peak (PK)
FREQUENCY RANGE	1GHz ~ 40GHz		Average (AV)

ANTENNA POLARITY & TEST DISTANCE: HORIZONTAL AT 3 M

NO.	FREQ. (MHz)	EMISSION LEVEL (dBuV/m)	LIMIT (dBuV/m)	MARGIN (dB)	ANTENNA HEIGHT (m)	TABLE ANGLE (Degree)	RAW VALUE (dBuV)	CORRECTION FACTOR (dB/m)
1	#10480.00	49.6 PK	74.0	-24.4	3.36 H	192	36.05	13.55
2	#10480.00	37.0 AV	54.0	-17.0	3.36 H	192	23.45	13.55
3	15720.00	55.4 PK	74.0	-18.6	3.29 H	322	40.12	15.28
4	15720.00	44.3 AV	54.0	-9.7	3.29 H	322	29.02	15.28

REMARKS:

1. Emission Level(dBuV/m) = Raw Value(dBuV) + Correction Factor(dB/m)
2. Correction Factor(dB/m) = Antenna Factor(dB/m) + Cable Factor(dB) – Pre-Amplifier Factor(dB)
3. The other emission levels were very low against the limit.
4. Margin value = Emission Level – Limit value
5. "#": The radiated frequency is out of the restricted band.

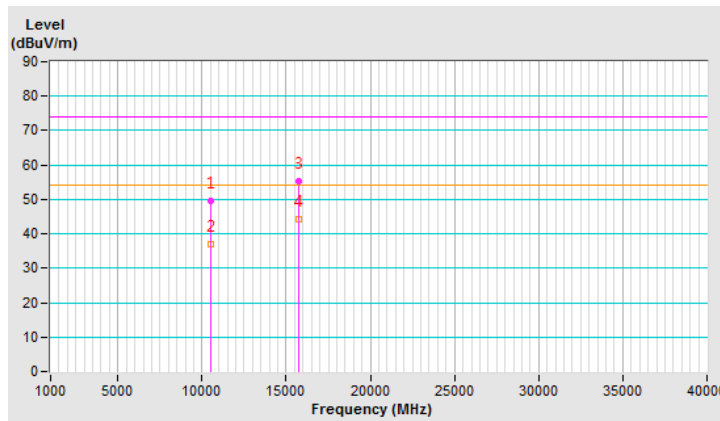

CHANNEL	TX Channel 48	DETECTOR FUNCTION	Peak (PK)
FREQUENCY RANGE	1GHz ~ 40GHz		Average (AV)

ANTENNA POLARITY & TEST DISTANCE: VERTICAL AT 3 M								
NO.	FREQ. (MHz)	EMISSION LEVEL (dBuV/m)	LIMIT (dBuV/m)	MARGIN (dB)	ANTENNA HEIGHT (m)	TABLE ANGLE (Degree)	RAW VALUE (dBuV)	CORRECTION FACTOR (dB/m)
1	#10480.00	54.3 PK	74.0	-19.7	2.84 V	169	40.75	13.55
2	#10480.00	42.6 AV	54.0	-11.4	2.84 V	169	29.05	13.55
3	15720.00	59.2 PK	74.0	-14.8	2.62 V	147	43.92	15.28
4	15720.00	47.0 AV	54.0	-7.0	2.62 V	147	31.72	15.28

REMARKS:

1. Emission Level(dBuV/m) = Raw Value(dBuV) + Correction Factor(dB/m)
2. Correction Factor(dB/m) = Antenna Factor(dB/m) + Cable Factor(dB) – Pre-Amplifier Factor(dB)
3. The other emission levels were very low against the limit.
4. Margin value = Emission Level – Limit value
5. " # ": The radiated frequency is out of the restricted band.

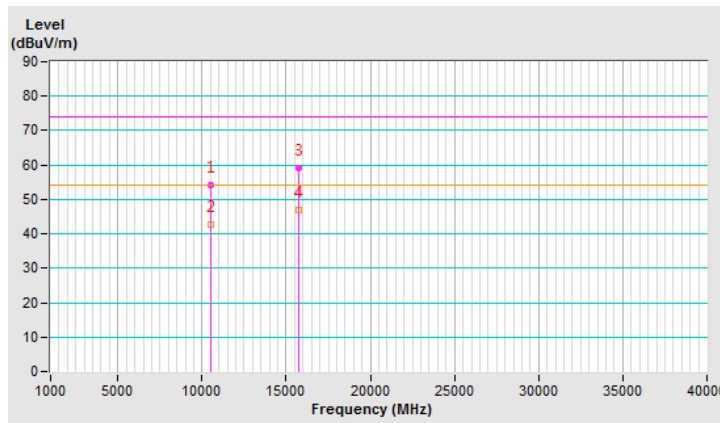

CHANNEL	TX Channel 52	DETECTOR FUNCTION	Peak (PK)
FREQUENCY RANGE	1GHz ~ 40GHz		Average (AV)

ANTENNA POLARITY & TEST DISTANCE: HORIZONTAL AT 3 M								
NO.	FREQ. (MHz)	EMISSION LEVEL (dBuV/m)	LIMIT (dBuV/m)	MARGIN (dB)	ANTENNA HEIGHT (m)	TABLE ANGLE (Degree)	RAW VALUE (dBuV)	CORRECTION FACTOR (dB/m)
1	#10520.00	49.7 PK	74.0	-24.3	3.40 H	152	36.11	13.59
2	#10520.00	37.6 AV	54.0	-16.4	3.40 H	152	24.01	13.59
3	15780.00	56.8 PK	74.0	-17.2	3.29 H	330	41.67	15.13
4	15780.00	45.4 AV	54.0	-8.6	3.29 H	330	30.27	15.13

REMARKS:

1. Emission Level(dBuV/m) = Raw Value(dBuV) + Correction Factor(dB/m)
2. Correction Factor(dB/m) = Antenna Factor(dB/m) + Cable Factor(dB) – Pre-Amplifier Factor(dB)
3. The other emission levels were very low against the limit.
4. Margin value = Emission Level – Limit value
5. " # ": The radiated frequency is out of the restricted band.

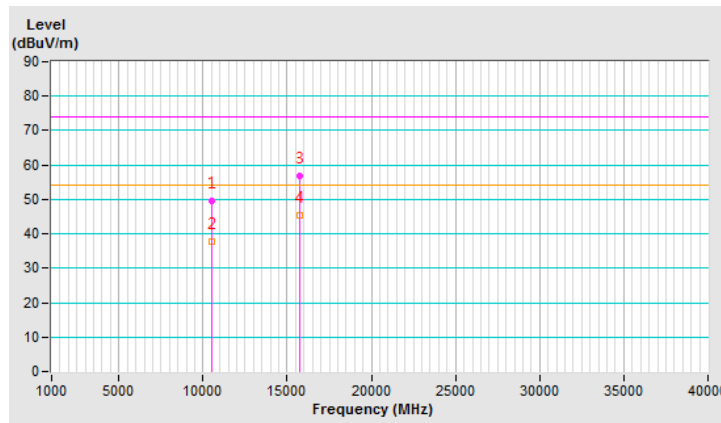

CHANNEL	TX Channel 52	DETECTOR FUNCTION	Peak (PK)
FREQUENCY RANGE	1GHz ~ 40GHz		Average (AV)

ANTENNA POLARITY & TEST DISTANCE: VERTICAL AT 3 M								
NO.	FREQ. (MHz)	EMISSION LEVEL (dBuV/m)	LIMIT (dBuV/m)	MARGIN (dB)	ANTENNA HEIGHT (m)	TABLE ANGLE (Degree)	RAW VALUE (dBuV)	CORRECTION FACTOR (dB/m)
1	#10520.00	55.2 PK	74.0	-18.8	2.81 V	172	41.61	13.59
2	#10520.00	42.9 AV	54.0	-11.1	2.81 V	172	29.31	13.59
3	15780.00	60.3 PK	74.0	-13.7	2.62 V	151	45.17	15.13
4	15780.00	47.7 AV	54.0	-6.3	2.62 V	151	32.57	15.13

REMARKS:

1. Emission Level(dBuV/m) = Raw Value(dBuV) + Correction Factor(dB/m)
2. Correction Factor(dB/m) = Antenna Factor(dB/m) + Cable Factor(dB) – Pre-Amplifier Factor(dB)
3. The other emission levels were very low against the limit.
4. Margin value = Emission Level – Limit value
5. " # ": The radiated frequency is out of the restricted band.

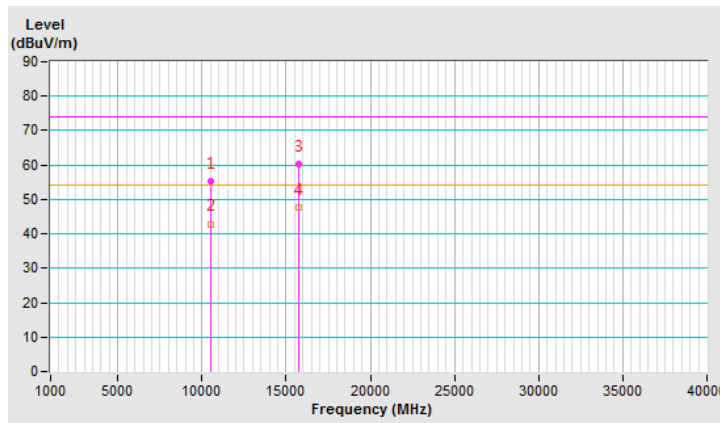

CHANNEL	TX Channel 60	DETECTOR FUNCTION	Peak (PK)
FREQUENCY RANGE	1GHz ~ 40GHz		Average (AV)

ANTENNA POLARITY & TEST DISTANCE: HORIZONTAL AT 3 M

NO.	FREQ. (MHz)	EMISSION LEVEL (dBuV/m)	LIMIT (dBuV/m)	MARGIN (dB)	ANTENNA HEIGHT (m)	TABLE ANGLE (Degree)	RAW VALUE (dBuV)	CORRECTION FACTOR (dB/m)
1	10600.00	49.3 PK	74.0	-24.7	3.41 H	178	35.51	13.79
2	10600.00	36.8 AV	54.0	-17.2	3.41 H	178	23.01	13.79
3	15900.00	55.8 PK	74.0	-18.2	3.30 H	317	40.66	15.14
4	15900.00	44.7 AV	54.0	-9.3	3.30 H	317	29.56	15.14

REMARKS:

1. Emission Level(dBuV/m) = Raw Value(dBuV) + Correction Factor(dB/m)
2. Correction Factor(dB/m) = Antenna Factor(dB/m) + Cable Factor(dB) – Pre-Amplifier Factor(dB)
3. The other emission levels were very low against the limit.
4. Margin value = Emission Level – Limit value

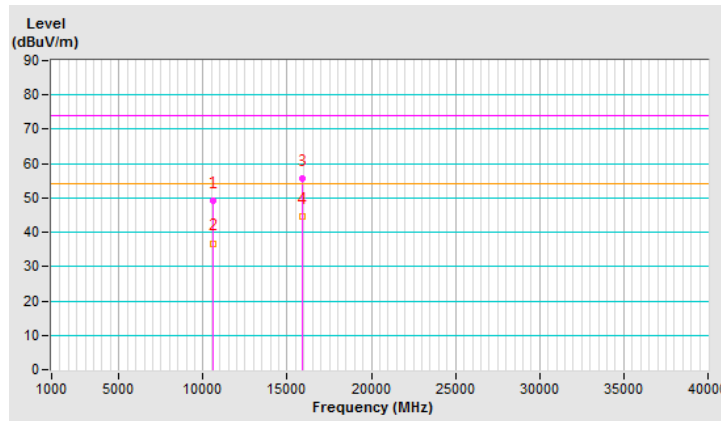

CHANNEL	TX Channel 60	DETECTOR FUNCTION	Peak (PK)
FREQUENCY RANGE	1GHz ~ 40GHz		Average (AV)

ANTENNA POLARITY & TEST DISTANCE: VERTICAL AT 3 M

NO.	FREQ. (MHz)	EMISSION LEVEL (dBuV/m)	LIMIT (dBuV/m)	MARGIN (dB)	ANTENNA HEIGHT (m)	TABLE ANGLE (Degree)	RAW VALUE (dBuV)	CORRECTION FACTOR (dB/m)
1	10600.00	54.1 PK	74.0	-19.9	2.81 V	161	40.31	13.79
2	10600.00	42.1 AV	54.0	-11.9	2.81 V	161	28.31	13.79
3	15900.00	59.8 PK	74.0	-14.2	2.68 V	159	44.66	15.14
4	15900.00	47.5 AV	54.0	-6.5	2.68 V	159	32.36	15.14

REMARKS:

1. Emission Level(dBuV/m) = Raw Value(dBuV) + Correction Factor(dB/m)
2. Correction Factor(dB/m) = Antenna Factor(dB/m) + Cable Factor(dB) – Pre-Amplifier Factor(dB)
3. The other emission levels were very low against the limit.
4. Margin value = Emission Level – Limit value

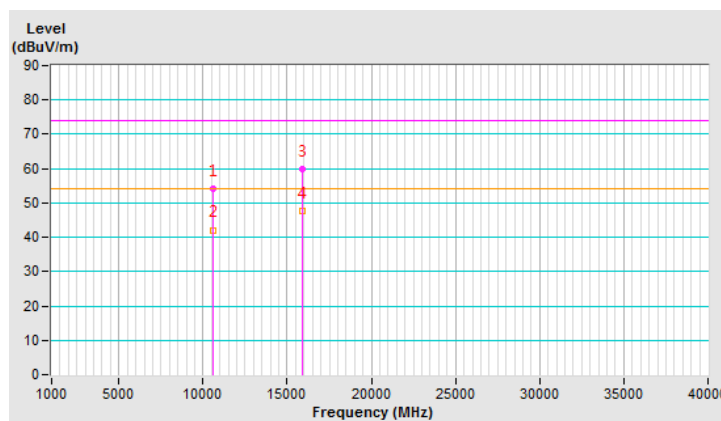

CHANNEL	TX Channel 64	DETECTOR FUNCTION	Peak (PK)
FREQUENCY RANGE	1GHz ~ 40GHz		Average (AV)

ANTENNA POLARITY & TEST DISTANCE: HORIZONTAL AT 3 M								
NO.	FREQ. (MHz)	EMISSION LEVEL (dBuV/m)	LIMIT (dBuV/m)	MARGIN (dB)	ANTENNA HEIGHT (m)	TABLE ANGLE (Degree)	RAW VALUE (dBuV)	CORRECTION FACTOR (dB/m)
1	10640.00	49.2 PK	74.0	-24.8	3.31 H	196	35.29	13.91
2	10640.00	36.7 AV	54.0	-17.3	3.31 H	196	22.79	13.91
3	15960.00	55.5 PK	74.0	-18.5	3.28 H	336	40.32	15.18
4	15960.00	44.2 AV	54.0	-9.8	3.28 H	336	29.02	15.18

REMARKS:

1. Emission Level(dBuV/m) = Raw Value(dBuV) + Correction Factor(dB/m)
2. Correction Factor(dB/m) = Antenna Factor(dB/m) + Cable Factor(dB) – Pre-Amplifier Factor(dB)
3. The other emission levels were very low against the limit.
4. Margin value = Emission Level – Limit value

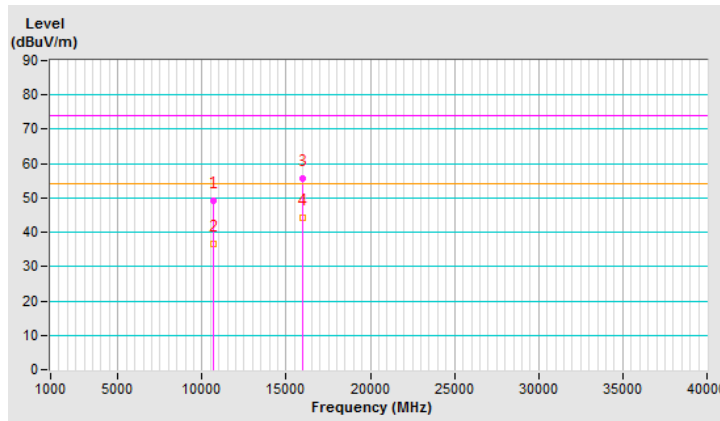

CHANNEL	TX Channel 64	DETECTOR FUNCTION	Peak (PK)
FREQUENCY RANGE	1GHz ~ 40GHz		Average (AV)

ANTENNA POLARITY & TEST DISTANCE: VERTICAL AT 3 M								
NO.	FREQ. (MHz)	EMISSION LEVEL (dBuV/m)	LIMIT (dBuV/m)	MARGIN (dB)	ANTENNA HEIGHT (m)	TABLE ANGLE (Degree)	RAW VALUE (dBuV)	CORRECTION FACTOR (dB/m)
1	10640.00	54.3 PK	74.0	-19.7	2.88 V	170	40.39	13.91
2	10640.00	42.5 AV	54.0	-11.5	2.88 V	170	28.59	13.91
3	15960.00	59.3 PK	74.0	-14.7	2.63 V	139	44.12	15.18
4	15960.00	47.0 AV	54.0	-7.0	2.63 V	139	31.82	15.18

REMARKS:

1. Emission Level(dBuV/m) = Raw Value(dBuV) + Correction Factor(dB/m)
2. Correction Factor(dB/m) = Antenna Factor(dB/m) + Cable Factor(dB) – Pre-Amplifier Factor(dB)
3. The other emission levels were very low against the limit.
4. Margin value = Emission Level – Limit value

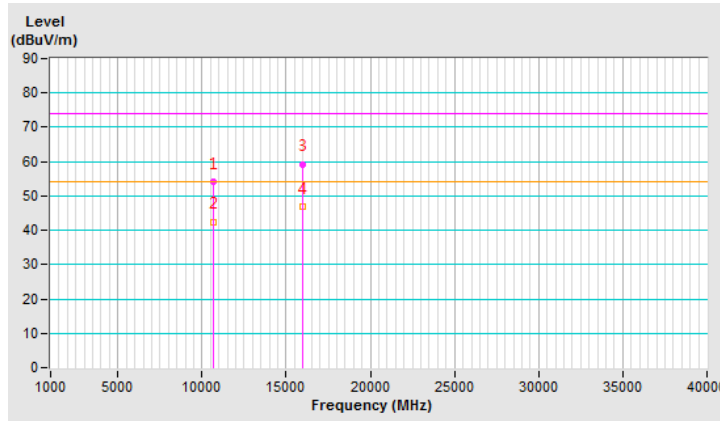

CHANNEL	TX Channel 100	DETECTOR FUNCTION	Peak (PK)
FREQUENCY RANGE	1GHz ~ 40GHz		Average (AV)

ANTENNA POLARITY & TEST DISTANCE: HORIZONTAL AT 3 M								
NO.	FREQ. (MHz)	EMISSION LEVEL (dBuV/m)	LIMIT (dBuV/m)	MARGIN (dB)	ANTENNA HEIGHT (m)	TABLE ANGLE (Degree)	RAW VALUE (dBuV)	CORRECTION FACTOR (dB/m)
1	11000.00	49.8 PK	74.0	-24.2	3.37 H	185	34.73	15.07
2	11000.00	37.4 AV	54.0	-16.6	3.37 H	185	22.33	15.07
3	#16500.00	55.2 PK	74.0	-18.8	3.29 H	316	37.17	18.03
4	#16500.00	44.2 AV	54.0	-9.8	3.29 H	316	26.17	18.03

REMARKS:

1. Emission Level(dBuV/m) = Raw Value(dBuV) + Correction Factor(dB/m)
2. Correction Factor(dB/m) = Antenna Factor(dB/m) + Cable Factor(dB) – Pre-Amplifier Factor(dB)
3. The other emission levels were very low against the limit.
4. Margin value = Emission Level – Limit value
5. " # ": The radiated frequency is out of the restricted band.

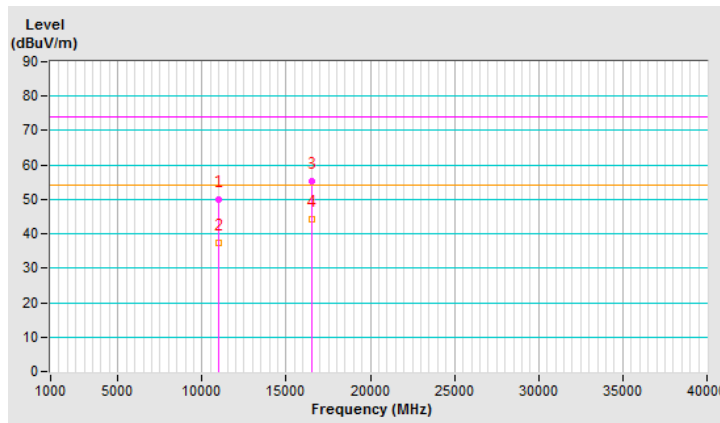

CHANNEL	TX Channel 100	DETECTOR FUNCTION	Peak (PK)
FREQUENCY RANGE	1GHz ~ 40GHz		Average (AV)

ANTENNA POLARITY & TEST DISTANCE: VERTICAL AT 3 M								
NO.	FREQ. (MHz)	EMISSION LEVEL (dBuV/m)	LIMIT (dBuV/m)	MARGIN (dB)	ANTENNA HEIGHT (m)	TABLE ANGLE (Degree)	RAW VALUE (dBuV)	CORRECTION FACTOR (dB/m)
1	11000.00	54.5 PK	74.0	-19.5	2.85 V	164	39.43	15.07
2	11000.00	42.6 AV	54.0	-11.4	2.85 V	164	27.53	15.07
3	#16500.00	58.9 PK	74.0	-15.1	2.65 V	139	40.87	18.03
4	#16500.00	47.0 AV	54.0	-7.0	2.65 V	139	28.97	18.03

REMARKS:

1. Emission Level(dBuV/m) = Raw Value(dBuV) + Correction Factor(dB/m)
2. Correction Factor(dB/m) = Antenna Factor(dB/m) + Cable Factor(dB) – Pre-Amplifier Factor(dB)
3. The other emission levels were very low against the limit.
4. Margin value = Emission Level – Limit value
5. " # ": The radiated frequency is out of the restricted band.

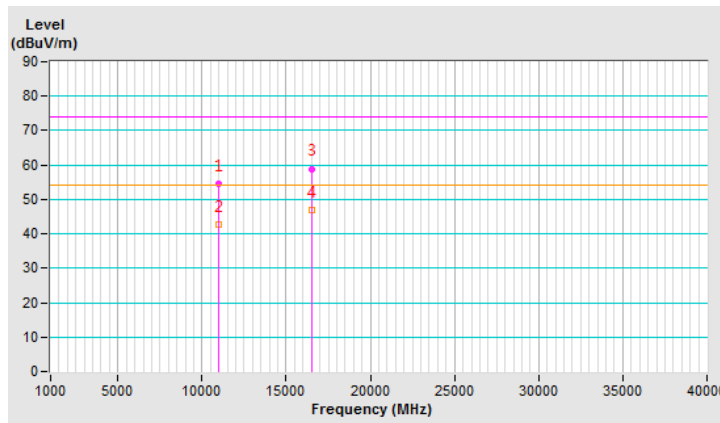

CHANNEL	TX Channel 120	DETECTOR FUNCTION	Peak (PK)
FREQUENCY RANGE	1GHz ~ 40GHz		Average (AV)

ANTENNA POLARITY & TEST DISTANCE: HORIZONTAL AT 3 M

NO.	FREQ. (MHz)	EMISSION LEVEL (dBuV/m)	LIMIT (dBuV/m)	MARGIN (dB)	ANTENNA HEIGHT (m)	TABLE ANGLE (Degree)	RAW VALUE (dBuV)	CORRECTION FACTOR (dB/m)
1	11200.00	50.0 PK	74.0	-24.0	3.38 H	181	35.05	14.95
2	11200.00	37.4 AV	54.0	-16.6	3.38 H	181	22.45	14.95
3	#16800.00	55.7 PK	74.0	-18.3	3.26 H	310	36.51	19.19
4	#16800.00	44.6 AV	54.0	-9.4	3.26 H	310	25.41	19.19

REMARKS:

1. Emission Level(dBuV/m) = Raw Value(dBuV) + Correction Factor(dB/m)
2. Correction Factor(dB/m) = Antenna Factor(dB/m) + Cable Factor(dB) – Pre-Amplifier Factor(dB)
3. The other emission levels were very low against the limit.
4. Margin value = Emission Level – Limit value
5. " # ": The radiated frequency is out of the restricted band.

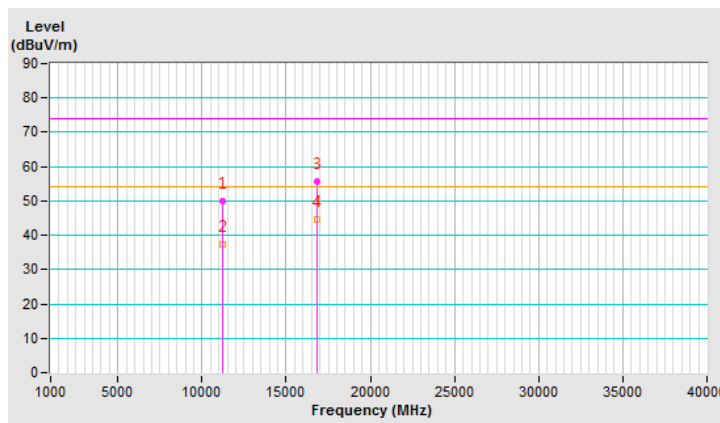

CHANNEL	TX Channel 120	DETECTOR FUNCTION	Peak (PK)
FREQUENCY RANGE	1GHz ~ 40GHz		Average (AV)

ANTENNA POLARITY & TEST DISTANCE: VERTICAL AT 3 M								
NO.	FREQ. (MHz)	EMISSION LEVEL (dBuV/m)	LIMIT (dBuV/m)	MARGIN (dB)	ANTENNA HEIGHT (m)	TABLE ANGLE (Degree)	RAW VALUE (dBuV)	CORRECTION FACTOR (dB/m)
1	11200.00	54.0 PK	74.0	-20.0	2.85 V	178	39.05	14.95
2	11200.00	42.6 AV	54.0	-11.4	2.85 V	178	27.65	14.95
3	#16800.00	59.4 PK	74.0	-14.6	2.63 V	154	40.21	19.19
4	#16800.00	46.9 AV	54.0	-7.1	2.63 V	154	27.71	19.19

REMARKS:

1. Emission Level(dBuV/m) = Raw Value(dBuV) + Correction Factor(dB/m)
2. Correction Factor(dB/m) = Antenna Factor(dB/m) + Cable Factor(dB) – Pre-Amplifier Factor(dB)
3. The other emission levels were very low against the limit.
4. Margin value = Emission Level – Limit value
5. " # ": The radiated frequency is out of the restricted band.

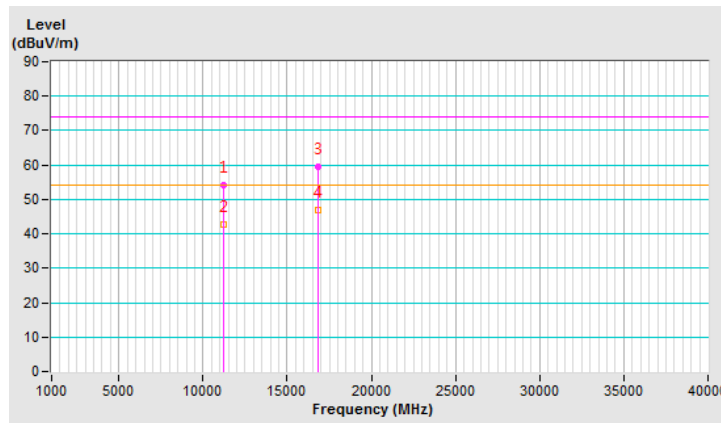

CHANNEL	TX Channel 140	DETECTOR FUNCTION	Peak (PK)
FREQUENCY RANGE	1GHz ~ 40GHz		Average (AV)

ANTENNA POLARITY & TEST DISTANCE: HORIZONTAL AT 3 M								
NO.	FREQ. (MHz)	EMISSION LEVEL (dBuV/m)	LIMIT (dBuV/m)	MARGIN (dB)	ANTENNA HEIGHT (m)	TABLE ANGLE (Degree)	RAW VALUE (dBuV)	CORRECTION FACTOR (dB/m)
1	11400.00	49.7 PK	74.0	-24.3	3.38 H	187	34.35	15.35
2	11400.00	37.1 AV	54.0	-16.9	3.38 H	187	21.75	15.35
3	#17100.00	55.6 PK	74.0	-18.4	3.26 H	333	35.50	20.10
4	#17100.00	44.8 AV	54.0	-9.2	3.26 H	333	24.70	20.10

REMARKS:

1. Emission Level(dBuV/m) = Raw Value(dBuV) + Correction Factor(dB/m)
2. Correction Factor(dB/m) = Antenna Factor(dB/m) + Cable Factor(dB) – Pre-Amplifier Factor(dB)
3. The other emission levels were very low against the limit.
4. Margin value = Emission Level – Limit value
5. "#": The radiated frequency is out of the restricted band.

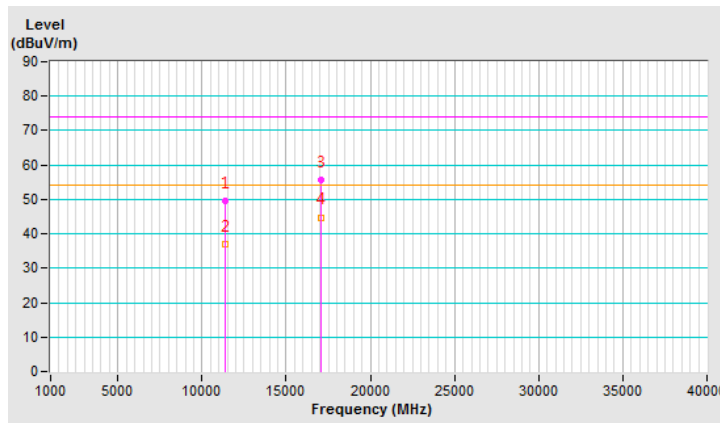

CHANNEL	TX Channel 140	DETECTOR FUNCTION	Peak (PK)
FREQUENCY RANGE	1GHz ~ 40GHz		Average (AV)

ANTENNA POLARITY & TEST DISTANCE: VERTICAL AT 3 M								
NO.	FREQ. (MHz)	EMISSION LEVEL (dBuV/m)	LIMIT (dBuV/m)	MARGIN (dB)	ANTENNA HEIGHT (m)	TABLE ANGLE (Degree)	RAW VALUE (dBuV)	CORRECTION FACTOR (dB/m)
1	11400.00	54.6 PK	74.0	-19.4	2.89 V	156	39.25	15.35
2	11400.00	42.8 AV	54.0	-11.2	2.89 V	156	27.45	15.35
3	#17100.00	59.0 PK	74.0	-15.0	2.57 V	137	38.90	20.10
4	#17100.00	46.6 AV	54.0	-7.4	2.57 V	137	26.50	20.10

REMARKS:

1. Emission Level(dBuV/m) = Raw Value(dBuV) + Correction Factor(dB/m)
2. Correction Factor(dB/m) = Antenna Factor(dB/m) + Cable Factor(dB) – Pre-Amplifier Factor(dB)
3. The other emission levels were very low against the limit.
4. Margin value = Emission Level – Limit value
5. "#": The radiated frequency is out of the restricted band.

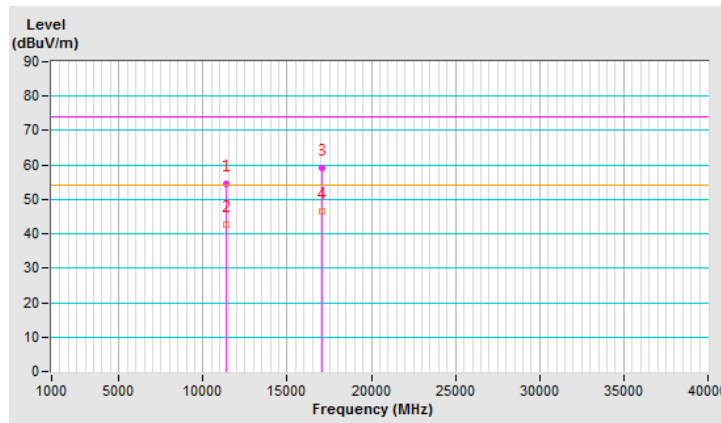

CHANNEL	TX Channel 144	DETECTOR FUNCTION	Peak (PK)
FREQUENCY RANGE	1GHz ~ 40GHz		Average (AV)

ANTENNA POLARITY & TEST DISTANCE: HORIZONTAL AT 3 M								
NO.	FREQ. (MHz)	EMISSION LEVEL (dBuV/m)	LIMIT (dBuV/m)	MARGIN (dB)	ANTENNA HEIGHT (m)	TABLE ANGLE (Degree)	RAW VALUE (dBuV)	CORRECTION FACTOR (dB/m)
1	11440.00	49.6 PK	74.0	-24.4	3.43 H	143	34.34	15.26
2	11440.00	37.8 AV	54.0	-16.2	3.43 H	143	22.54	15.26
3	#17160.00	56.5 PK	74.0	-17.5	3.24 H	316	36.48	20.02
4	#17160.00	45.4 AV	54.0	-8.6	3.24 H	316	25.38	20.02

REMARKS:

1. Emission Level(dBuV/m) = Raw Value(dBuV) + Correction Factor(dB/m)
2. Correction Factor(dB/m) = Antenna Factor(dB/m) + Cable Factor(dB) – Pre-Amplifier Factor(dB)
3. The other emission levels were very low against the limit.
4. Margin value = Emission Level – Limit value
5. " # ": The radiated frequency is out of the restricted band.

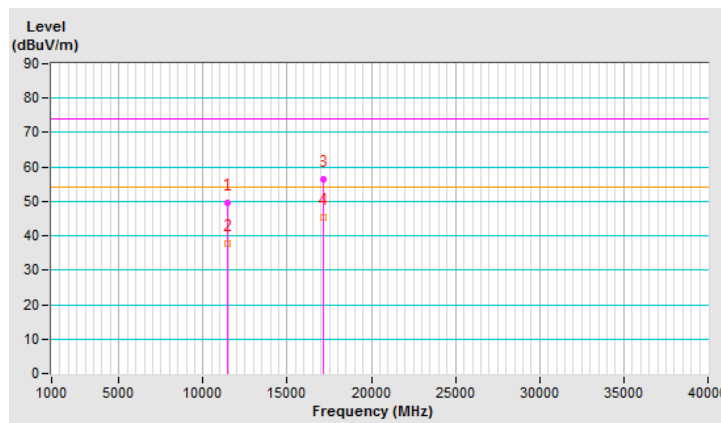

CHANNEL	TX Channel 144	DETECTOR FUNCTION	Peak (PK)
FREQUENCY RANGE	1GHz ~ 40GHz		Average (AV)

ANTENNA POLARITY & TEST DISTANCE: VERTICAL AT 3 M								
NO.	FREQ. (MHz)	EMISSION LEVEL (dBuV/m)	LIMIT (dBuV/m)	MARGIN (dB)	ANTENNA HEIGHT (m)	TABLE ANGLE (Degree)	RAW VALUE (dBuV)	CORRECTION FACTOR (dB/m)
1	11440.00	55.6 PK	74.0	-18.4	2.83 V	171	40.34	15.26
2	11440.00	43.1 AV	54.0	-10.9	2.83 V	171	27.84	15.26
3	#17160.00	59.7 PK	74.0	-14.3	2.63 V	145	39.68	20.02
4	#17160.00	47.4 AV	54.0	-6.6	2.63 V	145	27.38	20.02

REMARKS:

1. Emission Level(dBuV/m) = Raw Value(dBuV) + Correction Factor(dB/m)
2. Correction Factor(dB/m) = Antenna Factor(dB/m) + Cable Factor(dB) – Pre-Amplifier Factor(dB)
3. The other emission levels were very low against the limit.
4. Margin value = Emission Level – Limit value
5. "#": The radiated frequency is out of the restricted band.

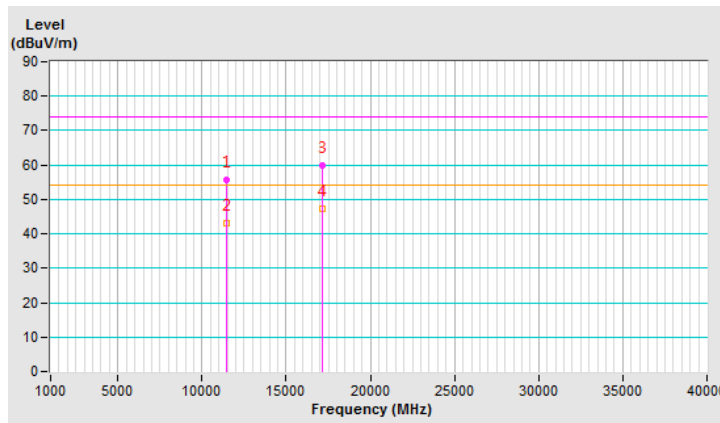

CHANNEL	TX Channel 149	DETECTOR FUNCTION	Peak (PK)
FREQUENCY RANGE	1GHz ~ 40GHz		Average (AV)

ANTENNA POLARITY & TEST DISTANCE: HORIZONTAL AT 3 M								
NO.	FREQ. (MHz)	EMISSION LEVEL (dBuV/m)	LIMIT (dBuV/m)	MARGIN (dB)	ANTENNA HEIGHT (m)	TABLE ANGLE (Degree)	RAW VALUE (dBuV)	CORRECTION FACTOR (dB/m)
1	11490.00	49.5 PK	74.0	-24.5	3.37 H	142	34.32	15.18
2	11490.00	37.4 AV	54.0	-16.6	3.37 H	142	22.22	15.18
3	#17235.00	57.1 PK	74.0	-16.9	3.25 H	340	36.94	20.16
4	#17235.00	45.6 AV	54.0	-8.4	3.25 H	340	25.44	20.16

REMARKS:

1. Emission Level(dBuV/m) = Raw Value(dBuV) + Correction Factor(dB/m)
2. Correction Factor(dB/m) = Antenna Factor(dB/m) + Cable Factor(dB) – Pre-Amplifier Factor(dB)
3. The other emission levels were very low against the limit.
4. Margin value = Emission Level – Limit value
5. " # ": The radiated frequency is out of the restricted band.

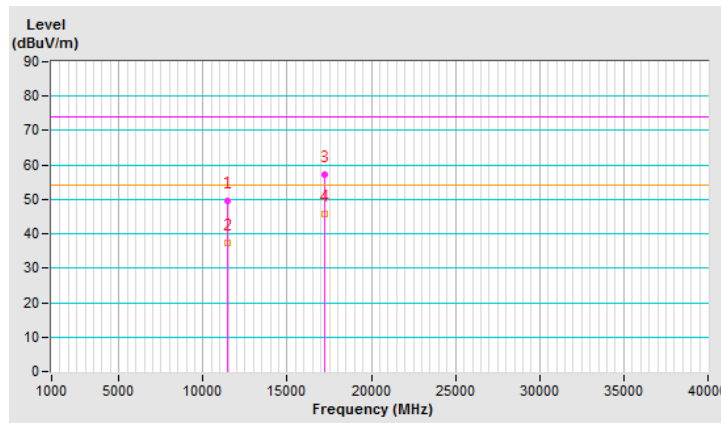

CHANNEL	TX Channel 149	DETECTOR FUNCTION	Peak (PK)
FREQUENCY RANGE	1GHz ~ 40GHz		Average (AV)

ANTENNA POLARITY & TEST DISTANCE: VERTICAL AT 3 M								
NO.	FREQ. (MHz)	EMISSION LEVEL (dBuV/m)	LIMIT (dBuV/m)	MARGIN (dB)	ANTENNA HEIGHT (m)	TABLE ANGLE (Degree)	RAW VALUE (dBuV)	CORRECTION FACTOR (dB/m)
1	11490.00	54.9 PK	74.0	-19.1	2.82 V	175	39.72	15.18
2	11490.00	42.7 AV	54.0	-11.3	2.82 V	175	27.52	15.18
3	#17235.00	59.9 PK	74.0	-14.1	2.61 V	152	39.74	20.16
4	#17235.00	47.3 AV	54.0	-6.7	2.61 V	152	27.14	20.16

REMARKS:

1. Emission Level(dBuV/m) = Raw Value(dBuV) + Correction Factor(dB/m)
2. Correction Factor(dB/m) = Antenna Factor(dB/m) + Cable Factor(dB) – Pre-Amplifier Factor(dB)
3. The other emission levels were very low against the limit.
4. Margin value = Emission Level – Limit value
5. " # ": The radiated frequency is out of the restricted band.

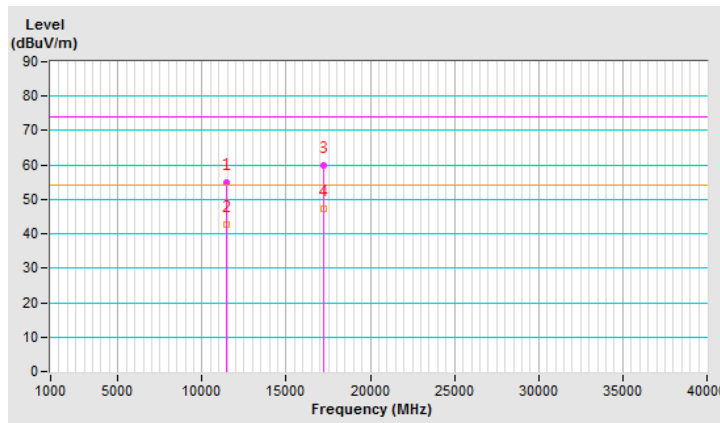

CHANNEL	TX Channel 157	DETECTOR FUNCTION	Peak (PK)
FREQUENCY RANGE	1GHz ~ 40GHz		Average (AV)

ANTENNA POLARITY & TEST DISTANCE: HORIZONTAL AT 3 M

NO.	FREQ. (MHz)	EMISSION LEVEL (dBuV/m)	LIMIT (dBuV/m)	MARGIN (dB)	ANTENNA HEIGHT (m)	TABLE ANGLE (Degree)	RAW VALUE (dBuV)	CORRECTION FACTOR (dB/m)
1	11570.00	50.7 PK	74.0	-23.3	3.36 H	173	35.77	14.93
2	11570.00	38.8 AV	54.0	-15.2	3.36 H	173	23.87	14.93
3	#17355.00	57.8 PK	74.0	-16.2	3.28 H	326	36.99	20.81
4	#17355.00	46.7 AV	54.0	-7.3	3.28 H	326	25.89	20.81

REMARKS:

1. Emission Level(dBuV/m) = Raw Value(dBuV) + Correction Factor(dB/m)
2. Correction Factor(dB/m) = Antenna Factor(dB/m) + Cable Factor(dB) – Pre-Amplifier Factor(dB)
3. The other emission levels were very low against the limit.
4. Margin value = Emission Level – Limit value
5. " # ": The radiated frequency is out of the restricted band.

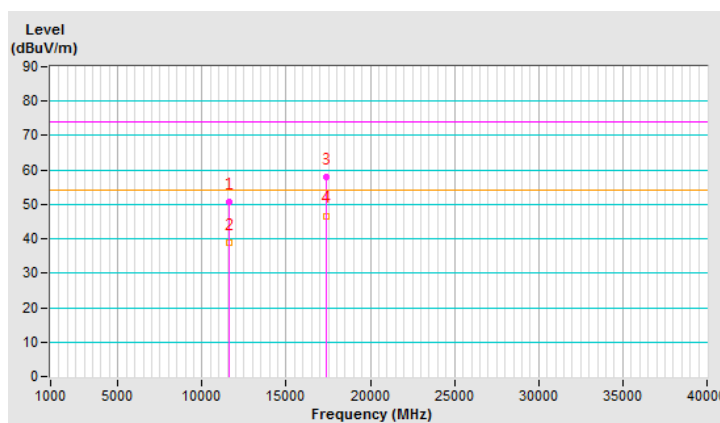

CHANNEL	TX Channel 157	DETECTOR FUNCTION	Peak (PK)
FREQUENCY RANGE	1GHz ~ 40GHz		Average (AV)

ANTENNA POLARITY & TEST DISTANCE: VERTICAL AT 3 M								
NO.	FREQ. (MHz)	EMISSION LEVEL (dBuV/m)	LIMIT (dBuV/m)	MARGIN (dB)	ANTENNA HEIGHT (m)	TABLE ANGLE (Degree)	RAW VALUE (dBuV)	CORRECTION FACTOR (dB/m)
1	11570.00	56.6 PK	74.0	-17.4	3.40 V	291	41.67	14.93
2	11570.00	44.6 AV	54.0	-9.4	3.40 V	291	29.67	14.93
3	#17355.00	61.2 PK	74.0	-12.8	3.36 V	310	40.39	20.81
4	#17355.00	48.5 AV	54.0	-5.5	3.36 V	310	27.69	20.81

REMARKS:

1. Emission Level(dBuV/m) = Raw Value(dBuV) + Correction Factor(dB/m)
2. Correction Factor(dB/m) = Antenna Factor(dB/m) + Cable Factor(dB) – Pre-Amplifier Factor(dB)
3. The other emission levels were very low against the limit.
4. Margin value = Emission Level – Limit value
5. " # ": The radiated frequency is out of the restricted band.

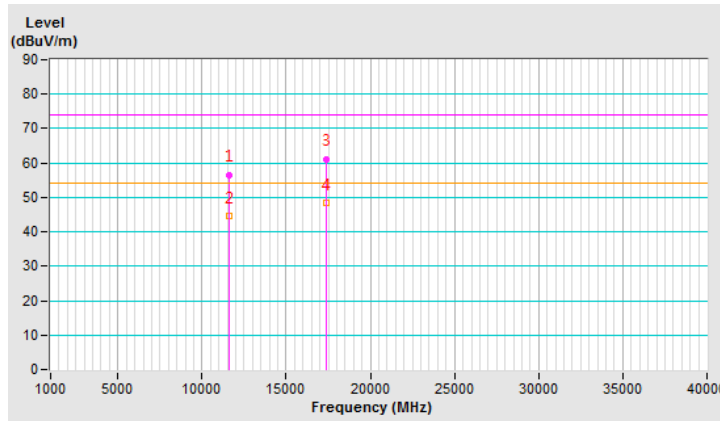

CHANNEL	TX Channel 165	DETECTOR FUNCTION	Peak (PK)
FREQUENCY RANGE	1GHz ~ 40GHz		Average (AV)

ANTENNA POLARITY & TEST DISTANCE: HORIZONTAL AT 3 M

NO.	FREQ. (MHz)	EMISSION LEVEL (dBuV/m)	LIMIT (dBuV/m)	MARGIN (dB)	ANTENNA HEIGHT (m)	TABLE ANGLE (Degree)	RAW VALUE (dBuV)	CORRECTION FACTOR (dB/m)
1	11650.00	50.5 PK	74.0	-23.5	3.43 H	176	35.73	14.77
2	11650.00	39.1 AV	54.0	-14.9	3.43 H	176	24.33	14.77
3	#17475.00	57.3 PK	74.0	-16.7	3.26 H	319	35.76	21.54
4	#17475.00	46.3 AV	54.0	-7.7	3.26 H	319	24.76	21.54

REMARKS:

1. Emission Level(dBuV/m) = Raw Value(dBuV) + Correction Factor(dB/m)
2. Correction Factor(dB/m) = Antenna Factor(dB/m) + Cable Factor(dB) – Pre-Amplifier Factor(dB)
3. The other emission levels were very low against the limit.
4. Margin value = Emission Level – Limit value
5. " # ": The radiated frequency is out of the restricted band.

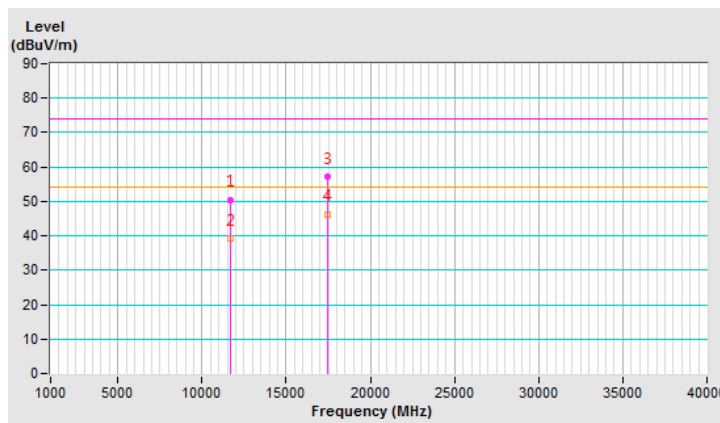

CHANNEL	TX Channel 165	DETECTOR FUNCTION	Peak (PK)
FREQUENCY RANGE	1GHz ~ 40GHz		Average (AV)

ANTENNA POLARITY & TEST DISTANCE: VERTICAL AT 3 M								
NO.	FREQ. (MHz)	EMISSION LEVEL (dBuV/m)	LIMIT (dBuV/m)	MARGIN (dB)	ANTENNA HEIGHT (m)	TABLE ANGLE (Degree)	RAW VALUE (dBuV)	CORRECTION FACTOR (dB/m)
1	11650.00	56.1 PK	74.0	-17.9	3.44 V	282	41.33	14.77
2	11650.00	44.2 AV	54.0	-9.8	3.44 V	282	29.43	14.77
3	#17475.00	60.9 PK	74.0	-13.1	3.35 V	295	39.36	21.54
4	#17475.00	48.4 AV	54.0	-5.6	3.35 V	295	26.86	21.54

REMARKS:

1. Emission Level(dBuV/m) = Raw Value(dBuV) + Correction Factor(dB/m)
2. Correction Factor(dB/m) = Antenna Factor(dB/m) + Cable Factor(dB) – Pre-Amplifier Factor(dB)
3. The other emission levels were very low against the limit.
4. Margin value = Emission Level – Limit value
5. " # ": The radiated frequency is out of the restricted band.

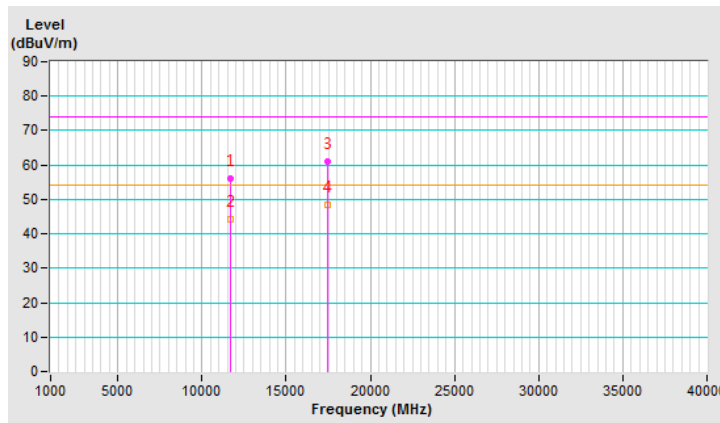

802.11n (HT20)

CHANNEL	TX Channel 36	DETECTOR FUNCTION	Peak (PK)
FREQUENCY RANGE	1GHz ~ 40GHz		Average (AV)

ANTENNA POLARITY & TEST DISTANCE: HORIZONTAL AT 3 M								
NO.	FREQ. (MHz)	EMISSION LEVEL (dBuV/m)	LIMIT (dBuV/m)	MARGIN (dB)	ANTENNA HEIGHT (m)	TABLE ANGLE (Degree)	RAW VALUE (dBuV)	CORRECTION FACTOR (dB/m)
1	#10360.00	50.0 PK	74.0	-24.0	3.41 H	162	36.70	13.30
2	#10360.00	38.6 AV	54.0	-15.4	3.41 H	162	25.30	13.30
3	15540.00	57.2 PK	74.0	-16.8	3.27 H	324	41.63	15.57
4	15540.00	46.1 AV	54.0	-7.9	3.27 H	324	30.53	15.57

REMARKS:

1. Emission Level(dBuV/m) = Raw Value(dBuV) + Correction Factor(dB/m)
2. Correction Factor(dB/m) = Antenna Factor(dB/m) + Cable Factor(dB) – Pre-Amplifier Factor(dB)
3. The other emission levels were very low against the limit.
4. Margin value = Emission Level – Limit value
5. " # ": The radiated frequency is out of the restricted band.

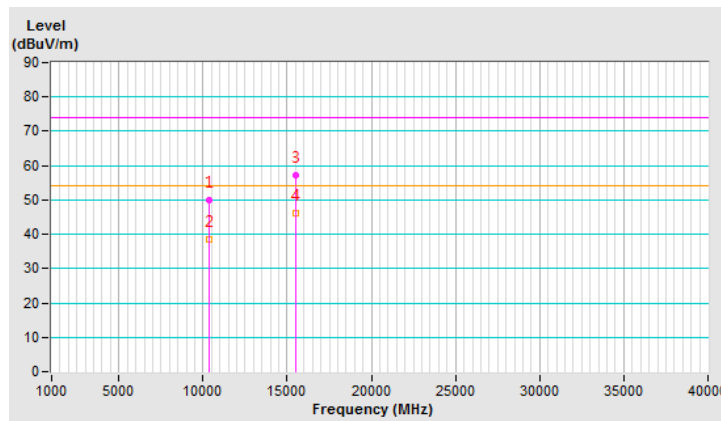

CHANNEL	TX Channel 36	DETECTOR FUNCTION	Peak (PK)
FREQUENCY RANGE	1GHz ~ 40GHz		Average (AV)

ANTENNA POLARITY & TEST DISTANCE: VERTICAL AT 3 M								
NO.	FREQ. (MHz)	EMISSION LEVEL (dBuV/m)	LIMIT (dBuV/m)	MARGIN (dB)	ANTENNA HEIGHT (m)	TABLE ANGLE (Degree)	RAW VALUE (dBuV)	CORRECTION FACTOR (dB/m)
1	#10360.00	56.1 PK	74.0	-17.9	3.39 V	289	42.80	13.30
2	#10360.00	44.1 AV	54.0	-9.9	3.39 V	289	30.80	13.30
3	15540.00	60.7 PK	74.0	-13.3	3.30 V	302	45.13	15.57
4	15540.00	48.4 AV	54.0	-5.6	3.30 V	302	32.83	15.57

REMARKS:

1. Emission Level(dBuV/m) = Raw Value(dBuV) + Correction Factor(dB/m)
2. Correction Factor(dB/m) = Antenna Factor(dB/m) + Cable Factor(dB) – Pre-Amplifier Factor(dB)
3. The other emission levels were very low against the limit.
4. Margin value = Emission Level – Limit value
5. " # ": The radiated frequency is out of the restricted band.

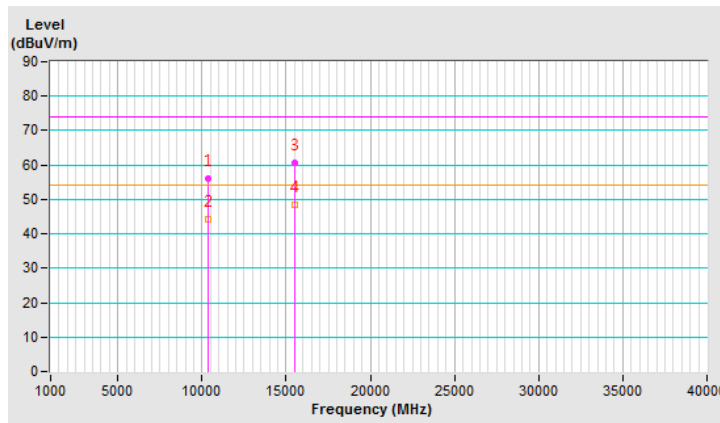

CHANNEL	TX Channel 40	DETECTOR FUNCTION	Peak (PK)
FREQUENCY RANGE	1GHz ~ 40GHz		Average (AV)

ANTENNA POLARITY & TEST DISTANCE: HORIZONTAL AT 3 M

NO.	FREQ. (MHz)	EMISSION LEVEL (dBuV/m)	LIMIT (dBuV/m)	MARGIN (dB)	ANTENNA HEIGHT (m)	TABLE ANGLE (Degree)	RAW VALUE (dBuV)	CORRECTION FACTOR (dB/m)
1	#10400.00	51.0 PK	74.0	-23.0	3.44 H	175	37.36	13.64
2	#10400.00	39.5 AV	54.0	-14.5	3.44 H	175	25.86	13.64
3	15600.00	57.3 PK	74.0	-16.7	3.28 H	334	41.65	15.65
4	15600.00	46.2 AV	54.0	-7.8	3.28 H	334	30.55	15.65

REMARKS:

1. Emission Level(dBuV/m) = Raw Value(dBuV) + Correction Factor(dB/m)
2. Correction Factor(dB/m) = Antenna Factor(dB/m) + Cable Factor(dB) – Pre-Amplifier Factor(dB)
3. The other emission levels were very low against the limit.
4. Margin value = Emission Level – Limit value
5. "#": The radiated frequency is out of the restricted band.

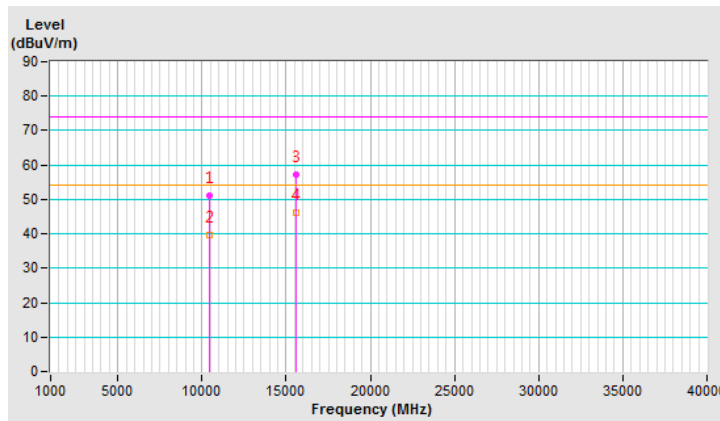

CHANNEL	TX Channel 40	DETECTOR FUNCTION	Peak (PK)
FREQUENCY RANGE	1GHz ~ 40GHz		Average (AV)

ANTENNA POLARITY & TEST DISTANCE: VERTICAL AT 3 M								
NO.	FREQ. (MHz)	EMISSION LEVEL (dBuV/m)	LIMIT (dBuV/m)	MARGIN (dB)	ANTENNA HEIGHT (m)	TABLE ANGLE (Degree)	RAW VALUE (dBuV)	CORRECTION FACTOR (dB/m)
1	#10400.00	56.2 PK	74.0	-17.8	3.49 V	292	42.56	13.64
2	#10400.00	44.5 AV	54.0	-9.5	3.49 V	292	30.86	13.64
3	15600.00	60.7 PK	74.0	-13.3	3.40 V	284	45.05	15.65
4	15600.00	48.1 AV	54.0	-5.9	3.40 V	284	32.45	15.65

REMARKS:

1. Emission Level(dBuV/m) = Raw Value(dBuV) + Correction Factor(dB/m)
2. Correction Factor(dB/m) = Antenna Factor(dB/m) + Cable Factor(dB) – Pre-Amplifier Factor(dB)
3. The other emission levels were very low against the limit.
4. Margin value = Emission Level – Limit value
5. " # ": The radiated frequency is out of the restricted band.

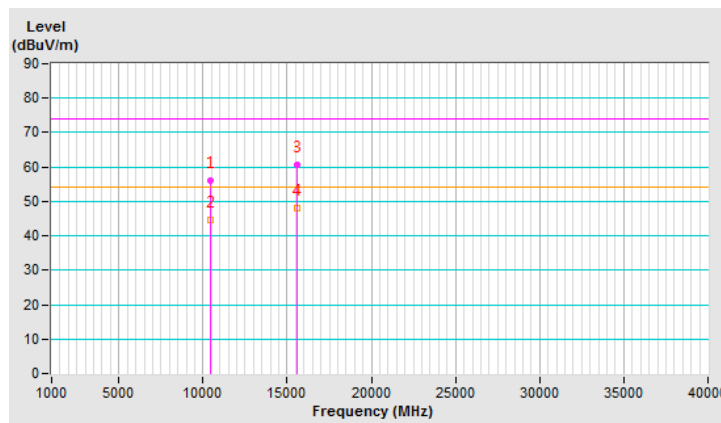

CHANNEL	TX Channel 48	DETECTOR FUNCTION	Peak (PK)
FREQUENCY RANGE	1GHz ~ 40GHz		Average (AV)

ANTENNA POLARITY & TEST DISTANCE: HORIZONTAL AT 3 M								
NO.	FREQ. (MHz)	EMISSION LEVEL (dBuV/m)	LIMIT (dBuV/m)	MARGIN (dB)	ANTENNA HEIGHT (m)	TABLE ANGLE (Degree)	RAW VALUE (dBuV)	CORRECTION FACTOR (dB/m)
1	#10480.00	49.7 PK	74.0	-24.3	3.32 H	182	36.15	13.55
2	#10480.00	37.7 AV	54.0	-16.3	3.32 H	182	24.15	13.55
3	15720.00	56.6 PK	74.0	-17.4	3.28 H	307	41.32	15.28
4	15720.00	45.2 AV	54.0	-8.8	3.28 H	307	29.92	15.28

REMARKS:

1. Emission Level(dBuV/m) = Raw Value(dBuV) + Correction Factor(dB/m)
2. Correction Factor(dB/m) = Antenna Factor(dB/m) + Cable Factor(dB) – Pre-Amplifier Factor(dB)
3. The other emission levels were very low against the limit.
4. Margin value = Emission Level – Limit value
5. " # ": The radiated frequency is out of the restricted band.

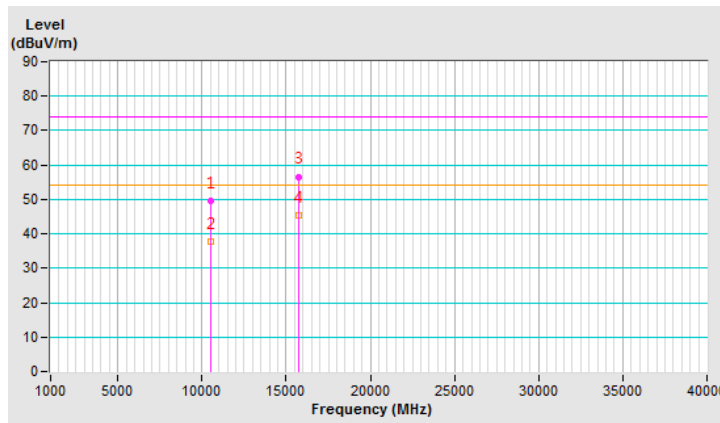

CHANNEL	TX Channel 48	DETECTOR FUNCTION	Peak (PK)
FREQUENCY RANGE	1GHz ~ 40GHz		Average (AV)

ANTENNA POLARITY & TEST DISTANCE: VERTICAL AT 3 M								
NO.	FREQ. (MHz)	EMISSION LEVEL (dBuV/m)	LIMIT (dBuV/m)	MARGIN (dB)	ANTENNA HEIGHT (m)	TABLE ANGLE (Degree)	RAW VALUE (dBuV)	CORRECTION FACTOR (dB/m)
1	#10480.00	55.1 PK	74.0	-18.9	2.87 V	167	41.55	13.55
2	#10480.00	42.7 AV	54.0	-11.3	2.87 V	167	29.15	13.55
3	15720.00	60.0 PK	74.0	-14.0	2.61 V	149	44.72	15.28
4	15720.00	47.6 AV	54.0	-6.4	2.61 V	149	32.32	15.28

REMARKS:

1. Emission Level(dBuV/m) = Raw Value(dBuV) + Correction Factor(dB/m)
2. Correction Factor(dB/m) = Antenna Factor(dB/m) + Cable Factor(dB) – Pre-Amplifier Factor(dB)
3. The other emission levels were very low against the limit.
4. Margin value = Emission Level – Limit value
5. "#": The radiated frequency is out of the restricted band.

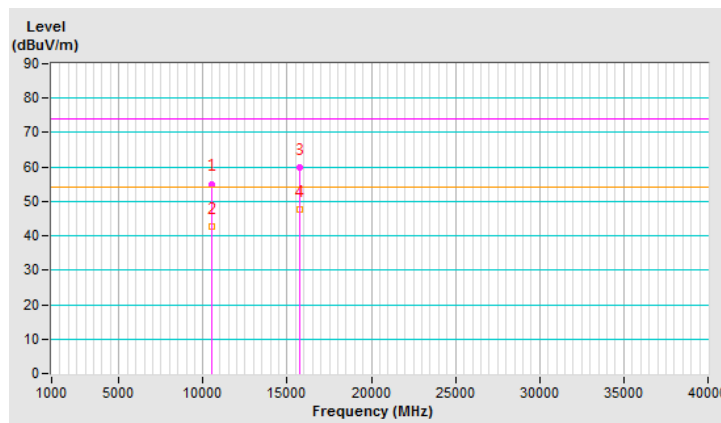

CHANNEL	TX Channel 52	DETECTOR FUNCTION	Peak (PK)
FREQUENCY RANGE	1GHz ~ 40GHz		Average (AV)

ANTENNA POLARITY & TEST DISTANCE: HORIZONTAL AT 3 M

NO.	FREQ. (MHz)	EMISSION LEVEL (dBuV/m)	LIMIT (dBuV/m)	MARGIN (dB)	ANTENNA HEIGHT (m)	TABLE ANGLE (Degree)	RAW VALUE (dBuV)	CORRECTION FACTOR (dB/m)
1	#10520.00	50.7 PK	74.0	-23.3	3.40 H	169	37.11	13.59
2	#10520.00	38.5 AV	54.0	-15.5	3.40 H	169	24.91	13.59
3	15780.00	55.9 PK	74.0	-18.1	3.27 H	313	40.77	15.13
4	15780.00	44.8 AV	54.0	-9.2	3.27 H	313	29.67	15.13

REMARKS:

1. Emission Level(dBuV/m) = Raw Value(dBuV) + Correction Factor(dB/m)
2. Correction Factor(dB/m) = Antenna Factor(dB/m) + Cable Factor(dB) – Pre-Amplifier Factor(dB)
3. The other emission levels were very low against the limit.
4. Margin value = Emission Level – Limit value
5. " # ": The radiated frequency is out of the restricted band.

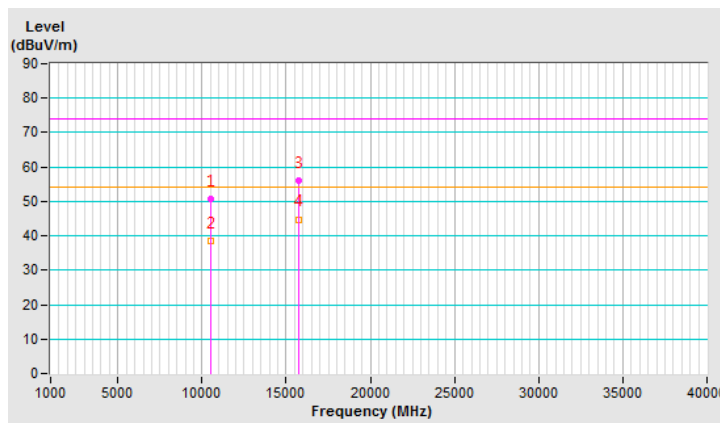

CHANNEL	TX Channel 52	DETECTOR FUNCTION	Peak (PK)
FREQUENCY RANGE	1GHz ~ 40GHz		Average (AV)

ANTENNA POLARITY & TEST DISTANCE: VERTICAL AT 3 M								
NO.	FREQ. (MHz)	EMISSION LEVEL (dBuV/m)	LIMIT (dBuV/m)	MARGIN (dB)	ANTENNA HEIGHT (m)	TABLE ANGLE (Degree)	RAW VALUE (dBuV)	CORRECTION FACTOR (dB/m)
1	#10520.00	55.7 PK	74.0	-18.3	2.82 V	183	42.11	13.59
2	#10520.00	43.1 AV	54.0	-10.9	2.82 V	183	29.51	13.59
3	15780.00	59.3 PK	74.0	-14.7	2.67 V	157	44.17	15.13
4	15780.00	46.9 AV	54.0	-7.1	2.67 V	157	31.77	15.13

REMARKS:

1. Emission Level(dBuV/m) = Raw Value(dBuV) + Correction Factor(dB/m)
2. Correction Factor(dB/m) = Antenna Factor(dB/m) + Cable Factor(dB) – Pre-Amplifier Factor(dB)
3. The other emission levels were very low against the limit.
4. Margin value = Emission Level – Limit value
5. " # ": The radiated frequency is out of the restricted band.

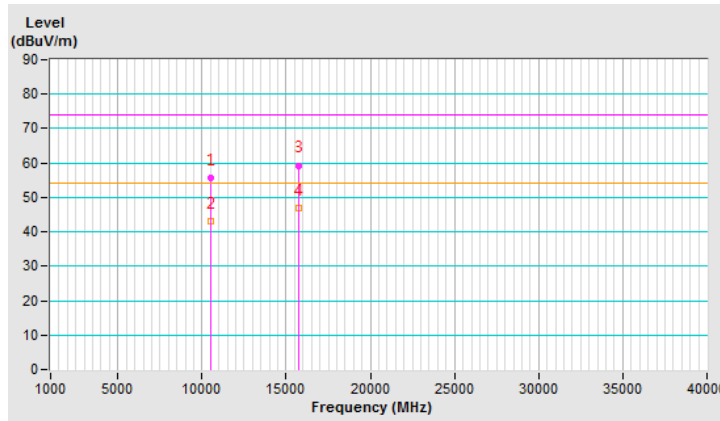

CHANNEL	TX Channel 60	DETECTOR FUNCTION	Peak (PK)
FREQUENCY RANGE	1GHz ~ 40GHz		Average (AV)

ANTENNA POLARITY & TEST DISTANCE: HORIZONTAL AT 3 M								
NO.	FREQ. (MHz)	EMISSION LEVEL (dBuV/m)	LIMIT (dBuV/m)	MARGIN (dB)	ANTENNA HEIGHT (m)	TABLE ANGLE (Degree)	RAW VALUE (dBuV)	CORRECTION FACTOR (dB/m)
1	10600.00	50.5 PK	74.0	-23.5	3.37 H	178	36.71	13.79
2	10600.00	37.8 AV	54.0	-16.2	3.37 H	178	24.01	13.79
3	15900.00	55.4 PK	74.0	-18.6	3.25 H	295	40.26	15.14
4	15900.00	44.4 AV	54.0	-9.6	3.25 H	295	29.26	15.14

REMARKS:

1. Emission Level(dBuV/m) = Raw Value(dBuV) + Correction Factor(dB/m)
2. Correction Factor(dB/m) = Antenna Factor(dB/m) + Cable Factor(dB) – Pre-Amplifier Factor(dB)
3. The other emission levels were very low against the limit.
4. Margin value = Emission Level – Limit value

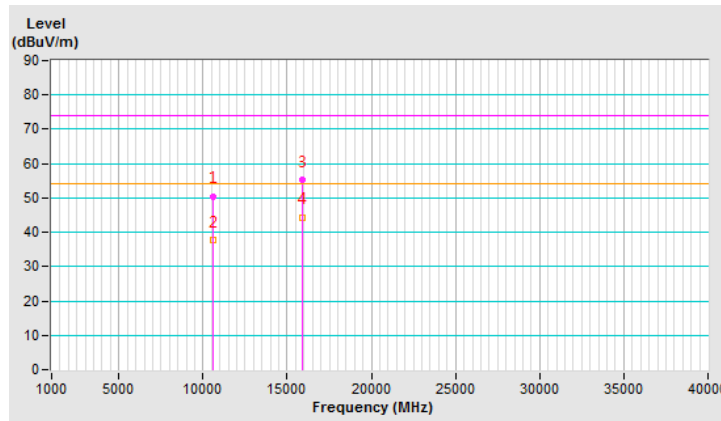

CHANNEL	TX Channel 60	DETECTOR FUNCTION	Peak (PK)
FREQUENCY RANGE	1GHz ~ 40GHz		Average (AV)

ANTENNA POLARITY & TEST DISTANCE: VERTICAL AT 3 M								
NO.	FREQ. (MHz)	EMISSION LEVEL (dBuV/m)	LIMIT (dBuV/m)	MARGIN (dB)	ANTENNA HEIGHT (m)	TABLE ANGLE (Degree)	RAW VALUE (dBuV)	CORRECTION FACTOR (dB/m)
1	10600.00	54.7 PK	74.0	-19.3	2.84 V	174	40.91	13.79
2	10600.00	43.0 AV	54.0	-11.0	2.84 V	174	29.21	13.79
3	15900.00	58.9 PK	74.0	-15.1	2.61 V	148	43.76	15.14
4	15900.00	46.8 AV	54.0	-7.2	2.61 V	148	31.66	15.14

REMARKS:

1. Emission Level(dBuV/m) = Raw Value(dBuV) + Correction Factor(dB/m)
2. Correction Factor(dB/m) = Antenna Factor(dB/m) + Cable Factor(dB) – Pre-Amplifier Factor(dB)
3. The other emission levels were very low against the limit.
4. Margin value = Emission Level – Limit value

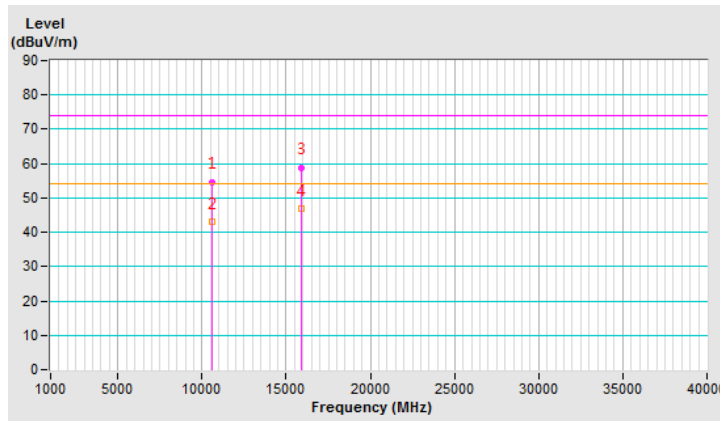

CHANNEL	TX Channel 64	DETECTOR FUNCTION	Peak (PK)
FREQUENCY RANGE	1GHz ~ 40GHz		Average (AV)

ANTENNA POLARITY & TEST DISTANCE: HORIZONTAL AT 3 M

NO.	FREQ. (MHz)	EMISSION LEVEL (dBuV/m)	LIMIT (dBuV/m)	MARGIN (dB)	ANTENNA HEIGHT (m)	TABLE ANGLE (Degree)	RAW VALUE (dBuV)	CORRECTION FACTOR (dB/m)
1	10640.00	50.2 PK	74.0	-23.8	3.37 H	195	36.29	13.91
2	10640.00	37.8 AV	54.0	-16.2	3.37 H	195	23.89	13.91
3	15960.00	55.4 PK	74.0	-18.6	3.25 H	324	40.22	15.18
4	15960.00	44.2 AV	54.0	-9.8	3.25 H	324	29.02	15.18

REMARKS:

1. Emission Level(dBuV/m) = Raw Value(dBuV) + Correction Factor(dB/m)
2. Correction Factor(dB/m) = Antenna Factor(dB/m) + Cable Factor(dB) – Pre-Amplifier Factor(dB)
3. The other emission levels were very low against the limit.
4. Margin value = Emission Level – Limit value

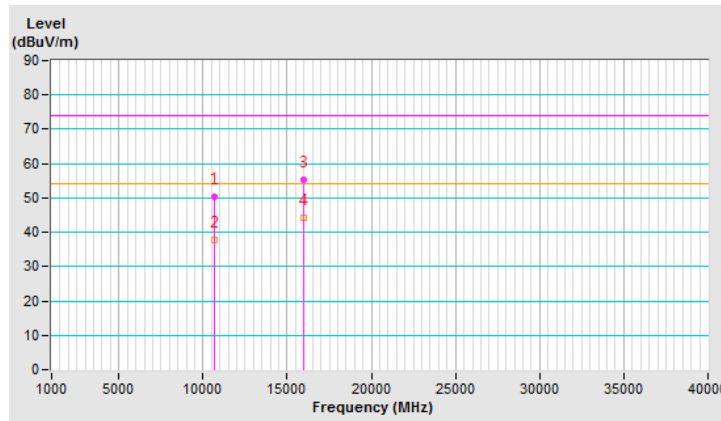

CHANNEL	TX Channel 64	DETECTOR FUNCTION	Peak (PK)
FREQUENCY RANGE	1GHz ~ 40GHz		Average (AV)

ANTENNA POLARITY & TEST DISTANCE: VERTICAL AT 3 M								
NO.	FREQ. (MHz)	EMISSION LEVEL (dBuV/m)	LIMIT (dBuV/m)	MARGIN (dB)	ANTENNA HEIGHT (m)	TABLE ANGLE (Degree)	RAW VALUE (dBuV)	CORRECTION FACTOR (dB/m)
1	10640.00	54.4 PK	74.0	-19.6	2.84 V	153	40.49	13.91
2	10640.00	42.5 AV	54.0	-11.5	2.84 V	153	28.59	13.91
3	15960.00	58.9 PK	74.0	-15.1	2.64 V	144	43.72	15.18
4	15960.00	46.7 AV	54.0	-7.3	2.64 V	144	31.52	15.18

REMARKS:

1. Emission Level(dBuV/m) = Raw Value(dBuV) + Correction Factor(dB/m)
2. Correction Factor(dB/m) = Antenna Factor(dB/m) + Cable Factor(dB) – Pre-Amplifier Factor(dB)
3. The other emission levels were very low against the limit.
4. Margin value = Emission Level – Limit value

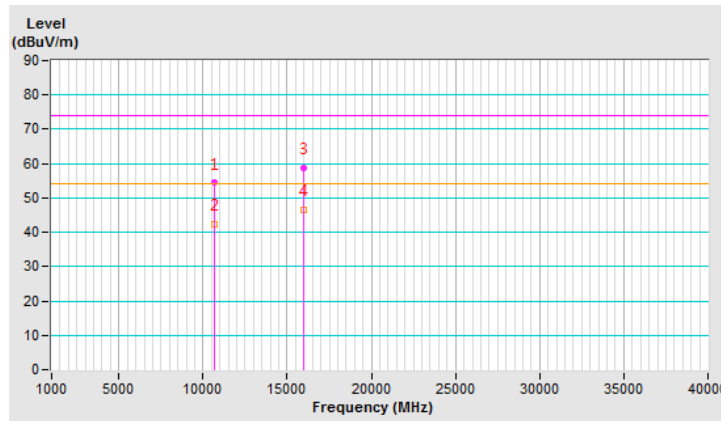

CHANNEL	TX Channel 100	DETECTOR FUNCTION	Peak (PK)
FREQUENCY RANGE	1GHz ~ 40GHz		Average (AV)

ANTENNA POLARITY & TEST DISTANCE: HORIZONTAL AT 3 M

NO.	FREQ. (MHz)	EMISSION LEVEL (dBuV/m)	LIMIT (dBuV/m)	MARGIN (dB)	ANTENNA HEIGHT (m)	TABLE ANGLE (Degree)	RAW VALUE (dBuV)	CORRECTION FACTOR (dB/m)
1	11000.00	50.3 PK	74.0	-23.7	3.44 H	187	35.23	15.07
2	11000.00	37.5 AV	54.0	-16.5	3.44 H	187	22.43	15.07
3	#16500.00	55.5 PK	74.0	-18.5	3.29 H	296	37.47	18.03
4	#16500.00	44.2 AV	54.0	-9.8	3.29 H	296	26.17	18.03

REMARKS:

1. Emission Level(dBuV/m) = Raw Value(dBuV) + Correction Factor(dB/m)
2. Correction Factor(dB/m) = Antenna Factor(dB/m) + Cable Factor(dB) – Pre-Amplifier Factor(dB)
3. The other emission levels were very low against the limit.
4. Margin value = Emission Level – Limit value
5. " # ": The radiated frequency is out of the restricted band.

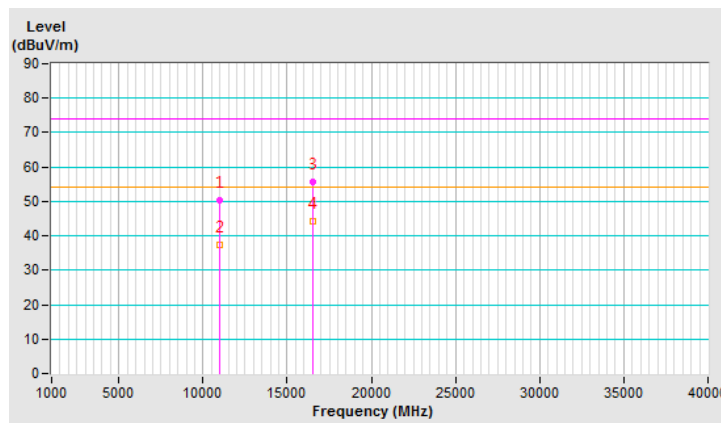

CHANNEL	TX Channel 100	DETECTOR FUNCTION	Peak (PK)
FREQUENCY RANGE	1GHz ~ 40GHz		Average (AV)

ANTENNA POLARITY & TEST DISTANCE: VERTICAL AT 3 M								
NO.	FREQ. (MHz)	EMISSION LEVEL (dBuV/m)	LIMIT (dBuV/m)	MARGIN (dB)	ANTENNA HEIGHT (m)	TABLE ANGLE (Degree)	RAW VALUE (dBuV)	CORRECTION FACTOR (dB/m)
1	11000.00	54.4 PK	74.0	-19.6	2.80 V	181	39.33	15.07
2	11000.00	42.4 AV	54.0	-11.6	2.80 V	181	27.33	15.07
3	#16500.00	59.2 PK	74.0	-14.8	2.70 V	134	41.17	18.03
4	#16500.00	47.1 AV	54.0	-6.9	2.70 V	134	29.07	18.03

REMARKS:

1. Emission Level(dBuV/m) = Raw Value(dBuV) + Correction Factor(dB/m)
2. Correction Factor(dB/m) = Antenna Factor(dB/m) + Cable Factor(dB) – Pre-Amplifier Factor(dB)
3. The other emission levels were very low against the limit.
4. Margin value = Emission Level – Limit value
5. " # ": The radiated frequency is out of the restricted band.

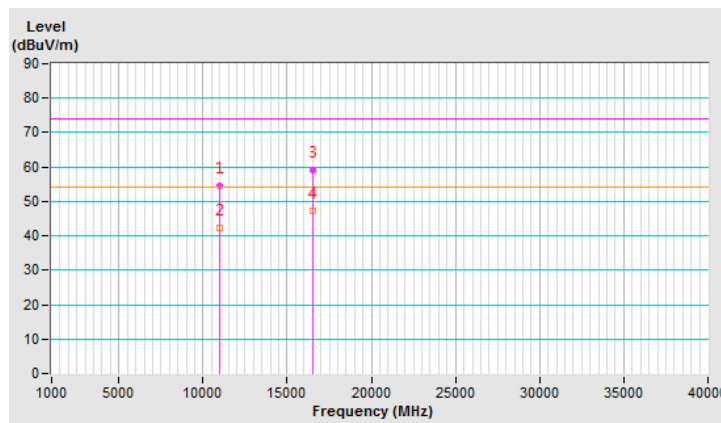

CHANNEL	TX Channel 120	DETECTOR FUNCTION	Peak (PK)
FREQUENCY RANGE	1GHz ~ 40GHz		Average (AV)

ANTENNA POLARITY & TEST DISTANCE: HORIZONTAL AT 3 M

NO.	FREQ. (MHz)	EMISSION LEVEL (dBuV/m)	LIMIT (dBuV/m)	MARGIN (dB)	ANTENNA HEIGHT (m)	TABLE ANGLE (Degree)	RAW VALUE (dBuV)	CORRECTION FACTOR (dB/m)
1	11200.00	49.7 PK	74.0	-24.3	3.36 H	167	34.75	14.95
2	11200.00	37.0 AV	54.0	-17.0	3.36 H	167	22.05	14.95
3	#16800.00	55.6 PK	74.0	-18.4	3.24 H	324	36.41	19.19
4	#16800.00	44.4 AV	54.0	-9.6	3.24 H	324	25.21	19.19

REMARKS:

1. Emission Level(dBuV/m) = Raw Value(dBuV) + Correction Factor(dB/m)
2. Correction Factor(dB/m) = Antenna Factor(dB/m) + Cable Factor(dB) – Pre-Amplifier Factor(dB)
3. The other emission levels were very low against the limit.
4. Margin value = Emission Level – Limit value
5. " # ": The radiated frequency is out of the restricted band.

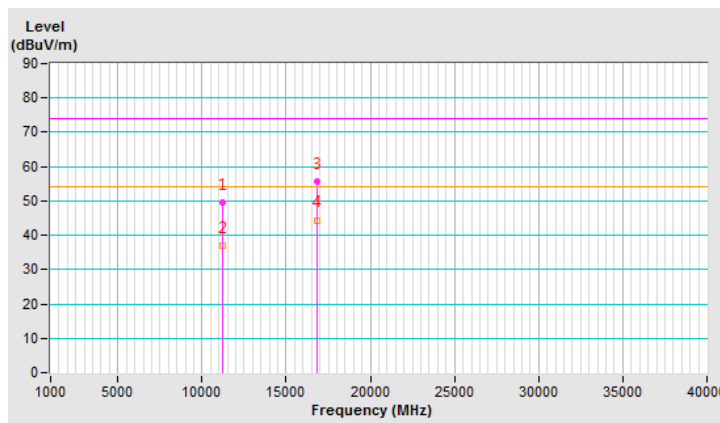

CHANNEL	TX Channel 120	DETECTOR FUNCTION	Peak (PK)
FREQUENCY RANGE	1GHz ~ 40GHz		Average (AV)

ANTENNA POLARITY & TEST DISTANCE: VERTICAL AT 3 M								
NO.	FREQ. (MHz)	EMISSION LEVEL (dBuV/m)	LIMIT (dBuV/m)	MARGIN (dB)	ANTENNA HEIGHT (m)	TABLE ANGLE (Degree)	RAW VALUE (dBuV)	CORRECTION FACTOR (dB/m)
1	11200.00	53.9 PK	74.0	-20.1	2.82 V	161	38.95	14.95
2	11200.00	42.4 AV	54.0	-11.6	2.82 V	161	27.45	14.95
3	#16800.00	58.9 PK	74.0	-15.1	2.68 V	129	39.71	19.19
4	#16800.00	47.1 AV	54.0	-6.9	2.68 V	129	27.91	19.19

REMARKS:

1. Emission Level(dBuV/m) = Raw Value(dBuV) + Correction Factor(dB/m)
2. Correction Factor(dB/m) = Antenna Factor(dB/m) + Cable Factor(dB) – Pre-Amplifier Factor(dB)
3. The other emission levels were very low against the limit.
4. Margin value = Emission Level – Limit value
5. " # ": The radiated frequency is out of the restricted band.

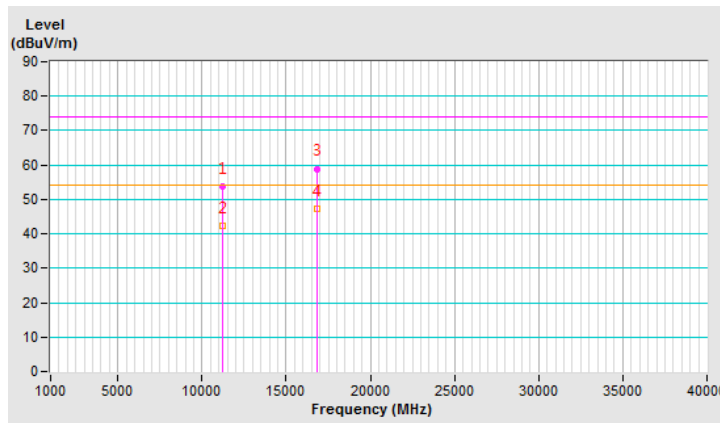

CHANNEL	TX Channel 140	DETECTOR FUNCTION	Peak (PK)
FREQUENCY RANGE	1GHz ~ 40GHz		Average (AV)

ANTENNA POLARITY & TEST DISTANCE: HORIZONTAL AT 3 M								
NO.	FREQ. (MHz)	EMISSION LEVEL (dBuV/m)	LIMIT (dBuV/m)	MARGIN (dB)	ANTENNA HEIGHT (m)	TABLE ANGLE (Degree)	RAW VALUE (dBuV)	CORRECTION FACTOR (dB/m)
1	11400.00	50.2 PK	74.0	-23.8	3.41 H	180	34.85	15.35
2	11400.00	37.7 AV	54.0	-16.3	3.41 H	180	22.35	15.35
3	#17100.00	55.8 PK	74.0	-18.2	3.30 H	313	35.70	20.10
4	#17100.00	44.9 AV	54.0	-9.1	3.30 H	313	24.80	20.10

REMARKS:

1. Emission Level(dBuV/m) = Raw Value(dBuV) + Correction Factor(dB/m)
2. Correction Factor(dB/m) = Antenna Factor(dB/m) + Cable Factor(dB) – Pre-Amplifier Factor(dB)
3. The other emission levels were very low against the limit.
4. Margin value = Emission Level – Limit value
5. " # ": The radiated frequency is out of the restricted band.

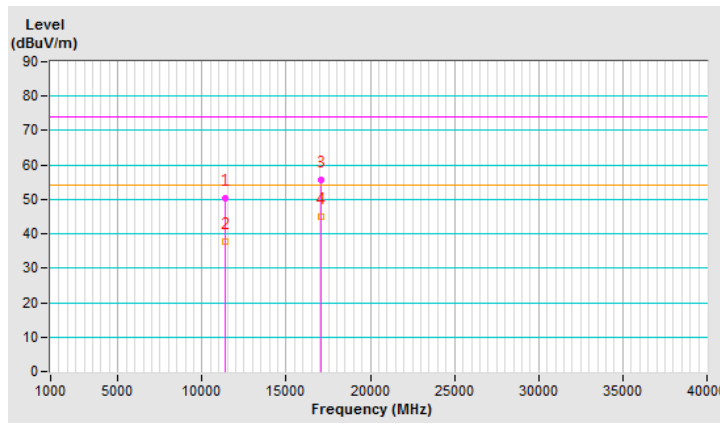

CHANNEL	TX Channel 140	DETECTOR FUNCTION	Peak (PK)
FREQUENCY RANGE	1GHz ~ 40GHz		Average (AV)

ANTENNA POLARITY & TEST DISTANCE: VERTICAL AT 3 M

NO.	FREQ. (MHz)	EMISSION LEVEL (dBuV/m)	LIMIT (dBuV/m)	MARGIN (dB)	ANTENNA HEIGHT (m)	TABLE ANGLE (Degree)	RAW VALUE (dBuV)	CORRECTION FACTOR (dB/m)
1	11400.00	54.3 PK	74.0	-19.7	2.84 V	172	38.95	15.35
2	11400.00	42.7 AV	54.0	-11.3	2.84 V	172	27.35	15.35
3	#17100.00	59.1 PK	74.0	-14.9	2.67 V	155	39.00	20.10
4	#17100.00	46.9 AV	54.0	-7.1	2.67 V	155	26.80	20.10

REMARKS:

1. Emission Level(dBuV/m) = Raw Value(dBuV) + Correction Factor(dB/m)
2. Correction Factor(dB/m) = Antenna Factor(dB/m) + Cable Factor(dB) – Pre-Amplifier Factor(dB)
3. The other emission levels were very low against the limit.
4. Margin value = Emission Level – Limit value
5. " # ": The radiated frequency is out of the restricted band.

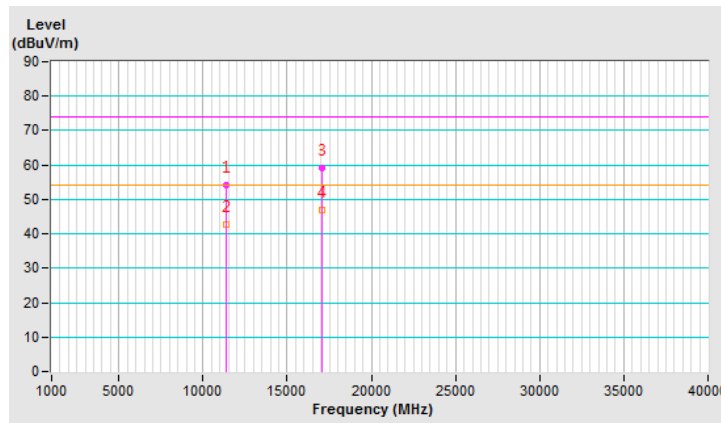

CHANNEL	TX Channel 144	DETECTOR FUNCTION	Peak (PK)
FREQUENCY RANGE	1GHz ~ 40GHz		Average (AV)

ANTENNA POLARITY & TEST DISTANCE: HORIZONTAL AT 3 M

NO.	FREQ. (MHz)	EMISSION LEVEL (dBuV/m)	LIMIT (dBuV/m)	MARGIN (dB)	ANTENNA HEIGHT (m)	TABLE ANGLE (Degree)	RAW VALUE (dBuV)	CORRECTION FACTOR (dB/m)
1	11440.00	49.9 PK	74.0	-24.1	3.37 H	153	34.64	15.26
2	11440.00	38.0 AV	54.0	-16.0	3.37 H	153	22.74	15.26
3	#17160.00	56.5 PK	74.0	-17.5	3.21 H	316	36.48	20.02
4	#17160.00	45.5 AV	54.0	-8.5	3.21 H	316	25.48	20.02

REMARKS:

1. Emission Level(dBuV/m) = Raw Value(dBuV) + Correction Factor(dB/m)
2. Correction Factor(dB/m) = Antenna Factor(dB/m) + Cable Factor(dB) – Pre-Amplifier Factor(dB)
3. The other emission levels were very low against the limit.
4. Margin value = Emission Level – Limit value
5. " # ": The radiated frequency is out of the restricted band.

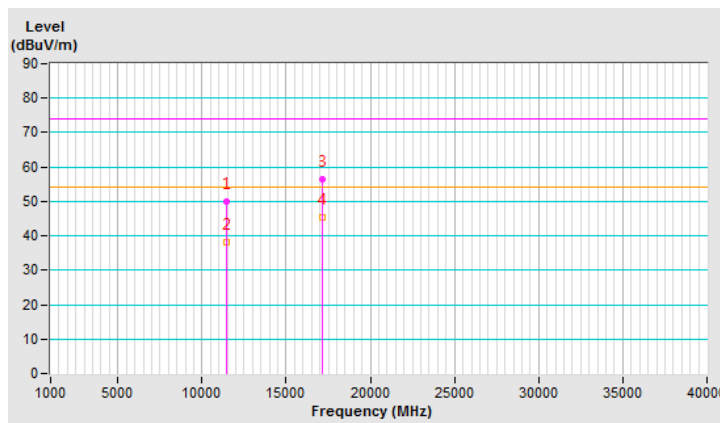

CHANNEL	TX Channel 144	DETECTOR FUNCTION	Peak (PK)
FREQUENCY RANGE	1GHz ~ 40GHz		Average (AV)

ANTENNA POLARITY & TEST DISTANCE: VERTICAL AT 3 M								
NO.	FREQ. (MHz)	EMISSION LEVEL (dBuV/m)	LIMIT (dBuV/m)	MARGIN (dB)	ANTENNA HEIGHT (m)	TABLE ANGLE (Degree)	RAW VALUE (dBuV)	CORRECTION FACTOR (dB/m)
1	11440.00	56.3 PK	74.0	-17.7	2.83 V	178	41.04	15.26
2	11440.00	43.6 AV	54.0	-10.4	2.83 V	178	28.34	15.26
3	#17160.00	59.2 PK	74.0	-14.8	2.68 V	142	39.18	20.02
4	#17160.00	47.2 AV	54.0	-6.8	2.68 V	142	27.18	20.02

REMARKS:

1. Emission Level(dBuV/m) = Raw Value(dBuV) + Correction Factor(dB/m)
2. Correction Factor(dB/m) = Antenna Factor(dB/m) + Cable Factor(dB) – Pre-Amplifier Factor(dB)
3. The other emission levels were very low against the limit.
4. Margin value = Emission Level – Limit value
5. " # ": The radiated frequency is out of the restricted band.

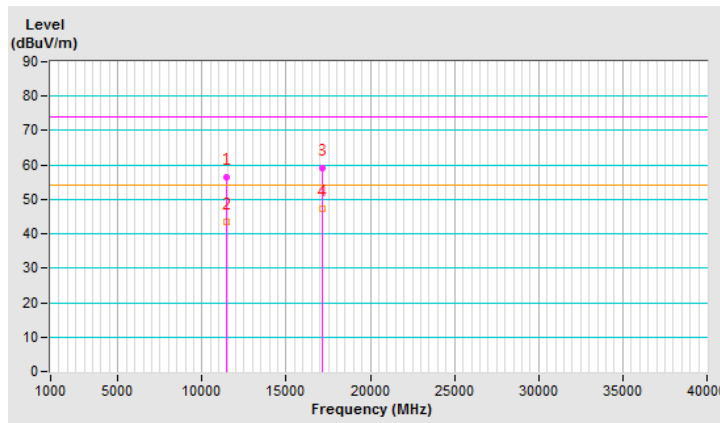

CHANNEL	TX Channel 149	DETECTOR FUNCTION	Peak (PK)
FREQUENCY RANGE	1GHz ~ 40GHz		Average (AV)

ANTENNA POLARITY & TEST DISTANCE: HORIZONTAL AT 3 M								
NO.	FREQ. (MHz)	EMISSION LEVEL (dBuV/m)	LIMIT (dBuV/m)	MARGIN (dB)	ANTENNA HEIGHT (m)	TABLE ANGLE (Degree)	RAW VALUE (dBuV)	CORRECTION FACTOR (dB/m)
1	11490.00	49.8 PK	74.0	-24.2	3.37 H	178	34.62	15.18
2	11490.00	37.8 AV	54.0	-16.2	3.37 H	178	22.62	15.18
3	#17235.00	56.1 PK	74.0	-17.9	3.20 H	308	35.94	20.16
4	#17235.00	44.9 AV	54.0	-9.1	3.20 H	308	24.74	20.16

REMARKS:

1. Emission Level(dBuV/m) = Raw Value(dBuV) + Correction Factor(dB/m)
2. Correction Factor(dB/m) = Antenna Factor(dB/m) + Cable Factor(dB) – Pre-Amplifier Factor(dB)
3. The other emission levels were very low against the limit.
4. Margin value = Emission Level – Limit value
5. " # ": The radiated frequency is out of the restricted band.

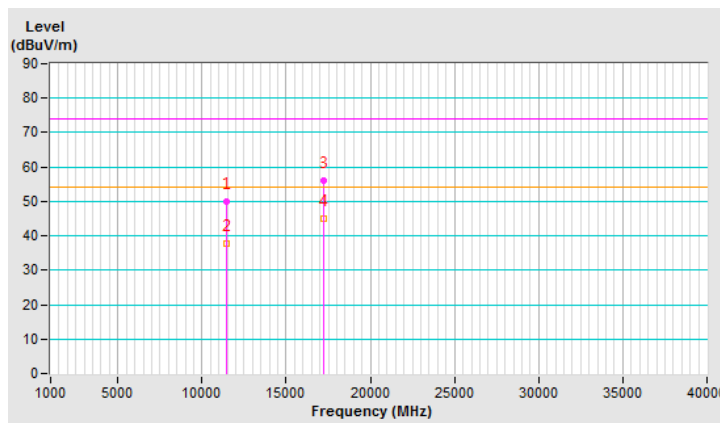

CHANNEL	TX Channel 149	DETECTOR FUNCTION	Peak (PK)
FREQUENCY RANGE	1GHz ~ 40GHz		Average (AV)

ANTENNA POLARITY & TEST DISTANCE: VERTICAL AT 3 M								
NO.	FREQ. (MHz)	EMISSION LEVEL (dBuV/m)	LIMIT (dBuV/m)	MARGIN (dB)	ANTENNA HEIGHT (m)	TABLE ANGLE (Degree)	RAW VALUE (dBuV)	CORRECTION FACTOR (dB/m)
1	11490.00	55.4 PK	74.0	-18.6	2.83 V	185	40.22	15.18
2	11490.00	43.3 AV	54.0	-10.7	2.83 V	185	28.12	15.18
3	#17235.00	60.7 PK	74.0	-13.3	2.63 V	162	40.54	20.16
4	#17235.00	47.9 AV	54.0	-6.1	2.63 V	162	27.74	20.16

REMARKS:

1. Emission Level(dBuV/m) = Raw Value(dBuV) + Correction Factor(dB/m)
2. Correction Factor(dB/m) = Antenna Factor(dB/m) + Cable Factor(dB) – Pre-Amplifier Factor(dB)
3. The other emission levels were very low against the limit.
4. Margin value = Emission Level – Limit value
5. " # ": The radiated frequency is out of the restricted band.

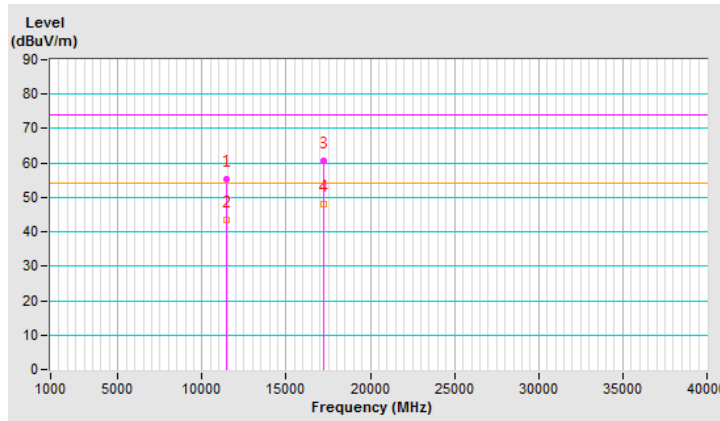

CHANNEL	TX Channel 157	DETECTOR FUNCTION	Peak (PK)
FREQUENCY RANGE	1GHz ~ 40GHz		Average (AV)

ANTENNA POLARITY & TEST DISTANCE: HORIZONTAL AT 3 M

NO.	FREQ. (MHz)	EMISSION LEVEL (dBuV/m)	LIMIT (dBuV/m)	MARGIN (dB)	ANTENNA HEIGHT (m)	TABLE ANGLE (Degree)	RAW VALUE (dBuV)	CORRECTION FACTOR (dB/m)
1	11570.00	50.7 PK	74.0	-23.3	3.38 H	175	35.77	14.93
2	11570.00	38.9 AV	54.0	-15.1	3.38 H	175	23.97	14.93
3	#17355.00	57.7 PK	74.0	-16.3	3.25 H	335	36.89	20.81
4	#17355.00	46.6 AV	54.0	-7.4	3.25 H	335	25.79	20.81

REMARKS:

1. Emission Level(dBuV/m) = Raw Value(dBuV) + Correction Factor(dB/m)
2. Correction Factor(dB/m) = Antenna Factor(dB/m) + Cable Factor(dB) – Pre-Amplifier Factor(dB)
3. The other emission levels were very low against the limit.
4. Margin value = Emission Level – Limit value
5. " # ": The radiated frequency is out of the restricted band.

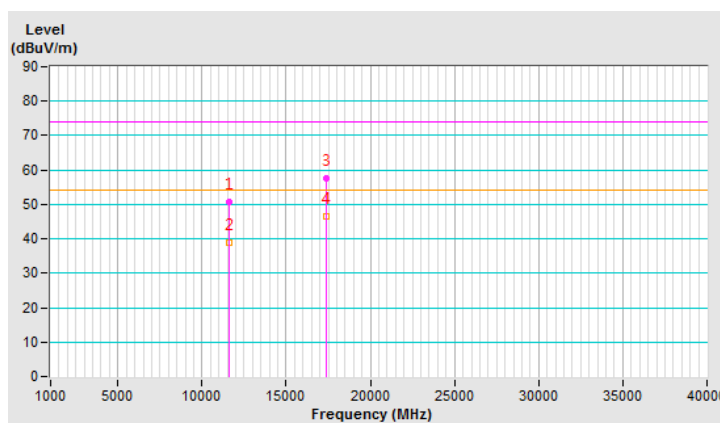

CHANNEL	TX Channel 157	DETECTOR FUNCTION	Peak (PK)
FREQUENCY RANGE	1GHz ~ 40GHz		Average (AV)

ANTENNA POLARITY & TEST DISTANCE: VERTICAL AT 3 M								
NO.	FREQ. (MHz)	EMISSION LEVEL (dBuV/m)	LIMIT (dBuV/m)	MARGIN (dB)	ANTENNA HEIGHT (m)	TABLE ANGLE (Degree)	RAW VALUE (dBuV)	CORRECTION FACTOR (dB/m)
1	11570.00	56.7 PK	74.0	-17.3	3.38 V	292	41.77	14.93
2	11570.00	44.5 AV	54.0	-9.5	3.38 V	292	29.57	14.93
3	#17355.00	61.0 PK	74.0	-13.0	3.40 V	298	40.19	20.81
4	#17355.00	48.8 AV	54.0	-5.2	3.40 V	298	27.99	20.81

REMARKS:

1. Emission Level(dBuV/m) = Raw Value(dBuV) + Correction Factor(dB/m)
2. Correction Factor(dB/m) = Antenna Factor(dB/m) + Cable Factor(dB) – Pre-Amplifier Factor(dB)
3. The other emission levels were very low against the limit.
4. Margin value = Emission Level – Limit value
5. " # ": The radiated frequency is out of the restricted band.

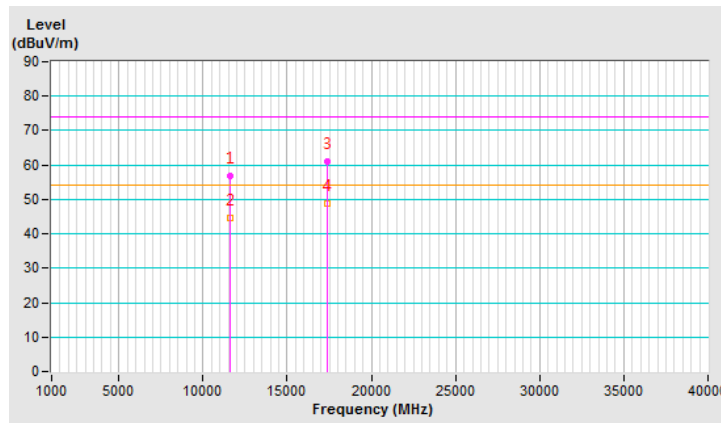

CHANNEL	TX Channel 165	DETECTOR FUNCTION	Peak (PK)
FREQUENCY RANGE	1GHz ~ 40GHz		Average (AV)

ANTENNA POLARITY & TEST DISTANCE: HORIZONTAL AT 3 M								
NO.	FREQ. (MHz)	EMISSION LEVEL (dBuV/m)	LIMIT (dBuV/m)	MARGIN (dB)	ANTENNA HEIGHT (m)	TABLE ANGLE (Degree)	RAW VALUE (dBuV)	CORRECTION FACTOR (dB/m)
1	11650.00	50.8 PK	74.0	-23.2	3.39 H	166	36.03	14.77
2	11650.00	39.1 AV	54.0	-14.9	3.39 H	166	24.33	14.77
3	#17475.00	57.8 PK	74.0	-16.2	3.29 H	322	36.26	21.54
4	#17475.00	46.7 AV	54.0	-7.3	3.29 H	322	25.16	21.54

REMARKS:

1. Emission Level(dBuV/m) = Raw Value(dBuV) + Correction Factor(dB/m)
2. Correction Factor(dB/m) = Antenna Factor(dB/m) + Cable Factor(dB) – Pre-Amplifier Factor(dB)
3. The other emission levels were very low against the limit.
4. Margin value = Emission Level – Limit value
5. " # ": The radiated frequency is out of the restricted band.

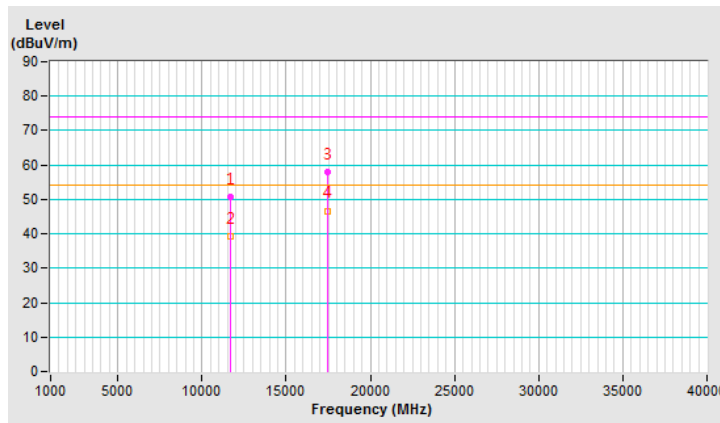

CHANNEL	TX Channel 165	DETECTOR FUNCTION	Peak (PK)
FREQUENCY RANGE	1GHz ~ 40GHz		Average (AV)

ANTENNA POLARITY & TEST DISTANCE: VERTICAL AT 3 M								
NO.	FREQ. (MHz)	EMISSION LEVEL (dBuV/m)	LIMIT (dBuV/m)	MARGIN (dB)	ANTENNA HEIGHT (m)	TABLE ANGLE (Degree)	RAW VALUE (dBuV)	CORRECTION FACTOR (dB/m)
1	11650.00	56.5 PK	74.0	-17.5	3.39 V	295	41.73	14.77
2	11650.00	44.5 AV	54.0	-9.5	3.39 V	295	29.73	14.77
3	#17475.00	60.8 PK	74.0	-13.2	3.39 V	295	39.26	21.54
4	#17475.00	48.3 AV	54.0	-5.7	3.39 V	295	26.76	21.54

REMARKS:

1. Emission Level(dBuV/m) = Raw Value(dBuV) + Correction Factor(dB/m)
2. Correction Factor(dB/m) = Antenna Factor(dB/m) + Cable Factor(dB) – Pre-Amplifier Factor(dB)
3. The other emission levels were very low against the limit.
4. Margin value = Emission Level – Limit value
5. " # ": The radiated frequency is out of the restricted band.

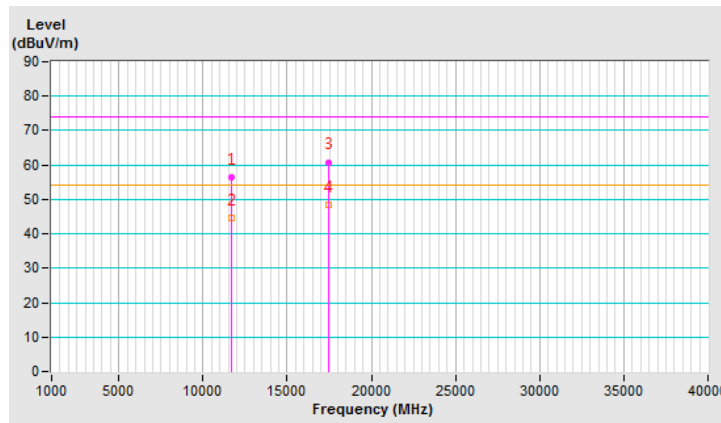

802.11n (HT40)

CHANNEL	TX Channel 38	DETECTOR FUNCTION	Peak (PK)
FREQUENCY RANGE	1GHz ~ 40GHz		Average (AV)

ANTENNA POLARITY & TEST DISTANCE: HORIZONTAL AT 3 M								
NO.	FREQ. (MHz)	EMISSION LEVEL (dBuV/m)	LIMIT (dBuV/m)	MARGIN (dB)	ANTENNA HEIGHT (m)	TABLE ANGLE (Degree)	RAW VALUE (dBuV)	CORRECTION FACTOR (dB/m)
1	#10380.00	47.6 PK	74.0	-26.4	3.38 H	182	34.13	13.47
2	#10380.00	35.4 AV	54.0	-18.6	3.38 H	182	21.93	13.47
3	15570.00	53.6 PK	74.0	-20.4	3.20 H	312	37.99	15.61
4	15570.00	42.2 AV	54.0	-11.8	3.20 H	312	26.59	15.61

REMARKS:

1. Emission Level(dBuV/m) = Raw Value(dBuV) + Correction Factor(dB/m)
2. Correction Factor(dB/m) = Antenna Factor(dB/m) + Cable Factor(dB) – Pre-Amplifier Factor(dB)
3. The other emission levels were very low against the limit.
4. Margin value = Emission Level – Limit value
5. " # ": The radiated frequency is out of the restricted band.

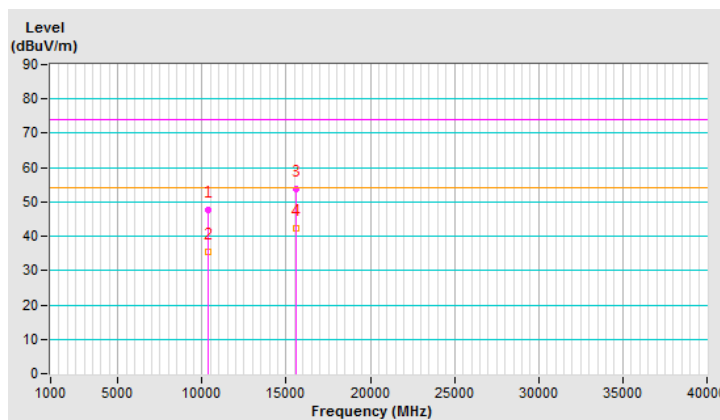

CHANNEL	TX Channel 38	DETECTOR FUNCTION	Peak (PK)
FREQUENCY RANGE	1GHz ~ 40GHz		Average (AV)

ANTENNA POLARITY & TEST DISTANCE: VERTICAL AT 3 M								
NO.	FREQ. (MHz)	EMISSION LEVEL (dBuV/m)	LIMIT (dBuV/m)	MARGIN (dB)	ANTENNA HEIGHT (m)	TABLE ANGLE (Degree)	RAW VALUE (dBuV)	CORRECTION FACTOR (dB/m)
1	#10380.00	51.3 PK	74.0	-22.7	2.81 V	175	37.83	13.47
2	#10380.00	40.2 AV	54.0	-13.8	2.81 V	175	26.73	13.47
3	15570.00	57.6 PK	74.0	-16.4	2.64 V	135	41.99	15.61
4	15570.00	45.4 AV	54.0	-8.6	2.64 V	135	29.79	15.61

REMARKS:

1. Emission Level(dBuV/m) = Raw Value(dBuV) + Correction Factor(dB/m)
2. Correction Factor(dB/m) = Antenna Factor(dB/m) + Cable Factor(dB) – Pre-Amplifier Factor(dB)
3. The other emission levels were very low against the limit.
4. Margin value = Emission Level – Limit value
5. " # ": The radiated frequency is out of the restricted band.

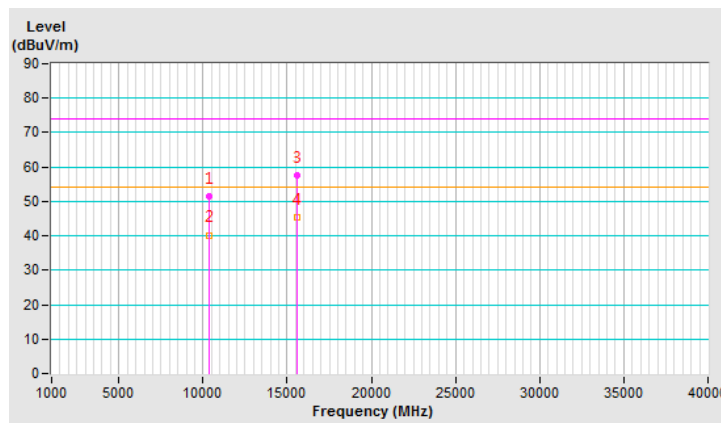

CHANNEL	TX Channel 46	DETECTOR FUNCTION	Peak (PK)
FREQUENCY RANGE	1GHz ~ 40GHz		Average (AV)

ANTENNA POLARITY & TEST DISTANCE: HORIZONTAL AT 3 M								
NO.	FREQ. (MHz)	EMISSION LEVEL (dBuV/m)	LIMIT (dBuV/m)	MARGIN (dB)	ANTENNA HEIGHT (m)	TABLE ANGLE (Degree)	RAW VALUE (dBuV)	CORRECTION FACTOR (dB/m)
1	#10460.00	47.8 PK	74.0	-26.2	3.39 H	192	34.23	13.57
2	#10460.00	35.8 AV	54.0	-18.2	3.39 H	192	22.23	13.57
3	15690.00	54.0 PK	74.0	-20.0	3.23 H	303	38.63	15.37
4	15690.00	42.6 AV	54.0	-11.4	3.23 H	303	27.23	15.37

REMARKS:

1. Emission Level(dBuV/m) = Raw Value(dBuV) + Correction Factor(dB/m)
2. Correction Factor(dB/m) = Antenna Factor(dB/m) + Cable Factor(dB) – Pre-Amplifier Factor(dB)
3. The other emission levels were very low against the limit.
4. Margin value = Emission Level – Limit value
5. " # ": The radiated frequency is out of the restricted band.

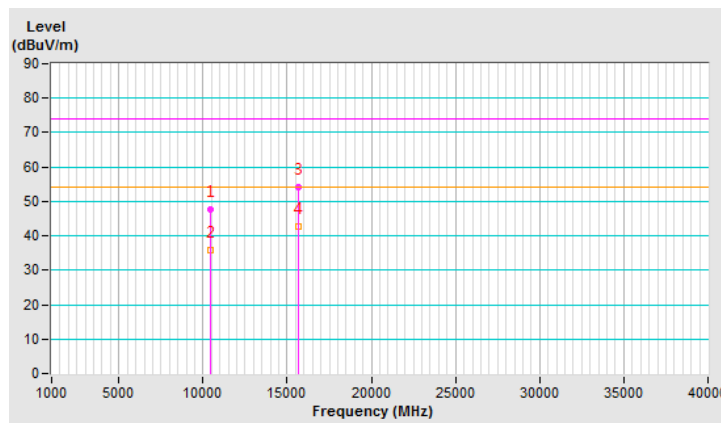

CHANNEL	TX Channel 46	DETECTOR FUNCTION	Peak (PK)
FREQUENCY RANGE	1GHz ~ 40GHz		Average (AV)

ANTENNA POLARITY & TEST DISTANCE: VERTICAL AT 3 M								
NO.	FREQ. (MHz)	EMISSION LEVEL (dBuV/m)	LIMIT (dBuV/m)	MARGIN (dB)	ANTENNA HEIGHT (m)	TABLE ANGLE (Degree)	RAW VALUE (dBuV)	CORRECTION FACTOR (dB/m)
1	#10460.00	51.9 PK	74.0	-22.1	2.85 V	171	38.33	13.57
2	#10460.00	40.5 AV	54.0	-13.5	2.85 V	171	26.93	13.57
3	15690.00	57.7 PK	74.0	-16.3	2.68 V	139	42.33	15.37
4	15690.00	45.4 AV	54.0	-8.6	2.68 V	139	30.03	15.37

REMARKS:

1. Emission Level(dBuV/m) = Raw Value(dBuV) + Correction Factor(dB/m)
2. Correction Factor(dB/m) = Antenna Factor(dB/m) + Cable Factor(dB) – Pre-Amplifier Factor(dB)
3. The other emission levels were very low against the limit.
4. Margin value = Emission Level – Limit value
5. " # ": The radiated frequency is out of the restricted band.

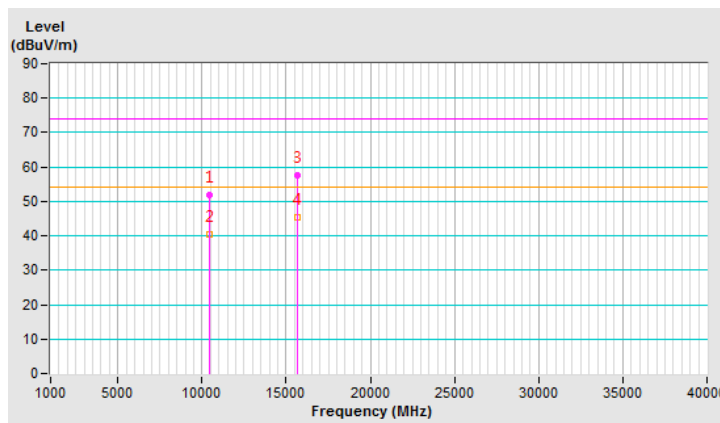

CHANNEL	TX Channel 54	DETECTOR FUNCTION	Peak (PK)
FREQUENCY RANGE	1GHz ~ 40GHz		Average (AV)

ANTENNA POLARITY & TEST DISTANCE: HORIZONTAL AT 3 M

NO.	FREQ. (MHz)	EMISSION LEVEL (dBuV/m)	LIMIT (dBuV/m)	MARGIN (dB)	ANTENNA HEIGHT (m)	TABLE ANGLE (Degree)	RAW VALUE (dBuV)	CORRECTION FACTOR (dB/m)
1	#10540.00	46.3 PK	74.0	-27.7	3.42 H	181	32.66	13.64
2	#10540.00	34.2 AV	54.0	-19.8	3.42 H	181	20.56	13.64
3	15810.00	52.4 PK	74.0	-21.6	3.26 H	293	37.32	15.08
4	15810.00	41.2 AV	54.0	-12.8	3.26 H	293	26.12	15.08

REMARKS:

1. Emission Level(dBuV/m) = Raw Value(dBuV) + Correction Factor(dB/m)
2. Correction Factor(dB/m) = Antenna Factor(dB/m) + Cable Factor(dB) – Pre-Amplifier Factor(dB)
3. The other emission levels were very low against the limit.
4. Margin value = Emission Level – Limit value
5. "#": The radiated frequency is out of the restricted band.

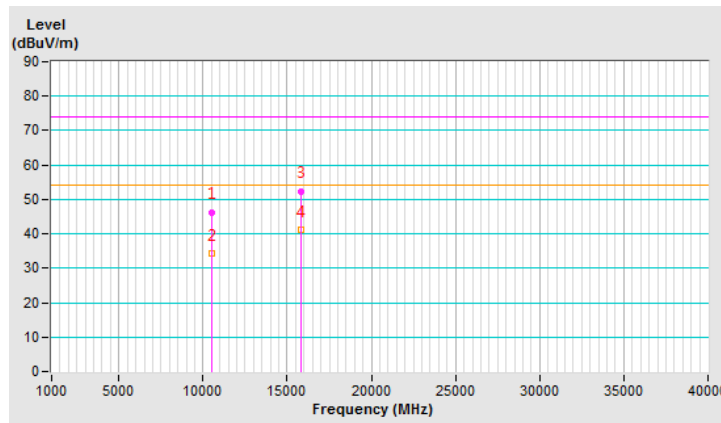

CHANNEL	TX Channel 54	DETECTOR FUNCTION	Peak (PK)
FREQUENCY RANGE	1GHz ~ 40GHz		Average (AV)

ANTENNA POLARITY & TEST DISTANCE: VERTICAL AT 3 M								
NO.	FREQ. (MHz)	EMISSION LEVEL (dBuV/m)	LIMIT (dBuV/m)	MARGIN (dB)	ANTENNA HEIGHT (m)	TABLE ANGLE (Degree)	RAW VALUE (dBuV)	CORRECTION FACTOR (dB/m)
1	#10540.00	51.4 PK	74.0	-22.6	2.84 V	179	37.76	13.64
2	#10540.00	40.0 AV	54.0	-14.0	2.84 V	179	26.36	13.64
3	15810.00	56.4 PK	74.0	-17.6	2.68 V	138	41.32	15.08
4	15810.00	44.6 AV	54.0	-9.4	2.68 V	138	29.52	15.08

REMARKS:

1. Emission Level(dBuV/m) = Raw Value(dBuV) + Correction Factor(dB/m)
2. Correction Factor(dB/m) = Antenna Factor(dB/m) + Cable Factor(dB) – Pre-Amplifier Factor(dB)
3. The other emission levels were very low against the limit.
4. Margin value = Emission Level – Limit value
5. "#": The radiated frequency is out of the restricted band.

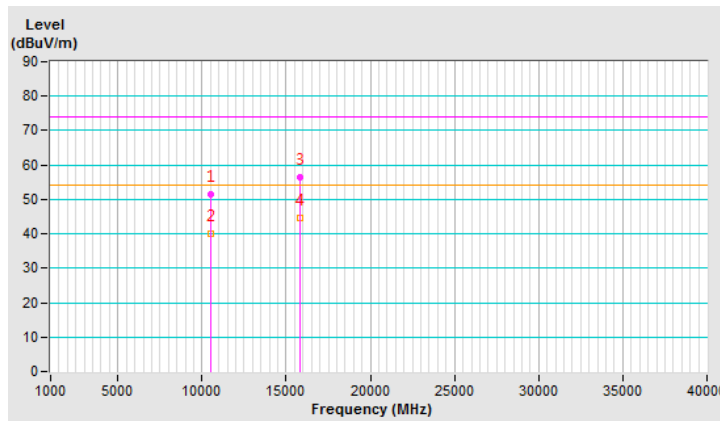

CHANNEL	TX Channel 62	DETECTOR FUNCTION	Peak (PK)
FREQUENCY RANGE	1GHz ~ 40GHz		Average (AV)

ANTENNA POLARITY & TEST DISTANCE: HORIZONTAL AT 3 M

NO.	FREQ. (MHz)	EMISSION LEVEL (dBuV/m)	LIMIT (dBuV/m)	MARGIN (dB)	ANTENNA HEIGHT (m)	TABLE ANGLE (Degree)	RAW VALUE (dBuV)	CORRECTION FACTOR (dB/m)
1	10620.00	46.6 PK	74.0	-27.4	3.42 H	191	32.75	13.85
2	10620.00	34.5 AV	54.0	-19.5	3.42 H	191	20.65	13.85
3	15930.00	52.8 PK	74.0	-21.2	3.22 H	307	37.64	15.16
4	15930.00	41.6 AV	54.0	-12.4	3.22 H	307	26.44	15.16

REMARKS:

1. Emission Level(dBuV/m) = Raw Value(dBuV) + Correction Factor(dB/m)
2. Correction Factor(dB/m) = Antenna Factor(dB/m) + Cable Factor(dB) – Pre-Amplifier Factor(dB)
3. The other emission levels were very low against the limit.
4. Margin value = Emission Level – Limit value

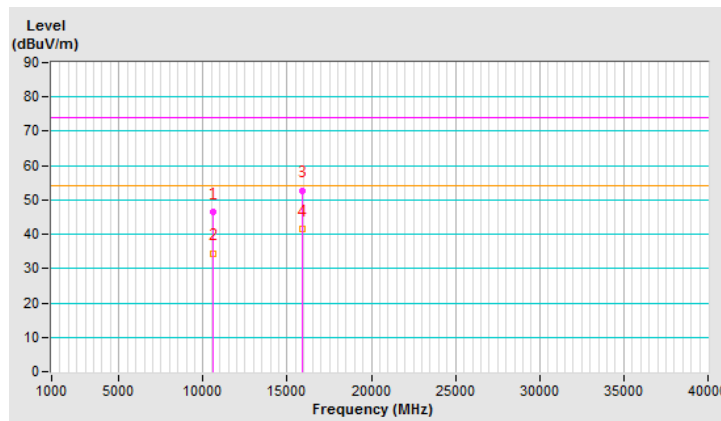

CHANNEL	TX Channel 62	DETECTOR FUNCTION	Peak (PK)
FREQUENCY RANGE	1GHz ~ 40GHz		Average (AV)

ANTENNA POLARITY & TEST DISTANCE: VERTICAL AT 3 M								
NO.	FREQ. (MHz)	EMISSION LEVEL (dBuV/m)	LIMIT (dBuV/m)	MARGIN (dB)	ANTENNA HEIGHT (m)	TABLE ANGLE (Degree)	RAW VALUE (dBuV)	CORRECTION FACTOR (dB/m)
1	10620.00	51.8 PK	74.0	-22.2	2.83 V	177	37.95	13.85
2	10620.00	40.5 AV	54.0	-13.5	2.83 V	177	26.65	13.85
3	15930.00	56.1 PK	74.0	-17.9	2.73 V	126	40.94	15.16
4	15930.00	44.2 AV	54.0	-9.8	2.73 V	126	29.04	15.16

REMARKS:

1. Emission Level(dBuV/m) = Raw Value(dBuV) + Correction Factor(dB/m)
2. Correction Factor(dB/m) = Antenna Factor(dB/m) + Cable Factor(dB) – Pre-Amplifier Factor(dB)
3. The other emission levels were very low against the limit.
4. Margin value = Emission Level – Limit value

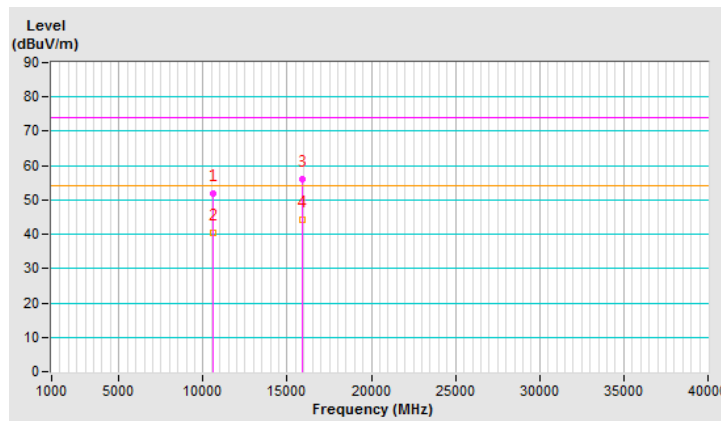

CHANNEL	TX Channel 102	DETECTOR FUNCTION	Peak (PK)
FREQUENCY RANGE	1GHz ~ 40GHz		Average (AV)

ANTENNA POLARITY & TEST DISTANCE: HORIZONTAL AT 3 M

NO.	FREQ. (MHz)	EMISSION LEVEL (dBuV/m)	LIMIT (dBuV/m)	MARGIN (dB)	ANTENNA HEIGHT (m)	TABLE ANGLE (Degree)	RAW VALUE (dBuV)	CORRECTION FACTOR (dB/m)
1	11020.00	46.2 PK	74.0	-27.8	3.47 H	196	31.16	15.04
2	11020.00	34.0 AV	54.0	-20.0	3.47 H	196	18.96	15.04
3	#16530.00	52.4 PK	74.0	-21.6	3.30 H	296	34.15	18.25
4	#16530.00	41.0 AV	54.0	-13.0	3.30 H	296	22.75	18.25

REMARKS:

1. Emission Level(dBuV/m) = Raw Value(dBuV) + Correction Factor(dB/m)
2. Correction Factor(dB/m) = Antenna Factor(dB/m) + Cable Factor(dB) – Pre-Amplifier Factor(dB)
3. The other emission levels were very low against the limit.
4. Margin value = Emission Level – Limit value
5. " # ": The radiated frequency is out of the restricted band.

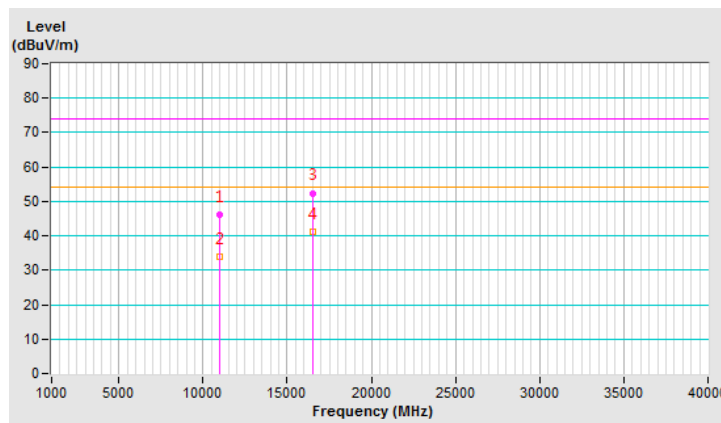

CHANNEL	TX Channel 102	DETECTOR FUNCTION	Peak (PK)
FREQUENCY RANGE	1GHz ~ 40GHz		Average (AV)

ANTENNA POLARITY & TEST DISTANCE: VERTICAL AT 3 M								
NO.	FREQ. (MHz)	EMISSION LEVEL (dBuV/m)	LIMIT (dBuV/m)	MARGIN (dB)	ANTENNA HEIGHT (m)	TABLE ANGLE (Degree)	RAW VALUE (dBuV)	CORRECTION FACTOR (dB/m)
1	11020.00	51.0 PK	74.0	-23.0	2.87 V	191	35.96	15.04
2	11020.00	40.0 AV	54.0	-14.0	2.87 V	191	24.96	15.04
3	#16530.00	56.0 PK	74.0	-18.0	2.68 V	115	37.75	18.25
4	#16530.00	43.6 AV	54.0	-10.4	2.68 V	115	25.35	18.25

REMARKS:

1. Emission Level(dBuV/m) = Raw Value(dBuV) + Correction Factor(dB/m)
2. Correction Factor(dB/m) = Antenna Factor(dB/m) + Cable Factor(dB) – Pre-Amplifier Factor(dB)
3. The other emission levels were very low against the limit.
4. Margin value = Emission Level – Limit value
5. " # ": The radiated frequency is out of the restricted band.

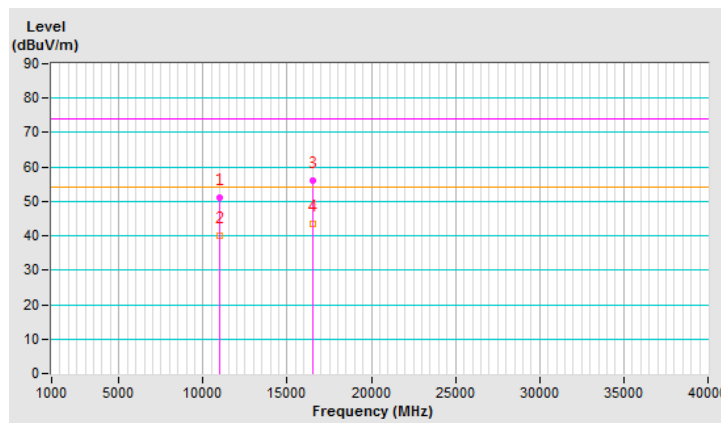

CHANNEL	TX Channel 118	DETECTOR FUNCTION	Peak (PK)
FREQUENCY RANGE	1GHz ~ 40GHz		Average (AV)

ANTENNA POLARITY & TEST DISTANCE: HORIZONTAL AT 3 M								
NO.	FREQ. (MHz)	EMISSION LEVEL (dBuV/m)	LIMIT (dBuV/m)	MARGIN (dB)	ANTENNA HEIGHT (m)	TABLE ANGLE (Degree)	RAW VALUE (dBuV)	CORRECTION FACTOR (dB/m)
1	11180.00	46.6 PK	74.0	-27.4	3.50 H	198	31.65	14.95
2	11180.00	34.5 AV	54.0	-19.5	3.50 H	198	19.55	14.95
3	#16770.00	52.3 PK	74.0	-21.7	3.28 H	284	33.14	19.16
4	#16770.00	41.1 AV	54.0	-12.9	3.28 H	284	21.94	19.16

REMARKS:

1. Emission Level(dBuV/m) = Raw Value(dBuV) + Correction Factor(dB/m)
2. Correction Factor(dB/m) = Antenna Factor(dB/m) + Cable Factor(dB) – Pre-Amplifier Factor(dB)
3. The other emission levels were very low against the limit.
4. Margin value = Emission Level – Limit value
5. " # ": The radiated frequency is out of the restricted band.

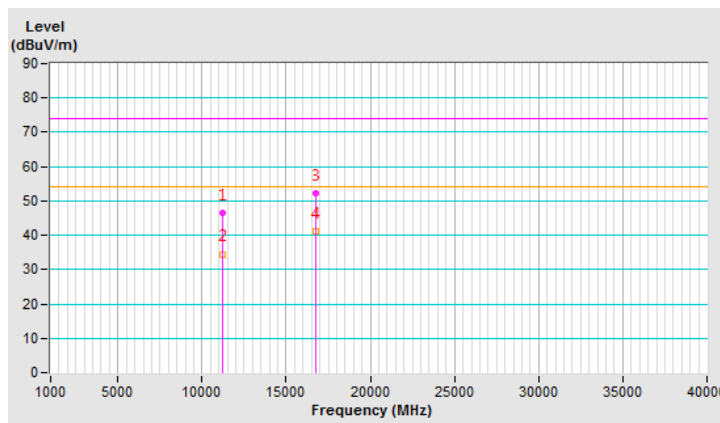

CHANNEL	TX Channel 118	DETECTOR FUNCTION	Peak (PK)
FREQUENCY RANGE	1GHz ~ 40GHz		Average (AV)

ANTENNA POLARITY & TEST DISTANCE: VERTICAL AT 3 M								
NO.	FREQ. (MHz)	EMISSION LEVEL (dBuV/m)	LIMIT (dBuV/m)	MARGIN (dB)	ANTENNA HEIGHT (m)	TABLE ANGLE (Degree)	RAW VALUE (dBuV)	CORRECTION FACTOR (dB/m)
1	11180.00	51.1 PK	74.0	-22.9	2.83 V	201	36.15	14.95
2	11180.00	40.2 AV	54.0	-13.8	2.83 V	201	25.25	14.95
3	#16770.00	56.5 PK	74.0	-17.5	2.66 V	110	37.34	19.16
4	#16770.00	43.9 AV	54.0	-10.1	2.66 V	110	24.74	19.16

REMARKS:

1. Emission Level(dBuV/m) = Raw Value(dBuV) + Correction Factor(dB/m)
2. Correction Factor(dB/m) = Antenna Factor(dB/m) + Cable Factor(dB) – Pre-Amplifier Factor(dB)
3. The other emission levels were very low against the limit.
4. Margin value = Emission Level – Limit value
5. " # ": The radiated frequency is out of the restricted band.

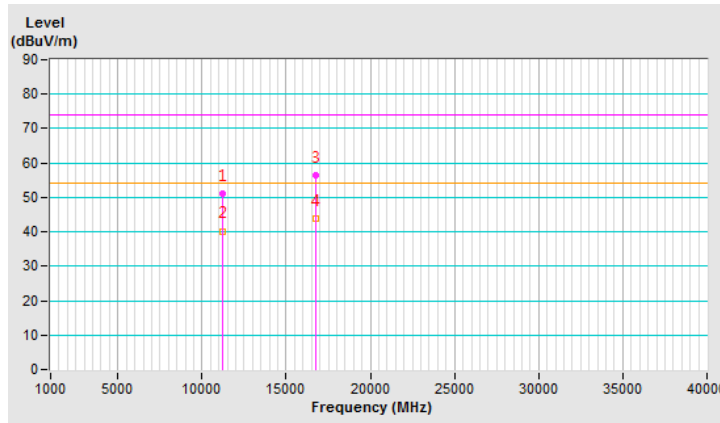

CHANNEL	TX Channel 134	DETECTOR FUNCTION	Peak (PK)
FREQUENCY RANGE	1GHz ~ 40GHz		Average (AV)

ANTENNA POLARITY & TEST DISTANCE: HORIZONTAL AT 3 M

NO.	FREQ. (MHz)	EMISSION LEVEL (dBuV/m)	LIMIT (dBuV/m)	MARGIN (dB)	ANTENNA HEIGHT (m)	TABLE ANGLE (Degree)	RAW VALUE (dBuV)	CORRECTION FACTOR (dB/m)
1	11340.00	46.7 PK	74.0	-27.3	3.48 H	196	31.28	15.42
2	11340.00	34.4 AV	54.0	-19.6	3.48 H	196	18.98	15.42
3	#17010.00	52.7 PK	74.0	-21.3	3.28 H	299	32.60	20.10
4	#17010.00	41.2 AV	54.0	-12.8	3.28 H	299	21.10	20.10

REMARKS:

1. Emission Level(dBuV/m) = Raw Value(dBuV) + Correction Factor(dB/m)
2. Correction Factor(dB/m) = Antenna Factor(dB/m) + Cable Factor(dB) – Pre-Amplifier Factor(dB)
3. The other emission levels were very low against the limit.
4. Margin value = Emission Level – Limit value
5. " # ": The radiated frequency is out of the restricted band.

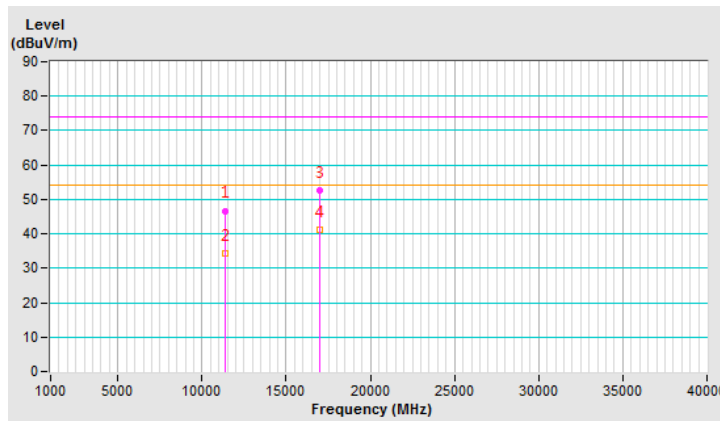

CHANNEL	TX Channel 134	DETECTOR FUNCTION	Peak (PK)
FREQUENCY RANGE	1GHz ~ 40GHz		Average (AV)

ANTENNA POLARITY & TEST DISTANCE: VERTICAL AT 3 M								
NO.	FREQ. (MHz)	EMISSION LEVEL (dBuV/m)	LIMIT (dBuV/m)	MARGIN (dB)	ANTENNA HEIGHT (m)	TABLE ANGLE (Degree)	RAW VALUE (dBuV)	CORRECTION FACTOR (dB/m)
1	11340.00	51.5 PK	74.0	-22.5	2.85 V	202	36.08	15.42
2	11340.00	40.3 AV	54.0	-13.7	2.85 V	202	24.88	15.42
3	#17010.00	55.8 PK	74.0	-18.2	2.69 V	110	35.70	20.10
4	#17010.00	43.4 AV	54.0	-10.6	2.69 V	110	23.30	20.10

REMARKS:

1. Emission Level(dBuV/m) = Raw Value(dBuV) + Correction Factor(dB/m)
2. Correction Factor(dB/m) = Antenna Factor(dB/m) + Cable Factor(dB) – Pre-Amplifier Factor(dB)
3. The other emission levels were very low against the limit.
4. Margin value = Emission Level – Limit value
5. " # ": The radiated frequency is out of the restricted band.

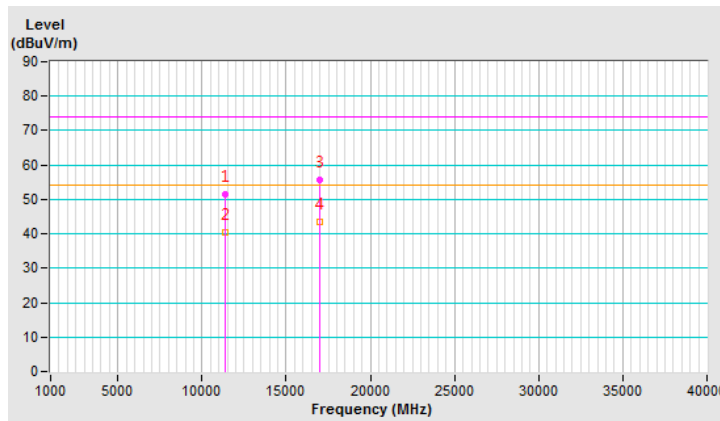

CHANNEL	TX Channel 142	DETECTOR FUNCTION	Peak (PK)
FREQUENCY RANGE	1GHz ~ 40GHz		Average (AV)

ANTENNA POLARITY & TEST DISTANCE: HORIZONTAL AT 3 M								
NO.	FREQ. (MHz)	EMISSION LEVEL (dBuV/m)	LIMIT (dBuV/m)	MARGIN (dB)	ANTENNA HEIGHT (m)	TABLE ANGLE (Degree)	RAW VALUE (dBuV)	CORRECTION FACTOR (dB/m)
1	11420.00	46.0 PK	74.0	-28.0	3.42 H	170	30.70	15.30
2	11420.00	33.8 AV	54.0	-20.2	3.42 H	170	18.50	15.30
3	#17130.00	52.2 PK	74.0	-21.8	3.27 H	281	32.15	20.05
4	#17130.00	41.2 AV	54.0	-12.8	3.27 H	281	21.15	20.05

REMARKS:

1. Emission Level(dBuV/m) = Raw Value(dBuV) + Correction Factor(dB/m)
2. Correction Factor(dB/m) = Antenna Factor(dB/m) + Cable Factor(dB) – Pre-Amplifier Factor(dB)
3. The other emission levels were very low against the limit.
4. Margin value = Emission Level – Limit value
5. " # ": The radiated frequency is out of the restricted band.

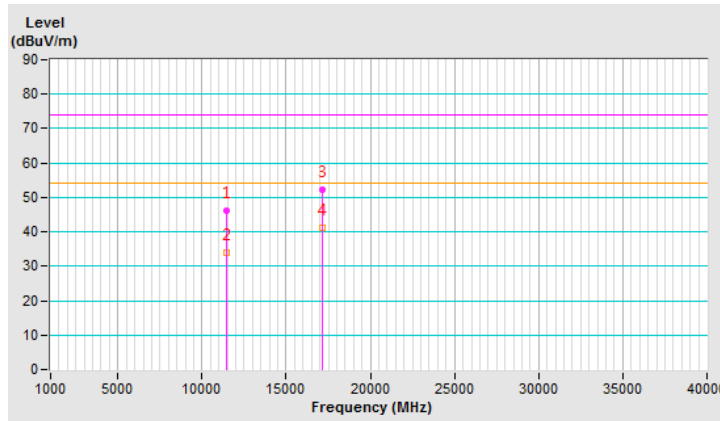

CHANNEL	TX Channel 142	DETECTOR FUNCTION	Peak (PK)
FREQUENCY RANGE	1GHz ~ 40GHz		Average (AV)

ANTENNA POLARITY & TEST DISTANCE: VERTICAL AT 3 M

NO.	FREQ. (MHz)	EMISSION LEVEL (dBuV/m)	LIMIT (dBuV/m)	MARGIN (dB)	ANTENNA HEIGHT (m)	TABLE ANGLE (Degree)	RAW VALUE (dBuV)	CORRECTION FACTOR (dB/m)
1	11420.00	51.0 PK	74.0	-23.0	2.89 V	168	35.70	15.30
2	11420.00	39.6 AV	54.0	-14.4	2.89 V	168	24.30	15.30
3	#17130.00	56.4 PK	74.0	-17.6	2.63 V	138	36.35	20.05
4	#17130.00	44.5 AV	54.0	-9.5	2.63 V	138	24.45	20.05

REMARKS:

1. Emission Level(dBuV/m) = Raw Value(dBuV) + Correction Factor(dB/m)
2. Correction Factor(dB/m) = Antenna Factor(dB/m) + Cable Factor(dB) – Pre-Amplifier Factor(dB)
3. The other emission levels were very low against the limit.
4. Margin value = Emission Level – Limit value
5. " # ": The radiated frequency is out of the restricted band.

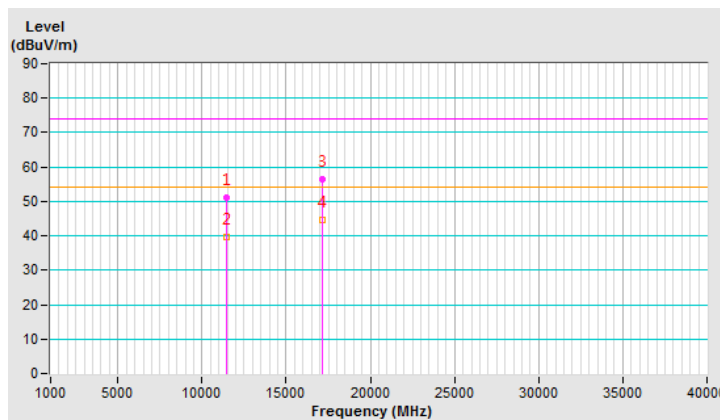

CHANNEL	TX Channel 151	DETECTOR FUNCTION	Peak (PK)
FREQUENCY RANGE	1GHz ~ 40GHz		Average (AV)

ANTENNA POLARITY & TEST DISTANCE: HORIZONTAL AT 3 M								
NO.	FREQ. (MHz)	EMISSION LEVEL (dBuV/m)	LIMIT (dBuV/m)	MARGIN (dB)	ANTENNA HEIGHT (m)	TABLE ANGLE (Degree)	RAW VALUE (dBuV)	CORRECTION FACTOR (dB/m)
1	11510.00	47.5 PK	74.0	-26.5	3.37 H	172	32.38	15.12
2	11510.00	35.1 AV	54.0	-18.9	3.37 H	172	19.98	15.12
3	#17265.00	53.8 PK	74.0	-20.2	3.26 H	308	33.47	20.33
4	#17265.00	42.5 AV	54.0	-11.5	3.26 H	308	22.17	20.33

REMARKS:

1. Emission Level(dBuV/m) = Raw Value(dBuV) + Correction Factor(dB/m)
2. Correction Factor(dB/m) = Antenna Factor(dB/m) + Cable Factor(dB) – Pre-Amplifier Factor(dB)
3. The other emission levels were very low against the limit.
4. Margin value = Emission Level – Limit value
5. " # ": The radiated frequency is out of the restricted band.

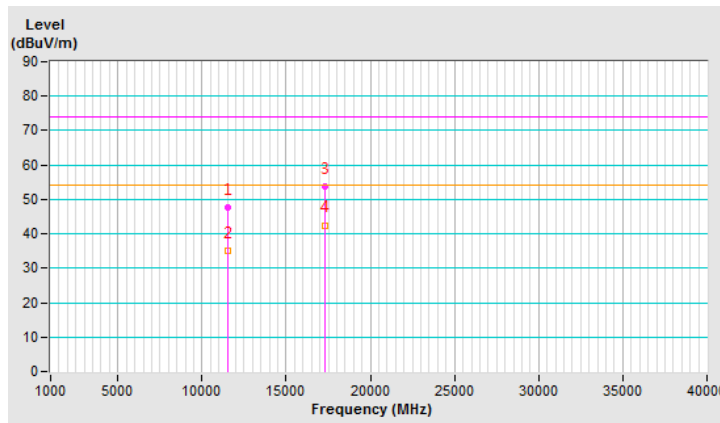

CHANNEL	TX Channel 151	DETECTOR FUNCTION	Peak (PK)
FREQUENCY RANGE	1GHz ~ 40GHz		Average (AV)

ANTENNA POLARITY & TEST DISTANCE: VERTICAL AT 3 M								
NO.	FREQ. (MHz)	EMISSION LEVEL (dBuV/m)	LIMIT (dBuV/m)	MARGIN (dB)	ANTENNA HEIGHT (m)	TABLE ANGLE (Degree)	RAW VALUE (dBuV)	CORRECTION FACTOR (dB/m)
1	11510.00	51.5 PK	74.0	-22.5	2.87 V	168	36.38	15.12
2	11510.00	40.5 AV	54.0	-13.5	2.87 V	168	25.38	15.12
3	#17265.00	57.6 PK	74.0	-16.4	2.61 V	143	37.27	20.33
4	#17265.00	45.5 AV	54.0	-8.5	2.61 V	143	25.17	20.33

REMARKS:

1. Emission Level(dBuV/m) = Raw Value(dBuV) + Correction Factor(dB/m)
2. Correction Factor(dB/m) = Antenna Factor(dB/m) + Cable Factor(dB) – Pre-Amplifier Factor(dB)
3. The other emission levels were very low against the limit.
4. Margin value = Emission Level – Limit value
5. " # ": The radiated frequency is out of the restricted band.

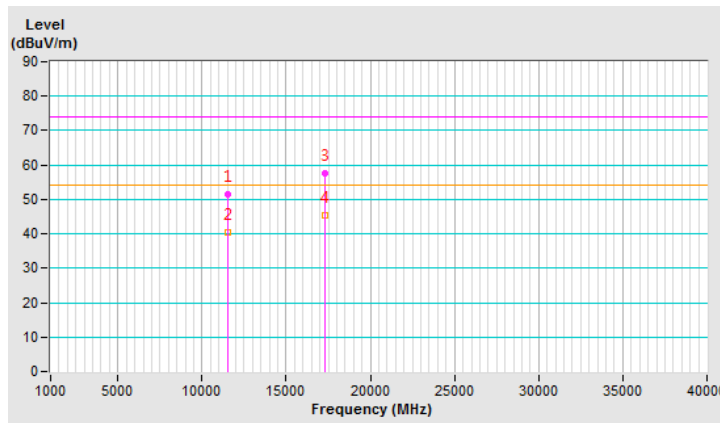

CHANNEL	TX Channel 159	DETECTOR FUNCTION	Peak (PK)
FREQUENCY RANGE	1GHz ~ 40GHz		Average (AV)

ANTENNA POLARITY & TEST DISTANCE: HORIZONTAL AT 3 M								
NO.	FREQ. (MHz)	EMISSION LEVEL (dBuV/m)	LIMIT (dBuV/m)	MARGIN (dB)	ANTENNA HEIGHT (m)	TABLE ANGLE (Degree)	RAW VALUE (dBuV)	CORRECTION FACTOR (dB/m)
1	11590.00	47.4 PK	74.0	-26.6	3.33 H	190	32.54	14.86
2	11590.00	35.1 AV	54.0	-18.9	3.33 H	190	20.24	14.86
3	#17385.00	53.8 PK	74.0	-20.2	3.16 H	306	32.84	20.96
4	#17385.00	42.4 AV	54.0	-11.6	3.16 H	306	21.44	20.96

REMARKS:

1. Emission Level(dBuV/m) = Raw Value(dBuV) + Correction Factor(dB/m)
2. Correction Factor(dB/m) = Antenna Factor(dB/m) + Cable Factor(dB) – Pre-Amplifier Factor(dB)
3. The other emission levels were very low against the limit.
4. Margin value = Emission Level – Limit value
5. " # ": The radiated frequency is out of the restricted band.

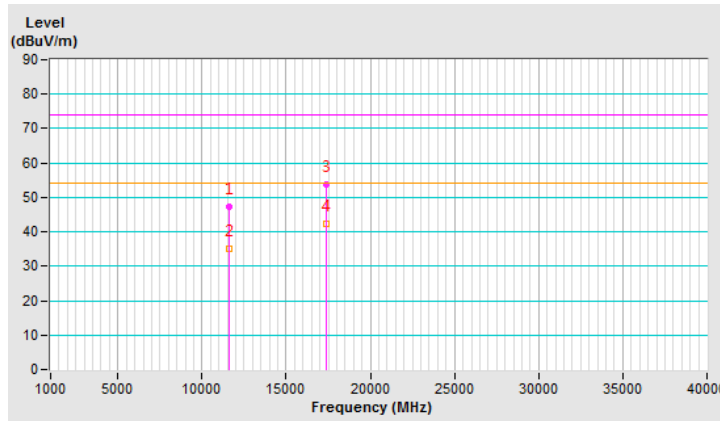

CHANNEL	TX Channel 159	DETECTOR FUNCTION	Peak (PK)
FREQUENCY RANGE	1GHz ~ 40GHz		Average (AV)

ANTENNA POLARITY & TEST DISTANCE: VERTICAL AT 3 M								
NO.	FREQ. (MHz)	EMISSION LEVEL (dBuV/m)	LIMIT (dBuV/m)	MARGIN (dB)	ANTENNA HEIGHT (m)	TABLE ANGLE (Degree)	RAW VALUE (dBuV)	CORRECTION FACTOR (dB/m)
1	11590.00	51.2 PK	74.0	-22.8	2.83 V	178	36.34	14.86
2	11590.00	40.0 AV	54.0	-14.0	2.83 V	178	25.14	14.86
3	#17385.00	57.8 PK	74.0	-16.2	2.58 V	133	36.84	20.96
4	#17385.00	45.7 AV	54.0	-8.3	2.58 V	133	24.74	20.96

REMARKS:

1. Emission Level(dBuV/m) = Raw Value(dBuV) + Correction Factor(dB/m)
2. Correction Factor(dB/m) = Antenna Factor(dB/m) + Cable Factor(dB) – Pre-Amplifier Factor(dB)
3. The other emission levels were very low against the limit.
4. Margin value = Emission Level – Limit value
5. " # ": The radiated frequency is out of the restricted band.

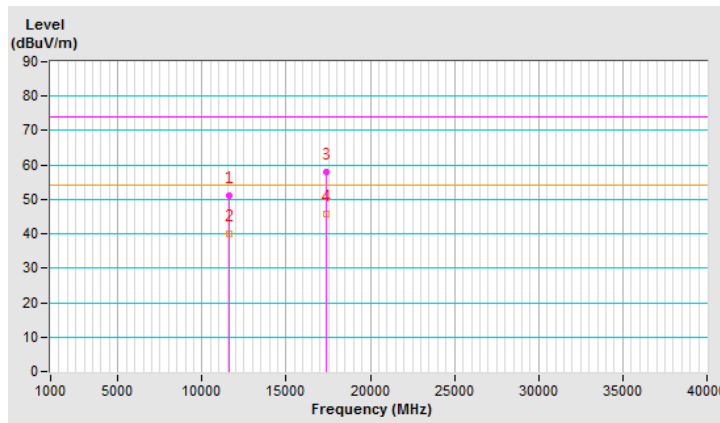

Below 1GHz Data:
802.11a

CHANNEL	TX Channel 52	DETECTOR FUNCTION	Quasi-Peak (QP)
FREQUENCY RANGE	30MHz ~ 1GHz		

ANTENNA POLARITY & TEST DISTANCE: HORIZONTAL AT 3 M								
NO.	FREQ. (MHz)	EMISSION LEVEL (dBuV/m)	LIMIT (dBuV/m)	MARGIN (dB)	ANTENNA HEIGHT (m)	TABLE ANGLE (Degree)	RAW VALUE (dBuV)	CORRECTION FACTOR (dB/m)
1	237.29	35.2 QP	46.0	-10.9	2.00 H	66	44.86	-9.71
2	249.22	36.3 QP	46.0	-9.7	1.00 H	212	45.53	-9.19
3	305.14	32.2 QP	46.0	-13.8	1.00 H	97	39.41	-7.24
4	433.18	37.9 QP	46.0	-8.1	1.00 H	31	41.60	-3.66
5	499.82	35.9 QP	46.0	-10.1	2.00 H	32	38.36	-2.50
6	780.00	35.4 QP	46.0	-10.6	1.00 H	303	32.30	3.09

REMARKS:

1. Emission Level(dBuV/m) = Raw Value(dBuV) + Correction Factor(dB/m)
2. Correction Factor(dB/m) = Antenna Factor(dB/m) + Cable Factor(dB) – Pre-Amplifier Factor(dB)
3. The other emission levels were very low against the limit.
4. Margin value = Emission Level – Limit value

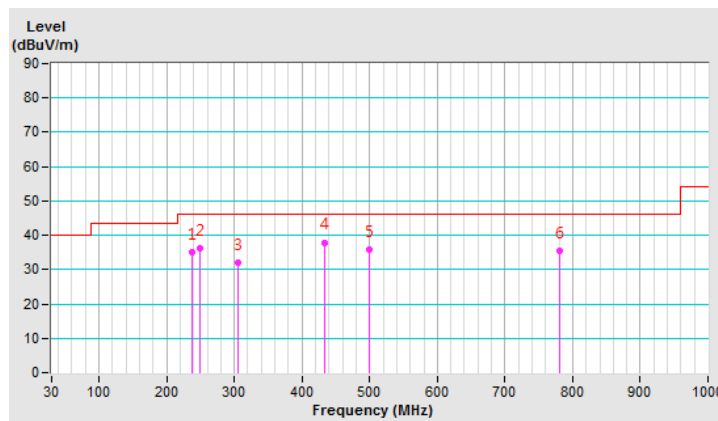

CHANNEL	TX Channel 52	DETECTOR FUNCTION	Quasi-Peak (QP)
FREQUENCY RANGE	30MHz ~ 1GHz		

ANTENNA POLARITY & TEST DISTANCE: VERTICAL AT 3 M								
NO.	FREQ. (MHz)	EMISSION LEVEL (dBuV/m)	LIMIT (dBuV/m)	MARGIN (dB)	ANTENNA HEIGHT (m)	TABLE ANGLE (Degree)	RAW VALUE (dBuV)	CORRECTION FACTOR (dB/m)
1	41.40	33.2 QP	40.0	-6.8	1.10 V	108	41.90	-8.68
2	71.10	33.6 QP	40.0	-6.4	1.00 V	300	43.89	-10.29
3	236.55	34.4 QP	46.0	-11.6	1.50 V	12	44.19	-9.79
4	305.10	34.3 QP	46.0	-11.7	1.40 V	302	41.52	-7.24
5	474.68	35.1 QP	46.0	-10.9	1.10 V	303	38.04	-2.92
6	508.60	38.9 QP	46.0	-7.1	1.10 V	126	41.09	-2.23

REMARKS:

1. Emission Level(dBuV/m) = Raw Value(dBuV) + Correction Factor(dB/m)
2. Correction Factor(dB/m) = Antenna Factor(dB/m) + Cable Factor(dB) – Pre-Amplifier Factor(dB)
3. The other emission levels were very low against the limit.
4. Margin value = Emission Level – Limit value

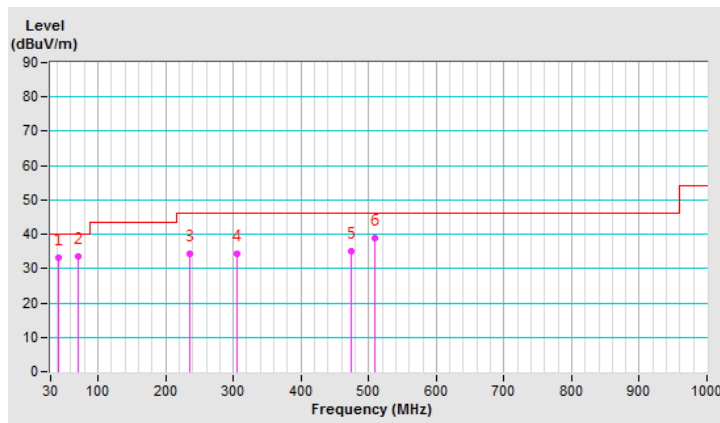

4.4.8 Test Results (Conducted Measurement)

Radiated versus Conducted Measurement	
<input checked="" type="checkbox"/> Conducted measurement	<input type="checkbox"/> Radiated measurement
<p><u>For Radiated measurement:</u> The level of unwanted emissions was measured when radiated by the cabinet or structure of the equipment with the antenna connector(s) terminated by a specified load (cabinet radiation)</p> <p><u>For Conducted measurement:</u> The level of unwanted emissions was measured as their power in a specified load (conducted spurious emissions).</p>	

Conducted Measurement Factor
<p>a. The max antenna gain were be used for conducted measurement.</p> <p>b. For the out of band spurious the gain for the specific band may have been used rather than the highest gain across all bands.</p> <p>c. For the band edge the gain for the specific band may have been used.</p> <p>d. In restricted bands below 1000 MHz, add upper bound on ground plane reflection: For $f = 30 - 1000$ MHz, add 4.7 dB.</p> <p>Note: The conducted emission test was considered some factor to compute test result.</p>

For testing, we select the highest gain on each frequency band for calculation and testing
The detail information as below:

5725~5850MHz:

Transmitter Circuit	Brand	Model	Ant. Type	5GHz Gain with cable loss (dBi)	5GHz Cable Loss (dB)	Connector Type	Cable Length (mm)
Chain (0)+(1)	WNC	81.EBJ15.005	PIFA	5.725~5.85GHz: 4.76	5.725~5.85GHz: 1.79	IPEX	300

5150~5350MHz, 5470~5725MHz:

Transmitter Circuit	Brand	Model	Ant. Type	5GHz Gain with cable loss (dBi)	5GHz Cable Loss (dB)	Connector Type	Cable Length (mm)
Chain (0)+(1)	WNC	81.EBJ15.005	PIFA	5.47~5.725GHz: 4.76	5.47~5.725GHz: 1.74	IPEX	300
				5.725~5.85GHz: 4.76	5.725~5.85GHz: 1.79		

Above 1GHz Data
802.11a - Channel 36

Conducted spurious emission table

No.	Frequency (MHz)	Emission Level (dBuV/m)	Limit (dBuV/m)	Margin (dB)	Raw Value (dBm)	Correction Factor (dB)	EIRP Level (dBm)
1	3453.125 PK	51.74	74	-22.26	-46.6	3.08	-43.52
2	3453.125 AV	35.2	54	-18.8	-63.14	3.08	-60.06
3	6906.25 PK	52.65	74	-21.35	-45.69	3.08	-42.61
4	6906.25 AV	46.17	54	-7.83	-52.17	3.08	-49.09
5	10362.5 PK	53.05	74	-20.95	-45.29	3.08	-42.21
6	10359.375 AV	34.55	54	-19.45	-63.79	3.08	-60.71
7	15549.875 PK	51.77	74	-22.23	-46.57	3.08	-43.49
8	15541.25 AV	40.66	54	-13.34	-57.68	3.08	-54.6

Note :

Emission Level (dBuV/m) = EIRP Level (dBm) – 20log(d) + 104.8

d = measurement distance in 3 meters.

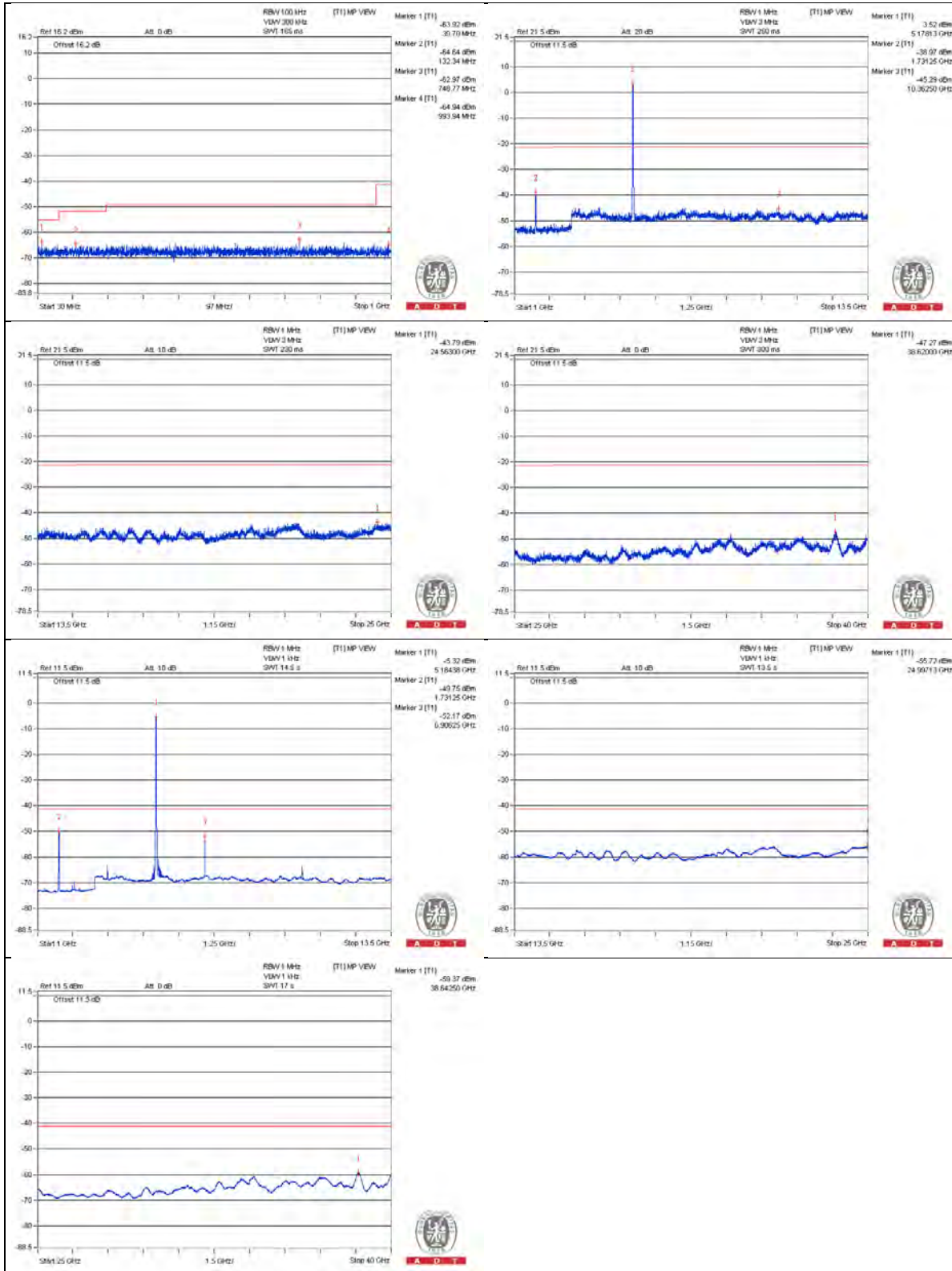

Bandedge table

No.	Frequency (MHz)	Emission Level (dBuV/m)	Limit (dBuV/m)	Margin (dB)	Raw Value (dBm)	Correction Factor (dB)	EIRP Level (dBm)
1	5149.6 PK	53.89	74	-20.11	-44.45	3.08	-41.37
2	5150 AV	41.12	54	-12.88	-57.22	3.08	-54.14

Note :
Emission Level (dBuV/m) = EIRP Level (dBm) – 20log(d) + 104.8
d = measurement distance in 3 meters.

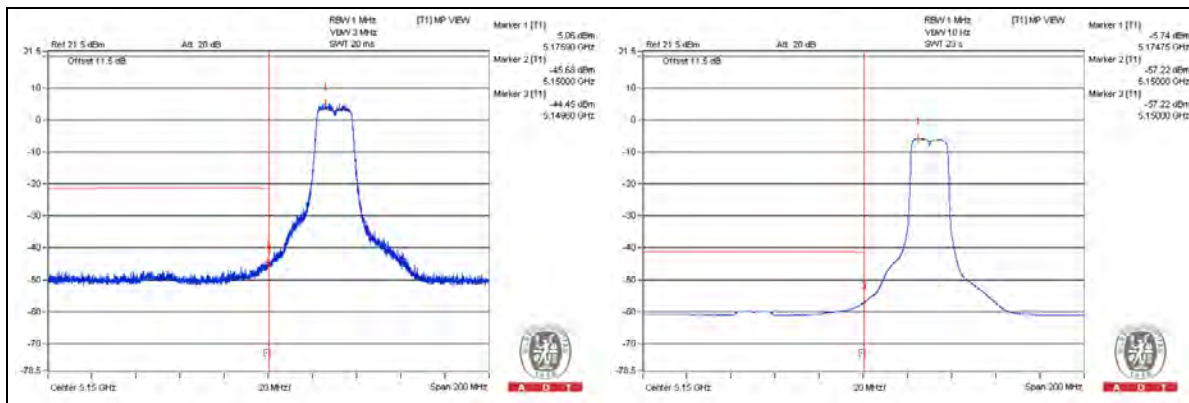

802.11a - Channel 40
Conducted spurious emission table

No.	Frequency (MHz)	Emission Level (dBuV/m)	Limit (dBuV/m)	Margin (dB)	Raw Value (dBm)	Correction Factor (dB)	EIRP Level (dBm)
1	3475 PK	50.76	74	-23.24	-47.58	3.08	-44.5
2	3465.625 AV	33.59	54	-20.41	-64.75	3.08	-61.67
3	6928.125 PK	51.76	74	-22.24	-46.58	3.08	-43.5
4	6934.375 AV	44.98	54	-9.02	-53.36	3.08	-50.28
5	10390.625 PK	52.66	74	-21.34	-45.68	3.08	-42.6
6	10400 AV	32.67	54	-21.33	-65.67	3.08	-62.59
7	15595.875 PK	51.26	74	-22.74	-47.08	3.08	-44
8	15595.875 AV	40.41	54	-13.59	-57.93	3.08	-54.85

Note :

Emission Level (dBuV/m) = EIRP Level (dBm) – 20log(d) + 104.8

d = measurement distance in 3 meters.

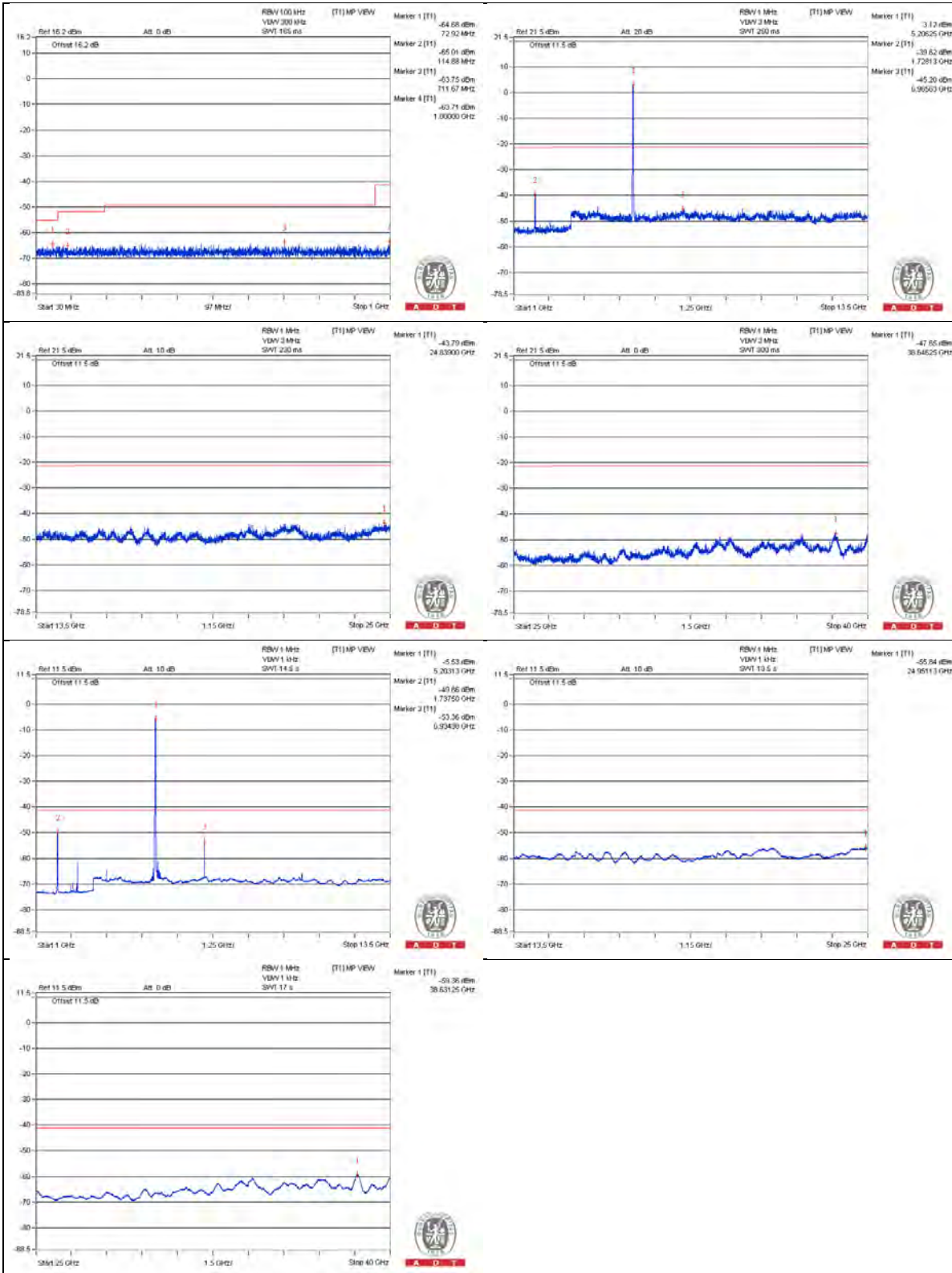

Bandedge table

No.	Frequency (MHz)	Emission Level (dBuV/m)	Limit (dBuV/m)	Margin (dB)	Raw Value (dBm)	Correction Factor (dB)	EIRP Level (dBm)
1	5122.15 PK	51.75	74	-22.25	-46.59	3.08	-43.51
2	5125.2 AV	38.58	54	-15.42	-59.76	3.08	-56.68

Note :

$$\text{Emission Level (dBuV/m)} = \text{EIRP Level (dBm)} - 20\log(d) + 104.8$$

d = measurement distance in 3 meters.

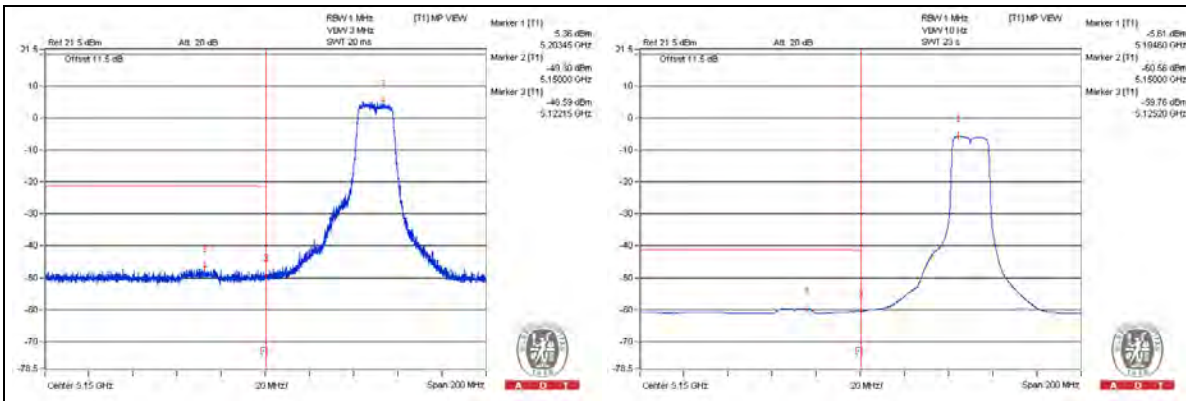

802.11a - Channel 48
Conducted spurious emission table

No.	Frequency (MHz)	Emission Level (dBuV/m)	Limit (dBuV/m)	Margin (dB)	Raw Value (dBm)	Correction Factor (dB)	EIRP Level (dBm)
1	3496.875 PK	50.56	74	-23.44	-47.78	3.08	-44.7
2	3493.75 AV	31.08	54	-22.92	-67.26	3.08	-64.18
3	6978.125 PK	52.81	74	-21.19	-45.53	3.08	-42.45
4	6987.5 AV	42.66	54	-11.34	-55.68	3.08	-52.6
5	10471.875 PK	50.87	74	-23.13	-47.47	3.08	-44.39
6	10478.125 AV	31.12	54	-22.88	-67.22	3.08	-64.14
7	15719.5 PK	49.77	74	-24.23	-48.57	3.08	-45.49
8	15713.75 AV	39.13	54	-14.87	-59.21	3.08	-56.13

Note :

Emission Level (dBuV/m) = EIRP Level (dBm) – 20log(d) + 104.8

d = measurement distance in 3 meters.

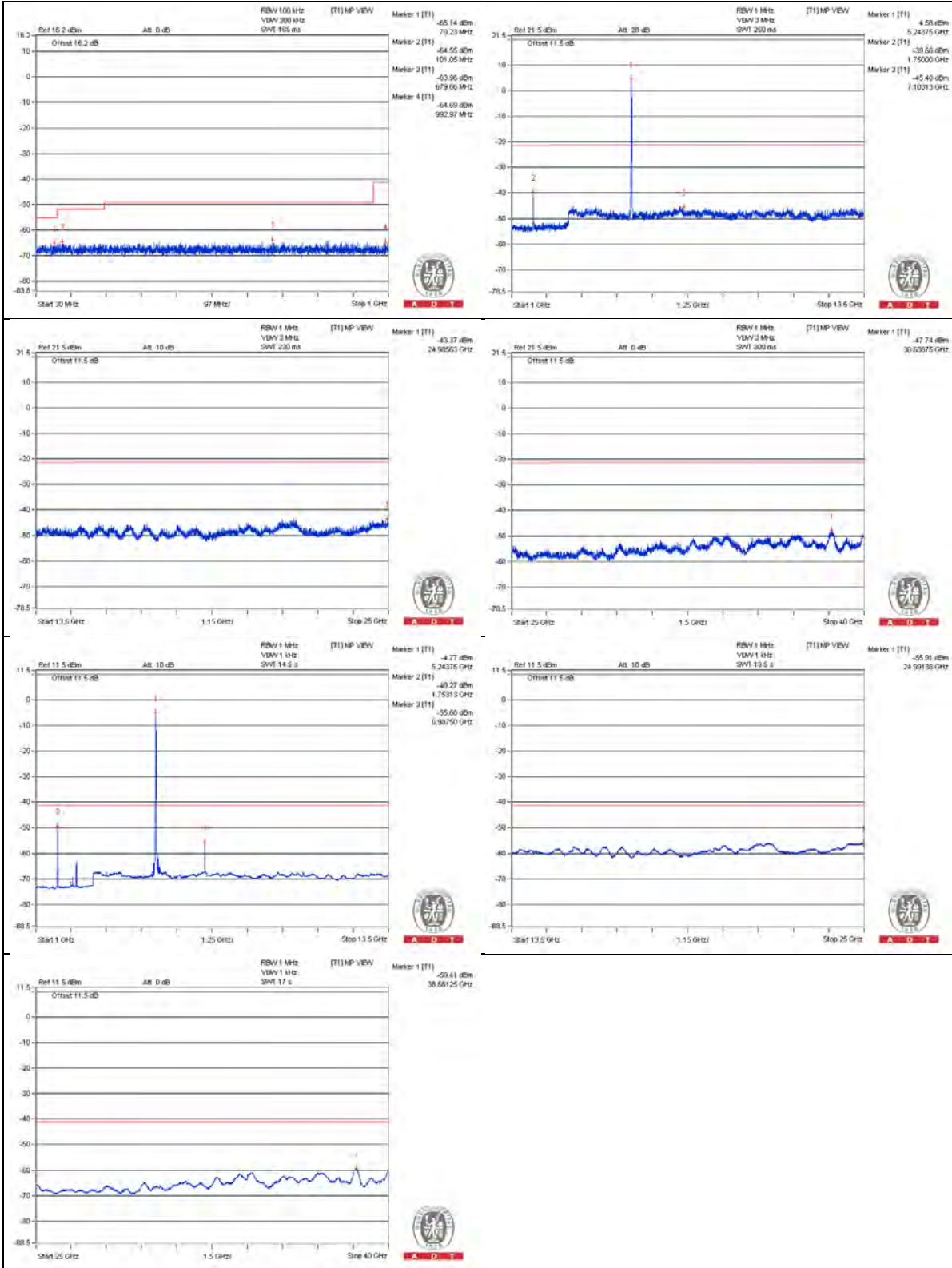

Bandedge table

No.	Frequency (MHz)	Emission Level (dBuV/m)	Limit (dBuV/m)	Margin (dB)	Raw Value (dBm)	Correction Factor (dB)	EIRP Level (dBm)
1	5131 PK	50.97	74	-23.03	-47.37	3.08	-44.29
2	5076.05 AV	37.54	54	-16.46	-60.8	3.08	-57.72

Note :

Emission Level (dBuV/m) = EIRP Level (dBm) – 20log(d) + 104.8

d = measurement distance in 3 meters.

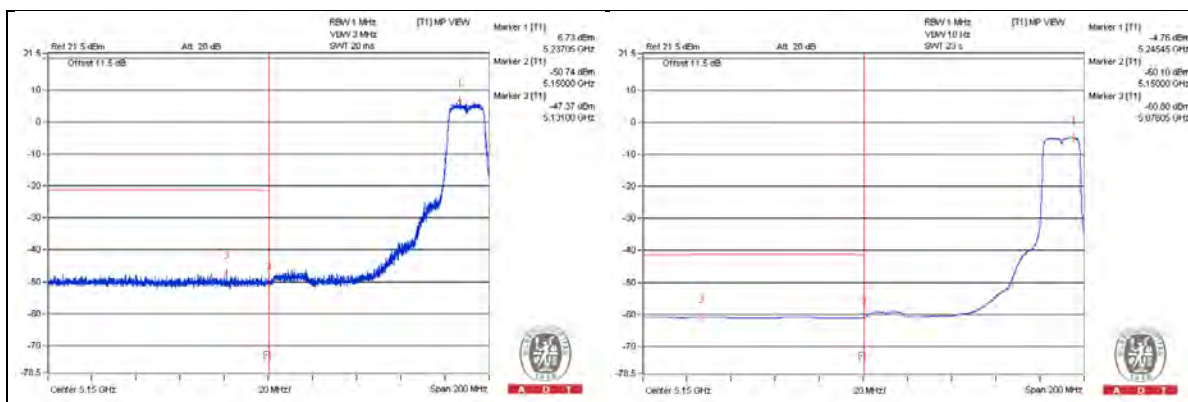

802.11a - Channel 52**Conducted spurious emission table**

No.	Frequency (MHz)	Emission Level (dBuV/m)	Limit (dBuV/m)	Margin (dB)	Raw Value (dBm)	Correction Factor (dB)	EIRP Level (dBm)
1	3503.125 PK	50.75	74	-23.25	-47.59	3.08	-44.51
2	3506.25 AV	31.34	54	-22.66	-67	3.08	-63.92
3	7015.625 PK	52.14	74	-21.86	-46.2	3.08	-43.12
4	7012.5 AV	41.69	54	-12.31	-56.65	3.08	-53.57
5	10525 PK	51.33	74	-22.67	-47.01	3.08	-43.93
6	10521.875 AV	32.04	54	-21.96	-66.3	3.08	-63.22
7	15779.875 PK	49.53	74	-24.47	-48.81	3.08	-45.73
8	15779.875 AV	38.67	54	-15.33	-59.67	3.08	-56.59

Note :

Emission Level (dBuV/m) = EIRP Level (dBm) – 20log(d) + 104.8

d = measurement distance in 3 meters.

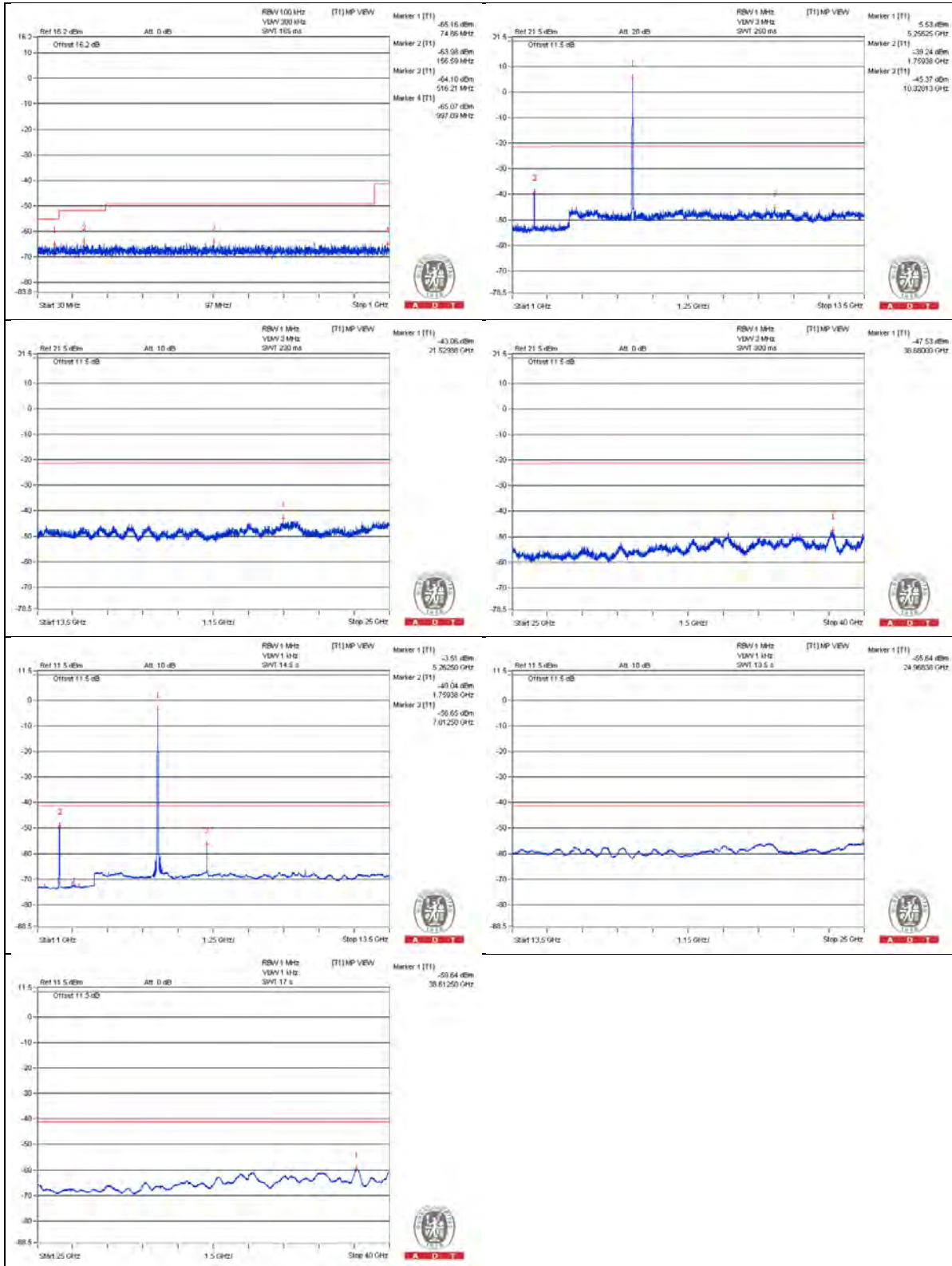

Bandedge table

No.	Frequency (MHz)	Emission Level (dBUV/m)	Limit (dBUV/m)	Margin (dB)	Raw Value (dBm)	Correction Factor (dB)	EIRP Level (dBm)
1	5107.7 PK	51.39	74	-22.61	-46.95	3.08	-43.87
2	5051.7 AV	37.5	54	-16.5	-60.84	3.08	-57.76

Note :
 Emission Level (dBUV/m) = EIRP Level (dBm) – 20log(d) + 104.8
 d = measurement distance in 3 meters.

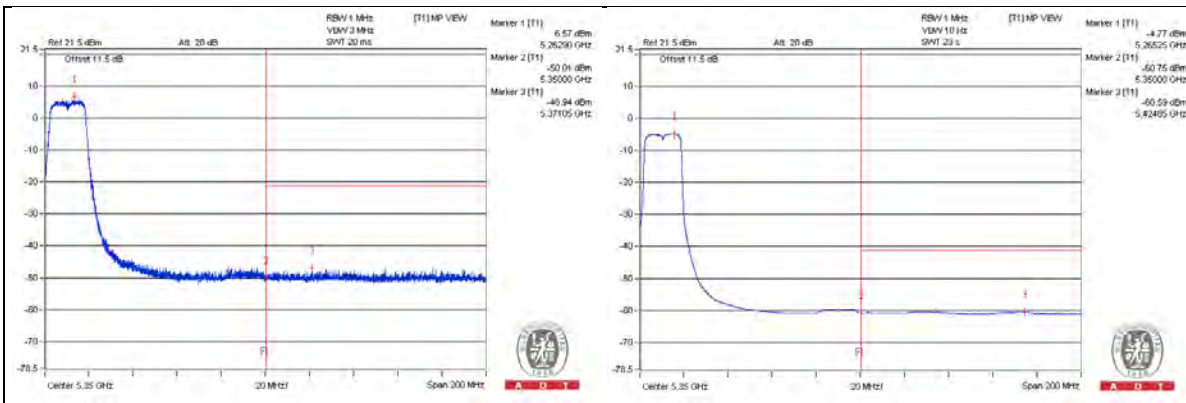

802.11a - Channel 60**Conducted spurious emission table**

No.	Frequency (MHz)	Emission Level (dBuV/m)	Limit (dBuV/m)	Margin (dB)	Raw Value (dBm)	Correction Factor (dB)	EIRP Level (dBm)
1	3537.5 PK	52.16	74	-21.84	-46.18	3.08	-43.1
2	3531.25 AV	30.3	54	-23.7	-68.04	3.08	-64.96
3	7059.375 PK	52.11	74	-21.89	-46.23	3.08	-43.15
4	7065.625 AV	36.22	54	-17.78	-62.12	3.08	-59.04
5	10609.375 PK	51.03	74	-22.97	-47.31	3.08	-44.23
6	10600 AV	30.99	54	-23.01	-67.35	3.08	-64.27
7	15903.5 PK	50.15	74	-23.85	-48.19	3.08	-45.11
8	15903.5 AV	39.43	54	-14.57	-58.91	3.08	-55.83

Note :

Emission Level (dBuV/m) = EIRP Level (dBm) – 20log(d) + 104.8

d = measurement distance in 3 meters.

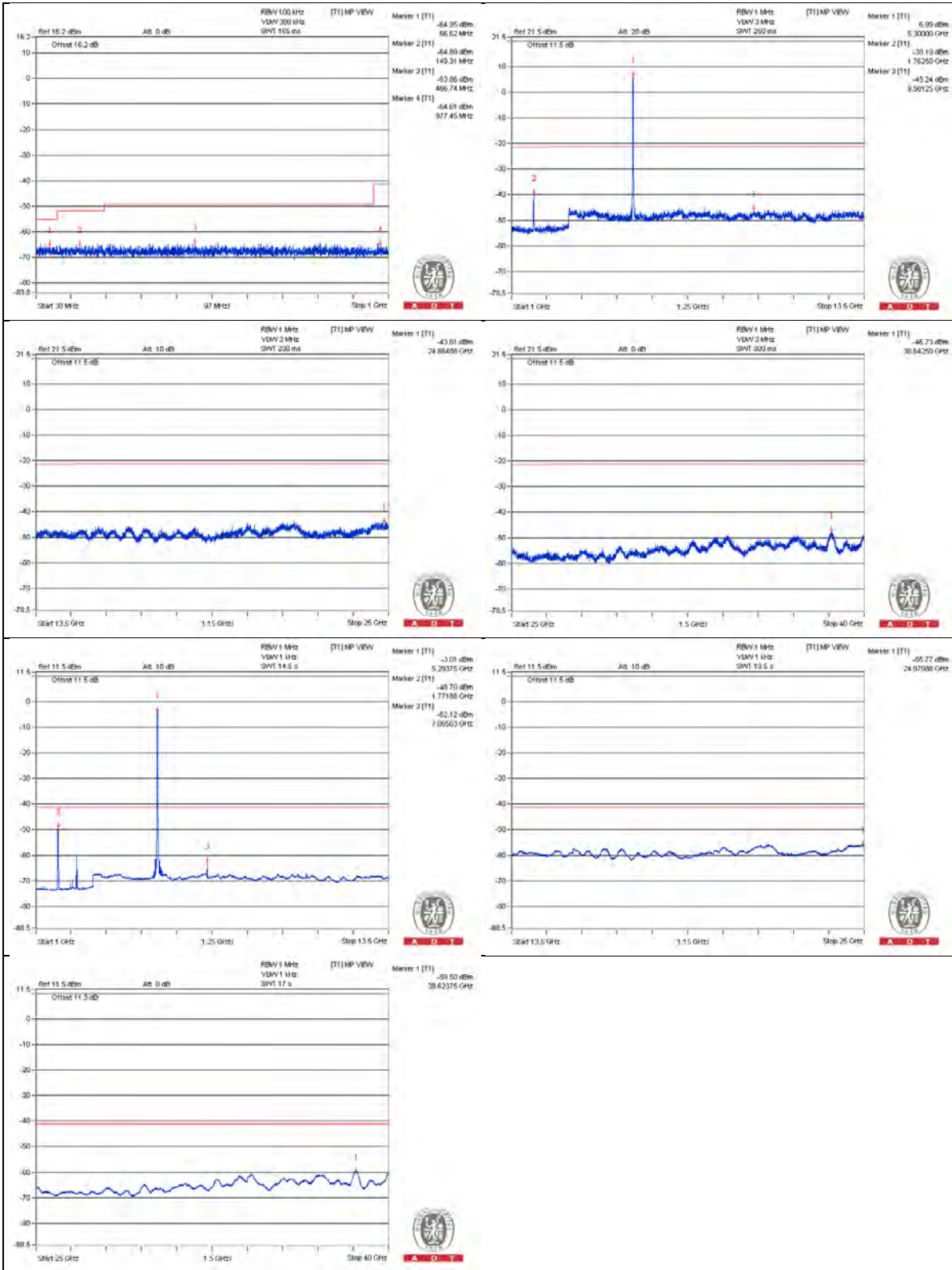

Bandedge table

No.	Frequency (MHz)	Emission Level (dBuV/m)	Limit (dBuV/m)	Margin (dB)	Raw Value (dBm)	Correction Factor (dB)	EIRP Level (dBm)
1	5384.3 PK	51.77	74	-22.23	-46.57	3.08	-43.49
2	5377.85 AV	38.6	54	-15.4	-59.74	3.08	-56.66

Note :
 Emission Level (dBuV/m) = EIRP Level (dBm) – 20log(d) + 104.8
 d = measurement distance in 3 meters.

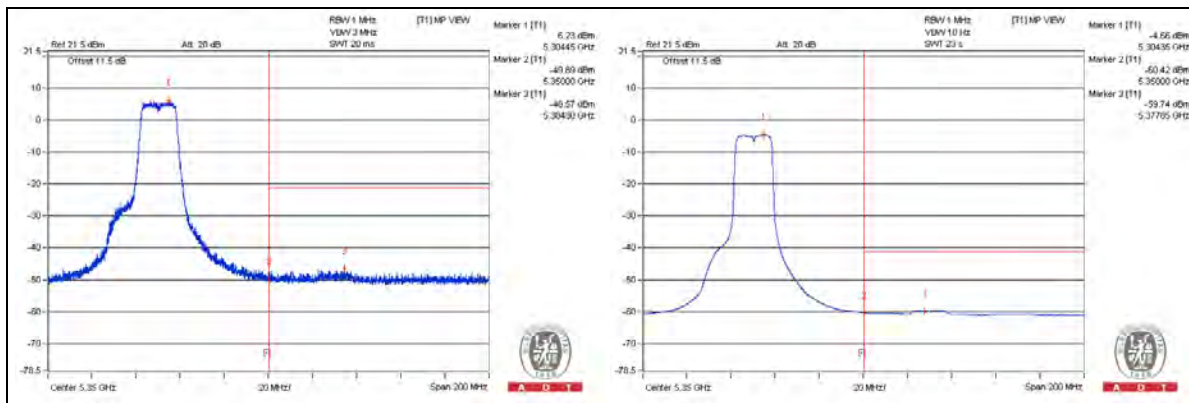

802.11a - Channel 64
Conducted spurious emission table

No.	Frequency (MHz)	Emission Level (dBuV/m)	Limit (dBuV/m)	Margin (dB)	Raw Value (dBm)	Correction Factor (dB)	EIRP Level (dBm)
1	3540.625 PK	50.04	74	-23.96	-48.3	3.08	-45.22
2	3546.875 AV	30.46	54	-23.54	-67.88	3.08	-64.8
3	7090.625 PK	50.28	74	-23.72	-48.06	3.08	-44.98
4	7093.75 AV	34.22	54	-19.78	-64.12	3.08	-61.04
5	10646.875 PK	51.09	74	-22.91	-47.25	3.08	-44.17
6	10640.625 AV	31.29	54	-22.71	-67.05	3.08	-63.97
7	15966.75 PK	51.09	74	-22.91	-47.25	3.08	-44.17
8	15955.25 AV	40.01	54	-13.99	-58.33	3.08	-55.25

Note :

Emission Level (dBuV/m) = EIRP Level (dBm) – 20log(d) + 104.8

d = measurement distance in 3 meters.

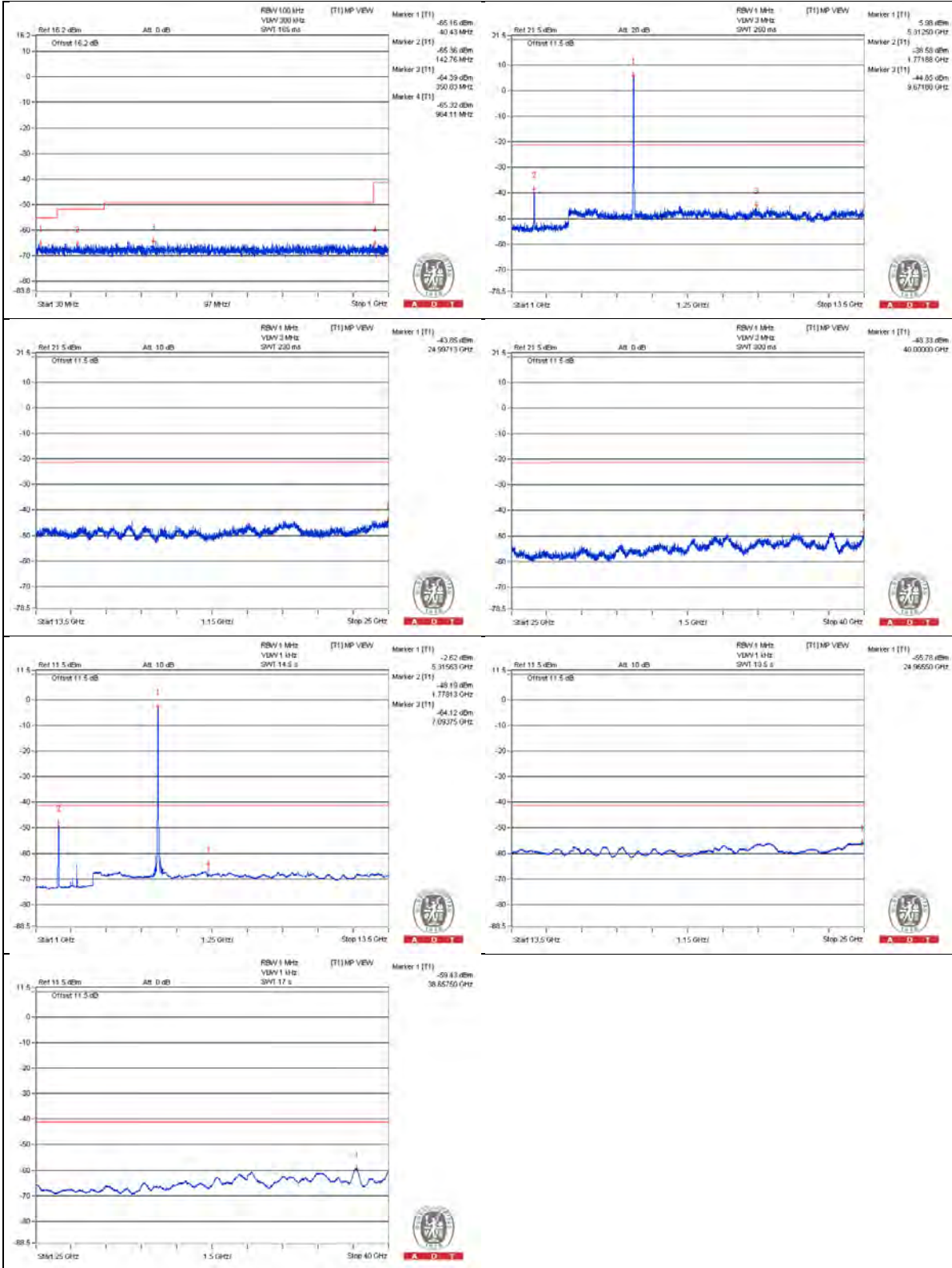

Bandedge table

No.	Frequency (MHz)	Emission Level (dBuV/m)	Limit (dBuV/m)	Margin (dB)	Raw Value (dBm)	Correction Factor (dB)	EIRP Level (dBm)
1	5352.6 PK	54.3	74	-19.7	-44.04	3.08	-40.96
2	5350 AV	41.05	54	-12.95	-57.29	3.08	-54.21

Note :

$$\text{Emission Level (dBuV/m)} = \text{EIRP Level (dBm)} - 20\log(d) + 104.8$$

d = measurement distance in 3 meters.

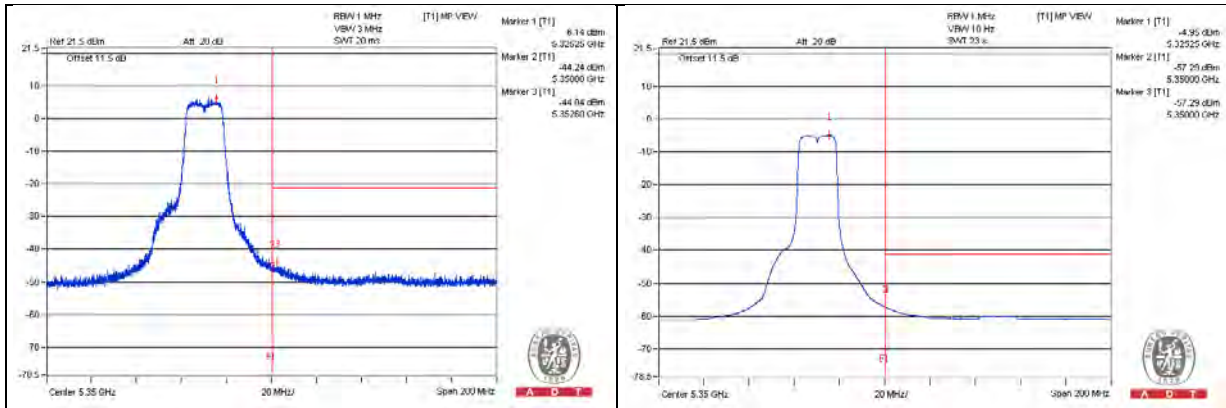

802.11a - Channel 100
Conducted spurious emission table

No.	Frequency (MHz)	Emission Level (dBuV/m)	Limit (dBuV/m)	Margin (dB)	Raw Value (dBm)	Correction Factor (dB)	EIRP Level (dBm)
1	3665.625 PK	52.24	74	-21.76	-47.78	4.76	-43.02
2	3665.625 AV	32.54	54	-21.46	-67.48	4.76	-62.72
3	7334.375 PK	53.07	74	-20.93	-46.95	4.76	-42.19
4	7334.375 AV	32.11	54	-21.89	-67.91	4.76	-63.15
5	10996.875 PK	51.91	74	-22.09	-48.11	4.76	-43.35
6	11000 AV	34.61	54	-19.39	-65.41	4.76	-60.65
7	16507.25 PK	53.77	74	-20.23	-46.25	4.76	-41.49
8	16492.875 AV	42.55	54	-11.45	-57.47	4.76	-52.71

Note :

Emission Level (dBuV/m) = EIRP Level (dBm) – 20log(d) + 104.8
d = measurement distance in 3 meters.

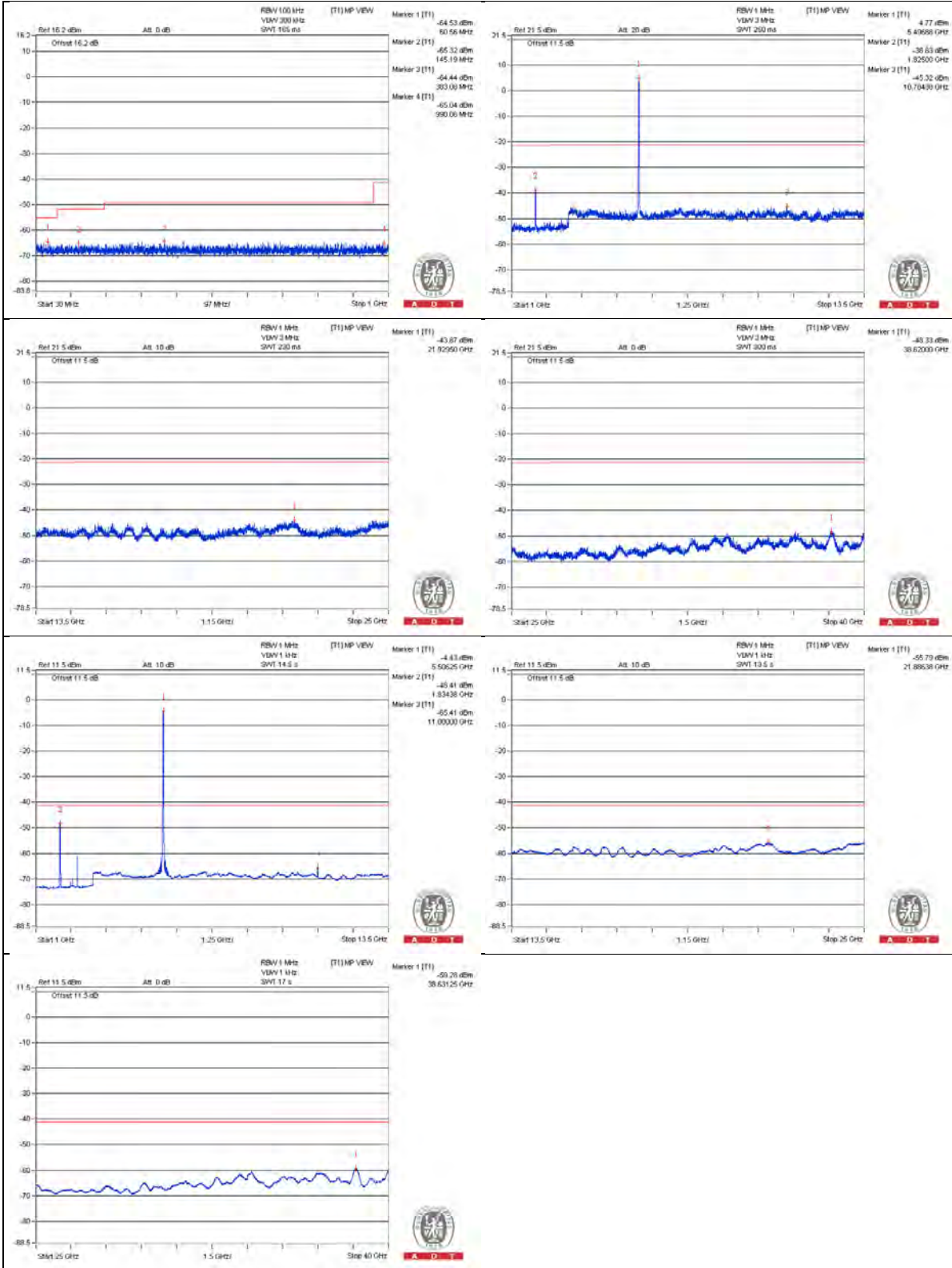

Bandedge table

No.	Frequency (MHz)	Emission Level (dBuV/m)	Limit (dBuV/m)	Margin (dB)	Raw Value (dBm)	Correction Factor (dB)	EIRP Level (dBm)
1	5469.56 PK	53.82	74	-20.18	-46.2	4.76	-41.44
2	5470 AV	41.42	54	-12.58	-58.6	4.76	-53.84

Note :

$$\text{Emission Level (dBuV/m)} = \text{EIRP Level (dBm)} - 20\log(d) + 104.8$$

d = measurement distance in 3 meters.

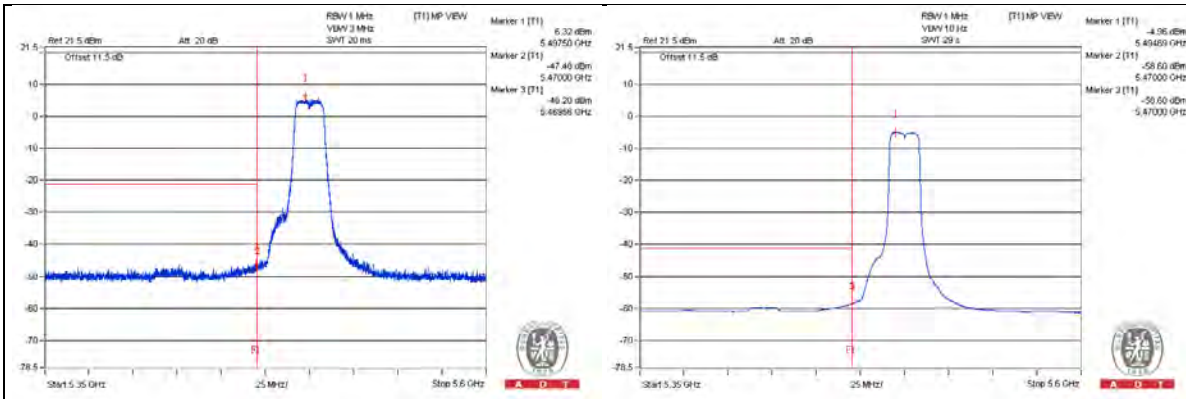

802.11a - Channel 120
Conducted spurious emission table

No.	Frequency (MHz)	Emission Level (dBuV/m)	Limit (dBuV/m)	Margin (dB)	Raw Value (dBm)	Correction Factor (dB)	EIRP Level (dBm)
1	3740.625 PK	53.17	74	-20.83	-46.85	4.76	-42.09
2	3731.25 AV	32.69	54	-21.31	-67.33	4.76	-62.57
3	7462.5 PK	53.79	74	-20.21	-46.23	4.76	-41.47
4	7465.625 AV	33.23	54	-20.77	-66.79	4.76	-62.03
5	11200 PK	51.63	74	-22.37	-48.39	4.76	-43.63
6	11200 AV	32.82	54	-21.18	-67.2	4.76	-62.44
7	16800.5 PK	52.12	74	-21.88	-47.9	4.76	-43.14
8	16800.5 AV	40.82	54	-13.18	-59.2	4.76	-54.44

Note :

Emission Level (dBuV/m) = EIRP Level (dBm) – 20log(d) + 104.8

d = measurement distance in 3 meters.

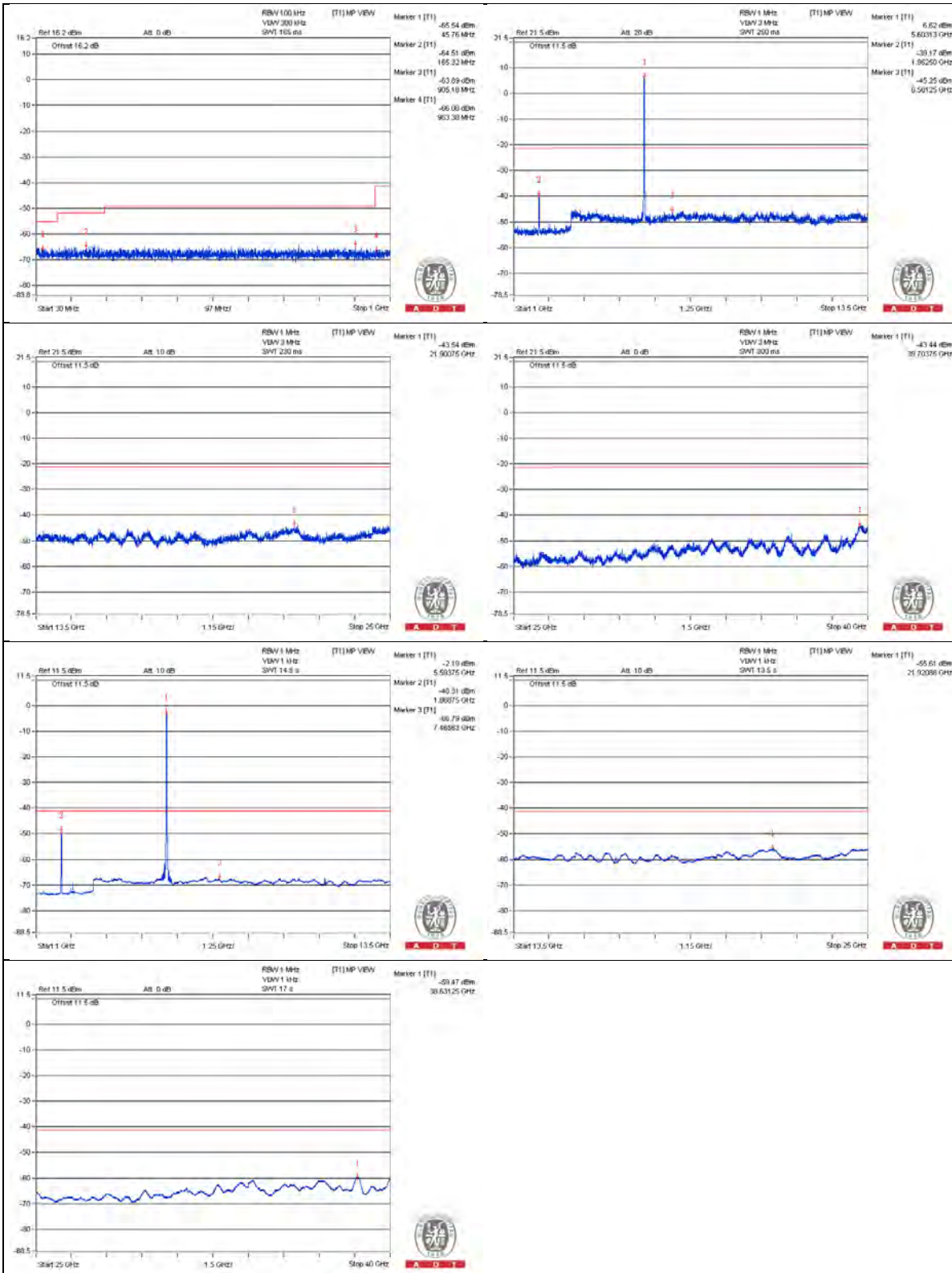

Bandedge table

No.	Frequency (MHz)	Emission Level (dBUV/m)	Limit (dBUV/m)	Margin (dB)	Raw Value (dBm)	Correction Factor (dB)	EIRP Level (dBm)
1	5379.37 PK	52.61	74	-21.39	-47.41	4.76	-42.65
2	5354.69 AV	39.31	54	-14.69	-60.71	4.76	-55.95

Note :

Emission Level (dBUV/m) = EIRP Level (dBm) – 20log(d) + 104.8

d = measurement distance in 3 meters.

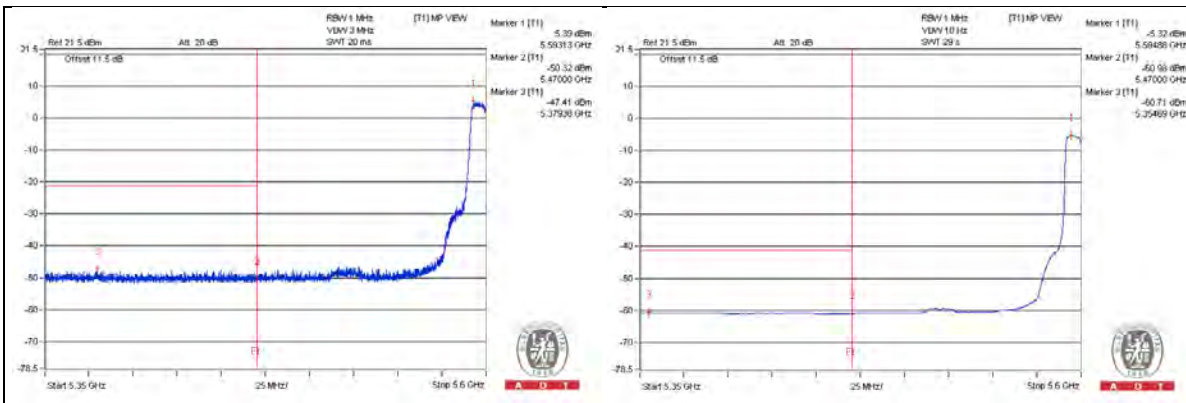

802.11a - Channel 140

Conducted spurious emission table

No.	Frequency (MHz)	Emission Level (dBuV/m)	Limit (dBuV/m)	Margin (dB)	Raw Value (dBm)	Correction Factor (dB)	EIRP Level (dBm)
1	3796.875 PK	53.21	74	-20.79	-46.81	4.76	-42.05
2	3800 AV	32.47	54	-21.53	-67.55	4.76	-62.79
3	7596.875 PK	52.66	74	-21.34	-47.36	4.76	-42.6
4	7600 AV	33	54	-21	-67.02	4.76	-62.26
5	11396.875 PK	52.68	74	-21.32	-47.34	4.76	-42.58
6	11400 AV	34.11	54	-19.89	-65.91	4.76	-61.15
7	17096.625 PK	55.44	74	-18.56	-44.58	4.76	-39.82
8	17099.5 AV	43.21	54	-10.79	-56.81	4.76	-52.05

Note :

Emission Level (dBuV/m) = EIRP Level (dBm) – 20log(d) + 104.8

d = measurement distance in 3 meters.

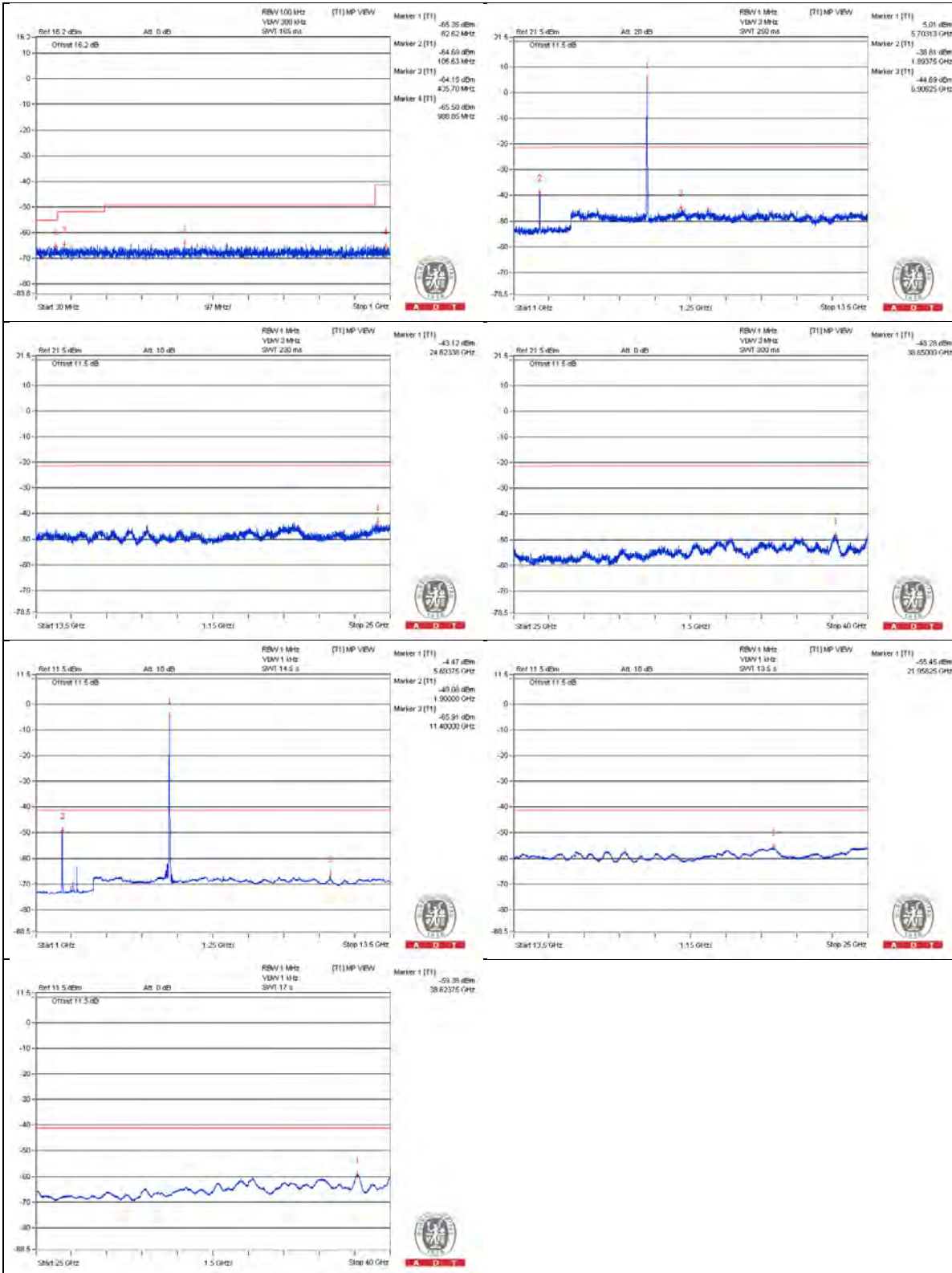

Bandedge table

No.	Frequency (MHz)	Emission Level (dBuV/m)	Limit (dBuV/m)	Margin (dB)	Raw Value (dBm)	Correction Factor (dB)	EIRP Level (dBm)
1	5725.1 PK	55.49	74	-18.51	-44.53	4.76	-39.77
2	5725.05 AV	43.13	54	-10.87	-56.89	4.76	-52.13

Note :

$$\text{Emission Level (dBuV/m)} = \text{EIRP Level (dBm)} - 20\log(d) + 104.8$$

d = measurement distance in 3 meters.

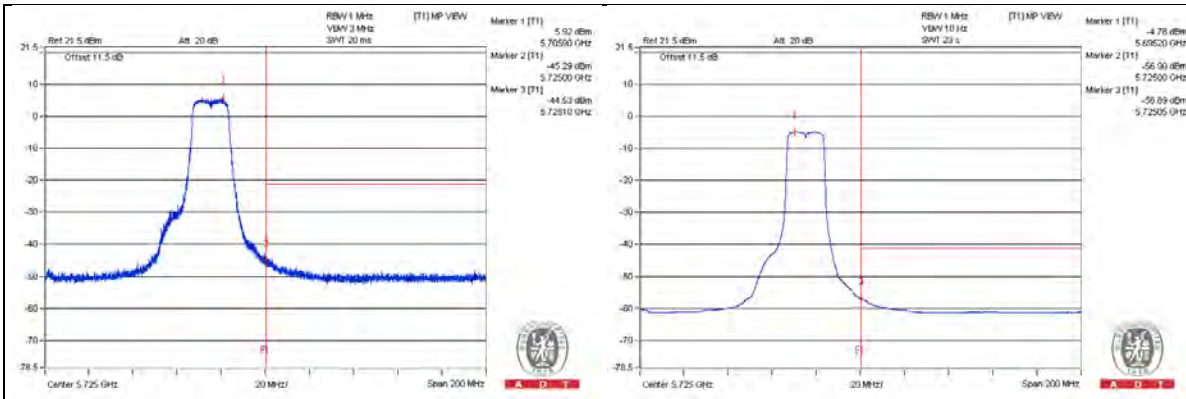

802.11a - Channel 144
Conducted spurious emission table

No.	Frequency (MHz)	Emission Level (dBuV/m)	Limit (dBuV/m)	Margin (dB)	Raw Value (dBm)	Correction Factor (dB)	EIRP Level (dBm)
1	3821.875 PK	54.14	74	-19.86	-45.88	4.76	-41.12
2	3809.375 AV	32.36	54	-21.64	-67.66	4.76	-62.9
3	7634.375 PK	54.23	74	-19.77	-45.79	4.76	-41.03
4	7628.125 AV	32.79	54	-21.21	-67.23	4.76	-62.47
5	11431.25 PK	52.01	74	-21.99	-48.01	4.76	-43.25
6	11437.5 AV	34.54	54	-19.46	-65.48	4.76	-60.72
7	17168.5 PK	54.63	74	-19.37	-45.39	4.76	-40.63
8	17159.875 AV	42.67	54	-11.33	-57.35	4.76	-52.59

Note :

Emission Level (dBuV/m) = EIRP Level (dBm) – 20log(d) + 104.8

d = measurement distance in 3 meters.

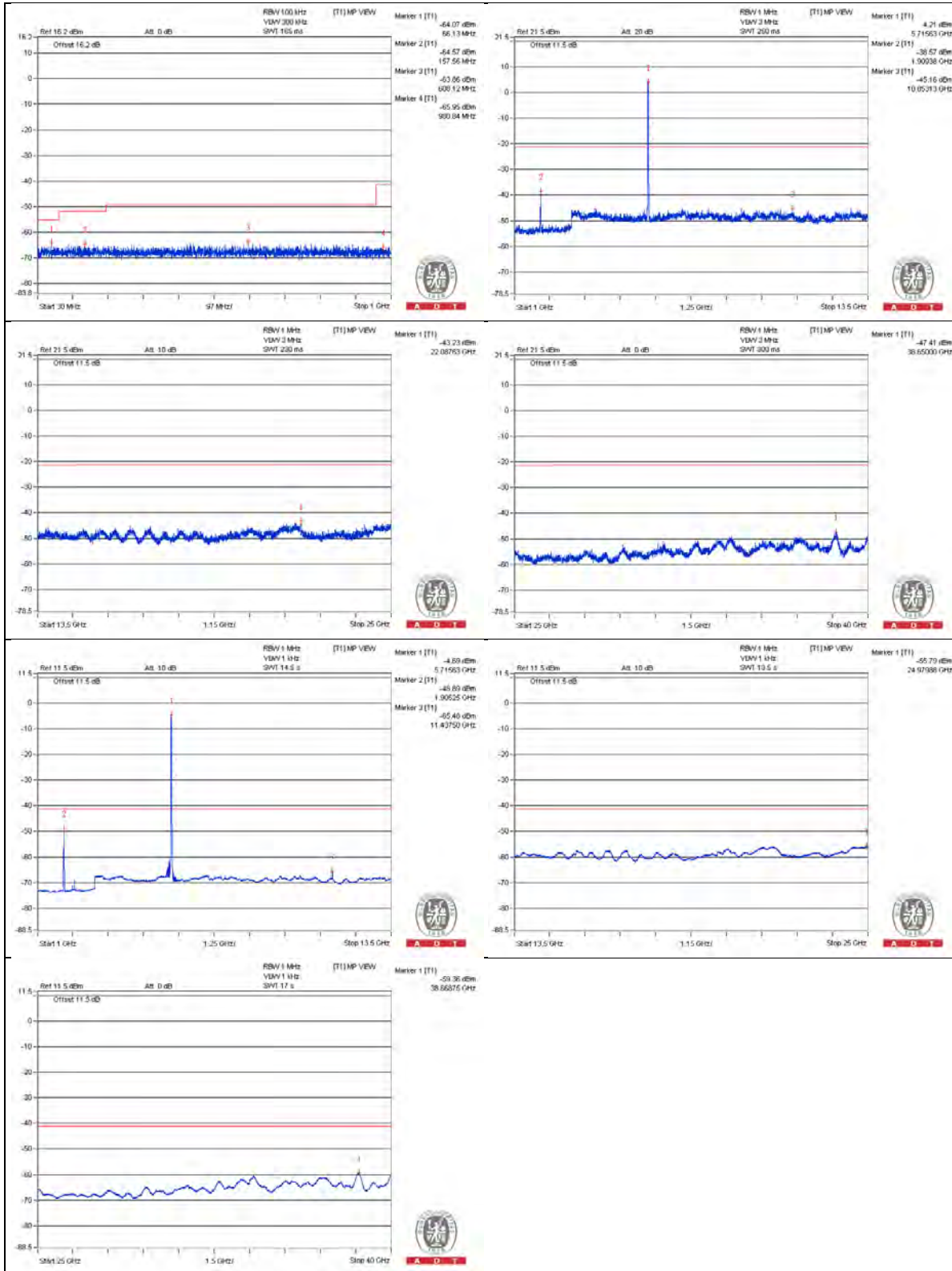

Bandedge table

No.	Frequency (MHz)	Emission Level (dBuV/m)	Limit (dBuV/m)	Margin (dB)	Raw Value (dBm)	Correction Factor (dB)	EIRP Level (dBm)
1	5892.32 PK	51.55	74	-22.45	-48.47	4.76	-43.71
2	5875.07 AV	39	54	-15	-61.02	4.76	-56.26

Note :

$$\text{Emission Level (dBuV/m)} = \text{EIRP Level (dBm)} - 20\log(d) + 104.8$$

d = measurement distance in 3 meters.

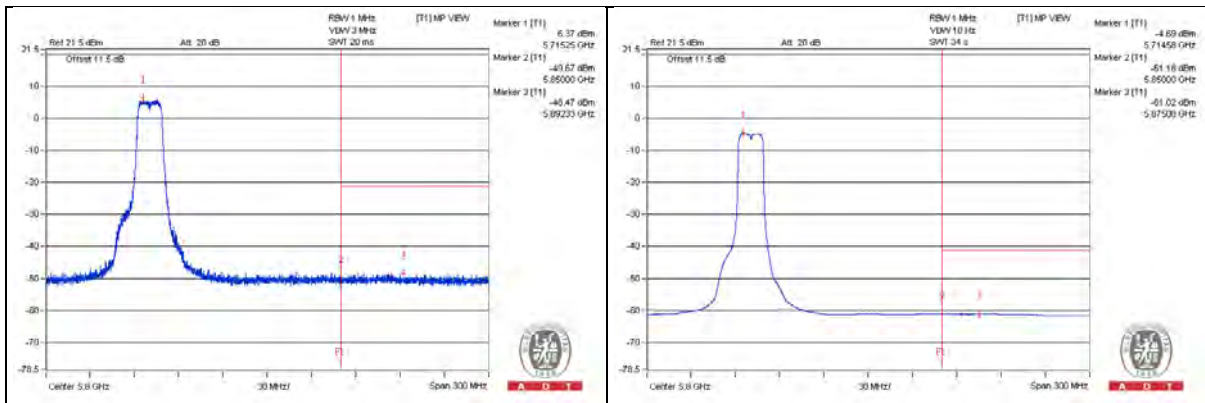

802.11a - Channel 149
Conducted spurious emission table

No.	Frequency (MHz)	Emission Level (dBuV/m)	Limit (dBuV/m)	Margin (dB)	Raw Value (dBm)	Correction Factor (dB)	EIRP Level (dBm)
1	3825 PK	52.97	74	-21.03	-47.05	4.76	-42.29
2	3831.25 AV	32.36	54	-21.64	-67.66	4.76	-62.9
3	7650 PK	53.89	74	-20.11	-46.13	4.76	-41.37
4	7659.375 AV	31.92	54	-22.08	-68.1	4.76	-63.34
5	11484.375 PK	53.16	74	-20.84	-46.86	4.76	-42.1
6	11490.625 AV	34.11	54	-19.89	-65.91	4.76	-61.15
7	17226 PK	53.07	74	-20.93	-46.95	4.76	-42.19
8	17228.875 AV	41.68	54	-12.32	-58.34	4.76	-53.58

Note :

Emission Level (dBuV/m) = EIRP Level (dBm) – 20log(d) + 104.8
d = measurement distance in 3 meters.

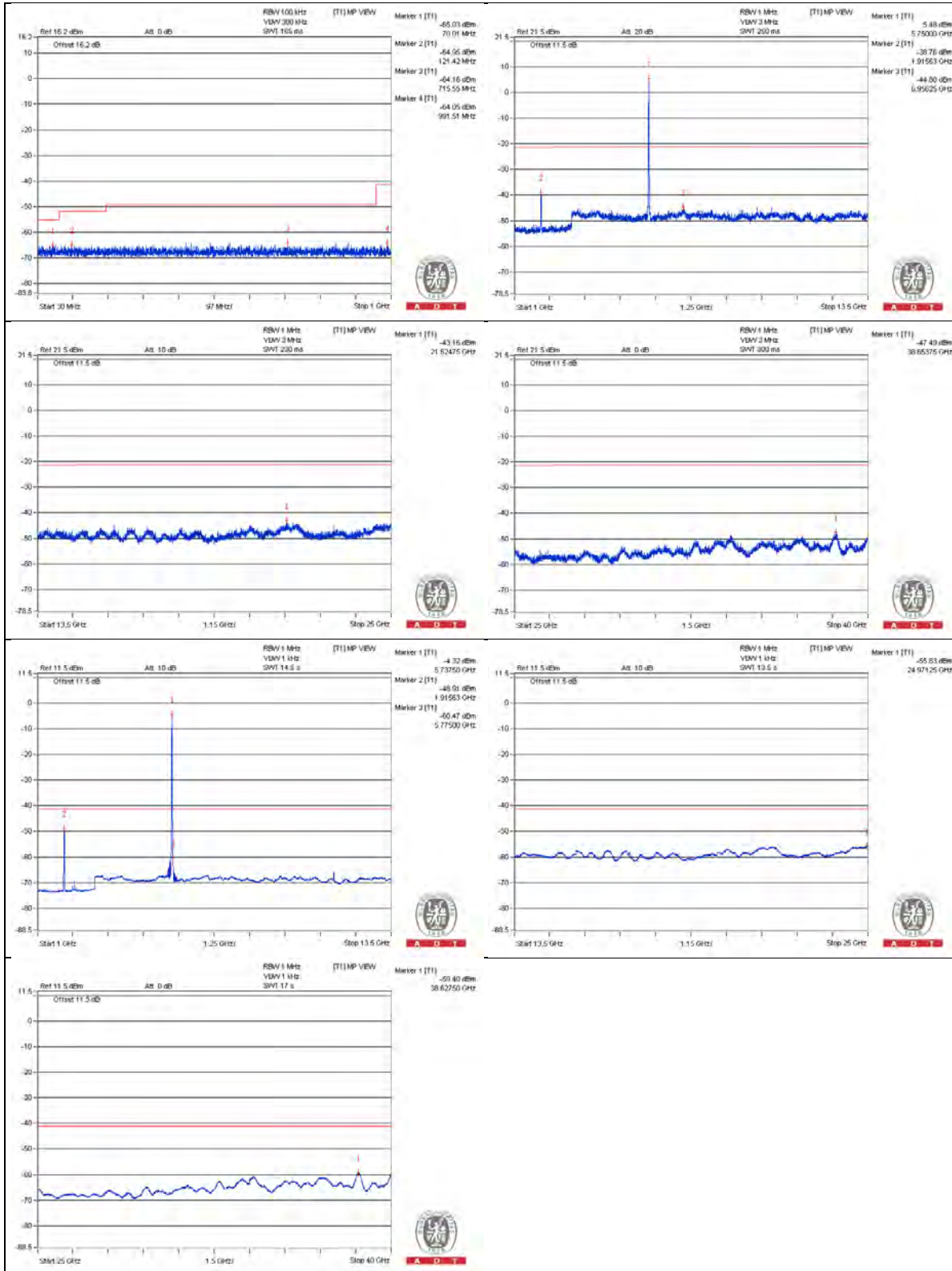

Bandedge table

No.	Frequency (MHz)	Emission Level (dBuV/m)	Limit (dBuV/m)	Margin (dB)	Raw Value (dBm)	Correction Factor (dB)	EIRP Level (dBm)
1	5713.77 PK	53.85	74	-20.15	-46.17	4.76	-41.41
2	5715 AV	41.17	54	-12.83	-58.85	4.76	-54.09
3	5724.65 PK	68.29	78.2	-9.91	-31.73	4.76	-26.97
4	5857.48 PK	51.63	78.2	-26.57	-48.39	4.76	-43.63
5	5937.5 PK	49.57	74	-24.43	-50.45	4.76	-45.69
6	5861.98 AV	39.03	54	-14.97	-60.99	4.76	-56.23

Note :

$$\text{Emission Level (dBuV/m)} = \text{EIRP Level (dBm)} - 20\log(d) + 104.8$$

d = measurement distance in 3 meters.

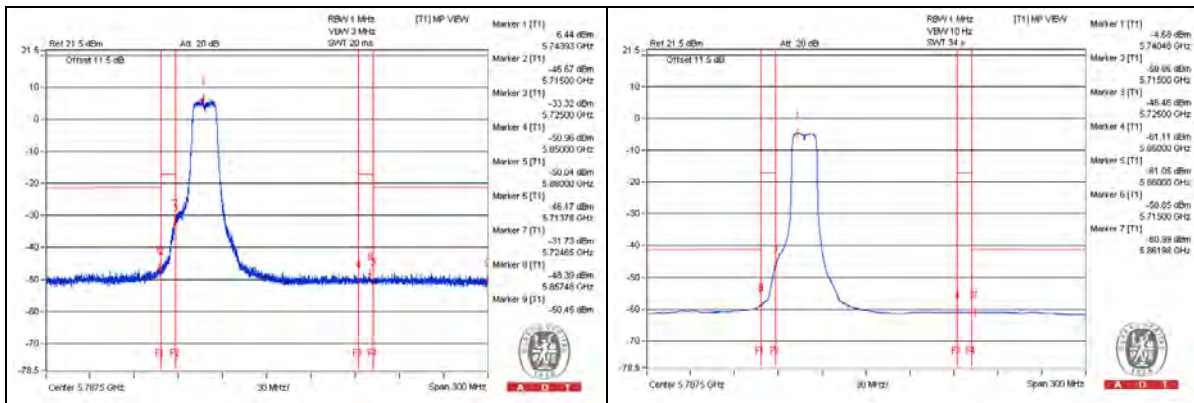

802.11a - Channel 157
Conducted spurious emission table

No.	Frequency (MHz)	Emission Level (dBuV/m)	Limit (dBuV/m)	Margin (dB)	Raw Value (dBm)	Correction Factor (dB)	EIRP Level (dBm)
1	3846.875 PK	53.08	74	-20.92	-46.94	4.76	-42.18
2	3859.375 AV	32.25	54	-21.75	-67.77	4.76	-63.01
3	7718.75 PK	52.63	74	-21.37	-47.39	4.76	-42.63
4	7712.5 AV	32.6	54	-21.4	-67.42	4.76	-62.66
5	11575 PK	51.94	74	-22.06	-48.08	4.76	-43.32
6	11565.625 AV	31.44	54	-22.56	-68.58	4.76	-63.82
7	17355.375 PK	52.73	74	-21.27	-47.29	4.76	-42.53
8	17352.5 AV	41.16	54	-12.84	-58.86	4.76	-54.1

Note :

Emission Level (dBuV/m) = EIRP Level (dBm) – 20log(d) + 104.8

d = measurement distance in 3 meters.

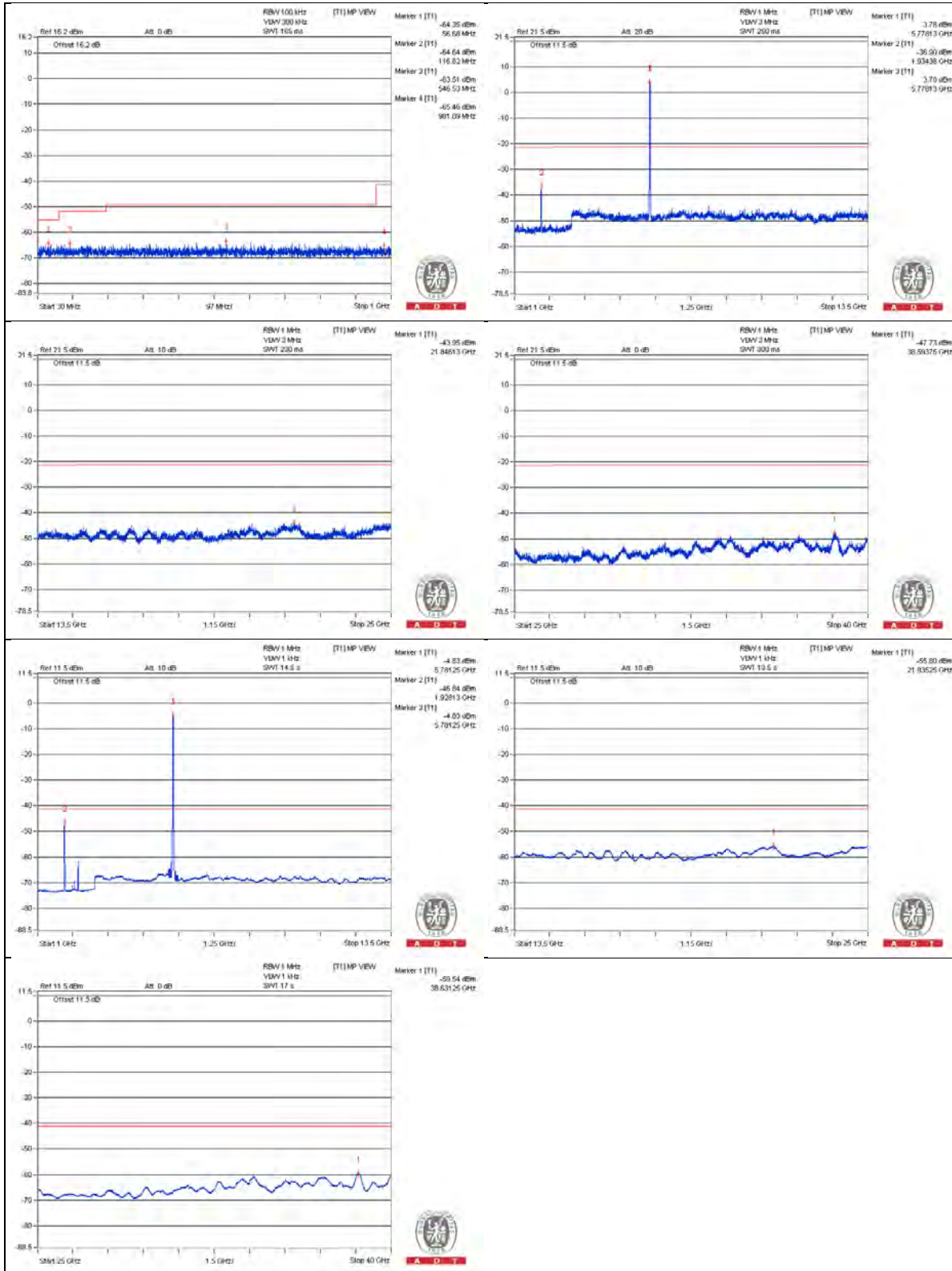

Bandedge table

No.	Frequency (MHz)	Emission Level (dBuV/m)	Limit (dBuV/m)	Margin (dB)	Raw Value (dBm)	Correction Factor (dB)	EIRP Level (dBm)
1	5685.5 PK	52.4	74	-21.6	-47.62	4.76	-42.86
2	5702.9 AV	39.6	54	-14.4	-60.42	4.76	-55.66
3	5720.23 PK	52.38	78.2	-25.82	-47.64	4.76	-42.88
4	5858.37 PK	51.62	78.2	-26.58	-48.4	4.76	-43.64
5	5937.5 PK	50.22	74	-23.78	-49.8	4.76	-45.04
6	5862.95 AV	39.04	54	-14.96	-60.98	4.76	-56.22

Note :

Emission Level (dBuV/m) = EIRP Level (dBm) – 20log(d) + 104.8

d = measurement distance in 3 meters.

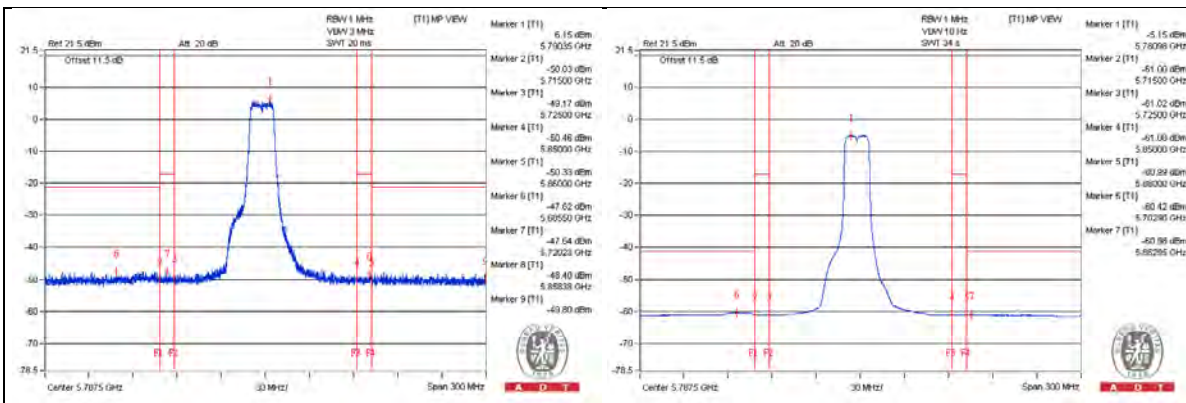

802.11a - Channel 165
Conducted spurious emission table

No.	Frequency (MHz)	Emission Level (dBuV/m)	Limit (dBuV/m)	Margin (dB)	Raw Value (dBm)	Correction Factor (dB)	EIRP Level (dBm)
1	3884.375 PK	53.07	74	-20.93	-46.95	4.76	-42.19
2	3887.5 AV	32.62	54	-21.38	-67.4	4.76	-62.64
3	7762.5 PK	53.3	74	-20.7	-46.72	4.76	-41.96
4	7765.625 AV	31.93	54	-22.07	-68.09	4.76	-63.33
5	11640.625 PK	50.77	74	-23.23	-49.25	4.76	-44.49
6	11650 AV	30.21	54	-23.79	-69.81	4.76	-65.05
7	17470.375 PK	51.9	74	-22.1	-48.12	4.76	-43.36
8	17470.375 AV	40.65	54	-13.35	-59.37	4.76	-54.61

Note :

Emission Level (dBuV/m) = EIRP Level (dBm) – 20log(d) + 104.8

d = measurement distance in 3 meters.

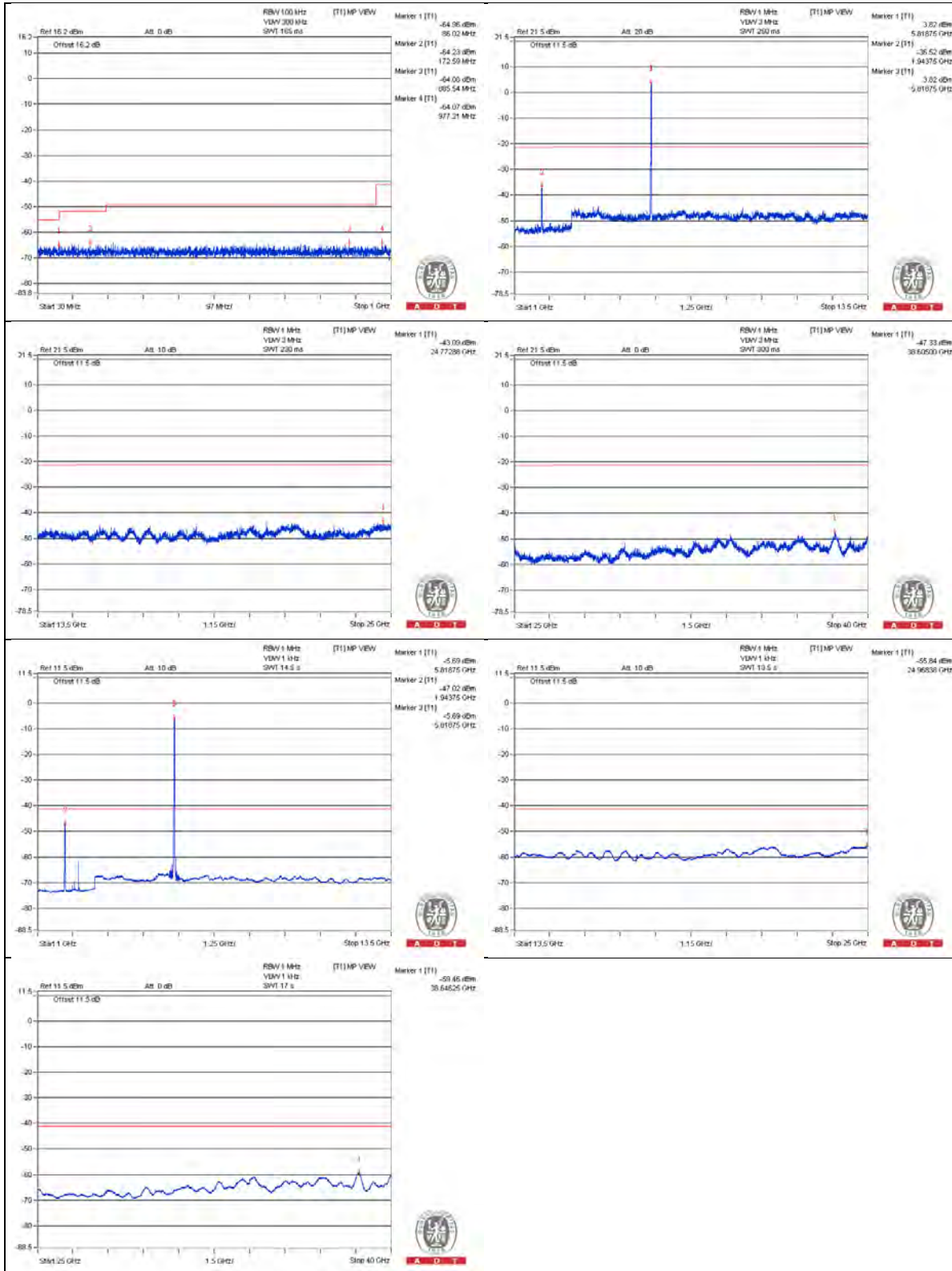

Bandedge table

No.	Frequency (MHz)	Emission Level (dBuV/m)	Limit (dBuV/m)	Margin (dB)	Raw Value (dBm)	Correction Factor (dB)	EIRP Level (dBm)
1	5714 PK	51.89	74	-22.11	-48.13	4.76	-43.37
2	5699.07 AV	39.14	54	-14.86	-60.88	4.76	-56.12
3	5715.5 PK	51.57	78.2	-26.63	-48.45	4.76	-43.69
4	5850.65 PK	55.38	78.2	-22.82	-44.64	4.76	-39.88
5	5937.5 PK	49.38	74	-24.62	-50.64	4.76	-45.88
6	5860 AV	40.2	54	-13.8	-59.82	4.76	-55.06

Note :

$$\text{Emission Level (dBuV/m)} = \text{EIRP Level (dBm)} - 20\log(d) + 104.8$$

d = measurement distance in 3 meters.

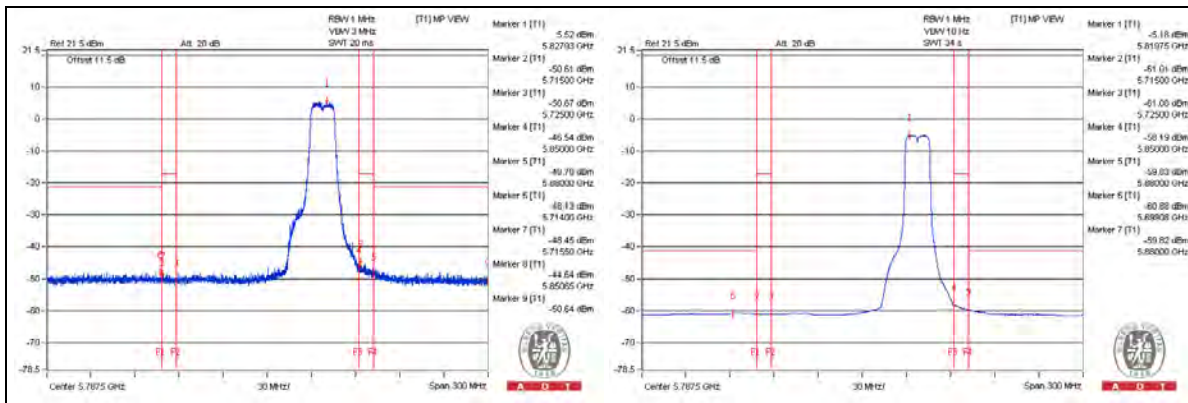

802.11n (HT20) - Channel 36**Conducted spurious emission table**

No.	Frequency (MHz)	Emission Level (dBuV/m)	Limit (dBuV/m)	Margin (dB)	Raw Value (dBm)	Correction Factor (dB)	EIRP Level (dBm)
1	3462.5 PK	51.01	74	-22.99	-47.33	3.08	-44.25
2	3453.125 AV	35.15	54	-18.85	-63.19	3.08	-60.11
3	6915.625 PK	52.68	74	-21.32	-45.66	3.08	-42.58
4	6906.25 AV	46.64	54	-7.36	-51.7	3.08	-48.62
5	10350 PK	51.42	74	-22.58	-46.92	3.08	-43.84
6	10359.375 AV	34.26	54	-19.74	-64.08	3.08	-61
7	15538.375 PK	51.84	74	-22.16	-46.5	3.08	-43.42
8	15538.375 AV	40.64	54	-13.36	-57.7	3.08	-54.62

Note :

Emission Level (dBuV/m) = EIRP Level (dBm) – 20log(d) + 104.8

d = measurement distance in 3 meters.

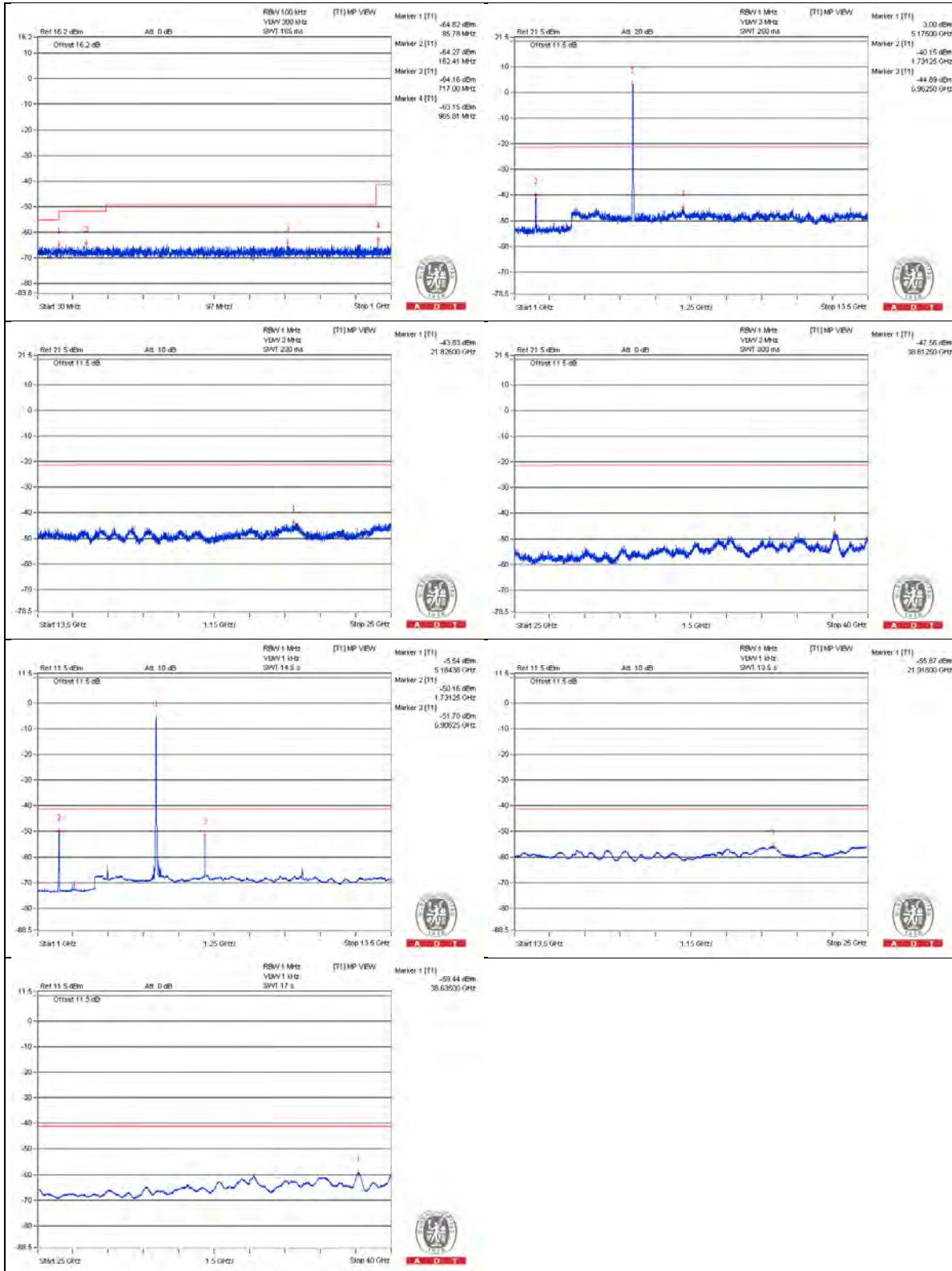

Bandedge table

No.	Frequency (MHz)	Emission Level (dBUV/m)	Limit (dBUV/m)	Margin (dB)	Raw Value (dBm)	Correction Factor (dB)	EIRP Level (dBm)
1	5149.5 PK	56.65	74	-17.35	-41.69	3.08	-38.61
2	5150 AV	42.02	54	-11.98	-56.32	3.08	-53.24

Note :

$$\text{Emission Level (dBUV/m)} = \text{EIRP Level (dBm)} - 20\log(d) + 104.8$$

d = measurement distance in 3 meters.

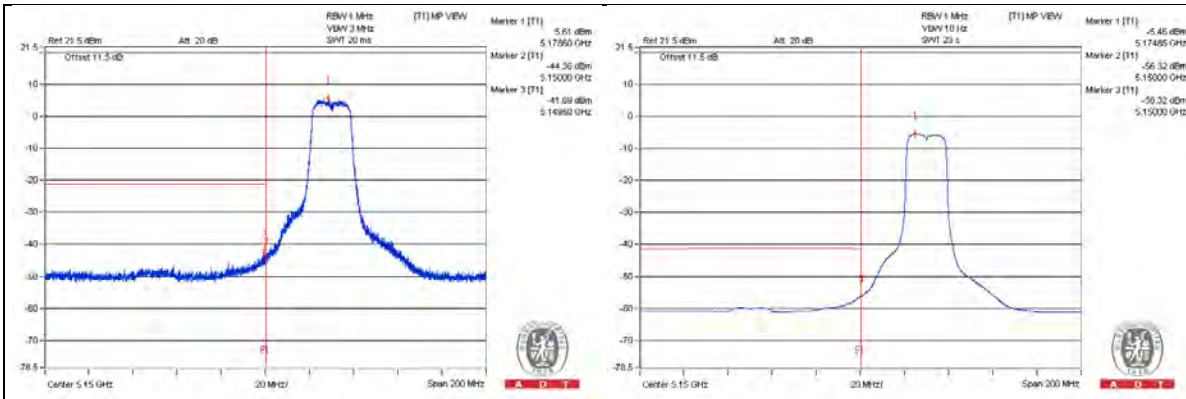

802.11n (HT20) - Channel 40
Conducted spurious emission table

No.	Frequency (MHz)	Emission Level (dBuV/m)	Limit (dBuV/m)	Margin (dB)	Raw Value (dBm)	Correction Factor (dB)	EIRP Level (dBm)
1	3471.875 PK	50.21	74	-23.79	-48.13	3.08	-45.05
2	3465.625 AV	33.78	54	-20.22	-64.56	3.08	-61.48
3	6934.375 PK	52.47	74	-21.53	-45.87	3.08	-42.79
4	6934.375 AV	45.88	54	-8.12	-52.46	3.08	-49.38
5	10396.875 PK	50.8	74	-23.2	-47.54	3.08	-44.46
6	10400 AV	33.3	54	-20.7	-65.04	3.08	-61.96
7	15595.875 PK	51.63	74	-22.37	-46.71	3.08	-43.63
8	15595.875 AV	40.57	54	-13.43	-57.77	3.08	-54.69

Note :

Emission Level (dBuV/m) = EIRP Level (dBm) – 20log(d) + 104.8

d = measurement distance in 3 meters.

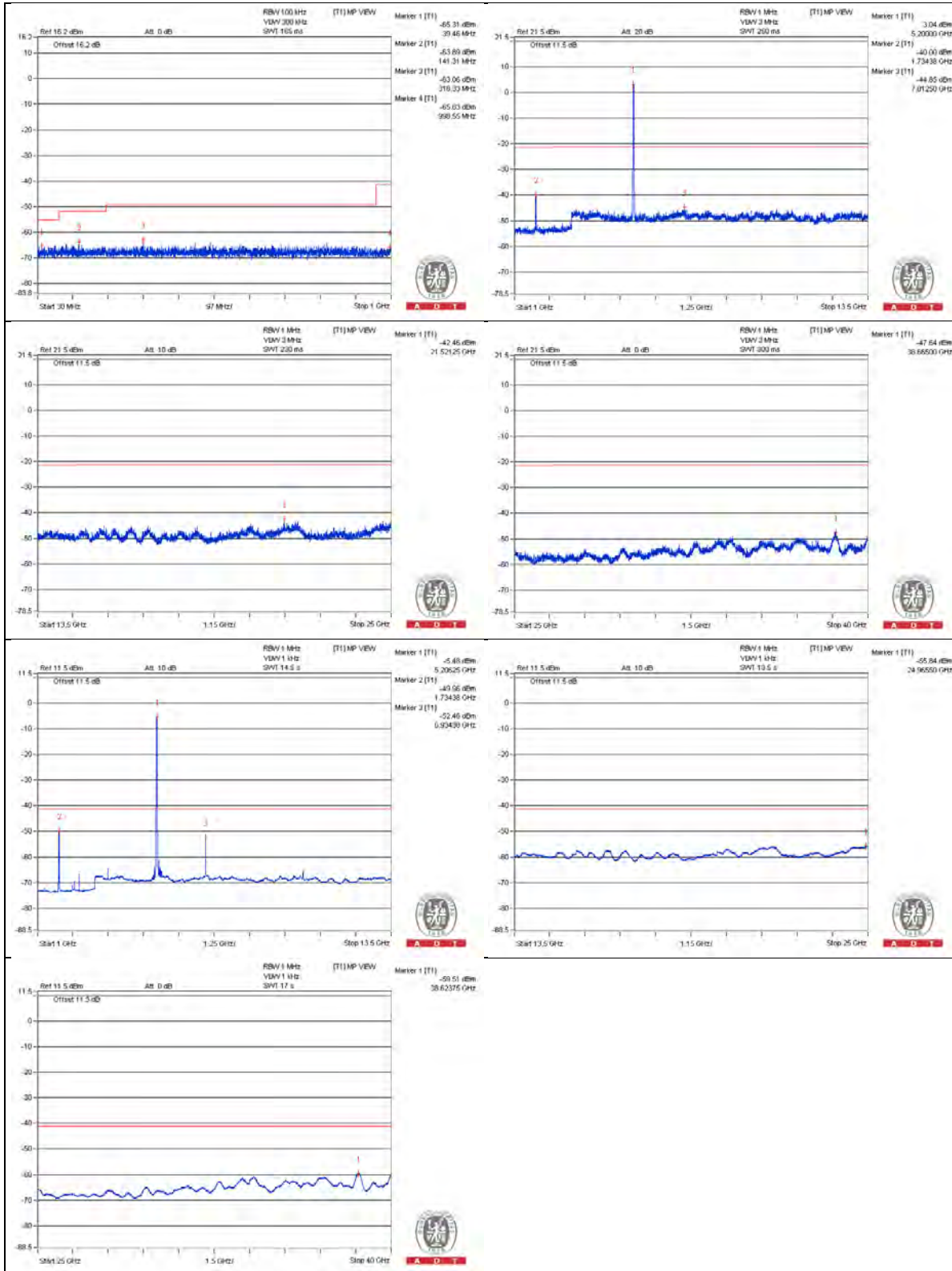

Bandedge table

No.	Frequency (MHz)	Emission Level (dBuV/m)	Limit (dBuV/m)	Margin (dB)	Raw Value (dBm)	Correction Factor (dB)	EIRP Level (dBm)
1	5117 PK	51.74	74	-22.26	-46.6	3.08	-43.52
2	5123.25 AV	38.55	54	-15.45	-59.79	3.08	-56.71

Note :
 Emission Level (dBuV/m) = EIRP Level (dBm) – 20log(d) + 104.8
 d = measurement distance in 3 meters.

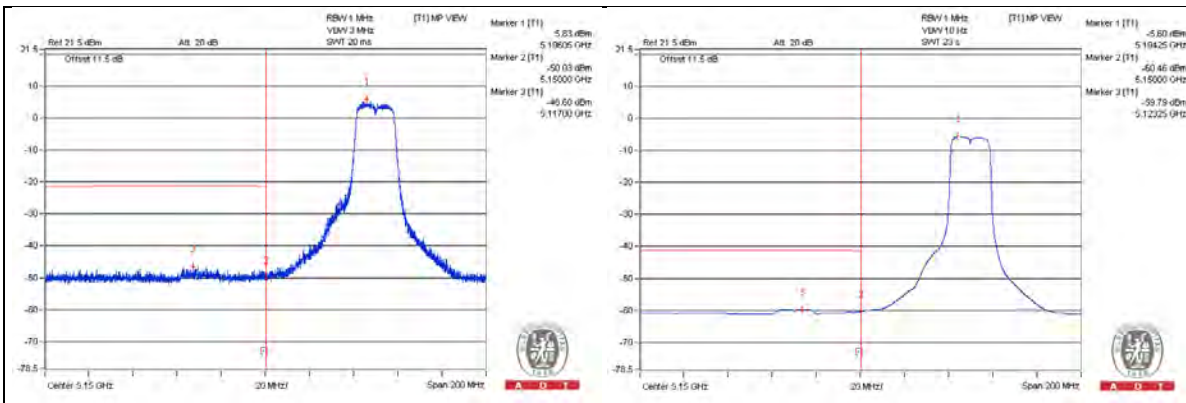

802.11n (HT20) - Channel 48

Conducted spurious emission table

No.	Frequency (MHz)	Emission Level (dBuV/m)	Limit (dBuV/m)	Margin (dB)	Raw Value (dBm)	Correction Factor (dB)	EIRP Level (dBm)
1	3490.625 PK	50.42	74	-23.58	-47.92	3.08	-44.84
2	3493.75 AV	32.01	54	-21.99	-66.33	3.08	-63.25
3	6981.25 PK	52.45	74	-21.55	-45.89	3.08	-42.81
4	6987.5 AV	43.18	54	-10.82	-55.16	3.08	-52.08
5	10487.5 PK	51.02	74	-22.98	-47.32	3.08	-44.24
6	10484.375 AV	32.05	54	-21.95	-66.29	3.08	-63.21
7	15710.875 PK	49.36	74	-24.64	-48.98	3.08	-45.9
8	15710.875 AV	39.07	54	-14.93	-59.27	3.08	-56.19

Note :

Emission Level (dBuV/m) = EIRP Level (dBm) – 20log(d) + 104.8

d = measurement distance in 3 meters.

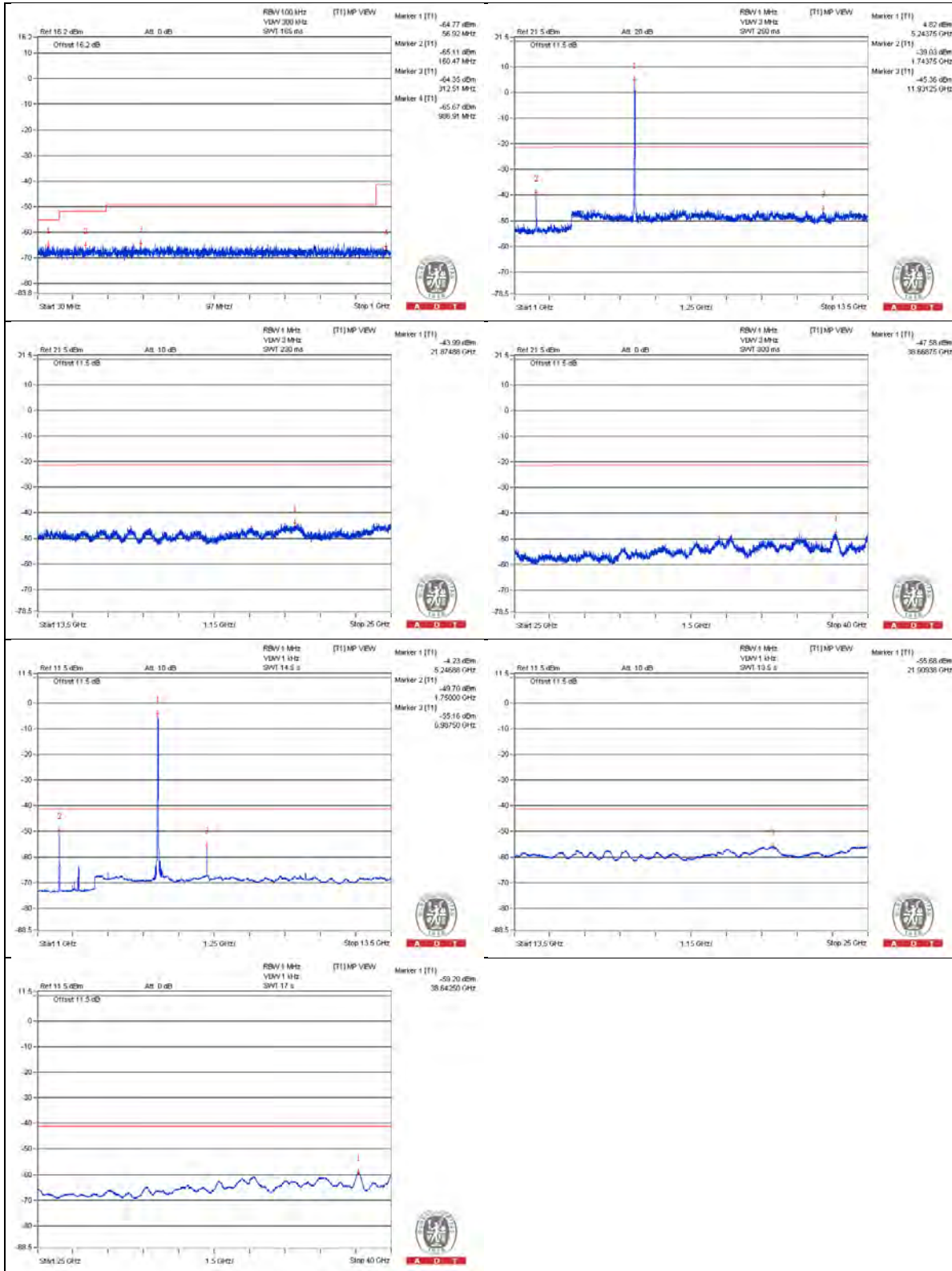

Bandedge table

No.	Frequency (MHz)	Emission Level (dBuV/m)	Limit (dBuV/m)	Margin (dB)	Raw Value (dBm)	Correction Factor (dB)	EIRP Level (dBm)
1	5064.7 PK	51.11	74	-22.89	-47.23	3.08	-44.15
2	5075.65 AV	37.55	54	-16.45	-60.79	3.08	-57.71

Note :
Emission Level (dBuV/m) = EIRP Level (dBm) – 20log(d) + 104.8
d = measurement distance in 3 meters.

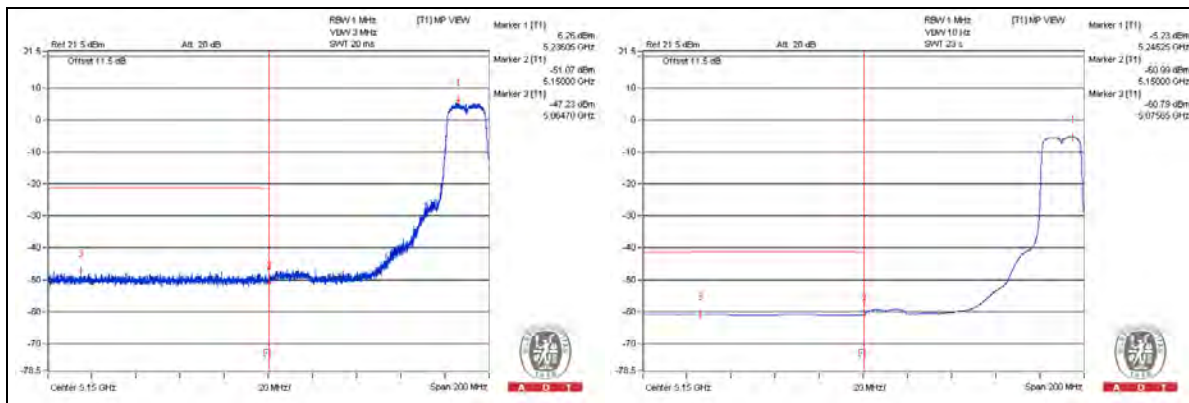

802.11n (HT20) - Channel 52
Conducted spurious emission table

No.	Frequency (MHz)	Emission Level (dBuV/m)	Limit (dBuV/m)	Margin (dB)	Raw Value (dBm)	Correction Factor (dB)	EIRP Level (dBm)
1	3506.25 PK	49.73	74	-24.27	-48.61	3.08	-45.53
2	3506.25 AV	31	54	-23	-67.34	3.08	-64.26
3	7021.875 PK	51.33	74	-22.67	-47.01	3.08	-43.93
4	7012.5 AV	41.2	54	-12.8	-57.14	3.08	-54.06
5	10525 PK	50.53	74	-23.47	-47.81	3.08	-44.73
6	10521.875 AV	30.91	54	-23.09	-67.43	3.08	-64.35
7	15774.125 PK	49.87	74	-24.13	-48.47	3.08	-45.39
8	15779.875 AV	38.72	54	-15.28	-59.62	3.08	-56.54

Note :

Emission Level (dBuV/m) = EIRP Level (dBm) – 20log(d) + 104.8

d = measurement distance in 3 meters.

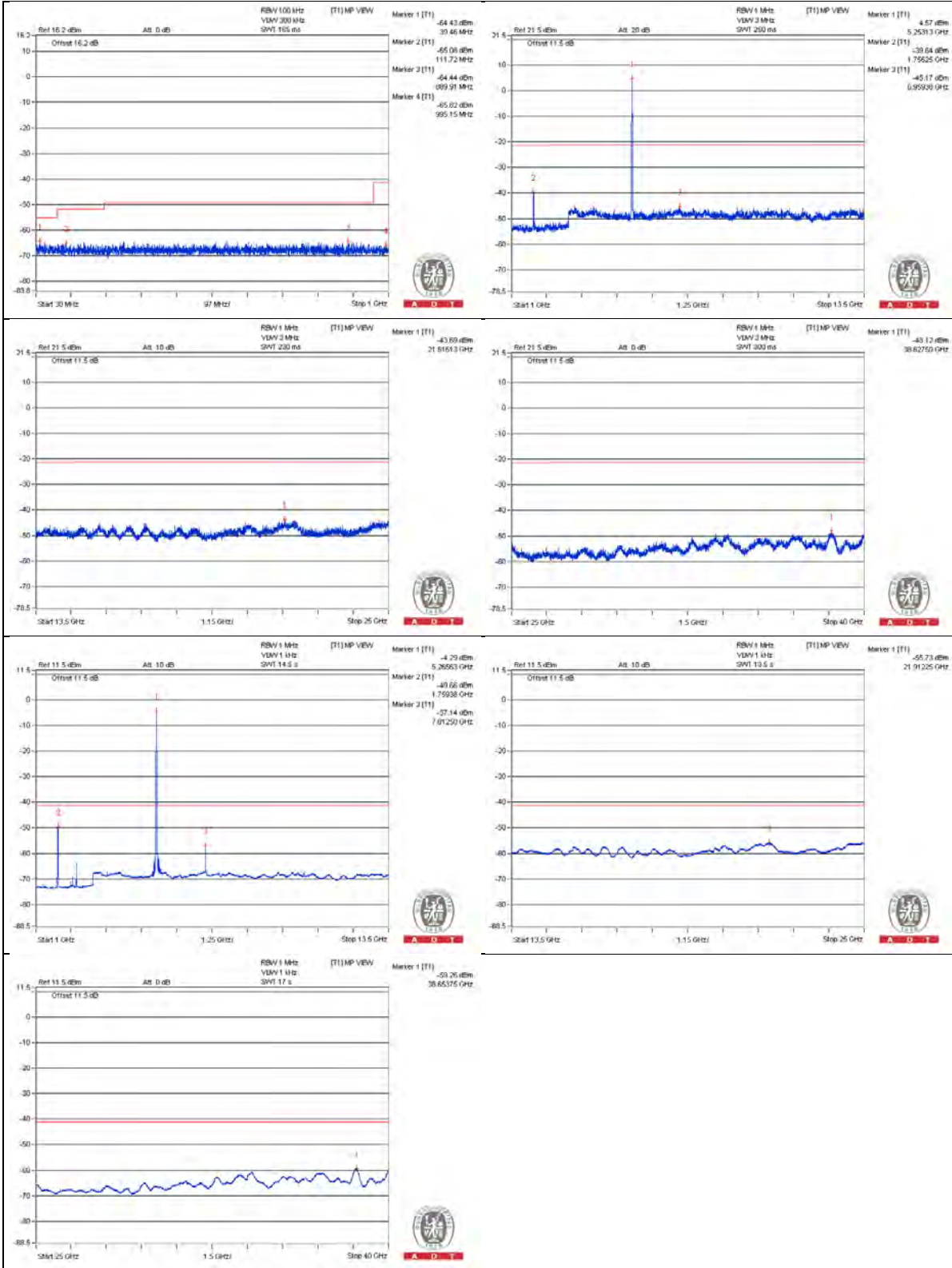

Bandedge table

No.	Frequency (MHz)	Emission Level (dBuV/m)	Limit (dBuV/m)	Margin (dB)	Raw Value (dBm)	Correction Factor (dB)	EIRP Level (dBm)
1	5135.7 PK	50.53	74	-23.47	-47.81	3.08	-44.73
2	5052.35 AV	37.54	54	-16.46	-60.8	3.08	-57.72

Note :

Emission Level (dBuV/m) = EIRP Level (dBm) – 20log(d) + 104.8

d = measurement distance in 3 meters.

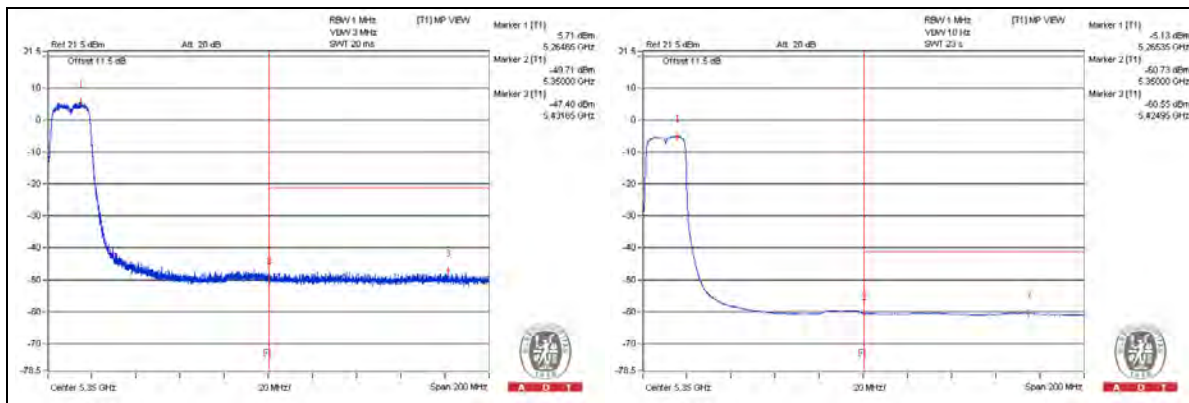

802.11n (HT20) - Channel 60
Conducted spurious emission table

No.	Frequency (MHz)	Emission Level (dBuV/m)	Limit (dBuV/m)	Margin (dB)	Raw Value (dBm)	Correction Factor (dB)	EIRP Level (dBm)
1	3537.5 PK	52.19	74	-21.81	-46.15	3.08	-43.07
2	3531.25 AV	30.62	54	-23.38	-67.72	3.08	-64.64
3	7062.5 PK	50.24	74	-23.76	-48.1	3.08	-45.02
4	7065.625 AV	35.83	54	-18.17	-62.51	3.08	-59.43
5	10600 PK	49.88	74	-24.12	-48.46	3.08	-45.38
6	10600 AV	30.67	54	-23.33	-67.67	3.08	-64.59
7	15900.625 PK	50.14	74	-23.86	-48.2	3.08	-45.12
8	15909.25 AV	39.52	54	-14.48	-58.82	3.08	-55.74

Note :

Emission Level (dBuV/m) = EIRP Level (dBm) – 20log(d) + 104.8

d = measurement distance in 3 meters.

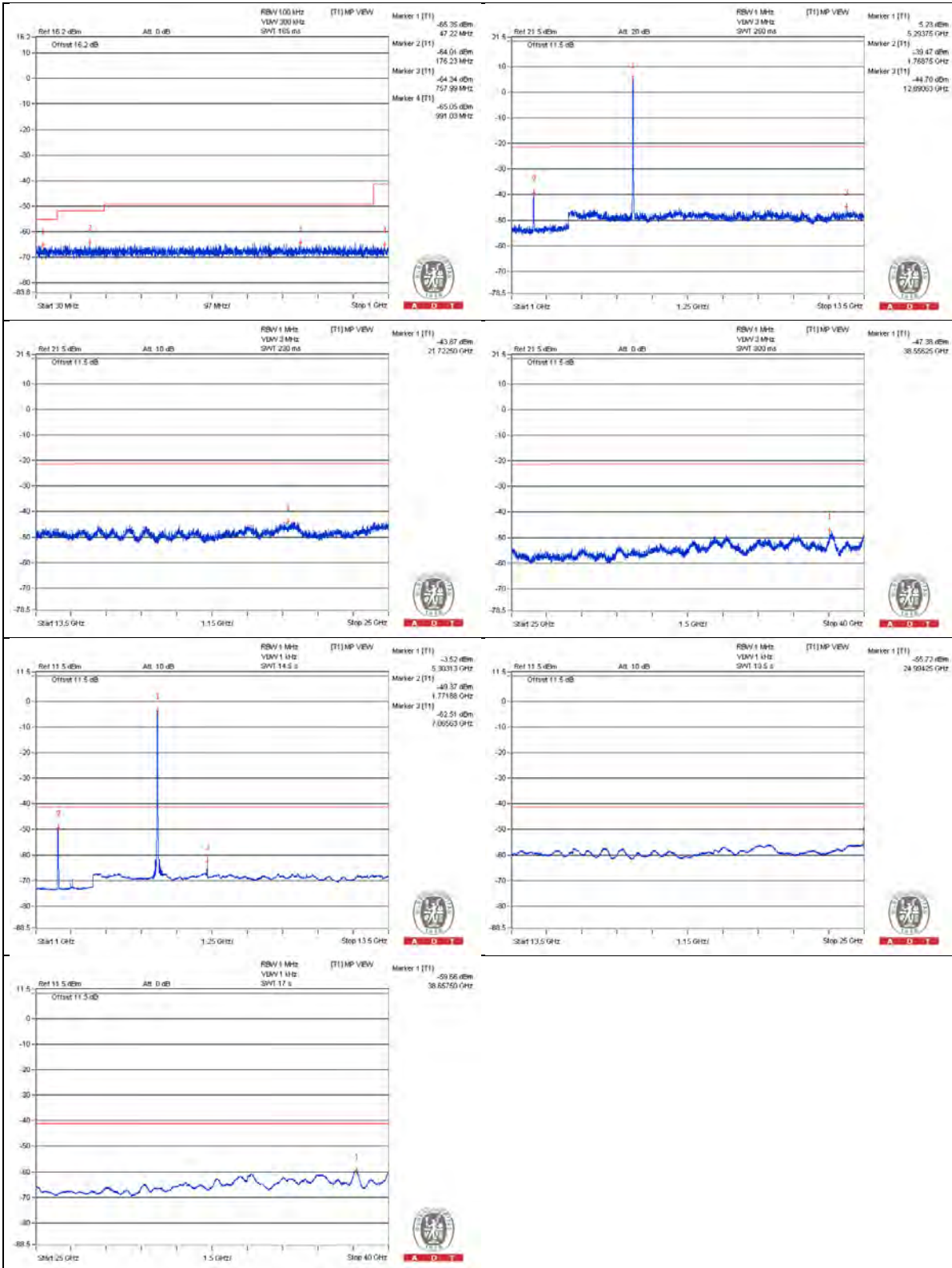

Bandedge table

No.	Frequency (MHz)	Emission Level (dBuV/m)	Limit (dBuV/m)	Margin (dB)	Raw Value (dBm)	Correction Factor (dB)	EIRP Level (dBm)
1	5375.95 PK	52	74	-22	-46.34	3.08	-43.26
2	5376.1 AV	38.57	54	-15.43	-59.77	3.08	-56.69

Note :
 Emission Level (dBuV/m) = EIRP Level (dBm) – 20log(d) + 104.8
 d = measurement distance in 3 meters.

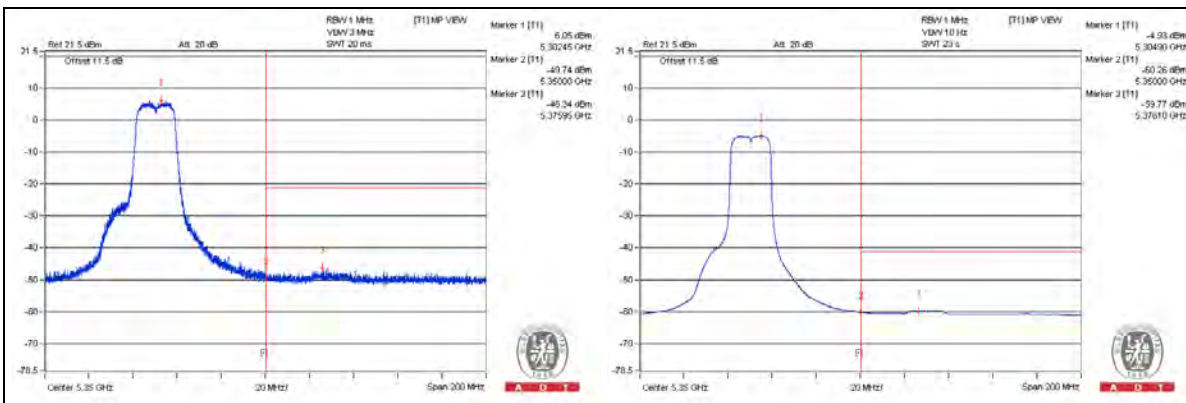

802.11n (HT20) - Channel 64
Conducted spurious emission table

No.	Frequency (MHz)	Emission Level (dBuV/m)	Limit (dBuV/m)	Margin (dB)	Raw Value (dBm)	Correction Factor (dB)	EIRP Level (dBm)
1	3543.75 PK	50.53	74	-23.47	-47.81	3.08	-44.73
2	3546.875 AV	30.44	54	-23.56	-67.9	3.08	-64.82
3	7103.125 PK	51.15	74	-22.85	-47.19	3.08	-44.11
4	7093.75 AV	34.12	54	-19.88	-64.22	3.08	-61.14
5	10643.75 PK	50.96	74	-23.04	-47.38	3.08	-44.3
6	10640.625 AV	31.23	54	-22.77	-67.11	3.08	-64.03
7	15969.625 PK	50.94	74	-23.06	-47.4	3.08	-44.32
8	15955.25 AV	39.97	54	-14.03	-58.37	3.08	-55.29

Note :

Emission Level (dBuV/m) = EIRP Level (dBm) – 20log(d) + 104.8

d = measurement distance in 3 meters.

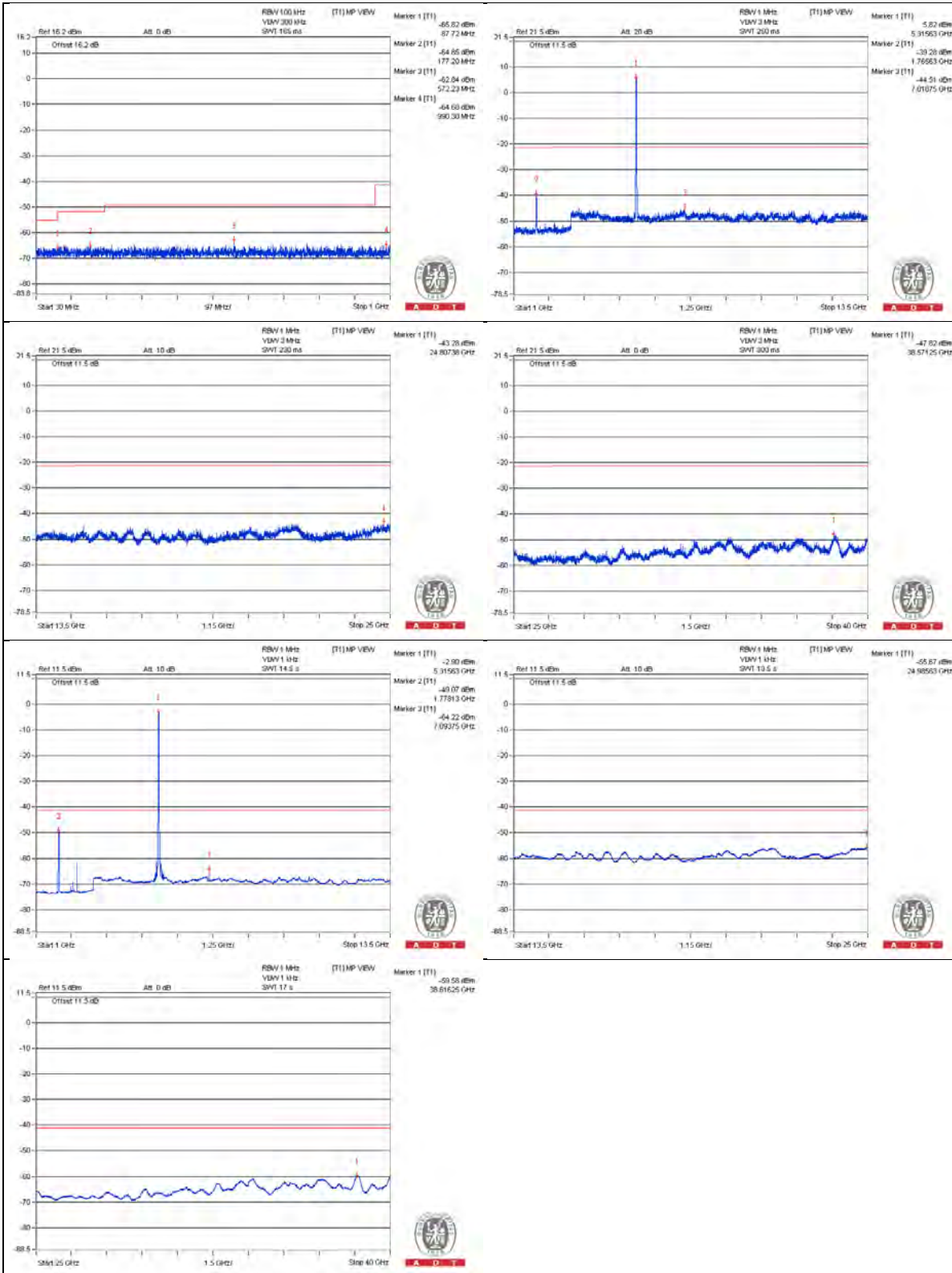

Bandedge table

No.	Frequency (MHz)	Emission Level (dBUV/m)	Limit (dBUV/m)	Margin (dB)	Raw Value (dBm)	Correction Factor (dB)	EIRP Level (dBm)
1	5350.4 PK	54.83	74	-19.17	-43.51	3.08	-40.43
2	5350.05 AV	41.44	54	-12.56	-56.9	3.08	-53.82

Note :

Emission Level (dBUV/m) = EIRP Level (dBm) – 20log(d) + 104.8
d = measurement distance in 3 meters.

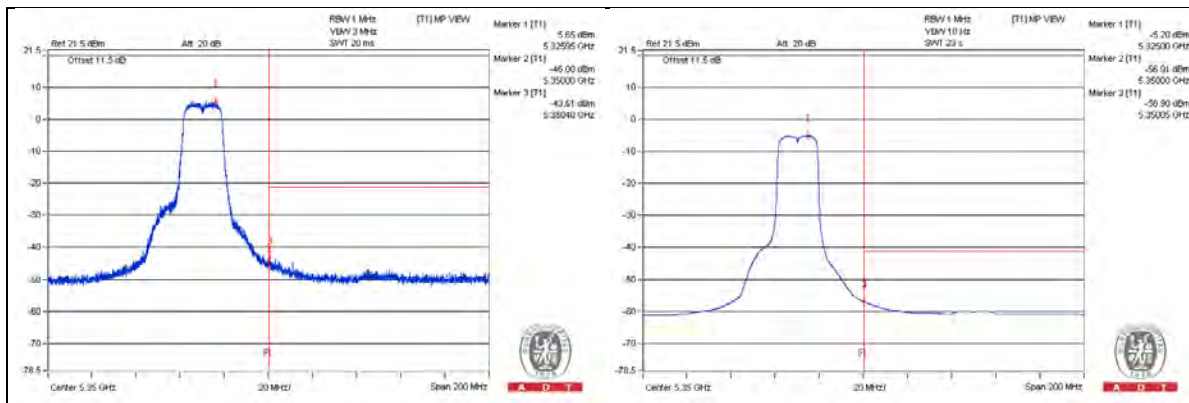

802.11n (HT20) - Channel 100
Conducted spurious emission table

No.	Frequency (MHz)	Emission Level (dBuV/m)	Limit (dBuV/m)	Margin (dB)	Raw Value (dBm)	Correction Factor (dB)	EIRP Level (dBm)
1	3665.625 PK	53.59	74	-20.41	-46.43	4.76	-41.67
2	3665.625 AV	32.74	54	-21.26	-67.28	4.76	-62.52
3	7331.25 PK	53.26	74	-20.74	-46.76	4.76	-42
4	7334.375 AV	32.11	54	-21.89	-67.91	4.76	-63.15
5	11009.375 PK	51.81	74	-22.19	-48.21	4.76	-43.45
6	11000 AV	34.19	54	-19.81	-65.83	4.76	-61.07
7	16490 PK	53.05	74	-20.95	-46.97	4.76	-42.21
8	16498.625 AV	42.43	54	-11.57	-57.59	4.76	-52.83

Note :

Emission Level (dBuV/m) = EIRP Level (dBm) – 20log(d) + 104.8

d = measurement distance in 3 meters.

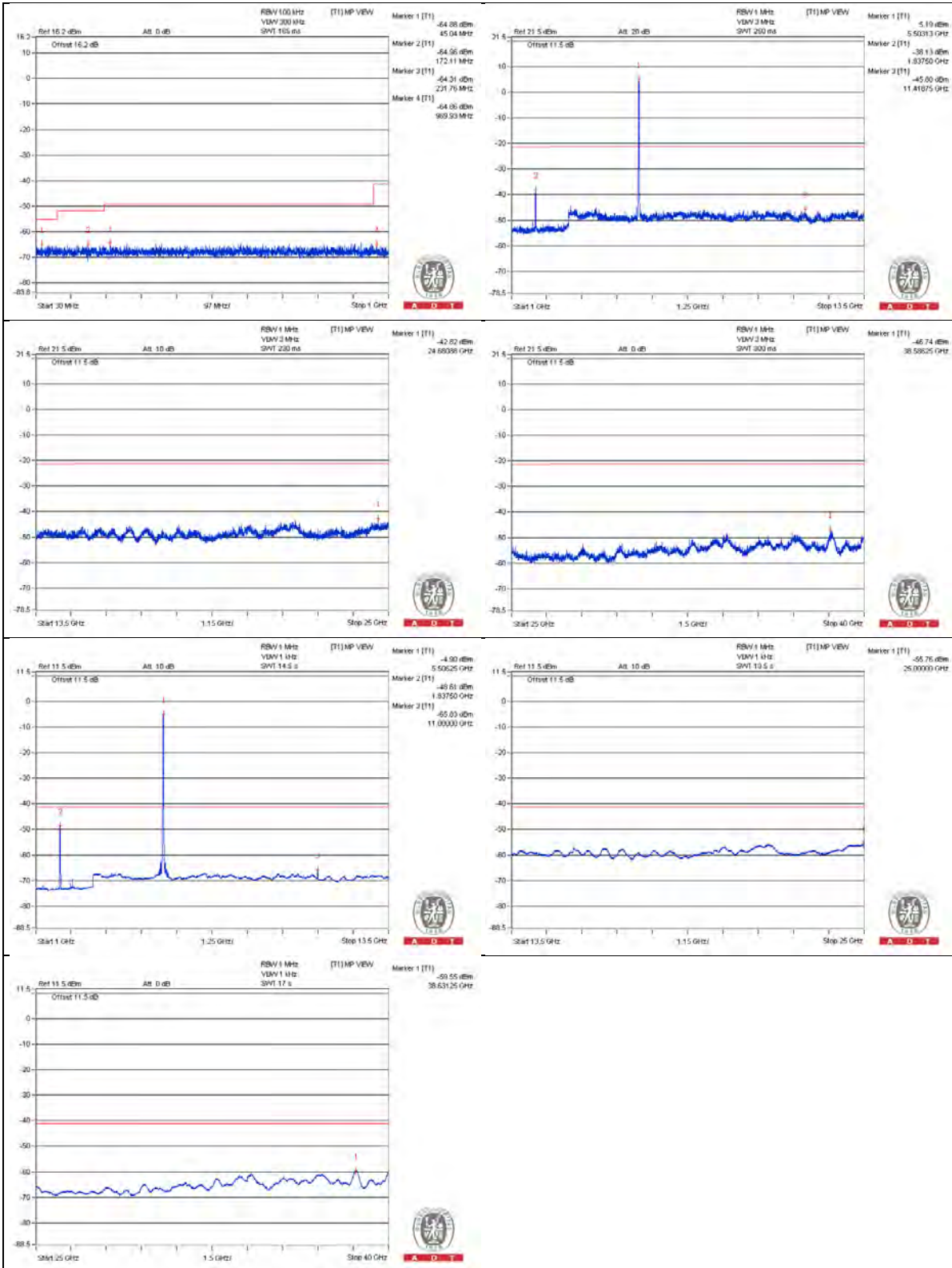

Bandedge table

No.	Frequency (MHz)	Emission Level (dBuV/m)	Limit (dBuV/m)	Margin (dB)	Raw Value (dBm)	Correction Factor (dB)	EIRP Level (dBm)
1	5465.56 PK	54.74	74	-19.26	-45.28	4.76	-40.52
2	5470 AV	41.62	54	-12.38	-58.4	4.76	-53.64

Note :

$$\text{Emission Level (dBuV/m)} = \text{EIRP Level (dBm)} - 20\log(d) + 104.8$$

d = measurement distance in 3 meters.

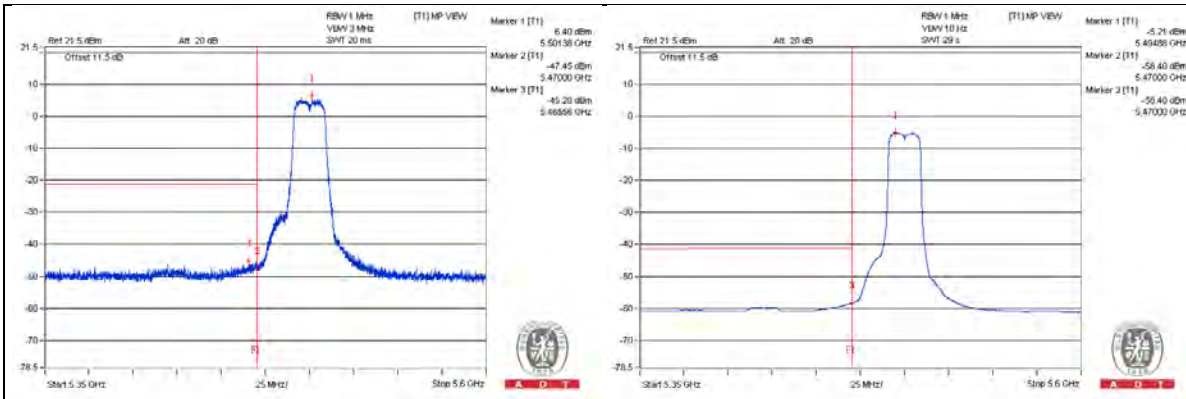

802.11n (HT20) - Channel 120**Conducted spurious emission table**

No.	Frequency (MHz)	Emission Level (dBuV/m)	Limit (dBuV/m)	Margin (dB)	Raw Value (dBm)	Correction Factor (dB)	EIRP Level (dBm)
1	3734.375 PK	52.46	74	-21.54	-47.56	4.76	-42.8
2	3731.25 AV	32.39	54	-21.61	-67.63	4.76	-62.87
3	7459.375 PK	53.11	74	-20.89	-46.91	4.76	-42.15
4	7465.625 AV	33.25	54	-20.75	-66.77	4.76	-62.01
5	11206.25 PK	51.09	74	-22.91	-48.93	4.76	-44.17
6	11200 AV	32.57	54	-21.43	-67.45	4.76	-62.69
7	16803.375 PK	51.32	74	-22.68	-48.7	4.76	-43.94
8	16803.375 AV	40.39	54	-13.61	-59.63	4.76	-54.87

Note :

Emission Level (dBuV/m) = EIRP Level (dBm) – 20log(d) + 104.8

d = measurement distance in 3 meters.

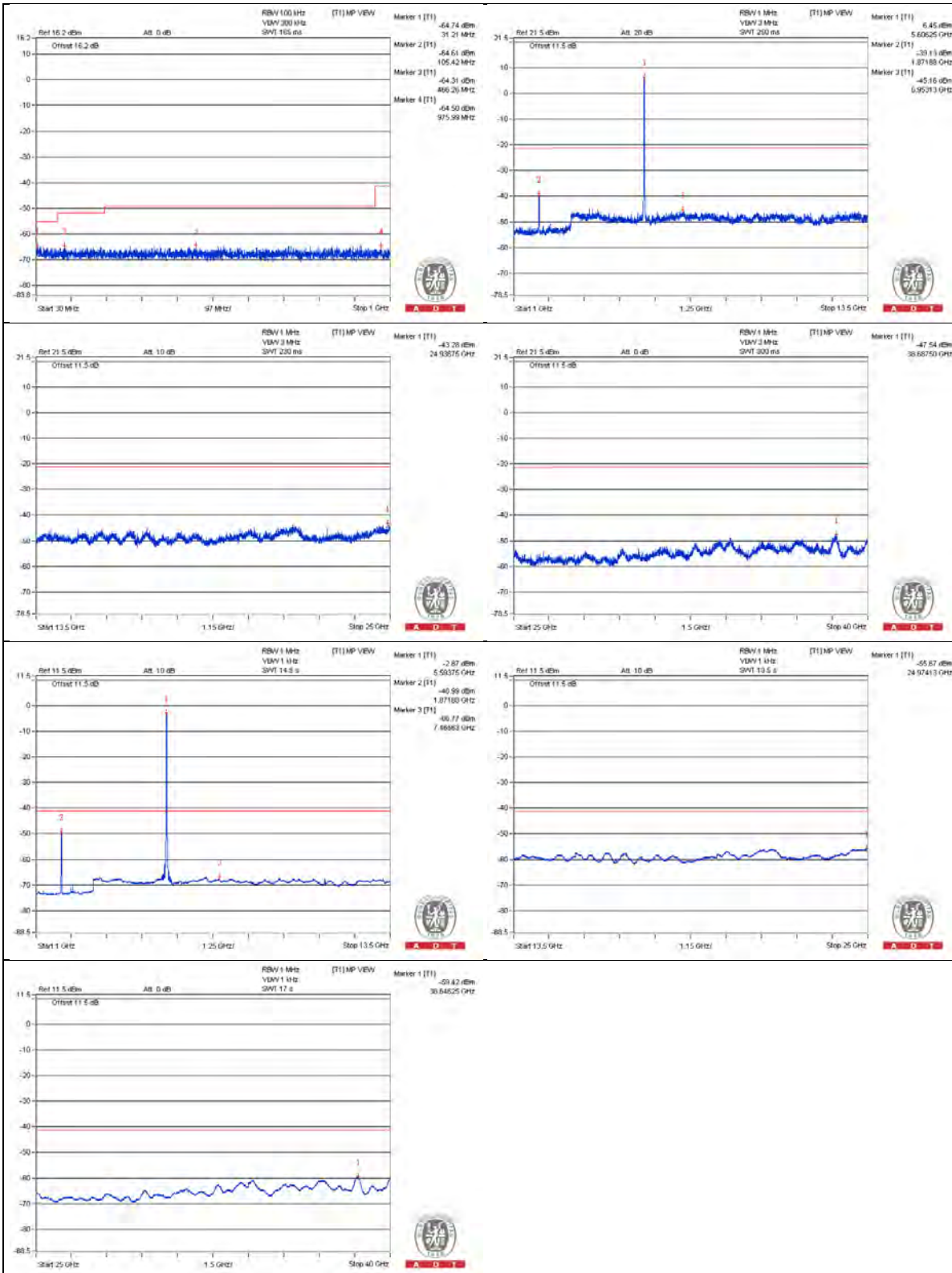

Bandedge table

No.	Frequency (MHz)	Emission Level (dBuV/m)	Limit (dBuV/m)	Margin (dB)	Raw Value (dBm)	Correction Factor (dB)	EIRP Level (dBm)
1	5433.31 PK	53.02	74	-20.98	-47	4.76	-42.24
2	5354.87 AV	39.33	54	-14.67	-60.69	4.76	-55.93

Note :

$$\text{Emission Level (dBuV/m)} = \text{EIRP Level (dBm)} - 20\log(d) + 104.8$$

d = measurement distance in 3 meters.

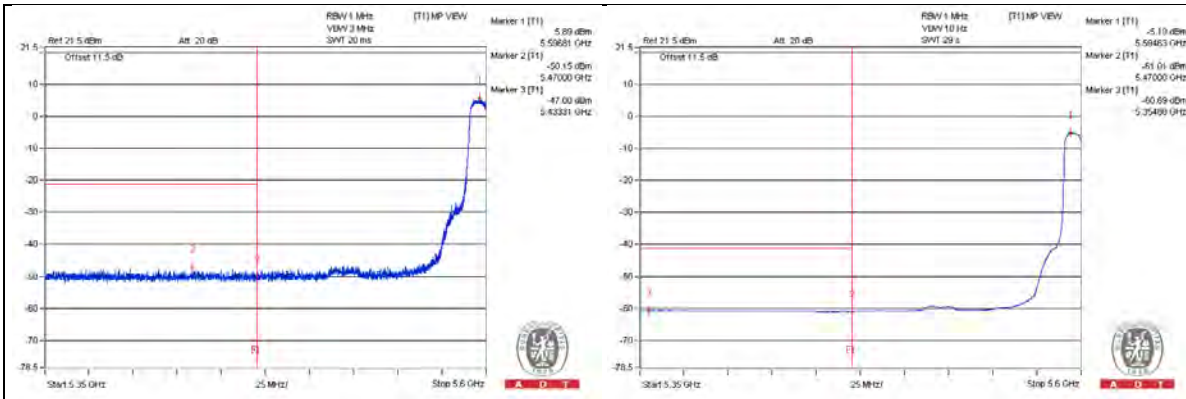

802.11n (HT20) - Channel 140
Conducted spurious emission table

No.	Frequency (MHz)	Emission Level (dBuV/m)	Limit (dBuV/m)	Margin (dB)	Raw Value (dBm)	Correction Factor (dB)	EIRP Level (dBm)
1	3796.875 PK	54.77	74	-19.23	-45.25	4.76	-40.49
2	3803.125 AV	32.41	54	-21.59	-67.61	4.76	-62.85
3	7596.875 PK	53.37	74	-20.63	-46.65	4.76	-41.89
4	7600 AV	32.6	54	-21.4	-67.42	4.76	-62.66
5	11393.75 PK	53.07	74	-20.93	-46.95	4.76	-42.19
6	11400 AV	33.27	54	-20.73	-66.75	4.76	-61.99
7	17096.625 PK	53.2	74	-20.8	-46.82	4.76	-42.06
8	17093.75 AV	42.85	54	-11.15	-57.17	4.76	-52.41

Note :

Emission Level (dBuV/m) = EIRP Level (dBm) – 20log(d) + 104.8

d = measurement distance in 3 meters.

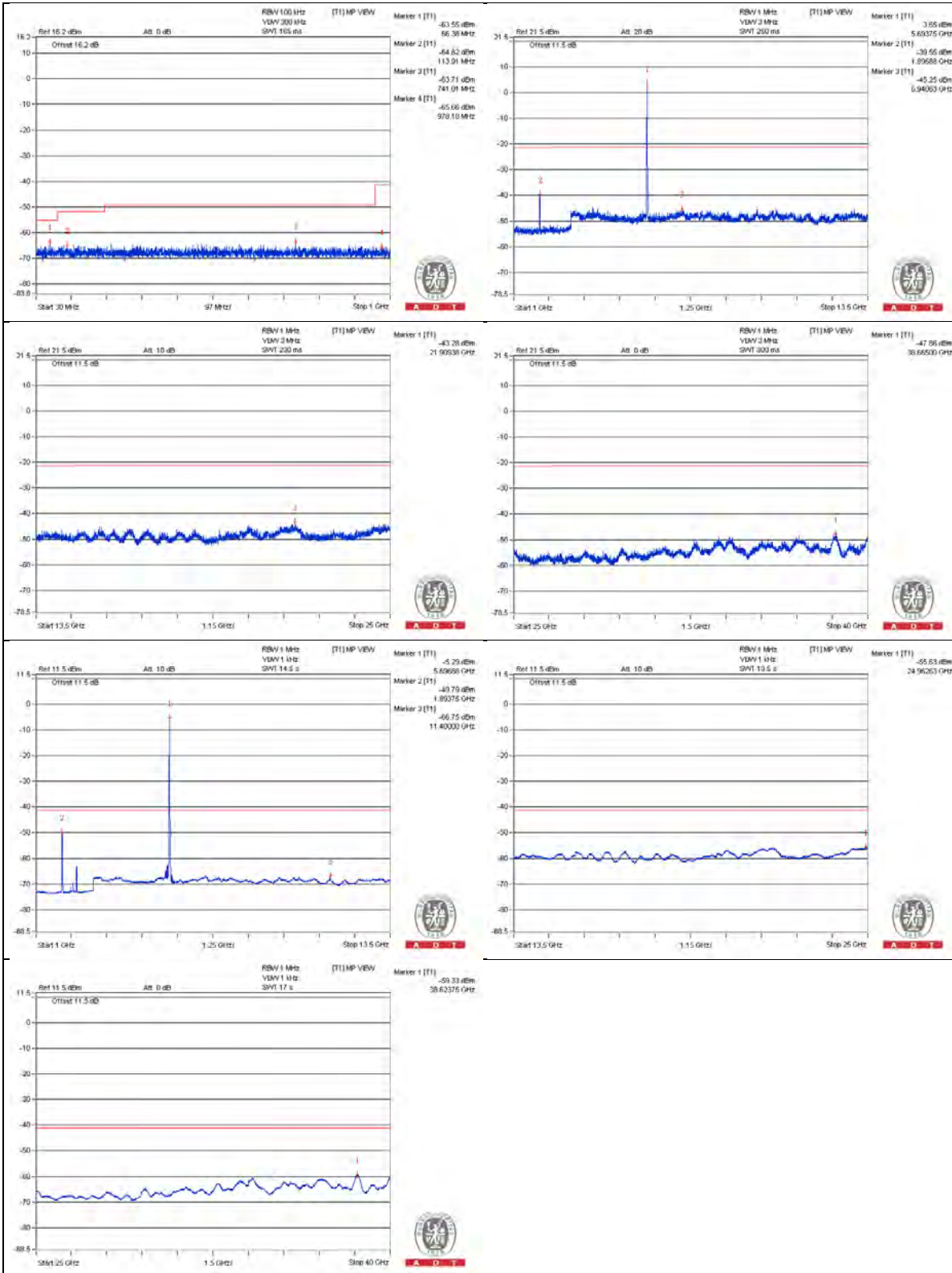

Bandedge table

No.	Frequency (MHz)	Emission Level (dBuV/m)	Limit (dBuV/m)	Margin (dB)	Raw Value (dBm)	Correction Factor (dB)	EIRP Level (dBm)
1	5725.5 PK	54.82	74	-19.18	-45.2	4.76	-40.44
2	5725 AV	42.62	54	-11.38	-57.4	4.76	-52.64

Note :

Emission Level (dBuV/m) = EIRP Level (dBm) – 20log(d) + 104.8
d = measurement distance in 3 meters.

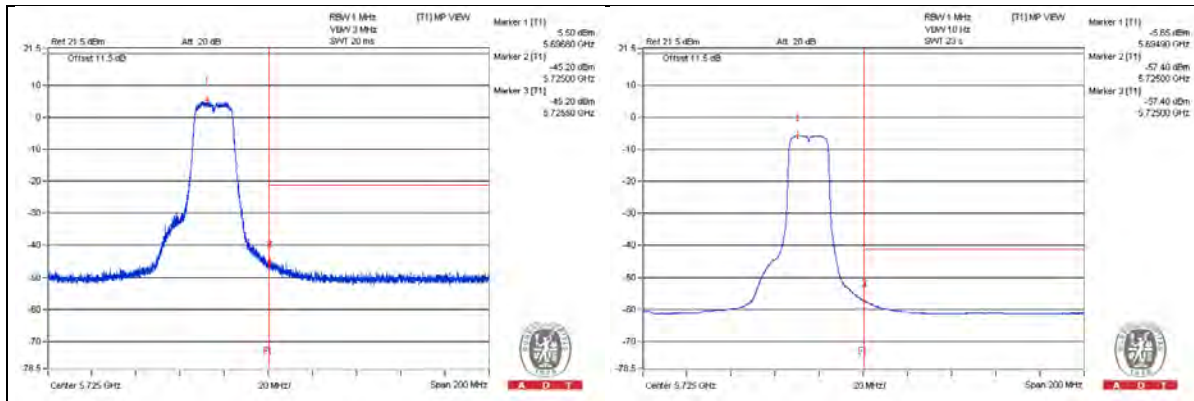

802.11n (HT20) - Channel 144**Conducted spurious emission table**

No.	Frequency (MHz)	Emission Level (dBuV/m)	Limit (dBuV/m)	Margin (dB)	Raw Value (dBm)	Correction Factor (dB)	EIRP Level (dBm)
1	3809.375 PK	54.27	74	-19.73	-45.75	4.76	-40.99
2	3812.5 AV	32.34	54	-21.66	-67.68	4.76	-62.92
3	7618.75 PK	53.16	74	-20.84	-46.86	4.76	-42.1
4	7628.125 AV	32.61	54	-21.39	-67.41	4.76	-62.65
5	11443.75 PK	54.02	74	-19.98	-46	4.76	-41.24
6	11440.625 AV	33.44	54	-20.56	-66.58	4.76	-61.82
7	17159.875 PK	53.16	74	-20.84	-46.86	4.76	-42.1
8	17154.125 AV	42.31	54	-11.69	-57.71	4.76	-52.95

Note :

Emission Level (dBuV/m) = EIRP Level (dBm) – 20log(d) + 104.8

d = measurement distance in 3 meters.

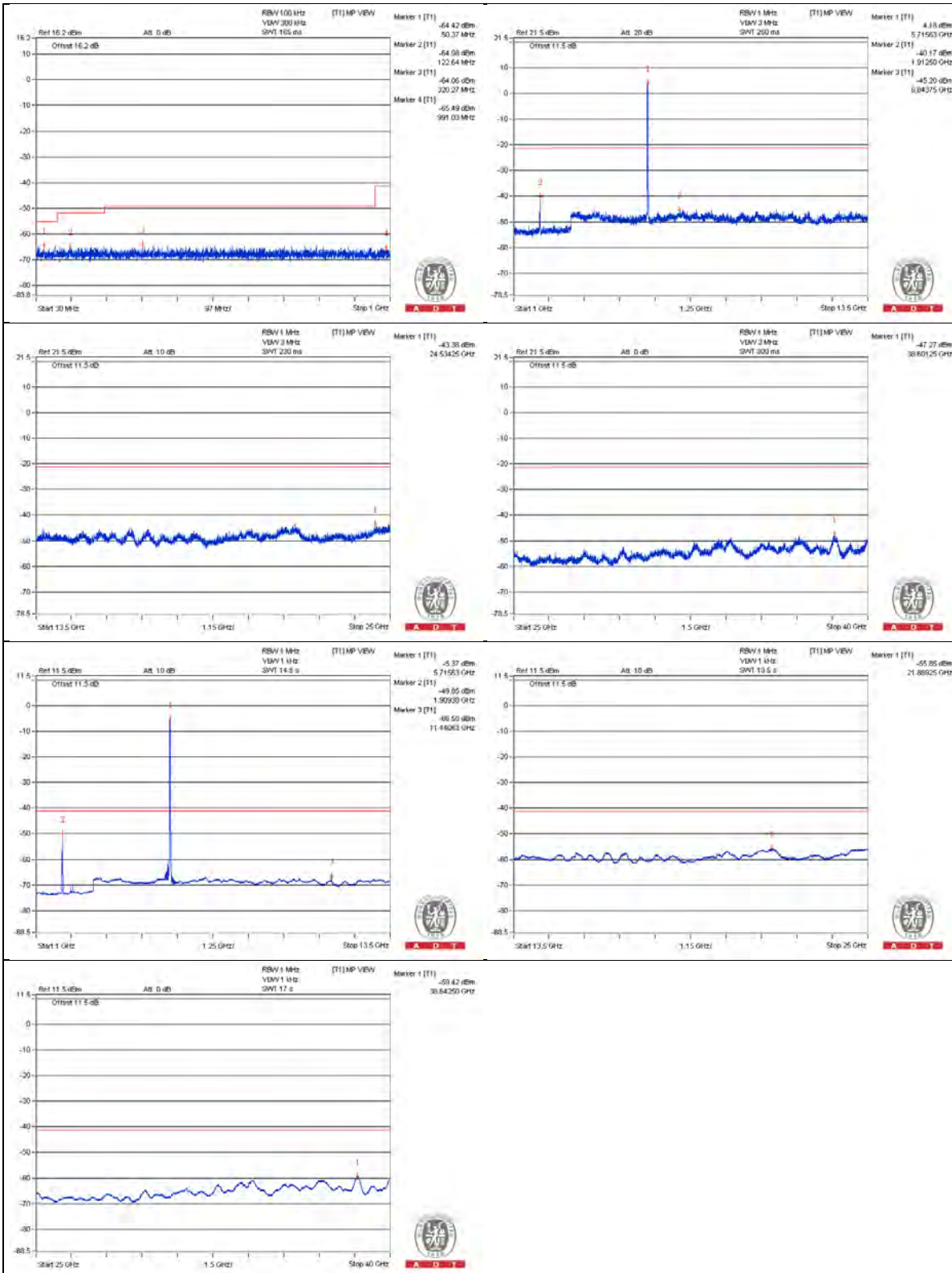

Bandedge table

No.	Frequency (MHz)	Emission Level (dBUV/m)	Limit (dBUV/m)	Margin (dB)	Raw Value (dBm)	Correction Factor (dB)	EIRP Level (dBm)
1	5857.23 PK	52.17	74	-21.83	-47.85	4.76	-43.09
2	5876.65 AV	38.99	54	-15.01	-61.03	4.76	-56.27

Note :

$$\text{Emission Level (dBUV/m)} = \text{EIRP Level (dBm)} - 20\log(d) + 104.8$$

d = measurement distance in 3 meters.

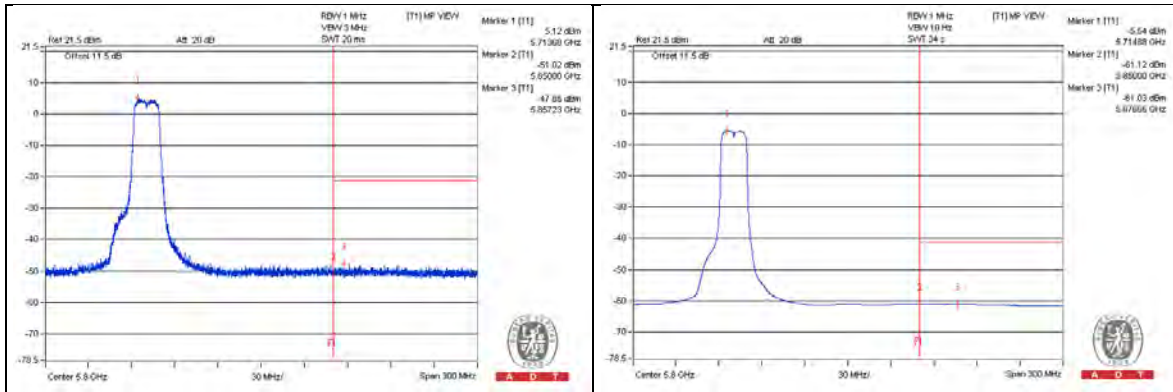

802.11n (HT20) - Channel 149**Conducted spurious emission table**

No.	Frequency (MHz)	Emission Level (dBuV/m)	Limit (dBuV/m)	Margin (dB)	Raw Value (dBm)	Correction Factor (dB)	EIRP Level (dBm)
1	3821.875 PK	53.39	74	-20.61	-46.63	4.76	-41.87
2	3825 AV	32.28	54	-21.72	-67.74	4.76	-62.98
3	7665.625 PK	52.54	74	-21.46	-47.48	4.76	-42.72
4	7659.375 AV	32.39	54	-21.61	-67.63	4.76	-62.87
5	11490.625 PK	52.1	74	-21.9	-47.92	4.76	-43.16
6	11490.625 AV	33.84	54	-20.16	-66.18	4.76	-61.42
7	17231.75 PK	54.64	74	-19.36	-45.38	4.76	-40.62
8	17231.75 AV	41.73	54	-12.27	-58.29	4.76	-53.53

Note :

Emission Level (dBuV/m) = EIRP Level (dBm) – 20log(d) + 104.8
d = measurement distance in 3 meters.

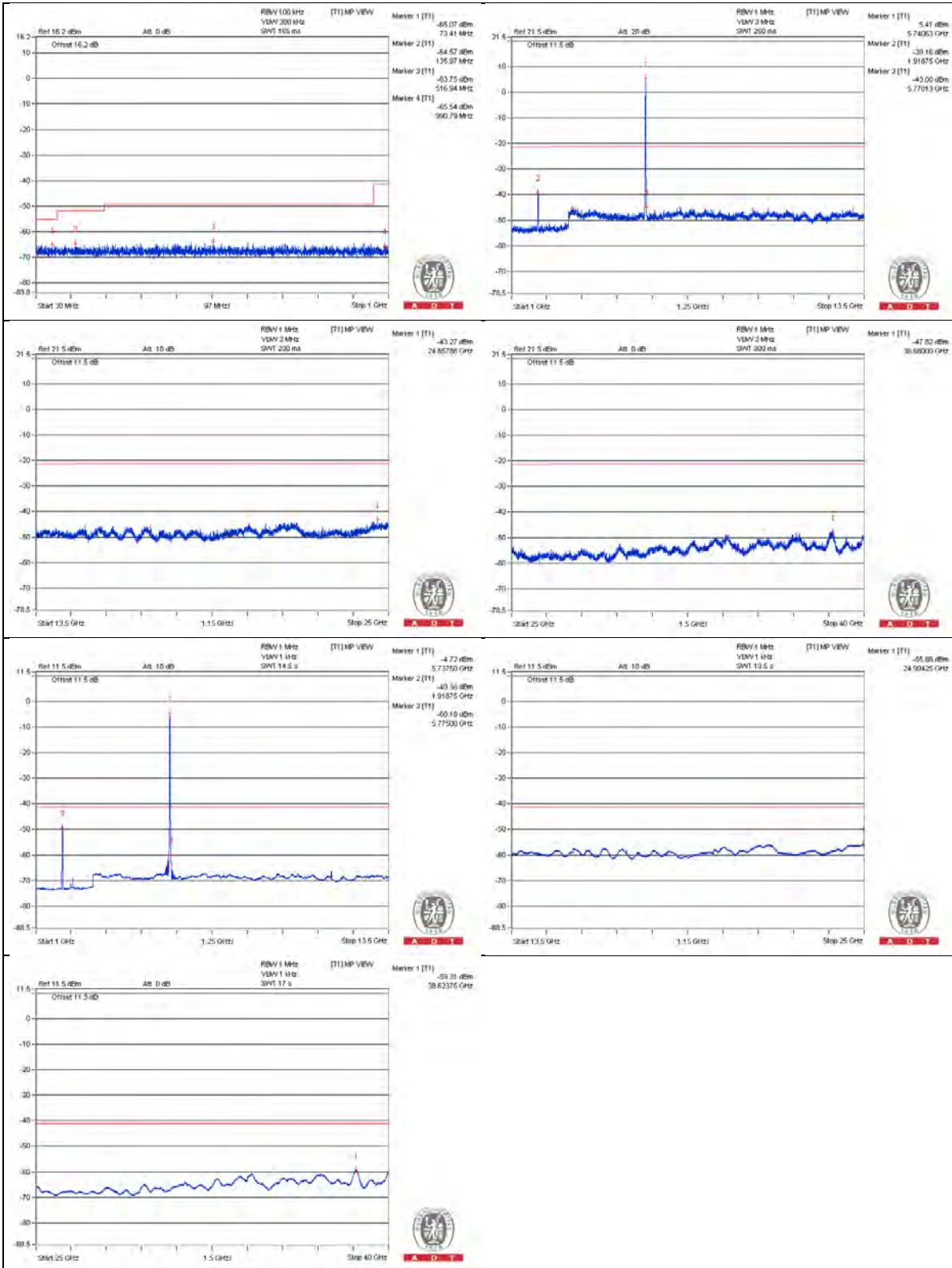

Bandedge table

No.	Frequency (MHz)	Emission Level (dBuV/m)	Limit (dBuV/m)	Margin (dB)	Raw Value (dBm)	Correction Factor (dB)	EIRP Level (dBm)
1	5714.9 PK	54.52	74	-19.48	-45.5	4.76	-40.74
2	5715 AV	40.58	54	-13.42	-59.44	4.76	-54.68
3	5725 PK	68.23	78.2	-9.97	-31.79	4.76	-27.03
4	5855.07 PK	52.57	78.2	-25.63	-47.45	4.76	-42.69
5	5937.5 PK	50.4	74	-23.6	-49.62	4.76	-44.86
6	5863.77 AV	38.96	54	-15.04	-61.06	4.76	-56.3

Note :

Emission Level (dBuV/m) = EIRP Level (dBm) – 20log(d) + 104.8
d = measurement distance in 3 meters.

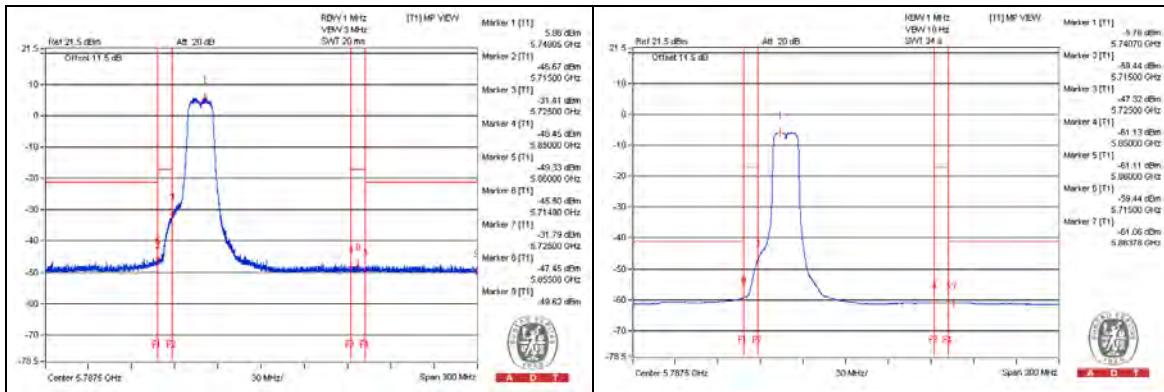

802.11n (HT20) - Channel 157
Conducted spurious emission table

No.	Frequency (MHz)	Emission Level (dBuV/m)	Limit (dBuV/m)	Margin (dB)	Raw Value (dBm)	Correction Factor (dB)	EIRP Level (dBm)
1	3850 PK	53.21	74	-20.79	-46.81	4.76	-42.05
2	3862.5 AV	32.28	54	-21.72	-67.74	4.76	-62.98
3	7721.875 PK	53.16	74	-20.84	-46.86	4.76	-42.1
4	7712.5 AV	32.09	54	-21.91	-67.93	4.76	-63.17
5	11565.625 PK	51.13	74	-22.87	-48.89	4.76	-44.13
6	11571.875 AV	31.12	54	-22.88	-68.9	4.76	-64.14

Note :

Emission Level (dBuV/m) = EIRP Level (dBm) – 20log(d) + 104.8

d = measurement distance in 3 meters.

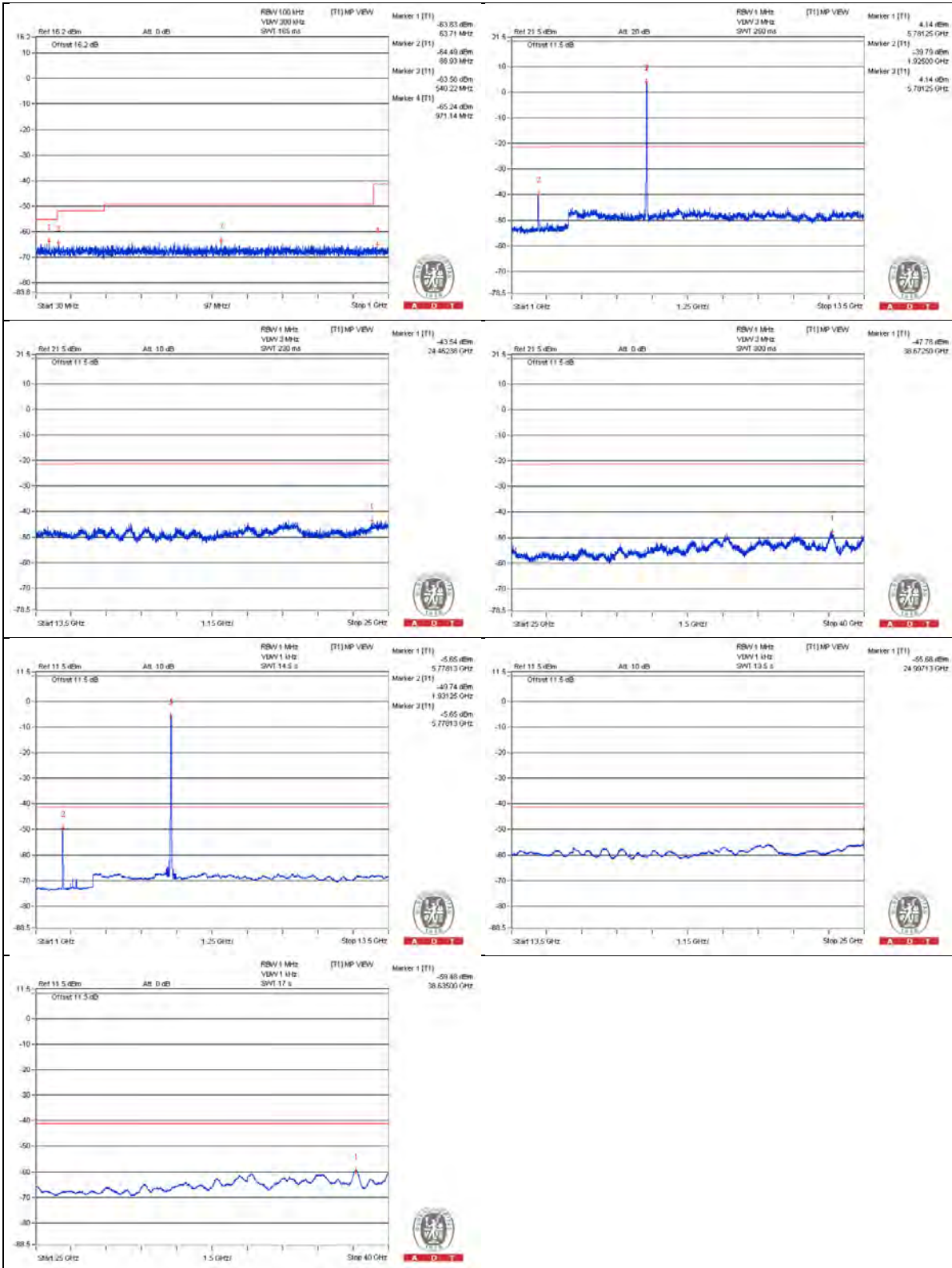

Bandedge table

No.	Frequency (MHz)	Emission Level (dBuV/m)	Limit (dBuV/m)	Margin (dB)	Raw Value (dBm)	Correction Factor (dB)	EIRP Level (dBm)
1	5700.05 PK	52.14	74	-21.86	-47.88	4.76	-43.12
2	5699.75 AV	39.39	54	-14.61	-60.63	4.76	-55.87
3	5724.35 PK	51.38	78.2	-26.82	-48.64	4.76	-43.88
4	5851.25 PK	51.29	78.2	-26.91	-48.73	4.76	-43.97
5	5937.5 PK	48.74	74	-25.26	-51.28	4.76	-46.52
6	5861.68 AV	38.99	54	-15.01	-61.03	4.76	-56.27

Note :

Emission Level (dBuV/m) = EIRP Level (dBm) – 20log(d) + 104.8

d = measurement distance in 3 meters.

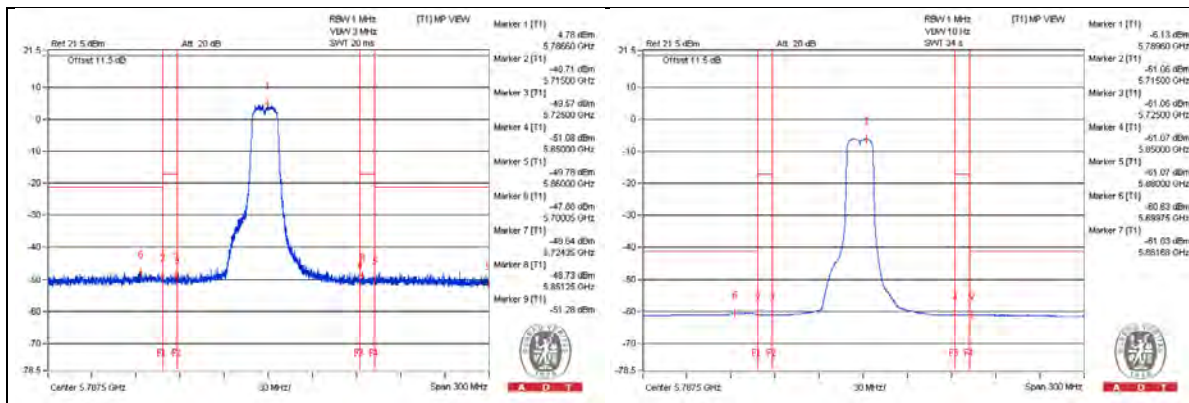

802.11n (HT20) - Channel 165
Conducted spurious emission table

No.	Frequency (MHz)	Emission Level (dBuV/m)	Limit (dBuV/m)	Margin (dB)	Raw Value (dBm)	Correction Factor (dB)	EIRP Level (dBm)
1	3881.25 PK	53.85	74	-20.15	-46.17	4.76	-41.41
2	3884.375 AV	32.71	54	-21.29	-67.31	4.76	-62.55
3	7771.875 PK	53.21	74	-20.79	-46.81	4.76	-42.05
4	7765.625 AV	32.06	54	-21.94	-67.96	4.76	-63.2
5	11646.875 PK	51.59	74	-22.41	-48.43	4.76	-43.67
6	11653.125 AV	30.24	54	-23.76	-69.78	4.76	-65.02
7	17484.75 PK	51.99	74	-22.01	-48.03	4.76	-43.27
8	17479 AV	40.76	54	-13.24	-59.26	4.76	-54.5

Note :

Emission Level (dBuV/m) = EIRP Level (dBm) – 20log(d) + 104.8

d = measurement distance in 3 meters.

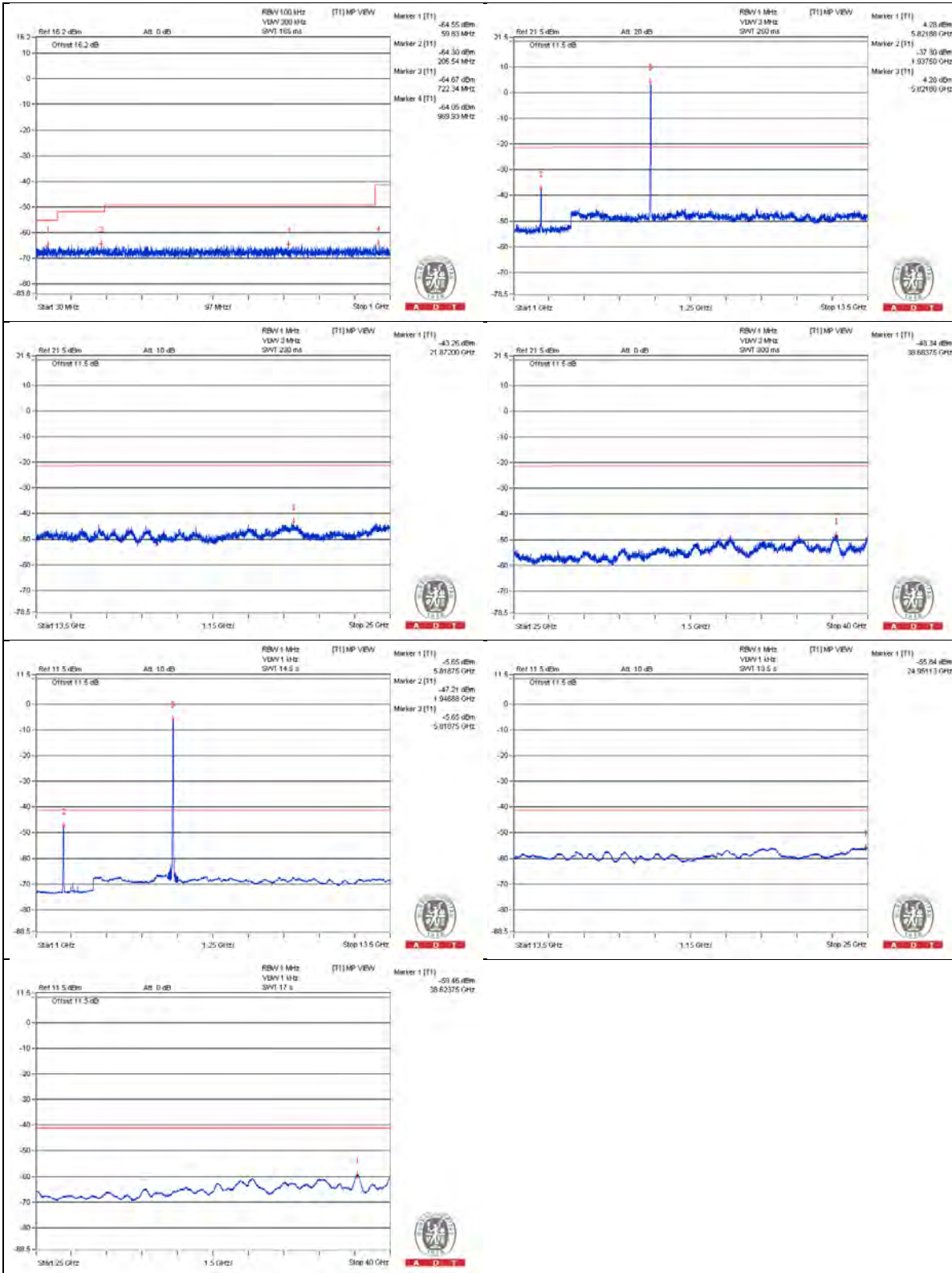

Bandedge table

No.	Frequency (MHz)	Emission Level (dBuV/m)	Limit (dBuV/m)	Margin (dB)	Raw Value (dBm)	Correction Factor (dB)	EIRP Level (dBm)
1	5671.77 PK	52.73	74	-21.27	-47.29	4.76	-42.53
2	5702.07 AV	39.11	54	-14.89	-60.91	4.76	-56.15
3	5723.98 PK	51.48	78.2	-26.72	-48.54	4.76	-43.78
4	5852.23 PK	54.37	78.2	-23.83	-45.65	4.76	-40.89
5	5937.5 PK	48.7	74	-25.3	-51.32	4.76	-46.56
6	5860 AV	40.25	54	-13.75	-59.77	4.76	-55.01

Note :

Emission Level (dBuV/m) = EIRP Level (dBm) – 20log(d) + 104.8
d = measurement distance in 3 meters.

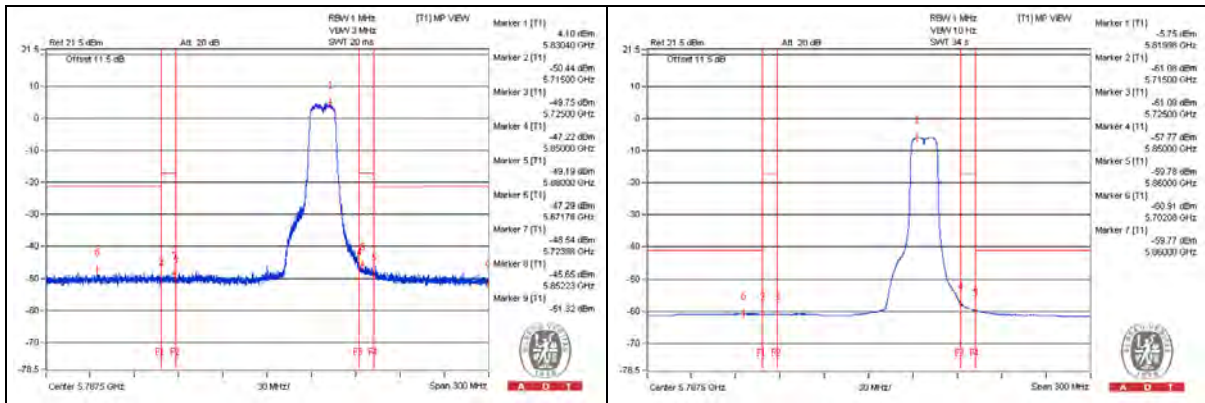

802.11n (HT40) - Channel 38**Conducted spurious emission table**

No.	Frequency (MHz)	Emission Level (dBuV/m)	Limit (dBuV/m)	Margin (dB)	Raw Value (dBm)	Correction Factor (dB)	EIRP Level (dBm)
1	3465.625 PK	50.46	74	-23.54	-47.88	3.08	-44.8
2	3459.375 AV	33.91	54	-20.09	-64.43	3.08	-61.35
3	6921.875 PK	52.1	74	-21.9	-46.24	3.08	-43.16
4	6918.75 AV	46.71	54	-7.29	-51.63	3.08	-48.55
5	10384.375 PK	51.46	74	-22.54	-46.88	3.08	-43.8
6	10375 AV	30.71	54	-23.29	-67.63	3.08	-64.55
7	15567.125 PK	50.85	74	-23.15	-47.49	3.08	-44.41
8	15575.75 AV	40.32	54	-13.68	-58.02	3.08	-54.94

Note :

Emission Level (dBuV/m) = EIRP Level (dBm) – 20log(d) + 104.8

d = measurement distance in 3 meters.

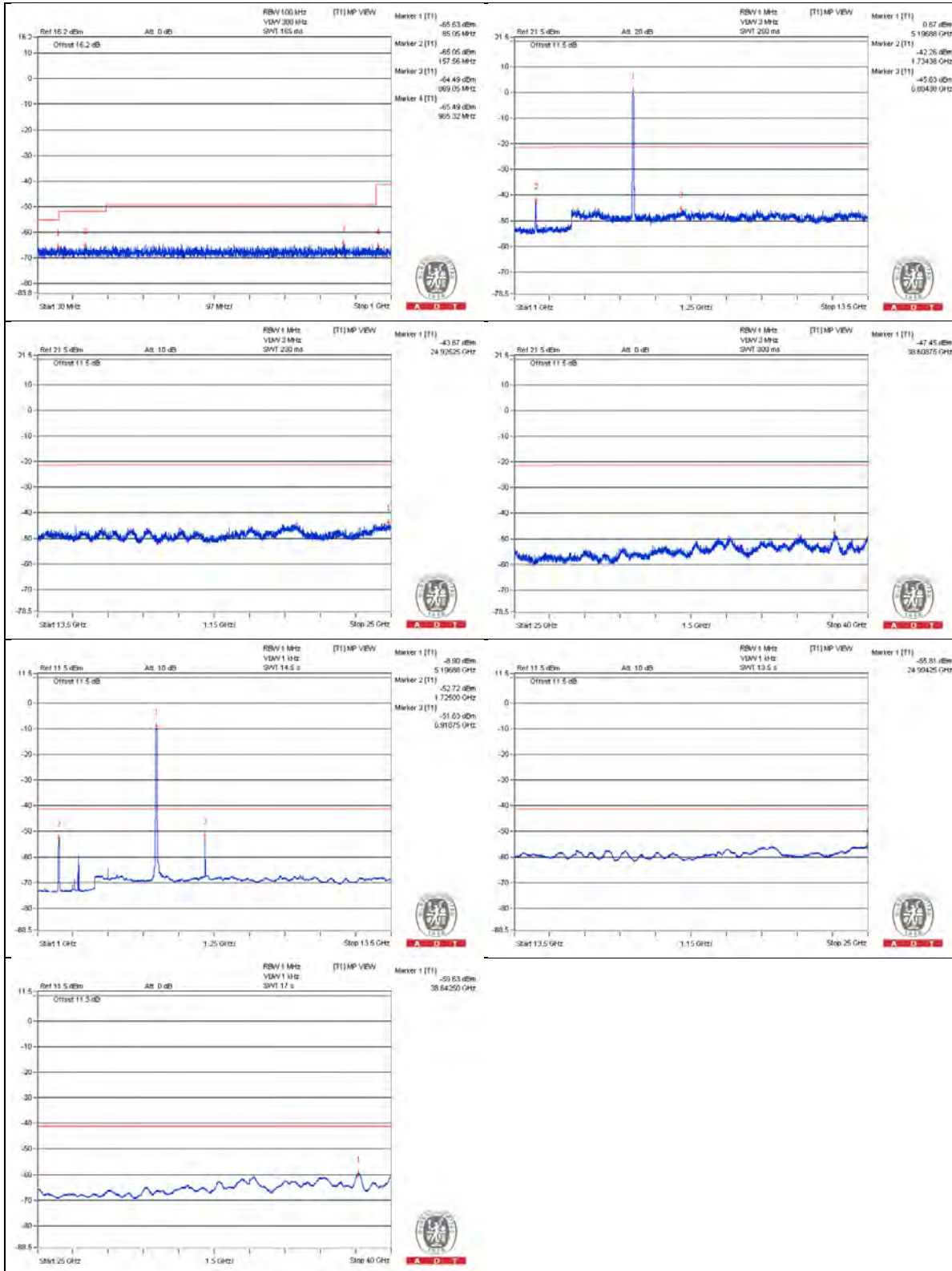

Bandedge table

No.	Frequency (MHz)	Emission Level (dBuV/m)	Limit (dBuV/m)	Margin (dB)	Raw Value (dBm)	Correction Factor (dB)	EIRP Level (dBm)
1	5150 PK	58.35	74	-15.65	-39.99	3.08	-36.91
2	5150 AV	44.61	54	-9.39	-53.73	3.08	-50.65

Note :

$$\text{Emission Level (dBuV/m)} = \text{EIRP Level (dBm)} - 20\log(d) + 104.8$$

d = measurement distance in 3 meters.

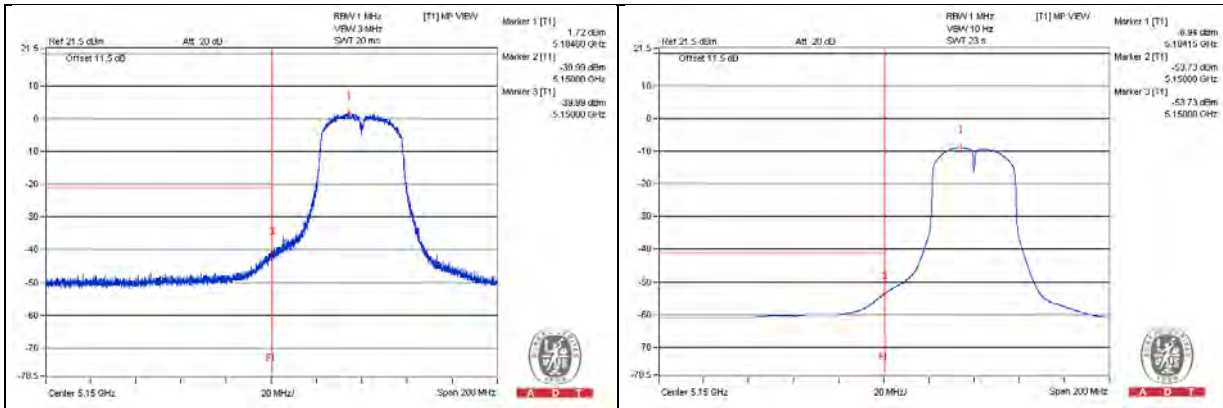

802.11n (HT40) - Channel 46
Conducted spurious emission table

No.	Frequency (MHz)	Emission Level (dBuV/m)	Limit (dBuV/m)	Margin (dB)	Raw Value (dBm)	Correction Factor (dB)	EIRP Level (dBm)
1	3478.125 PK	51.22	74	-22.78	-47.12	3.08	-44.04
2	3484.375 AV	31.47	54	-22.53	-66.87	3.08	-63.79
3	6971.875 PK	53.26	74	-20.74	-45.08	3.08	-42
4	6971.875 AV	43.97	54	-10.03	-54.37	3.08	-51.29
5	10459.375 PK	50.46	74	-23.54	-47.88	3.08	-44.8
6	10453.125 AV	30.41	54	-23.59	-67.93	3.08	-64.85
7	15685 PK	50.34	74	-23.66	-48	3.08	-44.92
8	15682.125 AV	39.58	54	-14.42	-58.76	3.08	-55.68

Note :

Emission Level (dBuV/m) = EIRP Level (dBm) – 20log(d) + 104.8

d = measurement distance in 3 meters.

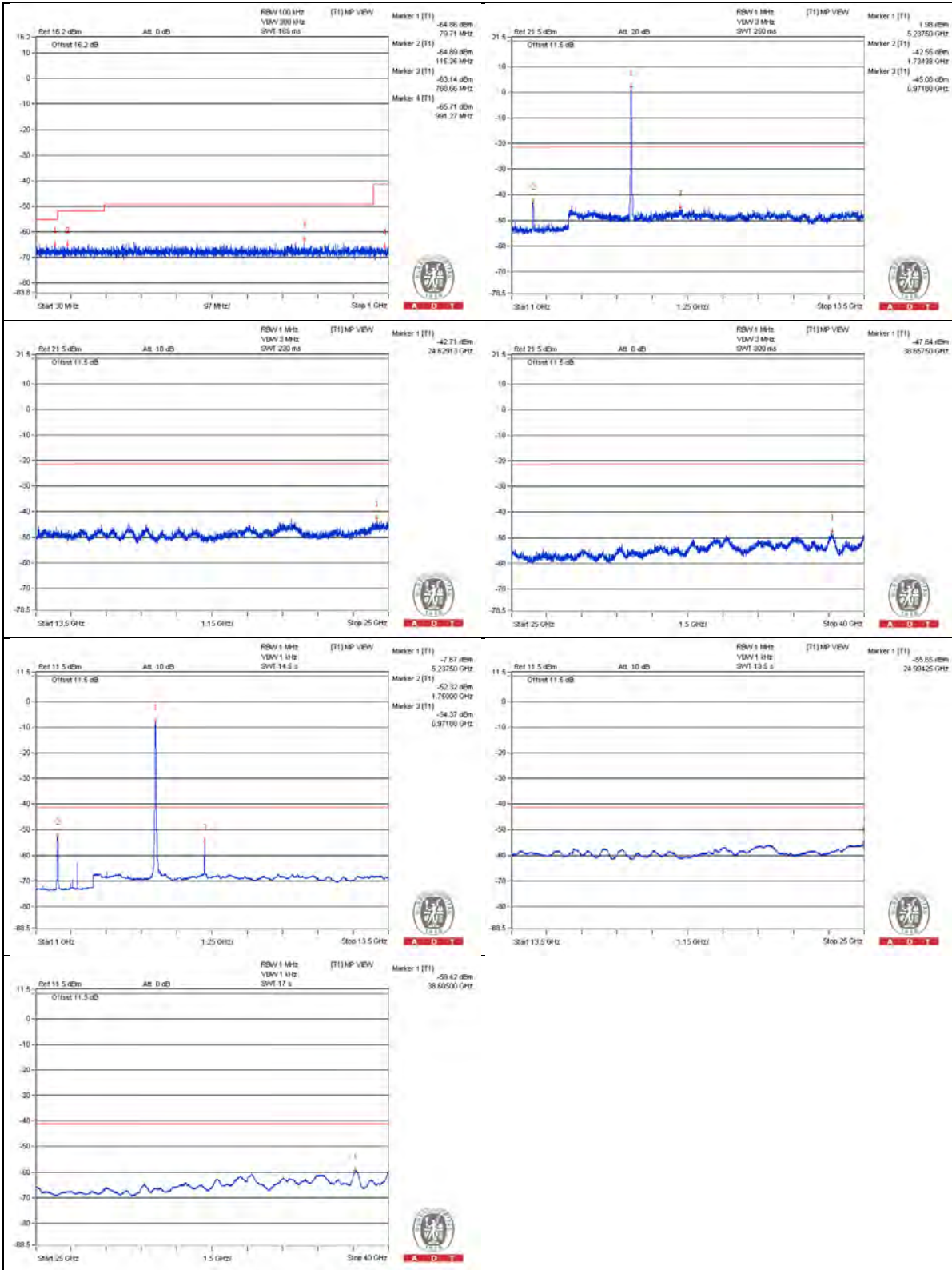

Bandedge table

No.	Frequency (MHz)	Emission Level (dBuV/m)	Limit (dBuV/m)	Margin (dB)	Raw Value (dBm)	Correction Factor (dB)	EIRP Level (dBm)
1	5143.75 PK	50.95	74	-23.05	-47.39	3.08	-44.31
2	5147.55 AV	38.47	54	-15.53	-59.87	3.08	-56.79

Note :
 Emission Level (dBuV/m) = EIRP Level (dBm) – 20log(d) + 104.8
 d = measurement distance in 3 meters.

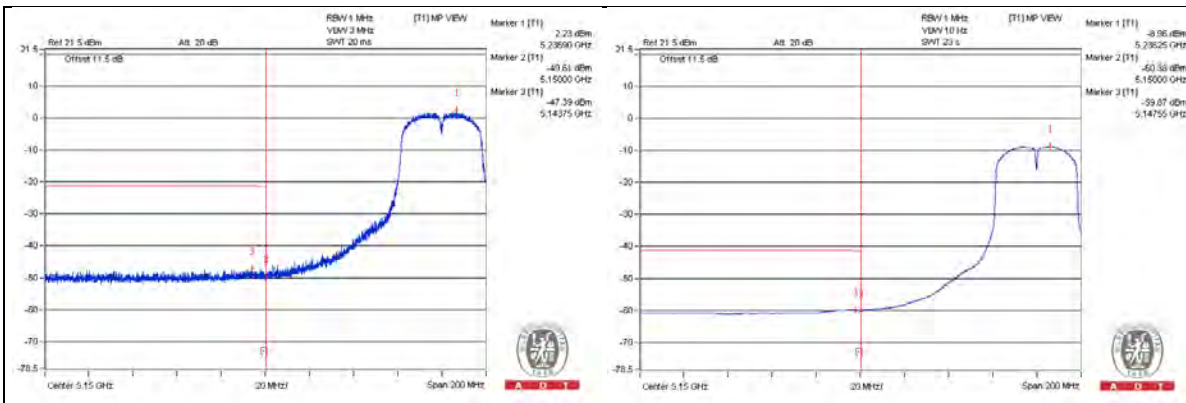

802.11n (HT40) - Channel 54
Conducted spurious emission table

No.	Frequency (MHz)	Emission Level (dBuV/m)	Limit (dBuV/m)	Margin (dB)	Raw Value (dBm)	Correction Factor (dB)	EIRP Level (dBm)
1	3512.5 PK	50.57	74	-23.43	-47.77	3.08	-44.69
2	3512.5 AV	30.41	54	-23.59	-67.93	3.08	-64.85
3	7021.875 PK	51.6	74	-22.4	-46.74	3.08	-43.66
4	7028.125 AV	40.03	54	-13.97	-58.31	3.08	-55.23
5	10537.5 PK	50.37	74	-23.63	-47.97	3.08	-44.89
6	10534.375 AV	29.8	54	-24.2	-68.54	3.08	-65.46
7	15817.25 PK	49.46	74	-24.54	-48.88	3.08	-45.8
8	15805.75 AV	38.54	54	-15.46	-59.8	3.08	-56.72

Note :

Emission Level (dBuV/m) = EIRP Level (dBm) – 20log(d) + 104.8

d = measurement distance in 3 meters.

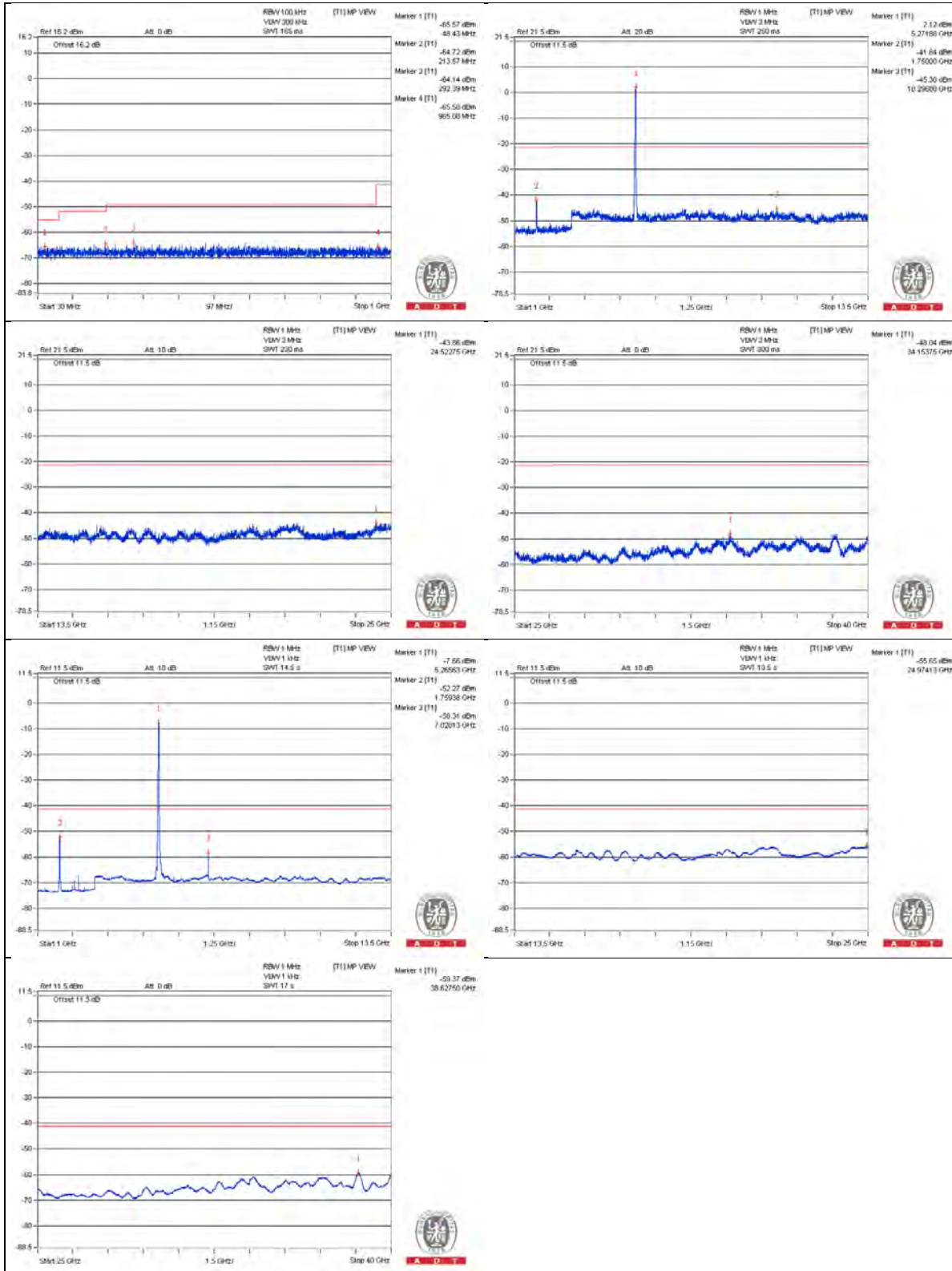

Bandedge table

No.	Frequency (MHz)	Emission Level (dBuV/m)	Limit (dBuV/m)	Margin (dB)	Raw Value (dBm)	Correction Factor (dB)	EIRP Level (dBm)
1	5141 PK	50.76	74	-23.24	-47.58	3.08	-44.5
2	5052.45 AV	37.53	54	-16.47	-60.81	3.08	-57.73

Note :
 Emission Level (dBuV/m) = EIRP Level (dBm) – 20log(d) + 104.8
 d = measurement distance in 3 meters.

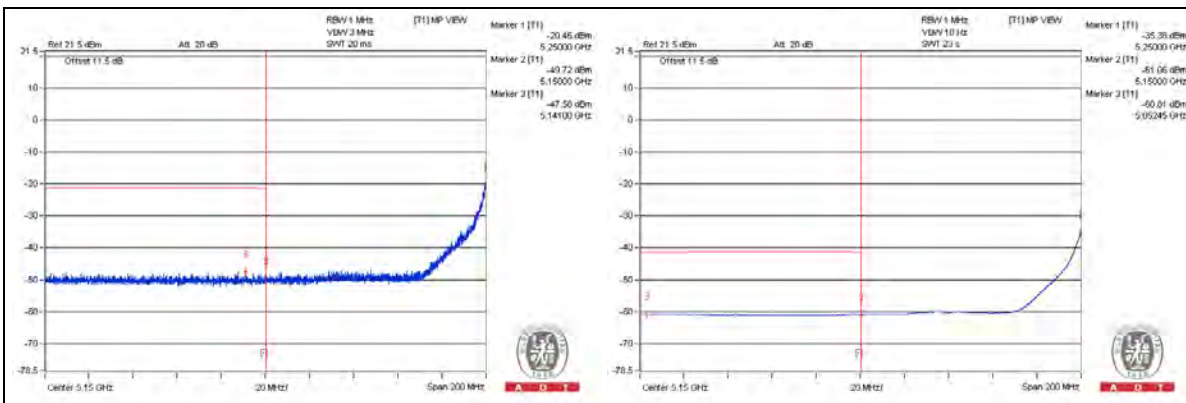

802.11n (HT40) - Channel 62
Conducted spurious emission table

No.	Frequency (MHz)	Emission Level (dBuV/m)	Limit (dBuV/m)	Margin (dB)	Raw Value (dBm)	Correction Factor (dB)	EIRP Level (dBm)
1	3531.25 PK	51.93	74	-22.07	-46.41	3.08	-43.33
2	3537.5 AV	30.73	54	-23.27	-67.61	3.08	-64.53
3	7071.875 PK	50.09	74	-23.91	-48.25	3.08	-45.17
4	7081.25 AV	34.91	54	-19.09	-63.43	3.08	-60.35
5	10612.5 PK	51.15	74	-22.85	-47.19	3.08	-44.11
6	10621.875 AV	30.04	54	-23.96	-68.3	3.08	-65.22
7	15932.25 PK	50.3	74	-23.7	-48.04	3.08	-44.96
8	15926.5 AV	39.71	54	-14.29	-58.63	3.08	-55.55

Note :

Emission Level (dBuV/m) = EIRP Level (dBm) – 20log(d) + 104.8

d = measurement distance in 3 meters.

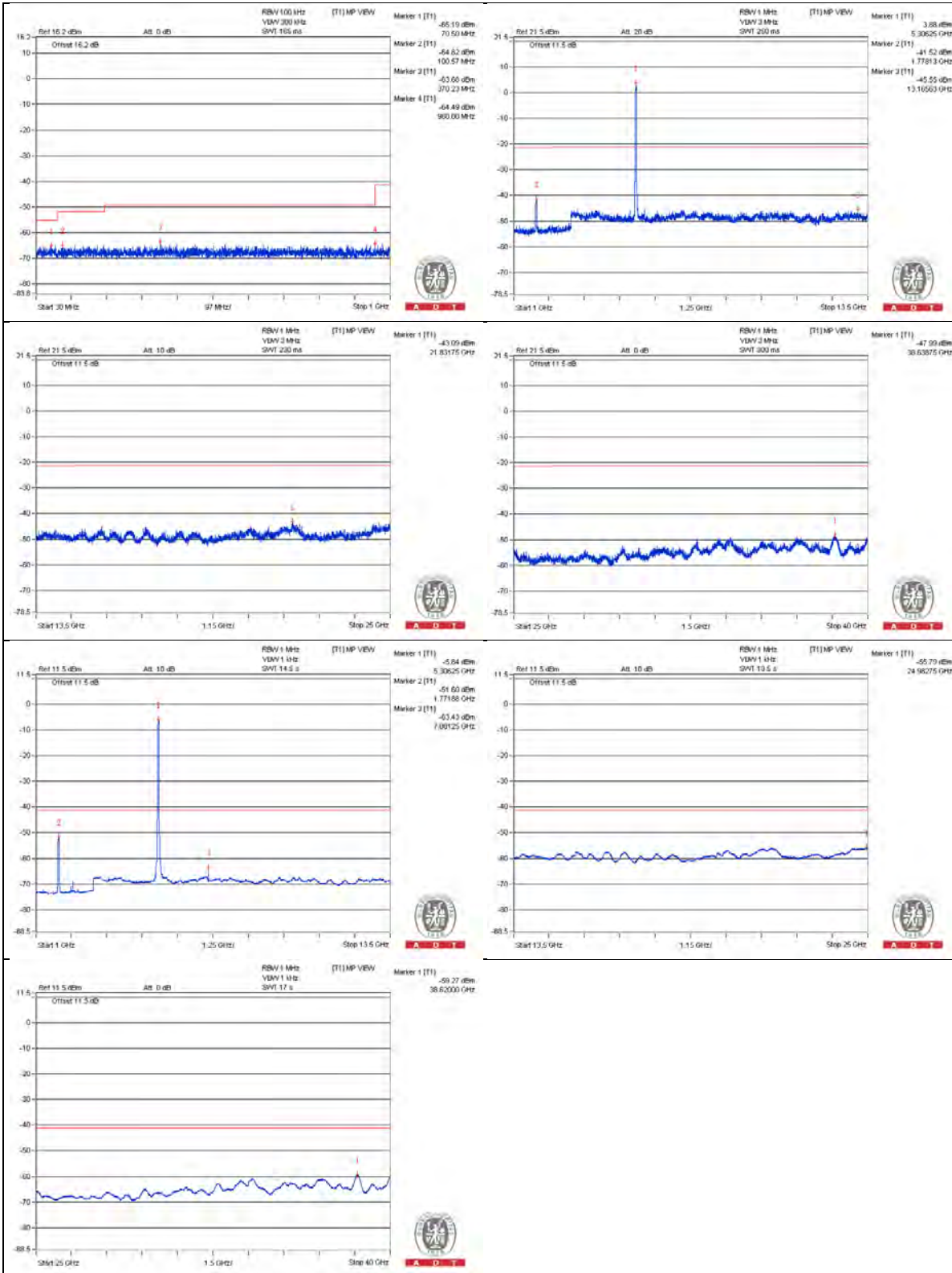

Bandedge table

No.	Frequency (MHz)	Emission Level (dBuV/m)	Limit (dBuV/m)	Margin (dB)	Raw Value (dBm)	Correction Factor (dB)	EIRP Level (dBm)
1	5350.5 PK	55.92	74	-18.08	-42.42	3.08	-39.34
2	5350 AV	43.19	54	-10.81	-55.15	3.08	-52.07

Note :

$$\text{Emission Level (dBuV/m)} = \text{EIRP Level (dBm)} - 20\log(d) + 104.8$$

d = measurement distance in 3 meters.

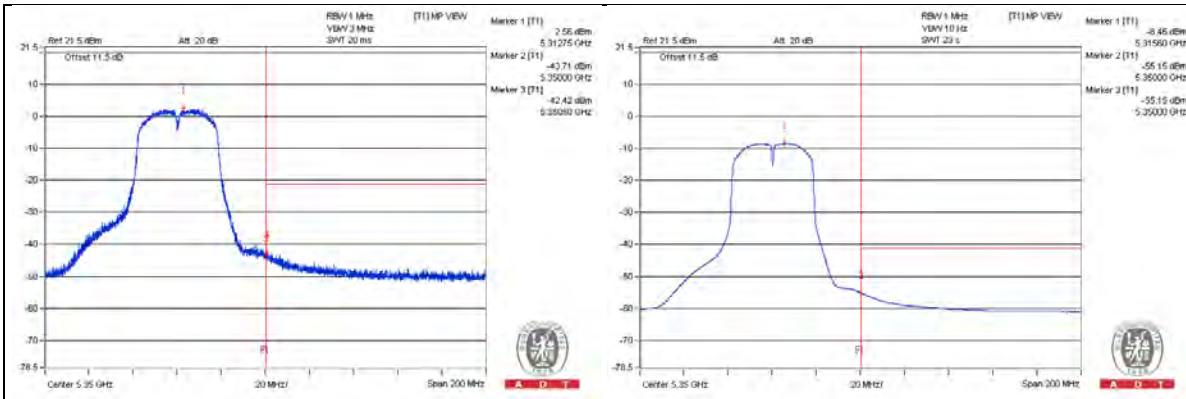

802.11n (HT40) - Channel 102**Conducted spurious emission table**

No.	Frequency (MHz)	Emission Level (dBuV/m)	Limit (dBuV/m)	Margin (dB)	Raw Value (dBm)	Correction Factor (dB)	EIRP Level (dBm)
1	3675 PK	53.7	74	-20.3	-46.32	4.76	-41.56
2	3671.875 AV	32.57	54	-21.43	-67.45	4.76	-62.69
3	7340.625 PK	52.59	74	-21.41	-47.43	4.76	-42.67
4	7346.875 AV	31.93	54	-22.07	-68.09	4.76	-63.33
5	11021.875 PK	50.74	74	-23.26	-49.28	4.76	-44.52
6	11012.5 AV	31.78	54	-22.22	-68.24	4.76	-63.48
7	16530.25 PK	53.37	74	-20.63	-46.65	4.76	-41.89
8	16533.125 AV	42.4	54	-11.6	-57.62	4.76	-52.86

Note :

Emission Level (dBuV/m) = EIRP Level (dBm) – 20log(d) + 104.8
d = measurement distance in 3 meters.

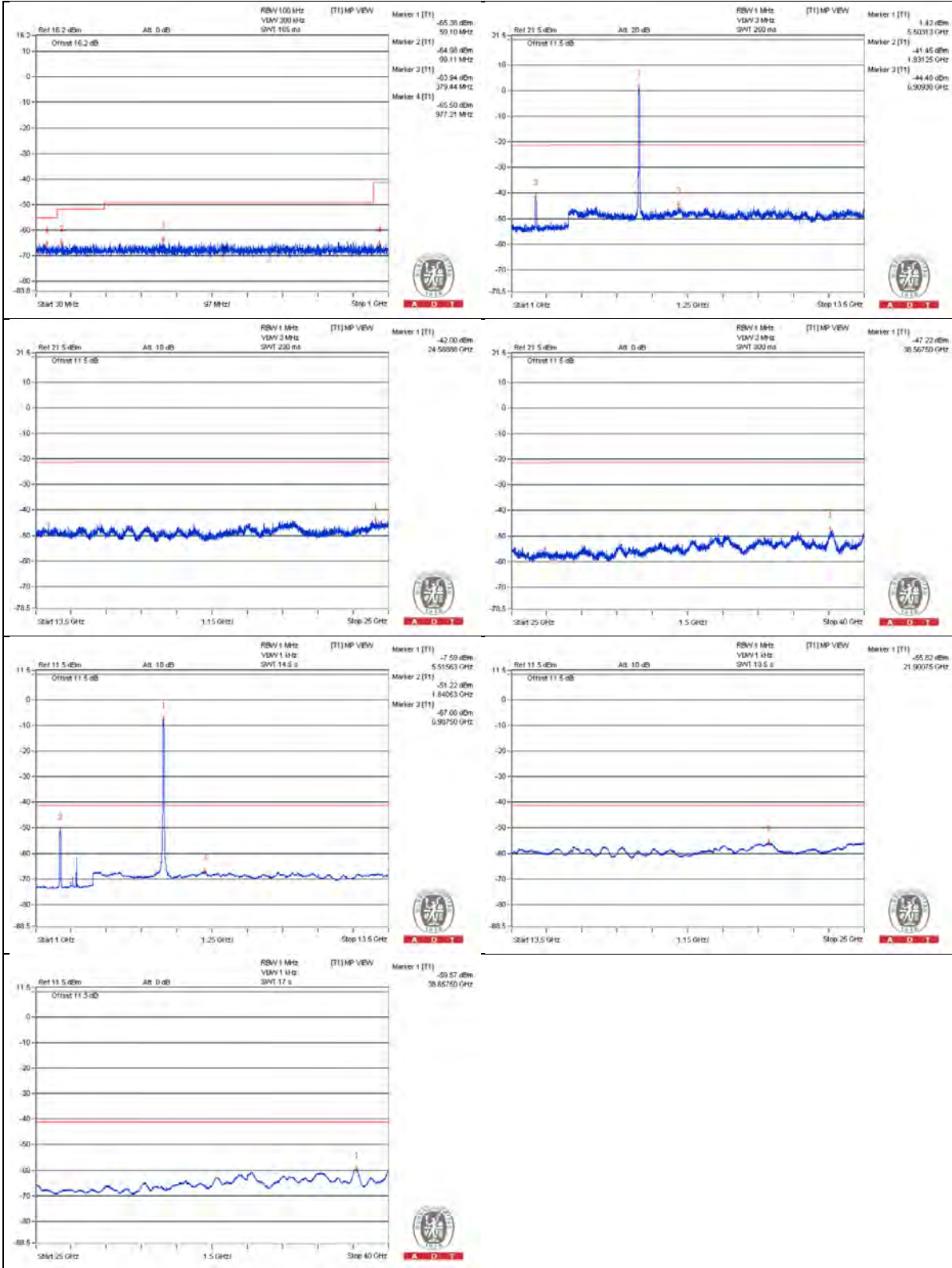

Bandedge table

No.	Frequency (MHz)	Emission Level (dBUV/m)	Limit (dBUV/m)	Margin (dB)	Raw Value (dBm)	Correction Factor (dB)	EIRP Level (dBm)
1	5469.31 PK	58.2	74	-15.8	-41.82	4.76	-37.06
2	5469.87 AV	45.18	54	-8.82	-54.84	4.76	-50.08

Note :

$$\text{Emission Level (dBUV/m)} = \text{EIRP Level (dBm)} - 20\log(d) + 104.8$$

d = measurement distance in 3 meters.

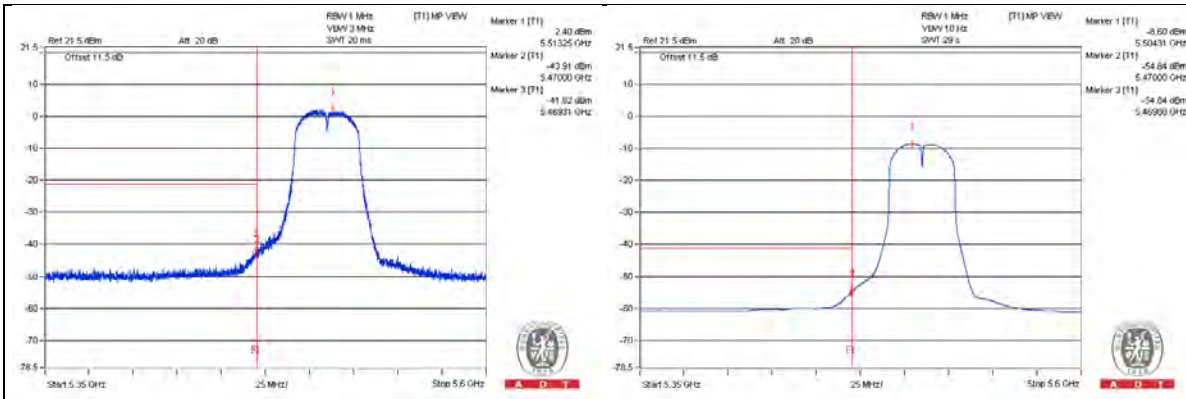

802.11n (HT40) - Channel 118
Conducted spurious emission table

No.	Frequency (MHz)	Emission Level (dBuV/m)	Limit (dBuV/m)	Margin (dB)	Raw Value (dBm)	Correction Factor (dB)	EIRP Level (dBm)
1	3718.75 PK	52.76	74	-21.24	-47.26	4.76	-42.5
2	3725 AV	32.33	54	-21.67	-67.69	4.76	-62.93
3	7443.75 PK	52.4	74	-21.6	-47.62	4.76	-42.86
4	7453.125 AV	33.06	54	-20.94	-66.96	4.76	-62.2
5	11184.375 PK	51.91	74	-22.09	-48.11	4.76	-43.35
6	11171.875 AV	31.51	54	-22.49	-68.51	4.76	-63.75
7	16774.625 PK	50.15	74	-23.85	-49.87	4.76	-45.11
8	16777.5 AV	39.18	54	-14.82	-60.84	4.76	-56.08

Note :

Emission Level (dBuV/m) = EIRP Level (dBm) – 20log(d) + 104.8

d = measurement distance in 3 meters.

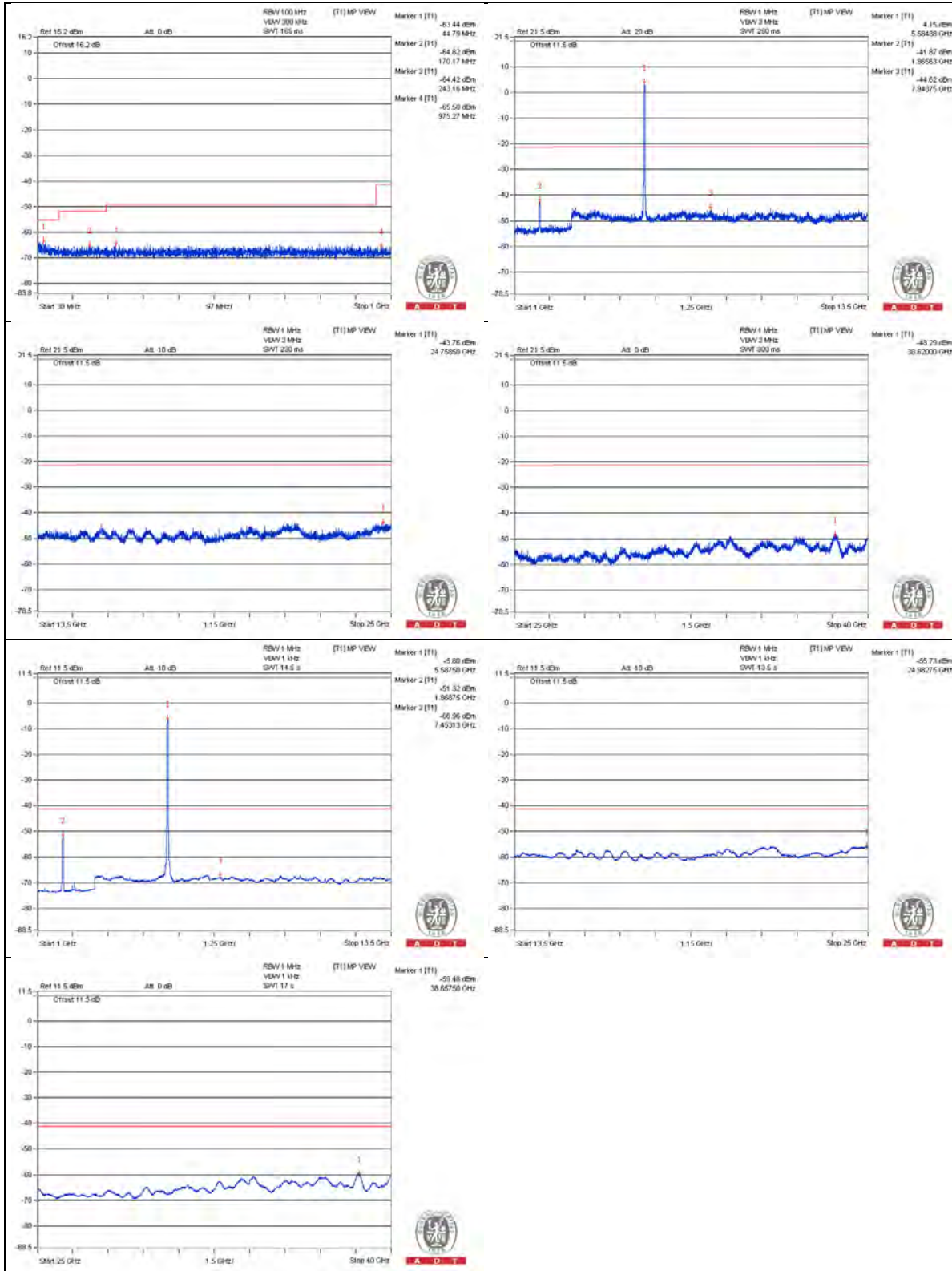

Bandedge table

No.	Frequency (MHz)	Emission Level (dBuV/m)	Limit (dBuV/m)	Margin (dB)	Raw Value (dBm)	Correction Factor (dB)	EIRP Level (dBm)
1	5426.75 PK	52.45	74	-21.55	-47.57	4.76	-42.81
2	5354.37 AV	39.27	54	-14.73	-60.75	4.76	-55.99

Note :
 Emission Level (dBuV/m) = EIRP Level (dBm) – 20log(d) + 104.8
 d = measurement distance in 3 meters.

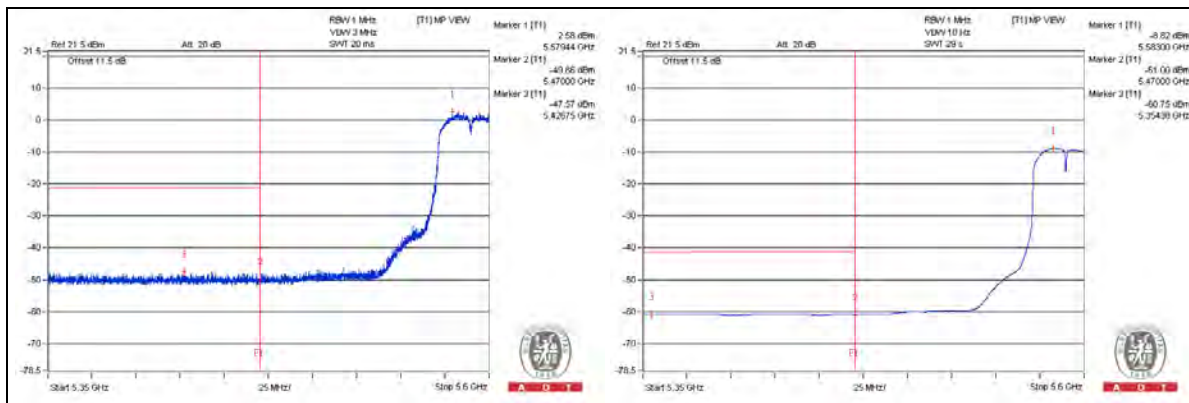

802.11n (HT40) - Channel 134
Conducted spurious emission table

No.	Frequency (MHz)	Emission Level (dBuV/m)	Limit (dBuV/m)	Margin (dB)	Raw Value (dBm)	Correction Factor (dB)	EIRP Level (dBm)
1	3771.875 PK	52.67	74	-21.33	-47.35	4.76	-42.59
2	3784.375 AV	32.27	54	-21.73	-67.75	4.76	-62.99
3	7550 PK	52.06	74	-21.94	-47.96	4.76	-43.2
4	7559.375 AV	32.39	54	-21.61	-67.63	4.76	-62.87
5	11346.875 PK	52.73	74	-21.27	-47.29	4.76	-42.53
6	11350 AV	32.12	54	-21.88	-67.9	4.76	-63.14
7	17010.375 PK	54.05	74	-19.95	-45.97	4.76	-41.21
8	17010.375 AV	42.03	54	-11.97	-57.99	4.76	-53.23

Note :

Emission Level (dBuV/m) = EIRP Level (dBm) – 20log(d) + 104.8

d = measurement distance in 3 meters.

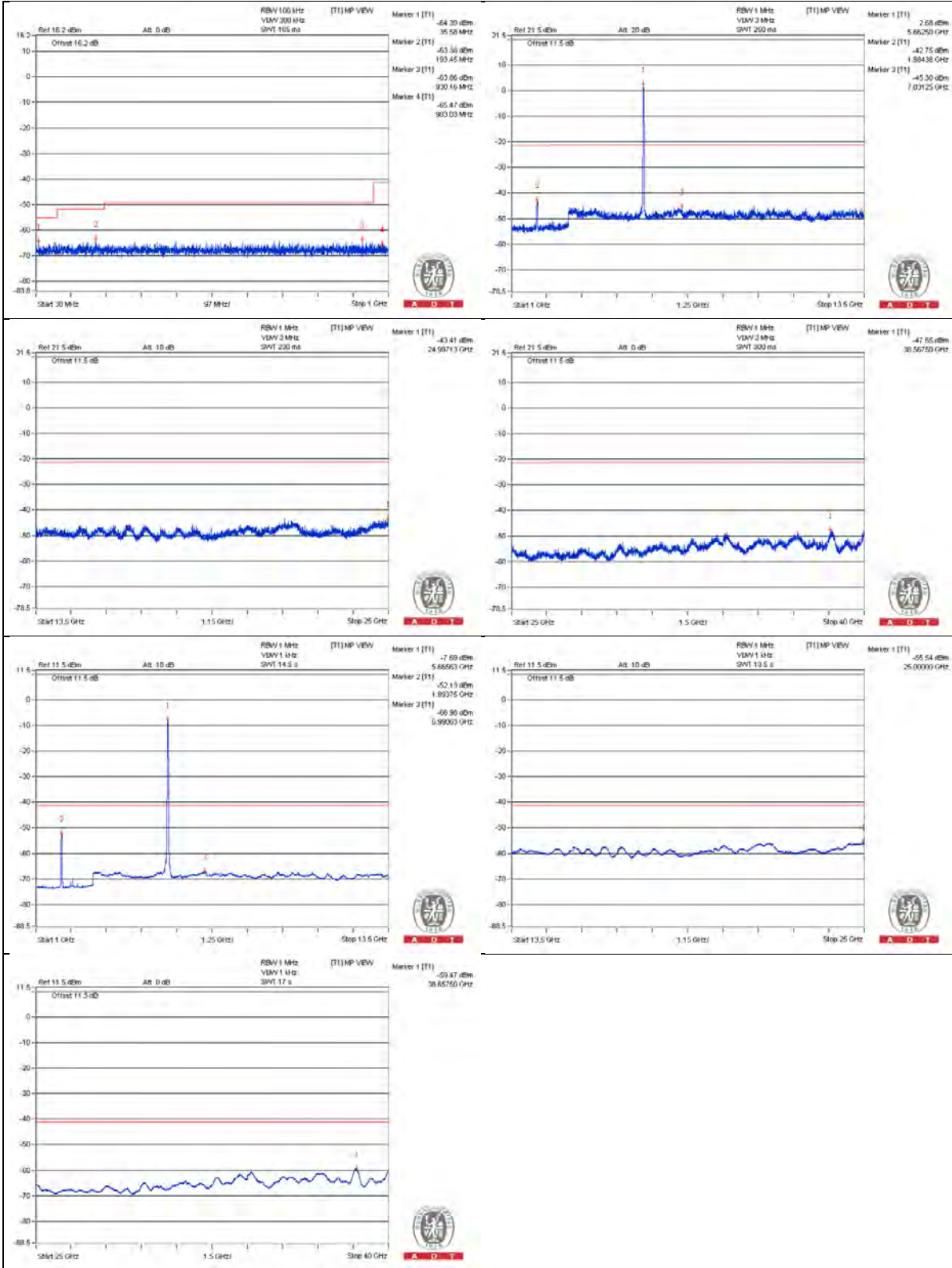

Bandedge table

No.	Frequency (MHz)	Emission Level (dBuV/m)	Limit (dBuV/m)	Margin (dB)	Raw Value (dBm)	Correction Factor (dB)	EIRP Level (dBm)
1	5726.3 PK	52.65	74	-21.35	-47.37	4.76	-42.61
2	5725 AV	40.12	54	-13.88	-59.9	4.76	-55.14

Note :

$$\text{Emission Level (dBuV/m)} = \text{EIRP Level (dBm)} - 20\log(d) + 104.8$$

d = measurement distance in 3 meters.

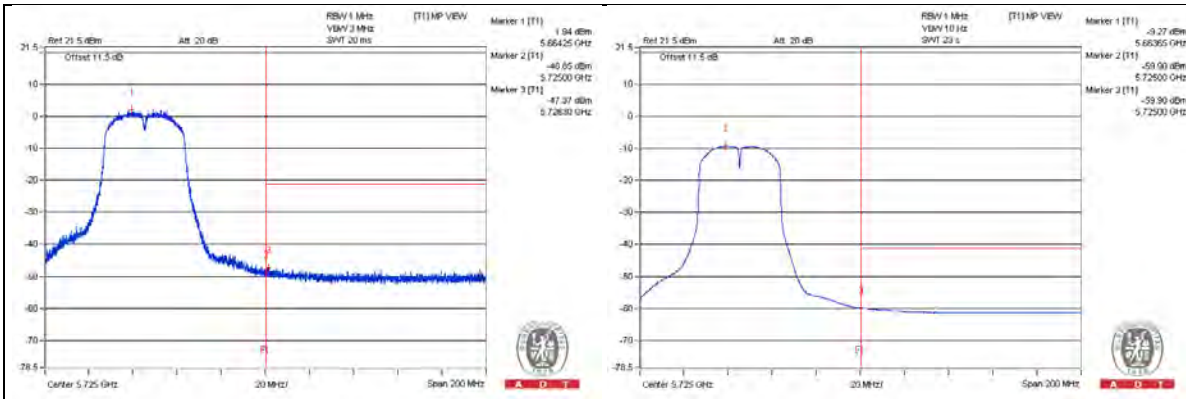

802.11n (HT40) - Channel 142
Conducted spurious emission table

No.	Frequency (MHz)	Emission Level (dBuV/m)	Limit (dBuV/m)	Margin (dB)	Raw Value (dBm)	Correction Factor (dB)	EIRP Level (dBm)
1	3803.125 PK	53.32	74	-20.68	-46.7	4.76	-41.94
2	3806.25 AV	32.16	54	-21.84	-67.86	4.76	-63.1
3	7615.625 PK	52.04	74	-21.96	-47.98	4.76	-43.22
4	7612.5 AV	32.44	54	-21.56	-67.58	4.76	-62.82
5	11421.875 PK	53.35	74	-20.65	-46.67	4.76	-41.91
6	11428.125 AV	32.12	54	-21.88	-67.9	4.76	-63.14
7	17122.5 PK	53.72	74	-20.28	-46.3	4.76	-41.54
8	17128.25 AV	42.18	54	-11.82	-57.84	4.76	-53.08

Note :

Emission Level (dBuV/m) = EIRP Level (dBm) – 20log(d) + 104.8

d = measurement distance in 3 meters.

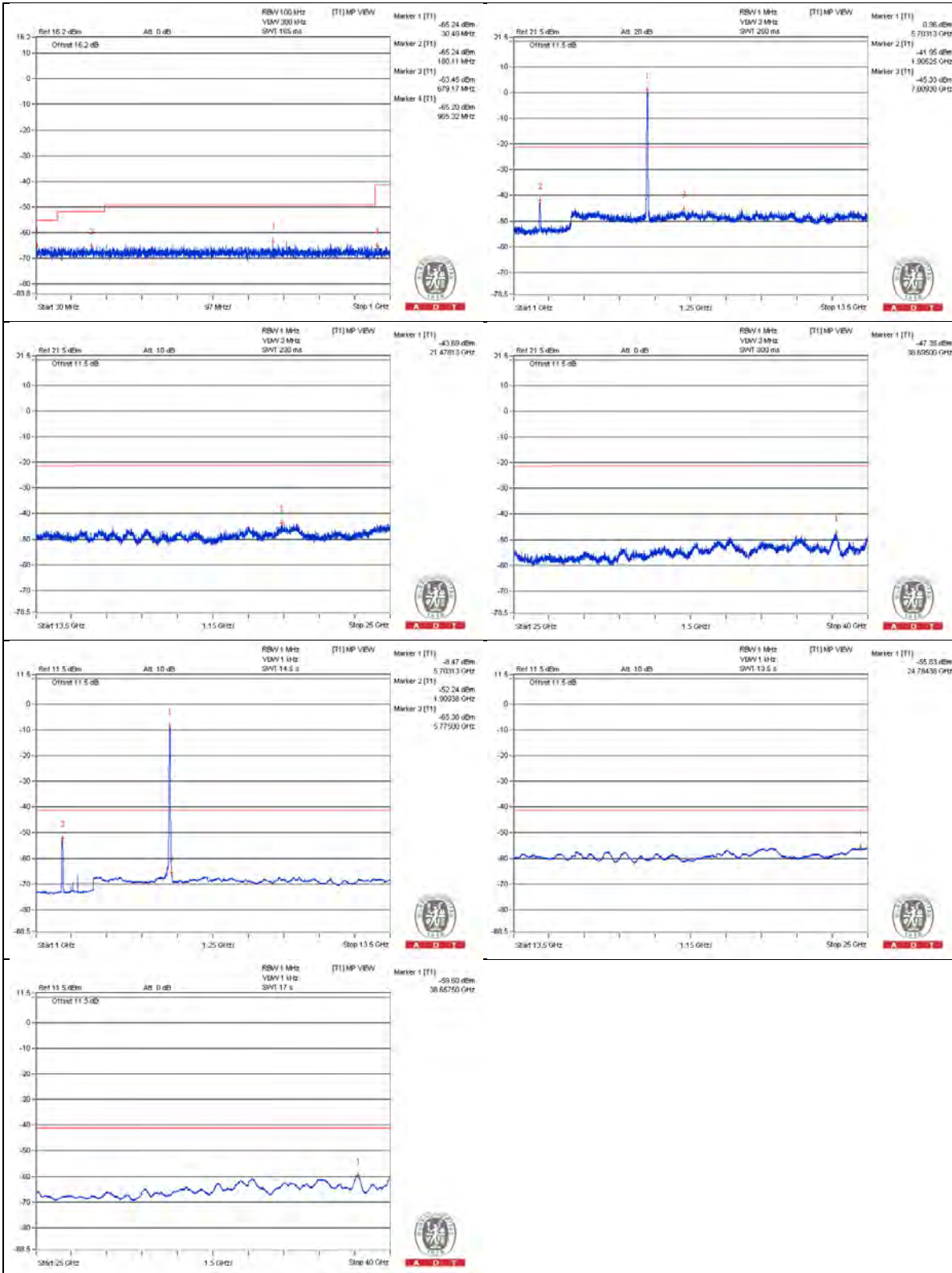

Bandedge table

No.	Frequency (MHz)	Emission Level (dBuV/m)	Limit (dBuV/m)	Margin (dB)	Raw Value (dBm)	Correction Factor (dB)	EIRP Level (dBm)
1	5888.43 PK	51.84	74	-22.16	-48.18	4.76	-43.42
2	5866.3 AV	38.93	54	-15.07	-61.09	4.76	-56.33

Note :

$$\text{Emission Level (dBuV/m)} = \text{EIRP Level (dBm)} - 20\log(d) + 104.8$$

d = measurement distance in 3 meters.

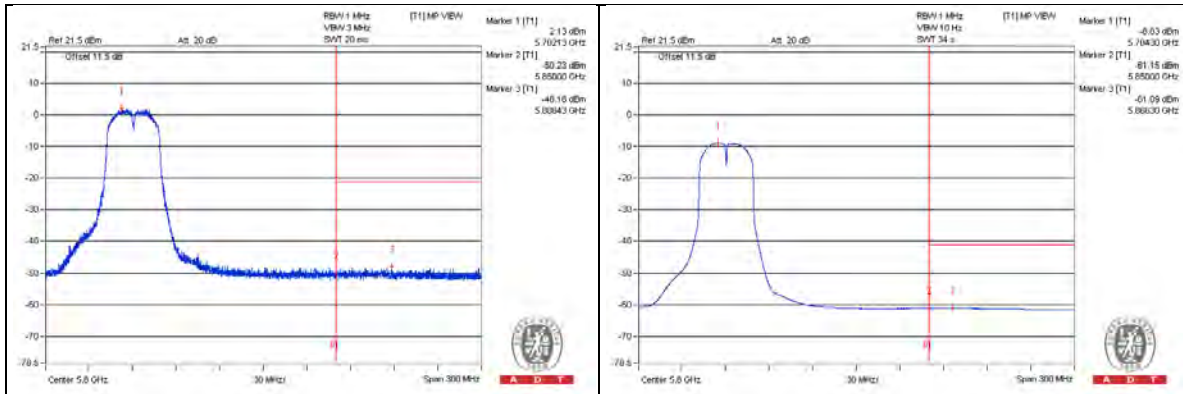

802.11n (HT40) - Channel 151
Conducted spurious emission table

No.	Frequency (MHz)	Emission Level (dBuV/m)	Limit (dBuV/m)	Margin (dB)	Raw Value (dBm)	Correction Factor (dB)	EIRP Level (dBm)
1	3828.125 PK	54.43	74	-19.57	-45.59	4.76	-40.83
2	3843.75 AV	32.43	54	-21.57	-67.59	4.76	-62.83
3	7678.125 PK	52.17	74	-21.83	-47.85	4.76	-43.09
4	7675 AV	31.99	54	-22.01	-68.03	4.76	-63.27
5	11512.5 PK	51.57	74	-22.43	-48.45	4.76	-43.69
6	11500 AV	31.21	54	-22.79	-68.81	4.76	-64.05
7	17269.125 PK	51.63	74	-22.37	-48.39	4.76	-43.63
8	17266.25 AV	40.47	54	-13.53	-59.55	4.76	-54.79

Note :

Emission Level (dBuV/m) = EIRP Level (dBm) – 20log(d) + 104.8
d = measurement distance in 3 meters.

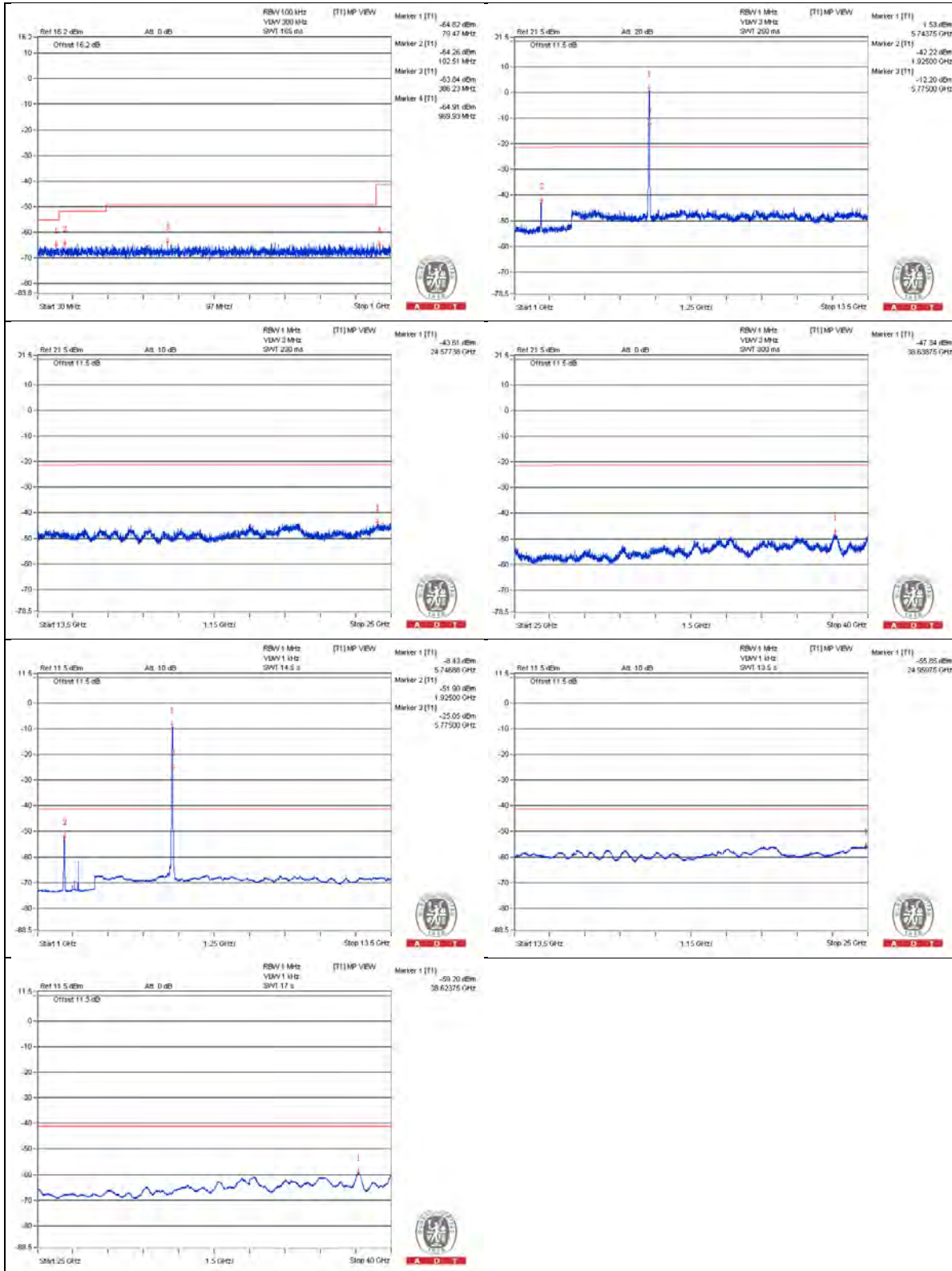

Bandedge table

No.	Frequency (MHz)	Emission Level (dBuV/m)	Limit (dBuV/m)	Margin (dB)	Raw Value (dBm)	Correction Factor (dB)	EIRP Level (dBm)
1	5714.6 PK	59.62	74	-14.38	-40.4	4.76	-35.64
2	5715 AV	46.13	54	-7.87	-53.89	4.76	-49.13
3	5723.37 PK	64.61	78.2	-13.59	-35.41	4.76	-30.65
4	5859.73 PK	51.56	78.2	-26.64	-48.46	4.76	-43.7
5	5937.5 PK	49.52	74	-24.48	-50.5	4.76	-45.74
6	5861.23 AV	38.9	54	-15.1	-61.12	4.76	-56.36

Note :

$$\text{Emission Level (dBuV/m)} = \text{EIRP Level (dBm)} - 20\log(d) + 104.8$$

d = measurement distance in 3 meters.

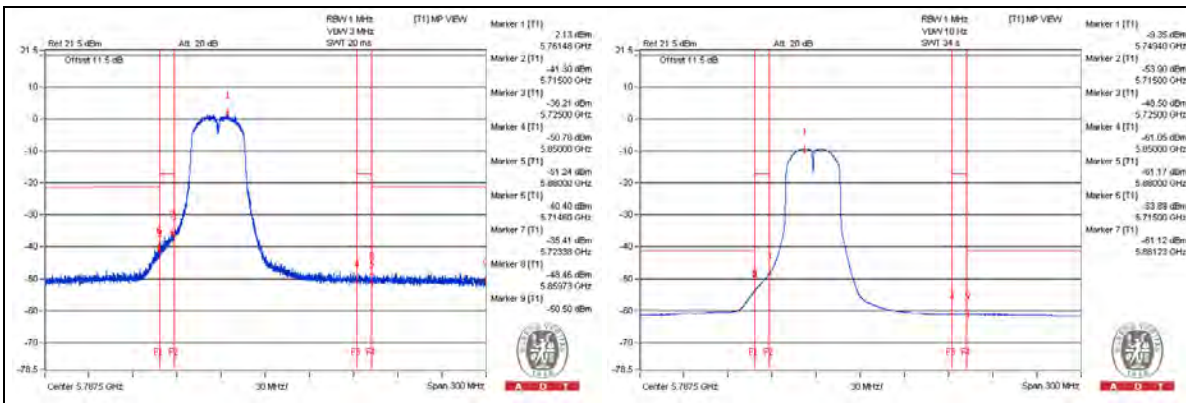

802.11n (HT40) - Channel 159
Conducted spurious emission table

No.	Frequency (MHz)	Emission Level (dBuV/m)	Limit (dBuV/m)	Margin (dB)	Raw Value (dBm)	Correction Factor (dB)	EIRP Level (dBm)
1	3856.25 PK	52.43	74	-21.57	-47.59	4.76	-42.83
2	3865.625 AV	32.24	54	-21.76	-67.78	4.76	-63.02
3	7721.875 PK	52.16	74	-21.84	-47.86	4.76	-43.1
4	7734.375 AV	31.68	54	-22.32	-68.34	4.76	-63.58
5	11593.75 PK	50.46	74	-23.54	-49.56	4.76	-44.8
6	11587.5 AV	30.44	54	-23.56	-69.58	4.76	-64.82
7	17381.25 PK	50.16	74	-23.84	-49.86	4.76	-45.1
8	17387 AV	39.27	54	-14.73	-60.75	4.76	-55.99

Note :

Emission Level (dBuV/m) = EIRP Level (dBm) – 20log(d) + 104.8
d = measurement distance in 3 meters.

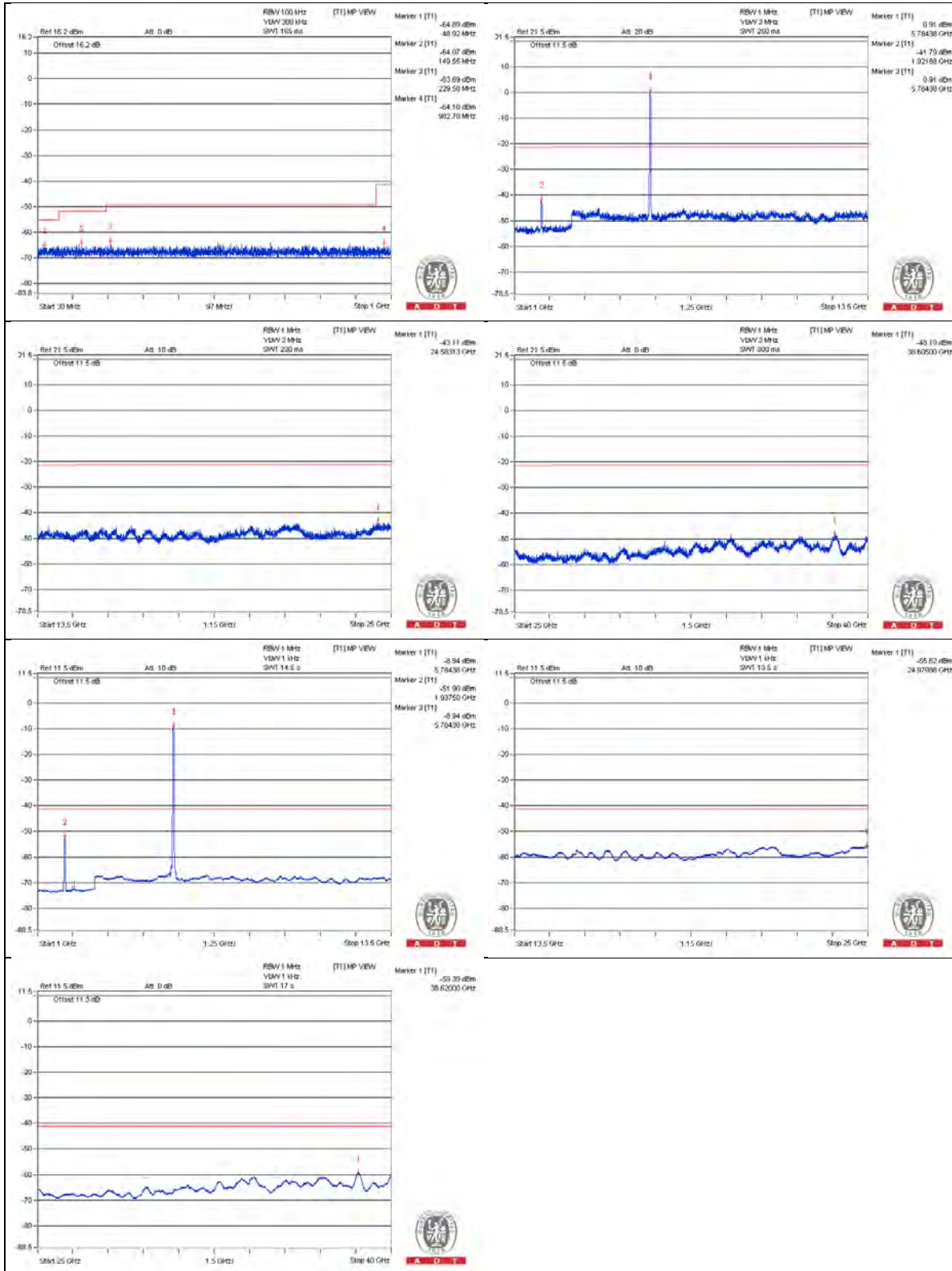

Bandedge table

No.	Frequency (MHz)	Emission Level (dBuV/m)	Limit (dBuV/m)	Margin (dB)	Raw Value (dBm)	Correction Factor (dB)	EIRP Level (dBm)
1	5681.75 PK	52.55	74	-21.45	-47.47	4.76	-42.71
2	5710.93 AV	39.25	54	-14.75	-60.77	4.76	-56.01
3	5719.7 PK	52.55	78.2	-25.65	-47.47	4.76	-42.71
4	5854.1 PK	53.13	78.2	-25.07	-46.89	4.76	-42.13
5	5937.5 PK	49.36	74	-24.64	-50.66	4.76	-45.9
6	5860.25 AV	39.49	54	-14.51	-60.53	4.76	-55.77

Note :

$$\text{Emission Level (dBuV/m)} = \text{EIRP Level (dBm)} - 20\log(d) + 104.8$$

d = measurement distance in 3 meters.

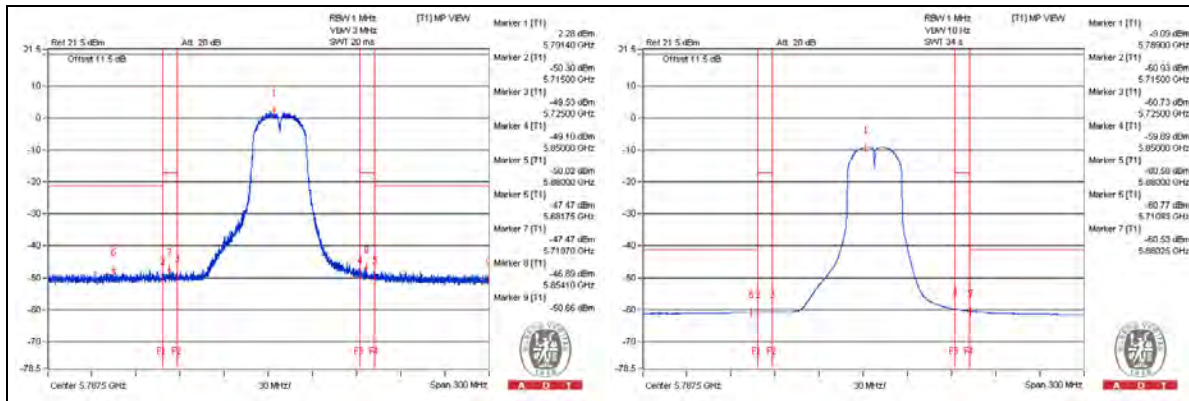

Below 1GHz Data
802.11a - Channel 52

Conducted spurious emission table

No.	Frequency (MHz)	Emission Level (dBuV/m)	Limit (dBuV/m)	Margin (dB)	Raw Value (dBm)	Correction Factor (dB)	EIRP Level (dBm)
1	841.1625	26.54	46	-19.46	-73.48	4.76	-68.72

Note :

Emission Level (dBuV/m) = EIRP Level (dBm) – 20log(d) + 104.8

d = measurement distance in 3 meters.

Emission levels include upper bound on ground plane reflection (4.7dB) for below 1GHz emission.

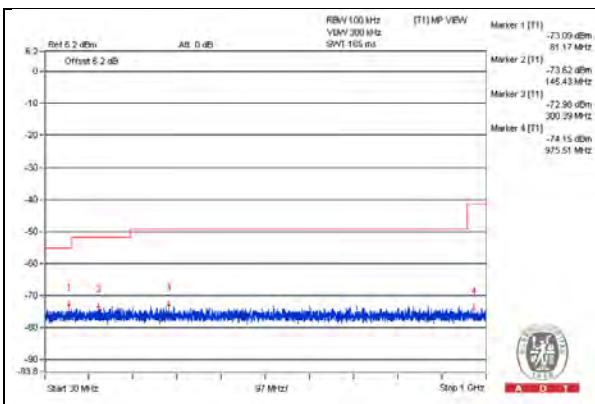

4.5 Frequency Stability Measurement

4.5.1 Limits of Frequency Stability Measurement

The frequency of the carrier signal shall be maintained within band of operation

4.5.2 Test Setup

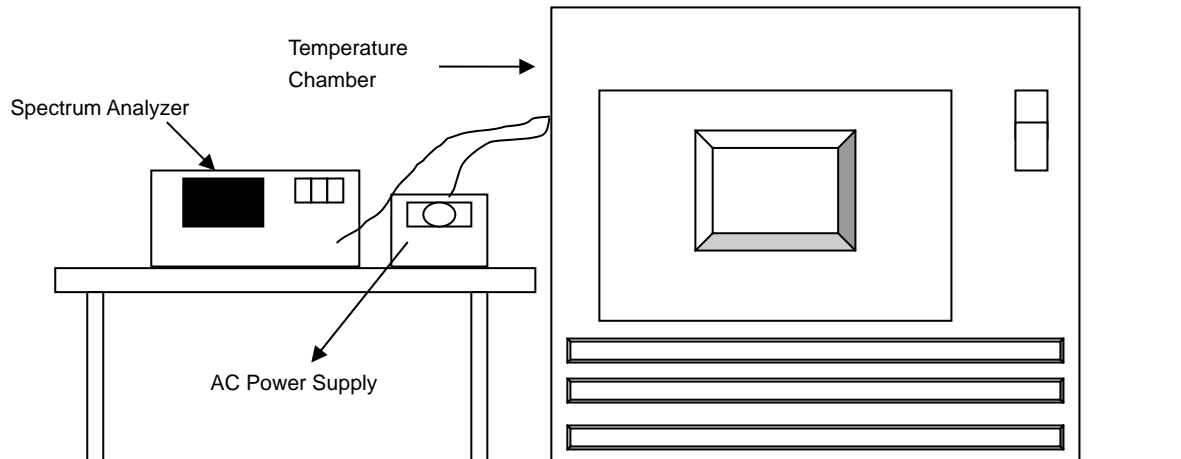

4.5.3 Test Instruments

DESCRIPTION & MANUFACTURER	MODEL NO.	SERIAL NO.	CALIBRATED DATE	CALIBRATED UNTIL
SPECTRUM ANALYZER R&S	FSP 40	100060	May 08, 2015	May 07, 2016
Temperature & Humidity Chamber GIANTFORCE	GTH-150-40-S P-AR	MAA0812-008	Jan. 12, 2015	Jan. 11, 2016

- NOTE:**
1. The test was performed in Oven room 2.
 2. The calibration interval of the above test instruments is 12 months and the calibrations are traceable to NML/ROC and NIST/USA.
 3. Tested Date: Nov. 16, 2015

4.5.4 Test Procedures

- a. The EUT was placed inside the environmental test chamber and powered by nominal AC voltage.
- b. Turn the EUT on and couple its output to a spectrum analyzer.
- c. Turn the EUT off and set the chamber to the highest temperature specified.
- d. Allow sufficient time (approximately 30 min) for the temperature of the chamber to stabilize, turn the EUT on and measure the operating frequency after 2, 5, and 10 minutes.
- e. Repeat step 2 and 3 with the temperature chamber set to the lowest temperature.
- f. The test chamber was allowed to stabilize at +20 degree C for a minimum of 30 minutes. The supply voltage was then adjusted on the EUT from 85% to 115% and the frequency record.

4.5.5 Deviation from Test Standard

No deviation.

4.5.6 EUT Operating Conditions

Set the EUT transmit at un-modulation mode to test frequency stability.

4.5.7 Test Results

Frequency Stability Versus Temp.									
Operating Frequency: 5180MHz									
Temp. (°C)	Power Supply (Vac)	0 Minute		2 Minute		5 Minute		10 Minute	
		Measured Frequency (MHz)	Frequency Drift (%)	Measured Frequency (MHz)	Frequency Drift (%)	Measured Frequency (MHz)	Frequency Drift (%)	Measured Frequency (MHz)	Frequency Drift (%)
50	120	5180.0245	0.00047	5180.0252	0.00049	5180.0249	0.00048	5180.024	0.00046
40	120	5180.0114	0.00022	5180.0141	0.00027	5180.0151	0.00029	5180.015	0.00029
30	120	5180.0018	0.00003	5180.0007	0.00001	5180.0027	0.00005	5180.0013	0.00003
20	120	5179.9809	-0.00037	5179.9828	-0.00033	5179.9819	-0.00035	5179.9825	-0.00034
10	120	5179.9946	-0.00010	5179.9939	-0.00012	5179.9902	-0.00019	5179.9908	-0.00018
0	120	5180.0143	0.00028	5180.0154	0.00030	5180.0131	0.00025	5180.0167	0.00032
-10	120	5180.0136	0.00026	5180.0099	0.00019	5180.0115	0.00022	5180.0099	0.00019
-20	120	5180.0029	0.00006	5180.002	0.00004	5180.0029	0.00006	5180.003	0.00006
-30	120	5180.0188	0.00036	5180.0221	0.00043	5180.022	0.00042	5180.0174	0.00034

Frequency Stability Versus Temp.									
Operating Frequency: 5180MHz									
Temp. (°C)	Power Supply (Vac)	0 Minute		2 Minute		5 Minute		10 Minute	
		Measured Frequency (MHz)	Frequency Drift (%)	Measured Frequency (MHz)	Frequency Drift (%)	Measured Frequency (MHz)	Frequency Drift (%)	Measured Frequency (MHz)	Frequency Drift (%)
20	138	5179.9807	-0.00037	5179.9837	-0.00031	5179.9817	-0.00035	5179.9815	-0.00036
	120	5179.9809	-0.00037	5179.9828	-0.00033	5179.9819	-0.00035	5179.9825	-0.00034
	102	5179.9804	-0.00038	5179.9818	-0.00035	5179.9815	-0.00036	5179.9825	-0.00034

4.6 Conducted Emission Measurement

4.6.1 Limits of Conducted Emission Measurement

Frequency (MHz)	Conducted Limit (dBuV)	
	Quasi-peak	Average
0.15 - 0.5	66 - 56	56 - 46
0.50 - 5.0	56	46
5.0 - 30.0	60	50

Note: 1. The lower limit shall apply at the transition frequencies.

2. The limit decreases in line with the logarithm of the frequency in the range of 0.15 to 0.50MHz.

4.6.2 Test Instruments

DESCRIPTION & MANUFACTURER	MODEL NO.	SERIAL NO.	CALIBRATED DATE	CALIBRATED UNTIL
Test Receiver R&S	ESCS 30	100375	May 06, 2015	May 05, 2016
Line-Impedance Stabilization Network (for EUT) SCHWARZBECK	NSLK-8127	8127-522	Sep. 01, 2015	Aug. 31, 2016
Line-Impedance Stabilization Network (for Peripheral) R&S	ENV216	100072	June 11, 2015	June 10, 2016
RF Cable	5D-FB	COCCAB-001	Mar. 09, 2015	Mar. 08, 2016
50 ohms Terminator	N/A	EMC-03	Sep. 23, 2015	Sep. 22, 2016
50 ohms Terminator	N/A	EMC-02	Oct. 01, 2015	Sep. 30, 2016
Software BVADT	BVADT_Cond_ V7.3.7.3	NA	NA	NA

Note:

1. The calibration interval of the above test instruments are 12 months and the calibrations are traceable to NML/ROC and NIST/USA.
2. The test was performed in Shielded Room No. C.
3. The VCCI Con C Registration No. is C-3611.
4. Tested Date: Nov. 19, 2015

4.6.3 Test Procedures

- a. The EUT was placed 0.4 meters from the conducting wall of the shielded room with EUT being connected to the power mains through a line impedance stabilization network (LISN). Other support units were connected to the power mains through another LISN. The two LISNs provide 50 ohm/ 50uH of coupling impedance for the measuring instrument.
- b. Both lines of the power mains connected to the EUT were checked for maximum conducted interference.
- c. The frequency range from 150kHz to 30MHz was searched. Emission levels under (Limit - 20dB) was not recorded.

NOTE: The resolution bandwidth and video bandwidth of test receiver is 9kHz for quasi-peak detection (QP) and average detection (AV) at frequency 0.15MHz-30MHz.

4.6.4 Deviation from Test Standard

No deviation.

4.6.5 Test Setup

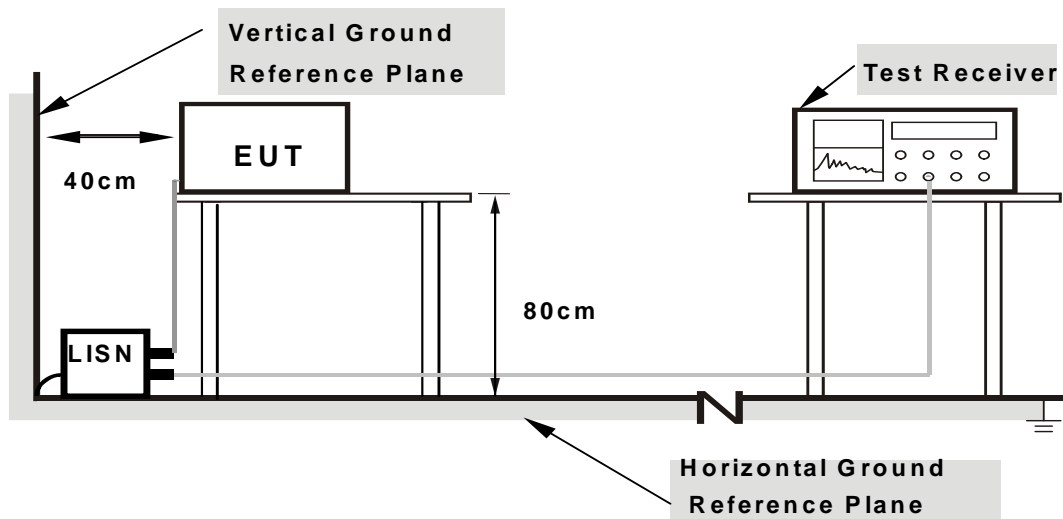

Note: 1.Support units were connected to second LISN.

For the actual test configuration, please refer to the attached file (Test Setup Photo).

4.6.6 EUT Operating Conditions

Same as 4.4.6.

4.6.7 Test Results

Phase	Line (L)	Detector Function	Quasi-Peak (QP) / Average (AV)
-------	----------	-------------------	--------------------------------

No	Frequency (MHz)	Correction Factor (dB)	Reading Value (dBuV)		Emission Level (dBuV)		Limit (dBuV)		Margin (dB)	
			Q.P.	AV.	Q.P.	AV.	Q.P.	AV.	Q.P.	AV.
1	0.15000	10.26	32.90	7.98	43.16	18.24	66.00	56.00	-22.84	-37.76
2	0.18944	10.23	44.58	33.86	54.81	44.09	64.06	54.06	-9.25	-9.97
3	0.25547	10.23	35.62	26.64	45.85	36.87	61.58	51.58	-15.73	-14.71
4	0.31797	10.23	29.64	22.90	39.87	33.13	59.76	49.76	-19.89	-16.63
5	0.50675	10.23	24.20	20.59	34.43	30.82	56.00	46.00	-21.57	-15.18
6	23.94922	10.97	13.05	7.07	24.02	18.04	60.00	50.00	-35.98	-31.96

Remarks:

1. Q.P. and AV. are abbreviations of quasi-peak and average individually.
2. The emission levels of other frequencies were very low against the limit.
3. Margin value = Emission level – Limit value
4. Correction factor = Insertion loss + Cable loss
5. Emission Level = Correction Factor + Reading Value

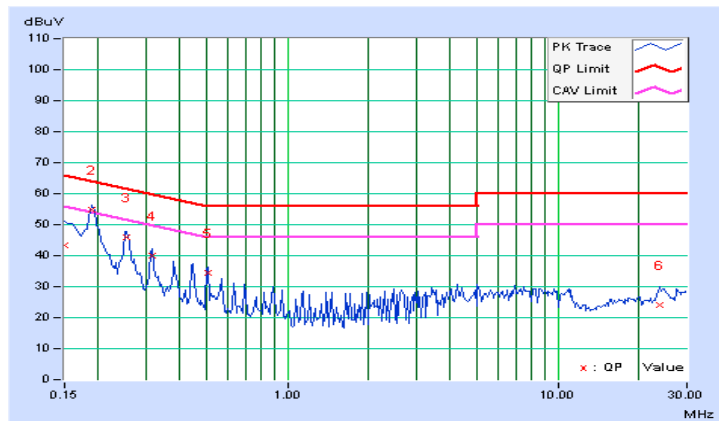

Phase	Neutral (N)	Detector Function	Quasi-Peak (QP) / Average (AV)
-------	-------------	-------------------	--------------------------------

No	Frequency (MHz)	Correction Factor (dB)	Reading Value (dBuV)		Emission Level (dBuV)		Limit (dBuV)		Margin (dB)	
			Q.P.	AV.	Q.P.	AV.	Q.P.	AV.	Q.P.	AV.
1	0.15000	10.24	32.76	7.92	43.00	18.16	66.00	56.00	-23.00	-37.84
2	0.18931	10.21	44.42	33.90	54.63	44.11	64.07	54.07	-9.44	-9.96
3	0.25369	10.21	36.07	27.20	46.28	37.41	61.64	51.64	-15.36	-14.23
4	0.31797	10.21	29.54	23.04	39.75	33.25	59.76	49.76	-20.01	-16.51
5	0.44297	10.22	26.26	24.05	36.48	34.27	57.01	47.01	-20.53	-12.74
6	23.30469	10.98	15.90	9.25	26.88	20.23	60.00	50.00	-33.12	-29.77

Remarks:

1. Q.P. and AV. are abbreviations of quasi-peak and average individually.
2. The emission levels of other frequencies were very low against the limit.
3. Margin value = Emission level – Limit value
4. Correction factor = Insertion loss + Cable loss
5. Emission Level = Correction Factor + Reading Value

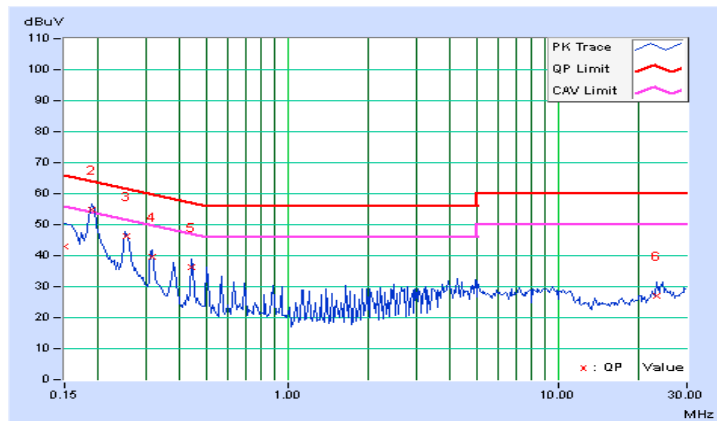

5 Pictures of Test Arrangements

Please refer to the attached file (Test Setup Photo).

6 Appendix B – Information on the Testing Laboratories

We, Bureau Veritas Consumer Products Services (H.K.) Ltd., Taoyuan Branch, were founded in 1988 to provide our best service in EMC, Radio, Telecom and Safety consultation. Our laboratories are accredited and approved according to ISO/IEC 17025.

If you have any comments, please feel free to contact us at the following:

Linko EMC/RF Lab

Tel: 886-2-26052180

Fax: 886-2-26051924

Hsin Chu EMC/RF Lab/Telecom Lab

Tel: 886-3-5935343

Fax: 886-3-5935342

Hwa Ya EMC/RF/Safety

Tel: 886-3-3183232

Fax: 886-3-3270892

Email: service.adt@tw.bureauveritas.com

Web Site: www.bureauveritas-adt.com

The address and road map of all our labs can be found in our web site also.

--- END ---