



A D T

## FCC Certification Test Report

**Report No.:** FC150706E06

**Test Model:** QCASP241

**Received Date:** July 06, 2015

**Test Date:** July 09 to 15, 2015

**Issued Date:** Nov. 16, 2015

**Applicant:** Qualcomm Atheros, Inc.

**Address:** 1700 Technology Drive, San Jose, CA 95110

**Issued By:** Bureau Veritas Consumer Products Services (H.K.) Ltd., Taoyuan Branch  
Hsin Chu Laboratory

**Lab Address:** No. 81-1, Lu Liao Keng, 9th Ling, Wu Lung Tsuen, Chiung Lin Hsiang, Hsin  
Chu Hsien 307, Taiwan R.O.C.

**Test Location (1):** No. 81-1, Lu Liao Keng, 9th Ling, Wu Lung Tsuen, Chiung Lin Hsiang, Hsin  
Chu Hsien 307, Taiwan R.O.C.

**Test Location (2):** No. 49, Ln. 206, Wende Rd., Shangshan Tsuen, Chiung Lin Hsiang, Hsin  
Chu Hsien 307, Taiwan R.O.C.



This report is for your exclusive use. Any copying or replication of this report to or for any other person or entity, or use of our name or trademark, is permitted only with our prior written permission. This report sets forth our findings solely with respect to the test samples identified herein. The results set forth in this report are not indicative or representative of the quality or characteristics of the lot from which a test sample was taken or any similar or identical product unless specifically and expressly noted. Our report includes all of the tests requested by you and the results thereof based upon the information that you provided to us. You have 60 days from date of issuance of this report to notify us of any material error or omission caused by our negligence, provided, however, that such notice shall be in writing and shall specifically address the issue you wish to raise. A failure to raise such issue within the prescribed time shall constitute your unqualified acceptance of the completeness of this report, the tests conducted and the correctness of the report contents. Unless specific mention, the uncertainty of measurement has been explicitly taken into account to declare the compliance or non-compliance to the specification. The report must not be used by the client to claim product certification, approval, or endorsement by TAF or any government agencies.

## Table of Contents

<b>Release Control Record</b> .....	<b>3</b>
<b>1 Certificate of Conformity</b> .....	<b>4</b>
<b>2 Summary of Test Results</b> .....	<b>5</b>
2.1 Measurement Uncertainty.....	5
2.2 Modification Record.....	5
<b>3 General Information</b> .....	<b>6</b>
3.1 Features of EUT.....	6
3.2 General Description of EUT.....	6
3.3 Description of Antenna.....	7
3.4 Operating Modes of EUT and Determination of Worst Case Operating Mode.....	8
3.5 Test Program Used and Operation Descriptions.....	8
3.6 Primary Clock Frequencies of Internal Source.....	8
3.7 Miscellaneous.....	9
<b>4 Configuration and Connections with EUT</b> .....	<b>10</b>
4.1 Connection Diagram of EUT and Peripheral Devices.....	10
4.2 Configuration of Peripheral Devices and Cable Connections.....	10
<b>5 Conducted Emissions at Mains Ports</b> .....	<b>11</b>
5.1 Limits.....	11
5.2 Test Instruments.....	11
5.3 Test Arrangement.....	12
5.4 Supplementary Information.....	12
5.5 Test Results.....	13
<b>6 Radiated Emissions up to 1 GHz</b> .....	<b>15</b>
6.1 Limits.....	15
6.2 Test Instruments.....	15
6.3 Test Arrangement.....	16
6.4 Supplementary Information.....	16
6.5 Test Results.....	17
<b>7 Radiated Emissions above 1 GHz</b> .....	<b>19</b>
7.1 Limits.....	19
7.2 Test Instruments.....	20
7.3 Test Arrangement.....	21
7.4 Supplementary Information.....	21
7.5 Test Results.....	22
<b>Appendix – Information on the Testing Laboratories</b> .....	<b>24</b>



A D T

### Release Control Record

Issue No.	Description	Date Issued
FC150706E06	Original release.	Nov. 16, 2015



## 1 Certificate of Conformity

**Product:** Low-Energy WiFi Single-Band 802.11b/g/n

**Brand:** Qualcomm Atheros

**Test Model:** QCASP241

**Sample Status:** R&D SAMPLE

**Applicant:** Qualcomm Atheros, Inc.

**Test Date:** July 09 to 15, 2015

**Standards:** 47 CFR FCC Part 15, Subpart B, Class B  
ICES-003:2012 Issue 5, Class B  
ANSI C63.4:2014

The above equipment has been tested by **Bureau Veritas Consumer Products Services (H.K.) Ltd., Taoyuan Branch**, and found compliance with the requirement of the above standards. The test record, data evaluation & Equipment Under Test (EUT) configurations represented herein are true and accurate accounts of the measurements of the sample's EMC characteristics under the conditions specified in this report.

**Prepared by :**  , **Date:** Nov. 16, 2015  
Lori Chung / Specialist

**Approved by :**  , **Date:** Nov. 16, 2015  
Ken Lu / Manager

## 2 Summary of Test Results

47 CFR FCC Part 15, Subpart B / ICES-003:2012 Issue 5, Class B

ANSI C63.4:2014

FCC Clause	ICES-003 Clause	Test Item	Result/Remarks	Verdict
15.107	6.1	AC Power Line Conducted Emissions	Minimum passing Class B margin is -18.91 dB at 0.15391 MHz	Pass
15.109	6.2.1	Radiated Emissions up to 1 GHz	Minimum passing Class B margin is -3.36 dB at 143.54 MHz	Pass
	6.2.2	Radiated Emissions above 1 GHz	Minimum passing Class B margin is -9.77 dB at 1534.30 MHz	Pass

Note: There is no deviation to the applied test methods and requirements covered by the scope of this report.

### 2.1 Measurement Uncertainty

Where relevant, the following measurement uncertainty levels have been estimated for tests performed on the EUT:

The listed uncertainties are the worst case uncertainty for the entire range of measurement. Please note that the uncertainty values are provided for informational purposes only and are not used in determining the PASS/FAIL results.

Measurement	Frequency	Expanded Uncertainty (k=2) ( $\pm$ )
Conducted Emissions at mains ports	150kHz ~ 30MHz	2.86 dB
Radiated Emissions up to 1 GHz	30MHz ~ 1GHz	3.99 dB
Radiated Emissions above 1 GHz	1GHz ~ 6GHz	3.65 dB
	6GHz ~ 18GHz	3.50 dB

### 2.2 Modification Record

There were no modifications required for compliance.

### 3 General Information

#### 3.1 Features of EUT

The tests reported herein were performed according to the method specified by Qualcomm Atheros, Inc., for detailed feature description, please refer to the manufacturer's specifications or user's manual.

#### 3.2 General Description of EUT

Product	Low-Energy WiFi Single-Band 802.11b/g/n
Brand	Qualcomm Atheros
Test Model	QCASP241
Sample Status	R&D SAMPLE
Operating Software	NA
Power Supply Rating	3.3Vdc from host equipment
Accessory Device	NA
Data Cable Supplied	NA

Note:

1. The modular has two variant designs as following table:

Variant No.	Difference	TX & RX Configuration
SKU #1	External antenna version	1TX/1RX (RX support diversity function)
SKU #2	On board PCB antenna version	1TX/1RX (TX/RX fix Main)

2. The EUT incorporates a 1T1R function.

MODULATION MODE	DATA RATE (MCS)	TX & RX CONFIGURATION	
<b>802.11b</b>	1 ~ 11Mbps	1TX	1RX
<b>802.11g</b>	6 ~ 54Mbps	1TX	1RX
<b>802.11n (HT20)</b>	MCS 0~7	1TX	1RX
<b>802.11n (HT40)</b>	MCS 0~7	1TX	1RX

### 3.3 Description of Antenna

The antenna gain was declared by client; please refer to the following table:

Set No.	Transmitter Circuit	Brand	Model	Ant. Type	2.4GHz Gain with cable loss (dBi)	2.4GHz Cable Loss (dB)	Connector Type	Cable Length (mm)
1	Chain (0)	WNC	81-EBJ15.005	PIFA	3.00	1.15	IPEX	300
	Chain (1)	WNC	81-EBJ15.005	PIFA	3.62	1.15	IPEX	300
Set No.	Transmitter Circuit	Brand		Model	Ant. Type	2.4GHz Gain with cable loss (dBi)		
2	Chain (0)	QCA		QCASP241-Ant	PCB	0.85		

Note: 1. Above antenna gains of antenna No. 1 is Total (H+V).

### 3.4 Operating Modes of EUT and Determination of Worst Case Operating Mode

Test mode is presented in the report as below.

Mode	Test Condition
	Description
1	Normal Mode

### 3.5 Test Program Used and Operation Descriptions

1. Turn on the power of all equipment.
2. Support unit A (NOTEBOOK COMPUTER) runs test program "Ping.exe" to link with support unit E (WiFi AP) via EUT by Wireless.

### 3.6 Primary Clock Frequencies of Internal Source

The EUT is a 2.4GHz WLAN device, provided by Qualcomm Atheros, Inc., for detailed internal source, please refer to the manufacturer's specifications.



### 3.7 Miscellaneous

#### Labelling Requirements for Part 15 Devices:

➤ Verification

The specific labelling requirements for a device subject to the Verification procedure are contained in Section 15.19(a). These labelling requirements are:

If the device is subject only to Verification, include a label bearing a unique identifier (Section 2.954) and one of three compliance statements specified in Section 15.19(a). If the labeling area for the device is so small, and/or it is not practical to place the compliance statement on the device, then the statement can be placed in the user manual or product packaging (Section 15.19(a)(5)). However, the device must still be labelled with the unique identifier (Verification). Generally, devices smaller than the palm of the hand are considered too small for the compliance statement.

➤ Certification

If the device is subject to Certification: (1) Section 2.925 contains information on identification of the equipment; (2) include a label bearing an FCC Identifier (FCC ID) (Section 2.926) and (3) include the appropriate compliance statement in Section 15.19(a). If the device is considered too small and therefore it is impractical (smaller than the palm of the hand) to display the compliance statement, then the statement may be placed in the user manual or product packaging. However, the device must still be labelled with the FCC ID. If the device is unquestionably too small for the FCC ID to be readable (smaller than 4-6 points), the FCC ID may be placed in the user manual. However, it must be determined that the device itself is too small – the label area allocated to the FCC ID may not be reduced because of over crowded identification of other product and regulatory information.

An electronic display of the FCC ID (see 9. Electronic Labelling below) may be used for Certification of Section 15.212 modular transmitters and software defined radios (Section 2.944).

➤ Declaration of Conformity (DoC):

The labelling requirements for a device subject to the DoC procedure are specified in Section 15.19(b). The label should include the FCC logo along with the Trade Name and Model Number, which satisfies the unique identifier requirement of Section 2.1074 if it represents the identical equipment tested for DoC compliance. For personal computers assembled from authorized components, the following additional text must also be included: “Assembled from tested components,” “Complete system not tested.” When the device is so small and/or when it is not practical to place the required additional text on the device, the text may be placed in the user manual or pamphlet supplied to the user. However, the FCC logo, Trade Name, and Model Number must still be displayed on the device (Section 15.19(b)(3)).



Part 15 Declaration of Conformity (DoC) Label Examples

Equipment certified as software defined radio may use a means that readily displays the FCC ID on an electronic display screen, instead of labelling the device (Section 2.925 (e)).

Further information may refer to FCC KDB:784748 D01 Labelling Part 15 &18 Guidelines

#### Labelling Requirements for ICES-003 Devices:

➤ Industry Canada ICES-003 Compliance Label:

*CAN ICES-3 (\*)/NMB-3(\*)*

\* Insert either “A” or “B” but not both to identify the applicable Class of ITE.

## 4 Configuration and Connections with EUT

### 4.1 Connection Diagram of EUT and Peripheral Devices

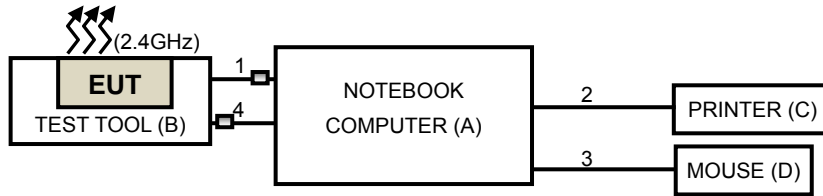

#### Remote site

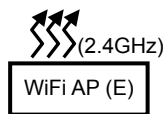

### 4.2 Configuration of Peripheral Devices and Cable Connections

No.	Product	Brand	Model No.	Serial No.	FCC ID	Remark
A	NOTEBOOK COMPUTER	DELL	E5420	CHHYLQ1	FCC DoC	Provided by Lab
B	TEST TOOL	Qualcomm Atheros	NA	NA	NA	Supplied by Client
C	PRINTER	EPSON	LQ-300+II	G88Y074083	FCC DoC	Provided by Lab
D	MOUSE	DELL	MOC5UO	I1401LVG	FCC DoC	Provided by Lab
E	WiFi AP	AboCom	WR5525	WR96002928	FCC DoC	Provided by Lab

#### NOTE:

- All power cords of the above support units are non-shielded (1.8 m).

For Radiated emission test						
No.	Cable	Qty.	Length (m)	Shielded (Yes/ No)	Cores (Number)	Remark
1	RS232 to USB Console	1	1.8	Yes	1	Provided by Lab
2	USB	1	1.8	Yes	0	Provided by Lab
3	USB	1	1.8	Yes	0	Provided by Lab
4	USB to Micro USB	1	2	Yes	1	Provided by Lab

- The core(s) is(are) originally attached to the cable(s).

## 5 Conducted Emissions at Mains Ports

### 5.1 Limits

Frequency (MHz)	Class A (dBuV)		Class B (dBuV)	
	Quasi-peak	Average	Quasi-peak	Average
0.15 - 0.5	79	66	66 - 56	56 - 46
0.50 - 5.0	73	60	56	46
5.0 - 30.0	73	60	60	50

Notes: 1. The lower limit shall apply at the transition frequencies.  
 2. The limit decreases linearly with the logarithm of the frequency in the range of 0.15 to 0.50 MHz.

### 5.2 Test Instruments

DESCRIPTION & MANUFACTURER	MODEL NO.	SERIAL NO.	CALIBRATED DATE	CALIBRATED UNTIL
Test Receiver R&S	ESCS 30	100375	May 06, 2015	May 05, 2016
Line-Impedance Stabilization Network (for EUT) SCHWARZBECK	NSLK-8127	8127-522	Sep. 15, 2014	Sep. 14, 2015
Line-Impedance Stabilization Network (for Peripheral) R&S	ENV216	100072	June 11, 2015	June 10, 2016
RF Cable	5D-FB	COCCAB-001	Mar. 09, 2015	Mar. 08, 2016
50 ohms Terminator	N/A	EMC-03	Sep. 22, 2014	Sep. 21, 2015
50 ohms Terminator	N/A	EMC-02	Sep. 30, 2014	Sep. 29, 2015
Software BVADT	BVADT_Cond_ V7.3.7.3	NA	NA	NA

**Note:**

1. The calibration interval of the above test instruments are 12 months and the calibrations are traceable to NML/ROC and NIST/USA.
2. The test was performed in Shielded Room No. C.
3. The VCCI Con C Registration No. is C-3611.
4. Tested Date: July 09, 2015

### 5.3 Test Arrangement

- The EUT was placed 0.4 meters from the conducting wall of the shielded room with EUT being connected to the power mains through a line impedance stabilization network (LISN). Other support units were connected to the power mains through another LISN. The two LISNs provide 50 Ohm/ 50uH of coupling impedance for the measuring instrument.
- Both lines of the power mains connected to the EUT were checked for maximum conducted interference.
- The test results of conducted emissions at mains ports are recorded of six worst margins for quasi-peak (mandatory) [and average (if necessary)] values against the limits at frequencies of interest unless the margin is 20 dB or greater.

Note: The resolution bandwidth and video bandwidth of test receiver is 9kHz for quasi-peak detection (QP) and average detection (AV) at frequency 0.15MHz-30MHz.

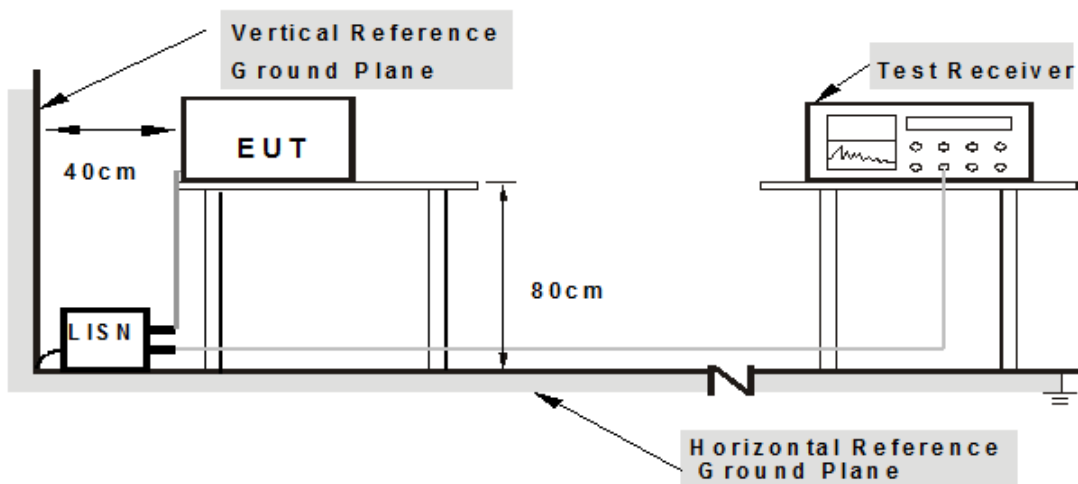

**Note: 1. Support units were connected to second LISN.**

For the actual test configuration, please refer to the related Item – Photographs of the Test Configuration.

### 5.4 Supplementary Information

There is not any deviation from the test standards for the test method.

### 5.5 Test Results

<b>Frequency Range</b>	150kHz ~ 30MHz	<b>Detector Function &amp; Resolution Bandwidth</b>	Quasi-Peak (QP) / Average (AV), 9kHz
<b>Input Power (System)</b>	120Vac, 60Hz	<b>Environmental Conditions</b>	25°C, 67%RH
<b>Tested by</b>	Jyunchun Lin		

Phase Of Power : Line (L)										
No	Frequency (MHz)	Correction Factor (dB)	Reading Value (dBuV)		Emission Level (dBuV)		Limit (dBuV)		Margin (dB)	
			Q.P.	AV.	Q.P.	AV.	Q.P.	AV.	Q.P.	AV.
1	0.15391	0.08	46.80	28.24	46.88	28.32	65.79	55.79	-18.91	-27.47
2	0.50997	0.11	30.88	18.02	30.99	18.13	56.00	46.00	-25.01	-27.87
3	0.65781	0.11	34.30	20.22	34.41	20.33	56.00	46.00	-21.59	-25.67
4	0.98203	0.13	31.14	19.94	31.27	20.07	56.00	46.00	-24.73	-25.93
5	1.97266	0.17	29.24	20.04	29.41	20.21	56.00	46.00	-26.59	-25.79
6	7.51172	0.35	28.10	19.82	28.45	20.17	60.00	50.00	-31.55	-29.83

**Remarks:**

1. Q.P. and AV. are abbreviations of quasi-peak and average individually.
2. The emission levels of other frequencies were very low against the limit.
3. Margin value = Emission level – Limit value
4. Correction factor = Insertion loss + Cable loss
5. Emission Level = Correction Factor + Reading Value

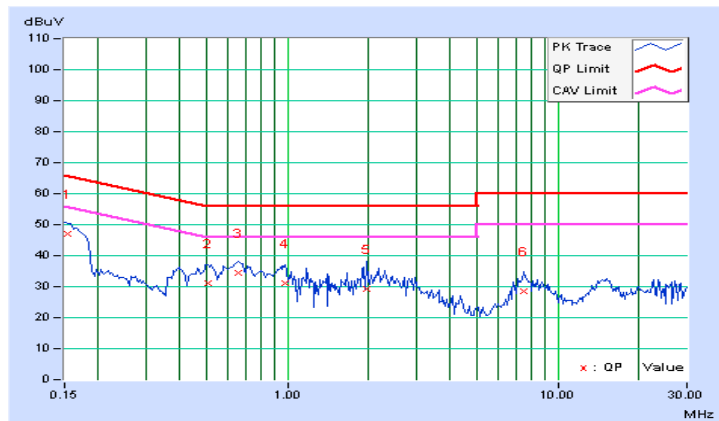

<b>Frequency Range</b>	150kHz ~ 30MHz	<b>Detector Function &amp; Resolution Bandwidth</b>	Quasi-Peak (QP) / Average (AV), 9kHz
<b>Input Power (System)</b>	120Vac, 60Hz	<b>Environmental Conditions</b>	25°C, 67%RH
<b>Tested by</b>	Jyunchun Lin		

Phase Of Power : Neutral (N)										
No	Frequency (MHz)	Correction Factor (dB)	Reading Value (dBuV)		Emission Level (dBuV)		Limit (dBuV)		Margin (dB)	
			Q.P.	AV.	Q.P.	AV.	Q.P.	AV.	Q.P.	AV.
1	0.15000	0.08	45.04	26.10	45.12	26.18	66.00	56.00	-20.88	-29.82
2	0.51719	0.11	30.76	17.26	30.87	17.37	56.00	46.00	-25.13	-28.63
3	0.67344	0.11	35.86	21.42	35.97	21.53	56.00	46.00	-20.03	-24.47
4	2.05469	0.17	30.86	20.16	31.03	20.33	56.00	46.00	-24.97	-25.67
5	7.68750	0.37	27.32	18.84	27.69	19.21	60.00	50.00	-32.31	-30.79
6	15.04688	0.60	26.42	19.88	27.02	20.48	60.00	50.00	-32.98	-29.52

**Remarks:**

1. Q.P. and AV. are abbreviations of quasi-peak and average individually.
2. The emission levels of other frequencies were very low against the limit.
3. Margin value = Emission level – Limit value
4. Correction factor = Insertion loss + Cable loss
5. Emission Level = Correction Factor + Reading Value

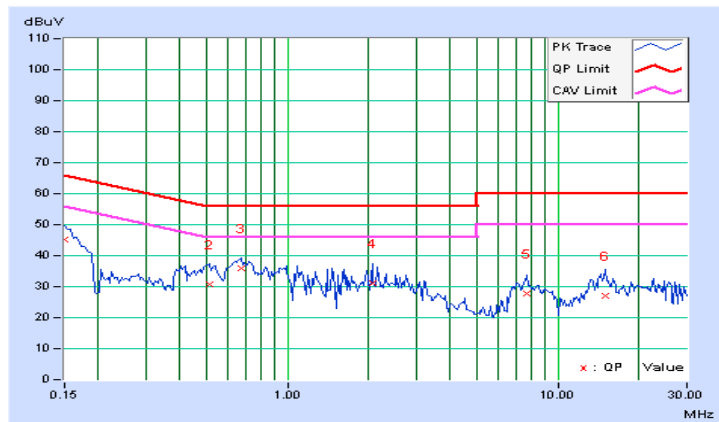

## 6 Radiated Emissions up to 1 GHz

### 6.1 Limits

Emissions radiated outside of the specified bands, shall be according to the general radiated limits as following:

Radiated Emissions Limits at 10 meters (dB $\mu$ V/m)				
Frequencies (MHz)	FCC 15B / ICES-003, Class A	FCC 15B / ICES-003, Class B	CISPR 22, Class A	CISPR 22, Class B
30-88	39	29.5	40	30
88-216	43.5	33.1		
216-230	46.4	35.6		
230-960				
960-1000	49.5	43.5	47	37

Radiated Emissions Limits at 3 meters (dB $\mu$ V/m)				
Frequencies (MHz)	FCC 15B / ICES-003, Class A	FCC 15B / ICES-003, Class B	CISPR 22, Class A	CISPR 22, Class B
30-88	49.5	40	50.5	40.5
88-216	54	43.5		
216-230	56.9	46		
230-960				
960-1000	60	54	57.5	47.5

- Notes:
1. The lower limit shall apply at the transition frequencies.
  2. Emission level (dB $\mu$ V/m) = 20 log Emission level (uV/m).
  3. QP detector shall be applied if not specified.

### 6.2 Test Instruments

DESCRIPTION & MANUFACTURER	MODEL NO.	SERIAL NO.	CALIBRATED DATE	CALIBRATED UNTIL
Test Receiver Agilent	N9038A	MY50010125	Apr. 18, 2015	Apr. 17, 2016
	N9038A	MY50010132	July 05, 2015	July 04, 2016
Pre-Amplifier Mini-Circuits	ZFL-1000VH2B	AMP-ZFL-01	Nov. 12, 2014	Nov. 11, 2015
	ZFL-1000VH2B	AMP-ZFL-02	Nov. 12, 2014	Nov. 11, 2015
Trilog Broadband Antenna SCHWARZBECK	VULB 9168	9168-359	Feb. 05, 2015	Feb. 04, 2016
	VULB 9168	9168-358	Feb. 04, 2015	Feb. 03, 2016
RF Cable	8D-FB	CHFCAB-001 CHFCAB-002 CHFCAB-003	Oct. 03, 2014	Oct. 02, 2015
Software BVADT	ADT_Radiated_V8.7.07	NA	NA	NA
Antenna Tower & Turn Table CT	NA	NA	NA	NA

**Note:**

1. The calibration interval of the above test instruments are 12 months and the calibrations are traceable to NML/ROC and NIST/USA.
2. The test was performed in 10m Chamber No. F.
3. The FCC Site Registration No. is 928149.
4. The VCCI Site Registration No. is R-3252
5. The CANADA Site Registration No. is IC 7450H-1.
6. Tested Date: July 15, 2015

### 6.3 Test Arrangement

- The EUT was placed on the top of a rotating table 0.8 meters above the ground at an accredited test facility. The table was rotated 360 degrees to determine the position of the highest radiation.
- The EUT was set 10 meters away from the interference-receiving antenna, which was mounted on the top of a variable-height antenna tower.
- The antenna is a broadband antenna, and its height is varied from one meter to four meters above the ground to determine the maximum value of the field strength. Both horizontal and vertical polarizations of the antenna are set to make the measurement.
- For each suspected emission, the EUT was arranged to its worst case and then the antenna was tuned to heights from 1 meter to 4 meters and the rotatable table was turned from 0 degrees to 360 degrees to find the maximum reading.
- The test-receiver system was set to quasi-peak detect function and specified bandwidth with maximum hold mode when the test frequency is below 1 GHz.

Note: The resolution bandwidth and video bandwidth of test receiver/spectrum analyzer is 120kHz for quasi-peak detection (QP) at frequency below 1GHz.

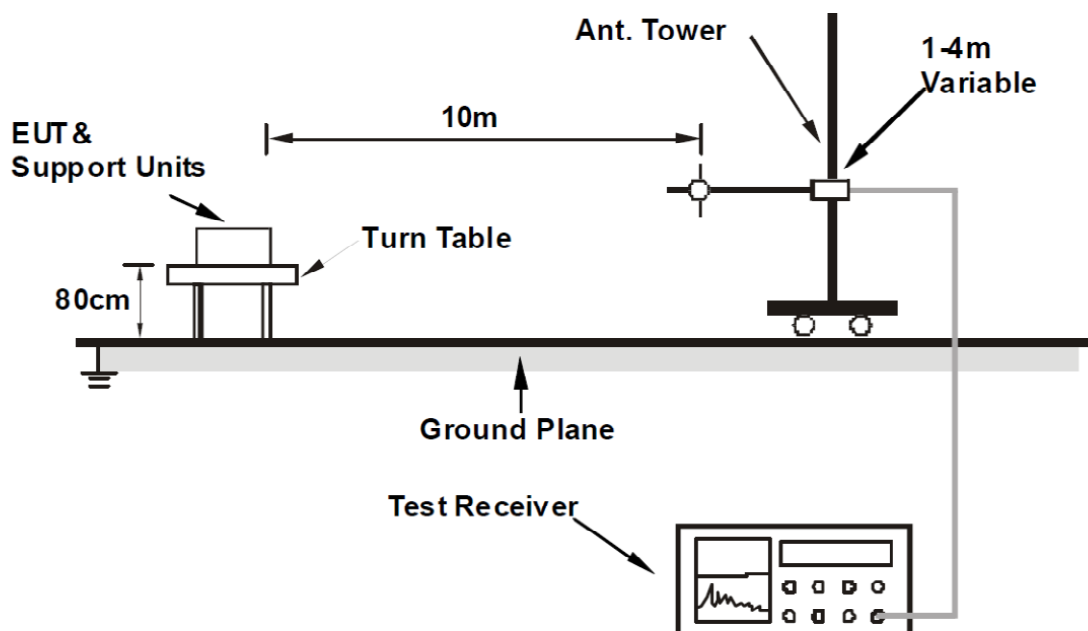

For the actual test configuration, please refer to the related Item – Photographs of the Test Configuration.

### 6.4 Supplementary Information

There is not any deviation from the test standards for the test method.



### 6.5 Test Results

Frequency Range	30MHz ~ 1GHz	Detector Function & Bandwidth	Quasi-Peak (QP), 120kHz
Input Power	3.3Vdc from host equipment	Environmental Conditions	25°C, 70%RH
Tested by	Scott Chen		

Antenna Polarity & Test Distance : Horizontal at 10 m								
No	Frequency (MHz)	Emission Level (dBuV/m)	Limit (dBuV/m)	Margin (dB)	Antenna Height (m)	Table Angle (Degree)	Raw Value (dBuV)	Correction Factor (dB/m)
1	89.85	26.62 QP	30.00	-3.38	4.00 H	20	44.94	-18.32
2	95.91	26.22 QP	30.00	-3.78	4.00 H	0	44.16	-17.94
3	143.88	26.40 QP	30.00	-3.60	4.00 H	234	38.79	-12.39
4	167.79	24.28 QP	30.00	-5.72	4.00 H	234	36.64	-12.36
5	311.66	33.45 QP	37.00	-3.55	3.00 H	301	44.25	-10.80
6	359.61	32.01 QP	37.00	-4.99	3.00 H	101	41.55	-9.54
7	431.53	33.46 QP	37.00	-3.54	2.00 H	14	40.66	-7.20

Remarks:

1. Emission Level(dBuV/m) = Raw Value(dBuV) + Correction Factor(dB/m)
2. Correction Factor(dB/m) = Antenna Factor (dB/m) + Cable Factor (dB) – Pre-Amplifier Factor (dB)
3. The other emission levels were very low against the limit.
4. Margin value = Emission level – Limit value

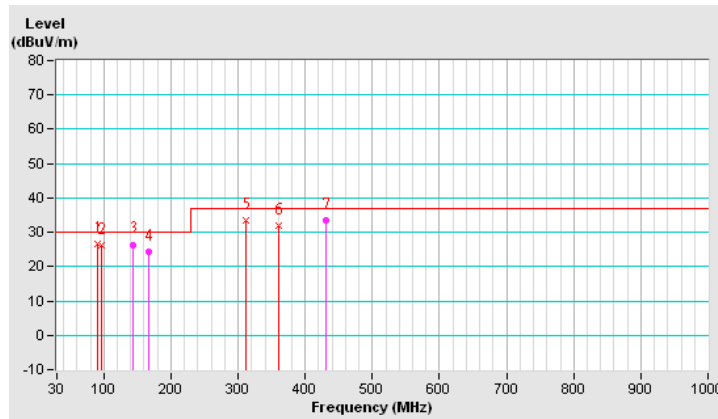

Frequency Range	30MHz ~ 1GHz	Detector Function & Bandwidth	Quasi-Peak (QP), 120kHz
Input Power	3.3Vdc from host equipment	Environmental Conditions	25°C, 70%RH
Tested by	Scott Chen		

Antenna Polarity & Test Distance : Vertical at 10 m								
No	Frequency (MHz)	Emission Level (dBuV/m)	Limit (dBuV/m)	Margin (dB)	Antenna Height (m)	Table Angle (Degree)	Raw Value (dBuV)	Correction Factor (dB/m)
1	35.82	26.44 QP	30.00	-3.56	1.00 V	113	40.23	-13.79
2	95.90	23.79 QP	30.00	-6.21	2.00 V	27	41.48	-17.69
<b>3</b>	<b>143.54</b>	<b>26.64 QP</b>	<b>30.00</b>	<b>-3.36</b>	<b>3.00 V</b>	<b>75</b>	<b>39.00</b>	<b>-12.36</b>
4	167.80	25.79 QP	30.00	-4.21	2.00 V	224	38.35	-12.56
5	202.51	24.31 QP	30.00	-5.69	2.00 V	227	39.82	-15.51
6	335.65	32.84 QP	37.00	-4.16	1.00 V	226	42.88	-10.04
7	431.53	32.73 QP	37.00	-4.27	1.00 V	229	39.81	-7.08

Remarks:

1. Emission Level(dBuV/m) = Raw Value(dBuV) + Correction Factor(dB/m)
2. Correction Factor(dB/m) = Antenna Factor (dB/m) + Cable Factor (dB) – Pre-Amplifier Factor (dB)
3. The other emission levels were very low against the limit.
4. Margin value = Emission level – Limit value

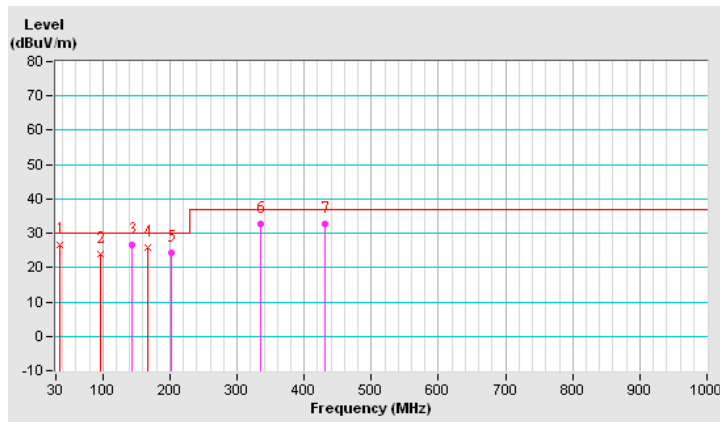

## 7 Radiated Emissions above 1 GHz

### 7.1 Limits

Emissions radiated outside of the specified bands, shall be according to the general radiated limits as following:

Radiated Emissions Limits at 10 meters (dB $\mu$ V/m)				
Frequencies (MHz)	FCC 15B / ICES-003, Class A	FCC 15B / ICES-003, Class B	CISPR 22, Class A	CISPR 22, Class B
1000-3000	Avg: 49.5	Avg: 43.5	Not defined	Not defined
Above 3000	Peak: 69.5	Peak: 63.5	Not defined	Not defined

Radiated Emissions Limits at 3 meters (dB $\mu$ V/m)				
Frequencies (MHz)	FCC 15B / ICES-003, Class A	FCC 15B / ICES-003, Class B	CISPR 22, Class A	CISPR 22, Class B
1000-3000	Avg: 60	Avg: 54	Avg: 56 Peak: 76	Avg: 50 Peak: 70
Above 3000	Peak: 80	Peak: 74	Avg: 60 Peak: 80	Avg: 54 Peak: 74

- Notes:
1. The lower limit shall apply at the transition frequencies.
  2. Emission level (dB $\mu$ V/m) = 20 log Emission level (uV/m).
  3. As shown in 15.35(b), for frequencies above 1000MHz, the field strength limits are based on average detector, however, the peak field strength of any emission shall not exceed the maximum permitted average limits, specified above by more than 20dB under any condition of modulation.

#### Frequency Range (For unintentional radiators)

Highest frequency generated or used in the device or on which the device operates or tunes (MHz)	Upper frequency of measurement range (MHz)
Below 1.705	30
1.705-108	1000
108-500	2000
500-1000	5000
Above 1000	5th harmonic of the highest frequency or 40GHz, whichever is lower

**7.2 Test Instruments**

DESCRIPTION & MANUFACTURER	MODEL NO.	SERIAL NO.	CALIBRATED DATE	CALIBRATED UNTIL
Test Receiver Agilent	N9038A	MY50010125	Apr. 18, 2015	Apr. 17, 2016
Pre-Amplifier Agilent	8449B	3008A01975	Feb. 28, 2015	Feb. 27, 2016
Horn Antenna SCHWARZBECK	BBHA 9120D	D123	Feb. 05, 2015	Feb. 04, 2016
RF Cable	SUCOFLEX104	RF-104-206 RF-104-209 RF-104-110	Dec. 11, 2014	Dec.10, 2015
Software BVADT	ADT_Radiated_ V8.7.07	NA	NA	NA
Antenna Tower & Turn Table CT	NA	NA	NA	NA

**Note:**

1. The calibration interval of the above test instruments are 12 months and the calibrations are traceable to NML/ROC and NIST/USA.
2. The test was performed in 10m Chamber No. F.
3. Tested Date: July 15, 2015

### 7.3 Test Arrangement

- The EUT was placed on the top of a rotating table 0.8 meters above the ground at an accredited chamber room. The table was rotated 360 degrees to determine the position of the highest radiation.
- The EUT was set 3 meters away from the interference-receiving antenna, which was mounted on the top of a variable-height antenna tower.
- The height of antenna can be varied from one meter to four meters, the height of adjustment depends on the EUT height and the antenna 3dB beamwidth both, to detect the maximum value of the field strength. Both horizontal and vertical polarizations of the antenna are set to make the measurement.
- For each suspected emission, the EUT was arranged to its worst case and then the antenna was tuned to heights and the rotatable table was turned from 0 degrees to 360 degrees to find the maximum reading.
- The spectrum analyzer system was set to peak and average detect function and specified bandwidth with maximum hold mode when the test frequency is above 1 GHz.

Note: The resolution bandwidth of test receiver/spectrum analyzer is 1MHz and video bandwidth is 3MHz for Peak detection (PK) at frequency above 1GHz. The resolution bandwidth of test receiver/spectrum analyzer is 1 MHz for Average detection (AV) at frequency above 1GHz.

#### <Frequency Range above 1GHz>

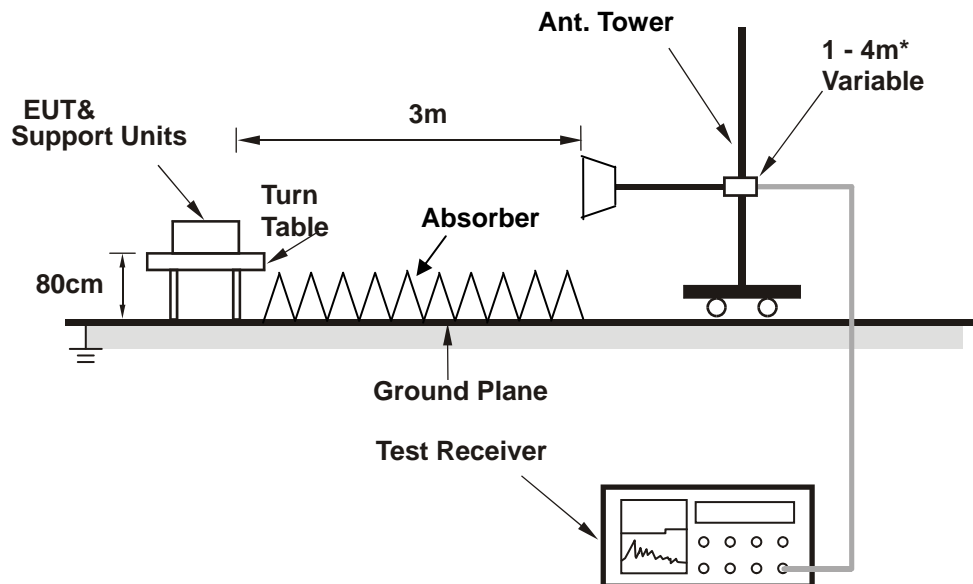

\* : depends on the EUT height and the antenna 3dB beamwidth both.

For the actual test configuration, please refer to the related Item – Photographs of the Test Configuration.

### 7.4 Supplementary Information

There is not any deviation from the test standards for the test method.

### 7.5 Test Results

Frequency Range	1GHz ~ 12.5GHz	Detector Function & Bandwidth	Peak (PK) / Average (AV), 1MHz
Input Power	3.3Vdc from host equipment	Environmental Conditions	25°C, 70%RH
Tested by	Scott Chen		

Antenna Polarity & Test Distance : Horizontal at 3 m								
No	Frequency (MHz)	Emission Level (dBuV/m)	Limit (dBuV/m)	Margin (dB)	Antenna Height (m)	Table Angle (Degree)	Raw Value (dBuV)	Correction Factor (dB/m)
1	1534.30	46.57 PK	74.00	-27.43	1.00 H	12	48.14	-1.57
2	<b>1534.30</b>	<b>44.23 AV</b>	<b>54.00</b>	<b>-9.77</b>	<b>1.00 H</b>	<b>12</b>	<b>45.80</b>	<b>-1.57</b>
3	1828.75	46.83 PK	74.00	-27.17	1.00 H	85	46.54	0.29
4	1828.75	25.77 AV	54.00	-28.23	1.00 H	85	25.48	0.29
5	1997.50	57.97 PK	74.00	-16.03	1.00 H	181	57.26	0.71
6	1997.50	26.57 AV	54.00	-27.43	1.00 H	181	25.86	0.71
7	2245.50	48.51 PK	74.00	-25.49	1.00 H	168	46.16	2.35
8	2245.50	27.65 AV	54.00	-26.35	1.00 H	168	25.30	2.35
9	2664.00	48.82 PK	74.00	-25.18	1.00 H	31	44.39	4.43
10	2664.00	30.01 AV	54.00	-23.99	1.00 H	31	25.58	4.43
11	5327.50	47.18 PK	74.00	-26.82	1.00 H	9	35.25	11.93
12	5327.50	33.27 AV	54.00	-20.73	1.00 H	9	21.34	11.93

Remarks:

1. Emission Level(dBuV/m) = Raw Value(dBuV) + Correction Factor(dB/m)
2. Correction Factor(dB/m) = Antenna Factor (dB/m) + Cable Factor (dB) – Pre-Amplifier Factor (dB)
3. The other emission levels were very low against the limit.
4. Margin value = Emission level – Limit value

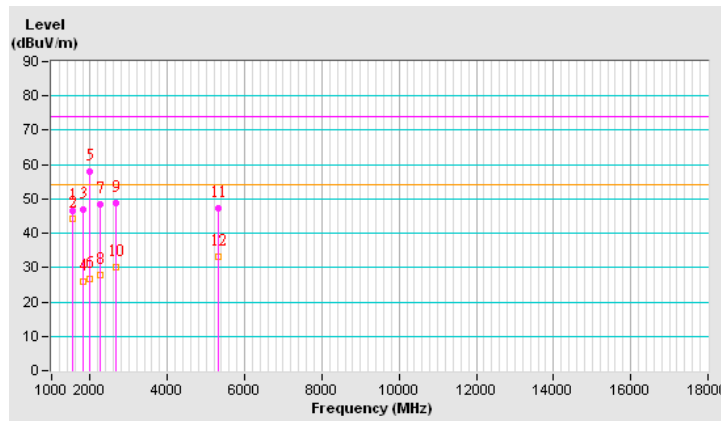

Frequency Range	1GHz ~ 12.5GHz	Detector Function & Bandwidth	Peak (PK) / Average (AV), 1MHz
Input Power	3.3Vdc from host equipment	Environmental Conditions	25°C, 70%RH
Tested by	Scott Chen		

Antenna Polarity & Test Distance : Vertical at 3 m								
No	Frequency (MHz)	Emission Level (dBuV/m)	Limit (dBuV/m)	Margin (dB)	Antenna Height (m)	Table Angle (Degree)	Raw Value (dBuV)	Correction Factor (dB/m)
1	1332.75	51.01 PK	74.00	-22.99	1.00 V	192	53.47	-2.46
2	1332.75	27.54 AV	54.00	-26.46	1.00 V	192	30.00	-2.46
3	1617.00	53.09 PK	74.00	-20.91	1.00 V	181	53.95	-0.86
4	1617.00	26.45 AV	54.00	-27.55	1.00 V	181	27.31	-0.86
5	1996.75	59.66 PK	74.00	-14.34	1.00 V	316	58.95	0.71
6	1996.75	26.85 AV	54.00	-27.15	1.00 V	316	26.14	0.71
7	2243.75	55.63 PK	74.00	-18.37	1.00 V	92	53.30	2.33
8	2243.75	28.35 AV	54.00	-25.65	1.00 V	92	26.02	2.33
9	2662.50	56.98 PK	74.00	-17.02	1.00 V	290	52.56	4.42
10	2662.50	29.96 AV	54.00	-24.04	1.00 V	290	25.54	4.42
11	5324.50	50.10 PK	74.00	-23.90	1.00 V	272	38.18	11.92
12	5324.50	33.24 AV	54.00	-20.76	1.00 V	272	21.32	11.92

Remarks:

1. Emission Level(dBuV/m) = Raw Value(dBuV) + Correction Factor(dB/m)
2. Correction Factor(dB/m) = Antenna Factor (dB/m) + Cable Factor (dB) – Pre-Amplifier Factor (dB)
3. The other emission levels were very low against the limit.
4. Margin value = Emission level – Limit value

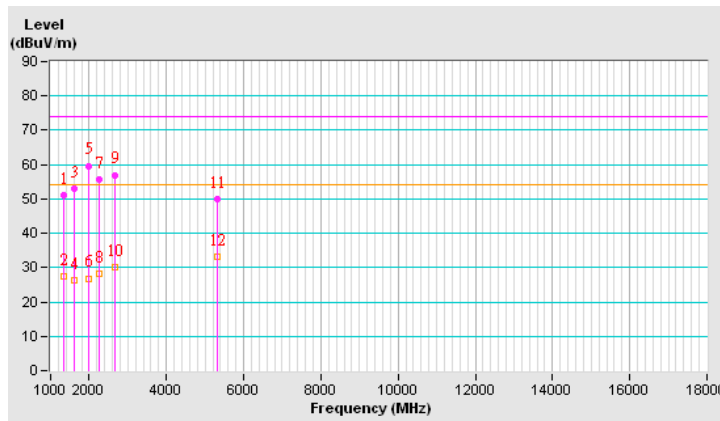

## Appendix – Information on the Testing Laboratories

We, Bureau Veritas Consumer Products Services (H.K.) Ltd., Taoyuan Branch, were founded in 1988 to provide our best service in EMC, Radio, Telecom and Safety consultation. Our laboratories are accredited and approved according to ISO/IEC 17025.

If you have any comments, please feel free to contact us at the following:

**Linko EMC/RF Lab**

Tel: 886-2-26052180

Fax: 886-2-26051924

**Hsin Chu EMC/RF/Telecom Lab**

Tel: 886-3-5935343

Fax: 886-3-5935342

**Hwa Ya EMC/RF/Safety Lab**

Tel: 886-3-3183232

Fax: 886-3-3270892

**Email:** [service.adt@tw.bureauveritas.com](mailto:service.adt@tw.bureauveritas.com)

**Web Site:** [www.bureauveritas-adt.com](http://www.bureauveritas-adt.com)

The address and road map of all our labs can be found in our web site also.

--- END ---